

We are IntechOpen, the world's leading publisher of Open Access books Built by scientists, for scientists

4,800

Open access books available

122,000

International authors and editors

135M

Downloads

Our authors are among the

154

Countries delivered to

TOP 1%

most cited scientists

12.2%

Contributors from top 500 universities



WEB OF SCIENCE™

Selection of our books indexed in the Book Citation Index
in Web of Science™ Core Collection (BKCI)

Interested in publishing with us?
Contact book.department@intechopen.com

Numbers displayed above are based on latest data collected.

For more information visit www.intechopen.com



Effects of Surface Tension on Mass Transfer Devices

Honda (Hung-Ta) Wu¹ and Tsair-Wang Chung²

¹Center of General Education, Chungyu Institute of Technology

²Department of Chemical Engineering/R&D Center for Membrane Technology,
Chung-Yuan Christian University
Taiwan, ROC

1. Introduction

Fluid flow resulted from the gradient of surface tension usually called as Marangoni effect or surface tension effect, and the induced convection was called as Marangoni convection. Earlier studies about Marangoni effect were to discuss and analyze the disturbed phenomena in the gas-liquid interface. The phenomenon of the so called “tears and wine” was first studied by Carlo Marangoni in 1865. The Benard cells resulted from the gradient of temperature were another instance of Marangoni convections. Nowadays, the surface tension effect was extensively applied in many fields. For example, the nanostructure changed as a result of Marangoni effect in enhanced laser nanopatterning of silicon. Besides, to avoid spotting in silicon wafers, the matter of low surface tension was blown over the wet wafer to lead the gradient of surface tension and to dry wafer surface by the induced Marangoni effect. Marangoni effect was also utilized in dyeing works. The dyes or pigments were floated on the surface of the basic medium, and then they moved toward the diffusion direction by Marangoni effect. Finally, the surface was covered by paper or cloth to take a print.

On the basis of small disturbance analysis, the interfacial disturbances can be divided into stable, stability and instability state. The stable state means that the fluid flowed phenomenon is not affected by Marangoni effect. The studies about stability state were always focused on critical Marangoni number or neutral stability curve. The instability state could be subdivided into stationary and oscillatory instabilities, and they were known as Marangoni instability. The regular hexagonal pattern of convective cells, such as Benard cells, was formed by heating from below or cooling from above, and which was the typical stationary instability, that is, the Marangoni convections with regular convection were called as stationary instability; however, the Marangoni convection with irregular convection was called as oscillatory instability. In general, the mass transfer performance can be enhanced by the Marangoni instability or so called interfacial disturbance. Therefore, studies about mass transfer affected by interfacial disturbance were focused on performance enhancement. Both of stationary instability or oscillatory instability can be called as interfacial disturbance in these studies.

Mentioned above, Marangoni instability or interfacial disturbance can be resulted from the gradient of surface tension. Since fluids are the indispensable element for mass transfer devices, fluid flow affected by surface tension and effect of Marangoni instability on mass

transfer were discussed in recent years. Generally speaking, the reason for the induced Marangoni convection could be divided into artificial and spontaneous Marangoni convection. For example, the disturbance induced by surface additive injected into absorption system could be called as artificial Marangoni instability; however the spontaneous Marangoni instability could be produced by some composed components in the distillation, extraction, bubble columns and so on. The Marangoni effect could be occurred in the gas-liquid and liquid-liquid contacting systems or mass transfer devices, such as packed distillation column, falling film absorber, absorption process with chemical reaction, two-phase flow system, liquid jets system and so on.

In addition to the gradient of surface tension, the liquid fluid with continuous phase is an important reason to trigger the Marangoni effect so much that the liquid fluid with continuous phase can be observed in the mass transfer devices mentioned above. Therefore, the purpose of this chapter is to discuss effects of Marangoni instability on mass transfer devices. Besides, some experimental results are present to describe effects of Marangoni effect on absorption performance. The interfacial disturbance and surface stress were also observed and calculated to analyze mass transfer performance for water vapor absorbed by triethylene glycol (TEG) solution in packed bed absorber. Described above, the phenomena of Marangoni effect in the thin liquid film, thicker liquid layer, and mass transfer devices were elucidated in the first. Secondly, the definitions related to artificial and spontaneous Marangoni convections were described. And then effects of interfacial disturbance resulted from the gradient of surface tension on the performance of mass transfer devices were discussed. Finally, the summary of this chapter was described in the conclusion.

2. Marangoni effect in thin liquid film, thicker liquid layer, and mass transfer devices

2.1 Thin liquid film

Fluid flow driven by the gradient of surface tension had been called as Marangoni effect, and the surface of liquid thin film was always inhomogeneous or wavy in the microview. As shown in Fig. 1, the horizontal coordinate toward the thinner region is assumed to be positive x , that is the direction of $+x$, and the section of between real line and dotted line can be regarded as a cellular convection in the interface. Since the concentration in the thinner region is higher than that in the thicker region, the concentration gradient, eq. 2, is greater than zero for the gradient of surface tension, eq. 1.

$$\frac{d\gamma}{dX} = \frac{\partial\gamma}{\partial C_{AL}} \frac{\partial C_{AL}}{\partial X} \quad (1)$$

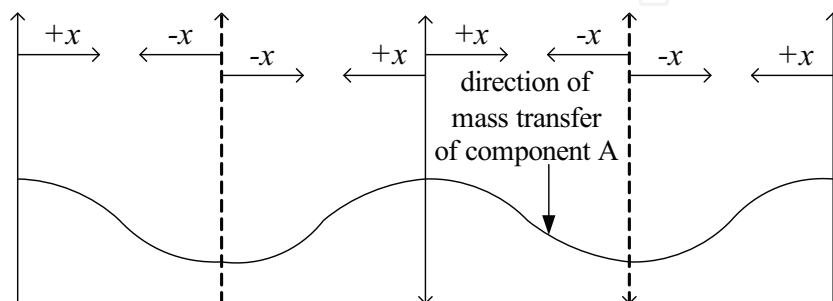

Fig. 1. Fluid flow induced by the gradient of surface tension in the thin liquid film

$$\frac{\partial C_{AL}}{\partial X} > 0 \quad (2)$$

where the symbol γ is surface tension, and C_{AL} is the concentration of solute in liquid phase. Mentioned above, the direction of fluid flow is dominated by the gradient of surface tension with respect to the concentration of liquid solution, that is $\partial\gamma/\partial C_{AL}$.

a. $\frac{\partial\gamma}{\partial C_{AL}} < 0$

If the gradient of surface tension with respect to concentration is less than zero (negative), the gradient of surface tension (eq. 1) will be negative. The liquid will flow from thinner region to thicker region. Compared with liquid flowing on the supported surface, such as packing surface, the gas-liquid contacting area is reduced by the contraction of liquid film on packing surface, which leads to the less mass transport. Therefore, the phenomenon was called as "Marangoni negative system".

b. $\frac{\partial\gamma}{\partial C_{AL}} > 0$

If the gradient of surface tension with respect to concentration is greater than zero (positive), the gradient of surface tension will be positive. The liquid will flow from thicker region to thinner region. Since the fluid flow under this condition makes liquid film flowing homogeneously on the supported surface, the gas-liquid contacting area is larger than the "Marangoni negative system". The mass transfer performance is always better for this system, and the phenomenon is called as "Marangoni positive system".

Extended from the concept of Marangoni effect acting on thin liquid film, effect of surface tension on mass transfer performance of packed distillation column was investigated by Patberg et al., 1983. Since the surface tension of feeding solution was almost not changed while contacting with the reflux, Fig. 2 (a) showed the liquid was subject to the path of the shortest distance and the lowest resistance. Flow phenomenon in Fig. 2 (a) was resulted from Marangoni negative or neutral system in packed distillation column. Therefore, the poor distilling performance was due to the bad efficiency of packing wetted. On the opposite, the solution on the button of packing could be drawn by the feeding solution on the top of packing due to the surface tension of feeding solution increased by the reflux. Therefore, Fig. 2 (b) showed the solution flowing more homogeneously over the packing material. Since the wetting efficiency of packing material is good for mass transfer under the condition of Fig. 2 (b), the mass transfer performance of packed distillation column is better than Fig. 2 (a). This can be called as Marangoni positive system in the packed distillation column. In addition, Patberg et al., 1983 also found that the interface refreshment was affected by the smaller packing and the lower liquid flow rates more significantly. Patberg et al., 1983 assumed that the shear stress was equal to the largest possible surface tension difference divided by an assumed creeping height, which resulted in the constant shear stress and constant thickness of creeping film. To achieve a more detailed approximation, the creeping film phenomenon (Fig. 3) for packed distillation column was proposed by Dijkstra & Drinkenburg, 1990 to discuss effects of surface tension on wetted area and mass transfer. The numerical results showed that Marangoni effect was more significant in lower Biot number (Buoyancy effect), and the creeping height was increased with the increased Marangoni number. Finally, the Marangoni effect resulted from evaporation of acetone affected mass transfer flux for the acetone-water system was also demonstrated by Dijkstra & Drinkenburg, 1990.

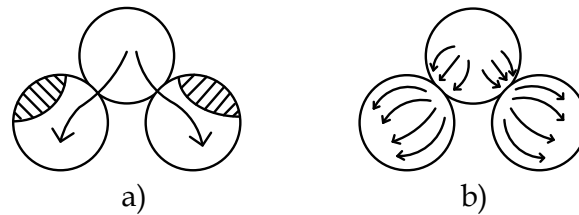

Fig. 2. Schematic diagram of liquid flow over packing under the conditions of (a) negative or neutral system (b) positive system. (referred from Patberg et al., 1983)

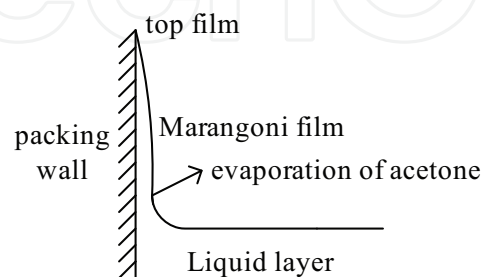
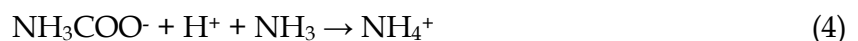

Fig. 3. Schematic diagram of the phenomenon of creeping film. (referred from Dijkstra & Drinkenburg, 1990)

2.2 Liquid layer

Marangoni convection or Marangoni instability was usually resulted from the gradient of surface tension in the thicker liquid layer. In addition to the interfacial disturbance resulted from heating the bottom of liquid layer, the interfacial disturbance also can be induced by the gradient of concentration, such as chemisorptions of carbon dioxide by monoethanolamine (MEA) solution. Brian et al., 1967 proposed the chemisorptions mechanism for carbon dioxide absorbed by MEA solution as follows:



The absorption efficiency of carbon dioxide could be enhanced by the induced interfacial disturbance in the system. In order to analyze effects of surface tension on cellular convection, the chemisorptions for the components of H_2S -MEA- H_2O and CO_2 -MEA- H_2O were investigated by Buzek, 1983. Absorption of H_2S by MEA solution was an instantaneous and irreversible reaction, and the mass transfer resistance in the gas phase was negligible. Since the liquid surface and its vicinity were occupied by the only ionized products, there was no concentration gradient responsible for cellular convection. Although the mass transfer resistance in the gas phase was still negligible for absorption of CO_2 by MEA solution, the rate of chemical reaction between MEA solution and CO_2 was finite. The gradient of interfacial tension could be resulted from nonuniform interfacial distribution of reactant and product. Therefore, the cellular convection could be resulted from absorption of CO_2 by MEA solution due to the gradient of interfacial tension. For the chemisorptions, Kaminsky et al., 1998 proposed the model of energy-balance equation, and the results showed that the mass transfer rate between phases was increased by the induced interfacial disturbance. Besides, to discuss the influences of surfactant solutions spreading on

hydrophilic surfaces affected by Marangoni effect, Cachile et al., 1999 used nonionic surfactants, such as $C_{12}E_4$ and $C_{12}E_{10}$, in ethylene glycol (EG) and diethylene glycol (DEG) to deposit on the surface of oxidized silicon wafer. Cachile et al., 1999 found that the spreading of surfactant solutions on hydrophilic surfaces and the structure of the instability pattern were dominated by the mobility of pure surfactant and the relative humidity, especially for that higher than 80%. In recent years, Marangoni convections were also discussed in the systems of solute evaporating from a liquid phase to an inert phase, surfactant transport from an aqueous to an organic phase, and absorption and desorption of carbon dioxide into and from organic solvents by Colinet et al., 2003, Lavabre et al., 2005, and Sun, 2006 respectively.

In general, the interfacial disturbance resulted from spontaneous mass transfer is insignificant, and it is difficult to observe by naked eyes. Therefore, some studies compared mass transfer data with and without Marangoni effect to show influence of surface tension on mass transfer performance. On the other hand, some studies used the disturbed phenomena in the macro view or established the disturbed model to deduce interfacial disturbance resulted from the gradient of surface tension. Mentioned above, scaling up the interfacial phenomena from micro view and proving by experimental data under the conditions without violating scientific theory is one way to realize interfacial phenomena affected by the Marangoni effect.

In order to observe and realize the interfacial phenomena resulted from the gradient of surface tension for the absorption system, the water drop was instilled on the surface of TEG solution to observe the interfacial disturbance and calculate the surface stress. The schematic diagram for observing water drop instilled on the surface of TEG solution is shown in Fig. 4. Since the disturbed phenomena for water drop instilled on different concentrations of TEG solutions are similar, only water drop instilled on 95 wt. % TEG solution is shown to describe the interfacial disturbance, such as Fig. 5 (a), (b) and (c). As shown in Fig. 5, the microscope with the software of image processing was used to observe the interfacial phenomena. The water drop can be called as the spreading liquid and the TEG solution can be called as the supporting liquid during the process of instilling water drop on the surface of the TEG solution. Since the surface tension of water drop was greater than that of TEG solution, the contraction of water drop inward was occurred by the induced interfacial stress, as shown in Fig. 5 (a) and (b). The results showed that the rate of instantaneous contraction for the interfacial contour was faster than dissolution of water drop into TEG solution. And then the drop diverged gradually due to mutual dissolution between water and TEG, as shown in Fig. 5 (c). In addition, the longitudinal gradient of surface tension made the disturbed behavior around the peripheral region of water drop, which could be called as the interfacial instability and the instability lasted from 30s to 40s.

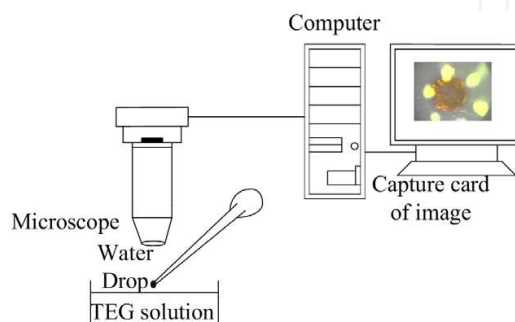

Fig. 4. The observed system of water drop instilled on the surface of TEG solutions

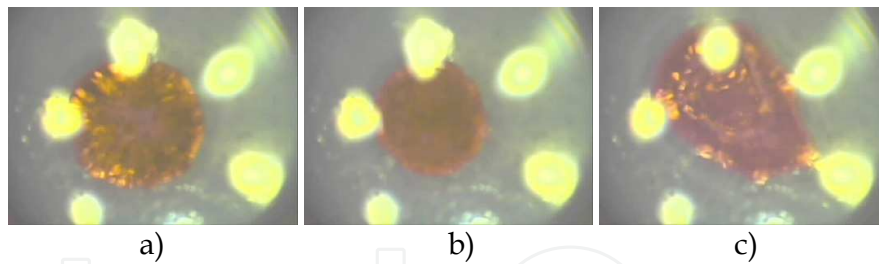

Fig. 5. Images of water drop instilled on surface of 95 wt. % TEG solution (a) the start of water drop on the TEG solution, (b) the contraction of water drop, (c) divergence of water drop on TEG surface

The interfacial stress was calculated and the relationship between interfacial stress and concentration of TEG solution was drawn after the images of water drop instilled on the surface of TEG solutions were captured. The schematic diagram of water drop on the TEG surface is shown in Fig. 6, and the assumptions of homogeneous water film and plug flow is made for the contraction of water drop in this system. Mentioned above, the interfacial stress can be deduced as follows:

$$dF = dma \quad (5)$$

$$dF = d\rho V_{drop}a \quad (6)$$

where the symbol F is the interfacial stress, m is the mass of liquid drop, V is the volume of liquid drop, ρ is the density of liquid drop, and a is the acceleration of leading edge of liquid drop. Assuming the acceleration maintained a constant at that instant.

$$dF = a \cdot d(\rho V_{drop}) \quad (7)$$

$$\because V_{drop} = 2\pi r \times \omega \quad (8)$$

ω = the thickness of liquid film

Eq. 7 is replaced by eq. 8, and the interfacial stress can be obtained from eq. 9.

$$F = a\rho\omega 2\pi \times \int_{r_1}^{r_2} r dr \quad (9)$$

On the basis of eq. 9, the interfacial stress resulted from the gradient of surface tension can be calculated, and the relationship between interfacial stress and concentration of TEG solution is shown in Fig. 7. As known, the surface tension of TEG solution is decreased with the increased concentration of TEG solution. The surface tension difference between water and TEG solution should be greater for the higher TEG concentration, which leads to the stronger interfacial stress. Fig. 7 also shows that the interfacial stress increases dramatically for the concentration higher than 93 wt. % TEG solution. Therefore, the absorption performance of water vapor absorbed by TEG solution could be increased more significant as TEG concentration greater than 93 wt. %, and the deduction is consistent with experimental results by Wu and Chung, 2006. Although the interfacial stress is insignificant for lower concentration, the interfacial instability resulted from longitudinal gradient of surface tension around the peripheral region of water drop is still being. The interfacial stress and Marangoni instability resulted from the enough difference of surface tension

between spreading and supporting liquids was demonstrated, and the disturbed phenomena described above could also be helpful for explaining why the performance of mass transfer devices affected by the Marangoni effect.

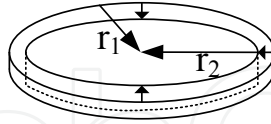

Fig. 6. The schematic diagram of water drop contracted inward on the surface of TEG solution

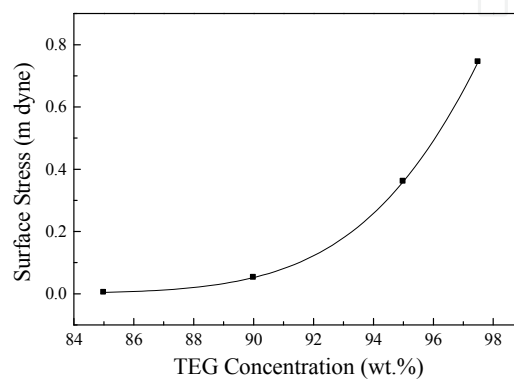

Fig. 7. Effects on TEG concentration on interfacial stress

2.3 Mass transfer devices

In addition to Benard cell resulted from the gradient of surface tension in the liquid layer, studies related to Marangoni effect were almost devoted to packed distillation column and liquid-liquid contacting system before 1990. For example, Bakker et al., 1967 defined the ratio F of the measured concentration to the calculated concentration to analyze effect of driving force on the ratio F for the liquid-liquid extraction system. The ratio F was increased with the increased driving force. Bakker et al., 1967 deduced that the discrepancy between measured and calculated concentration could be attributed to the interfacial movement. The components and the changed range of ratio F for the system are shown in Table 1. Besides, Moens & Bos, 1972 used pool column to investigate effect of surface tension on surface renewal. The relationship between stabilizing index, $M = -(d\gamma/dx)(x-x^*)$, and number of transfer units N_{og} was used to analyze mass transfer performance affected by the gradient of surface tension. Roll cells were observed only for stabilizing index M greater than 5 dn/cm, and N_{og} was not decreased beyond 0.15 dn/cm. Moens & Bos, 1972 concluded that the surface was renewed by the longitudinal gradient of surface tension. The entering liquid spread over the interface and moved towards outlet rapidly under the condition of positive M , which led interfacial velocity and mass transfer coefficient to be increased. However, the entering liquid did not spread over the interface under the condition of negative M . As a result of limiting spread of liquid, the insignificant surface renewal and the limited Marangoni effect could be derived for this condition. For absorption system, the surface additive could be added to absorption system to induce interfacial disturbance. For example, n-octanol was added to the aqueous solution of lithium bromide to induce interfacial disturbance by Kashiwagi et al., 1993 in the falling-film system. Both of adding n-

octanol vapor and adding saturated n-octanol to the aqueous solution of lithium bromide were performed by Kashiwagi et al., 1993. The results showed that absorption of steam was enhanced by the induced Marangoni effect. On the other hand, sodium lauryl sulfate (SLS) and cetyltrimethyl ammonium bromide (CTMAB) were used as surfactant respectively by Vazquez et al., 1996 to test the performance of carbon dioxide absorbed by water. Experimental results showed that the performance of carbon dioxide absorbed by water could be enhanced by the convection-inducing liquid, 20-100 wt. % aqueous solution of methanol, ethanol, 2-propanol, and the mass transfer coefficient would be reduced with the increased surfactant concentration.

Similar to Patberg et al., 1983, Proctor et al., 1998 also discussed effects of surface tension on packed distillation column. The difference between them is that the experimental parameters, include different scale of packed distillation column and liquid flow rate were performed by Proctor et al., 1998. Effects of surface tension on mass transfer performance for the small-scale packed distillation column were consistent with previous studies. However, the extra surface was produced by spray and small drops for the larger scale column in the negative system, and then the mass transfer performance was better for the negative system at heavier loading. For absorption of carbon dioxide, liquid water, monoethanolamine (MEA), and metheldiethanolamine (MDEA) aqueous solution were often used as absorbent solutions to absorb carbon dioxide in the open studies. For example, aqueous solution of MDEA was used to absorb carbon dioxide by Zhang et al., 2003 to discuss the discrepancy of absorption rate between experimental data and kinetics model, and hence they thought that the enhanced absorption rate could be attributed to Marangoni effect resulted from the elevated partial pressure of carbon dioxide. In addition, some studies related to Marangoni effect in the recent years can also be found from absorption of CO₂ and NH₃ absorbed by NaOH and water in the falling film and bubble absorption systems, as shown in Table 1.

Mentioned above, the gradient of surface tension could be formed by mass transfer in the interface, and then the Marangoni instability could be induced by the gradient in the mass transfer device with continuous liquid phase. Therefore, the packed-bed absorber with continuous liquid phase was tested by Wu et al., 2001 to discuss effects of Marangoni convection on mass transfer performance of water vapor absorbed by TEG solution. Since the surface tension of absorbent solution was depend on concentration and temperature, the stabilizing index (*M*-index) was established with respect to the differentiation of concentration. On the basis of dimensional analysis and *M*-index, the empirical mass transfer correlation with *M*-index was established in eq. 10.

$$\frac{k_{xa} \cdot M \cdot d_p^2}{\mu_L} = 1 \times 10^{-7} \cdot \left(\frac{\rho_L \cdot L \cdot d_p}{\mu_L} \right)^{0.5} \left(\frac{\mu_L}{D_L \cdot \rho_L} \right)^{1/3} \left(\frac{L}{G} \right)^{1.55} (M - index)^{0.25} \quad (10)$$

where k_{xa} is the mass transfer coefficient in the liquid phase, M is the molecular weight of the transferred matter, d_p is the diameter of the transferred matter, μ_L is the viscosity of liquid fluid, the term in the first parentheses is the Reynolds number, the term in the second parentheses is the Schmidt number, L is the liquid flow rate, G is the gas flow rate, and *M-index* is the Marangoni-index. The difference between experimental mass transfer coefficients and predicted by eq. 10 is about 7%, which is better than that predicted by the empirical mass transfer correlation without *M*-index. The results mean that mass transfer phenomena and performance should be affected by Marangoni effect under the process of water vapor absorbed by TEG solution.

Method of Mass Transfer	Authors	Response Value	Changed Range	Components
Extraction	Bakker et al., 1967	F	1~3	acetic acid from water to isobutyl alcohol
Distillation (Packed Column)	Proctor et al., 1998	H_{og} (mm) (height of transfer units)	20-100	n-propanol/water
Distillation (Pool Column)	Moens & Bos, 1972	N_{og} (number of transfer units)	2.55-3.65	n-heptane/methyl-cyclohexane overall gas
Absorption (Falling Film)	Kashiwagi et al., 1993	Na (kg/m ² s)	0.9-1.9	steam absorption by 58.3 %wt. LiBr solution
Absorption (Falling Film)	Zanfir et al., 2005	conversion, %	40-100	CO ₂ absorbed by NaOH
Absorption (Pool absorber)	Vazquez et al., 1996	k_1 (m/s)	$6.6-7.8 \times 10^{-5}$	CO ₂ absorbed by water
Absorption (Packed Absorber)	Zhang et al., 2003	N (kmol/m ² s)	1.229- 26.699×10^{-6}	CO ₂ absorbed by MDEA
Absorption (Bubble)	Kim et al., 2006	m (g/s) absorption rate	0.3-2.8	NH ₃ absorbed by water

Table 1. Response value and the changed range for different mass transfer devices

3. Artificial and spontaneous marangoni convections

Researches about Marangoni effect can be categorized into experimental operation and numerical simulation. For the experimental operation, some studies compared experimental data to demonstrate that mass transfer performance affected by Marangoni effect, and the others observed or analyzed surface velocity and interfacial properties resulted from the gradient of surface tension to show effect of interfacial disturbance on mass transfer. Researches about Marangoni effect discussed by numerical simulation can also be categorized as follows. One is to simulate Marangoni effect resulted from the gradient of surface tension in the mass transfer system, and show that the performance is affected by Marangoni effect; the other is discuss the roll cells resulted from Marangoni instability and to analyze the induced interfacial disturbance by dimensionless numbers based on mass transfer principle and linear stability analysis. According to the collected references, the studies about interfacial disturbance discussed by numerical simulation are beyond 70 percent. Half of the other studies are to investigate effect of Marangoni effect on mass and heat transfer performance by practical experimental data; and the rest is to analyze and discuss Marangoni convection by the observed technology. The difference of study number shows that it is not easy to design a pilot engineering device accompanied with surface tension effect. The designer not only need to have the ability to design mass or heat transport device, but also need to have the ability to make the Marangoni effect occurring in the mass transfer device. Furthermore, studies about transfer performance affected by Marangoni effect in mass transfer devices and image observation during the process of mass transfer were not increased in recent years, which causes it is difficult to find the relevant paper for Marangoni effect occurring in the mass transfer devices. However, heat and mass transport engineering and drying of chip and semiconductor affected by Marangoni effect have been demonstrated in the open literatures. This is why the subject of effects of surface

tension on mass transfer devices was selected to discuss in this chapter; however, it still need more hands to fill the gap in the literature. The purpose of this chapter is to discuss effect of Marangoni effect on mass transfer devices, and hence most of the descriptions are focused on the mass transfer enhancement affected by Marangoni effect. Some results obtained from numerical simulation are used to assist the descriptions about interfacial behaviors.

Mass Transfer Device	Method	Times of Mass Transfer Enhancement	Authors(year)
liquid-liquid system	100 ml water + 0.002-0.05 g ionic and non-ionic surfactants	1-7 times (compared with the absence of surfactant)	Agble & Mendes, 2000
falling film absorber	saturated n-octanol vapor was supplied to the absorber	increase 20% (mass flux, kg/m ² s)	Kashiwagi et al., 1993
plane absorption system (two concentric absorption cell)	methanol, ethanol, 1-propanol, 2-propanol or acetone (20-100% wt aqueous solution) was deposited at the surface of water liquid	3-4 times (compared with the absence of surfactant)	Vazquez et al., 1996
plane absorption system (two concentric absorption cell)	methanol, ethanol or n-propanol, (0-100 % wt.) was deposited at the surface of water liquid	3-4 times (compared with the absence of surfactant)	Lu et al., 1996
plane absorption system (two concentric absorption cell)	2-ethyl-1-hexanol was deposited at the surface of water liquid	1-4 times (compared with the absence of surfactant)	Kim et al., 1996
plane absorption system (two concentric absorption cell)	ethanol was added to the surface of liquid water	2-5 times (compared with the absence of surfactant)	Lu et al., 1997
plane absorption system (two concentric absorption cell)	ethanol was added to the surface of TEG solution and ethanol vapor was added to absorption system	increase 15-60% (removal efficiency, %)	Yang et al., 2008
plane absorption system	ethanol was added to the surface of absorbent solution (triethylene glycol)	increase 5-17% (mass transfer coefficient, mol/m ² min)	Wu et al., 2008

Table 2. Mass transfer devices and the method to result in interfacial disturbance for the artificial Marangoni convection

Mass Transfer Device	Properties	Purpose	Authors
Wetted wall column	solulal Marangoni effect experimental data	to discuss the intensity of interfacial disturbance for solutes transferring	Maroudas & Awistowski, 1964
Wetted wall column	solulal Marangoni effect experimental data	to show that absorption of carbon dioxide into monoethanolamine affected by interfacial turbulence	Brian et al., 1967
Liquid-liquid extraction	solulal Marangoni effect experimental data	to analyze the relationship between mass transfer data and driving force across liquid-liquid interfaces	Bakker et al., 1967
horizontal liquid layer	solulal Marangoni effect numerical simulation	to develop the transient models of transfer processes based on the transient age distributions	Chung et al., 1971
Packed distillation column	solulal Marangoni effect experimental data	to estimate influence of driving force on the efficiency of distillation column	Moens, 1972
Liquid-jet and wetted wall column	solulal Marangoni effect experimental data	to discuss mass transfer enhancement affected by interfacial disturbance for desorbing surface-active solute	Imaishi et al., 1982
Packed distillation column	solulal Marangoni effect experimental data	to discuss effect of positive and negative driving force on different packings	Patberg et al. (1983)
Pilot wetted wall	solulal Marangoni effect numerical simulation	to discuss mass transfer enhancement by the model of creeping film	Dijkstra et al., 1990
Liquid layer with finite deep	solulal Marangoni effect numerical simulation	to study Marangoni instability for chemisorptions	Warmuzinski & Tanczyk, 1991
Packed rectification column	solulal Marangoni effect experimental data	to discuss effect of positive and negative systems on rectification efficiency	Martin & Perez, 1994

Horizontal liquid layer	thermal Marangoni effect numerical simulation	to analyze effect of viscosity and deformable free surface on stationary thermocapillary convection	Kalitzova et al., 1996
Horizontal liquid layer	thermal Marangoni effect experimental data numerical simulation	to study effect of Marangoni number on steady and oscillatory thermocapillary flow	Kamotani et al., 1996
Packed distillation column	solutal Marangoni effect experimental data	to discuss effect positive and negative driving force on mass transfer performance	Proctor et al., 1998
Quiescent gas-Liquid contactor and gas-liquid channel	solutal Marangoni effect experimental data	to show the mass-transfer performance enhanced by interfacial turbulence and to observe interfacial convection by schlieren photography	Sun et al., 2002

Table 3. Some studies related to spontaneous Marangoni convections

Generally speaking, the interfacial disturbance can be divided into artificial and spontaneous Marangoni convection. In order to enhance mass transport, the interfacial disturbance resulted from the added surfactants is called as artificial Marangoni convection. In contrast with artificial Marangoni convection, the gradient of interfacial tension resulted from the process of mass transfer is called as spontaneous Marangoni convection. Some studies related to artificial and spontaneous Marangoni convection are listed in Table 2 and 3.

3.1 Artificial Marangoni convection

By means of the difference of surface tension between spreading and supporting liquids, the artificial Marangoni convection can be induced by the added surfactant or solution on the surface of supporting liquid. In addition, the Marangoni convection could be produced by injecting a few of volatile solute into solvent or adding surfactant vapor to mass transfer system in the process of gas-liquid contacting, and then the mass transfer performance could be enhanced. Except for numerical simulation, the searched papers discussed about mass transfer enhancement by artificial Marangoni convection are shown in Table 2. The artificial Marangoni convections could be occurred in the device with continuous liquid phase, such as falling film absorber, plate absorption system, and liquid-liquid contacting system. For example, the concept of larger difference of surface tension between vapor and absorbent solution can be utilized to produce imbalanced surface tension on liquid surface of falling film system. Once the vapor or the droplet is condensed on liquid surface, the Marangoni convection or wavy surface can be resulted from the imbalanced surface tension. The absorption performance could be enhanced by the artificial Marangoni convection, such as

the saturated n-octanol vapor was added to the falling film absorber by Kashiwagi et al., 1993, and the ethanol vapor was added to the absorption system by Yang et al., 2008. Vazquez et al., 1996, Lu et al., 1997, and Kim et al., 1996 used capillary tube to deposit liquid drops of methanol, ethanol, and n-propanol respectively on the surface of liquid water to enhance mass transfer performance for two concentric absorption system, and the mass transfer enhancement was also shown in Table 2. In addition, aqueous solutions of ionic and non-ionic surfactants were added to the liquid-liquid system respectively to discuss mass transfer enhancement by Agble & Mendes, 2000.

In addition to the interfacial disturbance induced by vapor condensation and liquid drop, the liquid ethanol was used to produce interfacial disturbance in the plate absorption system by authors of this chapter based on the higher volatility and the lower surface tension for liquid ethanol with the properties of high volatility and low surface tension was used to produce interfacial disturbance in the plate absorption system by authors of this chapter. As shown in Fig. 8, the working solutions used to absorb water vapor in the absorption system included triethylene glycol (TEG) and diethylene glycol (DEG) solutions. Pure ethanol was added to the absorbent solution up to 5 wt. % for each experimental run. In order to make humid to be carried by air, pure water was poured into the flask A. Air humidity can be controlled by air flow rate and numbers of flask. After the humidity attained equilibrium in the system, TEG solution with the added ethanol was injected into the absorption cell by liquid valve. Humidity and temperature were measured in the entrance and exit of the absorption cell, and then the mass transfer coefficient were calculated to discuss mass transfer coefficient changed with time and mass transfer performance affected by artificial Marangoni effect. The solution was regenerated at 80°C after experimental operation. Fig. 9 and 10 shows the scheme of mass transfer coefficient changed with time for water vapor absorbed by TEG and DEG solutions respectively. Compared Fig. 9 with Fig. 10, the mass transfer coefficient of water vapor absorbed by DEG solution is slightly greater than that by TEG solution. The mass transfer coefficient for addition of ethanol is greater than that without addition of ethanol, and the mass transfer coefficient is leveled off after 240s. Since the more ethanol evaporates from glycol solution to air phase at the beginning of absorption process, the induced interfacial disturbance should be stronger for the beginning. As also shown in Fig. 9 and 10, the mass transfer enhancement is significant before 150 sec, and then the mass transfer coefficients with and without addition of ethanol are closer. Therefore, the mass transfer performance enhanced by the induced interfacial disturbance can be demonstrated by comparing mass transfer coefficient with and without addition of ethanol in this study.

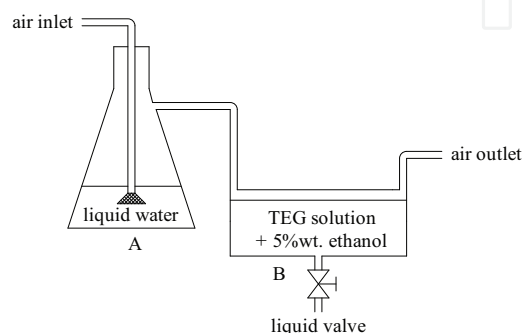

Fig. 8. Plane absorption system with addition of ethanol

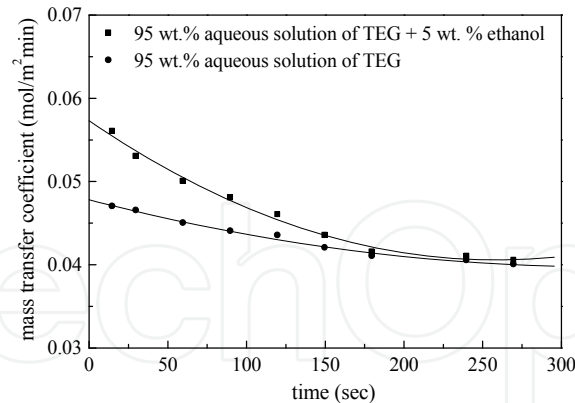

Fig. 9. Mass transfer coefficient for water vapor absorbed by TEG solution in plane absorption system

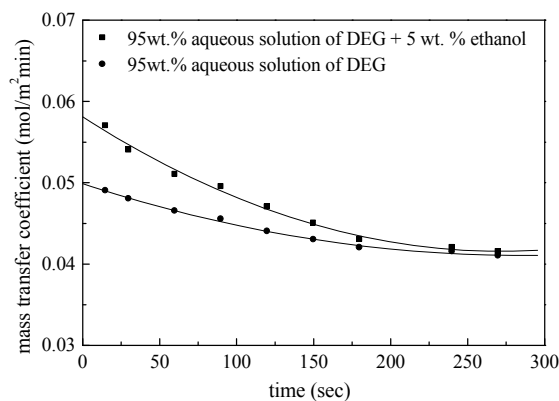

Fig. 10. Mass transfer coefficient for water vapor absorbed by DEG solution in plane absorption system

3.2 Spontaneous Marangoni convection

Table 2 and Table 3 show that the artificial Marangoni convection can be applied into falling-film absorption system, plane-absorption system, and liquid-liquid contacting system; however, the spontaneous Marangoni convection was occurred in the system with fluid circulation or chemical reaction, such as packed distillation column or chemisorptions. Since the difference of surface tension between feed liquid and reflux is larger enough to result in the gradient of surface tension in distillation column, the interface would be disturbed, renewed or accelerated by the gradient. For the spontaneous Marangoni convection, the interfacial instability for falling-film absorption system, packed distillation column, and the system of horizontal liquid layer heated from bottom were often analyzed by mass transfer fundamental and linear stability analysis. Based on the collected references, just some studies discussed effects of spontaneous Marangoni convection on mass transfer performance by practical experimental data; the most studies analyzed and discussed interfacial instability by numerical simulation. Table 3 lists some studies to elucidate effect

of Marangoni effect on mass transfer devices. For the studies of spontaneous Marangoni convection performed by experimental operation, the mass transfer data affected by spontaneous Marangoni convection could be compared with that without spontaneous Marangoni convection or the theoretical data, and the results showed that the mass transfer data affected by spontaneous Marangoni convection were greater than that without spontaneous Marangoni convection or the theoretical data, such as Bakker et al., 1967, Moens, 1972, Patberg et al., 1983, Martin & Perez, 1994, Proctor et al., 1998, and Sun et al., 2002 in Table 3. In addition, most studies attributed the discrepancy between experimental data and predicted results to that the Marangoni effect was not considered into traditional mass transfer theory. For the studies with numerical simulation, some studies discussed effects of Marangoni number and other dimensionless number on interfacial instability for the gradient of surface tension resulted from temperature, such as Kalitova et al., 1996 and Kamotani et al., 1996. Some studies devoted to analyze solutal Marangoni instability resulted from chemisorptions, such as absorption of carbon dioxide by MEA solution. The relevant models were set and solved by numerical method to analyze effects of surface tension on mass transfer, such as Dijkstra et al., 1990 and Warmuzinski & Tanczyk, 1991. The amount of studies related to Marangoni effect is much greater for discussing by numerical simulation; however, establishment of experimental system and confirmation of experimental data are the way to promote engineering and science technology. Therefore, such field still needs more scholars to make effort in future.

4. Marangoni effect in the mass transfer devices and mass transfer performance affected by Marangoni effect

Table 1 shows mass transfer devices and their performance affected by Marangoni effect. As shown in Table 1 and Table 2, Marangoni effect was often discussed for the devices of packed-distillation column, falling-film absorber, two-concentric absorption system, and liquid-liquid contacting system. The dependent variables H_{og} and N_{og} were usually used to discuss mass transfer performance for packed-distillation column, the dependent variables mass transfer coefficient (k_l or k_g) and mass transfer flux (N) were usually used to discuss mass transfer enhancement for absorption system, and the factor F was usually used to discuss the difference of transfer performances with and without Marangoni effect. Since effects of surface tension on performances of mass transfer devices were emphasized in this chapter, introduction of mass transfer devices and effects of surface tension on mass transfer performance are elucidated for packed-distillation column, two-concentric absorption cell, falling film absorber, and liquid-liquid contact system respectively.

4.1 Packed-distillation column

A typical packed distillation column is shown in Fig. 11. The purpose of distillation column is to separate miscible liquids by boiling points of mixture components. In general, a distillation device consists of a distillation column, a condenser, a reboiler, reflux tube, and a heat source. In order to provide contacting area between liquid and vapor phases, the packed-bed or the tray column can be selected. The difference between the packed-bed column and the tray column is that the surface area for packed-bed column is continuous and the surface area for the tray column is discrete. Since the Marangoni effect could be induced from the continuous liquid phase, the packed-bed column was discussed in this

chapter. Liquid flows down the packed bed, and vapor upflows to contact with liquid phase in the countercurrent. The vapor was cooled and condensed in the condenser, and the liquid was reboiled in the reboiler. Once the contacting time is provided enough for gas and liquid phases, the matter with the property of volatile or low boiling point can be obtained in the top of condenser, and the heavier matter can be obtained in the bottom of condenser.

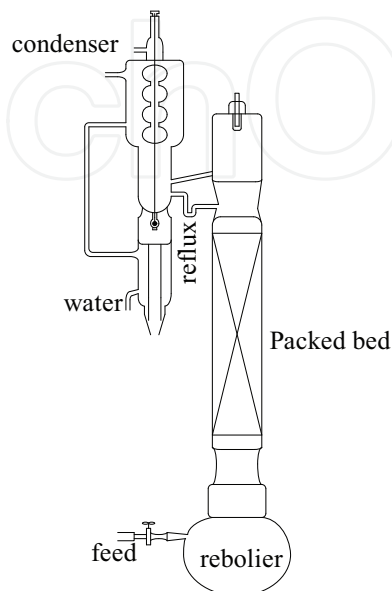

Fig. 11. Schematic diagram of packed-bed distillation column

For the gradient of surface tension, Marangoni effect in the packed-bed distillation column can be divided into positive and negative system. For example, a component of low surface tension transferred from a liquid phase to a gas phase may increase surface tension of the transferred spot on the surface of liquid layer, and then the liquid surrounding the spot is drawn to the spot. The flow phenomenon driven by this kind of surface tension gradient may spread over the packing well in packed-bed column and increase mass transfer performance. Therefore, the system making more packing surface wetted by liquid is called as positive system for the packed-bed distillation column. In the opposite case, if a component of high surface tension transfers from a liquid phase to a gas phase, surface tension of the transferred spot will be decreased. The induced stress is directed from the spot to the surrounding liquid, which leads the wetted surface to be contrasted. Since the mass transfer performance would be decreased with the decreased contact area between gas and liquid phases, such system is called as negative system. In addition, Moens & Bos, 1972 pointed out that the surface renewal effects could be caused by the longitudinal gradient of surface tension for the pool distillation column, that is, evaporation of the component of low surface tension would accompany with the increased surface tension in the direction of liquid flow. Since the liquid flow would be accelerated along the interface and the mass transfer performance would be enhanced by the surface renewal, such a system for promoting surface renewal could be called as a positive system for the pool distillation column. In contrast with the positive system, the surface tension would be decreased in the direction of liquid flow by transferring the component of high surface tension from a liquid phase to a gas phase. The flow velocity would be retarded, and the surface renewal of pool column would be decreased under this condition. Since the mass transfer performance was

increased insignificantly with the increased driving force, the system with bad surface renewal was called as negative system for the pool distillation column. As shown in Fig. 12, Moens & Bos, 1972 and Patberg et al., 1983 demonstrated that the mass transfer

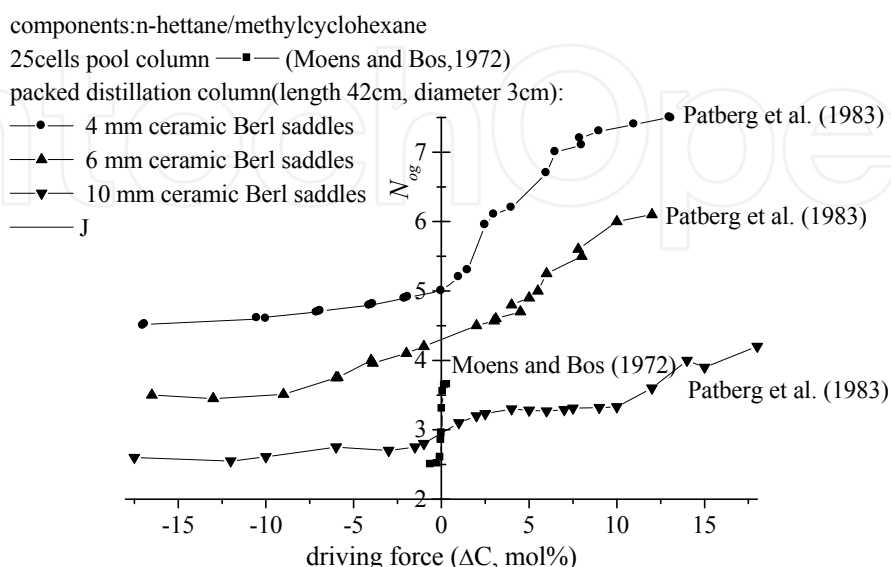

Fig. 12. Effect of driving force on N_{og} for n-heptane/methylcyclohexane

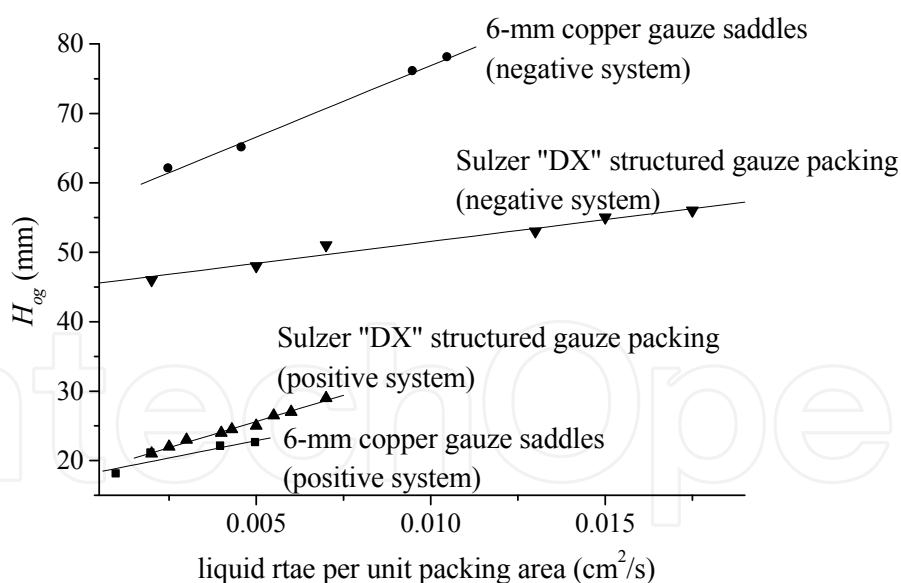

Fig. 13. Effect of surface tension gradient on HTU Values for different packings. (data source: Proctor et al., 1998)

performances were increased significantly for the positive system, especially for the smaller packing. Since the size of pool distillation column established by Moens & Bos, 1972 is larger than that of Patberg et al., 1983, the mass transfer performance seems to be increased more significantly across zero driving force. Besides, the relationship between height of transfer unit and liquid rate was established by Proctor et al., 1998 for packed distillation column, as

shown in Fig. 13. The results also demonstrated that the mass transfer performance of positive system was better than that of negative system. Since the specific surface area of 6-mm copper gauze saddles is larger than that of Sulzer "DX" structured gauze packing, the mass transfer performance for that packed with 6-mm copper gauze saddles is slightly higher than that packed with Sulzer "DX" structured gauze packing under the positive condition. However, the mobility of n-propanol on the surface of Sulzer "DX" structured gauze packing is better than that of 6-mm copper gauze saddles so much that the detrimental effects under the condition of negative system may be overcome partly to lead the better mass transfer performance for Sulzer "DX" structured gauze packing.

4.2 Two-concentric absorption cell

The schematic diagram of two-concentric absorption cell is shown in Fig. 14. The absorbent liquid is injected in the bottom of this system. The liquid flows upwardly along the center of the inner cylinder, and then flows on the plane surface of the inner cylinder. In order to induce interfacial disturbance, the liquid of low surface tension could be fed on the surface of absorbent liquid by the capillary tube. If the interfacial disturbance was considered to be induced by surfactant vapor, the saturated vapor is the better choice to inject from inlet of surfactant vapor. The distance between the fed liquid and the surface of absorbent liquid is as close as possible to avoid Marangoni effect interfered by gravity. Inlet and outlet of the treated air are usually mounted in the opposite sides of capillary tube. The gas can be single component or multi-components. In order to ensure effective contact for gas and liquid phases, some fixed blades are suggested to mount in the absorption system.

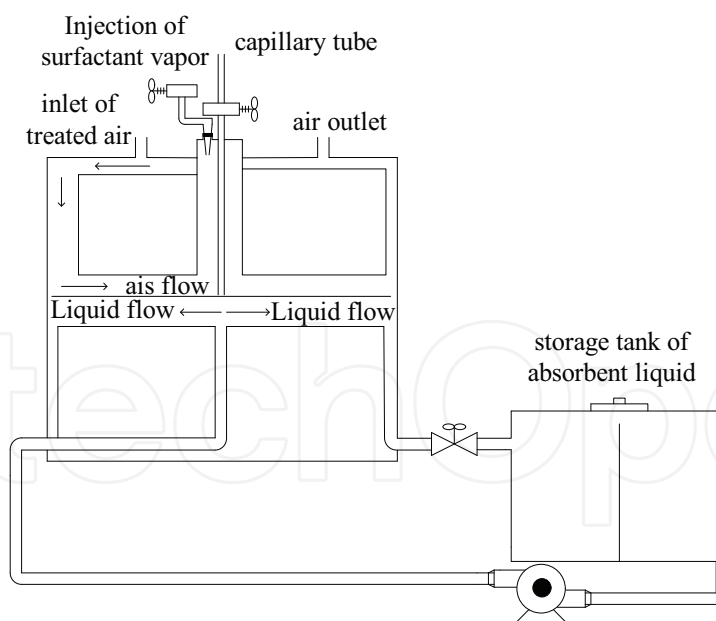

Fig. 14. Schematic diagram of two-concentric absorption system

As known, the gradient of surface tension could be arisen from transferring a component across interface. Thus the interfacial disturbance resulted from the gradient could be occurred in some separation processes, such as distillation, absorption, and extraction. However, it is not easy to discuss effects of interfacial behaviors on mass transfer process because of other interferences, such as buoyancy, gravity, viscosity, and etc. In order to

control the intensity of the induced Marangoni convection, the interfacial convection was induced by adding surfactant liquid of low surface tension at the interface. As shown in Fig. 14, if the difference of surface tension between the absorbent solution (supporting liquid) and the fed liquid (spreading liquid) is large enough, the tangential stress at the interface will be resulted in. Therefore, the Marangoni convection will be produced by the stress in the region between liquid surface and underlying liquid. In general, the spreading liquid with low surface tension was usually added on the surface of supporting liquid to make Marangoni convection artificially, and hence the absorption performance was enhanced with the increased effective area between gas and liquid phases or with the promoted surface renewal. For example, the mass transfer performance of water vapor absorbed by solution of lithium bromide is increased with the increased concentrations of 2-ethyl-1-hexanol in the range from 10 to 100 ppm, as shown in Fig. 15. Fig. 15 also shows that the efficiency of water vapor removed by the solution of lithium chloride is better for the addition of ethanol into gas stream than into working solution. In addition, to discuss effect of surface additives on interfacial disturbance quantitatively, some surface additives were added to absorbent solution, such as aqueous solutions of anionic sodium lauryl sulfate (SLS), anionic sodium dodecyl sulfate (SDS), aqueous solution of cationic cetyltrimethylammonium bromide (CTMAB), and aqueous solution of dodecyl trimethyl ammonium chloride (DTMAC). Lu et al., 1997 showed that mass transfer performance of carbon dioxide absorbed by water could be enhanced by interfacial disturbance resulted from addition of ethanol; however, the mass transfer coefficient was decreased with the increased surfactant concentration, as shown in Fig. 16. Therefore, effects of anionic and cationic surfactants on mass transfer performance of absorption system were demonstrated by Lu et al., 1997 and Vazquez et al., 2000.

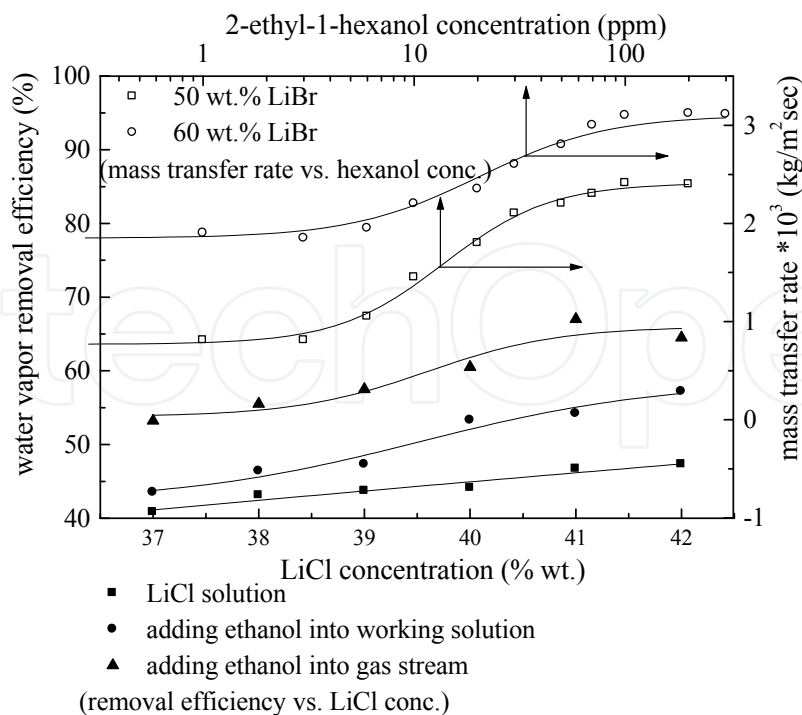

Fig. 15. Effects of the induced interfacial disturbance on mass transfer performance. (data source: Kim et al., 1996 and Yang et al., 2008)

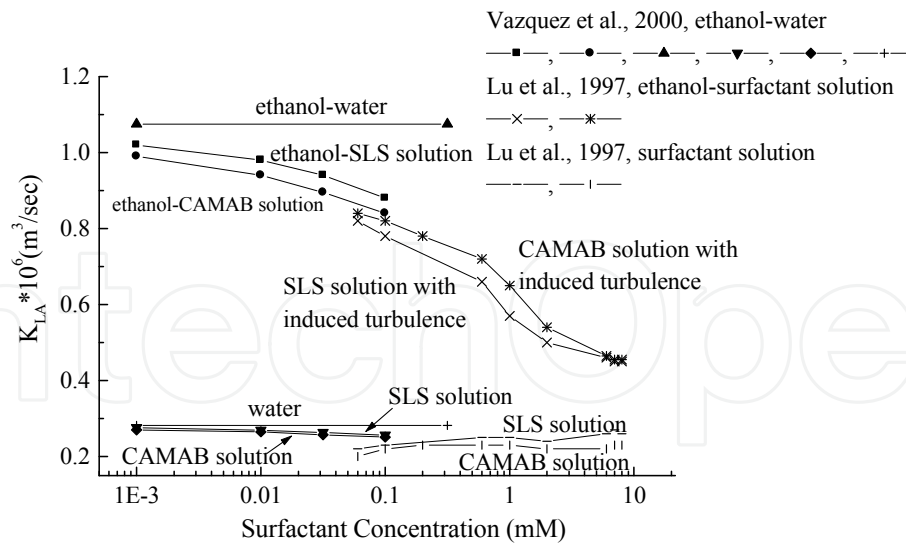

Fig. 16. Effects of the induced Marangoni convection and surfactant concentration on mass transfer performance. (data source: Lu et al., 1997 and Vazquez et al., 2000)

4.3 Falling-film absorber

The common falling-film absorption systems are shown in Fig. 17 and Fig. 18. The advantage of the device in Fig. 17 is that the contacting time or distance between liquid and gas can be adjusted easily; however, the large-scale contacting area between gas and liquid phases, such as the device in Fig. 18, is suitable for observing interfacial behaviors during absorption process. The falling-film absorption system shown in Fig. 17 is mainly consisted of two-concentric annulus pipes, cap, and some flow controller. The absorbent liquid is introduced into the bottom of the falling-film system. The absorbent liquid flows up the inside of the inner annulus pipe, and then is distributed by a cap to form liquid film. Gas inlet and outlet can be designed in the top or bottom of the system. If the gas inlet is in the top of the system, the gas and liquid will flow in the cocurrent. Oppositely, if the gas inlet is in the bottom of the system, the gas and liquid will flow in the countercurrent. While the liquid film flows down the outside of the inner annulus pipe, pollutant in the gas phase is absorbed by the liquid film between cap and gas outlet. The thickness of liquid film can be determined by the width between cap and inner annulus pipe and the liquid flow rate. For the falling-film absorption system shown in Fig. 18, the absorbent liquid may be introduced into the system by the slit-shape distributor or liquid nozzle so much that the thickness of liquid film can be determined by the liquid distributor and liquid flow rate. Similar to the device in Fig. 17, the depositions of gas inlet and outlet determine gas and liquid flowing in the cocurrent or countercurrent.

Similar to the packed-bed distillation column, the gradient of surface tension can be formed by transferring a solute from a liquid phase to a gas phase, and promoting surface renewal by Marangoni convection. If the difference of surface tension between solute and solvent is large enough, the gradient of surface tension will be formed around the spot where the solute evaporates or desorbs. The interfacial disturbance is induced by the gradient of surface tension at the interface so much that the desorbed solute is called as surface-active solute. For example, the liquid-phase mass transfer coefficients with and without interfacial disturbance in the falling film absorption system were compared by Imaishi et al., 1982, and the results showed that desorption performance would be enhanced with the increased

concentration of solute, as shown in Fig. 19. Kashiwagi et al., 1993 also demonstrated that the mass transfer performance would be enhanced by addition of vapor of low surface tension in the falling film system, and the mass transfer enhanced by the surfactant concentration was shown in Fig. 19. The difference of activation of Marangoni convection between Kashiwagi et al., 1993 and Imaishi et al., 1982 is that Kashiwagi et al., 1993 added vapor of low surface tension to induce Marangoni convection artificially, and Imaishi et al., 1982 used the surface-active solute desorbed from absorbent liquid to result in Marangoni convection spontaneously. Whatever the activated method of Marangoni convection was used, the mass transfer enhancements were demonstrated by experimental results how to activate the Marangoni convection. Besides, the solutal Marangoni effect can also be resulted from chemisorptions, such as carbon dioxide absorbed by aqueous solution of monoethanolamine. Therefore, mass transfer enhancement for carbon dioxide absorbed by MEA solution was demonstrated by Brian et al., 1967, and the mass transfer enhancement affected by MEA concentration was shown in Fig. 19. Since the operating conditions were different for these three data point of Brian et al., 1967, the trend differed with other studies was not focused here.

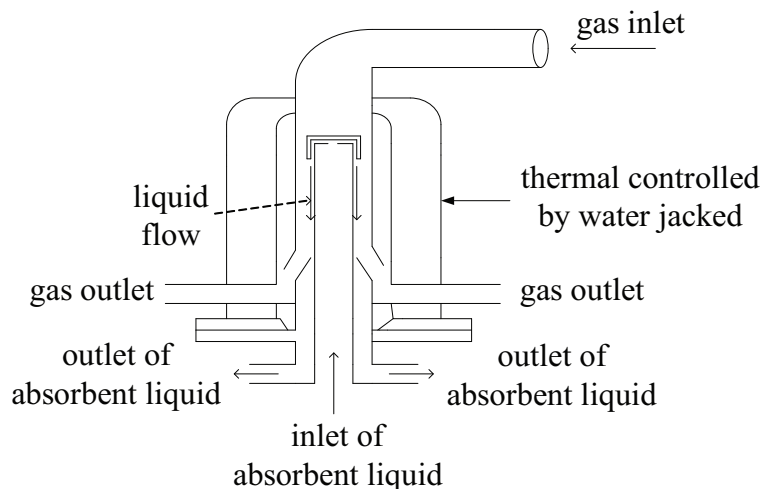

Fig. 17. Schematic diagram of falling-film absorption system consisted of two-concentric pipes. (referred from Imaishi et al., 1982)

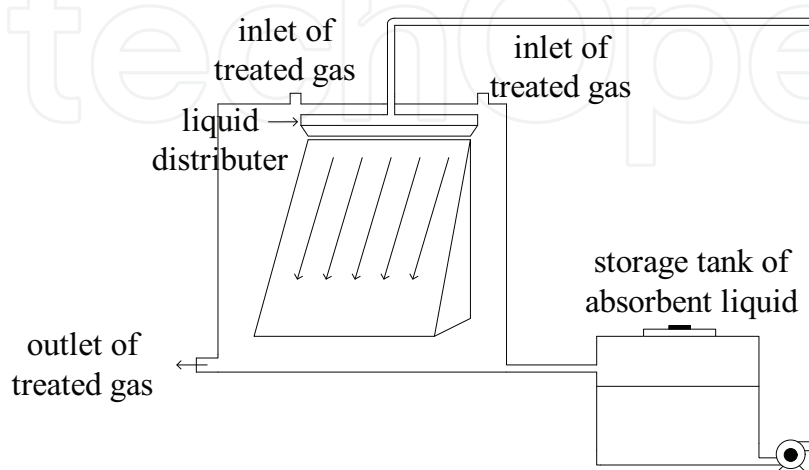

Fig. 18. Schematic diagram of falling-film absorption system consisted of the inclined plane

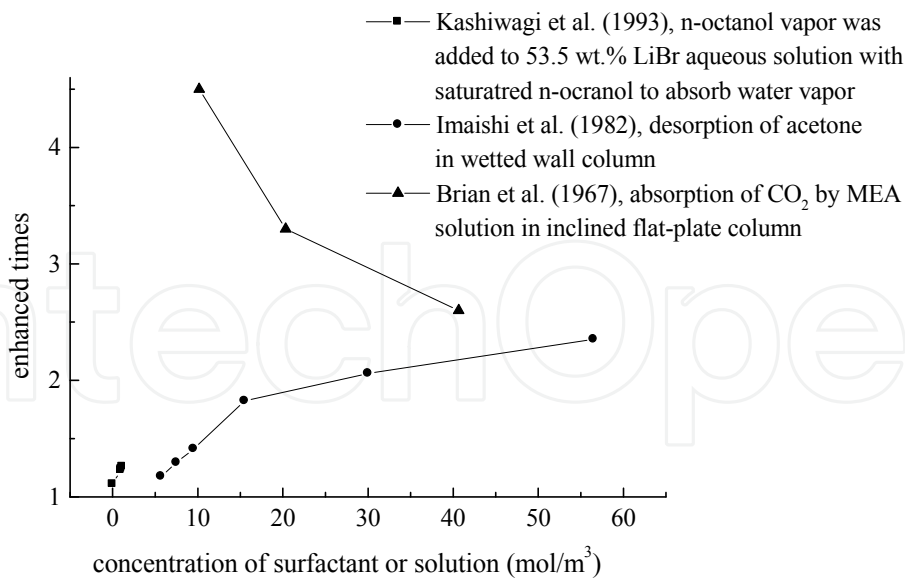

Fig. 19. Effect of concentration of surfactant or solution on mass transfer enhancement

4.4 Liquid-liquid contact system

In order to investigate effect of Marangoni instability on mass transfer performance or interfacial phenomena induced by the gradient of surface tension for liquid-liquid contact system, some kinds of liquid-liquid contact devices were designed. Based on the direction of fluid flow, the liquid-liquid contact system can be generally categorized into vertical and horizontal liquid-liquid mass transfer devices. The schematic diagram of vertical liquid-liquid contact device is shown in Fig. 20. The heavier liquid is introduced at A, and comes into contact with the lighter liquid in the cocurrent. Then the heavier liquid flows over the rod C, and leaves at the valve D. The lighter liquid is introduced at B and leaves the device at valve E. Described above, transport of solute between phases is occurred in the section between F and G. The horizontal liquid-liquid contact devices can also be divided into dynamic and static liquid-liquid contact devices, as shown in Fig. 21 and 22 respectively. As shown in Fig. 21, the heavier and the lighter liquids are introduced at the inlet A and B, and the divider C is used to smooth out the flow. The length between D and E decides the exposure time for transferring solute between phases. The heavier liquid leaves at valve F while the lighter liquid leaves at valve G after the exposure time. In order to observe periodic Marangoni instability in liquid-liquid mass transfer device, transport of a surfactant, such as cetyltrimethylammonium bromide, from an aqueous to an organic phase in the static liquid-liquid contact system, as shown in Fig. 22, was performed by Lavabre et al., 2005. In general, the organic solution was placed in the bottom of the beaker, and then the aqueous solution was introduced on the top of the organic solution. The advantage of this system is to make the visualization of interfacial disturbance easier.

For the system of transferring a solute from one liquid phase to another liquid phase, development of interfacial instability depends on the differences of surface tension between liquid A and surfactant and that between surfactant and liquid B. Fig. 23 shows that a solute diffuses from liquid A to liquid B. Assuming that the surface tension of solute is less than those of liquid A and liquid B, and then the interfacial tension will be decreased with the increased concentration of solute. If a solute is transferred from bulk liquid A to the point S, a small disturbance near point S will be resulted from the gradient of interfacial tension. The

underlying liquid is brought with the small disturbance to the interface, and the interfacial instability is promoted. Furthermore, the solute diffuses from interface to bulk liquid B, and then the interfacial tension at point S increases with the decreased concentration of solute. Since the gradient of interfacial tension resulted from solute transferring from interface to liquid B is opposite to that transferring from liquid A to interface, the disturbance induced by transferring solute from interface to liquid B will be opposite to that transferring from liquid A to interface. Therefore, the interfacial instability will depend on the differences of surface tension between surfactant and liquid A and that between surfactant and liquid B. Mentioned above, transferring a solute from one liquid phase to another liquid phase might cause the gradient of concentration in the interface, and then the gradient of surface tension may be formed by the gradient of concentration. Once the difference of surface tension between surfactant and liquid A is differ from that between surfactant and liquid B significantly, the interfacial disturbance will be occurred by the solutal Marangoni effect. For example, Maroudas & Sawistowskis, 1964 used the F-factor to discuss transfer of solute across liquid/liquid system in the horizontal, and the F-factor was used to show the intensity of interfacial disturbance. Since the F-factor is greater than unity in the dynamic liquid/liquid system especially for the initial 500s, the spontaneous interfacial disturbance was verified for transferring phenol between carbon tetrachloride and water, as shown in Fig. 24. Besides, the mass transfer flux was used by Agble & Mendes, 2000 to discuss effect of surfactants on interfacial mass transfer for liquid-liquid contact system. As a result of the presence of ionic surfactant, such as dodecyl trimethyl ammonium bromide, the molar flux was enhanced by the induced Marangoni convection especially for the initial 2000s, as shown in Fig. 24. In contrast with nonionic surfactant, such as ATLAS G 1300, and pure water, the molar fluxes were lower than that addition of an ionic surfactant, and the molar fluxes seemed to be equal for the nonionic surfactant and pure water. The result means that Marangoni convection could be dampened by the addition of a nonionic surfactant.

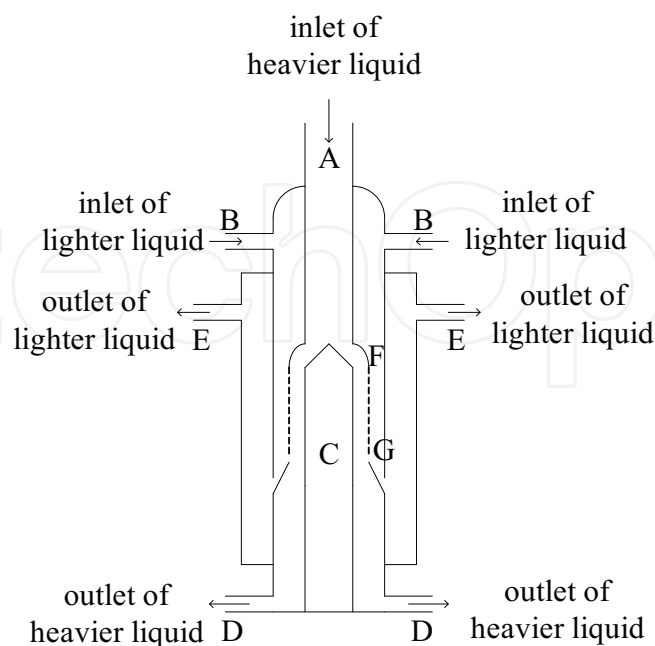

Fig. 20. Schematic diagram of liquid-liquid contact device in the vertical. (referred from Bakker et al., 1967)

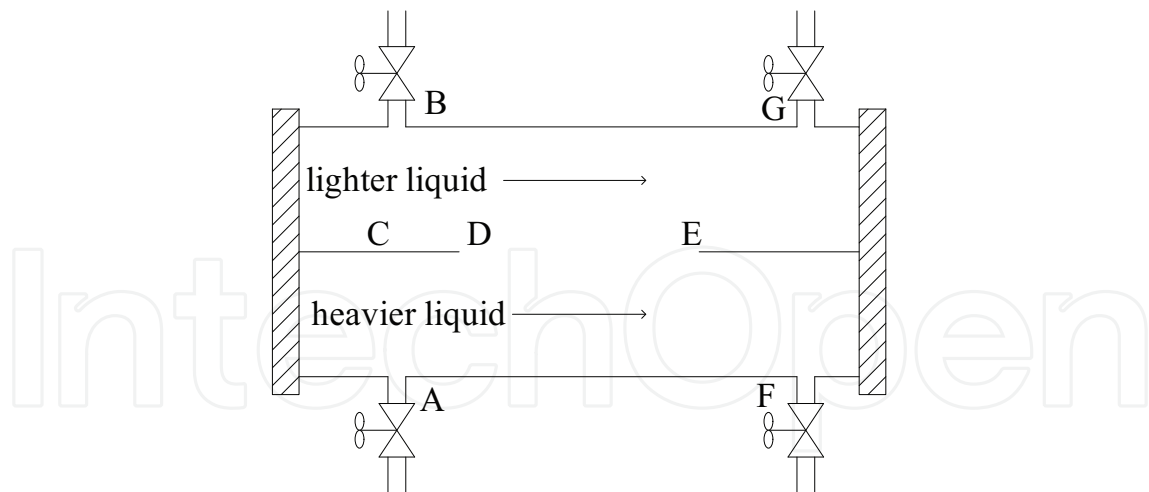

Fig. 21. Schematic diagram of dynamic liquid-liquid contact device in the horizontal. (referred from Maroudas & Sawistowski, 1964)

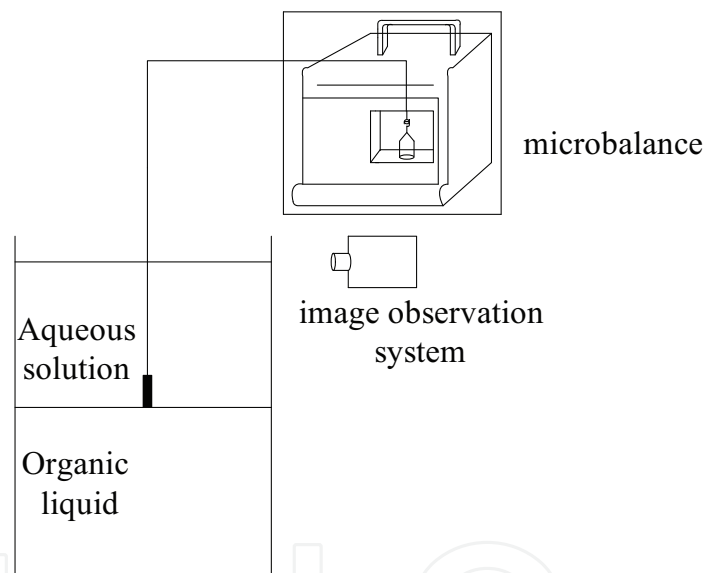

Fig. 22. Schematic diagram of static liquid-liquid contact device in the horizontal. (referred from Lavabre et al. 2005)

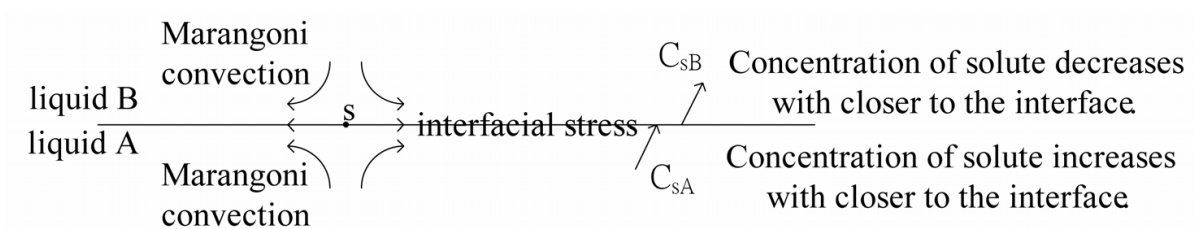

Fig. 23. Schematic diagram of Marangoni convection resulted from liquid-liquid contact system. (Referred from Miller & Neogi, 1985)

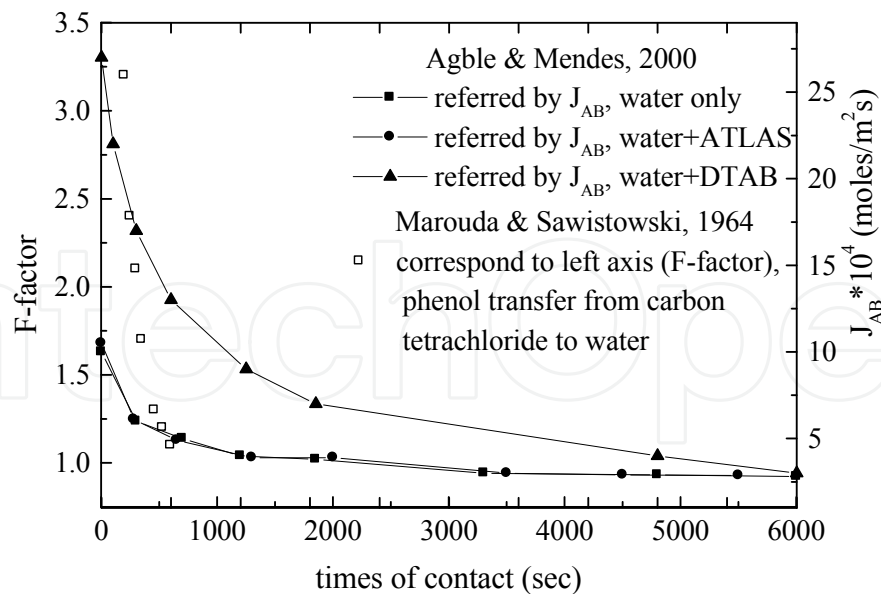

Fig. 24. Effects of contact time of mass transfer enhancement

5. Conclusions

The surface tension not only can apply for daily life but also can apply for engineering and scientific technology. For example, the surface tension can be applied into eye drops, ball pen, condensed liquid drop, capillary phenomenon, liquid lens, and etc. for the daily life. Besides, the surface tension can also be applied into semiconductor drying, artificial rainfall, and mass transfer enhancement for engineering and scientific technology. Since the effective area can be increased by interfacial disturbance, the surface tension plays an important role between phases. For example, the gradient of surface tension was used to induce interfacial disturbance to improve mass transfer efficiency by some studies. The purpose of this chapter is also to discuss the performance of mass transfer devices affected by the Marangoni effect, which is resulted from the gradient of surface tension.

First, the fluid flow in thin liquid film, thinner liquid layer, and mass transfer devices was introduced, and then the observation of interfacial disturbance resulted from liquid drop instilled on the surface of TEG solution was presented by the author of this chapter. The disturbed phenomena of liquid drop on the surface of TEG solution was used to explain successfully why the Marangoni effect occurred in the absorber with continuous liquid phase. In addition, artificial and spontaneous Marangoni convection were described in this chapter. Table 2 and Table 3 show some studies related to artificial and spontaneous Marangoni convection in the mass transfer devices. Evaporation of ethanol was used by author to form the gradient of surface tension, and then the mass transfer performance increased with the induced interfacial disturbance was demonstrated by the experimental results. Finally, the interfacial disturbance resulted from the gradient of surface tension and performance affected by the interfacial disturbance for these devices, such as packed-bed distillation column, two-concentric absorption cell, falling-film absorber, and liquid-liquid contact system, were described and analyzed.

Mentioned above, the surface tension is an important physics at the interface. The formed gradient of surface tension not only changes effective area between gas and liquid phases, but also affects the mass transfer mechanism. The results always make the traditional mass

transfer fundamental underestimate the practical mass transfer data. In order to describe the interfacial disturbance resulted from the gradient of surface tension more precisely; some models and relevant governing equations had been established and solved to explain mass transfer affected by Marangoni effect. However, the phenomena of fluid flow dominated by Marangoni effect seem to be still in the stage of speculation. Since the interfacial convection induced by the gradient of surface tension is difficult to observe by naked eyes, development of computational fluid dynamic can be suggested to describe effects of surface tension on fluid flow of the mass transfer devices in future. In order to promote the application of the Marangoni effect in the engineering and scientific technology, more researches discussed about Marangoni effect and more data confirmed the interfacial disturbance will be expected to fill the gap of this filed by more excellent scholars.

6. References

- Agble, D. & Mendes-Tatsis, M. A. (2000). The Effect of Surfactants on Interfacial Mass Transfer in Binary Liquid-Liquid System. *International Journal of Heat and Mass Transfer*, 43, 1025-1034, ISSN: 0017-9310.
- Bakker, C. A. P.; Vlissingen, Fentener, F. H. & Beek, W. J. (1967). The Influence of the Driving Force in Liquid-Liquid Extraction—a Study of Mass Transfer with and without Interfacial Turbulence under Well-Defined Conditions. *Chemical Engineering Science*, 22, 1349-1355, ISSN: 0009-2509.
- Brian, P. L. T.; Vivian, J. E. & Matiatos, D. C. (1967). Interfacial Turbulence during the Absorption of Carbon Dioxide into Monoethanolamine. *AIChE J.*, 13(1), 28-36, ISSN: 0001-1541.
- Buzek, J. (1983). Some Aspects of the Mechanism of Cellular Convection. *Chemical Engineering Science*, 38(1), 155-160, ISSN: 0009-2509.
- Cachile, M.; Cazabat, A. M.; Bardon, S.; Valignat, M. P. & Vandembrouck, F. (1999). Spontaneous Spreading of Surfactant Solutions on Hydrophilic Surfaces. *Colloids and Surfaces A: Physicochemical and Engineering Aspects*, 159, 47-56, ISSN: 0927-7757.
- Chung, B. T. F.; Fan, L. T. & Hwang, C. L. (1971). Surface Renewal and Penetration Models in the Transient State. *AIChE J.*, 17(1), 154-160, ISSN: 0001-1541.
- Colinet, P.; Joannes L.; Iorio C. S.; Haut, B.; Bestehorn, M.; Lebon, G. & Legros, J. C. (2003). Interfacial Turbulence in Evaporating Liquids: Theory and Preliminary Results of the ITEL-MASTER 9 Sounding Rocket Experiment. *Adv. Space Res.*, 32(2), 119-127, ISSN: 0273-1177.
- Dijkstra, H. A. & Drinkenburg, A. A. H. (1990). Enlargement of Wetted Area and Mass Transfer due to Surface Tension Gradients: the Creeping Film Phenomenon. *Chemical Engineering Science*, 45(4), 1079-1088, ISSN: 0009-2509.
- Imaishi, N.; Suzuki, Y.; Hozawa, M. & Fujinawa, K. (1982). Interfacial Turbulence in Gas-Liquid Mass Transfer. *International Chemical Engineering*, 22(4), 659-665, ISSN: 0020-6318.
- Kalizova-Kurteva, P. G.; Slavtchev, S. G. & Kurtev, I. A. (1996). Stationary Marangoni Instability in a Liquid Layer with Temperature-Dependent Viscosity and Deformable Free Surface. *Microgravity sci. technol.*, IX/4, 257-263, ISSN: 0938-0108.
- Kaminsky V. A.; Vyaz'min A. V.; Kulov N. N. & Dil'man V. V. (1998). Marangoni effect in the Presence of Bulk Turbulence. *Chemical Engineering Science*, 53(19), 3347-3353, ISSN: 0009-2509.

- Kamotani, Y. & Masud, J. (1996). Oscillatory Convection Due to Combined Buoyancy and Thermocapillarity. *Journal of Thermophysics and Heat Transfer*, 10(1), 102-108, ISSN: 0887-8722.
- Kashiwagi, T.; Rie, Dong-ho; Kurosawa, S.; Nomura, T. & Omata, K. (1993). Marangoni Effect on the Process of Steam Absorption into a Falling Film of an Aqueous Solution of LiBr. *Heat Transfer-Japanese Research*, 22(4), 355-371, ISSN: 0096-0802.
- Kim, J.-K.; Jung, J. Y.; Kim, J. H.; Kim, M.-G.; Kashiwagi, T & Kang, Y. T. (2006). The Effect of Chemical Surfactants on the Absorption Performance during NH₃/H₂O Bubble Absorption Process. *International Journal of Refrigeration*, 29, 170-177, ISSN: 0140-7007.
- Kim, Kwang J; Berman, Neil S. & Wood, Byard D. (1996). Absorption of Water Vapor into LiBr Solutions with 2-Ethyl-1-Hexanol. *AIChE J.*, 42(3), 884-888, ISSN: 0001-1541.
- Lavabre, D.; Pradines, V; Micheu, Jean-Claude & Pimienta, V. (2005) Periodic Marangoni Instability in Surfactant (CATB) Liquid/Liquid Mass Transfer. *J. Phys. Chem. B*, 109, 7582-7586, ISSN: 1089-5647.
- Lu, Hsin-Hsen; Yang, Yu-Min; Maa & Jer-Ru (1996). Effect of Artificially Provoked Marangoni Convection at a Gas/Liquid Interface on Absorption. *Ind. Eng. Chem. Res.*, 35, 1921-1928, ISSN: 0888-5885.
- Lu, Hsin-Hsen; Yang, Yu-Min & Maa, Jer-Ru (1997). On the Induction Criterion of the Marangoni Convection at the Gas/Liquid Interface. *Ind. Eng. Chem. Res.*, 36, 474-482, 0888-5885
- Maroudas, N. G. & Sawistowski, H (1964). Simultaneous Transfer of Two-Solutes across Liquid-Liquid Interfaces. *Chemical Engineering Science*, 19, 919-931, ISSN: 0009-2509.
- Martin, Martin & Perez, Chica (1994). The Influence of Surface Tension on the Volumetric Mass Transfer Coefficient in Rectification. *International Chemical Engineering*, 34(1), 76-81, ISSN: 0020-6318.
- Miller, C. A. & Neogi, P. (1985). *Interfacial Phenomena Equilibrium and Dynamic Effects*, Marcel Dekker, ISBN: 0-8247-7490-6, New Work.
- Moens, F. P. & Bos, R. G. (1972). Surface Renewal Effects in Distillation. *Chemical Engineering Science*, 27, 403-408, ISSN: 0009-2509.
- Patberg, W. B.; Koers, A.; Steenge, W. D. E. & Drinkenburg A. A. H. (1983). Effectiveness of Mass Transfer in a Packed Distillation Column in Relation to Surface Tension Gradients. *Chemical Engineering Science*, 38(6), 917-923, ISSN: 0009-2509.
- Proctor, Sebastian J.; Biddulph, Michael W. & Krishnamurthy, Krish R. (1998). Effects of Marangoni Surface Tension Forces on Modern Distillation Packings. *AIChE J.*, 44(4), 831-835, ISSN: 0001-1541.
- Sun, Z. F. (2006). Onset of Rayleigh-Benard-Marangoni Convection in Gas-Liquid Mass Transfer with Two-Phase Flow: Comparison of Measured Results with Theoretical Results. *Ind. Eng. Chem. Res.*, 45, 6325-6329, ISSN: 0888-5885.
- Sun, Z. F.; Wang, S. Y. & Miao, Y. Z. (2002). Absorption and Desorption of Carbon Dioxide into and from Organic Solvents: Effects of Rayleigh and Marangoni Instability. *Ind. Eng. Chem. Res.*, 41, 1905-1913, ISSN: 0888-5885.
- Vazquez, G.; Antorrena, G.; Navaza, J. M. & Santos, V. (1996). Absorption of CO₂ by Water and Surfactant Solutions in the Presence of Induced Marangoni Effect. *Chemical Engineering Science*, 51(12), 3317-3324, ISSN: 0009-2509.

- Vazquez, G; Antorrena, G. & Navaza, J. M. (2000). Influence of Surfactant Concentration and Chain Length on the Absorption of CO₂ by Aqueous Surfactant Solutions in the Presence and Absence of Induced Marangoni Effect. *Ind. Eng. Chem. Res.*, 39, 1088-1094, ISSN: 0888-5885.
- Warmuzinski, Krzysztof & Tanczyk, Marek (1991). Marangoni Instability during the Absorption of Carbon Dioxide into Aqueous Solutions of Monoethanolamine. *Chem. Eng. Process.*, 30, 113-121, ISSN: 0255-2701.
- Wu, Honda & Chung Tsair-Wang (2006). Analysis of Effect of Gas-Liquid Interfacial Disturbance on Mass Transfer Performance. *Surface Review and Letters*, 13 (2 & 3), 279-286, ISSN: 0218-625X.
- Wu, Honda & Chung, Tsair-Wang (2008). Influences for the Addition of Ethanol to the Absorption System on the Interfacial Disturbances and Mass Transfer Performance. *Ind. Eng. Chem. Res.*, 47, 7397-7404, ISSN: 0888-5885.
- Wu, Honda; Chung, Tsair-Wang & Lai, Ming-Hong (2001). Effects of Marangoni Convection on the Mass Transfer Performance in a Packed-Bed Absorber. *Ind. Eng. Chem. Res.*, 40, 885-891, ISSN: 0888-5885.
- Yang, Nai-Hsuan; Chen, Yi-Jen; Liao, Chien-Chin & Chung, Tsair-Wang (2008). Improved Absorption in Gas-Liquid Systems by the Addition of a Low Surface Tension Component in the Gas and/or Liquid Phase. *Ind. Eng. Chem. Res.*, 47, 8823-8827, ISSN: 0888-5885.
- Zanfir, M.; Gavriilidid, A; Wille, Ch. & Hessel, V. (2005). Carbon Dioxide Absorption in a Falling Film Microstructured Reactor: Experiments and Modeling. *Ind. Eng. Chem. Res.*, 44, 1742-1751, ISSN: 0888-5885.
- Zhang, X.; Wang, J.; Zhang, C.-F.; Yang, Y.-H. & Xu, J.-J. (2003). Absorption Rate into a MDEA Aqueous Solution Blended with Piperazine under a High CO₂ Partial Pressure. *Ind. Eng. Chem. Res.*, 42, 118-122, ISSN: 0888-5885.

IntechOpen

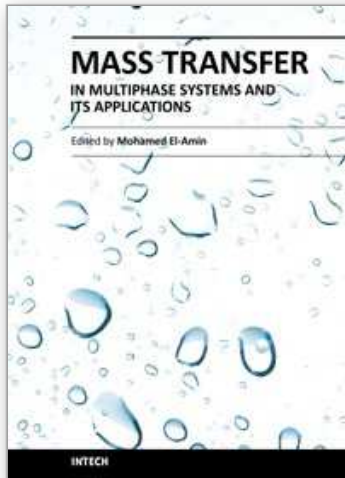

Mass Transfer in Multiphase Systems and its Applications

Edited by Prof. Mohamed El-Amin

ISBN 978-953-307-215-9

Hard cover, 780 pages

Publisher InTech

Published online 11, February, 2011

Published in print edition February, 2011

This book covers a number of developing topics in mass transfer processes in multiphase systems for a variety of applications. The book effectively blends theoretical, numerical, modeling and experimental aspects of mass transfer in multiphase systems that are usually encountered in many research areas such as chemical, reactor, environmental and petroleum engineering. From biological and chemical reactors to paper and wood industry and all the way to thin film, the 31 chapters of this book serve as an important reference for any researcher or engineer working in the field of mass transfer and related topics.

How to reference

In order to correctly reference this scholarly work, feel free to copy and paste the following:

Honda (Hung-Ta) Wu and Tsair-Wang Chung (2011). Effect of Surface Tension on Mass Transfer Devices, Mass Transfer in Multiphase Systems and its Applications, Prof. Mohamed El-Amin (Ed.), ISBN: 978-953-307-215-9, InTech, Available from: <http://www.intechopen.com/books/mass-transfer-in-multiphase-systems-and-its-applications/effect-of-surface-tension-on-mass-transfer-devices>

INTECH
open science | open minds

InTech Europe

University Campus STeP Ri
Slavka Krautzeka 83/A
51000 Rijeka, Croatia
Phone: +385 (51) 770 447
Fax: +385 (51) 686 166
www.intechopen.com

InTech China

Unit 405, Office Block, Hotel Equatorial Shanghai
No.65, Yan An Road (West), Shanghai, 200040, China
中国上海市延安西路65号上海国际贵都大饭店办公楼405单元
Phone: +86-21-62489820
Fax: +86-21-62489821

© 2011 The Author(s). Licensee IntechOpen. This chapter is distributed under the terms of the [Creative Commons Attribution-NonCommercial-ShareAlike-3.0 License](#), which permits use, distribution and reproduction for non-commercial purposes, provided the original is properly cited and derivative works building on this content are distributed under the same license.

IntechOpen

IntechOpen