

We are IntechOpen, the world's leading publisher of Open Access books Built by scientists, for scientists

4,800

Open access books available

122,000

International authors and editors

135M

Downloads

Our authors are among the

154

Countries delivered to

TOP 1%

most cited scientists

12.2%

Contributors from top 500 universities



WEB OF SCIENCE™

Selection of our books indexed in the Book Citation Index
in Web of Science™ Core Collection (BKCI)

Interested in publishing with us?
Contact book.department@intechopen.com

Numbers displayed above are based on latest data collected.

For more information visit www.intechopen.com



Advancements in Automotive Antennas

Brendan D. Pell, Edin Sulic, Wayne S. T. Rowe,
Kamran Ghorbani and Sabu John
*RMIT University
Australia*

1. Introduction

Today's production vehicles are fitted with a multitude of antennas to facilitate communication and enable a moving vehicle to connect with the outside world. Recent years have seen the introduction of new electronic devices to the automotive environment. These devices are usually designed to aid the driver, increase safety, or enhance the driving experience, and many of them rely on wireless communication to perform their task. Antennas are a necessary part of any wireless communication system, enabling transmission and reception of signals in free-space.

At the same time, automobile manufacturers have been seeking to create cost effective, fuel efficient vehicles with attractive styling. This leads to a focus on sleek, lightweight vehicles with reduced aerodynamic drag and improved styling - an emphasis that would naturally conflict with fitment of traditional antennas. These market preferences, along with the technological factors, have combined in the past few years to drive significant innovation in the world of vehicular antennas.

In this chapter, we review the basics of antennas and radiation and examine the frequencies and services which are commonly used in the automotive environment. We will briefly discuss the antennas traditionally used on vehicles, and then detail the recent developments and trends in automotive antenna research.

2. Antenna fundamentals

Antennas are necessary components of any wireless communications device or system. An antenna is a device designed to send or receive radio waves. The antenna takes a guided wave, usually bound to a transmission line of some type such as a coaxial line, waveguide or microstrip transmission line and allows that same energy to propagate through free space. Antennas are passive devices, meaning that they do not require an external power source. They are also linear, meaning that their function is preserved regardless of the applied power level, and reciprocal, which implies that they behave in an equivalent manner in either transmit or receive modes.

Electrically conductive materials are commonly used to create antennas. Most antennas are made from metals, although they can be constructed from dielectric materials.

2.1 Key properties of antennas

Specialised terminology is used to describe antenna performance. This language allows engineers to express antenna behaviour, specify requirements, and compare various design options. Some of the most commonly used terms are included below. Text which appears in quotation marks is from the IEEE Standard Definitions of Terms for Antennas (IEEE Std 145-1993).

Bandwidth

The *bandwidth* of an antenna refers to “the range of frequencies within which the performance of the antenna, with respect to some characteristic, conforms to a specified standard”. The most common usage of bandwidth is in the sense of *impedance bandwidth*, which refers to those frequencies over which an antenna may operate. This is often defined with the aid of the Voltage Standing Wave Ratio (VSWR) or return loss values from measurements.

Other bandwidths which may be referred to are *gain bandwidth*, which defines the range of frequencies over which the gain is above a certain value, and *axial ratio bandwidth* which may be used in the case of a circularly polarised antenna.

Radiation Pattern

The *radiation pattern* represents the energy radiated from the antenna in each direction, often pictorially. The IEEE Definition states that it is “the spatial distribution of a quantity that characterizes the electromagnetic field generated by an antenna”. Most often this is the radiation intensity or power radiated in a given direction.

Gain

In many wireless systems an antenna is designed to enhance radiation in one direction while minimising radiation in other directions. This is achieved by increasing the *directivity* of the antenna which leads to *gain* in a particular direction. The *gain* is thus “the ratio of the radiation intensity, in a given direction, to the radiation intensity that would be obtained if the power accepted by the antenna were radiated isotropically” (that is, equally in all directions). In the case of a receiving antenna, an increase in gain produces increased sensitivity to signals coming from one direction with the corollary of a degree of rejection to signals coming from other directions. Antenna gain is often related to the gain of an isotropic radiator, resulting in units *dBi*. An alternative is to relate the gain of any given antenna to the gain of a dipole thus producing the units *dBd*. (0 dBd = 2.15 dBi). Antenna gain may be viewed with the aid of a *radiation pattern*.

Polarisation

Polarisation of the wave radiated from an antenna describes the behaviour of the electric and magnetic field vectors as they propagate through free space. Polarisation is typically approximately *linear*. When linear the polarisation may be further described as either *vertical* or *horizontal* based on the orientation of the electric field with respect to earth. In the automotive environment, the polarisation of signals depends on the service in question. Many satellite services (such as GPS) use *circularly polarised* signals. For best performance the polarisation of the receive antenna should match the polarisation of the transmitted signal.

2.2 Impedance matching conventions

In low frequency electronic circuits ordinary wires are used to connect components together to form a circuit. When the frequency in the circuit is high, or the circuit dimensions approach that of a wavelength, a transmission line (a special configuration of wires or flat conductors) must be used to connect these components and avoid reflections. This transmission line has a defined impedance, and allows the high frequency energy to propagate down the line. Impedance discontinuities in this transmission line will cause a reflection and stop effective transmission down the line. For this reason the input impedance of an antenna is critical to achieving proper matching to the transmitting device to which it is attached. Most transmission lines have an impedance of 50Ω , while the impedance of an antenna changes with frequency. At some frequencies a given antenna will not be matched to the transmission line, and will not accept or radiate power, while at those frequencies where the antenna is designed to operate, the impedance of the antenna will allow the electromagnetic energy to pass into the structure and radiate into the surrounding space. These frequencies would be deemed to be inside the antenna's *impedance bandwidth*.

Two measures of stating the impedance matching are commonly used, both of which are based on the reflection coefficient, which is a measure of how much energy is reflected back into the source from the antenna's terminals. The first measure shows the reflection coefficient on a logarithmic scale as $|S_{11}|$. Common definitions require that $|S_{11}|$ be below the -10 dB line to declare an acceptable impedance match. The second measure is similar, but on a linear scale and is referred to as VSWR (Voltage Standing Wave Ratio). In this terminology an antenna is deemed to be well matched to the line where VSWR is less than 2:1. This corresponds to a value of -9.54 dB in the logarithmic scheme, meaning the measures are approximately equivalent. Fig. 1 shows plots of $|S_{11}|$ and VSWR for a dipole

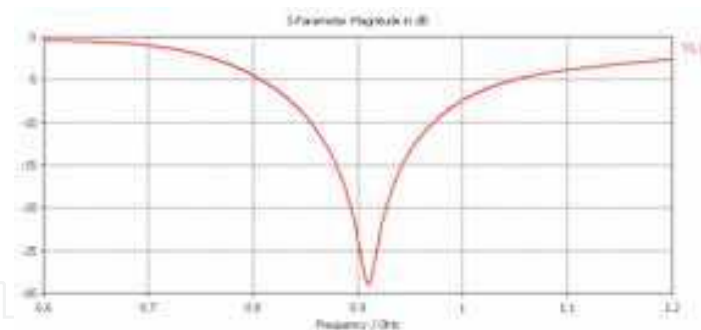

(a) $|S_{11}|$ of a dipole Antenna

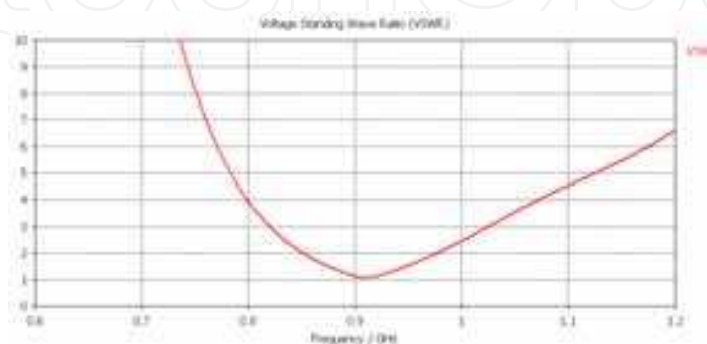

(b) VSWR of same dipole antenna

Fig. 1. (a) $|S_{11}|$ and (b) VSWR of a dipole antenna

antenna which is resonant near 900 MHz. Although the shape of the curves is different due to the use of either log or linear scaling, both plots reveal that the antenna presents a good impedance match to frequencies in the range from approximately 850 MHz to 970 MHz.

Although a 10 dB return loss is typically required in the majority of antenna applications, there are some exceptions. While some high performance systems may specify more precise matching, a notable exception is the cellular phone industry which permits more relaxed specifications. Most modern cellular phone antennas meet an $|S_{11}|$ requirement of -6 dB (Waterhouse, 2008) which is equivalent to a VSWR of 3:1. Recent years of handset design have led to a trade off which sacrifices antenna performance in order to obtain an attractive small sized handset. The signal strengths used in cellular networks combined with advances in receiver technology and modulation schemes compensate for handset antennas having low radiation efficiency and poor electrical performance, resulting in adequate performance of the overall system.

2.3 Radiation pattern essentials

Gain and Radiation Pattern were introduced in Section 2.1. This section describes some common radiation patterns and identifies radiation pattern features. Three dimensional radiation patterns are shown in Fig. 2, while a 2D radiation pattern on a polar plot is shown in Fig. 3.

Isotropic

According to IEEE Standard 145-1993 an *Isotropic* radiator is “a hypothetical, lossless antenna having equal radiation intensity in all directions” (Fig. 2(a)). Such an antenna does not exist, nor can one be created. Nevertheless, an isotropic radiator is a useful concept as a truly omni-directional source and as a reference for gain comparison purposes. When gains are specified in *dBi* the gain of the antenna under test is being described relative to this theoretical standard.

Omni-directional

When an antenna is described as *omni-directional* this is understood to mean that the antenna radiates an “essentially non-directional pattern in a given plane of the antenna and a directional pattern in any orthogonal plane”. A pattern of this type is shown in Fig. 2(b). In this figure it may be observed that the magnitude of the radiation is non-directional in the azimuth (around the sides) but not in elevation (sweeping from high to low). A pattern of this type is produced by dipole antennas and monopoles on an infinite ground plane. It represents an ideal standard for many services in the automotive environment where coverage is required on all angles around the vehicle but not required in the upward direction towards the sky.

Directional

A *directional* radiation pattern is shown in Fig. 2(c). This type of pattern can boost the signal strength due to its higher gain if aimed in the required direction. This comes at the expense of reduced effectiveness in other directions which may be desirable in certain applications. Highly directional antennas are desirable for point-to-point links and have application in automotive radar systems where a narrow beam may be scanned to detect nearby targets.

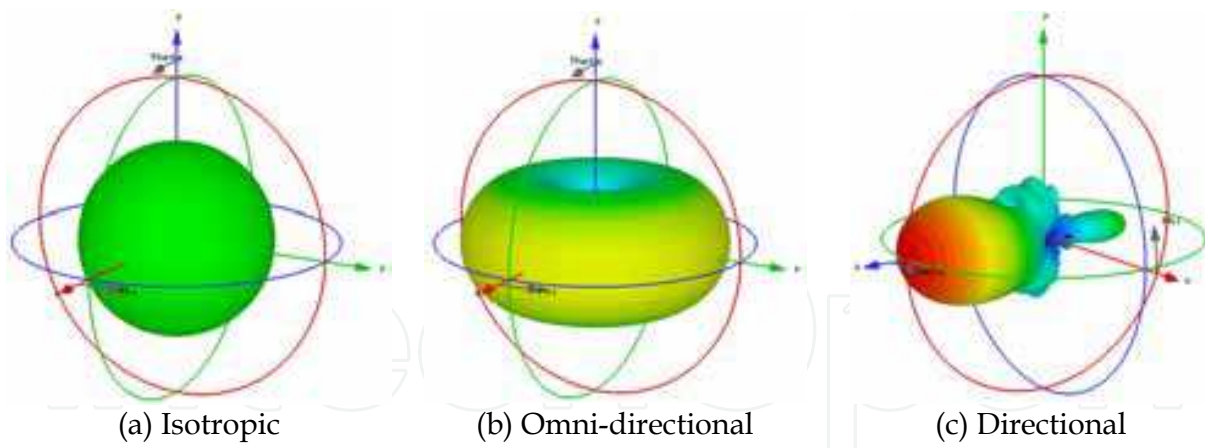

Fig. 2. Three dimensional radiation patterns

A two-dimensional representation highlighting common features

Radiation patterns are often plotted in two-dimensional form. Fig. 3 shows a 2D cut through the y-z plane of the 3D radiation pattern shown in Fig. 2(c). Careful examination of both figures will reveal the equivalence of the radiation information presented.

Distinct parts of a radiation pattern are referred to as lobes. These lobes and other characteristic features of radiation patterns are highlighted in Fig. 3.

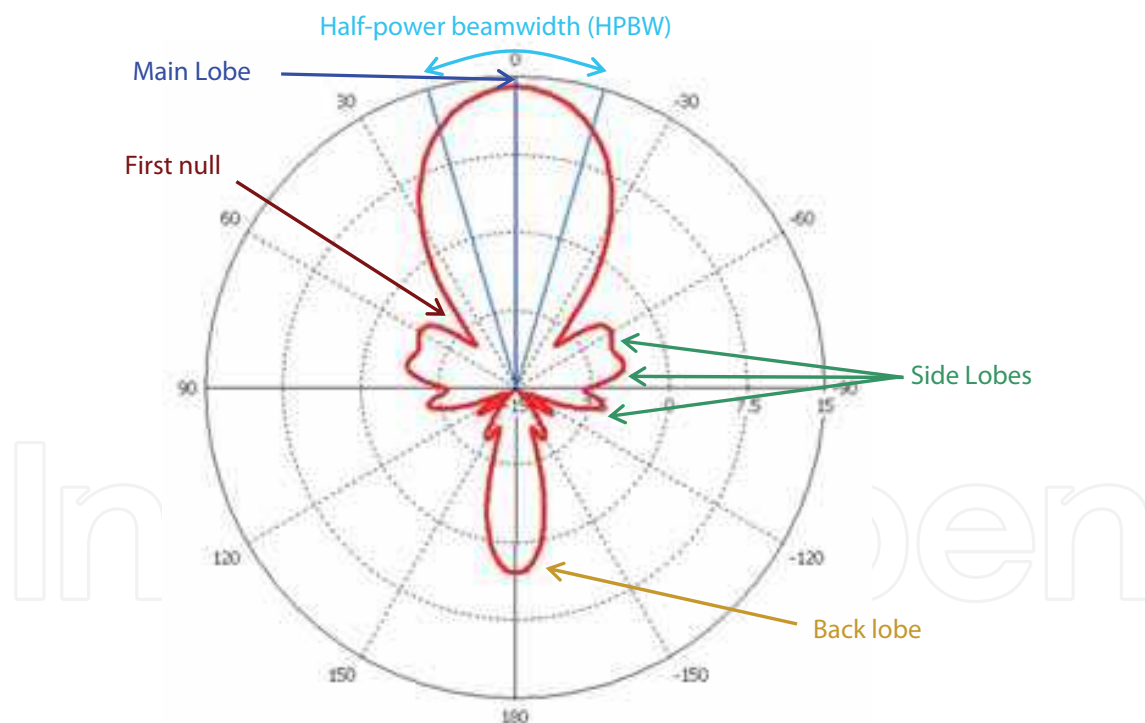

Fig. 3. A sample two dimensional radiation pattern

2.4 Near-field and far-field regions

The space surrounding an antenna may be divided into three approximate regions based on the behaviour of the electromagnetic fields in each of these regions. The first two regions are the *reactive near-field* and *radiating near-field* regions. The properties and configuration of

surrounding material in these regions may alter antenna performance, and the field at any angle is dependent on the distance to the antenna. In the third region known as the *far-field* region however it can be assumed that the antenna is a point source. The far-field region is normally regarded as beginning when the distance to the antenna is equal to $2D^2/\lambda$, where D is the maximum overall dimension of the antenna and continues on to infinity. Once in the far-field region, the radiation pattern and gain may be measured.

2.5 System considerations

Antennas are necessary components of all wireless systems, but are not of themselves sufficient for signal reception. Antennas do not operate in isolation. Here we briefly examine other important factors related to vehicular antenna systems.

Diversity Reception

Some automotive services use *diversity* to enhance the quality of the received signal. In non-line-of-site propagation environments such as the urban environment, reflections and shadows cast by buildings and other structures can cause fading in the signal strength in particular spatial locations or in given directions. In a diversity scheme two or more antennas are mounted in different locations or with different orientations on the vehicle. This provides two independent propagation paths for the signal. On an elementary level the diversity receiver switches between antennas to choose the one with the stronger signal. This provides a higher quality signal with fewer dropouts. Diversity is most commonly employed for FM radio reception purposes. Given that cars fitted with multiple antennas are regarded as being less visually appealing, vehicle manufacturers tend to combine an external mast antenna with a glass mounted antenna to give two distinct antennas for diversity purposes. This approach often achieves spatial and polarisation diversity, along with diversity in radiation direction.

Noise, Sensitivity and the Receiver

Any communications system receives the desired signal plus an unwanted signal which we may call *noise*. Noise comes from a variety of sources, ranging from the random movement of electrons inside any conductor (at a temperature above absolute zero) to Electromagnetic Interference (EMI) coupled in with the signal from nearby devices. In the automotive environment the vehicle's ignition system can be a source of significant EMI, meaning that antennas mounted near the front of the vehicle may receive more noise than an equivalent antenna mounted towards the rear.

Receiving systems have a specified *sensitivity*, which relates the minimum signal strength at the input required to achieve an acceptable Signal-to-Noise ratio (SNR). The sensitivity of commercial automotive receiving systems will have a large impact on the overall quality of the received service, particularly in areas of low signal strength.

In car radio systems the *receiver* may be called a *tuner* since it tunes its internal oscillators to demodulate the required station. The input impedance of the tuner, along with other fundamental properties are important in ensuring proper system operation.

3. Automotive frequencies and wireless services

In previous decades the use of antennas in vehicles was primarily limited to those employed for AM and FM radio. In contrast, today's vehicles are often fitted with many antennas for

additional purposes such as remote keyless entry, satellite navigation, and others. In the future it is likely that vehicles will require still more antennas for such things as mobile internet and mobile video, collision avoidance radar, and vehicle-to-vehicle or vehicle-to-infrastructure communication. A list of present and soon to be realised services is provided in Table 1. Each of these wireless services necessitates the incorporation of a suitable antenna into the vehicular platform to receive signals at the appropriate frequency.

Service	Typical Frequency	Tx*	Rx#	Direction of Radiation
AM Radio	Approximately 1 MHz		Yes	Horizontal
FM Radio	88 MHz to 108 MHz		Yes	Horizontal
In-vehicle TV	50 MHz to 400 MHz		Yes	Horizontal
Digital Audio Broadcasting (DAB)	100 MHz to 400 MHz		Yes	Horizontal
Remote Keyless Entry (RKE)	315 MHz/413 MHz/ 434 MHz		Yes	Horizontal
Tyre Pressure Monitoring System (TPMS)	315 MHz/413 MHz/ 434 MHz	Yes	Yes	Intra-vehicular
Cellular Phone (provision of Internet via HSPA)	850 MHz 900 MHz 1800 MHz 1900 MHz 2100 MHz	Yes	Yes	Horizontal
Satellite Navigation (GPS)	1.575 GHz		Yes	Satellite
Satellite Digital Audio Radio Service (SDARS)	2.3 GHz		Yes	Satellite
IEEE 802.11 b/g/n (Wi-Fi)	2.4 GHz	Yes	Yes	Horizontal
Bluetooth	2.4 GHz	Yes	Yes	Intra-vehicular
WiMAX	2.3 GHz/2.5 GHz/3.5 GHz	Yes	Yes	Horizontal
Electronic Toll Collection (ETC)	5.8 GHz (or 900 MHz)	Yes	Yes	Overhead
V2V+ and VII+	5.9 GHz	Yes	Yes	Horizontal
Collision Avoidance Radar	24 GHz and 77 GHz	Yes	Yes	Forward

* Transmit # Receive + These terms are acronyms for Vehicle-to-Vehicle communication and Vehicle-Infrastructure-Integration using IEEE 802.11p

Table 1. Summary of signals used on modern and next generation vehicles

The lowest frequencies used in vehicles are often for *AM* and *FM radio*. The history of radios in cars is vague but dates back to the 1920's. During this time period the installation of such devices was deemed unsafe and illegal in at least one US state (Rowan & Altgelt, 1985). Significant policy change obviously occurred over the years given that AM and FM Radio are installed in nearly all modern day passenger vehicles and are used to provide entertainment for the driver and passengers.

The third entry in the list of services in Table 1 describes *in-vehicle television* for which the necessary hardware is available including diversity receivers to minimise dropouts. In-vehicle television is rarely installed by the factory in present day vehicles, although DVD and multimedia entertainments systems are finding increased uptake in high-end luxury vehicles. *Digital Audio Broadcasting* is a more modern format for broadcasting entertainment radio. DAB uses digital rather than analogue modulation schemes, providing higher spectral efficiency and better quality audio in certain circumstances.

Many present day vehicles are able to be locked and unlocked by pressing a button on a radio transmitter integrated into the car's key or key ring. These services are known as *Remote Keyless Entry*, and typically operate in one of the low power bands shown in the table. These bands are often shared with *Tyre Pressure Monitoring Systems* which are finding increased acceptance in the passenger vehicle market and are available as third-party accessories. A typical TPMS has an air pressure sensor and wireless transmitter fitted to each wheel with a receiver unit mounted in or on the dash. The system can alert the driver to low tyre pressure before a flat tyre becomes a safety hazard.

Many frequency bands are used globally for *cellular telephone* (a.k.a. mobile telephone). Blocks of new spectrum are occasionally released by the authorities and purchased by telecommunications companies to cater for increased demand. The most commonly used frequencies are provided in the table. Inclusion of these frequency bands into a vehicle could allow for voice calls and additionally a full suite of services based on high speed access to the internet provided by HSPA (High Speed Packet Access). This has the potential to bring about a realisation of useful Location Based Services, XML based traffic updates and internet connectivity almost anywhere in urban and rural environments.

Guidance and navigation facilities are becoming more cost effective and seeing large uptake in the modern market. These navigation systems usually rely on the constellation of approximately thirty *Global Positioning System* (GPS) satellites to determine the location of the vehicle before plotting it on a map. The GPS L1 band is received in a narrow 20 MHz channel centred at 1.575 GHz.

The *Satellite Digital Audio Radio Service* is also described in the table. This service delivers hundreds of additional radio stations and is implemented by using circularly polarised signals from satellites arranged in an orbit which dwells over the North American continent. In urban environments where buildings can cause multipath and shadowing of the satellites, terrestrial based transmitters are also used.

The 2.4 GHz ISM band has seen enormous growth in the past decade due to the ubiquitous application and implementation of *Wi-Fi* and *Bluetooth* which occupy part of this band. Bluetooth is incorporated into many present day vehicles to allow hands free calling and operation of an equipped mobile through the vehicle's multimedia system. Future vehicles may be fitted with Wi-Fi to enable passengers to access the internet while on a journey.

An emerging technology that will need to compete with LTE and HSPA technologies is *WiMAX*. In a manner similar to the 3G and 4G cellular wireless standards, WiMAX could be used to provide a high speed wireless internet connection to a moving vehicle many kilometres from a base station.

Many *Electronic Toll Collection* systems are implemented at 5.8 GHz, often achieved by windscreen mounted removable wireless tags operating in an active-RFID system.

Vehicle-to-Vehicle communication systems are currently being developed and trialled to enable safer and more efficient road transport. A portion of spectrum at 5.9 GHz has been reserved in many countries for this purpose, where vehicles and road side objects would form networks and share safety information as part of an Intelligent Transportation System (ITS). As an example a system such as this would alert the driver to sudden braking in traffic ahead, and of upcoming lane closures or unexpected obstructions. Emergency vehicles could broadcast warnings to drivers up to 1km away, signalling their presence and intentions. Many phrases have been coined to describe this technology including Dedicated Short Range Communications (DSRC), Vehicle2Vehicle (V2V), and Vehicle-Infrastructure-

Integration (VII). The relevant IEEE standard upon which the wireless connection is based is IEEE 802.11p. The US Department of Transport is developing these technologies in the IntellidriveSM program.

Collision Avoidance Radar is a technology which integrates with the Adaptive Cruise Control (ACC) system of a vehicle to prevent accidents, or in the case where a collision is unavoidable, reduce the severity of the impact. In normal use the system uses RADAR (or optionally LIDAR) to scan the road ahead and will reduce the throttle and apply brakes to automatically maintain a safe buffer distance to the car in front. Some systems will also detect pedestrians or other objects. In the event that the system detects an imminent collision, it may apply emergency braking and other precautionary measures to increase vehicle safety. Collision Avoidance Radar uses very high frequencies for numerous reasons including spectrum availability, the small size of antenna elements enabling integration of necessary phased array radar antennas, and the fact that a higher frequency helps to increase the Radar Cross Section, and therefore, the detection range of targets of interest, such as pedestrians and other vehicles.

4. Traditional AM/FM antennas

4.1 Mast antennas

The low frequency and relatively high signal strengths encountered in AM and FM car radio systems have allowed the use of uncomplicated antenna systems in the past. The most common antenna traditionally used for these bands is the mast antenna. A conductive rod is used to form a monopole antenna, approximately one quarter wavelength ($\lambda/4$) in length, which equates to approximately 75 cm in the middle of the FM band. Locating such an antenna in the centre of the roof gives the best radiation performance, with the antenna elevated above obstructions and surrounded by a conducting ground plane of approximately equal extent in all directions. Despite this, the front or rear fender is usually preferred for aesthetic reasons. Retractable and non-retractable versions are commercially available.

Antennas for receiving FM radio in vehicles should receive signals equally well from all directions around the horizon, due to the movement and rotation of the vehicle with respect to the transmitting source. This quarter wavelength monopole antenna would provide an ideal radiation pattern in the azimuth if it was mounted above an infinite ground plane. Typical fender mounting provides a very non-ideal ground plane however, leading to radiation patterns that are less omni-directional (ie. the radiation becomes directional). Hence, designing such antennas for vehicles has traditionally been an iterative process involving several stages of prototyping and measurement on completed vehicle bodies.

Retractable mast antennas (Fig. 4) allow the antenna to be retracted, hidden and protected when not in use. Such antennas consist of a long rod divided into numerous segments. The segments are appropriately dimensioned to slide inside one another when retracted, leading to a tapering profile when extended. Most modern retractable antennas are raised and lowered by an electric motor leading to increased cost and expense. Such power retractable antennas are often mounted on the passenger side of the vehicle, whilst manually operated retractable antennas tend to be installed on the driver side so the driver can raise or lower the mast without having to walk to the other side of the vehicle.

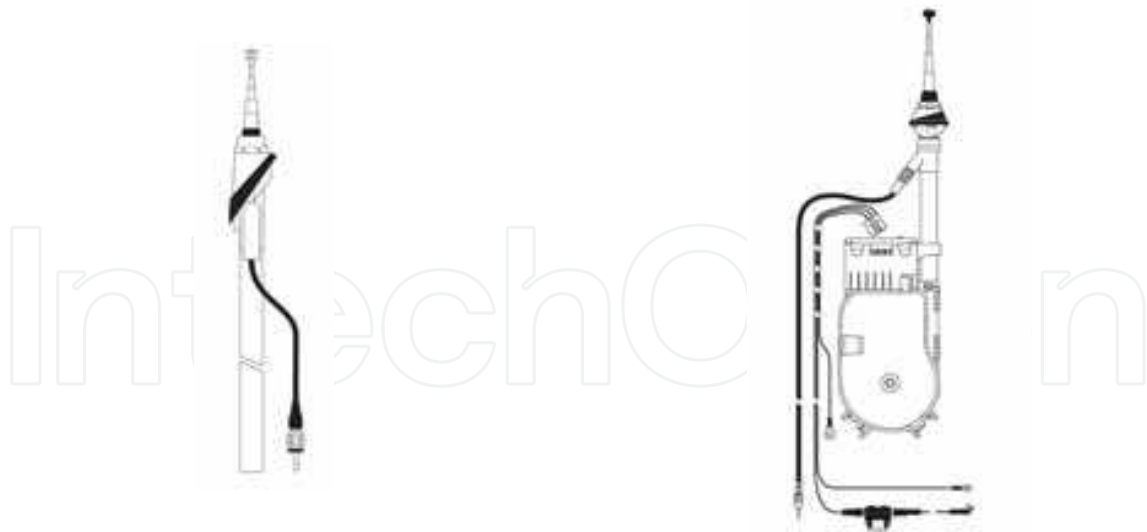

(a) Manually retractable mast antenna

(b) Power retractable mast antenna

Fig. 4. Technical drawings of typical mast antennas

4.2 Glass mounted AM/FM Antennas

A second kind of AM and FM antenna is the glass mounted antenna. AM and FM antennas using this technique have become very common in the last decade, as pre-amplifiers have helped to compensate for poor radiation performance. On modern vehicles, these antennas are similar in appearance to the demister elements commonly embedded in the rear windscreen.

Many glass mounted antennas installed in present day vehicles are based on wire geometry although the antenna may or may not be an actual wire. It can be formed by using wire of a very thin diameter or a silk screened film which is laminated between layers of glass in the vehicle windows (Jensen, 1971). Glass mounted antennas provide no additional aerodynamic drag and create no wind noise which is a significant advantage over mast type designs. They also require no holes to be created in the vehicle body, which may lead to cheaper tooling for the metal work. Despite this, on glass antennas tend to be more directional than mast antennas, which can lead to nulls in the reception on certain angles around the vehicle.

On-glass antennas were first located in the rear windscreen, and this remains a common position on sedans made today. Many SUV's or station wagons use the rear quarter window in preference to the rear window. A variety of different shapes are used for the antennas, often forming grid or meandering geometries, with a shape that works well on one vehicle not necessarily performing well on other vehicles (Gottwald, 1998). No universal glass mounted antenna has yet been discovered. This is due to the effect of the vehicle body on the antenna's impedance and radiation, which is significant for on-glass antennas. Antenna oriented vertically may provide better reception of vertically polarised signals.

Fig. 5 shows a typical active rear window antenna. Early designs adopted the defogger elements themselves and connected through a DC blocking capacitor to the radio tuner. Newer designs often separate these two functions, having a defogger element which occupies most of the glass, with a smaller area set aside for antenna lines.

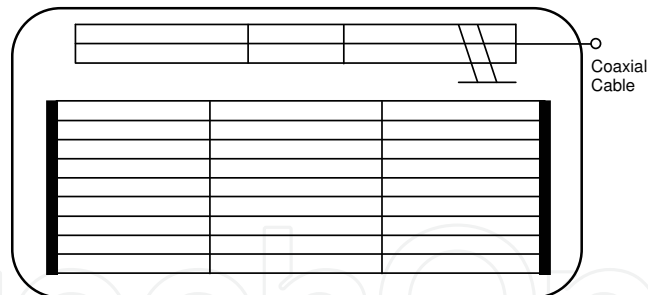

Fig. 5. Schematic of a typical rear windscreen glass antenna.

5. New developments and research outcomes

Examination of production vehicles produced over the past ten to fifteen years reveals a shift away from the traditional quarter wavelength mast antenna towards more aesthetically pleasing antennas. This section provides a review of new findings and innovative solutions to vehicular antenna problems along with the advantages and disadvantages of each type.

5.1 Bee-sting antennas

The bee-sting antenna is a wire antenna similar to the mast antenna used for many decades, but consists of a shortened element installed in a raked back attitude (Fig. 6). An amplifier is used to boost the signal level to compensate for the poor performance obtained by the shorter antenna length (Cerretelli & Biffi Gentili, 2007). Some antennas also include a separate feed for a Cellular phone or DAB system.



Fig. 6. Bee sting antenna © IEEE with permission (Cerretelli & Biffi Gentili, 2007)

5.2 Blade or Shark-fin antennas

Many varieties of shark-fin antennas exist, having been popularised primarily by the European marques near the turn of the 21st century. Shark-fin antennas are commonly a collection of several antennas. Most designs consist of multiple narrowband antennas all located together under a single radome or housing. This housing is typically shaped like a blade or dorsal fin, and is usually located on the roof towards the rear of the vehicle. Two examples of shark-fin designs are shown in Fig. 7.



Fig. 7. Shark-fin Antennas

Fig. 8 shows an early shark-fin antenna design in detail. This design was fitted to the BMW 3-Series (E46) and provides for cellular phone frequencies. The antenna consists of a cast steel base and a fin-shaped cover made from an ABS and Polycarbonate polymer. Radiating elements are on both sides of an FR-4 circuit board which stands erect in the middle of the device. Rubber gaskets are used to seal the inner components from the environment. The design achieves an impedance match (shown in Fig. 9) at the required frequencies by incorporating inline filters which allow the radiators to be a quarter wavelength long at high

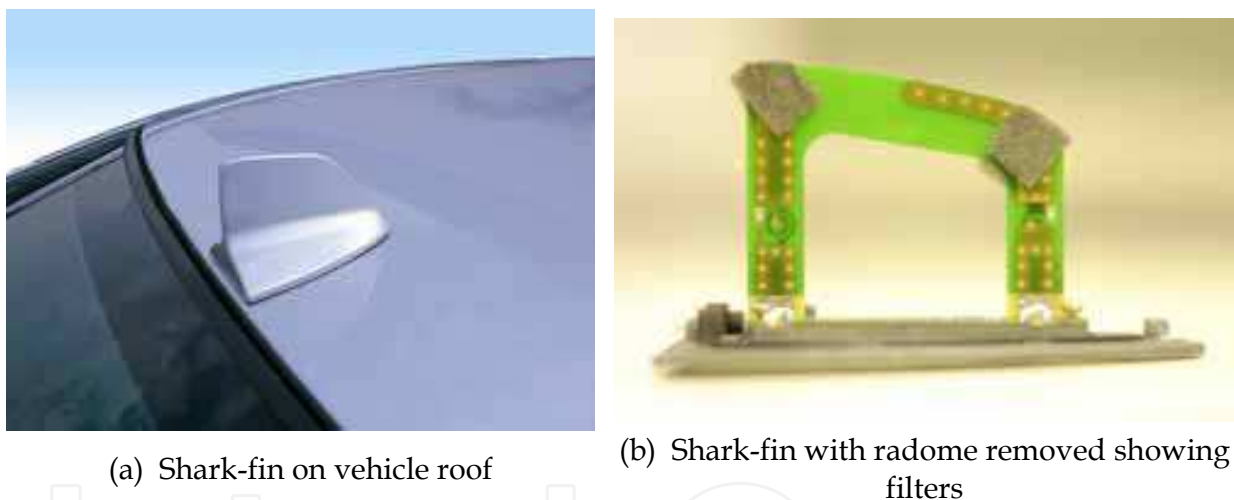

Fig. 8. BMW 3-Series E46 Sharkfin Antenna

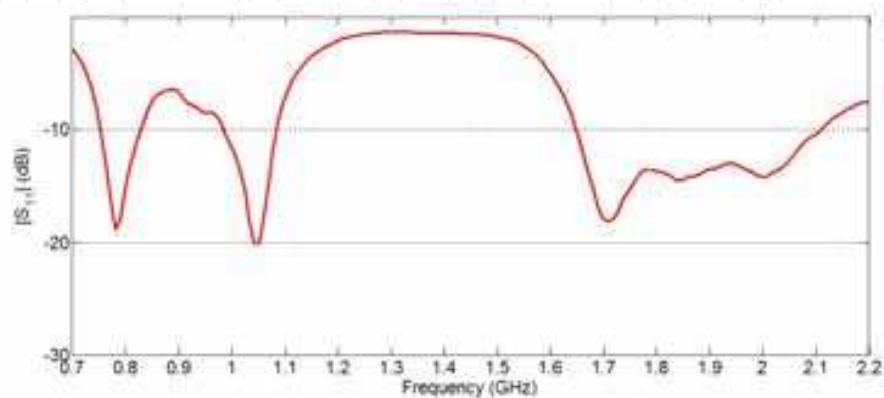

Fig. 9. Measured reflection coefficient of BMW 3-series E46 Shark-fin Antenna

and low frequencies simultaneously. A surface mount resistor is used in conjunction with a printed inductor on the reverse side of the board to form a filter. This filter has the effect of connecting the upper radiating elements at lower frequencies by creating an electrical short circuit. At higher frequencies the filter creates an open circuit, leaving only the short elements connected to the feed line.

Fig. 10 shows a shark-fin style antenna which was published in the literature for use in US automobiles (J.F. Hopf et al., 2007). With the cover removed, it is clear that this antenna demonstrates the case where multiple individual antennas are located together under a single radome.

The leftmost antenna in the figure is a GPS antenna, constructed using a probe fed patch design on a high dielectric constant substrate. This provides a hemispherical radiation pattern covering the sky which is appropriate for receiving satellite signals. Circular polarisation may be induced in patch antennas such as these by truncating diagonally opposite corners of the patch, or by feeding the antenna off centre.

The white antenna to the right of centre in the figure is a crossed frame antenna for SDARS reception.

The two posts present in the design provide for cellular telephone reception. The elements are based on quarter wavelength monopoles with top loading elements to increase the effective electrical length at the low end of the band. The presence of these posts is typical of shark-fin antennas, however these particular posts contain filters which have been optimized to have minimal effect on the nearby SDARS antenna.

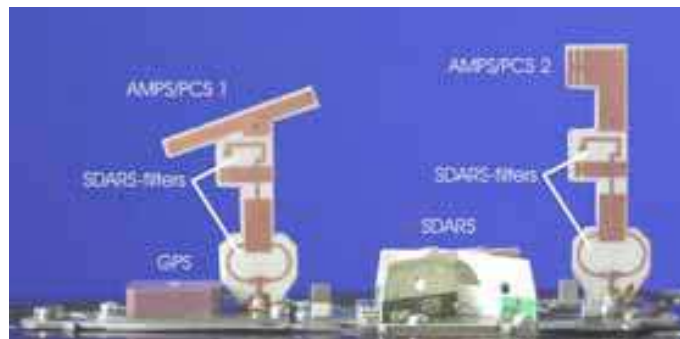

Fig. 10. Internals of a modern shark-fin antenna © IEEE with permission (J.F. Hopf et al., 2007)

5.3 TV antennas on glass

Research has continued into traditional AM and FM antennas mounted on glass even today (Bogdanov et al., 2010), particularly in the area of effective simulation techniques. At the same time, antenna configurations for other services have also been investigated. An early paper describes the system shown in Fig. 11 of a diversity reception system for analogue TV. The antennas are printed on the rear quarter glass and have four branches. The antennas are arranged symmetrically on the left and right sides of the vehicle. The design includes some meandering elements which give a long electrical length in a small space. Other branches of the design include slanted and short horizontal elements. The authors claim the system provides improved performance over a rod antenna, and is capable of operating in the range from 90 MHz to 770 MHz (Toriyama et al., 1987).

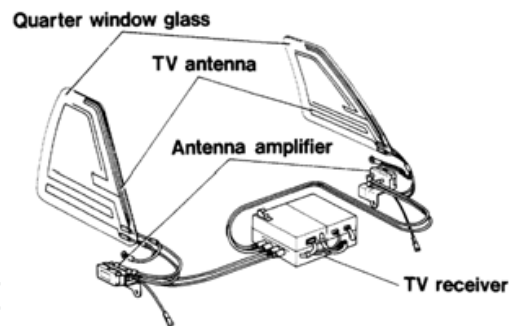

Fig. 11. Analogue TV Antenna system in rear quarter glass
© IEEE with permission (Toriyama et al., 1987)

A glass mounted antenna designed for the newer Digital Terrestrial TV reception is shown in Fig. 12. The H-shaped elements allow both long and short current paths to be formed, providing a wideband impedance match (Iizuka et al., 2005). The long path occurs when current flows diagonally from top left to bottom right in Fig. 12(a), while the shorter path runs diagonally from bottom left to top right. The impedance matching of this design results in a VSWR of less than 3:1 from 470 MHz to 710 MHz when connected to a 110Ω line. The antenna is formed on a low cost FR-4 substrate, and is integrated with an RF circuit which provides a balun, some filtering, and a Low Noise Amplifier (LNA) to boost the signal before it is sent down the transmission line to the tuner. Four of these antennas were installed in the test vehicle shown in Fig. 12(b), being located in the upper portion of both the front and rear windscreen on both driver and passenger sides. The gain and radiation pattern of the system was measured at 530 MHz, and it was found that the radiation pattern was nearly omni-directional at this frequency when all four antennas were excited.

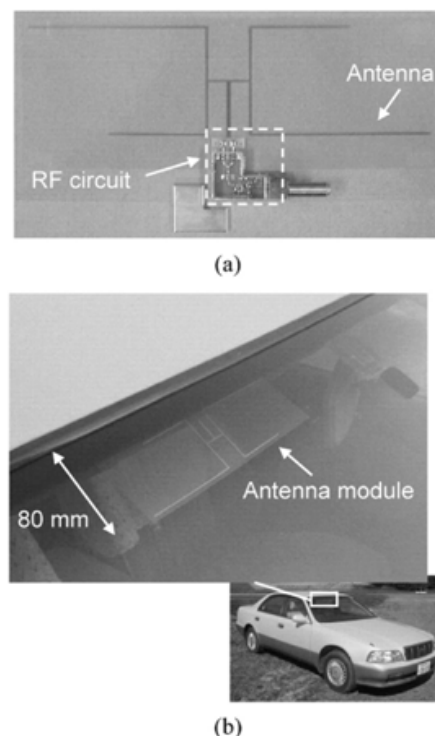

Fig. 12. Digital TV Antenna attached to vehicle glass
© IEEE with permission (Iizuka et al., 2005)

5.4 Circular microstrip patch antenna on glass

Microstrip Patch antennas have many advantages in communication systems including being thin, cheap to produce, and easy to integrate into devices. The application of this kind of antenna to automotive glass has been investigated by several researchers. One paper suggested two methods of patch antenna integration (Economou & Langley, 1998). The first is a patch antenna formed on a traditional microwave substrate such as Rogers RT Duroid® which is then attached to the inside of a vehicle windscreen (Fig. 13(a)). The second describes a more integrated concept which uses a layer of glass itself as the antenna substrate, and excites the patch with a proximity coupled feed line (Fig. 13(b)).

Patch antennas using the first method of integration were designed to resonate near 2 GHz and 6 GHz respectively, and were adhered to a vehicle windscreen for testing. A useful increase in impedance bandwidth from less than 2% to about 7% was observed due to the addition of a thick dielectric superstrate. Presence of the glass also generates surface waves which create undesirable ripples in the far-field radiation pattern.

The second method using glass as the antenna substrate poses fabrication complexities, and would lead to a high windscreen replacement cost in the event of cracking or breakage, so was only investigated by simulation. Simulation results showed that this geometry would also result in lower radiation efficiency due to increased surface wave losses.

The electrical properties of the layers in the windscreen were $\epsilon_{r1} = 6.75$, $\tan \delta = 0.03$ for the glass and $\epsilon_{r2} = 2.9$, $\tan \delta = 0.05$ for the middle plastic layer.

The thickness of automotive glass may vary by up to 15% in the standard manufacturing process. This causes no problems or distortions for driver vision, but could present a problem for patch antennas attached to glass. The centre frequency of the antenna may be shifted by up to 3% and could be coupled with an additional but slight change in the impedance bandwidth.

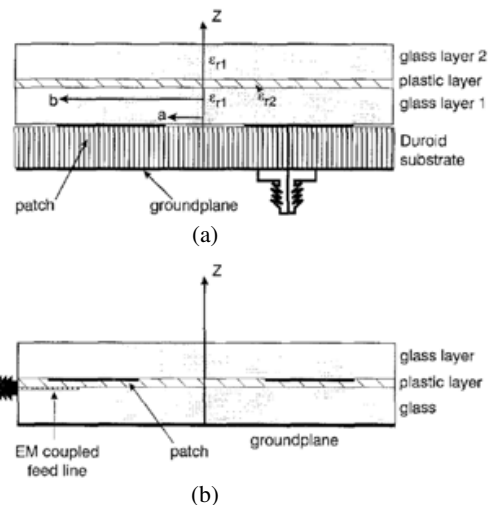

Fig. 13. Patch Antennas on glass © IEEE with permission (Economou & Langley, 1998)

5.5 Rear spoiler with built-in antenna

In the late 1990's a team of Japanese engineers working with Toyota and Aisin Seiki developed a rear spoiler to be mounted up high on the rear of a compact SUV. This spoiler was the first to be fitted with an invisible antenna (Fig. 14). The paper describes a blow molded part made from a polymeric material (Koike et al., 1999). The spoiler is located high

on the vehicle, minimizing shadowing from passing traffic. The antenna is similar to a dipole which would normally require a balanced feed. In order to connect a dipole antenna to a coaxial line, a balun is usually required. The geometry of the spoiler and processing temperature during manufacture would make integration of such a balun difficult. In order to overcome this, an innovative antenna design is used. The shorter element in Fig. 14(a) is approximately $\lambda/4$ long, while the longer element is approximately $\lambda/2$. Parametric investigations found that a tab at the end of the longer radiating element improved antenna performance by coupling to the vehicle's metallic roof. Although the directivity is less than perfect (Fig. 14(b)), it is adequate for the intended application.

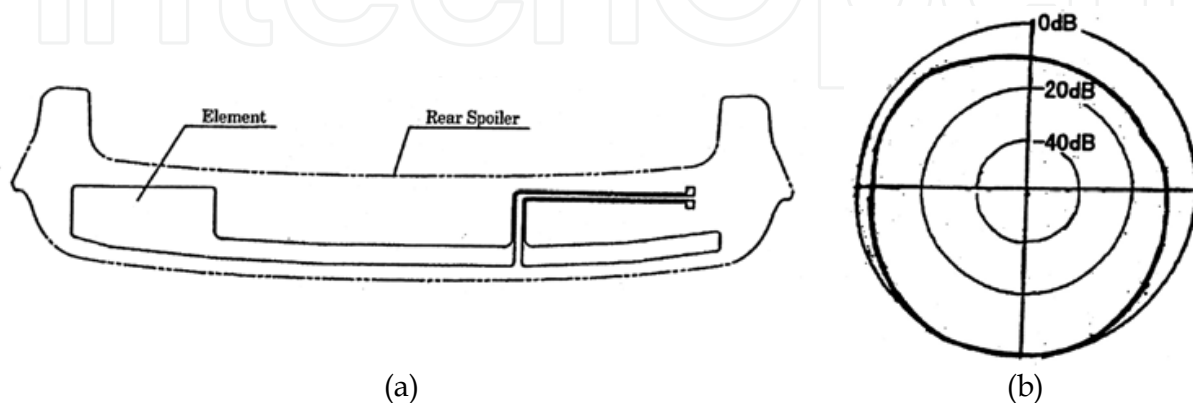

Fig. 14. Integrated antenna in spoiler
© SAE International with permission (Koike et al., 1999)

5.6 Volvo XC90 aperture antenna

Swedish manufacturer Volvo fitted a unique antenna to their XC90 SUV, launched in 2003. The system provides an alternative to glass mounted wire antennas which may be adversely affected by heated windscreen elements and window tinting films containing conductive metallic layers. The XC90 is fitted with a traditional metallic skinned "turret top" roof, but an aperture is created at the rear of the vehicle. This opening is covered with a polymeric panel, and forms an ideal location for some hidden antennas (Low et al., 2006). Fig. 15(a) shows the XC90 from above and Fig. 15(b) shows some simulation results of the vehicle's metallic structure for different antenna configurations. The aperture in the vehicle body is clearly shown. The portion of roof which contains the antennas is the black unpainted section at the rear of the vehicle in Fig. 15(a) which at first glance may look like a sunroof. Seven antenna components (Fig. 16) are formed by printing wire shapes onto a large polyester film using conductive ink. The antennas act as monopole probes, exciting the aperture in which they are placed. For some services, multiple antennas are used in different locations to achieve radiation and polarisation differences between elements allowing diversity reception. The film bearing the printed antennas is attached to a plastic carrier which contains the necessary amplifiers, and the whole unit is located in the aperture and covered with a black polymeric composite material. Examination of Fig. 16 reveals that these antennas are for low frequency services, with Table 1 revealing each service is centred well below 1 GHz. This low frequency implies a long wavelength which requires physically long antenna elements. Note that the services targeted in this design are different from those commonly used in the smaller shark-fin style antennas.



(a) Completed XC90 vehicle

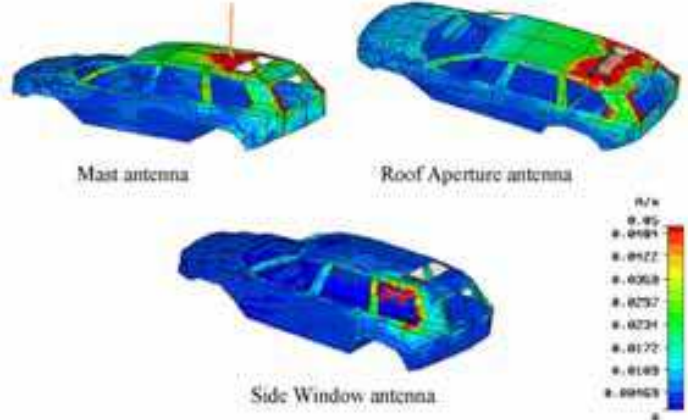

(b) Simulations of surface currents for various antennas

© IEEE with permission (Low et al., 2006)

Fig. 15. Volvo XC90

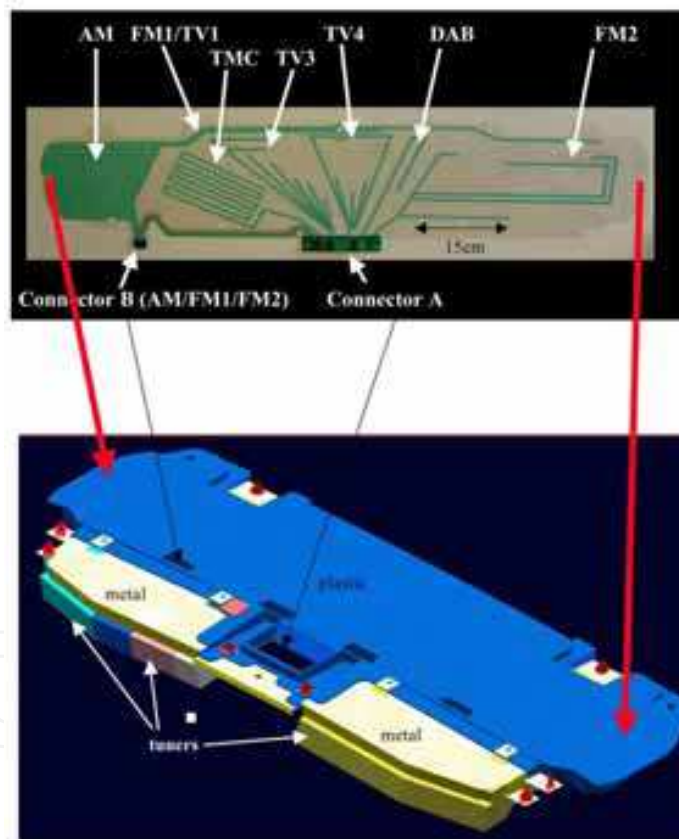

Fig. 16. XC90 antenna configuration. The film from the top image attaches to the carrier in the lower image as shown. © IEEE with permission (Low et al., 2006)

Performance of the roof aperture antenna for the FM band was compared in both simulation and measurement against a roof mounted monopole with a length of 80 cm and a side window antenna as used in an estate car Fig. 15(b). Unsurprisingly, the authors report that the roof mounted monopole provided exceptional performance for vertically polarised signals, but performed poorly for horizontally polarised signals. On average, the roof

mounted aperture antenna performed approximately 2 dB better than the side window antenna, but was unable to trump the roof mounted monopole for vertical polarisation gain.

5.7 Body integrated spiral antenna

Researchers in Germany investigated the possibility of mounting a cavity-backed spiral antenna in the trunk lid of a car (Gschwendtner & Wiesbeck, 2003). The four arm spiral antenna produced is approximately 40cm in diameter and is backed by a metallic cavity (Fig. 17(a)). The spiral supports two modes of radiation depending on how the signal is fed into the structure. The first mode is a coplanar waveguide (CPW) mode which creates a null at zenith (ie. directly above the antenna) with omni-directional radiation around the sides of the device. This mode generates a radiation pattern that is suitable for terrestrial services.

The second mode, known as the coupled slot line (CSL) mode feeds only two of the four arms, creating a circularly polarised radiator with a maximum at zenith (directly overhead). This mode of radiation is ideal for satellite services.

A metallic cavity with a height of 4 cm was placed below the spiral to stop back-radiation into the vehicle body. Measured S-parameters of the antenna with the cavity present are shown in Fig. 17(b). The curve is below -10 dB from 670 MHz to beyond 5 GHz for the terrestrial mode ($|S_{11}|$), with the exception of some peaks as high as -8 dB in the frequencies below 1.4 GHz. These peaks are due to the presence of the metallic cavity. The satellite mode ($|S_{22}|$) meets the -10 dB requirement from 1.3 GHz to 2.2 GHz, providing broadband circularly polarized satellite reception. The $|S_{12}|$ curve illustrates the coupling between the two ports.

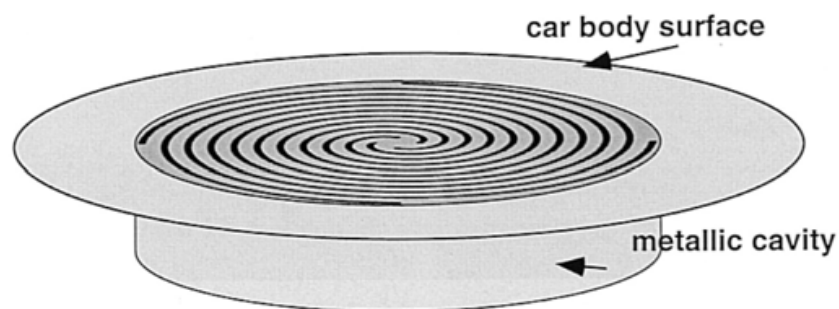

(a) Antenna design showing metallic cavity

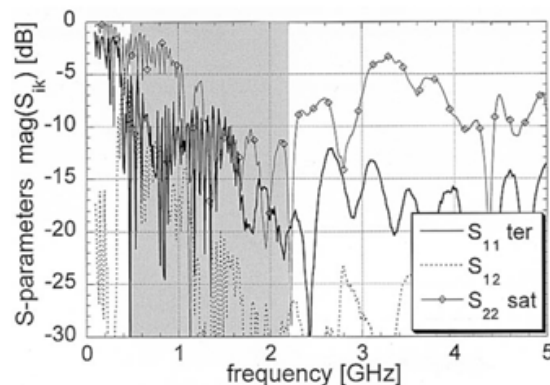

(b) Measured S-parameters of spiral antenna with cavity

Fig. 17. Four arm spiral antenna © IEEE with permission (Gschwendtner & Wiesbeck, 2003)

Fig. 18 shows the finished antenna installed in the intended location on a vehicle. The top surface is mounted flush with the exterior trunk-lid panel. No measurements of the antenna installed in the vehicle were provided. The antenna provides for more multiple services due to its wideband impedance match and results in an elegant solution, given that the structure does not protrude from the vehicle body, eliminating additional drag.

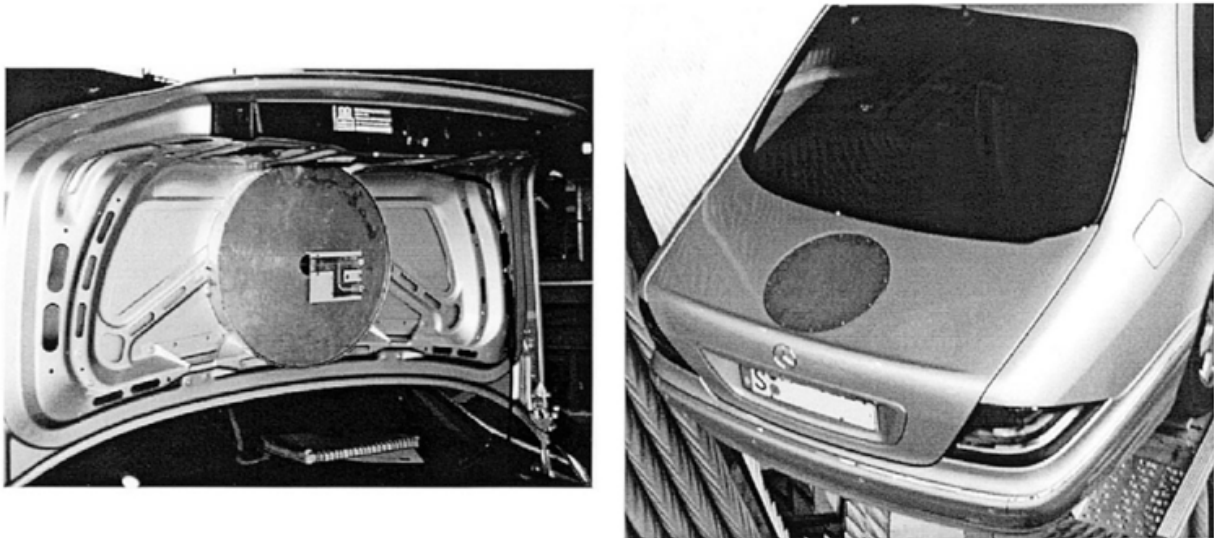

Fig. 18. Spiral antenna integrated into the trunk lid of a Mercedes Sedan
© IEEE with permission (Gschwendtner & Wiesbeck, 2003)

5.8 Planar Inverted Cone Antenna (PICA)

The PICA is a low profile antenna (Fig. 19) with a very wideband impedance match (Pell et al., 2009). In its intended application in a vehicle it would be encapsulated in or mounted under a polymeric panel in a manner similar to the Volvo XC90 antenna. This may be achieved if the electrical properties of the material are known (Sulic et al., 2007). However, rather than leaving the polymeric panel black, the covering panel could be painted to match the colour of the vehicle so that the assembled structure becomes a colour co-ordinated component which is indistinguishable from a section of bonnet, roof or trunk.

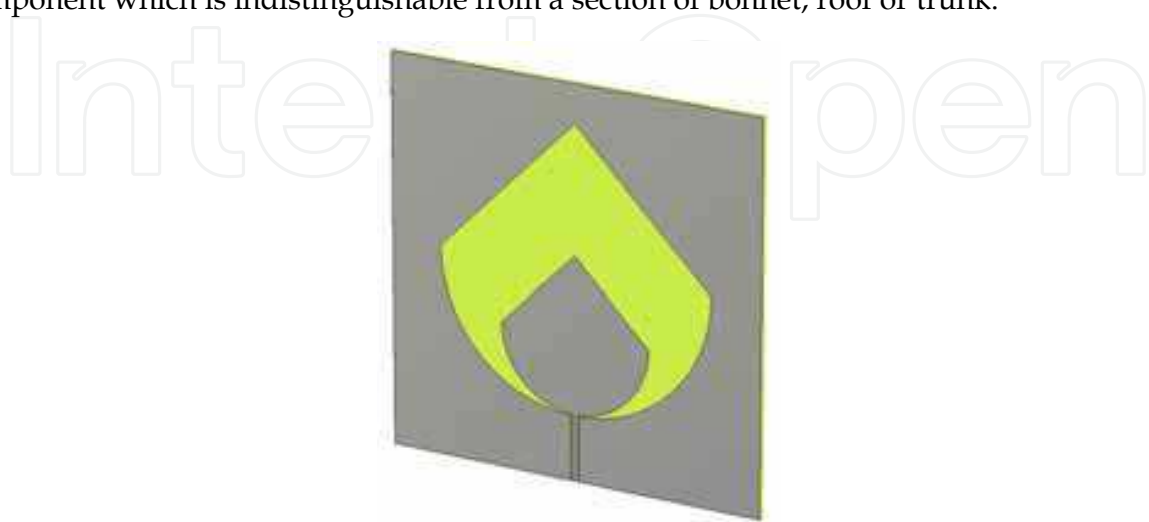

Fig. 19. Planar Inverted Cone Antenna

The use of a wideband antenna is similar in concept to that used by Gschwendtner and Wiesbeck in the previously examined spiral antenna. Due to its wide impedance bandwidth, a single antenna can cover more than one service if appropriate interfacing hardware is provided. In contrast to the cavity-backed spiral antenna, the PICA provides a wider impedance bandwidth and is fabricated on industry standard circuit board material (FR-4), making series production affordable. It requires no cavity, giving a thinner overall structure, and may be attached to the underside of surfaces which feature a gentle curve, making it a truly conformal solution.

Being fabricated on a square 20 cm x 20 cm substrate, the enlarged uniplanar CPW-fed PICA provides a suitable antenna for many of the services in Table 1. It presents a good impedance match to a 50 ohm line over a wide range of frequencies extending from 730 MHz to beyond 10 GHz (Fig. 20).

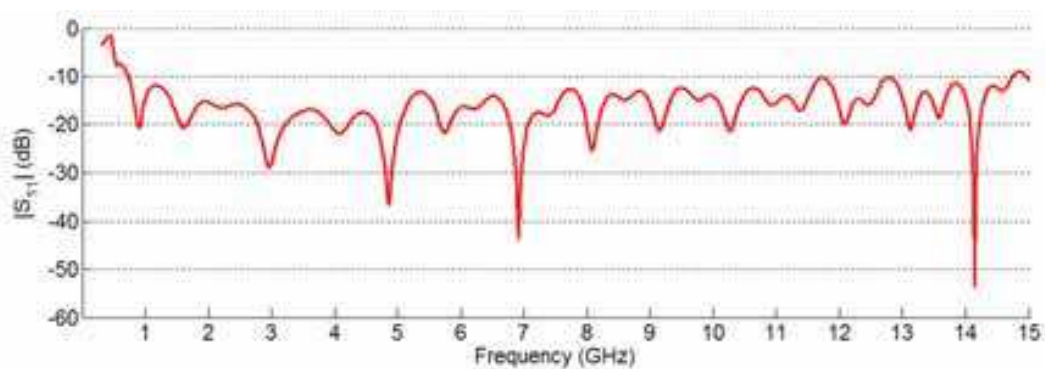

Fig. 20. Simulated impedance response of the Large PICA antenna

In the case where an antenna such as the PICA may be encapsulated in the middle of a dielectric material, it may experience deformation due to the pressure and flow of material during the moulding process. This requires a thorough understanding of the rheology of the material to be used (Sulic et al., 2010). An understanding of the properties of the polymer may influence the temperature at which the material is cured during manufacturing, and will impact on the way the charge is loaded into the tool in preparation for moulding.

The radiation pattern of the antenna in free space changes across the frequency band in a manner convenient for the application. At each frequency the level of gain in the required direction is suitable for vehicular use when mounted in a horizontal attitude, as would be the case in a bonnet, roof or trunk lid. Fig. 21 shows the simulated radiation pattern of the antenna at key frequencies in the band. Where possible, these frequencies were selected to align with an automotive service.

At cellular phone frequencies (Fig. 21(a)) the pattern is wide with low directivity. The peak gain occurs at broadside to the antenna substrate, yet in the plane of the substrate (x-y plane) the gain averages about 0 dBi with a null in the y direction. Given that cellular phone towers are terrestrially based, it is this horizontal part of the radiation pattern which is critical, and the gain is adequate.

Fig. 21(b) shows the radiation pattern at the frequency used for GPS. The radiation pattern has become slightly more directed, with a realised gain of 5.7 dBi. Despite the lack of circular polarisation, the radiation performance of the PICA should provide a satisfactory signal to a modern receiver unit like the SiRFStarIII™ to enable accurate positioning. Verification of this assumption is a matter of present investigation.

At 5.9 GHz (Fig. 21(d)) the radiation pattern of the PICA is dominated by the currents formed along the tapered slot between the two PICA shapes. This leads to high gain y-directed lobes encroaching upon endfire. This is suitable for vehicle-to-vehicle applications where signals should be directed close to the horizon to communicate with nearby automobiles and roadside infrastructure.

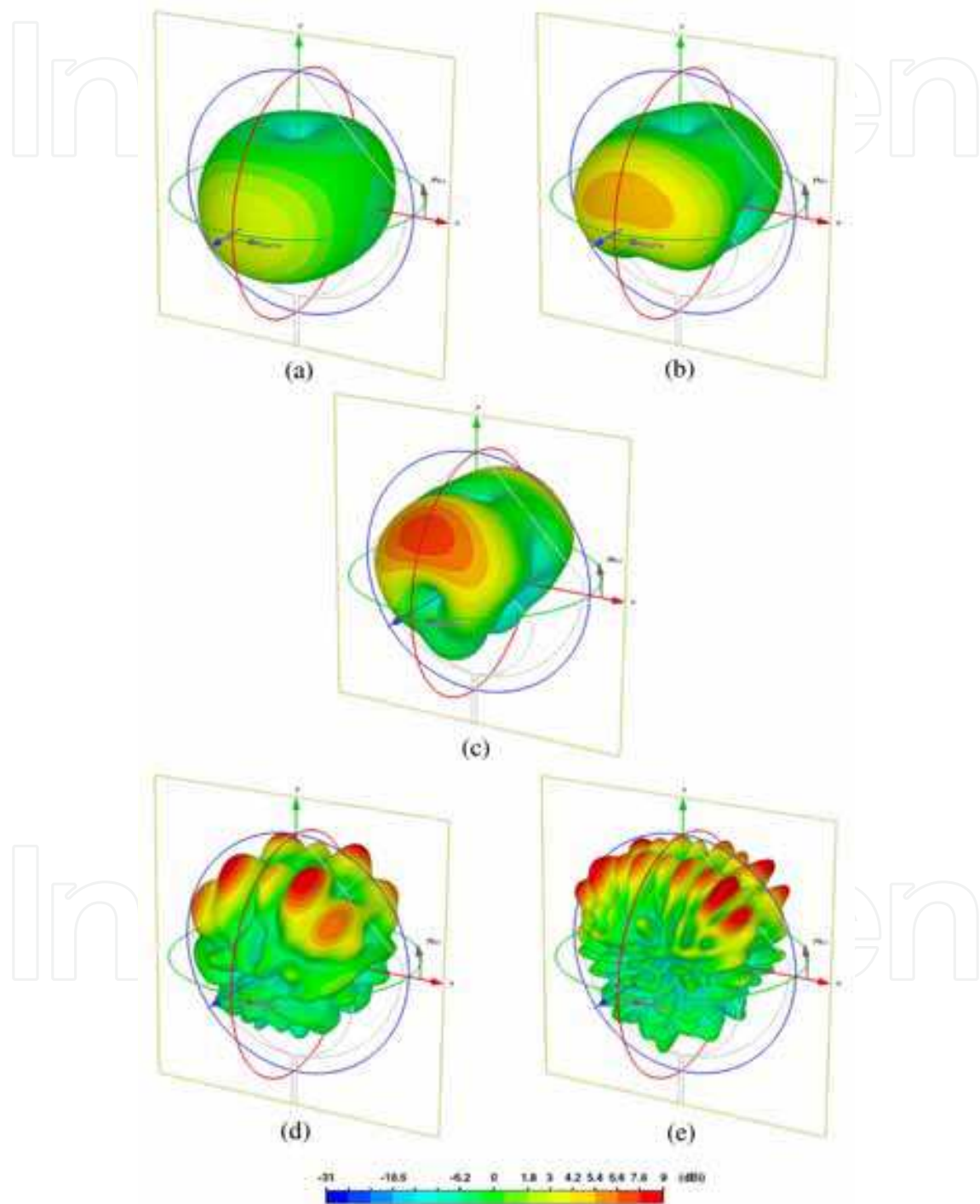

Fig. 21. Simulated 3D radiation patterns of the enlarged uniplanar CPW fed PICA. (a) 850 MHz, Max gain is 3.9 dBi (b) 1.575 GHz, Max gain is 5.7 dBi (c) 2.4 GHz, Max gain is 8.1 dBi (d) 5.9 GHz, Max gain is 9.6 dBi (e) 9.5 GHz, Max gain is 11 dBi

5.9 Antennas integrated into Plastic Trunk Lid

Heinz Lindenmeier and his team at the University of the Bundeswehr Munich have made an outstanding contribution to vehicular antennas over many decades, particularly with regards to amplifiers and diversity systems. Lindenmeier and his team presented an antenna concept for application in cars with plastic trunk lids (Lindenmeier et al., 2006) as is common in some cabriolets and convertibles. In such vehicles a traditional fixed glass rear window is not normally available, so integration into the plastic trunk lid is an ideal substitute.

In order to create an antenna a copper ring is created around the perimeter of the plastic trunk lid near the metallic supporting structure (Fig. 22). Two switches are inserted into this ring, and act to control the impedance of the network. Both ends of the ring are connected to an amplifier unit which is used to obtain both FM-diversity and TV reception.

A separate AM radio feed is connected to a wire antenna geometry which is located inside the previously mentioned ring. A ground plane is also included in the middle of the ring. The intention is that a cellular phone antenna, or GPS patch antenna may be installed to this location under the polymeric trunk lid. This would provide an ideal spot to locate antennas for higher frequency services and would not disrupt the operation of the lower frequency services.

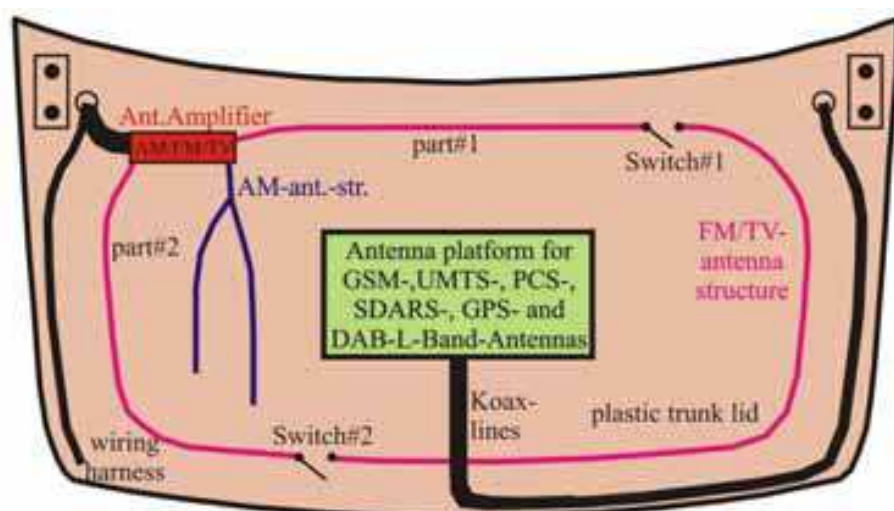

Fig. 22. Active antennas integrated into Plastic Trunk Lid
© SAE International with permission (Lindenmeier et al., 2006)

5.10 Other automotive antenna configurations

Satellite Antennas

Several designs exist for reception of Ku-band satellite signals on either moving or stationary vehicles. High gains of 30 dBi or higher are required, leading to the use of reflector antennas (Eom et al., 2007) or array antennas (Mousavi et al., 2008). Reflector antennas are often mechanically steered and housed in a radome which results in a high profile device approaching half a meter in depth (Fig. 23(a)). Array antennas use a collection of many patch antennas and typically result in roof mounted components with a lower profile, thinner than even 10 cm (Fig. 23(b)). These systems may be steered mechanically with motors, or electronically by changing the phase between elements.

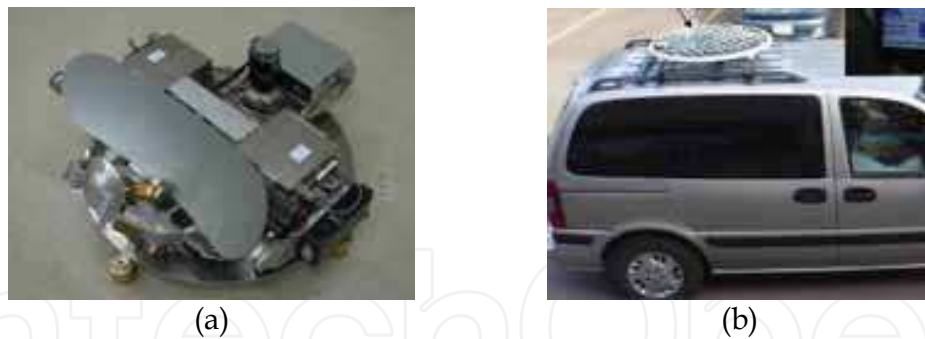

Fig. 23. (a) Satellite reflector system © IEEE with permission (Eom et al., 2007), (b) Satellite phased array system © IEEE with permission (Mousavi et al., 2008)

Collision Avoidance Radar

Antennas designed to work as part of a collision avoidance radar system are very small because of the high frequencies of operation (typically 24 GHz or 77 GHz) which leads to a correspondingly short wavelength, and small antenna size. 77 GHz is preferred for *Long Range Radar* detection, up to 150 m in front of the vehicle, while 24 GHz systems are used for *Short Range Radar* where the distance is less than 30 m. Many requirements need to be satisfied in designing such antennas (Hoare & Hill, 2000). Fig. 24 shows some recently presented antennas for these purposes. Fig. 24(a) and (c) show antennas for 77 GHz radar systems published in the literature, while Fig. 24(b) shows a commercial system used by Mercedes.

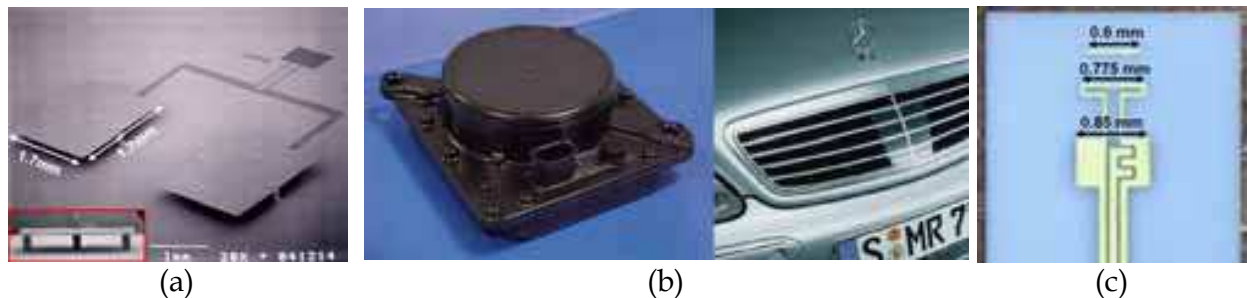

Fig. 24. Automotive Radar antenna configurations (a) a fabricated 2x1 77 GHz Patch array © IEEE with permission (Lee et al., 2005) (b) the Mercedes Long Range Radar System © IEEE with permission (Wenger, 2005) (c) a 77 GHz Yagi-Uda antenna used to feed a reflector © IEEE with permission (Beer et al., 2009)

6. The effect of automotive paints on vehicular antennas

The effect of automotive paints on vehicular antennas was recently studied in depth (Pell et al., n.d.). Two different paint families were investigated including a traditional polyurethane chemistry and the modern water-based paints which are gaining increased use because of their environmental benefits. Both metallic and non-metallic varieties of the paints were investigated.

Metallic paints present an interesting scenario for antenna applications. Such paints create a shimmering visual effect by the inclusion of thousands of small flakes of aluminium in the paint (Fig. 25), yet these flakes are inherently conductive. It seems reasonable that the presence of these conductive flakes in the near-field of an antenna may potentially cause severe disruption to proper antenna operation.

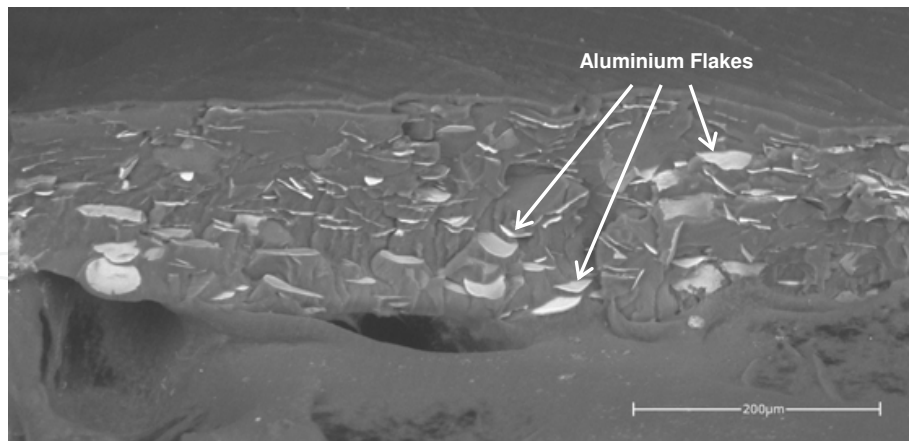

Fig. 25. Scanning Electron Microscope image of the edge of a section of paint

The authors report that the presence of automotive paints has potential to bring about a shift in the resonant frequency of an antenna due to the addition of dielectric material. This effect is more pronounced on narrowband antennas.

Metallic particles in the paint are very small compared to a wavelength at the frequencies of interest. The free electrons in the aluminium flakes are not truly free to move since they are isolated in the paint binder. This prevents a true shielding effect as in the case of a continuous conductor. A slight gain reduction may be observed when paints containing metallic particles are applied to antennas.

Electrostatic primers were also investigated in this work. Such coatings are intended to provide a level of DC conductivity to enable electrostatic painting of polymeric parts, which results in a high yield with less overspray, and hence a more efficient painting process with lower levels of paint wastage. It was found that these coatings were lossy at microwave frequencies (due to their DC conductivity), bringing about a gain reduction of approximately 1.5 dB on a narrowband patch antenna. This implies that for any polymeric panels containing antennas, the structure should be painted offline, or in a manner not requiring application of an electrostatic primer.

7. Conclusion

Automotive antennas have seen significant advancements in recent years. No longer is a large protruding fender mounted mast antenna the norm for production vehicles. As seen from the antenna configurations mentioned here, a good impedance match can be obtained for a wide frequency range. Also, depending on the frequency range being targeted, it is possible to achieve acceptable gains and directivities. These developments augur well for the deployment of a new range and type of integrated vehicular antennas. Future developments will likely focus on two key areas: further integration of the antenna components with the vehicle structure, and new antenna configurations for radar and vehicle-to-vehicle communication services. With the developments in antenna design mentioned in this chapter, further integration of antennas within vehicular components will be expected, particularly with the present inexorable drive from within the automotive industry, to shift more automotive components from metallic to polymeric materials.

8. Acknowledgement

The authors wish to acknowledge other members of the research group, Kefei Zhang and Rahul Gupta. Brendan D. Pell thanks Hao V. Nguyen for sharing his knowledge and experience.

9. References

- Beer, S., Adamiuk, G. & Zwick, T. (2009) Novel Antenna Concept for Compact Millimeter-Wave Automotive Radar Sensors. *Antennas and Wireless Propagation Letters, IEEE*, 8, pp.771-774.
- Bogdanov, F., Karkashadze, D., Jobava, R., Gheonjian, A., Yavolovskaya, E., Bondarenko, N. & Ullrich, C. (2010) Validation of Hybrid MoM Scheme With Included Equivalent Glass Antenna Model for Handling Automotive EMC Problems. *IEEE Transactions on Electromagnetic Compatibility*, 52 (1), pp.164-172.
- Cerretelli, M. & Biffi Gentili, G. (2007) Progress in Compact Multifunction Automotive Antennas. In: *International Conference on Electromagnetics in Advanced Applications*. pp.93-96.
- Economou, L. & Langley, J. (1998) Circular microstrip patch antennas on glass for vehicle applications. *IEE Proceedings Microwaves, Antennas and Propagation*, 145 (5), pp.416-420.
- Eom, S.Y., Son, S.H., Jung, Y.B., Jeon, S.I., Ganin, S., Shubov, A., Tobolev, A. & Shishlov, A. (2007) Design and Test of a Mobile Antenna System With Tri-Band Operation for Broadband Satellite Communications and DBS Reception. *IEEE Transactions on Antennas and Propagation*, 55 (11), pp.3123-3133.
- Gottwald, G. (1998) Numerical Analysis of Integrated Glass Antenna Systems. In: *SAE Technical Paper Series*. Paper ID 982386, Society of Automotive Engineers.
- Gschwendtner, E. & Wiesbeck, W. (2003) Ultra-broadband car antennas for communications and navigation applications. *IEEE Transactions on Antennas and Propagation*, 51 (8), pp.2020-2027.
- Hoare, E. & Hill, R. (2000) System requirements for automotive radar antennas. In: *IEE Colloquium on Antennas for Automotives*. pp.1/1-111.
- Hopf, J., Reiter, L. & Lindenmeier, S. (2007) Compact multi-antenna system for cars with electrically invisible phone antennas for SDARS frequencies. In: *2nd International ITG Conference on Antennas, 2007. INICA '07*. pp.171-175.
- IEEE Std 145-1993 (1993) IEEE Standard Definitions of Terms for Antennas. [Internet]. Available from: <10.1109/IEEESTD.1993.119664>.
- Iizuka, H., Watanabe, T., Sato, K. & Nishikawa, K. (2005) Modified H-Shaped Antenna for Automotive Digital Terrestrial Reception. *IEEE Transactions on Antennas and Propagation*, 53 (8), pp.2542-2548.
- Jensen, W.K. (1971) Concealed Windshield Broadband Antenna, U.S. Pat. 3,576,576.
- Koike, T., Hase, N., Koide, E., Murakami, Y., Izawa, S., Ohira, T., Nagasaka, O., Tanaka, Y. & Suzuki, T. (1999) Development of a Rear Spoiler with Built-in Antenna. In: *SAE Technical Paper Series*. Paper ID 1999-01-0807, Society of Automotive Engineers.
- Lee, H.S., Jeong-Geun Kim, Songcheol Hong & Jun-Bo Yoon (2005) Micromachined CPW-fed suspended patch antenna for 77 GHz automotive radar applications. In: *The*

- European Conference on Wireless Technology, 2005*. pp.249-252. Available from: <10.1109/ECWT.2005.1617704>.
- Lindenmeier, H., Reiter, L., Ramadan, A., Hopf, J. & Lindenmeier, S. (2006) A New Design Principle of Active Receiving Antennas Applied with a High Impedance Amplifier-Diversity-Module in a Compact Multi-Band-Antenna-System on a Plastic Trunk Lid. In: *SAE Technical Paper Series*. Paper ID 2006-01-0480, Society of Automotive Engineers.
- Low, L., Langley, R., Breden, R. & Callaghan, P. (2006) Hidden Automotive Antenna Performance and Simulation. *IEEE Transactions on Antennas and Propagation*, 54 (12), pp.3707-3712.
- Mousavi, P., Fakharzadeh, M., Jamali, S., Narimani, K., Hossu, M., Bolandhemmat, H., Rafi, G. & Safavi-Naeini, S. (2008) A Low-Cost Ultra Low Profile Phased Array System for Mobile Satellite Reception Using Zero-Knowledge Beamforming Algorithm. *IEEE Transactions on Antennas and Propagation*, 56 (12), pp.3667-3679.
- Okada, Y., Tanaka, H. & Yamane, K. (2007) Electromagnetic Field Analysis for Smart Key Antenna. In: *SAE Technical Paper Series*. Paper ID 2007-01-0943, Society of Automotive Engineers.
- Pell, B.D., Sulic, E., Rowe, W.S.T. & Ghorbani, K. (2009) Custom-directional wideband PICA for multi-service vehicular applications. In: *APMC 2009. Asia Pacific Microwave Conference, 2009*. pp.1863-1866.
- Pell, B.D., Sulic, E., Rowe, W.S.T., Ghorbani, K. & John, S. Experimental Study of the Effect of Modern Automotive Paints on Vehicular Antennas. *Accepted (August 2010) for publication in IEEE Transactions on Antennas and Propagation*.
- Rowan, C.W. & Altgelt, C.A. (1985) When car radios were illegal: A history of early American and European car radios. In: *SAE Technical Paper Series*. Paper ID 850019, Society of Automotive Engineers.
- Sulic, E., Pell, B., John, S., Gupta, R., Rowe, W., Ghorbani, K., Zhang, K. & Lewis, M. (2007) Parametric Evaluation of Communication Devices in Smart Composite Structures. In: *Proceedings of the 5th Australasian Congress on Applied Mechanics (ACAM)*. Brisbane, Australia, Engineers Australia, pp.477-482.
- Sulic, E., Pell, B., John, S., Gupta, R., Rowe, W., Ghorbani, K. & Zhang, K. (2010) Deformation Evaluation of Embedded Antennas in Vehicular Components. In: *Proceedings of the World Congress of Engineering 2010*. London, UK, pp.2389-2394.
- Toriyama, H., Ohe, J., Kondo, H. & Yotsuya, H. (1987) Development of printed-on glass TV antenna system for car. In: *37th IEEE Vehicular Technology Conference, 1987*. pp.334-342.
- Waterhouse, R. (2008) *Printed Antennas for Wireless Communications*. Wiley. p30.
- Wenger, J. (2005) Automotive radar - status and perspectives. In: *IEEE Compound Semiconductor Integrated Circuit Symposium, 2005. CSIC '05*. p.4 pp. Available from: <10.1109/CSICS.2005.1531741>.

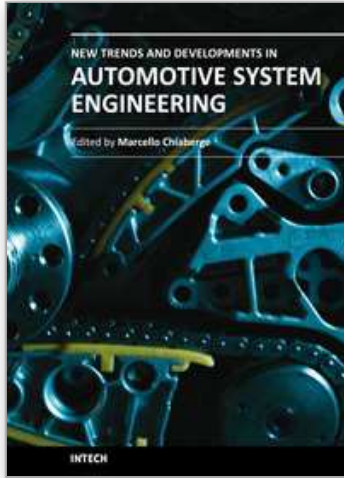

New Trends and Developments in Automotive System Engineering

Edited by Prof. Marcello Chiaberge

ISBN 978-953-307-517-4

Hard cover, 664 pages

Publisher InTech

Published online 08, January, 2011

Published in print edition January, 2011

In the last few years the automobile design process is required to become more responsible and responsibly related to environmental needs. Basing the automotive design not only on the appearance, the visual appearance of the vehicle needs to be thought together and deeply integrated with the “power” developed by the engine. The purpose of this book is to try to present the new technologies development scenario, and not to give any indication about the direction that should be given to the research in this complex and multi-disciplinary challenging field.

How to reference

In order to correctly reference this scholarly work, feel free to copy and paste the following:

Brendan D. Pell, Edin Sulic, Wayne S. T. Rowe, Kamran Ghorbani and Sabu John (2011). Advancements in Automotive Antennas, New Trends and Developments in Automotive System Engineering, Prof. Marcello Chiaberge (Ed.), ISBN: 978-953-307-517-4, InTech, Available from: <http://www.intechopen.com/books/new-trends-and-developments-in-automotive-system-engineering/advancements-in-automotive-antennas>

INTECH
open science | open minds

InTech Europe

University Campus STeP Ri
Slavka Krautzeka 83/A
51000 Rijeka, Croatia
Phone: +385 (51) 770 447
Fax: +385 (51) 686 166
www.intechopen.com

InTech China

Unit 405, Office Block, Hotel Equatorial Shanghai
No.65, Yan An Road (West), Shanghai, 200040, China
中国上海市延安西路65号上海国际贵都大饭店办公楼405单元
Phone: +86-21-62489820
Fax: +86-21-62489821

© 2011 The Author(s). Licensee IntechOpen. This chapter is distributed under the terms of the [Creative Commons Attribution-NonCommercial-ShareAlike-3.0 License](#), which permits use, distribution and reproduction for non-commercial purposes, provided the original is properly cited and derivative works building on this content are distributed under the same license.

IntechOpen

IntechOpen