

# We are IntechOpen, the world's leading publisher of Open Access books Built by scientists, for scientists

4,800

Open access books available

122,000

International authors and editors

135M

Downloads

Our authors are among the

154

Countries delivered to

TOP 1%

most cited scientists

12.2%

Contributors from top 500 universities



WEB OF SCIENCE™

Selection of our books indexed in the Book Citation Index  
in Web of Science™ Core Collection (BKCI)

Interested in publishing with us?  
Contact [book.department@intechopen.com](mailto:book.department@intechopen.com)

Numbers displayed above are based on latest data collected.  
For more information visit [www.intechopen.com](http://www.intechopen.com)



# Multidimensional Chromatography in Pesticides Analysis

Tomasz Tuzimski  
*Medical University of Lublin  
Poland*

## 1. Introduction

The agricultural production of food and feed on an economically competitive basis needs an ever-increasing application of pesticides. Pesticide is a general term that includes variety of chemical and biological products to kill or control pests such as fungi, insects, rodents and weeds. In the European Union (EU) approximately 320,000 tonnes of active substances are sold every year, which accounts for one quarter of the world market (The Pesticides Safety Directorate, York, United Kingdom). Residues in fruit and vegetables, cereals, processed baby food and foodstuffs of animal origin are controlled through a system of statutory maximum residue limits (MRLs). The maximum residue limits (MRLs) are defined as: 'The maximum concentration of pesticide residue (expressed as milligrams of residue per kilogram of commodity (mg/kg)) likely to occur in or on food commodities and animal feeds after the use of pesticides according to good agricultural practice (GAP)' (Proposed PAHO/WHO Plan of Action for Technical Cooperation in Food Safety, 2006–2007). MRLs vary ordinarily within the interval 0.0008–50 mg/kg (The Applicant Guide: Maximum Residue Levels, The Pesticides Safety Directorate, York, United Kingdom), typically between 0.01 and 10 mg/kg for adult population. The lower values of MRLs are set for baby food – EC specified the MRL of 0.010 mg/kg (Pesticides and the Environment, A Strategy for the Sustainable Use of Plant Protection Products and Strategy Action Plans, London, United Kingdom), the lowest levels are set for particular special residues (Status of active substances under EU review (doc. 3010); Commission Directive 2003/13 and 14/; Council Directive 98/83/).

The most efficient approach to pesticide analysis involves the use of chromatographic methods. Sometimes, the resolving power attainable with a single chromatographic system is still insufficient for the analysis of complex mixtures. The coupling of chromatographic techniques is clearly attractive for the analysis of multicomponent mixtures of pesticides. Truly comprehensive two-dimensional (2D) hyphenation is generally achieved by frequent sampling from the first column into the second, which is a very rapid analysis. In this study are presented different modes of multidimensional chromatographic separation techniques including multidimensional gas chromatography (MDGC), multidimensional liquid chromatography (MDLC) and multidimensional planar chromatography (MDPC) applied to analysis of pesticides.

## 2. Mutidimensional chromatographic techniques applied to analysis of pesticides

### 2.1 Mutidimensional Gas Chromatography (MDGC)

The application of multidimensional gas chromatography has been focused in essentially two areas: (i) increasing peak capacity of the separation system, and (ii) increasing the speed of analysis of the separation system. In common with all multidimensional separations, two-dimensional GC requires that the target analytes are subjected to two or more mutually independent separation steps and that the compounds remain separated until completion of the overall procedure. **Figure 1** shows several potential on-line modes of two-dimensional GC operation. These couplings demonstrate GC-GC performed by using a single heart-cut from the primary to the secondary column, multiple heart-cuts, transferred to multiple intermediate traps, and heart-cuts to a multiple parallel secondary column configuration (Lewis, 2002). For all three of the examples of two-dimensional gas chromatography configurations shown in **Figure 1**, an interfacing unit is required between the primary and secondary column.

#### 2.1.1 Introduction to heart-cutting Mutidimensional Gas Chromatography (MDGC)

The non-intrusive manipulation of carrier gas effluent between two columns clearly has significant advantages in 2D GC. In addition, a pressure-driven switch between the columns introduces no extra band broadening to an eluting peak. A basic principle of pressure switching which has subsequently been used extensively for heart-cutting, venting and backflushing within two-dimensional systems was described by Deans (Deans, 1968). In this process are highlighted three distinct phases, i.e., that of survey of prefractionation, sample transfer and backflush of the primary column (Bertsch, 1990). The principle of operation is shown in **Figure 2**. The basis of the method is in the diversion of flows by using pressure balancing at junctions. The flow of carrier gas to each junction is controlled by solenoid valves, with the magnitude of pressure introduced being determined by the inlet and outlet pressures of the interacting devices and their individual flow resistances (Lewis, 2002).

There are three phases in the operation of DEANS switch (Lewis, 2002):

- a. Prefractionation-operation in the SURVEY position illustrated in **Figure 2** results in a balance of pressure such that flow from the primary column is diverted at the junction between the columns (marked 'A') towards Detector 1. This set of pressures prevents the sample entering the second column, but does provide the carrier gas for the second column. This is supplied as excess pressure at the junction A.
- b. Sample transfer - The second pressure configuration results in both columns being coupled in a sequential manner. A minor portion of the primary eluent is split at junction A to go to Detector 1, with the majority passing directly on to the secondary column.
- c. Analysis of fraction-once the sample transfer is complete, the third pressure configuration is adopted. The carrier gas flow through the secondary column is maintained by excess pressure at junction A, supplied from regulator B. Concurrently, the primary column is backflushed by also using the pressure supplied from regulator B.

Following the backflush of the primary column and separation of the analytes on the second column, the system can then be returned to its original prefractionation position, ready for the next sample injection (Lewis, 2002). The most intriguing developments in GC include comprehensive new designs for two-dimensional gas chromatography (GC x GC) and

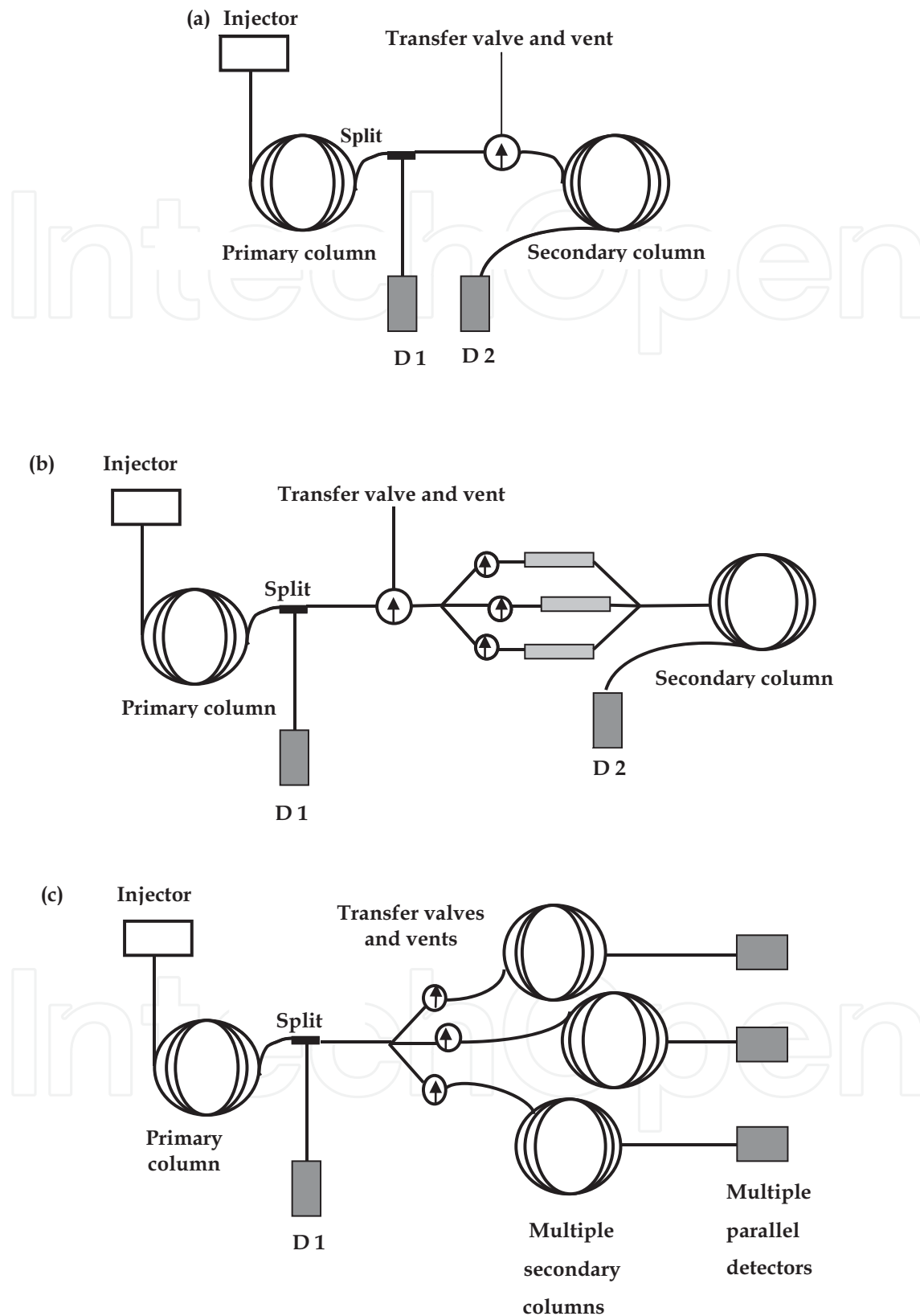

Fig. 1. Two-dimensional gas chromatography instrumental configurations: (a) direct transfer heart-cut configuration; (b) multiple parallel trap configuration; (c) multiple parallel column configuration; D 1 - first detector; D 2 - second detector (adapted from Lewis, 2002).

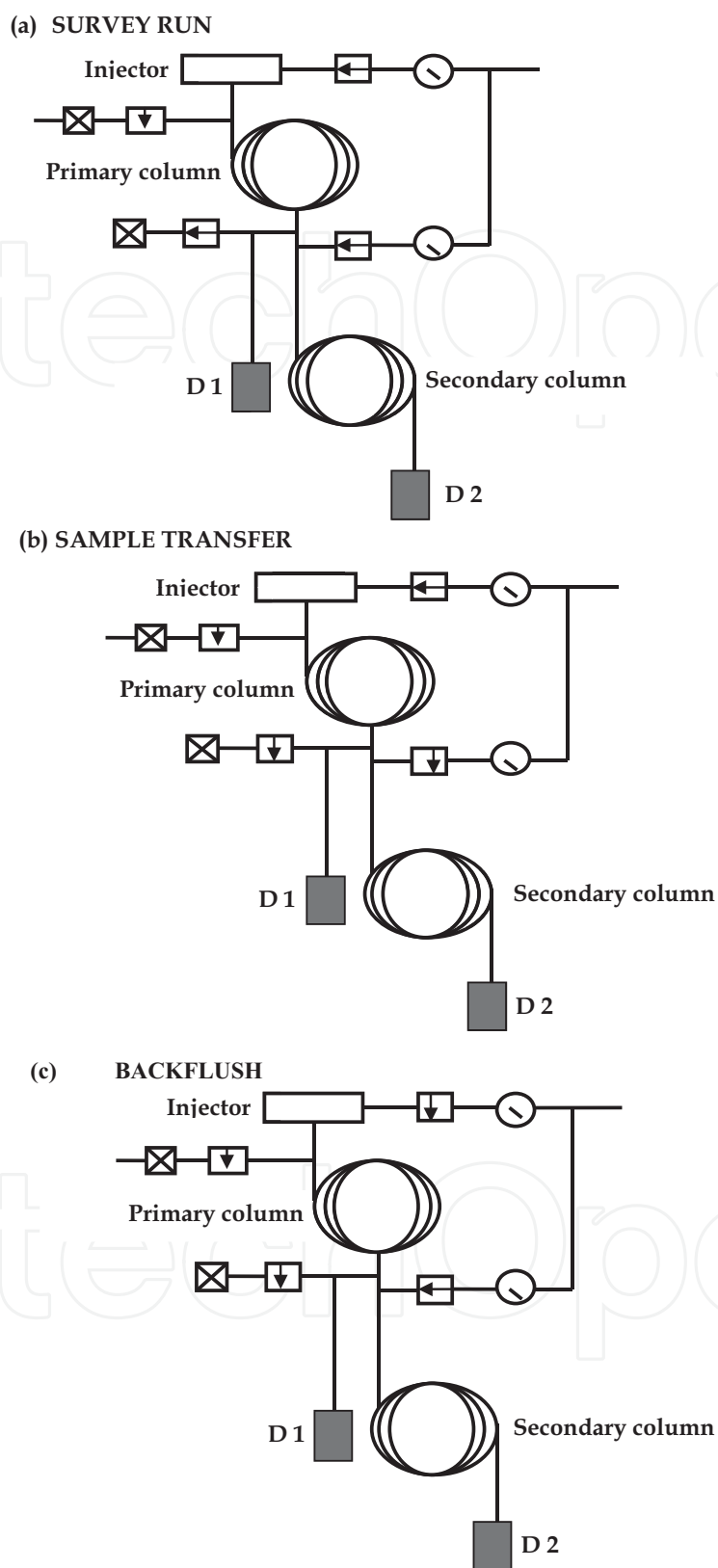





Fig. 2. Survey, sample transfer and backflush positions used during the non-intrusive DEANS heart-cut switching process;  - Carrier pressure regulation;  - On/off valve;  - Needle valve (adapted from Bertsch, 1990).

fluidic switching (DEANS switching) for multidimensional separations. Improvements in electronic pressure and flow control in modern GC instruments and the development of miniature and inert devices for column connections have greatly improved the performance and reliability of these techniques which has created new applications for these powerful techniques.

### 2.1.2 Heart-cutting Multidimensional Gas Chromatography (MDGC)

The heart-cutting multidimensional gas chromatography (MDGC) to determination of the enantiomeric fractions of *o,p'*-DDT was described (Muñoz-Arnanz et al., 2009). The MDGC system employed throughout consisted of two independent GC chromatographs, both equipped with a  $^{63}\text{Ni}$ -ECD system. The two chromatographs were designated as the first and the second dimension chromatographs, referred to as the 1D and 2D chromatographs, respectively. The heart-cutting MDGC configuration used in the paper cited is shown in **Figure 3**.

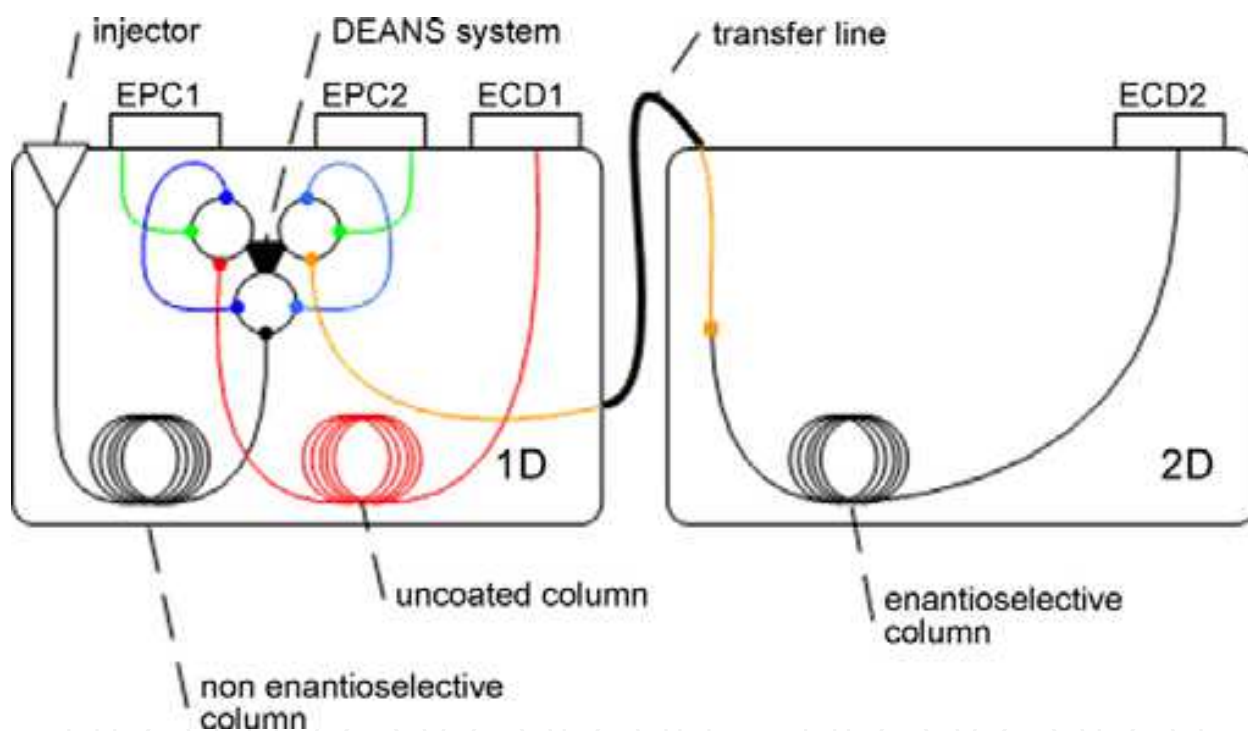

Fig. 3. Schematic diagram of the MDGC system used. Note the presence of the deactivated and uncoated fused silica capillary columns, which permits a total length from the injector to the detector in the 1D chromatograph equal to the distance that the analytes have to cover between the injector and the 2D ECD system (From Muñoz-Arnanz et al., 2009. With permission.).

Cuts or selected fractions were transferred from the first dimension column to the second using a system (DEANS), located in the 1D chromatographic oven, that was pneumatically controlled by means of two independent electronic pressure control (EPC) units. A temperature-controlled transfer line was directly connected to the DEANS switching system using press-fit connection. The instrumental LOD and LOQ were  $2.1 \text{ pg } \mu\text{L}^{-1}$  and  $7.1 \text{ pg } \mu\text{L}^{-1}$ , respectively for *o,p'*-DDT.

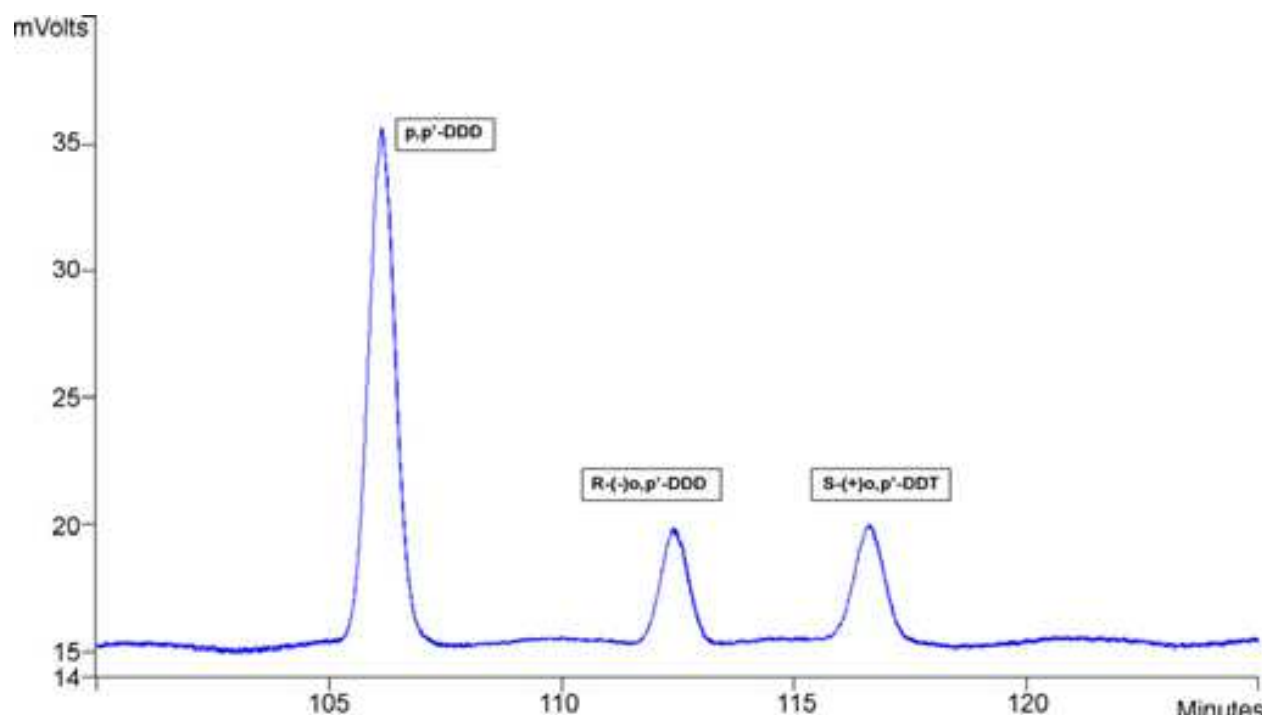

Fig. 4. Second dimension chromatogram showing the separation between  $p,p'$ -DDD and the two  $o,p'$ -DDT enantiomers (From Muñoz-Arnanz et al., 2009. With permission.).

As shown in **Figure 4**, a good separation between  $p,p'$ -DDT and both  $o,p'$ -DDT enantiomers was achieved. The 1D and 2D chromatograms obtained in the analysis of one soil sample are shown in **Figure 5**. The described MDGC method is reliable for determination of organochlorine pesticides in soil samples.

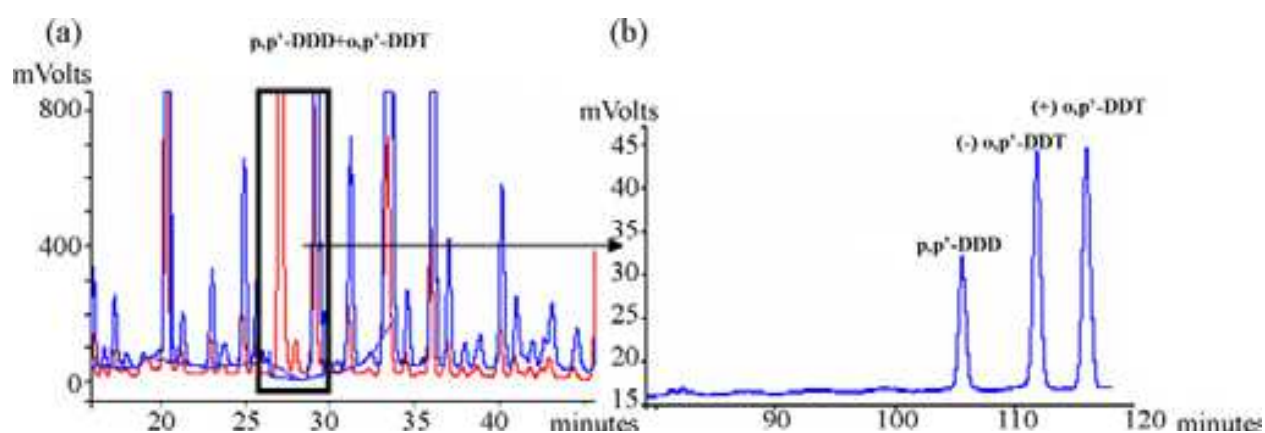

Fig. 5. (a) First dimension chromatogram showing the trace of the organohalogen compounds in a soil sample. Note the cut carried out between minutes 27 and 29. (b) Second dimension chromatogram showing the separation of the  $o,p'$ -DDT enantiomers from the rest of the species transferred in the same cut to the 2D system. (From Muñoz-Arnanz et al., 2009. With permission.).

### 2.1.3 Introduction to GC x GC separation

Single-column gas chromatography analysis has become the standard approach for measurement of volatile and semi-volatile constituents in numerous applications. However

the separation provided by conventional gas chromatography can be significantly enhanced by using comprehensive two-dimensional gas chromatography (GC x GC) instead. The comprehensive GC x GC technique was introduced by Phillips and co-workers (Liu and Phillips, 1991; Phillips and Xu, 1995; Phillips and Ledford, 1996). GC x GC technique have been reviewed (Geus et al., 1996; Bertsch, 1999, 2000; Phillips and Beens, 1999; Dallüge et al., 2003). Some fundamental and detailed information are included in book entitled 'Multidimensional Chromatography' edited by Mondello, Lewis and Bartle (John Wiley & Sons, 2002). A GC x GC system consists of two columns with different retention mechanisms, which are connected in series. In the truly multidimensional system, the separation mechanisms in the first and the second columns are different and independent of each other and the separation obtained in the first column is maintained during the modulation and separation in the second column. Generation and visualization of GC x GC chromatogram is shown in **Figure 6**.

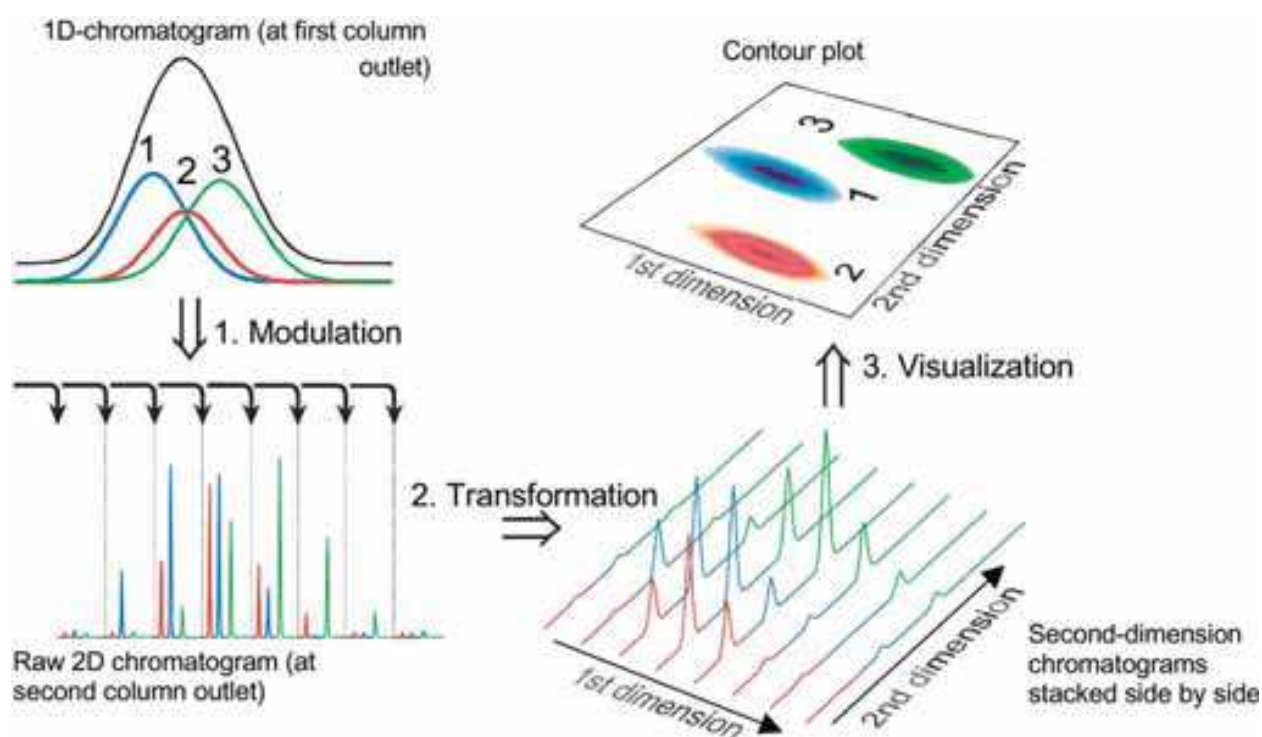

Fig. 6. Generation and visualization of a GC x GC chromatogram (From Dallüge et al., 2002. With permission.).

Peaks, or spots in the contour plot are identified by their retention times in the 1D and 2D, i.e., by their coordinates in the contour plot. Mass spectra for target analyte confirmation and/or the identification of unknowns can at present be obtained only from the chromatogram of the raw data (**Figure 6**, "raw 2D-chromatogram"). The total retention time of each peak of interest in the contour plot was calculated by adding the retention time from the first and second dimension. This total retention time is equivalent to the retention times in the raw 2D-chromatogram, where the peaks can be identified on the basis of their mass spectra, as is routinely done 1D-GC-MS. From the resulting peak table, both retention times (1D and 2D coordinates) were calculated to locate these peaks in the contour plot (Dallüge et al., 2002).

The two columns used may be operated at the same or independent temperatures. The sample is separated on the first column with conventional temperature program (most often 1-5°C per minute). During separation, small successive adjacent fractions of the eluate of the



first column are retained and focused at the beginning of the second column by means of a cryogenic modulator, which essentially works like a cold trap. After the trapping of each fraction, the modulator is switched off or moved away to effect the release of the retained analytes and the rapid injection on the second column (Dallüge et al., 2002). However, in practice, the sampling rate in the first dimension is limited by the duration of a single separation cycle in the second dimension. Thus, it would be advantageous to use as short a time for second-dimension to be efficient, it is advantageous to use longer time. Consequently, a compromise usually has to be struck between the first dimension sampling frequency and the second dimension separation time (Harynuk et al., 2005). Theoretical studies indicated that the optimum primary dimension sampling frequency is achieved when each primary dimension peak is sampled three to four times (Murphy et al., 2005).

The transfer of analyte from first dimension (1D) to second dimension (2D) by modulator and intervenes between the two dimensions gives important results in both dimensions, which arise from the modulation process. These are as follows (Marriott, 2002): (i) the zone to be passed (or more correctly, pulsed) from 1D to 2D must be compressed in space; (ii) the compressed zone must be delivered to 2D very rapidly, and as a sharp pulse; (iii) 2D must be capable of giving fast GC results, achieved by a combination or all of the following, i.e., a short column, thin film thickness, narrow i.d. column (giving high carrier linear velocity) and higher temperature (if a two-oven system is used); (iv) the peaks produced at the detector will be increased in peak height response due to the above process; (v) all of first column solute is transferred to the second column.

In practice, a number of mechanisms are used to enable refocusing and zone compression at the point of transfer, ranging from cryogenic and chemical micro-traps, to phase ratio refocusing at cooler over temperatures, when the secondary column is held at temperatures independent of the first column.

Overloading of the second dimension column in comprehensive two-dimensional gas chromatography separations can have a very significant effect on the available separation space in this dimension. The pesticides concentration in the samples are usually small and then narrow diameter columns should be used in second dimension of GC x GC experiment. Narrow columns have significant advantages, most important of which is the separation speed. It is much easier to obtain a very fast separation speed with narrower peaks under conditions of no overload in the second dimension. When analyzing samples in which the concentrations of the analytes or matrix components are unknown and may be high, it may be better to use larger diameter columns in the second dimension. In addition, this may lead to better overall resolution in the second dimension, unless the carrier gas flow rate in the system with the narrow second dimension column is reduced significantly (which lengthens the overall analysis time and might result in less efficient separation in the first dimension). It has been reported that it may actually be better to use columns with the same diameter in both dimensions in preliminary GC x GC experiments (Harynuk et al., 2005).

#### **2.1.4 Comprehensive two-dimensional Gas Chromatography (GC x GC) applied to analysis of pesticides**

As described earlier, substantial improvements in two-dimensional GC were not forthcoming until Phillips and his research group introduced and implemented an entirely new form of Two-Dimensional Gas Chromatography, called comprehensive two-dimensional GC, or GCxGC. The full sample is separated on a first, usually long conventional column, and then the entire sample is subjected to the second short column (in repeated cycles, hence

comprehensive), the eluting compounds are focused (usually cryo focused) in space and pulse-injected into a second column for their second dimension separation. A common phase selection strategy uses in first dimension separation of analytes according to their boiling points, whilst the second dimension separates analytes according to polarity.

In the literature, not too much attention has been devoted to the trace-level determination of pesticides, because there are many detailed protocols for their precise and accurate analysis by mean of 1D-GC-MS. The GC x GC technique has few main limitations (Poliak et al., 2008): (i) high price; (ii) difficult and expensive maintenance; GC x GC technique with thermal modulation requires inconvenient and costly maintenance in the form of daily consumption of carbon dioxide or liquid nitrogen; (iii) problematic compatibility with mass spectrometry; GC x GC technique with thermal modulation generates narrow GC peaks with less than 100 ms width, that are hard to combine with standard QMS, thus seems to require fast and expensive time-of-flight mass spectrometry (TOFMS). Nevertheless, now the GC x GC technique is more often applied as screening method for various groups of volatile and semivolatile analytes, because GC x GC (especially TOFMS) is a very promising powerful tool for identification and determination of pesticides. **Figure 7** shows diagram of modern GC x GC-TOFMS instrument. GC x GC provides unsurpassed resolution capability, the most pressing need is to prove that the implied complexity of a mixture is represented by the multitude of peaks spread about 2D space.

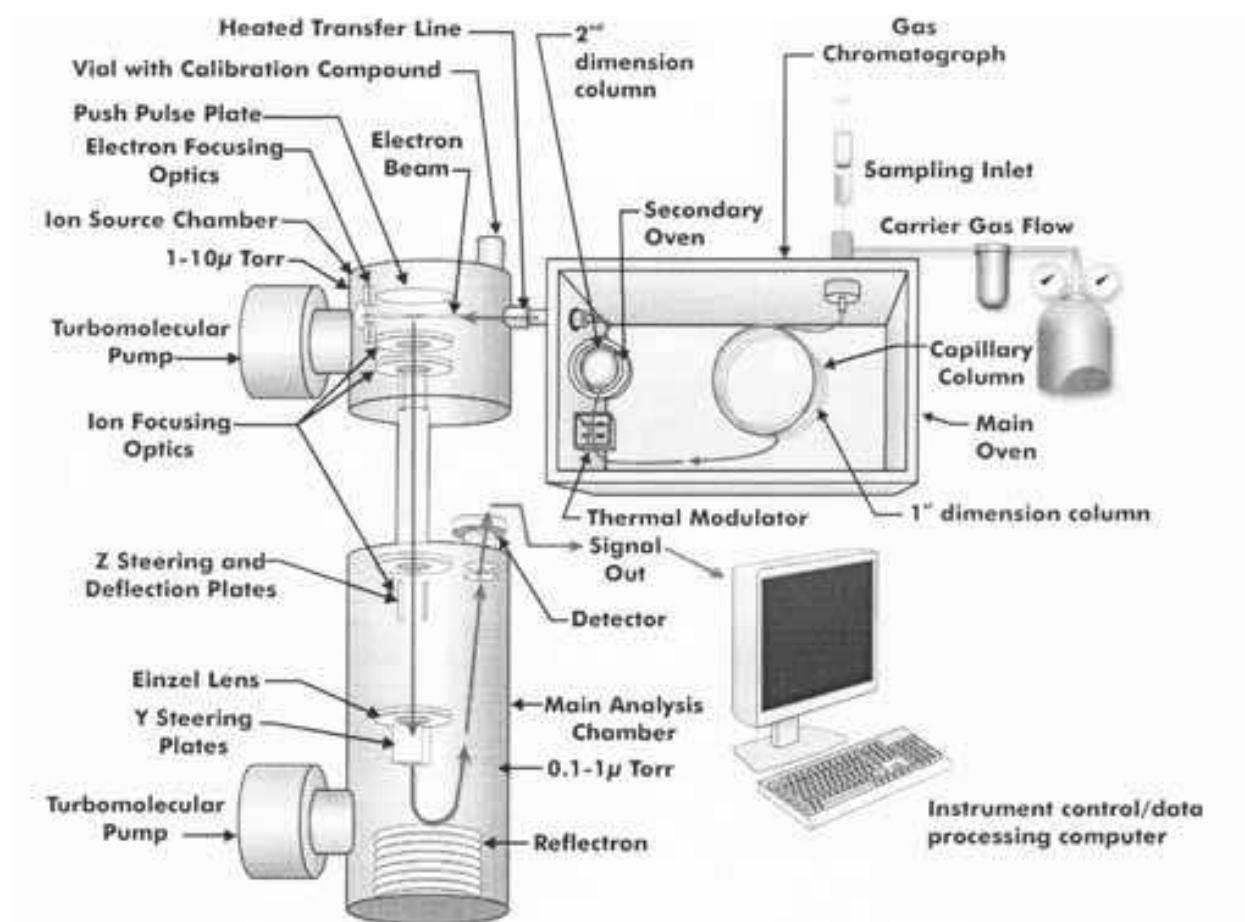

Fig. 7. Diagram of modern GC x GC - TOF MS instrument (From LECO Corporation, 2008. With permission.).

Determination of 287 pesticides at trace levels by GC x GC - TOFMS was described (Koning and Gumpendobler, 2007). GC x GC - TOFMS was able to analyze hundreds of pesticides in a single run. The use of GC x GC - TOFMS provides an enhanced separation mechanism that helps eliminate coelutions and provides users with a very structured and visually stimulating chromatogram (Koning and Gumpendobler, 2007).

As seen by viewing the second dimensions of the GC x GC contour plot in **Figure 8**, many coelutions would occur when analyzing in a single dimension mode. **Figure 9** displays a zoomed section of the contour plot indicating the coelution of four pesticides along the second dimension. However, these four pesticides are separated due to the selectivity of the second orthogonal separation (Koning and Gumpendobler, 2007). The separation of toxic analytes including 11 persistent halogenated pesticides by GC x GC - TOFMS was described (Focant et al., 2003). The feasibility of the coupling between GC x GC - TOFMS and the thermal desorption-programmable temperature vaporization injector was demonstrated from quantitative point of view. **Figure 10** illustrates the process responsible for the sharp re-injections of trapped analytes into the second column.

Especially, the determination of pesticides in complex matrices, such as food, often requires modern, rapid and universal methods. Comprehensive two-dimensional gas chromatography and isotope dilution time-of-flight mass spectrometry (GC x GC-IDTOFMS) for the simultaneous measurement of selected organochlorine pesticides (OCPs), polychlorinated biphenyls and bromide flame retardants in human serum and milk was described (Focant et al., 2003). The GC x GC-IDTOFMS results demonstrated the efficiency of this multianalyte measurement approach for such important matrices as serum and milk for human biomonitoring. **Figure 11** illustrates GC x GC-TOFMS chromatogram of the 11 persistent organochlorine pesticides in a human sample.

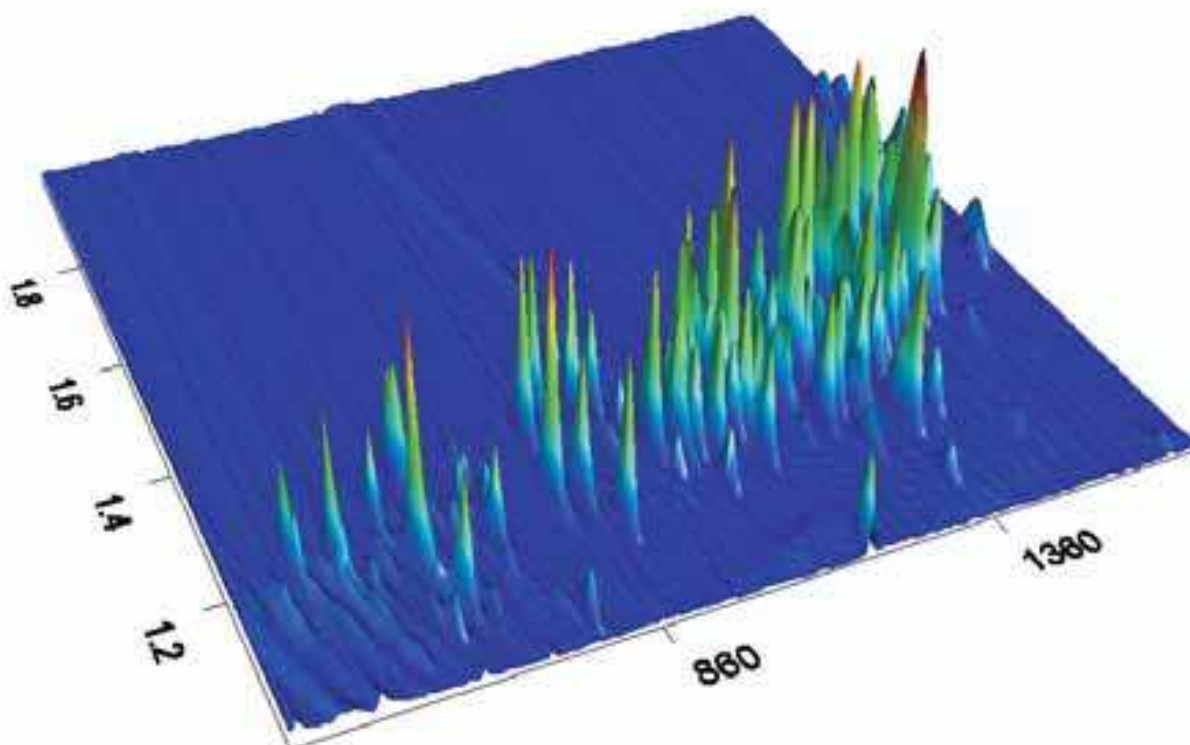

Fig. 8. GC x GC chromatogram for 287 investigated pesticides (From Koning and Gumpendobler, 2007. With permission.).

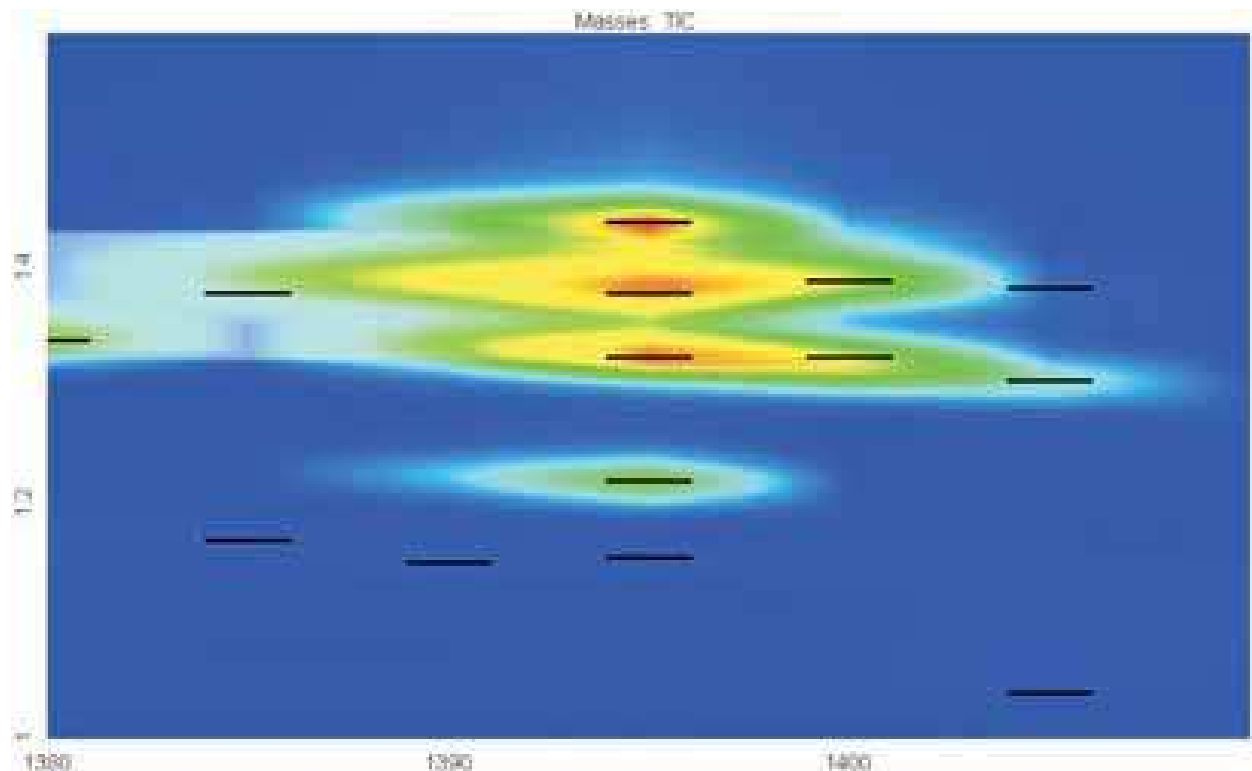

Fig. 9. Zoomed contour plot indicating coelution in the first dimension, but four analytes separation in the second dimension (From Koning and Gumpendobler, 2007. With permission.).

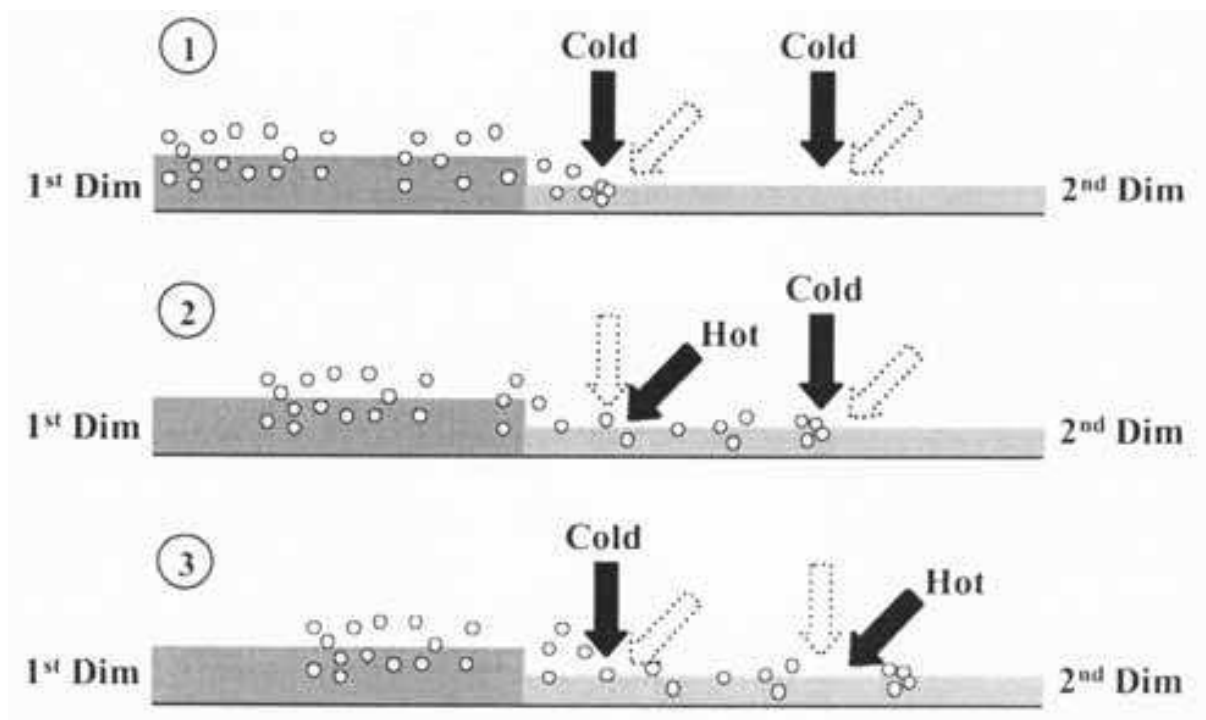

Fig. 10. Sequence of events responsible for (1) trapping, (2) releasing and re-focusing, and (3) re-injecting into the second column using a quad-jet cryo-modulator (From Focant et al., 2003. With permission.).

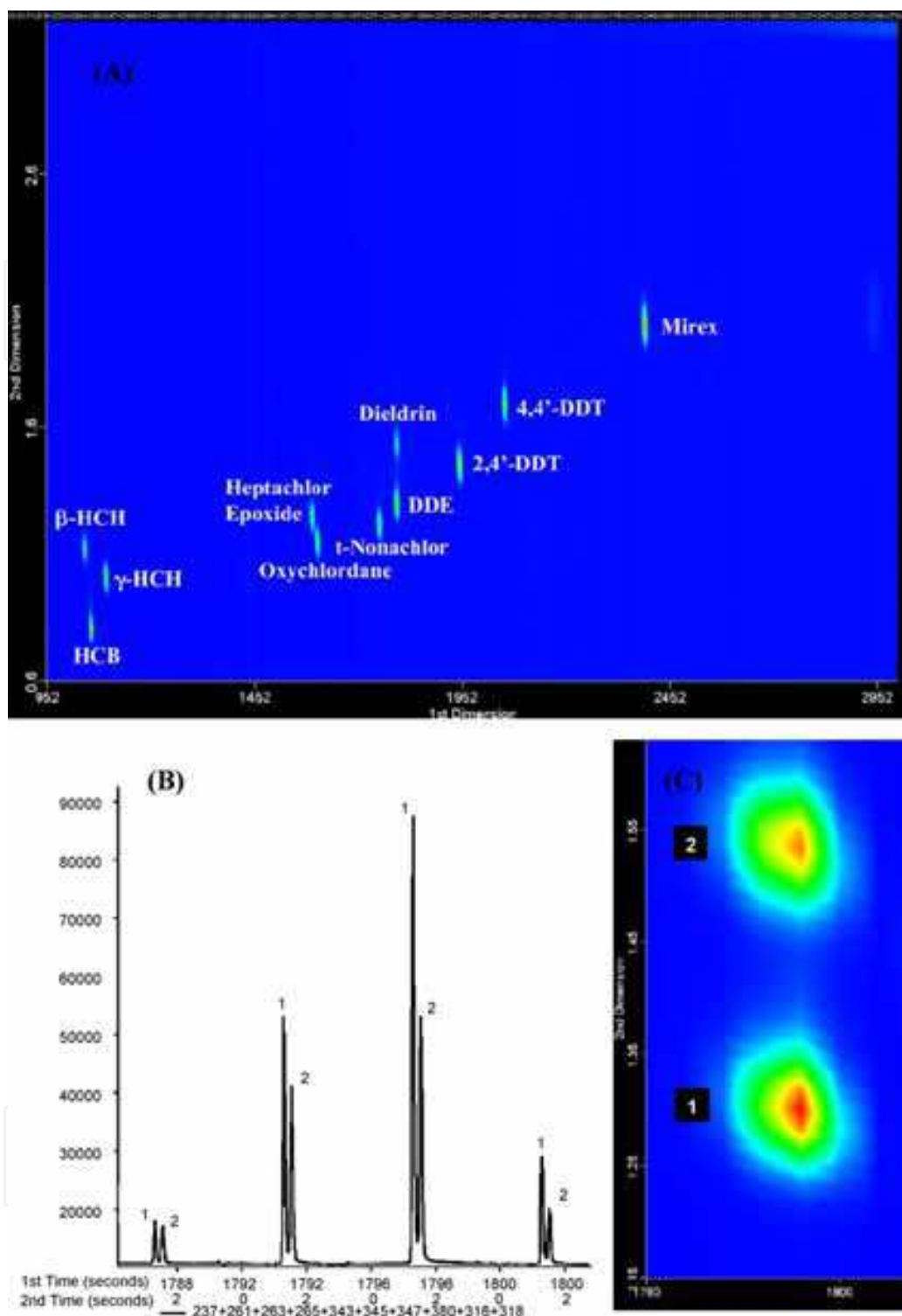

Fig. 11. (A) GCxGC-TOFMS chromatogram of the 11 persistent pesticides analyzed in human sample. The signal was reconstructed using six to eight characteristic ions for each compound (deconvoluted ion current traces). (B) A closer look at the region of the chromatogram where DDE (1) and dieldrin (2) eluate. The chromatogram has been reconstructed using the sum of the characteristic ions of the two species. (C) Shows the cluster corresponding to the 'slices' that can be recombined to produce the GCxGC contour plot shown in (B) (From Focant et al., 2003. With permission.).

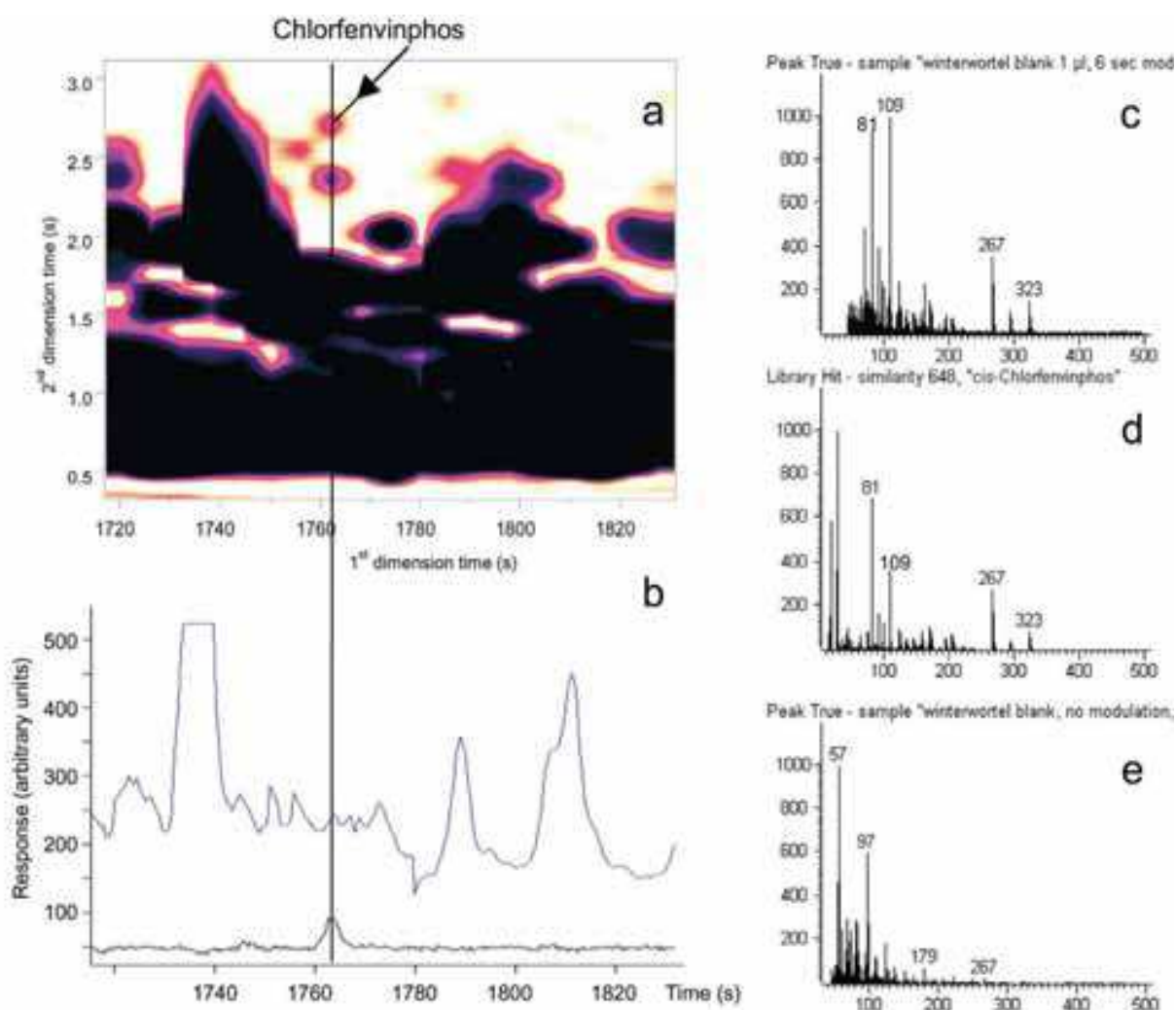

Fig. 12. GCxGC-TOF MS versus 1D-GC-TOF MS for the analysis of a carrot extract. (a) GCxGC-TOF MS contour plot. (b) 1D-GC-TOF MS chromatogram of the same region; upper trace, TIC scaled to 1%; lower trace,  $m/z$  323 ion trace. (c) Mass spectrum obtained after GCxGC separation showing the characteristic  $m/z$  values of chlorfenvinphos ( $m/z$  81, 109, 267, 295, 323). (d) Library spectrum of chlorfenvinphos and (e) spectrum obtained at the retention time of chlorfenvinphos after 1D-GC separation (From Dallüge et al., 2002. With permission.).

In another study (Zrostlíková et al., 2003), authors demonstrated GC  $\times$  GC - TOFMS as a powerful tool for solving the problems with reliable confirmation of pesticide residues at very low concentration levels as required for the analysis of some types of samples of baby food. The most troublesome matrix interferences observed in apple and peach were eluted as very broad asymmetric peaks completely overlapping the peaks of pesticides in the first dimension "boiling-point" separation. However, thanks to differing retention of these co-extracts they were in most cases efficiently separated in the second dimension of GC  $\times$  GC experiments. The limits of detection for most pesticides were well below 10 ng/mL and the reliable confirmation of analyte identity was possible at 10 ng/mL level for typically troublesome pesticides such as polar organophosphorus pesticides, methamidophos or acephate (Zrostlíková et al., 2003). In another paper, authors (Dallüge et al., 2002)

demonstrated the dramatic improvement of separation in comparison with conventional GC by employing GC x GC - TOFMS with cryogenic modulator. All analyzed 58 pesticides in food extracts could be identified using their full-scan mass spectra, which was not possible when using 1D-GC-TOFMS. GC x GC-TOFMS versus 1D-GC-TOFMS for the analysis of a carrot extract is shown in **Figure 12**.

Comprehensive two-dimensional gas chromatography (GC x GC) coupled with nitrogen-phosphorus detector (NPD) and with micro electron-capture detector ( $\mu$ ECD) was applied for the separation and quantitation of fungicides in vegetable samples (Khummueng et al., 2006). The comparison of different column sets and selection of the temperature program were carried out with a mixture of nine N-containing fungicides, eight of which were chlorinated. Both techniques: GC x GC-NPD and GC x GC-  $\mu$ ECD were compared. The non-polar/polar column set used in GC x GC, with thicker film phase in the 2D column gives symmetric, non-tailing peaks in GC x GC analysis with NPD detector. The limit of detection (LOD) and limit of quantitation (LOQ) were less than about 74 and 246 ng L<sup>-1</sup>. The described study shows that GC x GC-NPD has a potential for the routine analysis of fungicides in food and vegetables samples, providing a low LOD and LOQ and a good repeatability and reproducibility of peak response (Khummueng et al., 2006). Determination of pesticide residues in grapes samples by GC x GC-  $\mu$ ECD and GC x GC coupled with flame ionization detector (FID) was also described (Pizzuti et al., 2009). In this study, a new compressed air modulator was used in GC x GC-  $\mu$ ECD experiments. **Figure 13** shows dual-stage

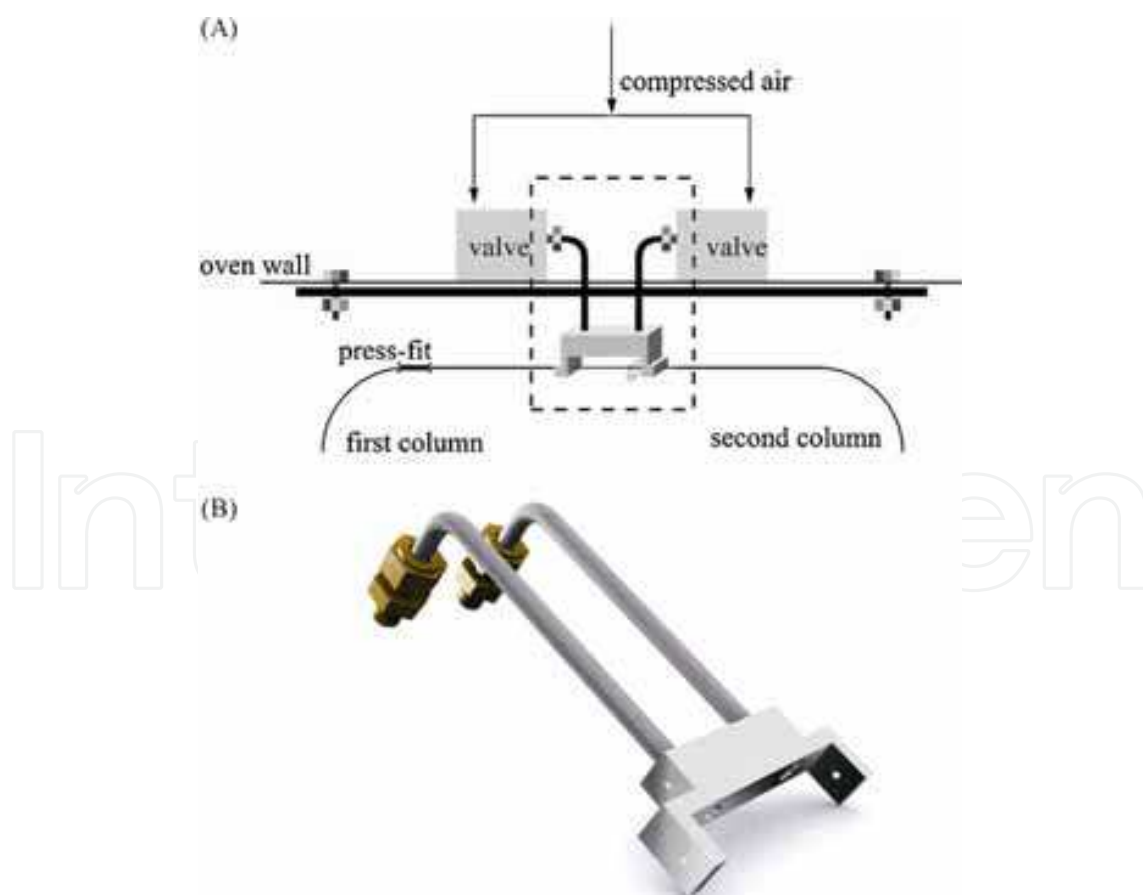

Fig. 13. (A) Schematic representation and (B) a photograph of the dual-stage compressed air modulator for GCxGC (From Pizzuti et al., 2009. With permission.).

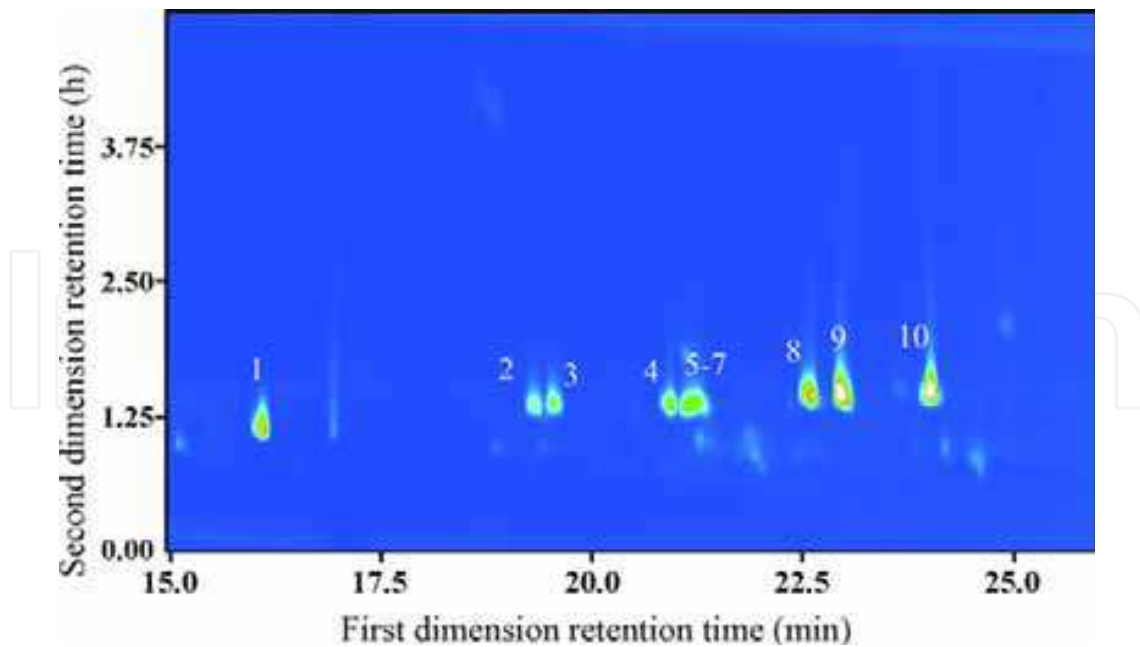

Fig. 14. GC×GC- $\mu$ ECD contour plots for a matrix extract spiked at  $0.05\text{mgkg}^{-1}$  with pyrethroid pesticides. Target compounds are numbered as follows: (1) bifenthrin; (2) *cis*-permethrin; (3) *trans*-permethrin; (4–7) cypermethrin (I, II, III, IV); (8) fenvalerate; (9) esfenvalerate; (10) deltamethrin. (From Pizzuti et al., 2009. With permission.).

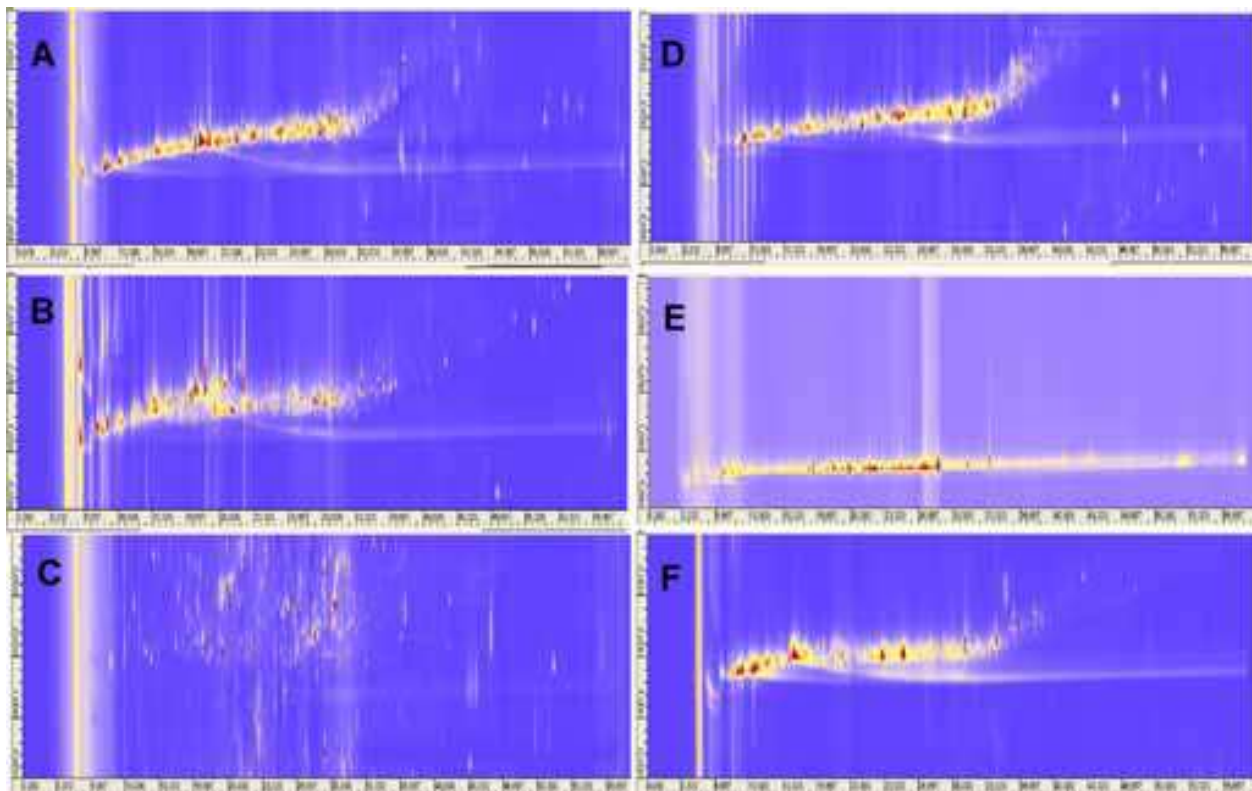

Fig. 15. Analysis of a non-spiked orange extract by GC×GC- $\mu$ ECD using (A) ZB-5×HT-8, (B) ZB-5×BPX-50, (C) ZB-5×SW10, (D) DB-17×HT-8, (E) DB-17×BPX-50 and (F) HT-8×BPX-50 as column combinations. (From Ramos et al., 2009. With permission.).



compressed air modulator for GC×GC instrument. This modulator uses compressed air to cool two small portions in the first centimeters of the second chromatographic column of a comprehensive multidimensional gas chromatography system. The GC x GC system proposed was applied in the determination of pyrethroid pesticides (bifenthrin, cypermethrin, deltamethrin, fenvalerate, esfenvalerate, *cis*- and *trans*-permethrin) in grape samples.

**Figure 14** shows GC x GC-  $\mu$ ECD contour plots for a matrix extract spiked at 0.05 mg kg<sup>-1</sup> with pyrethroid pesticides. The values of method (GC x GC-  $\mu$ ECD) limit of quantification (LOQ) were 0.01-0.02 mg kg<sup>-1</sup> for all pyrethroids and the values of recovery were between 94.3 and 115.2% with good precision, RSD < 18.4% (Pizzuti et al., 2009).

Determination of three classes of pesticides (organophosphorus pesticides, triazines and pyrethroids) in selected fruits, i.e., orange, apple, pear and grape by GC x GC-  $\mu$ ECD also was described (Ramos et al., 2009). Six column combination with different polarities were tested (**Figure 15**). Firstly, an apolar phase, ZB-5, was combined with phases of increasing polarity, i.e. BPX-50 and SW, and of different selectivity, i.e., HT-8. Secondly, a more polar phase, DB-17, was tested as first dimension in combination with HT-8 and BPX-50 as second dimension columns (Ramos et al., 2009). The proposed GC x GC-  $\mu$ ECD allowed accurate determination of the analytes at levels far below the MRLs set in current EU legislations even if no further concentration of the collected extract was carried out.

## 2.2 Mutidimensional Liquid Chromatography (MDLC) applied to analysis of pesticides

### 2.2.1 Introduction to Mutidimensional Liquid Chromatography (MDLC)

Multidimensional chromatography (also known as coupled-column chromatography (LC-LC coupling) or column switching) represents a powerful tool and an alternative procedure to classical one-dimensional high performance liquid chromatography. Multidimensional liquid chromatography (MDLC) separation has been defined as technique which is mainly characterized by two distinct criteria: (i) the first criterion for a multidimensional system is that sample components must be displaced by two or more separation techniques involving orthogonal separation mechanisms; (ii) the second criterion is that components that are separated by any single separation dimension must not be recombined in any further separation dimension (Giddings, 1984; 1987).

Multidimensional liquid chromatography (MDLC) can be performed as in MDGC either in on-line or off-line mode. With off-line operation, the fractions eluted from the primary column are collected manually or by a fraction collector and then reinjected, either with or without concentration, into a second column. This approach has the advantage of being simple, does not need any switching valve, and the mobile phases in each column need not be mutually compatible. These mode has also disadvantages: (i) more time-consuming; (ii) procedure are labour-intensive; (iii) sample loss or contamination during handling; (iv) recovery of sample is low. On-line mode of MDLC have the advantage of automation by using pneumatic or electronically controlled valving, which switches the column effluent directly from the primary column into the secondary column. The on-line technique is more reproducible, no loss off sample and contamination occurs. Automation improves reliability and sample throughput, and shortens the analysis time, as well minimizes sample loss or change since the analysis is performed in a closed-loop system (Corradini, 2002).

What characterizes coupled-column chromatography (LC-LC coupling) when compared to conventional multistep chromatography is the requirement that the whole chromatographic process be carried out on-line. The transferred volume of the mobile phase from the first

column to the second column (from 1D to 2D) can correspond to a group of peaks, a single peak or a fraction of a peak, so that different parts of the sample may follow different paths through the LC-LC configuration (Corradini, 2002).

LC-LC coupling can be subdivided into both systems (Regnier & Huang, 1996):

- homomodal LC-LC is a type of development, in which the chromatographic improvement occurs by switching columns of analogous selectivity. The goal is mainly to optimize an already satisfactory separation, that is, to concentrate a dilute sample (sample enrichment) or to shorten the analysis time;
- heterogenous LC-LC is a type of development achieved by varying the separation mechanism during the separation process; selectivity changes may be made by varying the nature of the stationary phase, which can possess complementary separation characteristics.

The term '*LC-LC*', and more generally 'multidimensional', is usually restricted to heterogenous LC-LC system, which involve separation modes which are as different as possible (orthogonal), and in which there is a distinct difference in retention mechanisms (Giddings, 1984).

The LC-LC separation system may be used in both modes (Regnier & Huang, 1996):

- profiling mode is to separate all single components from multicomponent, complex sample. In this mode every component from the first column (primary column, 1D) is fractionated and transferred to the second column (secondary column, 2D);
- targeted mode is to isolate either a single or a few components of similar retention in a complex sample containing components having a wide range of capacity factor values. Targeted LC-LC analysis is carried out by transferring a wide or narrow cut of the chromatographic effluent from the 1D to 2D by flow switching and the mobile phase is thereby diverted or reserved. The fraction of interest to be transferred to a secondary column may consist of early-eluting analytes (first eluted zone, the 'front-cut'), or components eluted in the middle of the chromatographic effluent ('heart-cut') or at the end of the chromatogram ('end-cut') (Ramsteiner, 1988).

Multidimensional liquid chromatography (MDLC) has been applied to analysis of non-volatile pesticides, but presently the MDLC is used generally rather less often than MDGC.

### **2.2.2 Coupled-column chromatography (LC-LC Coupling) applied to analysis of pesticides**

Screening and analysis of polar pesticides based on coupled-column reversed-phase (RP) liquid chromatography (LC-LC) and GC-MS has been used as a powerful tool in the execution of environmental monitoring programmes (Hogendoorn et al., 1996). Reversed-phase liquid chromatography in combination with UV detection is an attractive technique for the analysis of polar pesticides in aqueous samples. It is robust, rugged and allows the direct injection of aqueous samples, without the need for extraction, derivatization or other sample manipulations. A relative disadvantage is that the sensitivity attainable with UV detection is usually insufficient for trace analysis. Consequently, a sample preconcentration step is needed for sensitive analysis. The compatibility of the mobile phase system with aqueous samples allows on-line sample enrichment by large volume injections in combination with LC column switching techniques. Authors show LC - LC (RP in both dimensions) examples of chromatograms of an extract of a raw drinking water sample indicating a monolinuron residue of 0.1  $\mu\text{g L}^{-1}$  and ground water sample containing 0.08  $\mu\text{g L}^{-1}$  ETU (Hogendoorn et al., 1996). The coupled-column (LC-LC) configuration consisting of

a 3  $\mu\text{m}$   $\text{C}_{18}$  column (50 x 4.6 mm I.D.) as the first column and a 5  $\mu\text{m}$   $\text{C}_{18}$  semi-permeable-surface (SPS) column (150 x 4.6 mm I.D.) as the second column appeared to be suitable for screening of acidic pesticides in surface water samples (Hogendoorn et al., 1999). In comparison to LC-LC employing two  $\text{C}_{18}$  stationary phases in both dimensions, the combination of  $\text{C}_{18}$  and SPS- $\text{C}_{18}$  columns significantly decreased the baseline deviation caused by the hump of the humic substances when using UV detection. The developed LC-LC procedure allowed the simultaneous determination of the target analytes bentazone and bromoxynil in uncleaned extracts of surface water samples to a level  $0.05 \mu\text{g L}^{-1}$  in less than 15 min. **Figure 16** shows example of LC-LC chromatogram with two acidic herbicides separated on the  $\text{C}_{18}$  (1D) and SPS- $\text{C}_{18}$  (2D) columns combination (Hogendoorn et al., 1999).

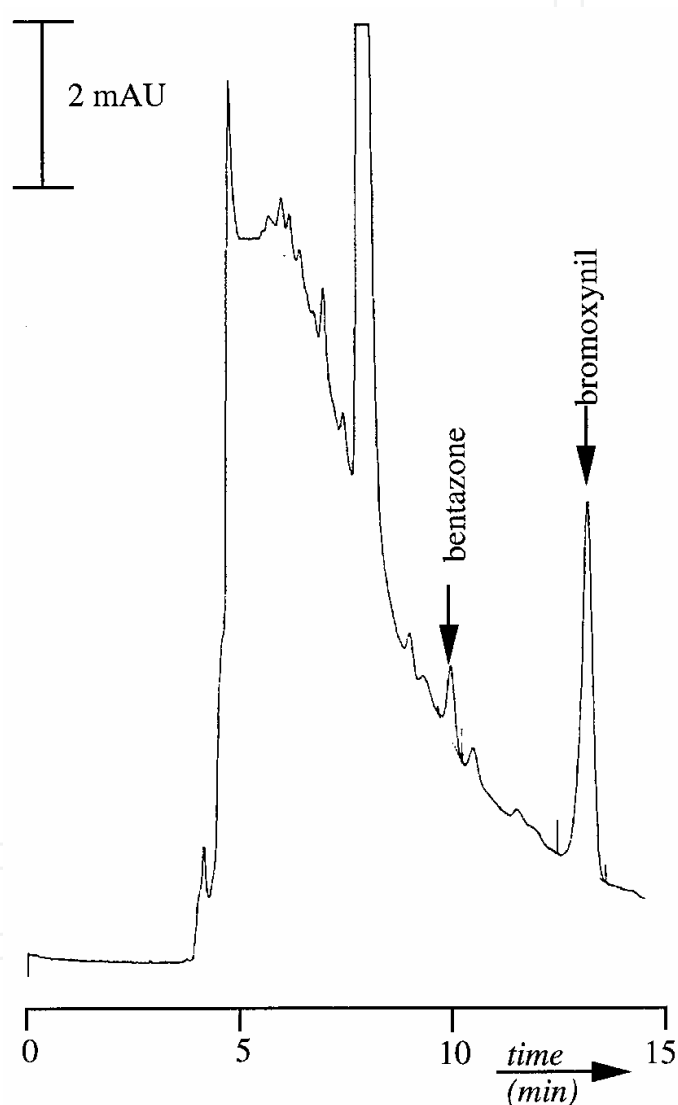

Fig. 16. LC-LC-UV (217 nm) chromatogram with the  $\text{C}_{18}$  (1D) and SPS- $\text{C}_{18}$  (2D) columns combination of an extract of ditch surface water sample containing  $0.37 \mu\text{g L}^{-1}$  of bentazone and  $2.3 \mu\text{g L}^{-1}$  of bromoxynil (From Hogendoorn et al., 1999. With permission.).

Concerning the determination of analytes involved in the studies mentioned above coupled-column LC-LC methods were used for analysis of ETU (Hogendoorn et al., 1991) and chlorophenoxy acid herbicides (Sancho-Llopis et al., 1993).

## 2.3 Mutidimensional Planar Chromatography (MDPC) applied to analysis of pesticides

### 2.3.1 Introduction to Mutidimensional Planar Chromatography (MDPC)

The application of multidimensional planar chromatography combined with different separation systems and modes of chromatogram development is often necessary for performing the separation of more complicated multicomponent mixtures. High separation efficiency can be obtained using modern planar chromatographic techniques which comprise two-dimensional development, chromatographic plates with different properties, a variety of solvent combinations for mobile phase preparation, various forced-flow techniques and multiple development modes. By combination of these possibilities, multidimensional planar chromatography (MDPC) can be performed in various ways. Giddings defined multidimensional chromatography as a technique which includes two criteria (Giddings, 1990):

- the components of the mixture are subjected to two or more separation steps in which their migration depends on different factors,
- when two components are separated in any single step, they always remain separated until completion of the separation.

Nyiredy divided multidimensional planar chromatography techniques as follows (Nyiredy, 2001, 2002, 2003):

- comprehensive two-dimensional planar chromatography (PC x PC) – multidimensional development on the same monolayer stationary phase and two developments with different mobile phases or using a bilayer stationary phase and two developments with the same or different mobile phases;
- targeted or selective two-dimensional planar chromatography (PC + PC) – technique, in which following the first development from the stationary phase a heart-cut spot is applied to a second stationary phase for subsequent analysis to separate the compounds of interest;
- targeted or selective two-dimensional planar chromatography (PC + PC) – second mode – technique, in which following the first development, which is finished and the plate dried, two lines must be scraped into the layer perpendicular to the first development and the plate developed with another mobile phase, to separate the compounds that are between the two lines. For the analysis of multicomponent mixtures containing more than one fraction, separation of components of the next fractions should be performed with suitable mobile phases;
- modulated two-dimensional planar chromatography (<sup>n</sup>PC) – technique, in which on the same stationary phase the mobile phases of decreasing solvent strengths and different selectivities are used;
- coupled-layer planar chromatography (PC-PC) – technique, in which two plates with different stationary phases are turned face to face (one stationary phase to second stationary phase) and pressed together so that a narrow zone of the layers overlaps, the compounds from the first stationary phase are transferred to the second plate and separated with a different mobile phase;
- combination of multidimensional planar chromatography methods – technique, in which the best separation of multicomponent mixture is realized by parallel combination of stationary and mobile phases, which are changed simultaneously. By use of this technique, e.g., after separation of compounds in the first dimension with changed mobile phases, the plate is dried and separation process is continued in perpendicular direction by use of the grafted technique with changed mobile phase (based on the idea of coupled TLC plates, denoted as graft TLC in 1979 (Pandey et al., 1979)).

## 2.3.2 Multidimensional Planar Chromatography (MDPC) applied in pesticide analysis

### 2.3.2.1 Comprehensive Two-dimensional (2D) Chromatography on One Adsorbent

One of the most attractive features of planar chromatography is the ability to operate in the two-dimensional (2D) mode. Two-dimensional TLC (2D-TLC) is performed by spotting the sample in the corner of a square chromatographic plate and by development in the first direction with the first eluent. After the development is completed the chromatographic plate is then removed from the developing chamber and the solvent is allowed to evaporate from the layer. The plate is rotated through  $90^\circ$  and then developed with the second solvent in the second direction which is perpendicular to the direction of the first development. In 2D-TLC the layer is usually of continuous composition, but two different mobile phases must be applied to obtain a better separation of the components. If these two solvent systems are of approximately the same strength but of optimally different selectivity, then the spots will be distributed over the entire plate area and in the ideal case the spot capacity of the two-dimensional system will be the product of the spot capacity of the two constituent one-dimensional systems. If the two constituent solvent systems are of the same selectivity but of different strengths, the spots will lie along a straight line; if both strength and selectivity are identical, the spots will lie along the diagonal.

Computer-aided techniques enable identification and selection of the optimum mobile phases for separation of different groups of compounds. The first report on this approach was by Guiochon and co-workers, who evaluated ten solvents of fixed composition in two-dimensional separation of nineteen dinitrophenyl amino acids chromatographed on polyamide layers (Gonnord et al., 1983). The authors introduced two equations for calculation of the separation quality – the sum of the squared distances between all the spots,  $D_A$ , and the inverse of the sum of the squared distances between all the spots,  $D_B$ . Steinbrunner et al. (Steinbrunner et al., 1986) proposed other functions for identification of the most appropriate mobile phases – the distance function  $DF$  and the inverse distance function  $IDF$ , which are the same form as  $D_A$  and  $D_B$ , respectively, but which use distances rather than the squares of distances. The planar response function  $PRF$  has been used as optimization criterion by Nurok et al. (Nurok et al., 1987). Strategies for optimizing the mobile phase in planar chromatography (including two-dimensional separation) (Nurok, 1989) and overpressured layer chromatography (including two-dimensional overpressured layer chromatography) (Nurok et al., 1997) have also been described. Another powerful tool is the use of graphical correlation plots of retention data for two chromatographic systems which differ with regard to modifiers and/or adsorbents (De Spiegeleer et al., 1987). The interpretation of plots is illustrated in **Fig. 17**. The plots on **Figure 17** indicate then directly the positions of spots on a two – dimensional chromatograms (2D-TLC). As shows **Figure 17F** the best separation of complex mixtures by 2D-TLC is possible with differentiated  $R_F$  values in both systems, then the correlation plots of retention parameters for two chromatographic systems are poor (Tuzimski & Soczewiński, 2002). Good separation can be achieved when the spots are spread over the whole of the chromatographic plate area (Tuzimski, 2004; Tuzimski & Soczewiński, 2002a-d; Tuzimski & Bartosiewicz, 2003). The largest differences were obtained by combination of normal-phase (NP) and reversed-phase (RP) systems with the same chromatographic layer, e.g., cyanopropyl (Tuzimski & Bartosiewicz, 2003; Hauck et al., 1996). An example of this type of 2D development is illustrated in **Figure 18d**.

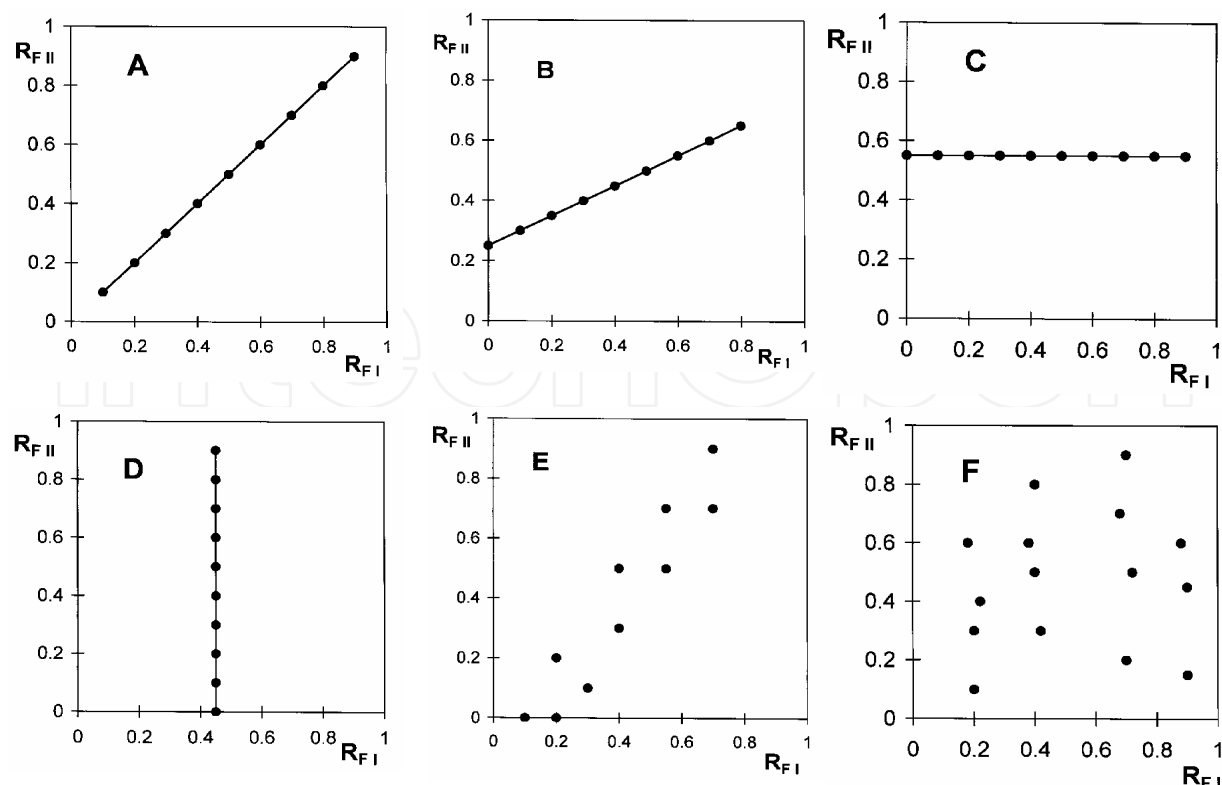

Fig. 17. Characteristic correlations  $R_{FII}$  vs.  $R_{FI}$  (From Tuzimski & Soczewiński 2002a, With permission.).

### 2.3.2.2 Two-dimensional thin-layer chromatography

In 2D development the mixtures can be simultaneously spotted at each corner of the chromatographic plate so that the number of separated samples can be higher in comparison to the 'classical 2D development' (Hubert et al., 1988, Dzido, 2001). An example of this type of 2D development is illustrated in **Figure 18a-d**. **Figure 18d** shows a videoscans of the plate which shows separation of three fractions of the mixture of nine pesticides by 2D planar chromatography with NP/RP systems on a chemically bonded-cyanopropyl stationary phase.

Nyiredy (Nyiredy, 2001; Szabady & Nyriedy, 1996) described the technique of joining two different adsorbent layers to form a single plate. Also large differences were obtained by combination of normal-phase systems of the type silica/nonaqueous eluent and reversed-phase systems of the type octadecyl silica/water + organic modifier (methanol, acetonitrile, dioxane) on multiphase plates with a narrow zone of SiO<sub>2</sub> and a wide zone of RP-18 (or vice versa) which are commercially available from Whatman (Multi K SC5 or CS5 plates) (Tuzimski & Soczewiński, 2002a-d; Tuzimski & Bartosiewicz, 2003). Tuzimski and Soczewiński as first used bilayer Multi K plates for separation of complex mixtures (**Figure 18b**) (Tuzimski & Soczewiński, 2002a-d; Tuzimski & Bartosiewicz, 2003).

Method development for 2D-TLC of complex mixtures can be formulated as follows (Tuzimski & Soczewiński, 2002a):

- determine  $R_F$  vs. % modifier plots for polar adsorbent and nonaqueous eluents composed of heptane (or hexane) and 2-3 polar modifiers; choose compositions of eluents for optimal differentiated retention of the components (in the range 0.05 - 0.70)

- determine  $R_F$  vs. % modifier concentration plots for aqueous RP systems (octadecyl, cyanopropyl silica or other polar adsorbents) for methanol and acetonitrile modifiers and choose optimal concentration of modifier
- correlate the  $R_F$  values for NP/RP combinations and choose that corresponding to optimal spacing of spots on the plate area
- use the optimal combination of NP/RP eluents for a bilayer or monolayer plate (silica, cyanopropyl silica, etc.).

Horizontal chambers can be easily used for two-dimensional separations. The only problem seems to be the sample size. In a conventional two-dimensional separation used for analytical purposes the sample size is small. The quantity of the sample can be considerably increased when using a spray-on technique with an automatic applicator. Soczewiński and Wawrzynowicz have proposed a simple mode to enhance the size of the sample mixture with the ES horizontal chamber (Soczewiński & Wawrzynowicz, 1981).

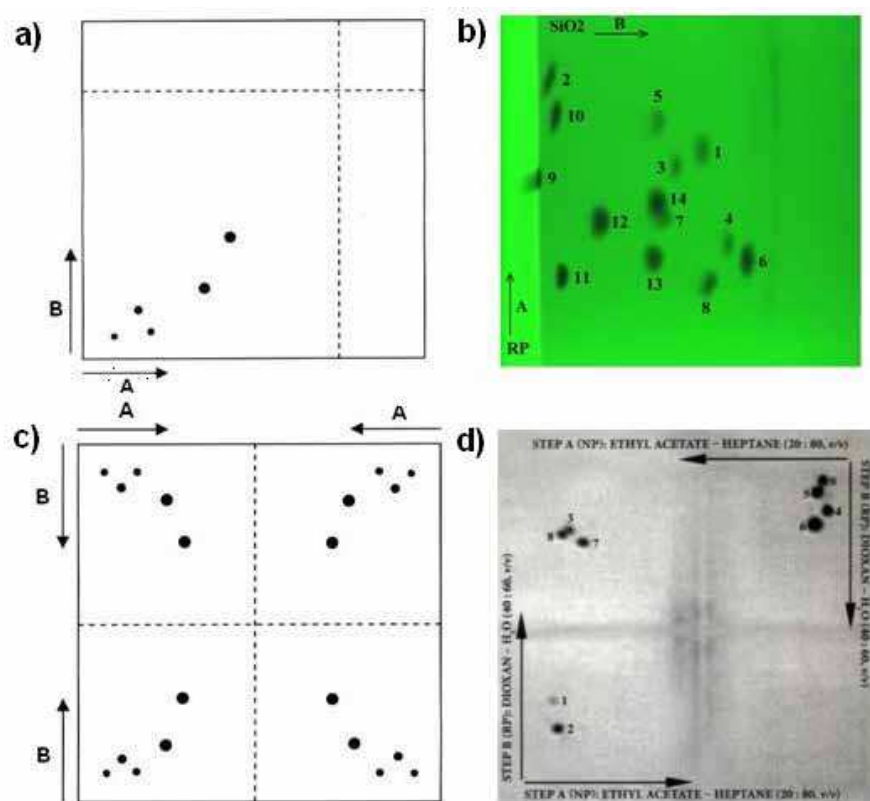

Fig. 18. Two-dimensional development, (a) schematic presentation of 2D-chromatogram (Adapted from Dzido, 2001. With permission.), (b) 2D-chromatogram of the 14-component mixture of pesticides presented as videoscan of dual-phase Multi-K CS5 plate in systems: A (first direction): methanol-water (60:40, v/v) on octadecyl silica adsorbent, B (second direction): tetrahydrofuran-*n*-heptane (20:80, v/v) on silica gel (From Tuzimski, 2002c. With permission), (c) schematic presentation of 2D- chromatogram of four samples simultaneously separated on the plate (Adapted from Dzido, 2001. With permission.), (d) 2D-chromatograms of three fractions of the mixture of nine pesticides presented as videoscan of the HPTLC plate (cyanopropyl) in systems with A (first direction): ethyl acetate-*n*-heptane (20:80, v/v), B (second direction): dioxane - water (40:60, v/v) (From Tuzimski & Soczewiński, 2004. With permission.).

### 2.3.2.3 Graft Thin-Layer Chromatography

The multidimensional separation can be performed using different mobile phases in systems with single-layer or bi-layer plates. Graft thin-layer chromatography is a multiple system in which chromatographic plates with similar or different stationary phases are used. Compounds from the first chromatographic plate after chromatogram development can be transferred to the second plate, without scraping, extraction, or re-spotting the bands by use of a strong mobile phase (Nyiredy, 2001). Graft-thin layer chromatography, a novel multiplate system with layers of the same or different adsorbents for isolation of the components of natural and synthetic mixtures on preparative scale, was first described by Pandey et al. (Pandey et al., 1979). The procedure of performing reproducible graft-TLC analysis was described in detail by Tuzimski (Tuzimski, 2007a). An example of this technique is demonstrated in **Figures 19** and **20** (Tuzimski, 2007a; Tuzimski, 2005).

In graft-TLC experiments with connected adsorbent layers several mixtures can be applied as spots 1 cm from the edge of the first adsorbent, e.g., silica gel plate. Several samples can be developed at the same time in the first direction, on the first adsorbent (up to ten in case of 20 cm x 10 cm plates). After drying, the plate used in the first run is cut into 2 cm x 10 cm strips. The cut strips should have smooth edges, without irregularities resulting from partial loss of adsorbent, because such irregularities may lead to deformation of the zones during the transfer to the second adsorbent layer. If the adsorbent edge is uneven, it should be smoothed before attachment to the second adsorbent (Tuzimski, 2007a). Then individual strips are clamped to other plates and compounds are transferred. Individual strips should be connected (2 mm overlap) to 10 cm x 10 cm HPTLC plates along the longer (10-cm) side of the strip. It is essential the two the plates are in close contact, but without disintegration of the overlapping layers. To achieve this the HPTLC plates are placed between thicker glass plates pressed together with screw clamps. The transfer of analysed compounds is performed in vertical glass chamber, as the joined plates are difficult to be developed in horizontal chambers. The most important issue in graft-TLC is to choose appropriate solvent to transfer compounds from the first adsorbent to another. The choice of this solvent depends on the choice of the first and second adsorbents and character of the transferred substances (whether polar or nonpolar). MeOH is usually applied for transferring compounds from the first adsorbent to another layer (Tuzimski, 2007a). If the analyzed compounds are strongly adsorbed on the first adsorbent, the addition of organic acids, and also water, to transferring solvent, is advised. So that all sample compounds have  $R_F = \approx 1.0$ . If after transfer from, e.g., the silica layer the spots are spread along the 1-cm transfer distance, the second HPTLC plate can be developed to a distance of 1 cm with a strong solvent to improve their shapes. The application of narrow strip of the first adsorbent may also play the same role as the preconcentrating zone in case of multiphase (bilayer) plate. The sample components are not only separated on the first step of graft-TLC experiment, but also concentrated, and as-such developed in the second direction. The concentration is also performed during the transfer, as the strong mobile phase used in this procedure transfer the analyzed substances to another adsorbent as very thin bands. Graft thin-layer chromatographic separation (2D planar chromatography on connected layers) of three mixtures of pesticides were described (Tuzimski, 2007a; Tuzimski, 2005).

Complete separation of the components of the pesticide mixtures was also achieved by adsorbent-gradient 2D TLC when in the first, normal-phase (NP), development was



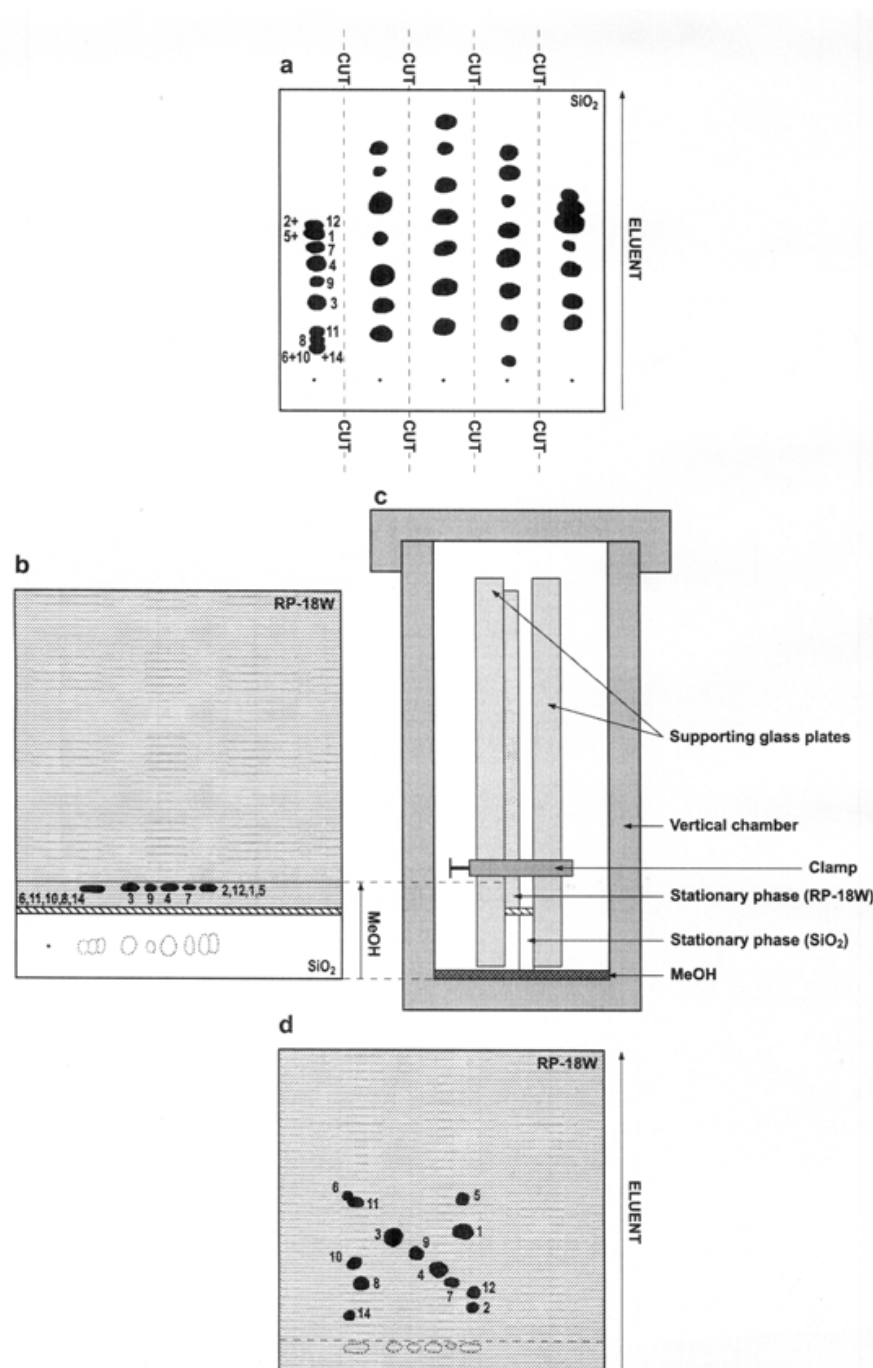

Fig. 19. Transfer of the mixture of pesticides from the first plate to the second one. (a) First development with partly separated mixtures of pesticides on silica plate. After development the silica plate was dried and cut along the dashed lines into 2 cm x 10 cm strips. (b) A narrow strip (2 cm x 10 cm) was connected (2 mm overlap - hatched area) to 10 cm x 10 cm HPTLC RP-18W plate along the longer (10 cm) side of the strip. The partly separated mixture of pesticides was transferred in a vertical chamber to the second plate using methanol as strong eluent to the distance of about 1 cm. (c) Schematic diagram of cross section of connected two adsorbents layers. (d) The HPTLC RP-18W plate was developed in the second dimension with organic - water eluent in the DS chamber (From Tuzimski, 2007a. With permission).

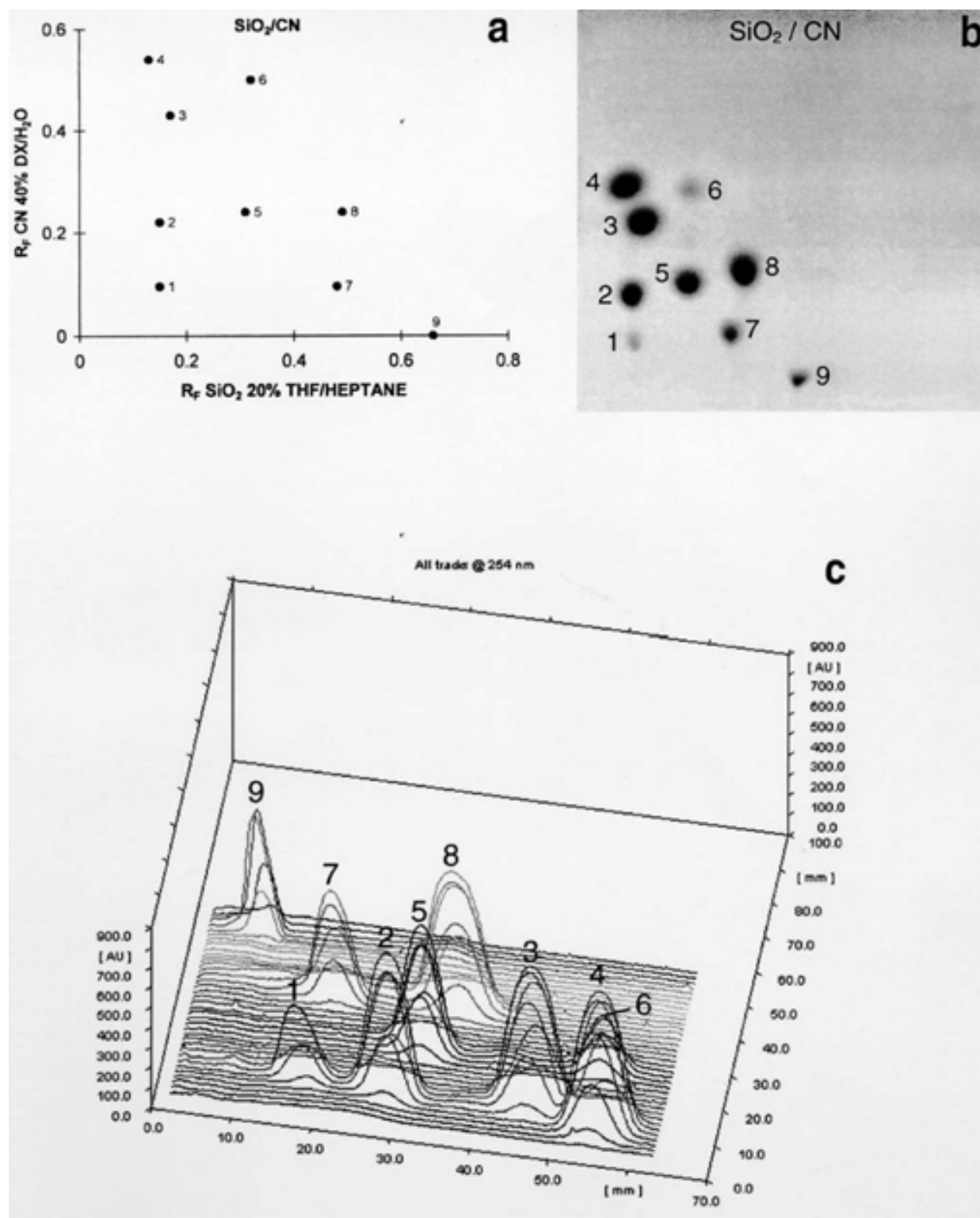

Fig. 20. (a) Correlation between normal-phase  $R_F$  values obtained with tetrahydrofuran-*n*-heptane, 20 + 80 (*v/v*), as mobile phase on silica and reversed-phase  $R_F$  values obtained with dioxane-water, 40 + 60 (*v/v*), as mobile phase on cyanopropyl layer. This pair of NP and RP systems was chosen for 2D TLC with adsorbent gradient. The videoscanned (b) and densitogram (c) of the plate show the separation achieved for the nine-component pesticide mixture (From Tuzimski, 2005. With permission.).

performed, second, reversed-phase (RP), development was performed on HPTLC RP18W F<sub>254S</sub> plates or HPTLC CN F<sub>254S</sub> plates (**Figure 20a**). **Figure 20b** shows the videoscans and **Figure 20c** shows the densitogram; complete separation of the components of the mixture of pesticides is apparent.

#### 2.3.2.4 Combination of Multidimensional Planar Chromatography (MDPC)

Very difficult separations of multicomponent mixtures of compounds require the application of multidimensional planar chromatography combining different separation systems. A new procedure for separation of complex mixtures by combination of different modes of multidimensional planar chromatography were described (Tuzimski, 2008a; Tuzimski, 2007b). By the help of this new procedure 14 or 22 compounds from a complex mixture were separated on 10 cm x 10 cm TLC and HPTLC plates (Tuzimski, 2008; Tuzimski, 2007b). In **Figure 21** an example of this procedure is presented step by step for separation of 22 compounds from complex mixtures on TLC plate (Tuzimski, 2008a).

Silica is the most popular and least expensive adsorbent used in planar chromatography, and has an excellent separation power. In the first part of experiments, solvent systems for silica stationary phase were selected to assign the investigated pesticides to groups of compounds based on the solvent classification by Snyder (Snyder, 1978) and the 'Prisma Method' described by Nyiredy and coworkers (Dallenbach-Tölke et al., 1986; Nyiredy et al., 1988; Nyiredy et al., 1989; Nyiredy et al., 1995). For the selection of suitable mobile phases, the first experiments were carried out on TLC silica plates in unsaturated chromatographic chambers with ten solvents (diethyl ether, 2-propanol, ethanol, tetrahydrofuran, acetic acid, dichloromethane, ethyl acetate, dioxane, toluene, and chloroform) from the eight groups of Snyder's solvent-selectivity triangle for normal phase (NP) chromatography according to their properties as proton acceptors, proton donors, and their dipole interactions. The literature data (Stahl, 1967) show that the most widely applied solvent classes for NP planar chromatography are from the corners of Snyder's solvent-selectivity triangle (groups I, VII, and VIII) and from group VI (ethyl acetate, methyl ethyl ketone, dioxane, acetone, acetonitrile) where all three effects (proton acceptor, proton donor and dipole interaction) are practically equalized; the solvents from group VI have a special function in the optimization of the mobile phase (Nyiredy, 1997).

Next, the solvent strength has to be either reduced or increased, so that the  $R_F$  values of investigated compounds lie between 0.2 and 0.8. If the solvents afford good separation, other solvents from the same group were also tested. Good results (**Figure 22**) were obtained with ethyl acetate-*n*-heptane, 40:60 (v/v), as mobile phase in first direction; this separated the pesticides into five groups, the first containing compounds 1-4, the second containing 5-7, the third containing 8-12, the fourth containing 13-17, and fifth containing 18-22.

The objective of the next series of experiments of the study reported in this paper was to investigate the separation of components of the five groups of pesticides. For optimization of the mobile phases for separation of pesticides in all five groups the suitable solvents are selected by the procedure described above (Dallenbach-Tölke et al., 1986; Nyiredy et al., 1988; Nyiredy et al., 1989; Nyiredy et al., 1995). If the spots of pesticides on the plate migrate too far ( $R_F$  values of investigated compounds are above 0.7) the solvent strength must be reduced by addition of heptane (or hexane) to the mobile phase. Conversely, if the spots of compounds on the plate do not migrate far enough ( $R_F$  values of pesticides are between 0 and 0.3) the solvent strength must be increased by addition of a stronger solvent (e. g., methanol, acetic acid, water).

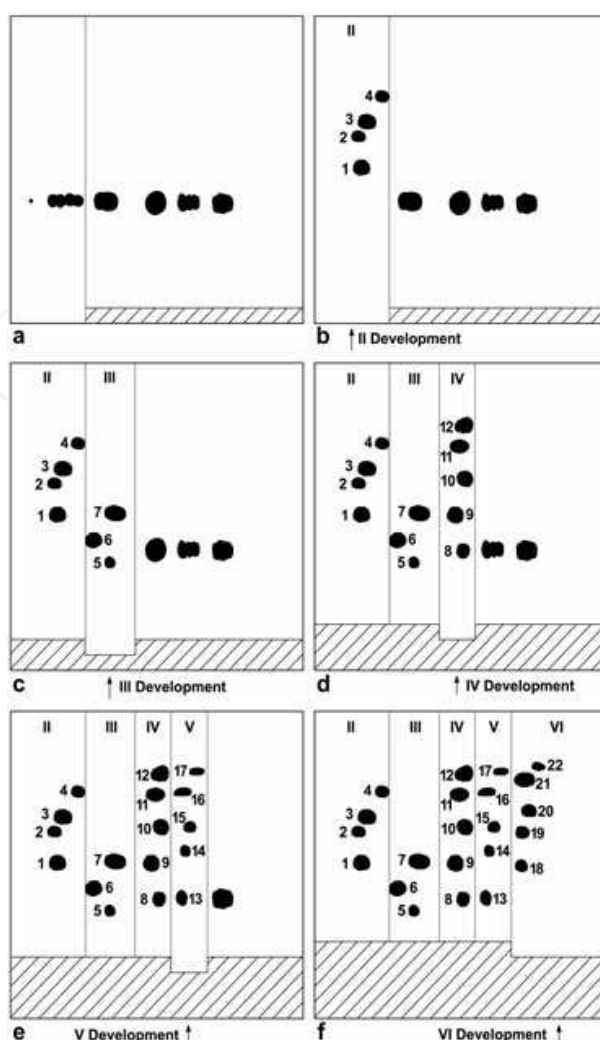

Fig. 21. Illustration of step by step selective multidimensional planar chromatographic separation. (a) The dried plate after the first separation (1st development) prepared for separation of the first group of compounds. One line (approx. 1 mm thick) is scraped in the stationary phase perpendicular to the first development, in such a way that the spot(s) of the target compounds are between the line and the edge of plate. For separation of the first group of compounds another 5-mm wide region of the silica gel layer removed from the bottom of the plate (the hatched lines indicate the stationary phase removed) so that in the next step mobile phase runs only up a narrow strip of adsorbent. (b) The dried plate after separation of the first group of pesticides (1–4) by use of acetonitrile–chloroform, 15:85 ( $v/v$ ), as mobile phase in the 2nd development. (c) The prepared and dried plate after separation of the components of the second group of pesticides (5–7) by development with 100% chloroform twice over the same distance (UMD). (d) The prepared and dried plate after separation of the five components of the third group of pesticides (8–12) with nitromethane–dichloromethane, 5:95 ( $v/v$ ), as mobile phase in the 4th development. (e) The prepared and dried plate after separation of the five components of next group of pesticides (13–17) with nitromethane–chloroform, 5:95 ( $v/v$ ), as mobile phase in the 5th development. (f) The prepared and dried plate after separation of the five components of last group of pesticides (18–22) with toluene – *n*-heptane, 70:30 ( $v/v$ ), as mobile phase in the 6th development (From Tuzimski, 2008a. With permission.).

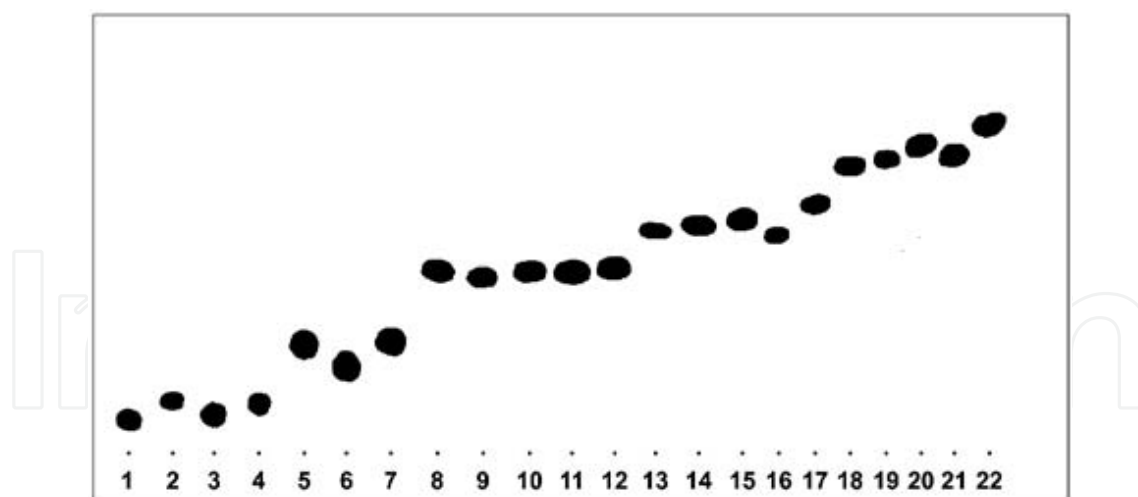

Fig. 22. Separation of 22 pesticides into five groups - compounds 1-4, 5-7, 8-12, 13-17, and 18-22 on a silica TLC plate with ethyl acetate-*n*-heptane, 40:60 (*v/v*), as mobile phase (From Tuzimski, 2008a. With permission.).

After optimization of the mobile phases for separation of the components of all groups of pesticides these mobile phases were used for multidimensional planar chromatography (**Figures 21a-21f**).

Mixtures of pesticides were applied as spots, 1 cm from the bottom and 3.5 cm from the left edge of the plate. TLC plates were developed in the first dimension (step I) with ethyl acetate-*n*-heptane, 40:60 (*v/v*), as normal-phase eluent. HPTLC plates were developed in the first dimension (step I) with ethyl acetate-*n*-heptane, 50:50 (*v/v*), as normal-phase eluent. After drying in air for 20 min the plates were turned by 90° (so that the partly separated components of the complex mixture of compounds were on the start line of the next step). Next, one or two lines (approx. 1 mm wide) were scraped in the adsorbent layer perpendicular to the direction of the first development, so the spot(s) of the target compounds were between the lines. Some of the adsorbent layer (approx. 5 mm wide) must be removed, to ensure that the mobile phase of the second development (step II) develops only the spot(s) of the target compounds between the two lines. Next, all the plate and stationary phase except the part to be developed was covered by glass plates which were fixed with clamps. This procedure was repeated in subsequent steps (steps III-VI). Before each of steps III to VI a region of the adsorbent layer must again be removed from the plate to ensure that the mobile phase only develops the zone of group of compounds of interest. (The regions removed before each development are shown by the hatched lines in **Figure 21**). The plates were developed in an unsaturated vertical chamber in MDPC experiment (**Figures 21a-21f**). To prevent the eluent from migration on adsorbent with constituents that are not aimed to be chromatographed during the particular step, the part of the plate, from which the adsorbent was removed, can be covered with lipophilic substance (wax). In this case, the plates can be developed in horizontal chamber in MDPC experiments.

The compounds from the first group (1-4) were chromatographed with acetonitrile-chloroform, 15:85 (*v/v*), as mobile phase (**Figure 21b**). The pesticides in the second group (5-7) were chromatographed twice with chloroform as mobile phase over the same distance (**Figure 21c**). The plate was dried for approximately 5 min between the two steps. The plate was then dried after the second separation of compounds of this group. Another portion of the stationary phase (the next 5 mm - hatched lines on **Figure 21d**) was then removed, to

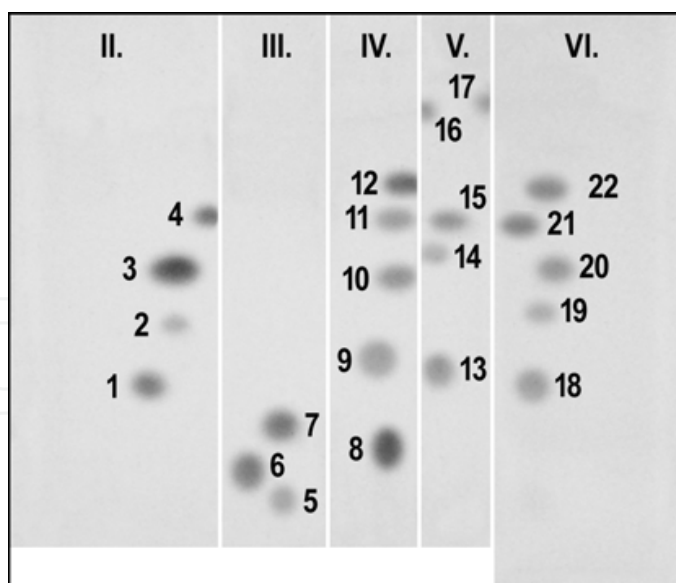

Fig. 23. Videoscans at 254 nm of the silica HPTLC plate showing separation of the 22 components of a complex mixture by developments I-VI in multidimensional planar chromatography (From Tuzimski, 2008a. With permission.).

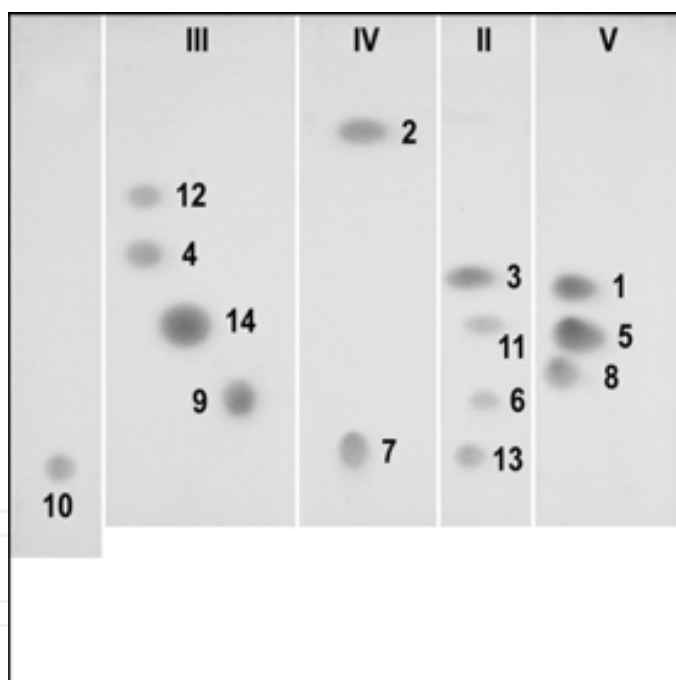

Fig. 24. Videoscans at 254 nm showing complete separation of the mixture of fourteen pesticides by multidimensional planar chromatography (MDPC) (From Tuzimski, 2007b. With permission).

ensure that the mobile phase used for development IV (**Figure 21d**) affected only the spots of the next group of compounds (8-12) between the two lines. Separation of components 13-17 with nitromethane- chloroform, 5:95 (v/v), as mobile phase in the next step on the TLC plate is depicted in **Figure 21e**. Separation of pesticides of the last group (18-22) with toluene-n-heptane, 70:30 (v/v), as mobile phase is depicted in **Figure 21f**. Separation of 22

components from a complex mixture by developments I–VI by multidimensional planar chromatography was also achieved on a silica HPTLC plate. The best results were obtained with ethyl acetate–n-heptane, 50:50 (v/v), as mobile phase in first direction, which separated the pesticides into five groups (1–4, 5–7, 8–12, 13–17, and 18–22). A videoscans of the multidimensional separation of the 22 components on a silica HPTLC plate is shown in **Figure 23** (Tuzimski, 2008a). The separation can be characterized as PC × (PC + nPC + PC + PC + PC)''.

Also videoscans (**Figure 24**) was performed showing a complete separation of the next 14-component mixture of pesticides in the I–Vth developments by multidimensional planar chromatography [PC × (nPC + PC + PC + PC)] (Tuzimski, 2007b).

### 2.3.2.5 Multidimensional Planar Chromatography in combination with Diode-Array Scanning Densitometry (MDPC-DAD) and High-Performance Liquid Chromatography Coupled with Diode-Array Detection (HPLC-DAD)

The best combination for multidimensional planar chromatography is the parallel combination of stationary and mobile phases. In the next mode of multidimensional planar chromatography the separations of multicomponent mixtures were realized on multiphase plates. Also the largest differences were obtained by combination of normal-phase systems of the type silica/nonaqueous eluent in the first step of MDPC and reversed-phase systems of the type octadecyl silica/water + organic modifier (methanol, acetonitrile, dioxane) in the next steps of MDPC on multiphase plates, e.g., with a narrow zone of SiO<sub>2</sub> and a wide zone of RP-18 (or vice versa) which are commercially available from Whatman (Multi K SC5 or CS5 plates) (Tuzimski, 2010a). Multidimensional planar chromatography (MDPC) is performed by spotting the multicomponent mixture in the corner of a square chromatographic plate (20 cm × 20 cm) and by development in the first direction with the first eluent on the narrow zone of SiO<sub>2</sub> (Multi K SC5 plate) or octadecyl silica (Multi K CS5 plate). After the development is completed the chromatographic plate is then removed from the developing chamber and the solvent is allowed to evaporate from the layer. The plate is rotated through 90° and then different solvents are used in the next steps which are perpendicular to the direction of the first development. The procedure for these steps is the easier as procedure described above and showed in **Figure 21a–f** (Tuzimski, 2010a), because in all the steps MDPC on the Multi K SC5 or CS5 plates the part to be developed was not covered by glass plates. Example MDPC procedure on Multi-K SC5 or CS5 plates are presented in **Figures 25** and **26**.

As shown in **Figure 26**, during step B the SC5 plates were developed until concentration in one band of the disturbing compounds of the extract on the border between the silica and octadecyl silica zones. This band was moved on to the second layer of adsorbent whereas only the clofentezine remained on the first layer of adsorbent and carefully separated from other compounds. During step B on CS5 the clofentezine was moved on to the second adsorbent (silica) whereas the other components of the extract remained on the first layer (octadecyl silica). These bands were concentrated on the border between the zones of adsorbents (**Figure 25**). It must be remembered that the Multi-K plates are especially useful for analysis of pesticides in multicomponent mixtures, e.g. in plant extracts, by MDPC.

In another mode of MDPC the separations of mixtures were realized on a monolayer of, e.g., silica. Separations of compounds were performed on polar stationary phases with a non-aqueous eluent (step A or in both A and B steps) and with partly aqueous eluents (step B) in the next step of MDPC. Application of multidimensional planar chromatography

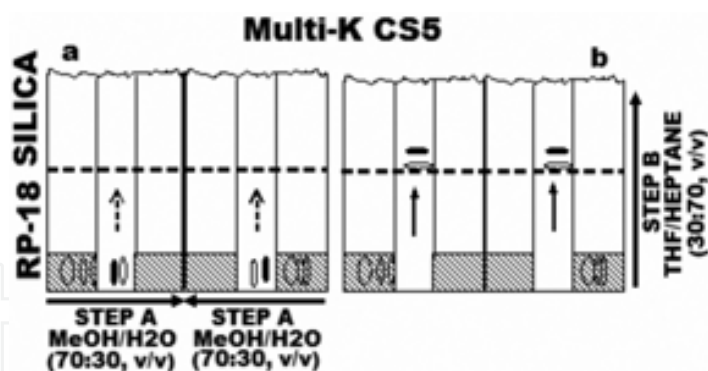

Fig. 25. Step-by-step illustration of selective multidimensional planar chromatography (MDPC) for clofentezine separation on bilayer Multi-K CS5 plate. (a) Dried plate after first separation (step A) by use of 70:30 (*v/v*) methanol-H<sub>2</sub>O. Plate prepared for separation of the group of compounds with clofentezine (black band in figure) from Herba Thymi extract (left side) and extract of Herba Thymi fortified by clofentezine (right side): two lines (about 1 mm wide) are scraped in the stationary phase perpendicular to the first development, in such a way that the bands of clofentezine are between the lines. For separation of the group of compounds a 5-mm wide area of the octadecyl silica layer (RP-18) is removed from the plate (hatched lines indicate the part of stationary phase removed) such that in step B mobile phase runs only in a narrow strip of adsorbent. (b) The Multi-K CS5 plate after step B, development with 30:70 (*v/v*) tetrahydrofuran-*n*-heptane as mobile phase for separation of clofentezine in the Herba Thymi extract (left side) and the Herba Thymi extract fortified with clofentezine (right side). Both clofentezine bands are black in the figure (From Tuzimski, 2010a. With permission).

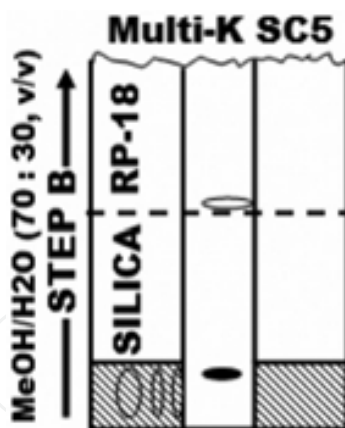

Fig. 26. Illustration of chromatogram obtained by multidimensional planar chromatography (MDPC) for clofentezine separation on bilayer Multi-K SC5 plate after step B with 70:30 (*v/v*) methanol-H<sub>2</sub>O. Before step B, the Multi-K SC5 plate was prepared for separation of the group of compounds with clofentezine (black band) from Herba Thymi extract. Two lines are scraped in the stationary phase (approx. 1 mm wide) perpendicular to the first development, in such a way that the clofentezine band was between the lines. For separation of the group of compounds a 5-mm wide area of the silica gel layer is removed from the plate (hatched lines indicate the part of stationary phase removed) such that in step B mobile phase runs only in a narrow strip of adsorbent (From Tuzimski, 2010a. With permission).



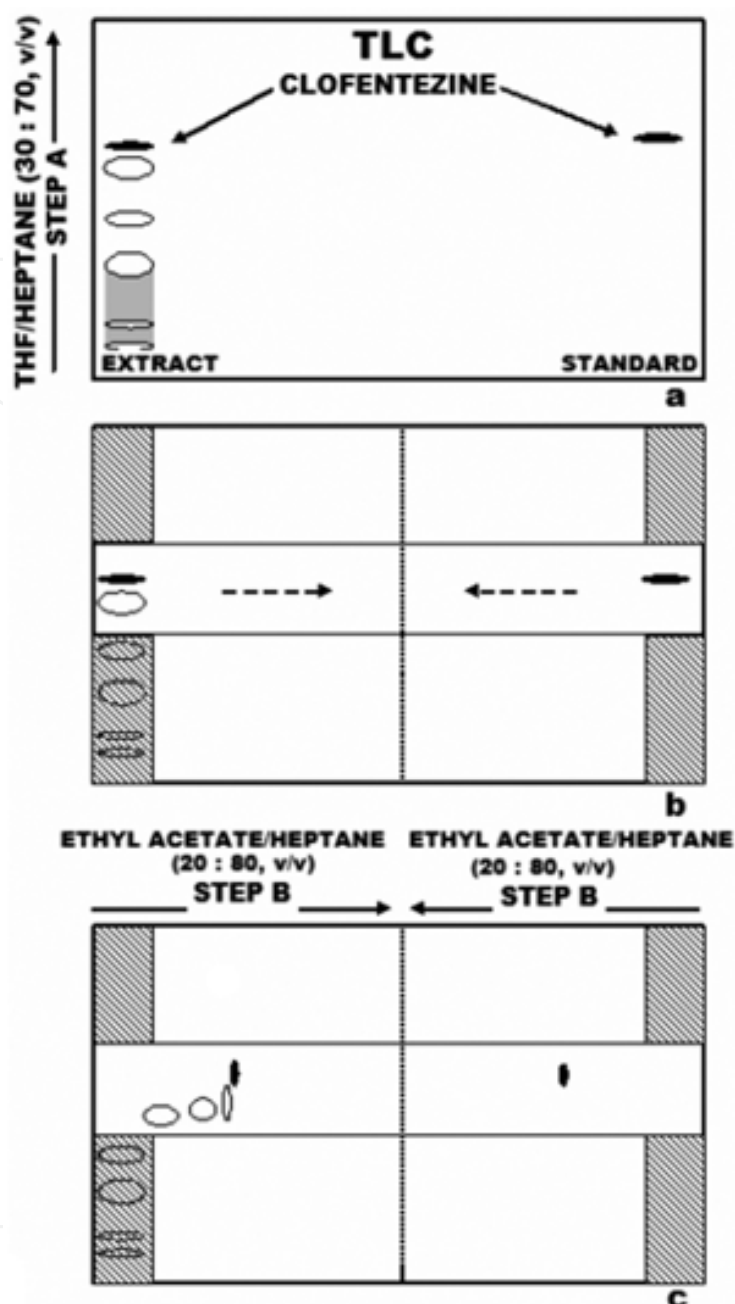

Fig. 27. Illustration of step-by-step selective multidimensional planar chromatography (MDPC) for separation of clofentezine in Herba Thymi extract. (a) Dried plate after the first separation (step A) by use of 30:70 ( $v/v$ ) tetrahydrofuran-*n*-heptane. (b) Plate prepared for separation of the second group of compounds with clofentezine (black band on figure) and clofentezine standard: two lines are scraped in the stationary phase (about 1 mm wide) perpendicular to the first development, in such a way that the bands of clofentezine are between these lines. For separation of the second group of compounds a 5-mm wide area of the silica gel layer is removed from the plate (hatched lines indicate part of stationary phase removed) such that in the next step mobile phase runs only in a narrow strip of adsorbent. (c) Dried plate after separation of the second group with clofentezine and clofentezine standard (both black bands) by use of 20:80 ( $v/v$ ) ethyl acetate-*n*-heptane as mobile phase (step B) to half of plate from opposite sides (From Tuzimski, 2010a. With permission).

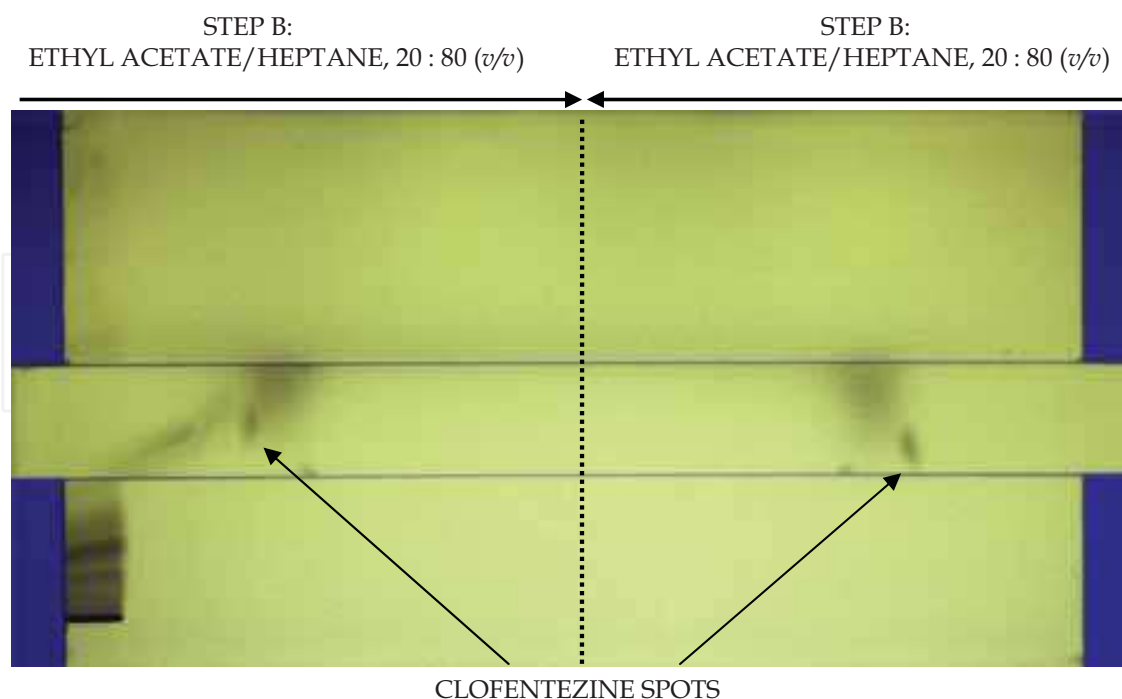

Fig. 28. Picture at 254 nm of dried plate after separation of the second group with clofentezine and standard of clofentezine by using ethyl acetate-*n*-heptane (20:80, v/v) as mobile phase (step B) to half of plate length from opposite sides (From Tuzimski, 2010b. With permission).

(MDPC) with different systems in steps, e.g., adsorption chromatography (step A) and hydrophilic interaction chromatography (HILIC) or ion exchange (step A) adsorption (step B) is especially useful for correct identification of components of difficult, complicated mixtures, e.g., pesticides in plant extracts. **Figures 27 and 28** shows MDPC mode on silica layer. MDPC combined with different modes of scanning, e.g., with diode array detection (MDPC-DAD) or mass spectrometry (MDPC-MS) enables quantitative analysis. Application of multidimensional planar chromatography and modern fiber optical TLC densitometric scanners with DAD are especially useful for correct identification of components of difficult, complicated mixtures, e.g., plant extracts. Comparison of contour plots obtained from the extract of *Herba Thymi* containing clofentezine after steps A and B are presented in **Figures 29a** and **29 b**. The procedure described for the separation of complex mixtures of compounds is inexpensive and can be applied to routine analysis of analytes in samples of natural origin, e.g., in water or plant extracts, after preliminary clean-up and concentration, e.g., by solid-phase extraction (SPE). The identification of analytes was confirmed by the comparison of the UV spectra of the components of plant extracts and standards of analytes by DAD densitometer (Tuzimski, 2010a,b) (**Figure 30**). The peak purity index is a numerical index for the quality of the coincidence between two datasets. It is given by the least-squares-fit coefficient calculated for all intensity pairs in the two datasets under consideration. The following equation is applied:

$$P = \frac{\sum_i (s_i - \bar{s})(r_i - \bar{r})}{\sqrt{\sum_i (s_i - \bar{s})^2 \sum_i (r_i - \bar{r})^2}} \quad (1)$$

where  $s_i$  and  $r_i$  are the respective intensities for the same abscissa value,  $i$  is the number of data points, and  $S$  and  $R$  are the average intensities of the first and second dataset.

A peak purity index has values in the range from 0 to 1. A peak-purity index of 1 indicates that the compared spectra are identical. The components of two mixtures of pesticides, which were separated by 2D-TLC with adsorbent gradients of the type silica-wettable with water octadecyl silica or silica-cyanopropyl, were identified by  $R_F$  in both chromatographic systems and by comparison of UV spectra (Tuzimski, 2005).

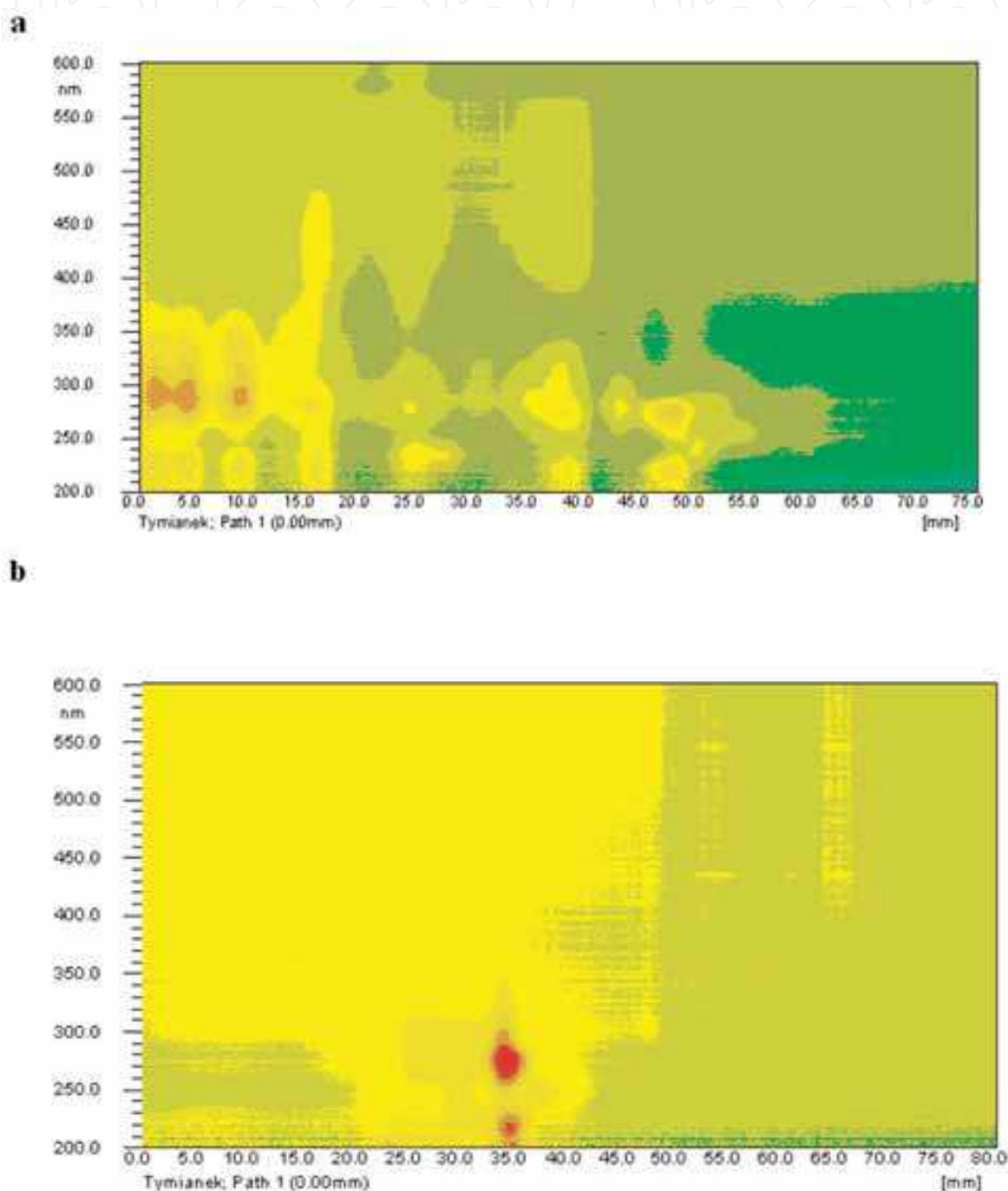

Fig. 29. Contour plots obtained from extract of Herba Thymi containing clofentezine: (a) after step A, (b) after step B (silica plate) (From Tuzimski, 2010a. With permission).

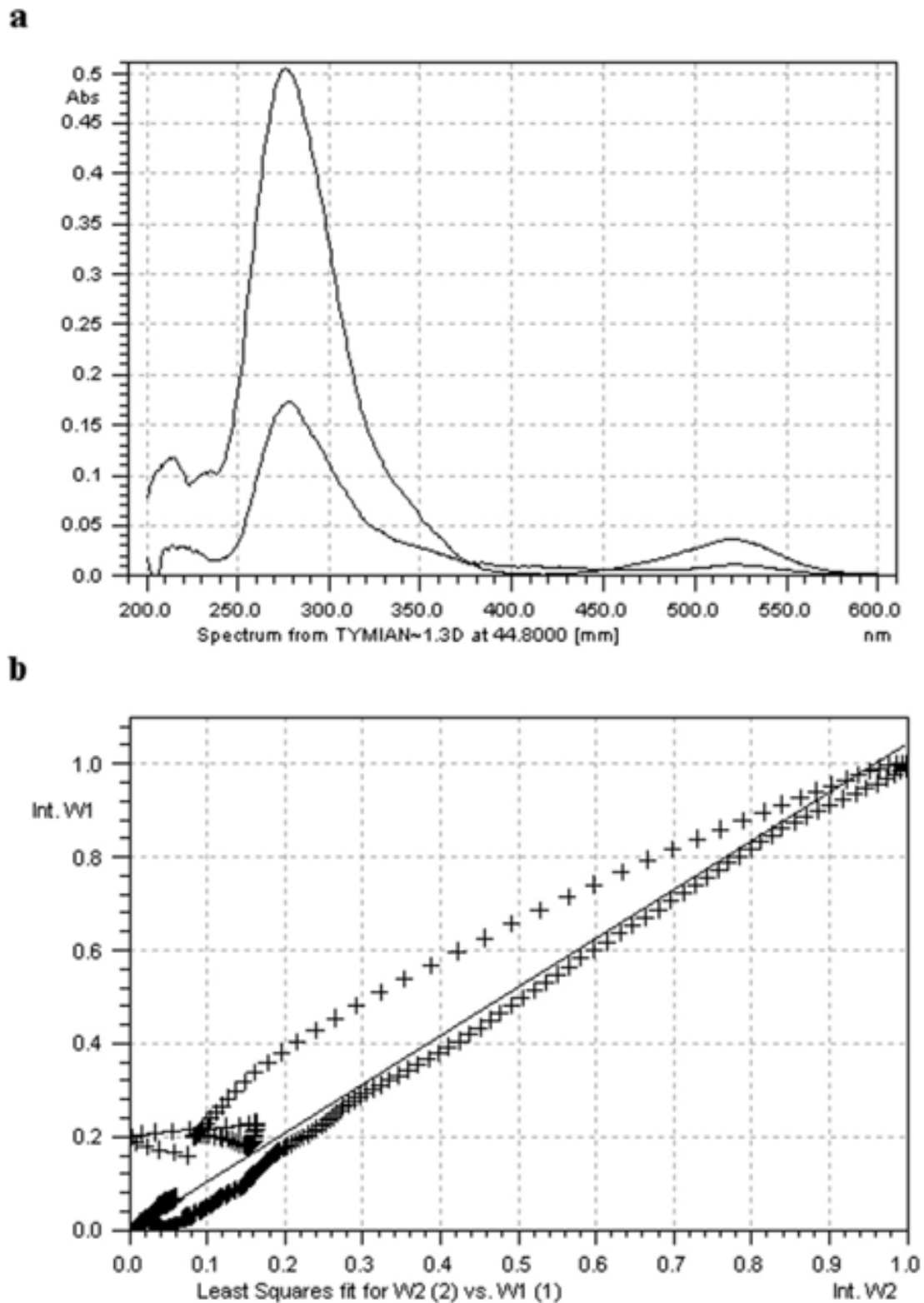

Fig. 30. (a) Comparison of UV spectrum of clofentezine found in Herba Thymi extract with UV spectrum of clofentezine standard from library. (b) Correlation curve of peak purity of spectra of clofentezine found in extract Herba Thymi and that of clofentezine standard (library) after step B. The purity index (*Pearson's r*) for the compared spectra was 0.9781 (From Tuzimski, 2010a. With permission).

Heart-cut spots of analytes from the stationary phase were also injected on e.g., a C18 column and analysed by HPLC-DAD (**Figures 31 and 32a**). Analyte identification was accomplished on the basis of the retention times of the analytes and by comparison of the UV spectrum of the reference compound in the library and the UV spectrum of the detected peak of the sample. A match equal or higher than 990 was fixed to confirm identification between both spectra for all the analytes determined (Tuzimski, 2008b,c; Tuzimski, 2009; Tuzimski & Sobczyński, 2009; Tuzimski, 2010a-c).

**Figure 32c** shows the purity of the pesticide peak after step B (Tuzimski, 2010a). The LOD and LOQ for clofentezine were 0.23 and 0.70  $\mu\text{g}$  per spot (TLC-DAD), and 0.35 and 1.06  $\mu\text{g}/\text{mL}$ , (HPLC-DAD), respectively. The method recovery was studied by analyzing five replicates of samples spiked with clofentezine at four concentrations levels (4.5, 6, 9 and 12  $\mu\text{g}/\text{g}$  in plant material). Average recoveries from the spiked samples, and the SD, were  $55.8\% \pm 4.5$  and  $44.5\% \pm 6.5$  (SPE: C18/SDB-1, THF eluates) after step B determined by MDPC-DAD and HPLC-DAD, respectively. The methanol eluates contained traces of clofentezine ( $<0.09\%$ ). The determined quantity of the clofentezine in the extract of *Herba Thymi* (*T. vulgaris* L., Lamiaceae) ranged from 0.78 to 0.86  $\mu\text{g}/\text{g}$  in plant material ( $n=7$ ) in samples from the year 2009. The suggested procedure is efficient and uncomplicated. It allows to analyze the quantity of clofentezine in medical herbs without the necessity of applying additional purifying and absorbents (silica or Florisil) of the matrix in SPE. Moreover, it does not necessitate the use of additional columns in HPLC experiments to purify the matrix from the ballast substances (Tuzimski, 2010b).

Multidimensional planar chromatography can be used for identification of known and unknown compounds, and – at least equally important – for correct identification of analytes in a variety of samples, e.g., clofentezine in *Herba Thymi*. MDPC has many advantages, for example wide possibilities of optimization of the chromatographic system, special development modes, diverse detection methods, and low-cost analysis of samples, requiring minimal sample cleanup.

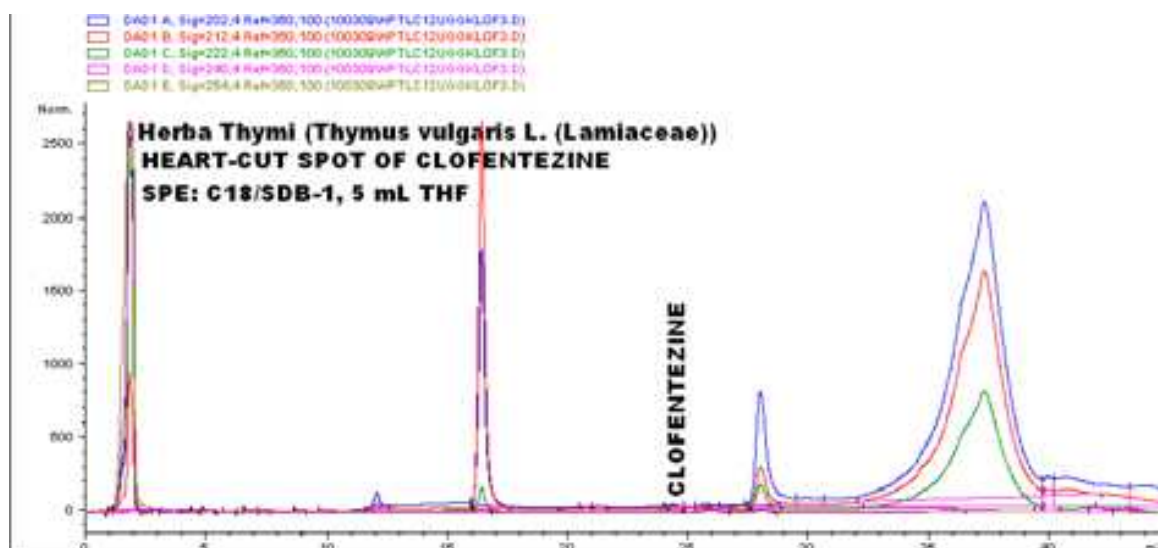
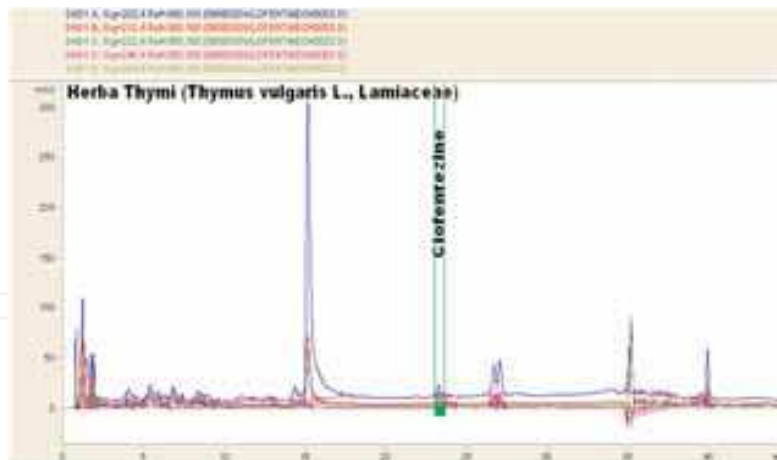

Fig. 31. Chromatogram obtained from heart-cut spot of clofentezine from extract *Herba Thymi* (*T. vulgaris* L., Lamiaceae) sample after SPE with C18/SDB-1 cartridge and MDPC-DAD (step B). HPLC-DAD showing detected and quantified clofentezine (From Tuzimski, 2010b. With permission).



(a)



(b)

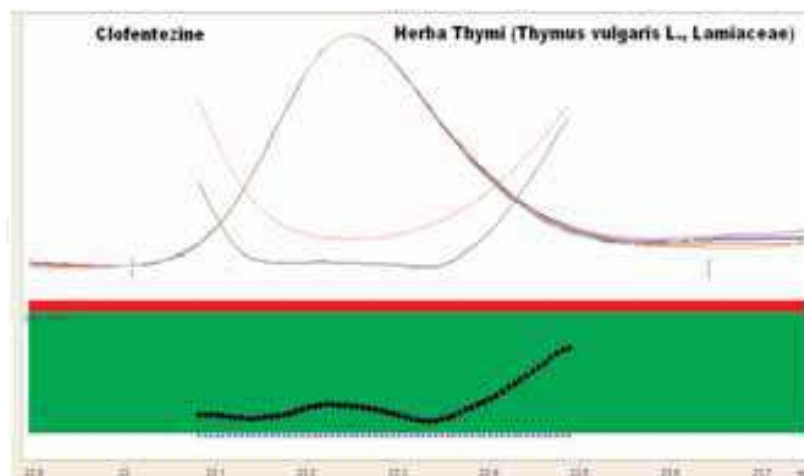

(c)

Fig. 32. (a) Chromatogram obtained from heart-cut spot of clofentezine from extract of Herba Thymi (*T. vulgaris* L., Lamiaceae) sample after SPE with C18/SDB-1 cartridge and MDPC-DAD (step B). (b) HPLC-DAD showing detected and quantified clofentezine. (c) Purity of HPLC peak obtained for clofentezine in Herba Thymi extract after step B (From Tuzimski, 2010a. With permission).

### 3. Conclusions

Multidimensional chromatography techniques represent a powerful tool and alternative procedure to classical one-dimensional chromatographic methods with optimum efficiency and selectivity for the separation of the component of interest, e.g., pesticides. Multidimensional gas chromatography (MDGC) is recommendable for separation and quantitative analysis of volatile and semi-volatile analytes, while multidimensional liquid chromatography (MDLC) and multidimensional planar chromatography (MDPC) are suitable for qualitative and quantitative analysis of non-volatile pesticides from different classes. The new multidimensional methods with fast scanning detectors should enable us to detect and determine many more analytes in original samples and continue to improve modern analytical methods for better research to control the environment for persistent pesticides.

### 4. Acknowledgements

The investigations were financially supported by a grant (No N N204 167136, 2009-2011) of the Ministry of Science and Higher Education, Poland (see references: Tuzimski T. (2010a-c)).

### 5. References

- Bertsch, W. (1990). Multidimensional gas chromatography, In: Multidimensional Chromatography. Techniques and applications, Cortes, H.J. (Ed.), Chromatographic Science Series, Vol. 50, pp. 74-144, Marcel Dekker, New York.
- Bertsch, W. (1999). Two-dimensional gas chromatography. Concepts, instrumentation, and applications - Part 1: Fundamentals, conventional two-dimensional gas chromatography, selected applications. HRC Journal of High Resolution Chromatography, 22, 12, 647-665.
- Bertsch, W. (2000). Two-dimensional gas chromatography. Concepts, instrumentation, and applications - Part 2: Comprehensive two-dimensional gas chromatography. HRC Journal of High Resolution Chromatography, 23, 3, 167-181.
- De Brabander, H.F.; Smets, F.; Pottie, G. (1988). Faster and cheaper two-dimensional HPTLC using the "4 x 4" mode. J. Planar Chromatogr. – Mod. TLC, 1, 369-371.
- Commission Directive 2003/13/EC, Off. J. Eur. Commun. L41 (2003) 33.
- Commission Directive 2003/14/EC, Off. J. Eur. Commun. L41 (2003) 37.
- Council Directive 98/83/EC, Off. J. Eur. Commun. L 330 (1998) 32.
- Corradini, C. (2002). Coupled-Column Liquid Chromatography, In: Multidimensional Chromatography, Mondello, L.; Lewis, A.C.; Bartle K.D. (Eds), pp. 109-134, John Wiley & Sons, Ltd, ISBN 0-471-98869-3, Chichester, England.
- Dallenbach-Tölke, K.; Nyiredy, Sz.; Meier, B.; Sticher, O. (1986) J. Chromatogr., 365, 63 – 72.
- Dallüge, J.; Rijn, M.; Beens, J.; Vreuls, R.J.J.; Brinkman, U.A.Th. (2002). Comprehensive two-dimensional gas chromatography with time-of-flight mass spectrometric detection applied to the determination of pesticides in food extracts. J. Chromatogr. A, 965, 1-2, 207-217.
- Dallüge, J.; Beens, J.; Brinkman, U.A.Th. (2003). Comprehensive two-dimensional gas chromatography: A powerful and versatile analytical tool. J. Chromatogr. A, 1000, 1-2, 69-108.
- Deans, R.R. (1968). A new technique for heart cutting in gas chromatography. Chromatographia, 1, 18, 18-22.

- Dzido, T.H. (2001). Modern TLC chamber, In: *Planar Chromatography, a Retrospective View for the Third Millennium*, Nyiredy, Sz. (Ed), pp. 69-87, Springer Scientific Publisher, Budapest.
- Focant, J.-F.; Sjödin, A.; Patterson Jr., D.G. (2003). Qualitative evaluation of thermal desorption-programmable temperature vaporization-comprehensive two-dimensional gas chromatography-time-of-flight mass spectrometry for the analysis of selected halogenated contaminants. *J. Chromatogr. A*, 1019, 1-2, 143-156.
- De Geus, H.-J.; De Boer, J.; Brinkman, U.A.Th. (1996). Multidimensionality in gas chromatography. *Trends Anal. Chem.*, 15, 398-408.
- Giddings, J. C. (1984). Two-dimensional separation: concepts and promise. *Anal. Chem.* 56, 1258A-1270A.
- Giddings, J. C. (1987). Concepts and comparison in multidimensional separation. *J. High Resolut. Chromatogr. Chromatogr. Comm.*, 10, 319-323.
- Giddings, J. C. (1990). Use of Multiple Dimensions in Analytical Separations, In: *Multidimensional Chromatography*, Cortes, H.J. (Ed.), pp. 251-299, Marcel Dekker, New York.
- Gonnord, M.F.; Levi, F.; Guiochon, G. (1983). Computer assistance in the selection of the optimum combination of systems for two-dimensional chromatography. *J. Chromatogr.*, 264, 1-6.
- Harynuk, J.; Górecki, T.; de Zeeuw, J. (2005). Overloading of the second-dimension column in comprehensive two-dimensional gas chromatography. *J. Chromatogr. A*, 1071, 1-2, 21-27.
- Hogendoorn, E.A.; van Zoonen, P.; Brinkman, U.A.Th. (1991). Column-switching RPLC for the trace-level determination of ethylenethiourea in aqueous samples. *Chromatographia*, 31, 5-6, 285-292.
- Hogendoorn, E.A.; Hoogerbrugge, R.; Baumann, R.A.; Meiring, H.D.; de Jong, A.P.J.M.; van Zoonen, P. (1996). Screening and analysis of polar pesticides in environmental monitoring programmes by coupled-column liquid chromatography and gas chromatography-mass spectrometry. *J. Chromatogr. A*, 754, 1-2, 49-60.
- Hogendoorn, E.A.; Westhuis, K.; Dijkman, E.; Heusinkveld, H.A.G.; den Boer, A.C.; Evers, E.A.I.M.; Baumann, R.A. (1996). Semi-permeable surface analytical reversed-phase column for the improved trace analysis of acidic pesticides in water with coupled-column reversed-phase liquid chromatography with UV detection. Determination of bromoxynil and bentazone in surface water. *J. Chromatogr. A*, 858, 1-2, 45-54.
- Khummueng, W.; Trenerry, C.; Rose, G.; Marriott, P.J. (2006). Application of comprehensive two-dimensional gas chromatography with nitrogen-selective detection for the analysis of fungicide residues in vegetable samples. *J. Chromatogr. A*, 1131, 1-2, 203-214.
- De Koning, S.; Gumpendobler, M. (2007). Determination of 287 pesticides at trace levels by GC x GC-TOFMS. Life Science and Chemical Analysis Solutions. Leco Corporation, Form No. 203-821-327.
- Leco Corporation (2008). Form No. 209-183.  
[http://www.leco.com/products/sep\\_sci/pegasus\\_4d/pegasus\\_4d.htm](http://www.leco.com/products/sep_sci/pegasus_4d/pegasus_4d.htm).
- Lewis, A.C. (2002). Multidimensional High Resolution Gas Chromatography, In: *Multidimensional Chromatography*, Mondello, L.; Lewis, A.C.; Bartle K.D. (Eds), pp. 47-75, John Wiley & Sons, Ltd, ISBN 0-471-98869-3, Chichester, England.
- Liu, Z.; Phillips, J.B. (1991). Comprehensive two-dimensional gas chromatography using an on-column thermal modulator interface. *J. Chromatogr. Sci.*, 29, 227-231.



- Mariott, P.J. (2002). Orthogonal GC-GC, In: *Multidimensional Chromatography*, Mondello, L.; Lewis, A.C.; Bartle K.D. (Eds), pp. 77-108, John Wiley & Sons, Ltd, ISBN 0-471-98869-3, Chichester, England.
- Muñoz-Arnanz, J.; Bosch, C.; Fernandez, P.; Grimalt, J.O.; Jimenez, B. (2009). Optimization of a heart-cutting multidimensional gas chromatography-based method for the assessment of enantiomeric fractions of o,p'-DDT in environmental samples. *J. Chromatogr. A*, 1216, 6141-6145.
- Murphy, R.E.; Schure, M.R.; Foley, J.P. (1998). Effect of sampling rate on resolution in comprehensive two-dimensional liquid chromatography. *Anal. Chem.*, 70, 8, 1585-1594.
- Nurok, D.; Habibi-Goudarzi S.; Kleyle R. (1987). Statistical approach to solvent selection as applied to two-dimensional thin-layer chromatography, *Anal. Chem.*, 59, 2424-2428.
- Nurok, D. (1989). Strategies for optimizing the mobile phase in planar chromatography, *Chem. Rev.*, 89, 363-375.
- Nurok, D.; Kleyle, R.; McCain, C.L.; Risley, D.S.; Ruterbories, K.J. (1997). Statistical method for quantifying mobile phase selectivity in one- and two-dimensional overpressured layer chromatography, *Anal. Chem.*, 69, 1398-1405.
- Nyiredy, Sz.; Dallenbach-Tölke, K.; Sticher, O. (1989). *J. Liquid Chromatography & Related Technologies*, 12, 95.
- Nyiredy, Sz.; Fatér, Zs. (1995). *J. Planar Chromatogr. – Mod. TLC*, 8, 341 – 345.
- Nyiredy, Sz.; (1997). In: *Chromatography – Celebrating Michael Tswett's 125th Birthay*, Kaiser, O.; Kaiser, R.E.; Gunz, H.; Günther, W.; (Eds), pp. 231 – 239, InCom, Duesseldorf.
- Nyiredy, Sz.; Dallenbach-Tölke, K.; Sticher, O. (1998) *J. Planar Chromatogr. – Mod. TLC.*, 1, 336 – 342.
- Nyiredy, Sz.; (2001). (Ed.) *Planar Chromatography, a Retrospective View for the Third Millennium*, Springer Scientific Publisher, Budapest.
- Nyiredy, Sz. (2002). *Multidimensional Planar Chromatography*, In: *Multidimensional Chromatography*, Mondello, L.; Lewis, A.C.; Bartle K.D. (Eds), pp. 171-196, John Wiley & Sons, Ltd, ISBN 0-471-98869-3, Chichester, England.
- Nyiredy, Sz. (2003). *Multidimensional planar chromatography, LC•GC Eur.*, 16, 52-59.
- Pandey, R.C.; Misra, R.; Rinehart Jr. K.L. (1979) Graft thin-layer chromatography. *J. Chromatogr.*, 169, 129-139.
- Pesticides and the Environment, A Strategy for the Sustainable Use of Plant Protection Products and Strategy Action Plans*, <http://www.pesticides.gov.uk/uploadedfiles/Web Assets/PSD/PB11721 Pesticidesenvironment Lo.pdf>, Department for Environment, Food and Rural Affairs, London, United Kingdom.
- Phillips, J.B.; Xu, J. (1995). Comprehensive multidimensional gas chromatography. *J. Chromatogr.* 703, 327-334.
- Phillips, J.B.; Ledford, E.B. (1996). Thermal modulation: a chemical instrumentation component of potential value in improving portability. *Field Anal. Chem. Technol.*, 1, 23-29.
- Phillips, J.B.; Beens, J. (1999). Comprehensive two-dimensional gas chromatography: A hyphenated method with strong coupling between the two dimensions. *J. Chromatogr. A*, 856, 1-2, 331-347.
- Pizzutti, I.R.; Vreuls, R.J.J.; de Kok, A.; Roehrs, R.; Martel, S.; Friggi, C.A.; Zanella, R. (2009). Design of a compressed air modulator to be used in comprehensive

- multidimensional gas chromatography and its application in the determination of pesticide residues in grapes. *J. Chromatogr. A*, 1216, 15, 3305–3311.
- Poliak, M.; Kochman, M.; Amirav, A. (2008). Pulsed flow modulation comprehensive two-dimensional gas chromatography. *J. Chromatogr. A*, 1186, 1-2, 189–195.
- Proposed PAHO/WHO Plan of Action for Technical Cooperation in Food Safety, 2006–2007, <ftp://ftp.fao.org/docrep/fao/meeting/010/af272e.pdf>.
- Ramos, J.J.; González, M.J.; Ramos L. (2009). Comparison of gas chromatography-based approaches after fast miniaturised sample preparation for the monitoring of selected pesticide classes in fruits. *J. Chromatogr. A*, 1216, 43, 7307–7313.
- Ramsteiner, K. A. (1988). Systematic approach to column switching. *J. Chromatogr.*, 456, 3–20.
- Regnier, F.; Huang, G. (1996). Future potential of targeted component analysis by multidimensional liquid chromatography–mass spectrometry. *J. Chromatogr.*, 750, 3–10.
- Sancho-Llopis, J.V.; Hernandez-Hernandez, F; Hogendoorn, E.A.; van Zoonen, P. (1993). Rapid method for the determination of eight chlorophenoxy acid residues in environmental water samples using off-line solid-phase extraction and on-line selective precolumn switching. *Anal. Chim. Acta*, 283, 1, 287–296.
- Snyder, L.R. (1978). *J. Chromatogr. Sci.*, 16, 223 – 231.
- De Spiegeleer, B.; Van den Bossche, W.; De Moerlose, P.; Massart, D. (1987). A strategy for two-dimensional, high-performance thin-layer chromatography, applied to local anesthetics, *Chromatographia*, 23, 407–411.
- Stahl, E. (1967). (Ed) *Dünnschicht-Chromatographie, Ein Laboratoriumshandbuch*, Springer, Berlin.
- Status of active substances under EU review (doc. 3010), [http://europa.eu.int/comm/food/plant/protection/evaluation/stat\\_active\\_subs\\_3010\\_en.xls](http://europa.eu.int/comm/food/plant/protection/evaluation/stat_active_subs_3010_en.xls).
- Steinbrunner, J.E.; Johnson, E.K.; Habibi-Goudarzi, S.; Nurok, D. (1986). In: *Planar Chromatography Vol. 1*, Kaiser, R.E. (Ed.), Hüthig Verlag, Heidelberg.
- Szabady, B.; Nyiredy, Sz. (1996). The versatility of multiple development, in *Dünnschicht-Chromatographie in Memoriam Professor Dr. Hellmut Jork*, Kaiser, R.E.; Günther, W.; Gunz, H.; Wulff, G. (Eds.), pp. 212–224, InCom Sonderband, Düsseldorf.
- The Applicant Guide: Maximum Residue Levels, [http://www.pesticides.gov.uk/au\\_environment.asp?id=1251](http://www.pesticides.gov.uk/au_environment.asp?id=1251), The Pesticides Safety Directorate, York, United Kingdom.
- The Background and the Need for Change, <http://www.pesticides.gov.uk/environment.asp?id=1523>, The Pesticides Safety Directorate, York, United Kingdom.
- Tuzimski, T.; Soczewiński, E. (2002a). Retention and selectivity of liquid-solid chromatographic systems for the analysis of pesticides (Retention database of ca. 100 pesticides). In: *Problems of Science, Teaching and Therapy*. Medical University of Lublin, Poland, No 12, Lublin, October 2002, pp. 219.
- Tuzimski, T.; Soczewiński, E. (2002b). Chemometric characterization of the  $R_F$  values of pesticides in thin-layer chromatography on silica with mobile phases comprising a weakly polar diluent and a polar modifier. Part V, *J. Planar Chromatogr. - Mod. TLC*, 15, 164–168.
- Tuzimski, T.; Soczewiński, E. (2002c). Correlation of retention parameters of pesticides in normal- and reversed-phase systems and their utilization for the separation of a

- mixture of 14 triazines and urea herbicides by means of two-dimensional thin-layer chromatography, *J. Chromatogr. A*, 961, 277-283.
- Tuzimski, T.; Soczewiński, E. (2002d). Use of database of plots of pesticide retention ( $R_F$ ) against mobile-phase composition. Part I. Correlation of pesticide retention data in normal- and reversed-phase systems and their use to separate a mixture of ten pesticides by 2D-TLC, *Chromatographia*, 56, 219-223.
- Tuzimski, T., Bartosiewicz, A. (2003). Correlation of retention parameters of pesticides in normal and RP systems and their utilization for the separation of a mixture of ten urea herbicides and fungicides by two-dimensional TLC on cyanopropyl-bonded polar stationary phase and two-adsorbent-layer Multi-K plate. *Chromatographia*, 58, 781-788.
- Tuzimski, T. (2004). Separation of a mixture of eighteen pesticides by two-dimensional thin-layer chromatography on a cyanopropyl-bonded polar stationary phase, *J. Planar Chromatogr. - Mod. TLC*, 17, 328-334.
- Tuzimski T. (2005). Two-dimensional TLC with adsorbent gradients of the type silica-octadecyl silica and silica-cyanopropyl for separation of mixtures of pesticides, *J. Planar Chromatogr. - Mod. TLC*, 18, 349-357.
- Tuzimski T. (2007a). Separation of multicomponent mixtures of pesticides by graft thin-layer chromatography on connected silica and octadecyl silica layers, *J. Planar Chromatogr. - Mod. TLC*, 20, 13-18.
- Tuzimski T. (2007b). A new procedure for separation of complex mixtures of pesticides by multidimensional planar chromatography, *J. Separation Sci.*, 30, 964-970.
- Tuzimski T. (2008a). Strategy for separation of complex mixtures by multidimensional planar chromatography, *J. Planar Chromatogr. - Mod. TLC*, 21, 49-54.
- Tuzimski T. (2008b). Application of SPE-HPLC-DAD and SPE-TLC-DAD to the determination of pesticides in real water samples. *J. Sep. Sci.*, 31, 3537 - 3542.
- Tuzimski T. (2008c) Determination of Pesticides in Water Samples from the Wieprz-Krzna Canal in the Łęczyńsko-Włodawskie Lake District of Southeastern Poland by Thin-Layer Chromatography with Diode Array Scanning and High-Performance Column Liquid Chromatography with Diode Array Detection. *J. AOAC International*, 91, 5, 1203-1209.
- Tuzimski T. (2009). Application of SPE-HPLC-DAD and SPE-HPTLC-DAD to the Analysis of Pesticides in Lake Water. *J. Planar Chromatogr. - Mod. TLC*, 22, 4, 235-240.
- Tuzimski T, Sobczyński, J. (2009). Application of HPLC-DAD and TLC-DAD after SPE to the Quantitative Analysis of Pesticides in Water Samples. *J. Liquid Chromatography & Related Technologies*, 32, 1241-1258.
- Tuzimski T. (2010a). New Procedure for Analysis of Complex Mixtures by use of Multidimensional Planar Chromatography in Combination with Diode-Array Scanning Densitometry and High-Performance Liquid Chromatography Coupled with Diode-Array Detection. *J. Planar Chromatogr. - Mod. TLC*, 23, 3, 184-189.
- Tuzimski T. (2010b). Determination of clofentezine in medical herb extracts by chromatographic methods combined with diode array scanning densitometry. *J. Sep. Sci.*, 33, 1954-1958.
- Tuzimski T. (2010c). Application of HPLC and TLC with Diode Array Detection After SPE to the Determination of Pesticides in Water Samples from the Zemborzycki Reservoir (Lublin, Southeastern Poland). *J. AOAC International*, 93, 6, in press., 1-9.
- Zrostlíková, J.; Hajšlová, J.; Čajka, T. (2003). Evaluation of two-dimensional gas chromatography-time-of-flight mass spectrometry for the determination of multiple pesticide residues in fruit. *J. Chromatogr. A*, 1019, 1-2, 173-186.

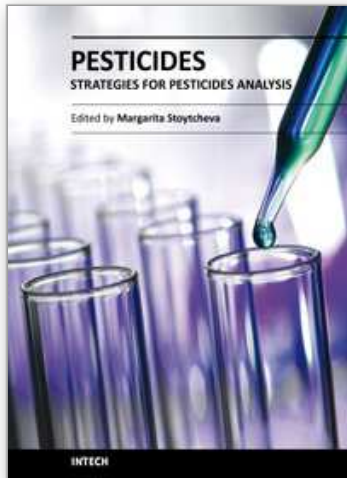

## **Pesticides - Strategies for Pesticides Analysis**

Edited by Prof. Margarita Stoytcheva

ISBN 978-953-307-460-3

Hard cover, 404 pages

**Publisher** InTech

**Published online** 21, January, 2011

**Published in print edition** January, 2011

This book provides recent information on various analytical procedures and techniques, representing strategies for reliability, specificity, selectivity and sensitivity improvements in pesticides analysis. The volume covers three main topics: current trends in sample preparation, selective and sensitive chromatographic detection and determination of pesticide residues in food and environmental samples, and the application of biological (immunoassays-and biosensors-based) methods in pesticides analysis as an alternative to the chromatographic methods for "in situ" and "on line" pesticides quantification. Intended as electronic edition, providing immediate "open access" to its content, the book is easy to follow and will be of interest to professionals involved in pesticides analysis.

### **How to reference**

In order to correctly reference this scholarly work, feel free to copy and paste the following:

Tomasz Tuzimski (2011). Multidimensional Chromatography in Pesticides Analysis, Pesticides - Strategies for Pesticides Analysis, Prof. Margarita Stoytcheva (Ed.), ISBN: 978-953-307-460-3, InTech, Available from: <http://www.intechopen.com/books/pesticides-strategies-for-pesticides-analysis/multidimensional-chromatography-in-pesticides-analysis>

**INTECH**  
open science | open minds

### **InTech Europe**

University Campus STeP Ri  
Slavka Krautzeka 83/A  
51000 Rijeka, Croatia  
Phone: +385 (51) 770 447  
Fax: +385 (51) 686 166  
[www.intechopen.com](http://www.intechopen.com)

### **InTech China**

Unit 405, Office Block, Hotel Equatorial Shanghai  
No.65, Yan An Road (West), Shanghai, 200040, China  
中国上海市延安西路65号上海国际贵都大饭店办公楼405单元  
Phone: +86-21-62489820  
Fax: +86-21-62489821

© 2011 The Author(s). Licensee IntechOpen. This chapter is distributed under the terms of the [Creative Commons Attribution-NonCommercial-ShareAlike-3.0 License](#), which permits use, distribution and reproduction for non-commercial purposes, provided the original is properly cited and derivative works building on this content are distributed under the same license.

IntechOpen

IntechOpen