

# We are IntechOpen, the world's leading publisher of Open Access books Built by scientists, for scientists

4,800

Open access books available

122,000

International authors and editors

135M

Downloads

Our authors are among the

154

Countries delivered to

TOP 1%

most cited scientists

12.2%

Contributors from top 500 universities



WEB OF SCIENCE™

Selection of our books indexed in the Book Citation Index  
in Web of Science™ Core Collection (BKCI)

Interested in publishing with us?  
Contact [book.department@intechopen.com](mailto:book.department@intechopen.com)

Numbers displayed above are based on latest data collected.  
For more information visit [www.intechopen.com](http://www.intechopen.com)



# Target Tracking for Mobile Sensor Networks Using Distributed Motion Planning and Distributed Filtering

Gerasimos G. Rigatos  
Industrial Systems Institute  
Greece

## 1. Introduction

The problem treated in this research work is as follows: there are  $N$  mobile robots (unmanned ground vehicles) which pursue a moving target. The vehicles emanate from random positions in their motion plane. Each vehicle can be equipped with various sensors, such as odometric sensors, cameras and non-imaging sensors such as sonar, radar and thermal signature sensors. These vehicles can be considered as *mobile sensors* while the ensemble of the autonomous vehicles constitutes a *mobile sensor network* (Rigatos, 2010a),(Olfati-Saber, 2005),(Olfati-Saber, 2007),(Elston & Frew, 2007). At each time instant each vehicle can obtain a measurement of the target's cartesian coordinates and orientation. Additionally, each autonomous vehicle is aware of the target's distance from a reference surface measured in a cartesian coordinates system. Finally, each vehicle can be aware of the positions of the rest  $N - 1$  vehicles. The objective is to make the unmanned vehicles converge in a synchronized manner towards the target, while avoiding collisions between them and avoiding collisions with obstacles in the motion plane. To solve the overall problem, the following steps are necessary: (i) to perform distributed filtering, so as to obtain an estimate of the target's state vector. This estimate provides the desirable state vector to be tracked by each one of the unmanned vehicles, (ii) to design a suitable control law for the unmanned vehicles that will enable not only convergence of the vehicles to the goal position but will also maintain the cohesion of the vehicles ensemble.

Regarding the implementation of the control law that will allow the mobile robots to converge to the target in a coordinated manner, this can be based on the calculation of a cost (energy) function consisting of the following elements: (i) the cost due to the distance of the  $i$ -th mobile robot from the target's coordinates, (ii) the cost due to the interaction with the other  $N - 1$  vehicles, (iii) the cost due to proximity to obstacles or inaccessible areas in the motion plane. The gradient of the aggregate cost function defines the path each vehicle should follow to reach the target and at the same time assures the synchronized approaching of the vehicles to the target. In this way, the update of the position of each vehicle will be finally described by a gradient algorithm which contains an interaction term with the gradient algorithms that defines the motion of the rest  $N - 1$  mobile robots. A suitable tool for proving analytically the convergence of the vehicles' swarm to the goal state is Lyapunov stability theory and particularly LaSalle's theorem (Rigatos, 2008a),(Rigatos, 2008b).

Regarding the implementation of distributed filtering, the Extended Information Filter and the Unscented Information Filter are suitable approaches. In the Extended Information

Filter there are local filters which do not exchange raw measurements but send to an aggregation filter their local information matrices (local inverse covariance matrices) and their associated local information state vectors (products of the local information matrices with the local state vectors) (Rigatos & Tzafestas, 2007). The Extended Information Filter performs fusion of the local state vector estimates which are provided by the local Extended Kalman Filters (EKFs), using the *Information matrix* and the *Information state vector* (Lee, 2008b), (Lee, 2008a), (Vercauteren & Wang, 2005), (Manyika & Durrant-Whyte, 1994). The Information Matrix is the inverse of the state vector covariance matrix and can be also associated to the Fisher Information matrix (Rigatos & Zhang, 2009). The Information state vector is the product between the Information matrix and the local state vector estimate (Shima et al., 2007). The Unscented Information Filter is a derivative-free distributed filtering approach which permits to calculate an aggregate estimate of the target's state vector by fusing the state estimates provided by Unscented Kalman Filters (UKFs) running at the mobile sensors. In the Unscented Information Filter an implicit linearization is performed through the approximation of the Jacobian matrix of the system's output equation by the product of the inverse of the estimation error covariance matrix with the cross-covariance matrix between the system's state vector and the system's output. Again the local information matrices and the local information state vectors are transferred to an aggregation filter which produces the global estimation of the system's state vector.

Using distributed EKFs and fusion through the Extended Information Filter or distributed UKFs through the Unscented Information Filter is more robust comparing to the centralized Extended Kalman Filter, or similarly the centralized Unscented Kalman Filter since, (i) if a local filter is subject to a fault then state estimation is still possible and can be used for accurate localization of the target, (ii) communication overhead remains low even in the case of a large number of distributed measurement units, because the greatest part of state estimation is performed locally and only information matrices and state vectors are communicated between the local filters, (iii) the aggregation performed also compensates for deviations in the state estimates of the local filters (Rigatos, 2010a).

The structure of the paper is as follows: in Section 2 the problem of target tracking in mobile sensor networks is studied. In Section 3 a distributed motion planning approach is analyzed. This is actually a distributed gradient algorithm, the convergence of which is proved using LaSalle's stability theory. In Section 4 distributed state estimation with the use of the Extended Information Filter approach is proposed. In section 5 distributed state estimation with the use of the Unscented Information Filter is studied. In Section 6 simulation experiments are provided about target tracking using distributed motion planning and distributed filtering. Finally, in Section 7 concluding remarks are stated.

## 2. Target tracking in mobile sensor networks

### 2.1 The problem of distributed target tracking

It is assumed that there are  $N$  mobile robots (unmanned vehicles) with positions  $p_1, p_2, \dots, p_N \in R^2$  respectively, and a target with position  $x^* \in R^2$  moving in a plane (see Fig. 1). Each unmanned vehicle can be equipped with various sensors, cameras and non-imaging sensors, such as sonar, radar or thermal signature sensors. The unmanned vehicles can be considered as mobile sensors while the ensemble of the autonomous vehicles constitutes a mobile sensors network. The discrete-time target's kinematic model is given by

$$\begin{aligned} x_t(k+1) &= \phi(x_t(k)) + L(k)u(k) + w(k) \\ z_t(k) &= \gamma(x_t(k)) + v(k) \end{aligned} \tag{1}$$

where  $x_t \in R^{m \times 1}$  is the target's state vector and  $z_t \in R^{p \times 1}$  is the measured output, while  $w(k)$  and  $v(k)$  are uncorrelated, zero-mean, Gaussian zero-mean noise processes with covariance matrices  $Q(k)$  and  $R(k)$  respectively. The operators  $\phi(x)$  and  $\gamma(x)$  are defined as  $\phi(x) = [\phi_1(x), \phi_2(x), \dots, \phi_m(x)]^T$ , and  $\gamma(x) = [\gamma_1(x), \gamma_2(x), \dots, \gamma_p(x)]^T$ , respectively.

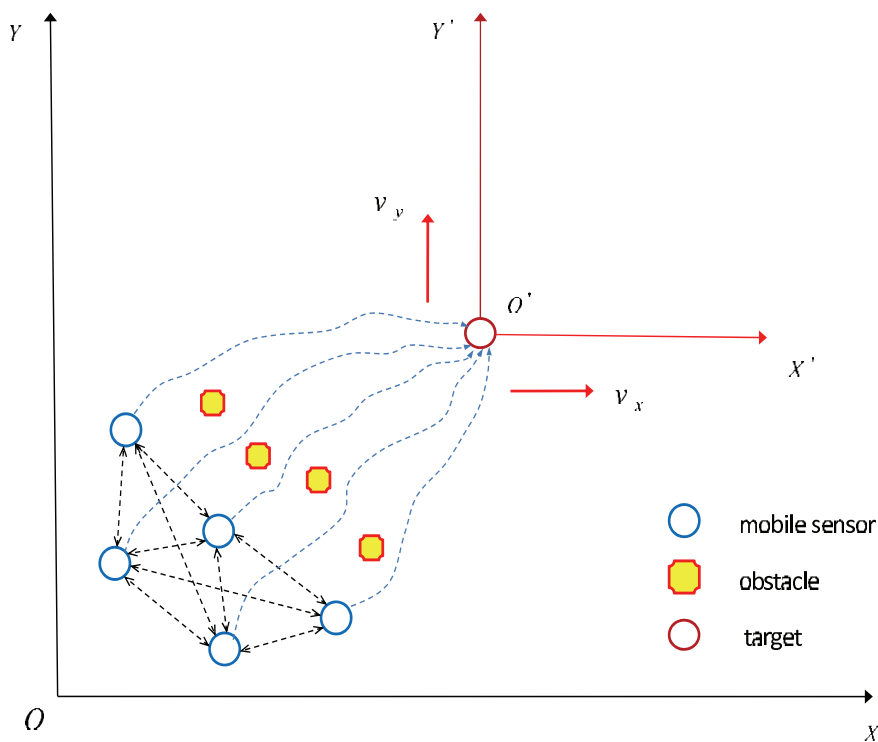

Fig. 1. Distributed target tracking in an environment with inaccessible areas.

At each time instant each mobile robot can obtain a measurement of the target's position. Additionally, each mobile robot is aware of the target's distance from a reference surface measured in an inertial coordinates system. Finally, each mobile sensor can be aware of the positions of the rest  $N - 1$  sensors. The objective is to make the mobile sensors converge in a synchronized manner towards the target, while avoiding collisions between them and avoiding collisions with obstacles in the motion plane. To solve the overall problem, the following steps are necessary: (i) to perform distributed filtering, so as to obtain an estimate of the target's state vector. This estimate provides the desirable state vector to be tracked by each one of the mobile robots, (ii) to design a suitable control law that will enable the mobile sensors not only converge to the target's position but will also preserve the cohesion of the mobile sensors swarm (see Fig. 2).

The exact position and orientation of the target can be obtained through distributed filtering. Actually, distributed filtering provides a two-level fusion of the distributed sensor measurements. At the first level, local filters running at each mobile sensor provide an estimate of the target's state vector by fusing the cartesian coordinates and bearing measurements of the target with the target's distance from a reference surface which is measured in an inertial coordinates system (Vissière et al., 2008). At a second level, fusion

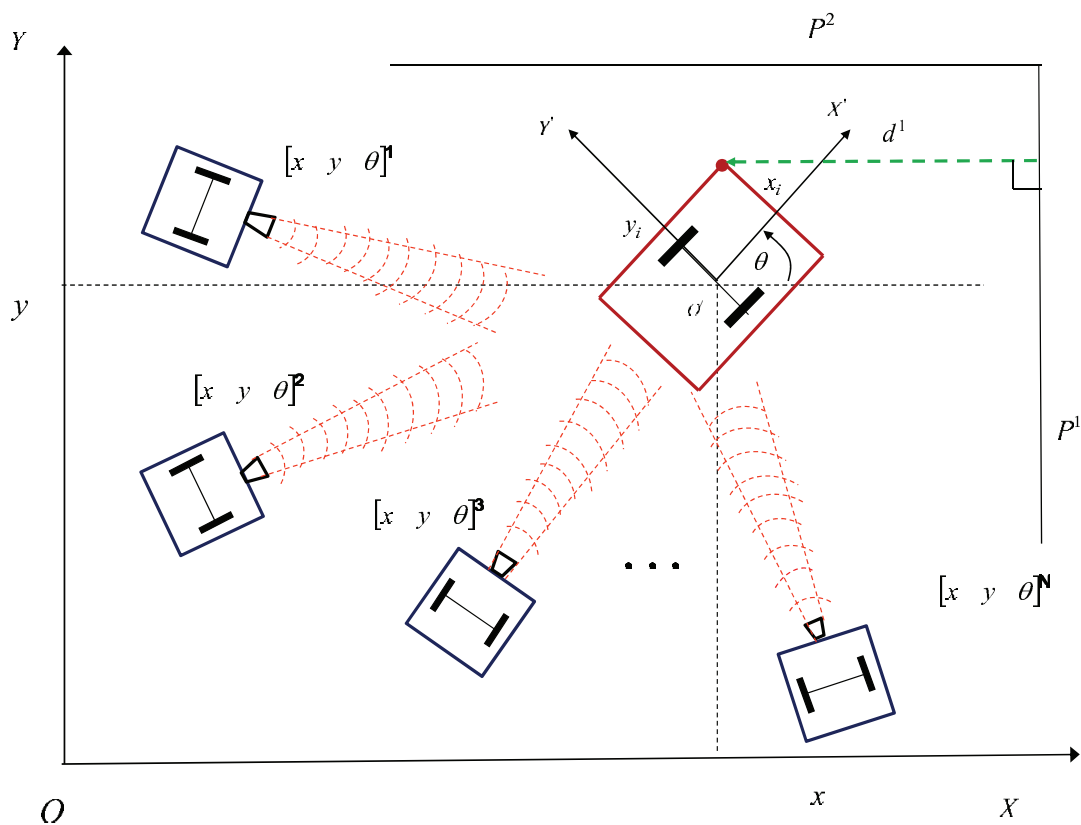

Fig. 2. Mobile robot providing estimates of the target's state vector, and the associated inertial and local coordinates reference frames

of the local estimates is performed with the use of the Extended Information Filter and the Unscented Information Filter. It is also assumed that the time taken in calculating the selection of data and in communicating between mobile robots is small, and that time delays, packet losses and out-of-sequence measurement problems in communication do not distort significantly the flow of the exchanged data.

Comparing to the traditional centralized or hierarchical fusion architecture, the network-centric architectures for the considered multi-robot system has the following advantages: (i) Scalability: since there are no limits imposed by centralized computation bottlenecks or lack of communication bandwidth, every mobile robot can easily join or quit the system, (ii) Robustness: in a decentralized fusion architecture no element of the system is mission-critical, so that the system is survivable in the event of on-line loss of part of its partial entities (mobile robots), (iii) Modularity: every partial entity is coordinated and does not need to possess a global knowledge of the network topology. However, these benefits are possible only if the sensor data can be fused and synthesized for distribution within the constraints of the available bandwidth.

## 2.2 Tracking of the reference path by the target

The continuous-time target's kinematic model is assumed to be that of a unicycle robot and is given by

$$\begin{aligned} \dot{x}(t) &= v(t)\cos(\theta(t)) \\ \dot{y}(t) &= v(t)\sin(\theta(t)) \\ \dot{\theta}(t) &= \omega(t). \end{aligned} \quad (2)$$

The target is steered by a dynamic feedback linearization control algorithm which is based on flatness-based control (Léchevin & Rabbath, 2006),(Rigatos, 2010b),(Fliess & Mounier, 1999),(Villagra et al., 2007):

$$\begin{aligned} u_1 &= \ddot{x}_d + K_{p1}(x_d - x) + K_{d1}(\dot{x}_d - \dot{x}) \\ u_2 &= \ddot{y}_d + K_{p2}(y_d - y) + K_{d2}(\dot{y}_d - \dot{y}) \\ \xi &= u_1 \cos(\theta) + u_2 \sin(\theta) \\ v &= \xi, \quad \omega = \frac{u_2 \cos(\theta) - u_1 \sin(\theta)}{\xi} \end{aligned} \quad (3)$$

The dynamics of the tracking error is given by

$$\begin{aligned} \ddot{e}_x + K_{d1}\dot{e}_x + K_{p1}e_x &= 0 \\ \ddot{e}_y + K_{d2}\dot{e}_y + K_{p2}e_y &= 0 \end{aligned} \quad (4)$$

where  $e_x = x - x_d$  and  $e_y = y - y_d$ . The proportional-derivative (PD) gains are chosen as  $K_{p_i}$  and  $K_{d_i}$ , for  $i = 1, 2$ . The dynamic compensator of Eq. (3) has a potential singularity at  $\xi = v = 0$ , i.e. when the target is not moving. It is noted however that the occurrence of such a singularity is structural for non-holonomic systems. It is assumed that the target follows a smooth trajectory  $(x_d(t), y_d(t))$  which is persistent, i.e. for which the nominal velocity  $v_d = (\dot{x}_d^2 + \dot{y}_d^2)^{1/2}$  along the trajectory never goes to zero (and thus singularities are avoided). The following theorem assures avoidance of singularities in the proposed flatness-based control law (Oriolo et al., 2002):

*Theorem:* Let  $\lambda_{11}$ ,  $\lambda_{12}$  and  $\lambda_{21}$ ,  $\lambda_{22}$  be respectively the eigenvalues of the two equations of the error dynamics, given in Eq. (4). Assume that for  $i = 1, 2$  it is  $\lambda_{i1}, \lambda_{i2} < 0$  (negative real eigenvalues), and that  $\lambda_{i2}$  is sufficiently small. If

$$\min_{t \geq 0} \left\| \begin{pmatrix} \dot{x}_d(t) \\ \dot{y}_d(t) \end{pmatrix} \right\| \geq \begin{pmatrix} \dot{e}_x^0 \\ \dot{e}_y^0 \end{pmatrix} \quad (5)$$

with  $\dot{e}_x^0 = \dot{e}_x(0) \neq 0$  and  $\dot{e}_y^0 = \dot{e}_y(0) \neq 0$  then the singularity  $\xi = 0$  is never met.

### 3. Distributed motion planning for the multi-robot system

#### 3.1 Kinematic model of the multi-robot system

The objective is to lead the ensemble of  $N$  mobile robots, with different initial positions on the 2-D plane, to converge to the target's position, and at the same time to avoid collisions between the mobile robots, as well as collisions with obstacles in the motion plane. An approach for doing this is the *potential fields theory*, in which the individual robots are steered towards an equilibrium by the gradient of an harmonic potential (Rigatos, 2008c),(Groß, et al.),(Bishop, 2003),(Hong et al., 2007). Variances of this method use nonlinear anisotropic harmonic potential fields which introduce to the robots' motion directional and regional avoidance constraints (Sinha & Ghose, 2006),(Pagello et al., 2006),(Sepulchre et al., 2007),(Masoud & Masoud, 2002). In the examined coordinated target-tracking problem the equilibrium is the target's position, which is not a-priori known and has to be estimated with the use of distributed filtering.

The position of each mobile robot in the 2-D space is described by the vector  $x^i \in R^2$ . The motion of the robots is synchronous, without time delays, and it is assumed that at every time instant each robot  $i$  is aware about the position and the velocity of the other  $N - 1$  robots. The cost function that describes the motion of the  $i$ -th mobile robot towards the target's position

is denoted as  $V(x^i) : R^n \rightarrow R$ . The value of  $V(x^i)$  at the target's position in  $\nabla_{x^i} V(x^i) = 0$ . The following conditions must hold:

- (i) The cohesion of the mobile robot's ensemble should be maintained, i.e. the norm  $\|x^i - x^j\|$  should remain upper bounded  $\|x^i - x^j\| < \epsilon^h$ ,
- (ii) Collisions between the robots should be avoided, i.e.  $\|x^i - x^j\| > \epsilon^l$ ,
- (iii) Convergence to the target's position should be succeeded for each mobile robot through the negative definiteness of the associated Lyapunov function  $\dot{V}^i(x^i) = \dot{e}^i(t)^T e^i(t) < 0$ , where  $e = x - x^*$  is the distance of the  $i$ -th mobile robot from the target's position.

The interaction between the  $i$ -th and the  $j$ -th mobile robot is

$$g(x^i - x^j) = -(x^i - x^j)[g_a(\|x^i - x^j\|) - g_r(\|x^i - x^j\|)] \quad (6)$$

where  $g_a()$  denotes the attraction term and is dominant for large values of  $\|x^i - x^j\|$ , while  $g_r()$  denotes the repulsion term and is dominant for small values of  $\|x^i - x^j\|$ . Function  $g_a()$  can be associated with an attraction potential, i.e.  $\nabla_{x^i} V_a(\|x^i - x^j\|) = (x^i - x^j)g_a(\|x^i - x^j\|)$ . Function  $g_r()$  can be associated with a repulsion potential, i.e.  $\nabla_{x^i} V_r(\|x^i - x^j\|) = (x^i - x^j)g_r(\|x^i - x^j\|)$ . A suitable function  $g()$  that describes the interaction between the robots is given by (Rigatos, 2008c),(Gazi & Passino, 2004)

$$g(x^i - x^j) = -(x^i - x^j)(a - be^{\frac{\|x^i - x^j\|^2}{\sigma^2}}) \quad (7)$$

where the parameters  $a, b$  and  $c$  are suitably tuned. It holds that  $g_a(x^i - x^j) = -a$ , i.e. attraction has a linear behavior (spring-mass system)  $\|x^i - x^j\|g_a(x^i - x^j)$ . Moreover,  $g_r(x^i - x^j) = be^{\frac{-\|x^i - x^j\|^2}{\sigma^2}}$  which means that  $g_r(x^i - x^j)\|x^i - x^j\| \leq b$  is bounded. Applying Newton's laws to the  $i$ -th robot yields

$$\dot{x}^i = v^i, \quad m^i \dot{v}^i = U^i \quad (8)$$

where the aggregate force is  $U^i = f^i + F^i$ . The term  $f^i = -K_v v^i$  denotes friction, while the term  $F^i$  is the propulsion. Assuming zero acceleration  $\dot{v}^i = 0$  one gets  $F^i = K_v v^i$ , which for  $K_v = 1$  and  $m^i = 1$  gives  $F^i = v^i$ . Thus an approximate kinematic model for each mobile robot is

$$\dot{x}^i = F^i. \quad (9)$$

According to the Euler-Langrange principle, the propulsion  $F^i$  is equal to the derivative of the total potential of each robot, i.e.

$$\begin{aligned} F^i &= -\nabla_{x^i} \{V^i(x^i) + \frac{1}{2} \sum_{i=1}^N \sum_{j=1, j \neq i}^N [V_a(\|x^i - x^j\|) + V_r(\|x^i - x^j\|)]\} \Rightarrow \\ F^i &= -\nabla_{x^i} \{V^i(x^i)\} + \sum_{j=1, j \neq i}^N [-\nabla_{x^i} V_a(\|x^i - x^j\|) - \nabla_{x^i} V_r(\|x^i - x^j\|)] \Rightarrow \\ F^i &= -\nabla_{x^i} \{V^i(x^i)\} + \sum_{j=1, j \neq i}^N [-(x^i - x^j)g_a(\|x^i - x^j\|) - (x^i - x^j)g_r(\|x^i - x^j\|)] \Rightarrow \\ F^i &= -\nabla_{x^i} \{V^i(x^i)\} - \sum_{j=1, j \neq i}^N g(x^i - x^j). \end{aligned}$$

Substituting in Eq. (9) one gets in discrete-time form

$$x^i(k+1) = x^i(k) + \gamma^i(k)[h(x^i(k)) + e^i(k)] + \sum_{j=1, j \neq i}^N g(x^i - x^j), \quad i = 1, 2, \dots, M. \quad (10)$$

The term  $h(x(k)^i) = -\nabla_{x^i} V^i(x^i)$  indicates a local gradient algorithm, i.e. motion in the direction of decrease of the cost function  $V^i(x^i) = \frac{1}{2} e^i(t)^T e^i(t)$ . The term  $\gamma^i(k)$  is the algorithms

step while the stochastic disturbance  $e^i(k)$  enables the algorithm to escape from local minima. The term  $\sum_{j=1, j \neq i}^N g(x^i - x^j)$  describes the interaction between the  $i$ -th and the rest  $N - 1$  stochastic gradient algorithms (Duflo, 1996),(Comets & Meyre, 2006),(Benveniste et al., 1990).

### 3.2 Stability of the multi-robot system

The behavior of the multi-robot system is determined by the behavior of its center (mean of the vectors  $x^i$ ) and of the position of each robot with respect to this center. The center of the multi-robot system is given by

$$\begin{aligned} \bar{x} &= E(x^i) = \frac{1}{N} \sum_{i=1}^N x^i \Rightarrow \dot{\bar{x}} = \frac{1}{N} \sum_{i=1}^N \dot{x}^i \Rightarrow \\ \dot{\bar{x}} &= \frac{1}{N} \sum_{i=1}^N [-\nabla_{x^i} V^i(x^i) - \sum_{j=1, j \neq i}^N g(x^i - x^j)] \end{aligned} \quad (11)$$

From Eq. (7) it can be seen that  $g(x^i - x^j) = -g(x^j - x^i)$ , i.e.  $g(\cdot)$  is an odd function. Therefore, it holds that  $\frac{1}{N} (\sum_{j=1, j \neq i}^N g(x^i - x^j)) = 0$ , and

$$\dot{\bar{x}} = \frac{1}{N} \sum_{i=1}^N [-\nabla_{x^i} V^i(x^i)] \quad (12)$$

Denoting the target's position by  $x^*$ , and the distance between the  $i$ -th mobile robot and the mean position of the multi-robot system by  $e^i(t) = x^i(t) - \bar{x}$  the objective of distributed gradient for robot motion planning can be summarized as follows:

(i)  $\lim_{t \rightarrow \infty} \bar{x} = x^*$ , i.e. the center of the multi-robot system converges to the target's position,

(ii)  $\lim_{t \rightarrow \infty} x^i = \bar{x}$ , i.e. the  $i$ -th robot converges to the center of the multi-robot system,

(iii)  $\lim_{t \rightarrow \infty} \dot{\bar{x}} = \dot{x}^*$ , i.e. the center of the multi-robot system stabilizes at the target's position.

If conditions (i) and (ii) hold then  $\lim_{t \rightarrow \infty} x^i = x^*$ . Furthermore, if condition (iii) also holds then all robots will stabilize close to the target's position.

It is known that the stability of local gradient algorithms can be proved with the use of Lyapunov theory (Benveniste et al., 1990). A similar approach can be followed in the case of the distributed gradient algorithms given by Eq. (10). The following simple Lyapunov function is considered for each gradient algorithm (Gazi & Passino, 2004):

$$V_i = \frac{1}{2} e^{iT} e^i \Rightarrow V_i = \frac{1}{2} \|e_i\|^2 \quad (13)$$

Thus, one gets

$$\dot{V}^i = e^{iT} \dot{e}^i \Rightarrow \dot{V}^i = (\dot{x}^i - \dot{\bar{x}}) e^i \Rightarrow$$

$$\dot{V}^i = [-\nabla_{x^i} V^i(x^i) - \sum_{j=1, j \neq i}^N g(x^i - x^j) + \frac{1}{M} \sum_{j=1}^N \nabla_{x^j} V^j(x^j)] e^i.$$

Substituting  $g(x^i - x^j)$  from Eq. (7) yields

$$\dot{V}_i = [-\nabla_{x^i} V^i(x^i) - \sum_{j=1, j \neq i}^N (x^i - x^j) a + \sum_{j=1, j \neq i}^N (x^i - x^j) g_r(\|x^i - x^j\|) + \frac{1}{N} \sum_{j=1}^N \nabla_{x^j} V^j(x^j)] e^i$$

which gives,

$$\begin{aligned} \dot{V}_i = & -a [\sum_{j=1, j \neq i}^N (x^i - x^j)] e^i + \\ & + \sum_{j=1, j \neq i}^N g_r(\|x^i - x^j\|) (x^i - x^j)^T e^i - [\nabla_{x^i} V^i(x^i) - \frac{1}{N} \sum_{j=1}^M \nabla_{x^j} V^j(x^j)]^T e^i \end{aligned}$$



It holds that  $\sum_{j=1}^N (x^i - x^j) = Nx^i - N\frac{1}{N}\sum_{j=1}^N x^j = Nx^i - N\bar{x} = N(x^i - \bar{x}) = Ne^i$ , therefore

$$\dot{V}_i = -aN\|e^i\|^2 + \sum_{j=1, j \neq i}^N g_r(\|x^i - x^j\|)(x^i - x^j)^T e^i - [\nabla_{x^i} V^i(x^i) - \frac{1}{N} \sum_{j=1}^N \nabla_{x^j} V^j(x^j)]^T e^i \quad (14)$$

It assumed that for all  $x^i$  there is a constant  $\bar{\sigma}$  such that

$$\|\nabla_{x^i} V^i(x^i)\| \leq \bar{\sigma} \quad (15)$$

Eq. (15) is reasonable since for a mobile robot moving on a 2-D plane, the gradient of the cost function  $\nabla_{x^i} V^i(x^i)$  is expected to be bounded. Moreover it is known that the following inequality holds:

$$\sum_{j=1, j \neq i}^N g_r(x^i - x^j)^T e^i \leq \sum_{j=1, j \neq i}^N b e^i \leq \sum_{j=1, j \neq i}^N b \|e^i\|.$$

Thus the application of Eq. (14) gives:

$$\begin{aligned} \dot{V}_i &\leq aN\|e^i\|^2 + \sum_{j=1, j \neq i}^N g_r(\|x^i - x^j\|)\|x^i - x^j\| \cdot \|e^i\| + \|\nabla_{x^i} V^i(x^i) - \frac{1}{N} \sum_{j=1}^N \nabla_{x^j} V^j(x^j)\| \|e^i\| \\ &\Rightarrow \dot{V}_i \leq aN\|e^i\|^2 + b(N-1)\|e^i\| + 2\bar{\sigma}\|e^i\| \end{aligned}$$

where it has been taken into account that

$$\sum_{j=1, j \neq i}^N g_r(\|x^i - x^j\|)^T \|e^i\| \leq \sum_{j=1, j \neq i}^N b \|e^i\| = b(N-1)\|e^i\|,$$

and from Eq. (15),

$$\|\nabla_{x^i} V^i(x^i) - \frac{1}{N} \sum_{j=1}^N \nabla_{x^j} V^j(x^j)\| \leq \|\nabla_{x^i} V^i(x^i)\| + \frac{1}{N} \|\sum_{j=1}^N \nabla_{x^j} V^j(x^j)\| \leq \bar{\sigma} + \frac{1}{N} N\bar{\sigma} \leq 2\bar{\sigma}.$$

Thus, one gets

$$\dot{V}_i \leq aN\|e^i\| \cdot [\|e^i\| - \frac{b(N-1)}{aN} - 2\frac{\bar{\sigma}}{aN}] \quad (16)$$

The following bound  $\epsilon$  is defined:

$$\epsilon = \frac{b(N-1)}{aN} + \frac{2\bar{\sigma}}{aN} = \frac{1}{aN} (b(N-1) + 2\bar{\sigma}) \quad (17)$$

Thus, when  $\|e^i\| > \epsilon$ ,  $\dot{V}_i$  will become negative and consequently the error  $e^i = x^i - \bar{x}$  will decrease. Therefore the tracking error  $e^i$  will remain in an area of radius  $\epsilon$  i.e. the position  $x^i$  of the  $i$ -th robot will stay in the cycle with center  $\bar{x}$  and radius  $\epsilon$ .

### 3.3 Stability in the case of a quadratic cost function

The case of a convex quadratic cost function is examined, for instance

$$V^i(x^i) = \frac{A}{2} \|x^i - x^*\|^2 = \frac{A}{2} (x^i - x^*)^T (x^i - x^*) \quad (18)$$

where  $x^* \in R^2$  denotes the target's position, while the associated Lyapunov function has a minimum at  $x^*$ , i.e.  $V^i(x^i = x^*) = 0$ . The distributed gradient algorithm is expected to converge to  $x^*$ . The robotic vehicles will follow different trajectories on the 2-D plane and will end at the target's position.

Using Eq.(18) yields  $\nabla_{x^i} V^i(x^i) = A(x^i - x^*)$ . Moreover, the assumption  $\nabla_{x^i} V^i(x^i) \leq \bar{\sigma}$  can be used, since the gradient of the cost function remains bounded. The robotic vehicles will concentrate round  $\bar{x}$  and will stay in a radius  $\epsilon$  given by Eq. (17). The motion of the mean position  $\bar{x}$  of the vehicles is

$$\begin{aligned} \dot{\bar{x}} &= -\frac{1}{N} \sum_{i=1}^N \nabla_{x^i} V^i(x^i) \Rightarrow \dot{\bar{x}} = -\frac{A}{N} \sum_{i=1}^N (x^i - x^*) \Rightarrow \\ \dot{\bar{x}} &= -\frac{A}{N} \sum_{i=1}^N x^i + \frac{A}{N} N x^* \Rightarrow \dot{\bar{x}} - \dot{x}^* = -A(\bar{x} - x^*) - \dot{x}^* \end{aligned} \quad (19)$$

The variable  $e_\sigma = \bar{x} - x^*$  is defined, and consequently

$$\dot{e}_\sigma = -A e_\sigma - \dot{x}^* \quad (20)$$

The following cases can be distinguished:

(i) The target is not moving, i.e.  $\dot{x}^* = 0$ . In that case Eq. (20) results in an homogeneous differential equation, the solution of which is given by

$$e_\sigma(t) = e_\sigma(0) e^{-At} \quad (21)$$

Knowing that  $A > 0$  results into  $\lim_{t \rightarrow \infty} e_\sigma(t) = 0$ , thus  $\lim_{t \rightarrow \infty} \bar{x}(t) = x^*$ .

(ii) the target is moving at constant velocity, i.e.  $\dot{x}^* = a$ , where  $a > 0$  is a constant parameter. Then the error between the mean position of the multi-robot formation and the target becomes

$$e_\sigma(t) = \left[ e_\sigma(0) + \frac{a}{A} \right] e^{-At} - \frac{a}{A} \quad (22)$$

where the exponential term vanishes as  $t \rightarrow \infty$ .

(iii) the target's velocity is described by a sinusoidal signal or a superposition of sinusoidal signals, as in the case of function approximation by Fourier series expansion. For instance consider the case that  $\dot{x}^* = b \cdot \sin(at)$ , where  $a, b > 0$  are constant parameters. Then the nonhomogeneous differential equation Eq. (20) admits a sinusoidal solution. Therefore the distance  $e_\sigma(t)$  between the center of the multi-robot formation  $\bar{x}(t)$  and the target's position  $x^*(t)$  will be also a bounded sinusoidal signal.

### 3.4 Convergence analysis using La Salle's theorem

From Eq. (16) it has been shown that each robot will stay in a cycle  $C$  of center  $\bar{x}$  and radius  $\epsilon$  given by Eq. (17). The Lyapunov function given by Eq. (13) is negative semi-definite, therefore asymptotic stability cannot be guaranteed. It remains to make precise the area of convergence of each robot in the cycle  $C$  of center  $\bar{x}$  and radius  $\epsilon$ . To this end, La Salle's theorem can be employed (Gazi & Passino, 2004),(Khalil, 1996).

*La Salle's Theorem:* Assume the autonomous system  $\dot{x} = f(x)$  where  $f : D \rightarrow R^n$ . Assume  $C \subset D$  a compact set which is positively invariant with respect to  $\dot{x} = f(x)$ , i.e. if  $x(0) \in C \Rightarrow x(t) \in C \forall t$ . Assume that  $V(x) : D \rightarrow R$  is a continuous and differentiable Lyapunov function such that  $\dot{V}(x) \leq 0$  for  $x \in C$ , i.e.  $V(x)$  is negative semi-definite in  $C$ . Denote by  $E$  the set of all points in  $C$  such that  $\dot{V}(x) = 0$ . Denote by  $M$  the largest invariant set in  $E$  and its boundary by  $L^+$ , i.e. for  $x(t) \in E : \lim_{t \rightarrow \infty} x(t) = L^+$ , or in other words  $L^+$  is the positive limit set of  $E$ . Then every solution  $x(t) \in C$  will converge to  $M$  as  $t \rightarrow \infty$ .

La Salle's theorem is applicable in the case of the multi-robot system and helps to describe more precisely the area round  $\bar{x}$  to which the robot trajectories  $x^i$  will converge. A generalized Lyapunov function is introduced which is expected to verify the stability analysis based on

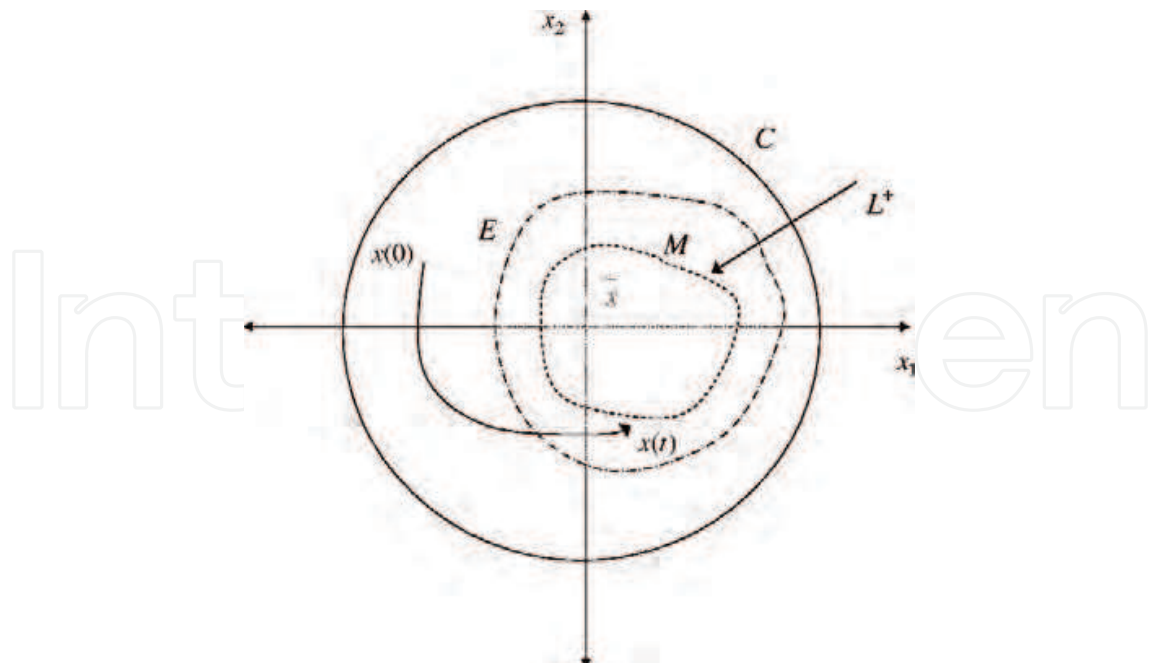

Fig. 3. LaSalle's theorem:  $C$ : invariant set,  $E \subset C$ : invariant set which satisfies  $\dot{V}(x) = 0$ ,  $M \subset E$ : invariant set, which satisfies  $\dot{V}(x) = 0$ , and which contains the limit points of  $x(t) \in E$ ,  $L^+$  the set of limit points of  $x(t) \in E$

Eq. (16). It holds that

$$V(x) = \sum_{i=1}^N V^i(x^i) + \frac{1}{2} \sum_{i=1}^N \sum_{j=1, j \neq i}^N \{V_a(\|x^i - x^j\|) - V_r(\|x^i - x^j\|)\} \Rightarrow$$

$$V(x) = \sum_{i=1}^N V^i(x^i) + \frac{1}{2} \sum_{i=1}^N \sum_{j=1, j \neq i}^N \{a\|x^i - x^j\| - V_r(\|x^i - x^j\|)\}$$

and

$$\nabla_{x^i} V(x) = [\sum_{i=1}^N \nabla_{x^i} V^i(x^i)] + \frac{1}{2} \sum_{i=1}^N \sum_{j=1, j \neq i}^N \nabla_{x^i} \{a\|x^i - x^j\| - V_r(\|x^i - x^j\|)\} \Rightarrow$$

$$\nabla_{x^i} V(x) = [\sum_{i=1}^N \nabla_{x^i} V^i(x^i)] + \sum_{j=1, j \neq i}^N (x^i - x^j) \{g_a(\|x^i - x^j\|) - g_r(\|x^i - x^j\|)\} \Rightarrow$$

$$\nabla_{x^i} V(x) = [\sum_{i=1}^N \nabla_{x^i} V^i(x^i)] + \sum_{j=1, j \neq i}^N (x^i - x^j) \{a - g_r(\|x^i - x^j\|)\}$$

and using Eq. (10) with  $\gamma^i(t) = 1$  yields  $\nabla_{x^i} V(x) = -\dot{x}^i$ , and

$$\dot{V}(x) = \nabla_x V(x)^T \dot{x} = \sum_{i=1}^N \nabla_{x^i} V(x)^T \dot{x}^i \Rightarrow \dot{V}(x) = -\sum_{i=1}^N \|\dot{x}^i\|^2 \leq 0 \quad (23)$$

Therefore it holds  $V(x) > 0$  and  $\dot{V}(x) \leq 0$  and the set  $C = \{x : V(x(t)) \leq V(x(0))\}$  is compact and positively invariant. Thus, by applying La Salle's theorem one can show the convergence of  $x(t)$  to the set  $M \subset C$ ,  $M = \{x : \dot{V}(x) = 0\} \Rightarrow M = \{x : \dot{x} = 0\}$ .

#### 4. Distributed state estimation using the extended information filter

##### 4.1 Extended kalman filtering at local processing units

As mentioned, to obtain an accurate estimate of the target's coordinates, fusion of the distributed sensor measurements can be performed either with the use of the Extended

Information Filter or with the use of the Unscented Information Filter. The distributed Extended Kalman Filter, also known as Extended Information Filter, performs fusion of the state estimates which are provided by local Extended Kalman Filters. Thus, the functioning of the local Extended Kalman Filters should be analyzed first. The following nonlinear state-space model is considered again (Rigatos & Tzafestas, 2007), (Rigatos, 2009b):

$$\begin{aligned} x(k+1) &= \phi(x(k)) + L(k)u(k) + w(k) \\ z(k) &= \gamma(x(k)) + v(k) \end{aligned} \tag{24}$$

where  $x \in R^{m \times 1}$  is the system's state vector and  $z \in R^{p \times 1}$  is the system's output, while  $w(k)$  and  $v(k)$  are uncorrelated, Gaussian zero-mean noise processes with covariance matrices  $Q(k)$  and  $R(k)$  respectively. The operators  $\phi(x)$  and  $\gamma(x)$  are  $\phi(x) = [\phi_1(x), \phi_2(x), \dots, \phi_m(x)]^T$ , and  $\gamma(x) = [\gamma_1(x), \gamma_2(x), \dots, \gamma_p(x)]^T$ , respectively. It is assumed that  $\phi$  and  $\gamma$  are sufficiently smooth in  $x$  so that each one has a valid series. Taylor expansion. Following a linearization procedure,  $\phi$  is expanded into Taylor series about  $\hat{x}$ :

$$\phi(x(k)) = \phi(\hat{x}(k)) + J_\phi(\hat{x}(k))[x(k) - \hat{x}(k)] + \dots \tag{25}$$

where  $J_\phi(x)$  is the Jacobian of  $\phi$  calculated at  $\hat{x}(k)$ :

$$J_\phi(x) = \frac{\partial \phi}{\partial x} \Big|_{x=\hat{x}(k)} = \begin{pmatrix} \frac{\partial \phi_1}{\partial x_1} & \frac{\partial \phi_1}{\partial x_2} & \dots & \frac{\partial \phi_1}{\partial x_m} \\ \frac{\partial \phi_2}{\partial x_1} & \frac{\partial \phi_2}{\partial x_2} & \dots & \frac{\partial \phi_2}{\partial x_m} \\ \vdots & \vdots & \vdots & \vdots \\ \frac{\partial \phi_m}{\partial x_1} & \frac{\partial \phi_m}{\partial x_2} & \dots & \frac{\partial \phi_m}{\partial x_m} \end{pmatrix} \tag{26}$$

Likewise,  $\gamma$  is expanded about  $\hat{x}^-(k)$

$$\gamma(x(k)) = \gamma(\hat{x}^-(k)) + J_\gamma[x(k) - \hat{x}^-(k)] + \dots \tag{27}$$

where  $\hat{x}^-(k)$  is the estimation of the state vector  $x(k)$  before measurement at the  $k$ -th instant to be received and  $\hat{x}(k)$  is the updated estimation of the state vector after measurement at the  $k$ -th instant has been received. The Jacobian  $J_\gamma(x)$  is

$$J_\gamma(x) = \frac{\partial \gamma}{\partial x} \Big|_{x=\hat{x}^-(k)} = \begin{pmatrix} \frac{\partial \gamma_1}{\partial x_1} & \frac{\partial \gamma_1}{\partial x_2} & \dots & \frac{\partial \gamma_1}{\partial x_m} \\ \frac{\partial \gamma_2}{\partial x_1} & \frac{\partial \gamma_2}{\partial x_2} & \dots & \frac{\partial \gamma_2}{\partial x_m} \\ \vdots & \vdots & \vdots & \vdots \\ \frac{\partial \gamma_p}{\partial x_1} & \frac{\partial \gamma_p}{\partial x_2} & \dots & \frac{\partial \gamma_p}{\partial x_m} \end{pmatrix} \tag{28}$$

The resulting expressions create first order approximations of  $\phi$  and  $\gamma$ . Thus the linearized version of the system is obtained:

$$\begin{aligned} x(k+1) &= \phi(\hat{x}(k)) + J_\phi(\hat{x}(k))[x(k) - \hat{x}(k)] + w(k) \\ z(k) &= \gamma(\hat{x}^-(k)) + J_\gamma(\hat{x}^-(k))[x(k) - \hat{x}^-(k)] + v(k) \end{aligned} \tag{29}$$

Now, the EKF recursion is as follows: First the time update is considered: by  $\hat{x}(k)$  the estimation of the state vector at instant  $k$  is denoted. Given initial conditions  $\hat{x}^-(0)$  and  $P^-(0)$  the recursion proceeds as:

– *Measurement update.* Acquire  $z(k)$  and compute:

$$\begin{aligned} K(k) &= P^-(k)J_\gamma^T(\hat{x}^-(k)) \cdot [J_\gamma(\hat{x}^-(k))P^-(k)J_\gamma^T(\hat{x}^-(k)) + R(k)]^{-1} \\ \hat{x}(k) &= \hat{x}^-(k) + K(k)[z(k) - \gamma(\hat{x}^-(k))] \\ P(k) &= P^-(k) - K(k)J_\gamma(\hat{x}^-(k))P^-(k) \end{aligned} \quad (30)$$

– *Time update.* Compute:

$$\begin{aligned} P^-(k+1) &= J_\phi(\hat{x}(k))P(k)J_\phi^T(\hat{x}(k)) + Q(k) \\ \hat{x}^-(k+1) &= \phi(\hat{x}(k)) + L(k)u(k) \end{aligned} \quad (31)$$

The schematic diagram of the EKF loop is given in Fig. 4.

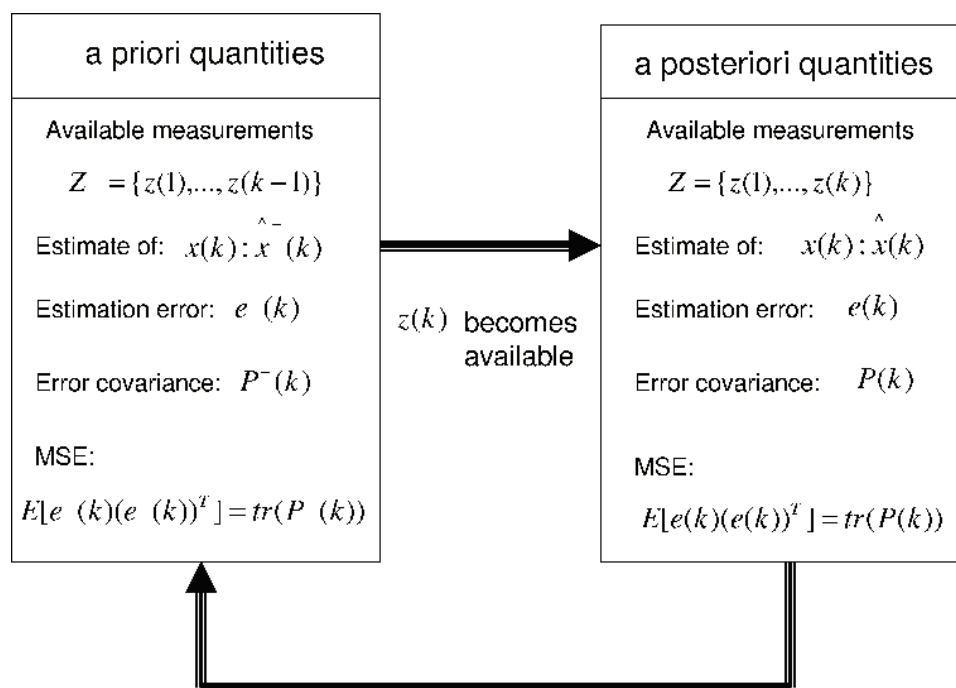

Fig. 4. Schematic diagram of the EKF loop

#### 4.2 Calculation of local estimations in terms of EIF information contributions

Again the discrete-time nonlinear system of Eq. (24) is considered. The Extended Information Filter (EIF) performs fusion of the local state vector estimates which are provided by the local Extended Kalman Filters, using the *Information matrix* and the *Information state vector* (Lee, 2008b), (Lee, 2008a), (Vercauteren & Wang, 2005), (Manyika & Durrant-Whyte, 1994). The Information Matrix is the inverse of the state vector covariance matrix, and can be also associated to the Fisher Information matrix (Rigatos & Zhang, 2009). The Information state vector is the product between the Information matrix and the local state vector estimate

$$\begin{aligned} Y(k) &= P^{-1}(k) = I(k) \\ \hat{y}(k) &= P^-(k)^{-1}\hat{x}(k) = Y(k)\hat{x}(k) \end{aligned} \quad (32)$$

The update equation for the Information Matrix and the Information state vector are given by

$$\begin{aligned} Y(k) &= P^-(k)^{-1} + J_\gamma^T(k)R^{-1}(k)J_\gamma(k) \\ &= Y^-(k) + I(k) \end{aligned} \quad (33)$$

$$\hat{y}(k) = \hat{y}^-(k) + J_\gamma^T R(k)^{-1} [z(k) - \gamma(x(k)) + J_\gamma \hat{x}^-(k)] = \hat{y}^-(k) + i(k) \quad (34)$$

where

$$I(k) = J_\gamma^T(k) R(k)^{-1} J_\gamma(k) \text{ is the associated information matrix and } i(k) = J_\gamma^T R(k)^{-1} [(z(k) - \gamma(x(k))) + J_\gamma \hat{x}^-(k)] \text{ is the information state contribution} \quad (35)$$

The predicted information state vector and Information matrix are obtained from

$$\hat{y}^-(k) = P^-(k)^{-1} \hat{x}^-(k) \quad Y^-(k) = P^-(k)^{-1} = [J_\phi(k) P^-(k) J_\phi(k)^T + Q(k)]^{-1} \quad (36)$$

The Extended Information Filter is next formulated for the case that multiple local sensor measurements and local estimates are used to increase the accuracy and reliability of the estimation of the target's cartesian coordinates and bearing. It is assumed that an observation vector  $z^i(k)$  is available for  $N$  different sensor sites (mobile robots)  $i = 1, 2, \dots, N$  and each sensor observes a common state according to the local observation model, expressed by

$$z^i(k) = \gamma(x(k)) + v^i(k), \quad i = 1, 2, \dots, N \quad (37)$$

where the local noise vector  $v^i(k) \sim N(0, R^i)$  is assumed to be white Gaussian and uncorrelated between sensors. The variance of a composite observation noise vector  $v_k$  is expressed in terms of the block diagonal matrix

$$R(k) = \text{diag}[R(k)^1, \dots, R^N(k)]^T \quad (38)$$

The information contribution can be expressed by a linear combination of each local information state contribution  $i^i$  and the associated information matrix  $I^i$  at the  $i$ -th sensor site

$$i(k) = \sum_{i=1}^N J_\gamma^i T(k) R^i(k)^{-1} [z^i(k) - \gamma^i(x(k)) + J_\gamma^i(k) \hat{x}^-(k)] \quad I(k) = \sum_{i=1}^N J_\gamma^i T(k) R^i(k)^{-1} J_\gamma^i(k) \quad (39)$$

Using Eq. (39) the update equations for fusing the local state estimates become

$$\hat{y}(k) = \hat{y}^-(k) + \sum_{i=1}^N J_\gamma^i T(k) R^i(k)^{-1} [z^i(k) - \gamma^i(x(k)) + J_\gamma^i(k) \hat{x}^-(k)] \quad Y(k) = Y^-(k) + \sum_{i=1}^N J_\gamma^i T(k) R^i(k)^{-1} J_\gamma^i(k) \quad (40)$$

It is noted that in the Extended Information Filter an aggregation (master) fusion filter produces a global estimate by using the local sensor information provided by each local filter. As in the case of the Extended Kalman Filter the local filters which constitute the Extended information Filter can be written in terms of *time update* and a *measurement update* equation.

*Measurement update:* Acquire  $z(k)$  and compute

$$Y(k) = P^-(k)^{-1} + J_\gamma^T(k) R(k)^{-1} J_\gamma(k) \quad \text{or } Y(k) = Y^-(k) + I(k) \text{ where } I(k) = J_\gamma^T(k) R^{-1}(k) J_\gamma(k) \quad (41)$$

$$\hat{y}(k) = \hat{y}^-(k) + J_\gamma^T(k) R(k)^{-1} [z(k) - \gamma(\hat{x}(k)) + J_\gamma \hat{x}^-(k)] \quad \text{or } \hat{y}(k) = \hat{y}^-(k) + i(k) \quad (42)$$

*Time update:* Compute

$$Y^-(k+1) = P^-(k+1)^{-1} = [J_\phi(k) P(k) J_\phi(k)^T + Q(k)]^{-1} \quad (43)$$

$$y^-(k+1) = P^-(k+1)^{-1} \hat{x}^-(k+1) \quad (44)$$

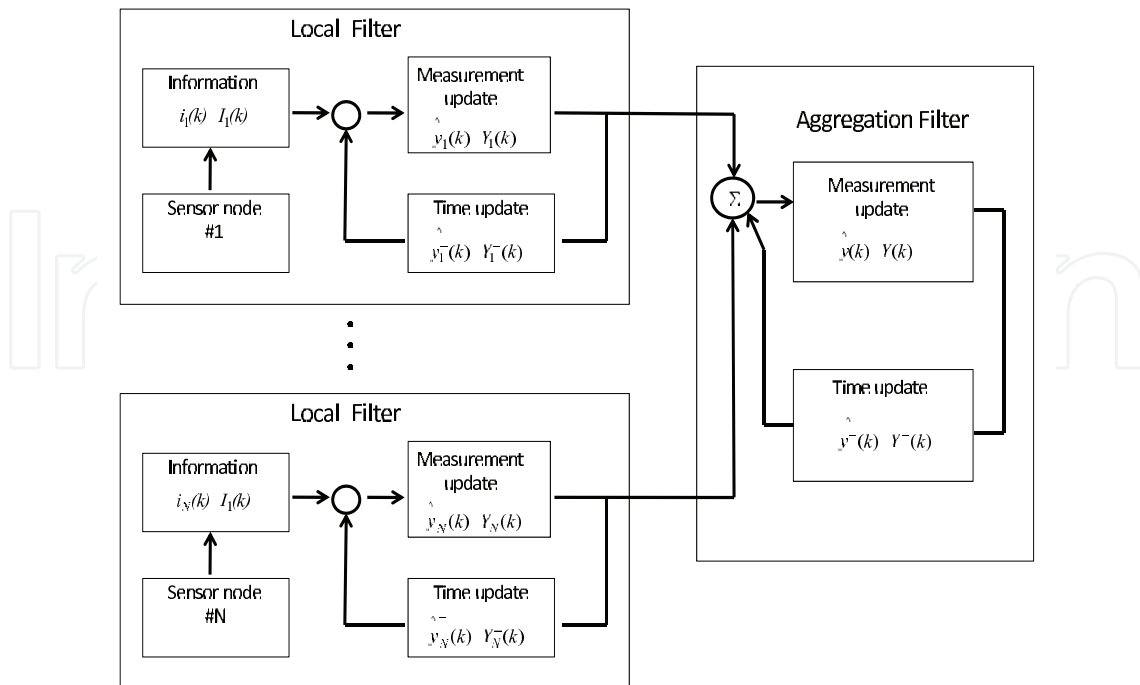

Fig. 5. Fusion of the distributed state estimates of the target (obtained by the mobile robots) with the use of the Extended Information Filter

#### 4.3 Extended information filtering for state estimates fusion

In the Extended Information Filter each one of the local filters operates independently, processing its own local measurements. It is assumed that there is no sharing of measurements between the local filters and that the aggregation filter (Fig. 5) does not have direct access to the raw measurements feeding each local filter. The outputs of the local filters are treated as measurements which are fed into the aggregation fusion filter (Lee, 2008b), (Lee, 2008a), (Vercauteren & Wang, 2005). Then each local filter is expressed by its respective error covariance and estimate in terms of information contributions given in Eq.(36)

$$P_i^{-1}(k) = P_i^{-}(k)^{-1} + J_\gamma^T R(k)^{-1} J_\gamma(k) \quad (45)$$

$$\hat{x}_i(k) = P_i(k) [P_i^{-}(k)^{-1} \hat{x}_i^{-}(k) + J_\gamma^T R(k)^{-1} [z^i(k) - \gamma^i(x(k)) + J_\gamma^i(k) \hat{x}_i^{-}(k)]]$$

It is noted that the local estimates are suboptimal and also conditionally independent given their own measurements. The global estimate and the associated error covariance for the aggregate fusion filter can be rewritten in terms of the computed estimates and covariances from the local filters using the relations

$$J_\gamma^T(k) R(k)^{-1} J_\gamma(k) = P_i(k)^{-1} - P_i^{-}(k)^{-1} \quad (46)$$

$$J_\gamma^T(k) R(k)^{-1} [z^i(k) - \gamma^i(x(k)) + J_\gamma^i(k) \hat{x}_i^{-}(k)] = P_i(k)^{-1} \hat{x}_i(k) - P_i^{-}(k)^{-1} \hat{x}_i^{-}(k)$$

For the general case of  $N$  local filters  $i = 1, \dots, N$ , the distributed filtering architecture is described by the following equations

$$P(k)^{-1} = P^{-}(k)^{-1} + \sum_{i=1}^N [P_i(k)^{-1} - P_i^{-}(k)^{-1}] \quad (47)$$

$$\hat{x}(k) = P(k) [P^{-}(k)^{-1} \hat{x}^{-}(k) + \sum_{i=1}^N (P_i(k)^{-1} \hat{x}_i(k) - P_i^{-}(k)^{-1} \hat{x}_i^{-}(k))]$$

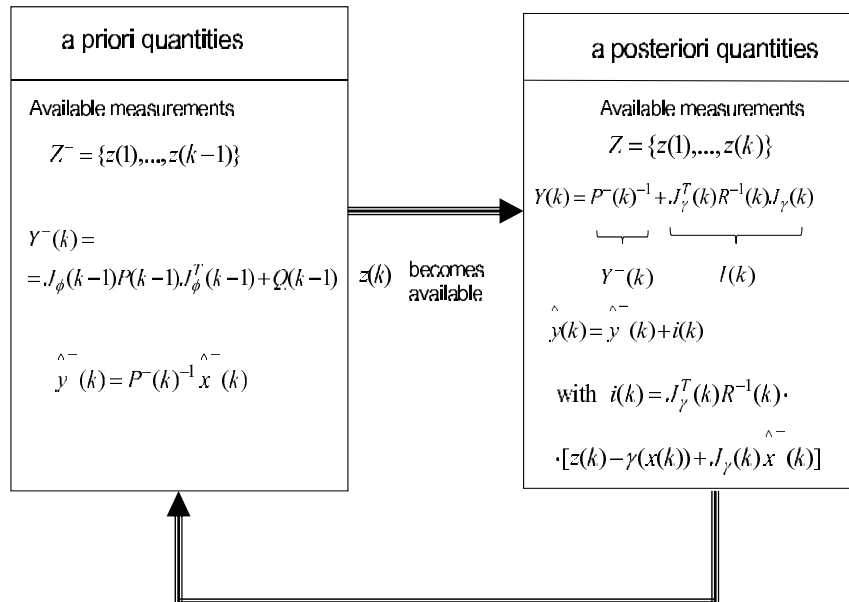

Fig. 6. Schematic diagram of the Extended Information Filter loop

It is noted that the global state update equation in the above distributed filter can be written in terms of the information state vector and of the information matrix

$$\begin{aligned} \hat{y}(k) &= \hat{y}^-(k) + \sum_{i=1}^N (\hat{y}_i(k) - \hat{y}_i^-(k)) \\ \hat{Y}(k) &= \hat{Y}^-(k) + \sum_{i=1}^N (\hat{Y}_i(k) - \hat{Y}_i^-(k)) \end{aligned} \quad (48)$$

The local filters provide their own local estimates and repeat the cycle at step  $k + 1$ . In turn the global filter can predict its global estimate and repeat the cycle at the next time step  $k + 1$  when the new state  $\hat{x}(k + 1)$  and the new global covariance matrix  $P(k + 1)$  are calculated. From Eq. (47) it can be seen that if a local filter (processing station) fails, then the local covariance matrices and the local state estimates provided by the rest of the filters will enable an accurate computation of the system's state vector.

## 5. Distributed state estimation using the unscented information filter

### 5.1 Unscented kalman filtering at local processing units

It is also possible to estimate the cartesian coordinates and bearing of the target through the fusion of the estimates provided by local Sigma-Point Kalman Filters. This can be succeeded using the Distributed Sigma-Point Kalman Filter, also known as *Unscented Information Filter* (UIF) (Lee, 2008b), (Lee, 2008a). First, the functioning of the local Sigma-Point Kalman Filters will be explained. Each local Sigma-Point Kalman Filter generates an estimation of the target's state vector by fusing the estimate of the target's coordinates and bearing obtained by each mobile robot with the distance of the target from a reference surface, measured in an inertial coordinates system. Unlike EKF, in Sigma-Point Kalman Filtering no analytical Jacobians of the system equations need to be calculated as in the case for the EKF (Julier et al., 2000), (Julier & Uhlmann, 2004), (Särrkä, 2007). This is achieved through a different approach for calculating the posterior 1st and 2nd order statistics of a random variable that undergoes a



nonlinear transformation. The state distribution is represented again by a Gaussian random variable but is now specified using a minimal set of deterministically chosen weighted sample points. The basic sigma-point approach can be described as follows:

1. A set of weighted samples (sigma-points) are deterministically calculated using the mean and square-root decomposition of the covariance matrix of the system's state vector. As a minimal requirement the sigma-point set must completely capture the first and second order moments of the prior random variable. Higher order moments can be captured at the cost of using more sigma-points.
2. The sigma-points are propagated through the true nonlinear function using functional evaluations alone, i.e. no analytical derivatives are used, in order to generate a posterior sigma-point set.
3. The posterior statistics are calculated (approximated) using tractable functions of the propagated sigma-points and weights. Typically, these take on the form of a simple weighted sample mean and covariance calculations of the posterior sigma points.

It is noted that the sigma-point approach differs substantially from general stochastic sampling techniques, such as Monte-Carlo integration (e.g Particle Filtering methods) which require significantly more sample points in an attempt to propagate an accurate (possibly non-Gaussian) distribution of the state. The deceptively simple sigma-point approach results in posterior approximations that are accurate to the third order for Gaussian inputs for all nonlinearities. For non-Gaussian inputs, approximations are accurate to at least the second-order, with the accuracy of third and higher-order moments determined by the specific choice of weights and scaling factors.

The Unscented Kalman Filter (UKF) is a special case of Sigma-Point Kalman Filters. The UKF is a discrete time filtering algorithm which uses the unscented transform for computing approximate solutions to the filtering problem of the form

$$\begin{aligned}x(k+1) &= \phi(x(k)) + L(k)U(k) + w(k) \\ y(k) &= \gamma(x(k)) + v(k)\end{aligned}\quad (49)$$

where  $x(k) \in R^n$  is the system's state vector,  $y(k) \in R^m$  is the measurement,  $w(k) \in R^n$  is a Gaussian process noise  $w(k) \sim N(0, Q(k))$ , and  $v(k) \in R^m$  is a Gaussian measurement noise denoted as  $v(k) \sim N(0, R(k))$ . The mean and covariance of the initial state  $x(0)$  are  $m(0)$  and  $P(0)$ , respectively.

Some basic operations performed in the UKF algorithm (*Unscented Transform*) are summarized as follows:

- 1) Denoting the current state mean as  $\hat{x}$ , a set of  $2n + 1$  sigma points is taken from the columns of the  $n \times n$  matrix  $\sqrt{(n + \lambda)P_{xx}}$  as follows:

$$\begin{aligned}x^0 &= \hat{x} \\ x^i &= \hat{x} + [\sqrt{(n + \lambda)P_{xx}}]_i, \quad i = 1, \dots, n \\ x^i &= \hat{x} - [\sqrt{(n + \lambda)P_{xx}}]_i, \quad i = n + 1, \dots, 2n\end{aligned}\quad (50)$$

and the associate weights are computed:

$$\begin{aligned}W_0^{(m)} &= \frac{\lambda}{(n + \lambda)} & W_0^{(c)} &= \frac{\lambda}{(n + \lambda) + (1 - \alpha^2 + \beta)} \\ W_i^{(m)} &= \frac{1}{2(n + \lambda)}, \quad i = 1, \dots, 2n & W_i^{(c)} &= \frac{1}{2(n + \lambda)}\end{aligned}\quad (51)$$

where  $i = 1, 2, \dots, 2n$  and  $\lambda = \alpha^2(n + \kappa) - n$  is a scaling parameter, while  $\alpha$ ,  $\beta$  and  $\kappa$  are constant parameters. Matrix  $P_{xx}$  is the covariance matrix of the state  $x$ .

2) Transform each of the sigma points as

$$z^i = h(x^i) \quad i = 0, \dots, 2n \quad (52)$$

3) Mean and covariance estimates for  $z$  can be computed as

$$\hat{z} \simeq \sum_{i=0}^{2n} W_i^{(m)} z^i$$

$$P_{zz} = \sum_{i=0}^{2n} W_i^{(c)} (z^i - \hat{z})(z^i - \hat{z})^T \quad (53)$$

4) The cross-covariance of  $x$  and  $z$  is estimated as

$$P_{xz} = \sum_{i=0}^{2n} W_i^{(c)} (x^i - \hat{x})(z^i - \hat{z})^T \quad (54)$$

The matrix square root of positive definite matrix  $P_{xx}$  means a matrix  $A = \sqrt{P_{xx}}$  such that  $P_{xx} = AA^T$  and a possible way for calculation is Singular Values Decomposition (SVD).

Next the basic stages of the *Unscented Kalman Filter* are given:

As in the case of the Extended Kalman Filter and the Particle Filter, the Unscented Kalman Filter also consists of prediction stage (time update) and correction stage (measurement update) (Julier & Uhlmann, 2004), (Särkkä, 2007).

*Time update:* Compute the predicted state mean  $\hat{x}^-(k)$  and the predicted covariance  $P_{xx}^-(k)$  as

$$[\hat{x}^-(k), P_{xx}^-(k)] = UT(f_d, \hat{x}(k-1), P_{xx}(k-1))$$

$$P_{xx}^-(k) = P_{xx}(k-1) + Q(k-1) \quad (55)$$

*Measurement update:* Obtain the new output measurement  $z_k$  and compute the predicted mean  $\hat{z}(k)$  and covariance of the measurement  $P_{zz}(k)$ , and the cross covariance of the state and measurement  $P_{xz}(k)$

$$[\hat{z}(k), P_{zz}(k), P_{xz}(k)] = UT(h_d, \hat{x}^-(k), P_{xx}^-(k))$$

$$P_{zz}(k) = P_{zz}(k) + R(k) \quad (56)$$

Then compute the filter gain  $K(k)$ , the state mean  $\hat{x}(k)$  and the covariance  $P_{xx}(k)$ , conditional to the measurement  $y(k)$

$$K(k) = P_{xz}(k)P_{zz}^{-1}(k)$$

$$\hat{x}(k) = \hat{x}^-(k) + K(k)[z(k) - \hat{z}(k)] \quad (57)$$

$$P_{xx}(k) = P_{xx}^-(k) - K(k)P_{zz}(k)K(k)^T$$

The filter starts from the initial mean  $m(0)$  and covariance  $P_{xx}(0)$ . The stages of state vector estimation with the use of the Unscented Kalman Filter algorithm are depicted in Fig. 7.

## 5.2 Unscented information filtering

The Unscented Information Filter (UIF) performs fusion of the state vector estimates which are provided by local Unscented Kalman Filters, by weighting these estimates with local Information matrices (inverse of the local state vector covariance matrices which are again recursively computed) (Lee, 2008b), (Lee, 2008a), (Vercauteren & Wang, 2005)]. The Unscented Information Filter is derived by introducing a linear error propagation based on the unscented transformation into the Extended Information Filter structure. First, an augmented state vector  $x_\alpha^-(k)$  is considered, along with the process noise vector, and the associated covariance matrix is introduced.

$$\hat{x}_\alpha^-(k) = \begin{pmatrix} \hat{x}^-(k) \\ \hat{w}^-(k) \end{pmatrix}, \quad P^{\alpha-}(k) = \begin{pmatrix} P^-(k) & 0 \\ 0 & Q^-(k) \end{pmatrix} \quad (58)$$

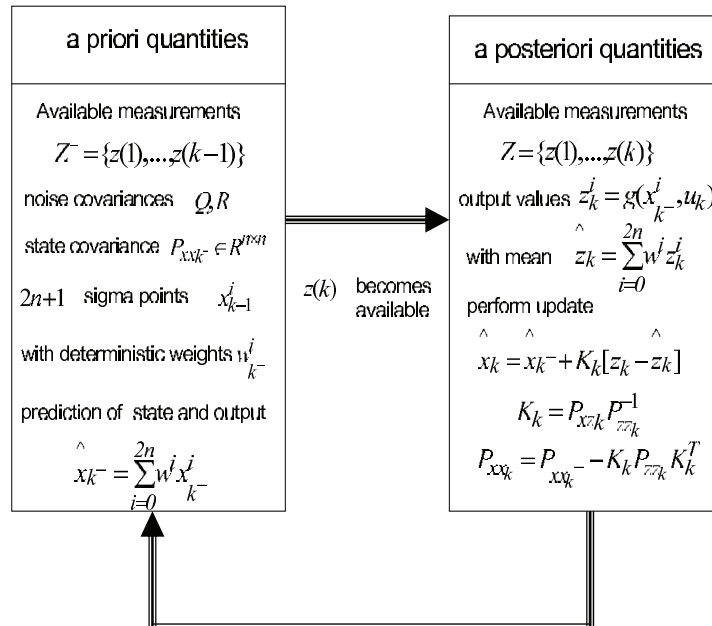

Fig. 7. Schematic diagram of the Unscented Kalman Filter loop

As in the case of local (lumped) Unscented Kalman Filters, a set of weighted sigma points  $X_{\alpha}^{i-}(k)$  is generated as

$$\begin{aligned}
 X_{\alpha,0}^{-}(k) &= \hat{x}_{\alpha}^{-}(k) \\
 X_{\alpha,i}^{-}(k) &= \hat{x}_{\alpha}^{-}(k) + [\sqrt{(n_{\alpha} + \lambda)P_{\alpha}^{-}(k-1)}]_i, \quad i = 1, \dots, n \\
 X_{\alpha,i}^{-}(k) &= \hat{x}_{\alpha}^{-}(k) + [\sqrt{(n_{\alpha} + \lambda)P_{\alpha}^{-}(k-1)}]_i, \quad i = n + 1, \dots, 2n
 \end{aligned}
 \tag{59}$$

where  $\lambda = \alpha^2(n_{\alpha} + \kappa) - n_{\alpha}$  is a scaling, while  $0 \leq \alpha \leq 1$  and  $\kappa$  are constant parameters. The corresponding weights for the mean and covariance are defined as in the case of the lumped Unscented Kalman Filter

$$\begin{aligned}
 W_0^{(m)} &= \frac{\lambda}{n_{\alpha} + \lambda} & W_0^{(c)} &= \frac{\lambda}{(n_{\alpha} + \lambda) + (1 - \alpha^2 + \beta)} \\
 W_i^{(m)} &= \frac{1}{2(n_{\alpha} + \lambda)}, \quad i = 1, \dots, 2n_{\alpha} & W_i^{(c)} &= \frac{1}{2(n_{\alpha} + \lambda)}, \quad i = 1, \dots, 2n_{\alpha}
 \end{aligned}
 \tag{60}$$

where  $\beta$  is again a constant parameter. The equations of the prediction stage (measurement update) of the information filter, i.e. the calculation of the information matrix and the information state vector of Eq. (36) now become

$$\begin{aligned}
 \hat{y}^{-}(k) &= Y^{-}(k) \sum_{i=0}^{2n_{\alpha}} W_i^m X_i^x(k) \\
 Y^{-}(k) &= P^{-}(k)^{-1}
 \end{aligned}
 \tag{61}$$

where  $X_i^x$  are the predicted state vectors when using the sigma point vectors  $X_i^w$  in the state equation  $X_i^x(k+1) = \phi(X_i^w(k)) + L(k)U(k)$ . The predicted state covariance matrix

is computed as

$$P^-(k) = \sum_{i=0}^{2n_\alpha} W_i^{(c)} [X_i^x(k) - \hat{x}^-(k)][X_i^x(k) - \hat{x}^-(k)]^T \quad (62)$$

As noted, the equations of the Extended Information Filter (EIF) are based on the linearized dynamic model of the system and on the inverse of the covariance matrix of the state vector. However, in the equations of the Unscented Kalman Filter (UKF) there is no linearization of the system dynamics, thus the UKF cannot be included directly into the EIF equations. Instead, it is assumed that the nonlinear measurement equation of the system given in Eq. (24) can be mapped into a linear function of its statistical mean and covariance, which makes possible to use the information update equations of the EIF. Denoting  $Y_i(k) = \gamma(X_i^x(k))$  (i.e. the output of the system calculated through the propagation of the  $i$ -th sigma point  $X^i$  through the system's nonlinear equation) the observation covariance and its cross-covariance are approximated by

$$P_{YY}^-(k) = E[(z(k) - \hat{z}^-(k))(z(k) - \hat{z}^-(k))^T] \simeq J_\gamma(k)P^-(k)J_\gamma(k)^T \quad (63)$$

$$P_{XY}^-(k) = E[(x(k) - \hat{x}^-(k))(z(k) - \hat{z}^-(k))^T] \simeq P^-(k)J_\gamma(k)^T \quad (64)$$

where  $z(k) = \gamma(x(k))$  and  $J_\gamma(k)$  is the Jacobian of the output equation  $\gamma(x(k))$ . Next, multiplying the predicted covariance and its inverse term on the right side of the information matrix Eq. (35) and replacing  $P(k)J_\gamma(k)^T$  with  $P_{XY}^-(k)$  gives the following representation of the information matrix (Lee, 2008b), (Lee, 2008a), (Vercauteren & Wang, 2005)

$$\begin{aligned} I(k) &= J_\gamma(k)^T R(k)^{-1} J_\gamma(k) \\ &= P^-(k)^{-1} P^-(k) J_\gamma(k)^T R(k)^{-1} J_\gamma(k) P^-(k)^T (P^-(k)^{-1})^T \\ &= P^-(k)^{-1} P_{XY}^-(k) R(k)^{-1} P_{XY}^-(k)^T (P^-(k)^{-1})^T \end{aligned} \quad (65)$$

where  $P^-(k)^{-1}$  is calculated according to Eq. (62) and the cross-correlation matrix  $P_{XY}(k)$  is calculated from

$$P_{XY}^-(k) = \sum_{i=0}^{2n_\alpha} W_i^{(c)} [X_i^x(k) - \hat{x}^-(k)][Y_i(k) - \hat{z}^-(k)]^T \quad (66)$$

where  $Y_i(k) = \gamma(X_i^x(k))$  and the predicted measurement vector  $\hat{z}^-(k)$  is obtained by  $\hat{z}^-(k) = \sum_{i=0}^{2n_\alpha} W_i^{(m)} Y_i(k)$ . Similarly, the information state vector  $i_k$  can be rewritten as

$$\begin{aligned} i(k) &= J_\gamma(k)^T R(k)^{-1} [z(k) - \gamma(x(k)) + J_\gamma(k)^T \hat{x}^-(k)] \\ &= P^-(k)^{-1} P^-(k) J_\gamma(k)^T R(k)^{-1} [z(k) - \gamma(x(k)) + J_\gamma(k)^T (P^-(k)^{-1})^T \hat{x}^-(k)] \\ &= P^-(k)^{-1} P_{XY}^-(k) R(k)^{-1} [z(k) - \gamma(x(k)) + P_{XY}^-(k) (P^-(k)^{-1})^T \hat{x}^-(k)] \end{aligned} \quad (67)$$

To complete the analogy to the information contribution equations of the EIF a "measurement" matrix  $H^T(k)$  is defined as

$$H(k)^T = P^-(k)^{-1} P_{XY}^-(k) \quad (68)$$

In terms of the "measurement" matrix  $H(k)$  the information contributions equations are written as

$$\begin{aligned} i(k) &= H^T(k) R(k)^{-1} [z(k) - \gamma(x(k)) + H(k) \hat{x}^-(k)] \\ I(k) &= H^T(k) R(k)^{-1} H(k) \end{aligned} \quad (69)$$

The above procedure leads to an implicit linearization in which the nonlinear measurement equation of the system given in Eq. (24) is approximated by the statistical error variance and its mean

$$z(k) = \gamma(x(k)) \simeq H(k)x(k) + \bar{u}(k) \quad (70)$$

where  $\bar{u}(k) = \gamma(\hat{x}^-(k)) - H(k)\hat{x}^-(k)$  is a measurement residual term.

### 5.3 Calculation of local estimations in terms of UIF information contributions

Next, the local estimations provided by distributed (local) Unscented Kalmans filters will be expressed in terms of the information contributions (information matrix  $I$  and information state vector  $i$ ) of the Unscented Information Filter, which were defined in Eq. (69) (Lee, 2008b), (Lee, 2008a), (Vercauteren & Wang, 2005). It is assumed that the observation vector  $\bar{z}_i(k+1)$  is available from  $N$  different sensors, and that each sensor observes a common state according to the local observation model, expressed by

$$\bar{z}_i(k) = H_i(k)x(k) + \bar{u}_i(k) + v_i(k) \quad (71)$$

where the noise vector  $v_i(k)$  is taken to be white Gaussian and uncorrelated between sensors. The variance of the composite observation noise vector  $v_k$  of all sensors is written in terms of the block diagonal matrix  $R(k) = \text{diag}[R_1(k)^T, \dots, R_N(k)^T]^T$ . Then one can define the local information matrix  $I_i(k)$  and the local information state vector  $i_i(k)$  at the  $i$ -th sensor, as follows

$$\begin{aligned} i_i(k) &= H_i^T(k)R_i(k)^{-1}[z_i(k) - \gamma^i(x(k)) + H_i(k)\hat{x}^-(k)] \\ I_i(k) &= H_i^T(k)R_i(k)^{-1}H_i(k) \end{aligned} \quad (72)$$

Since the information contribution terms have group diagonal structure in terms of the innovation and measurement matrix, the update equations for the multiple state estimation and data fusion are written as a linear combination of the local information contribution terms

$$\begin{aligned} \hat{y}(k) &= \hat{y}^-(k) + \sum_{i=1}^N i_i(k) \\ Y(k) &= Y^-(k) + \sum_{i=1}^N I_i(k) \end{aligned} \quad (73)$$

Then using Eq. (61) one can find the mean state vector for the multiple sensor estimation problem.

As in the case of the Unscented Kalman Filter, the Unscented Information Filter running at the  $i$ -th measurement processing unit can be written in terms of *measurement update* and *time update* equations:

*Measurement update:* Acquire measurement  $z(k)$  and compute

$$\begin{aligned} Y(k) &= P^-(k)^{-1} + H^T(k)R^{-1}(k)H(k) \\ \text{or } Y(k) &= Y^-(k) + I(k) \text{ where } I(k) = H^T(k)R^{-1}(k)H(k) \end{aligned} \quad (74)$$

$$\begin{aligned} \hat{y}(k) &= \hat{y}^-(k) + H^T(k)R^{-1}(k)[z(k) - \gamma(\hat{x}(k)) + H(k)\hat{x}^-(k)] \\ \text{or } \hat{y}(k) &= \hat{y}^-(k) + i(k) \end{aligned} \quad (75)$$

*Time update:* Compute

$$\begin{aligned} Y^-(k+1) &= (P^-(k+1))^{-1} \\ \text{where } P^-(k+1) &= \sum_{i=0}^{2n_x} W_i^{(c)} [X_i^x(k+1) - \hat{x}^-(k+1)][X_i^x(k+1) - \hat{x}^-(k+1)]^T \end{aligned} \quad (76)$$

$$\begin{aligned} \hat{y}(k+1) &= Y(k+1) \sum_{i=0}^{2n_x} W_i^{(m)} X_i^x(k+1) \\ \text{where } X_i^x(k+1) &= \phi(X_i^w(k)) + L(k)U(k) \end{aligned} \quad (77)$$

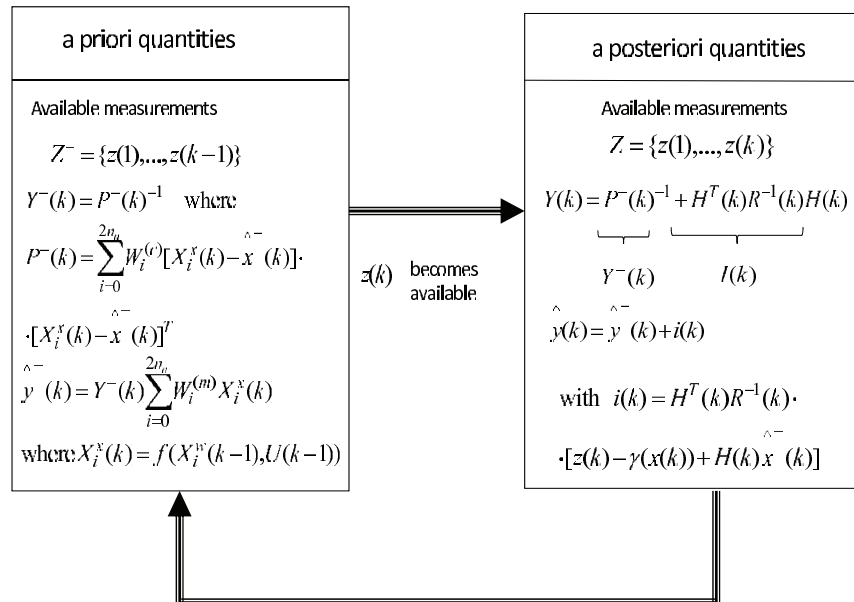

Fig. 8. Schematic diagram of the Unscented Information Filter loop

**5.4 Distributed unscented information filtering for state estimates fusion**

It has been shown that the update of the aggregate state vector of the Unscented Information Filter architecture can be expressed in terms of the local information matrices  $I_i$  and of the local information state vectors  $i_i$ , which in turn depend on the local covariance matrices  $P$  and cross-covariance matrices  $P_{XY}$ . Next, it will be shown that the update of the aggregate state vector can be also expressed in terms of the local state vectors  $x_i(k)$  and in terms of the local covariance matrices  $P_i(k)$  and cross-covariance matrices  $P_{XY}^i(k)$ . It is assumed that the local filters do not have access to each other row measurements and that they are allowed to communicate only their information matrices and their local information state vectors. Thus each local filter is expressed by its respective error covariance and estimate in terms of the local information state contribution  $i_i$  and its associated information matrix  $I_i$  at the  $i$ -th filter site. Then using Eq. (61) one obtains

$$P_i(k)^{-1} = P_i^-(k)^{-1} + H_i^T(k)R_i(k)^{-1}H_i(k) \tag{78}$$

$$\hat{x}_i = P_i(k)(P_i^-(k)\hat{x}_i^-(k) + H_i^T(k)R_i(k)^{-1}[z_i(k) - \gamma^i(x(k)) + H_i(k)\hat{x}_i^-(k)])$$

Using Eq. (78), each local information state contribution  $i_i$  and its associated information matrix  $I_i$  at the  $i$ -th filter are rewritten in terms of the computed estimates and covariances of the local filters

$$H_i^T(k)R_i(k)^{-1}H_i(k) = P_i^{-1}(k) - P_i^-(k)^{-1} \tag{79}$$

$$H_i^T(k)R_i(k)^{-1}[z_i(k) - \gamma^i(x(k)) + H_i(k)\hat{x}_i^-(k)] = P_i(k)^{-1}\hat{x}_i(k) - P_i^-(k)^{-1}\hat{x}_i^-(k)$$

where according to Eq.(68) it holds  $H_i(k) = P_i^-(k)^{-1}P_{XY,i}^-(k)$ . Next, the aggregate estimates of the distributed Unscented Information Filtering are derived for a number of  $N$  local

filters  $i = 1, \dots, N$  and sensor measurements, first in terms of covariances (Lee, 2008b),(Lee, 2008a),(Vercauteren & Wang, 2005).

$$\begin{aligned} P(k)^{-1} &= P^-(k)^{-1} + \sum_{i=1}^N [P_i(k)^{-1} - P_i^-(k)^{-1}] \\ \hat{x}(k) &= P(k)[P^-(k)^{-1}\hat{x}^-(k) + \sum_{i=1}^N (P_i(k)^{-1}\hat{x}_i(k) - P_i^-(k)^{-1}\hat{x}_i^-(k))] \end{aligned} \quad (80)$$

and also in terms of the information state vector and of the information state covariance matrix

$$\begin{aligned} \hat{y}(k) &= \hat{y}^-(k) + \sum_{i=1}^N (\hat{y}_i(k) - \hat{y}_i^-(k)) \\ Y(k) &= Y^-(k) + \sum_{i=1}^N [Y_i(k) - Y_i^-(k)] \end{aligned} \quad (81)$$

State estimation fusion based on the Unscented Information Filter (UIF) is fault tolerant. From Eq. (80) it can be seen that if a local filter (processing station) fails, then the local covariance matrices and local estimates provided by the rest of the filters will enable a reliable calculation of the system's state vector. Moreover, the UIF is computationally more efficient comparing to centralized filters and results in enhanced estimation accuracy.

## 6. Simulation tests

### 6.1 Estimation of target's position with the use of the extended information filter

The number of mobile robots used for target tracking in the simulation experiments was  $N = 10$ . However, since the mobile robots ensemble (mobile sensor network) is modular a larger number of mobile robot's could have been also considered. It is assumed that each mobile robot can obtain an estimation of the target's cartesian coordinates and bearing, i.e. the target's position  $[x, y]$  as well as the target's orientation  $\theta$ . To improve the accuracy of the target's localization, the target's coordinates and bearing are fused with the distance of the target from a reference surface measured in an inertial coordinates system (see Fig. 2 and 9).

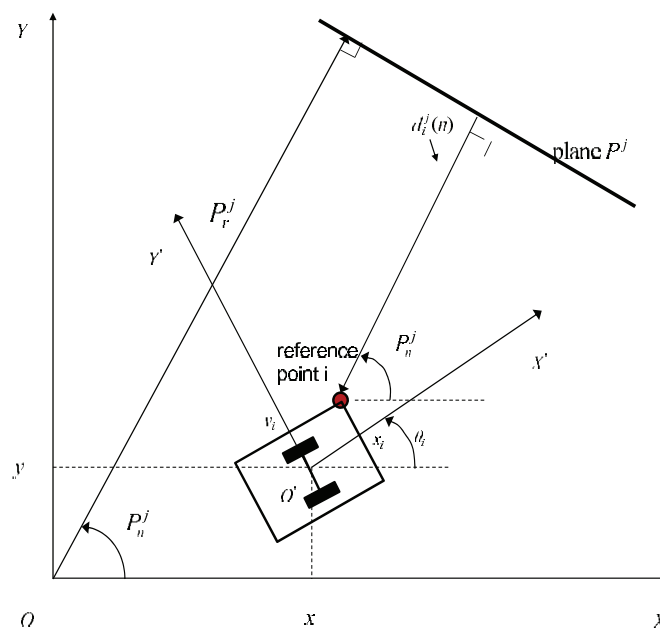

Fig. 9. Distance of the target's reference point  $i$  from the reference plane  $P^j$ , measured in the inertial coordinates system  $OXY$

The inertial coordinates system  $OXY$  is defined. Furthermore the coordinates system  $O'X'Y'$

is considered (Fig. 2).  $O'X'Y'$  results from  $OXY$  if it is rotated by an angle  $\theta$  (Fig. 2). The coordinates of the center of the wheels axis with respect to  $OXY$  are  $(x, y)$ , while the coordinates of the reference point  $i$  that is mounted on the vehicle, with respect to  $O'X'Y'$  are  $x'_i, y'_i$ . The orientation of the reference point with respect to  $O'X'Y'$  is  $\theta'_i$ . Thus the coordinates of the reference point with respect to  $OXY$  are  $(x_i, y_i)$  and its orientation is  $\theta_i$ , and are given by:

$$\begin{aligned} x_i(k) &= x(k) + x'_i \sin(\theta(k)) + y'_i \cos(\theta(k)) \\ y_i(k) &= y(k) - x'_i \cos(\theta(k)) + y'_i \sin(\theta(k)) \\ \theta_i(k) &= \theta(k) + \theta_i \end{aligned} \tag{82}$$

Each plane  $P^j$  in the robot's environment can be represented by  $P_r^j$  and  $P_n^j$  (Fig. 9), where (i)  $P_r^j$  is the normal distance of the plane from the origin  $O$ , (ii)  $P_n^j$  is the angle between the normal line to the plane and the  $x$ -direction.

The target's reference point  $i$  is at position  $x_i(k), y_i(k)$  with respect to the inertial coordinates system  $OXY$  and its orientation is  $\theta_i(k)$ . Using the above notation, the distance of the reference point  $i$ , from the plane  $P^j$  is represented by  $P_r^j, P_n^j$  (see Fig. 9):

$$d_i^j(k) = P_r^j - x_i(k) \cos(P_n^j) - y_i(k) \sin(P_n^j) \tag{83}$$

Assuming a constant sampling period  $\Delta t_k = T$  the measurement equation is  $z(k + 1) = \gamma(x(k)) + v(k)$ , where  $z(k)$  is the vector containing target's coordinates and bearing estimates obtained from a mobile sensor and the measurement of the target's distance to the reference surface, while  $v(k)$  is a white noise sequence  $\sim N(0, R(kT))$ . The measure vector  $z(k)$  can thus be written as

$$z(k) = [x(k) + v_1(k), y(k) + v_2(k), \theta(k) + v_3(k), d_1^j(k) + v_4(k)] \tag{84}$$

with  $i = 1, 2, \dots, n_s$ ,  $d_i^j(k)$  to be the distance measure with respect to the plane  $P^j$  and  $j = 1, \dots, n_p$  to be the number of reference surfaces. By definition of the measurement vector one has that the output function  $\gamma(x(k))$  is given by  $\gamma(x(k)) = [x(k), y(k), \theta(k), d_1^j(k)]$ .

To obtain the Extended Kalman Filter (EKF), the kinematic model of the target described in Eq. (2) is discretized and written in the discrete-time state-space form of Eq.(24) (Rigatos, 2009a),(Rigatos, 2010b).

The *measurement update* of the EKF is

$$\begin{aligned} K(k) &= P^-(k) J_\gamma^T(\hat{x}^-(k)) [J_\gamma(\hat{x}^-(k)) P^-(k) J_\gamma^T(\hat{x}^-(k)) + R(k)]^{-1} \\ \hat{x}(k) &= \hat{x}^-(k) + K(k) [z(k) - \gamma(\hat{x}^-(k))] \\ P(k) &= P^-(k) - K(k) J_\gamma^T P^-(k) \end{aligned}$$

The *time update* of the EKF is

$$\begin{aligned} P^-(k + 1) &= J_\phi(\hat{x}(k)) P(k) J_\phi^T(\hat{x}(k)) + Q(k) \\ \hat{x}^-(k + 1) &= \phi(\hat{x}(k)) + L(k) U(k) \end{aligned}$$

where

$$L(k) = \begin{pmatrix} T \cos(\theta(k)) & 0 \\ T \sin(\theta(k)) & 0 \\ 0 & T \end{pmatrix}$$



and

$$J_{\phi}(\hat{x}(k)) = \begin{pmatrix} 1 & 0 & -v(k)\sin(\theta)T \\ 0 & 1 & -v(k)\cos(\theta)T \\ 0 & 0 & 1 \end{pmatrix}$$

while  $Q(k) = \text{diag}[\sigma^2(k), \sigma^2(k), \sigma^2(k)]$ , with  $\sigma^2(k)$  chosen to be  $10^{-3}$  and  $\phi(\hat{x}(k)) = [\hat{x}(k), \hat{y}(k), \hat{\theta}(k)]^T$ ,  $\gamma(\hat{x}(k)) = [\hat{x}(k), \hat{y}(k), \hat{\theta}(k), d(k)]^T$ , i.e.

$$\gamma(\hat{x}(k)) = \begin{pmatrix} \hat{x}(k) \\ \hat{y}(k) \\ \hat{\theta}(k) \\ P_r^j - x_i(k)\cos(P_n^j) - y_i(k)\sin(P_n^j) \end{pmatrix} \quad (85)$$

The vector of the control input is given by  $U(k) = [v(k), \omega(k)]^T$ . Assuming one reference surface in the target's neighborhood one gets

$$J_{\gamma}^T(\hat{x}^-(k)) = [J_{\gamma_1}(\hat{x}^-(k)), J_{\gamma_2}(\hat{x}^-(k)), J_{\gamma_3}(\hat{x}^-(k)), J_{\gamma_4}(\hat{x}^-(k))]^T, \text{ i.e.}$$

$$J_{\gamma}^T(\hat{x}^-(k)) = \begin{pmatrix} 1 & 0 & 0 \\ 0 & 1 & 0 \\ 0 & 0 & 1 \\ -\cos(P_n^j) & -\sin(P_n^j) & \{x'_i\cos(\theta - P_n^j) - y'_i\sin(\theta - P_n^j)\} \end{pmatrix} \quad (86)$$

The use of EKF for fusing the target's coordinates and bearing measured by each mobile robot with the target's distance from a reference surface measured in an inertial coordinates system provides an estimation of the state vector  $[x(t), y(t), \theta(t)]$  and enables the successful tracking of the target's motion by the individual mobile robots (mobile sensors).

The tracking of the target by the swarm of the autonomous vehicles was tested in the case of several reference trajectories, both for motion in an environment without obstacles as well as for motion in a plane containing obstacles. The proposed distributed filtering scheme enabled accurate estimation of the target's state vector  $[x, y, \theta]^T$  through the fusion of the measurements of the target's coordinates and orientation obtained by each mobile robot with the measurement of the distance from a reference surface in an inertial coordinates frame. The state estimates provided by the Extended Kalman Filters running at each mobile sensor were fused into one single state estimate using Extended Information Filtering. The aggregate estimated coordinates of the target  $(\hat{x}^*, \hat{y}^*)$  provided the reference setpoint for the distributed motion planning algorithm. Each mobile sensor was made to move along the path defined by  $(\hat{x}^*, \hat{y}^*)$ . The convergence properties of the distributed motion planning algorithm were described in Section 3. The tracking of the target's trajectory by the mobile robots ensemble as well as the accuracy of the two-level sensor fusion-based estimation of the target's coordinates is depicted in Fig. 10 to Fig. 14. The target is marked as a thick-line rectangle and the associated reference trajectory is plotted as a thick line.

It is noted that using distributed EKFs and fusion through the Extended Information Filter is more robust comparing to the centralized EKF since (i) if a local processing unit is subject to a fault then state estimation is still possible and can be used for accurate localization of the target, as well as for tracking of target's trajectory by the individual mobile sensors (autonomous vehicles), (ii) communication overhead remains low even in the case of a large number of distributed mobile sensors, because the greatest part of state estimation procedure is performed locally and only information matrices and state vectors are communicated

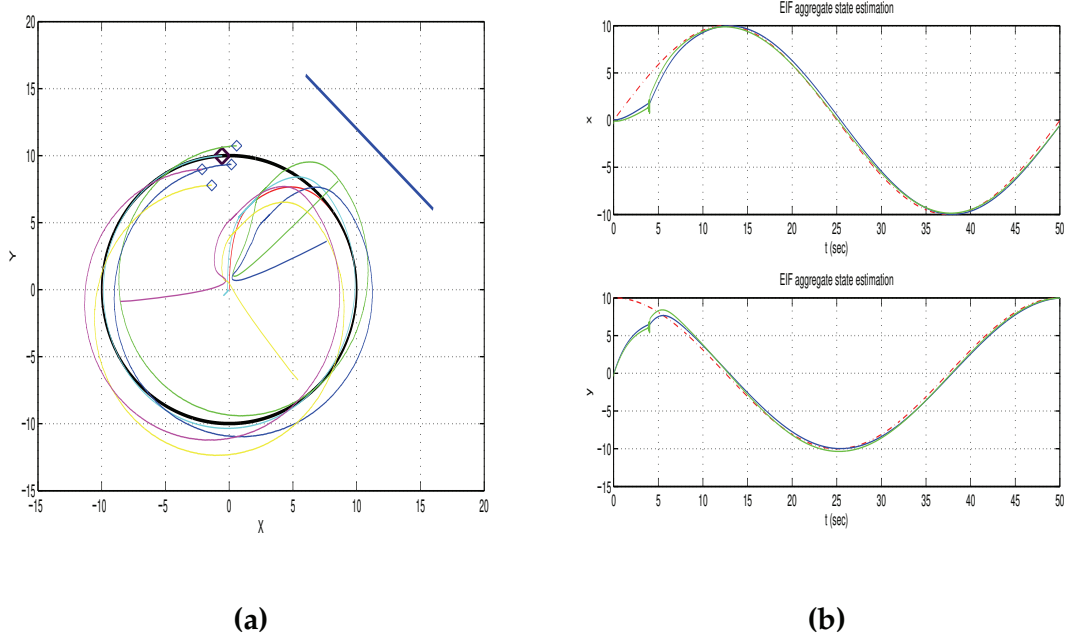

Fig. 10. (a) Distributed target tracking by an ensemble of autonomous vehicles when the target follows a circular trajectory in an obstacles-free motion space, (b) Aggregate estimation of the target's position with the use of Extended Information Filtering (continuous line) and target's reference path (dashed line).

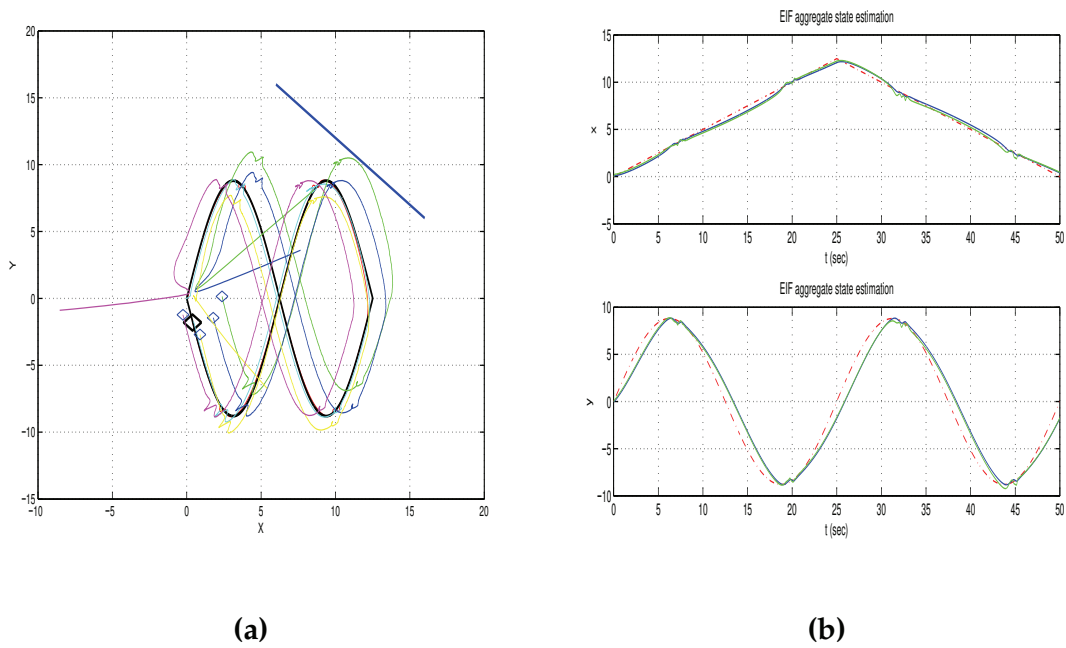

Fig. 11. (a) Distributed target tracking by an ensemble of autonomous vehicles when the target follows an eight-shaped trajectory in an obstacles-free motion space, (b) Aggregate estimation of the target's position with the use of Extended Information Filtering (continuous line) and target's reference path (dashed line)

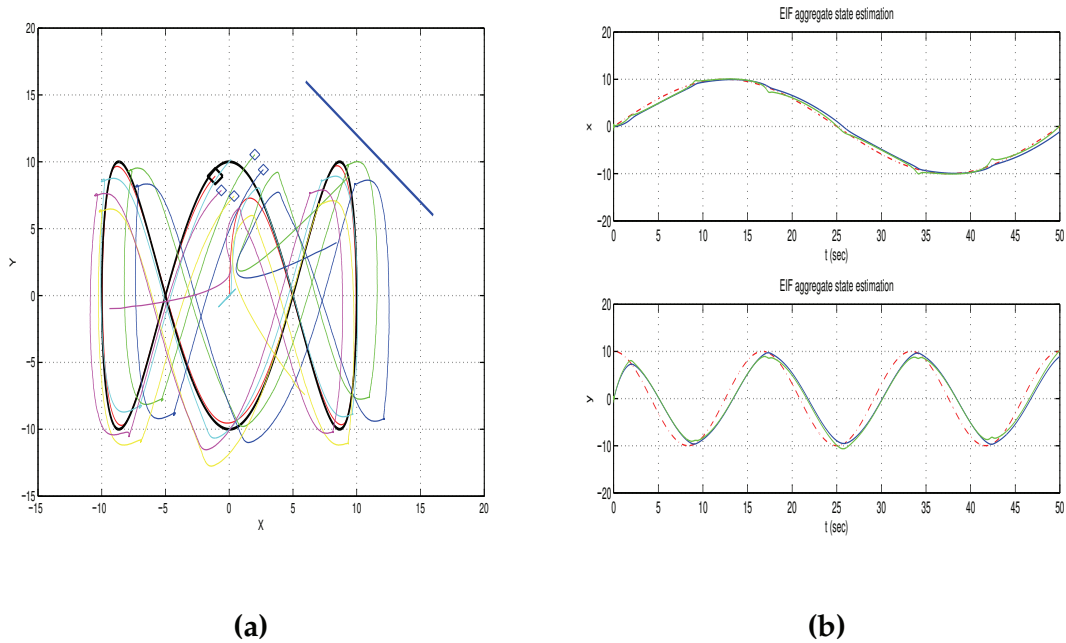

Fig. 12. (a) Distributed target tracking by an ensemble of autonomous vehicles when the target follows a curve-shaped trajectory in an obstacles-free motion space, (b) Aggregate estimation of the target's position with the use of Extended Information Filtering (continuous line) and target's reference path (dashed line).

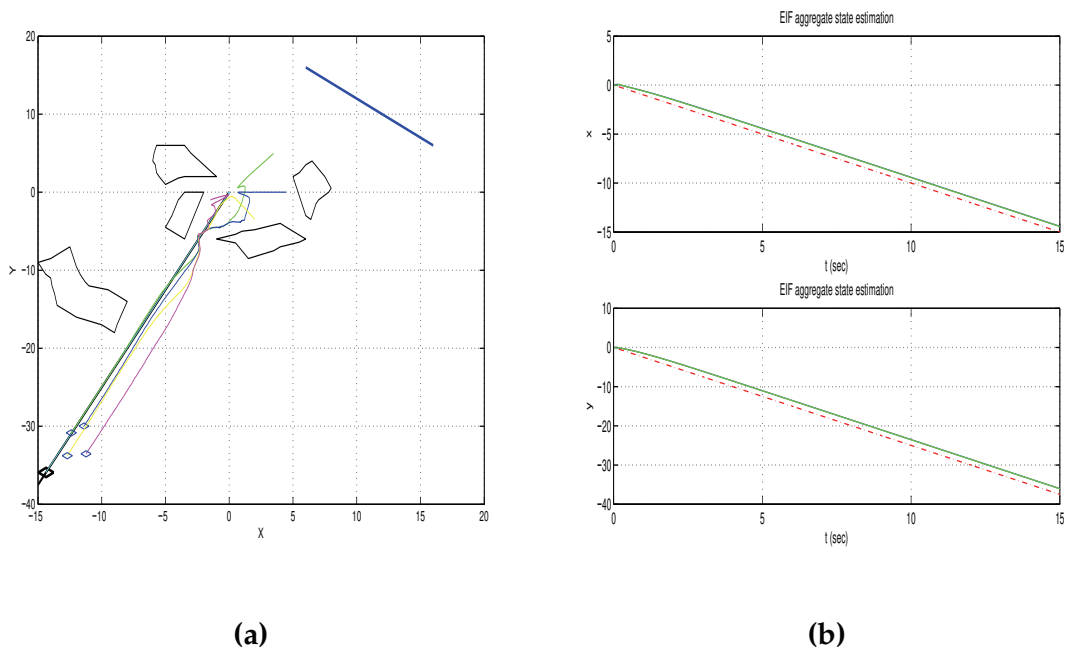

Fig. 13. (a) Distributed target tracking by an ensemble of autonomous vehicles when the target follows a line path in a motion space with obstacles, (b) Aggregate estimation of the target's position with the use of Extended Information Filtering (continuous line) and target's reference path (dashed line).

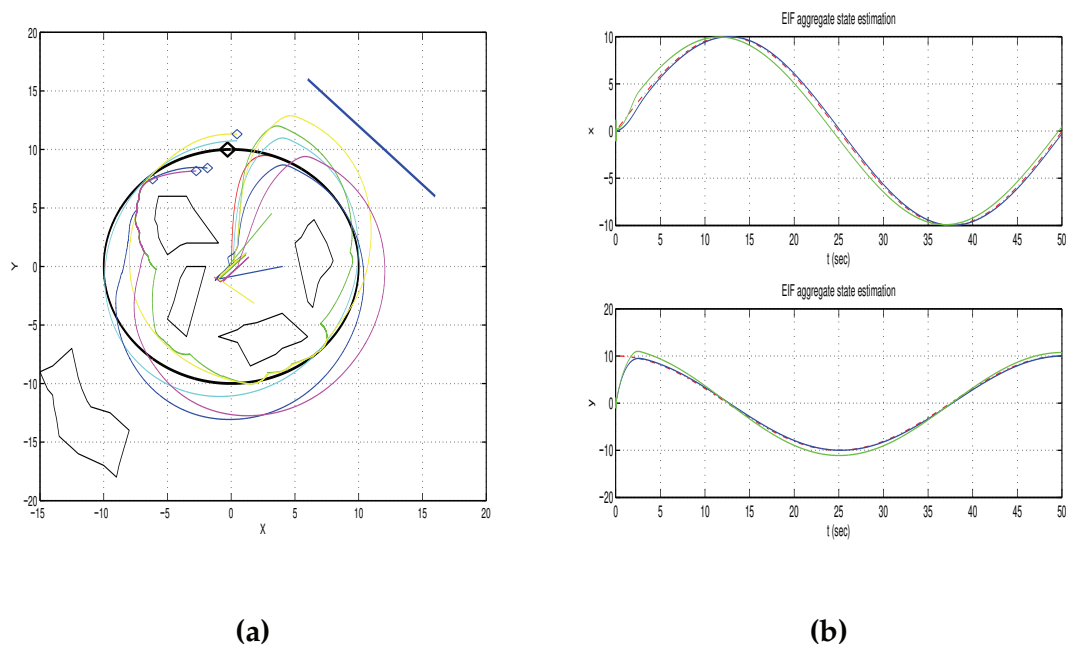

Fig. 14. (a) Distributed target tracking by an ensemble of autonomous vehicles when the target follows a circular path in a motion space with obstacles, (b) Aggregate estimation of the target's position with the use of Extended Information Filtering (continuous line) and target's reference path (dashed line).

between the local processing units, (iii) the aggregation performed on the local EKF also compensates for deviations in state estimates of local filters (which can be due to linearization errors).

## 6.2 Estimation of target's position with the use of unscented information filtering

Next, the estimation of the target's state vector was performed using the Unscented Information Filter. Again, the proposed distributed filtering enabled precise estimation of the target's state vector  $[x, y, \theta]^T$  through the fusion of measurements of the target's coordinates and bearing obtained by each mobile sensor with the distance of the target from a reference surface measured in an inertial coordinates system. The state estimates of the local Unscented Kalman Filters running at each mobile sensor (autonomous vehicle) were aggregated into a single estimation by the Unscented Information Filter. The estimated coordinates  $[\hat{x}^*, \hat{y}^*]$  of the target were used to generate the reference path which was followed by the mobile robots. The tracking of the target's trajectory by the mobile robots ensemble as well as the accuracy of the two-level sensor fusion-based estimation of the target's position is shown in Fig. 15 to Fig. 19.

As previously analyzed, the Unscented Information Filter is a derivative-free distributed filtering approach in which the local Unscented Kalman Filters provide estimations of the target's coordinates using the update in-time of a number of suitably chosen sigma-points. Therefore, unlike the Extended Information Filter and the local Extended Kalman Filters contained in it, in the Unscented Information Filter there is no need to calculate Jacobians through the computation of partial derivatives. Additionally, unlike the case of local Extended Kalman Filters there is no truncation of higher order Taylor expansion terms and

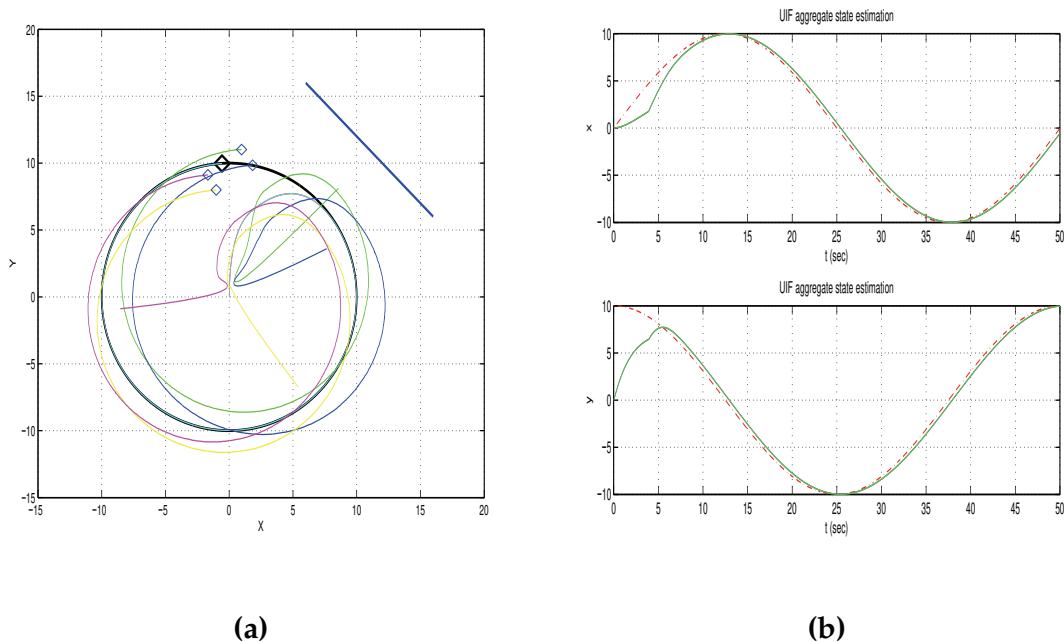

Fig. 15. (a) Distributed target tracking by an ensemble of autonomous vehicles when the target follows a circular trajectory in an obstacles-free motion space, (b) Aggregate estimation of the target's position with the use of Unscented Information Filtering (continuous line) and target's reference path (dashed line)

no linearization errors are introduced at the local estimators. In that sense the Unscented Information Filter provides a robust distributed state estimation and enables accurate tracking of the target by the mobile sensors (autonomous vehicles).

## 7. Conclusions

The paper has examined the problem of coordinated tracking of a target by an ensemble of mobile robots (unmanned ground vehicles). Each mobile robot was able to obtain measurements of the target's cartesian coordinates and orientation while a measurement of the target's distance from a reference surface in an inertial coordinates frame was also communicated to the mobile robots. The state estimates of local Extended Kalman Filters running at each mobile robot were fused into one single estimate using the Extended Information Filter. Similarly, the state estimates of local Unscented Kalman Filters running at each mobile sensor were aggregated by the Unscented Information Filter into one single estimation. The estimated coordinates of the target  $[\hat{x}^*, \hat{y}^*]$  were used to generate the reference path which was followed by the mobile robots. Next, a suitable motion planning algorithm was designed. The algorithm assured not only tracking of the reference path by the individual autonomous vehicles but also permitted (i) convergence of the autonomous vehicles to the target in a synchronized manner and (ii) avoidance of collisions with obstacles in the motion plane as well as avoidance of collisions between the autonomous vehicles. The performance of the distributed tracking algorithm was tested through simulation experiments.

Comparing to the traditional centralized or hierarchical fusion architecture, the network-centric architecture proposed by the paper has significant advantages which

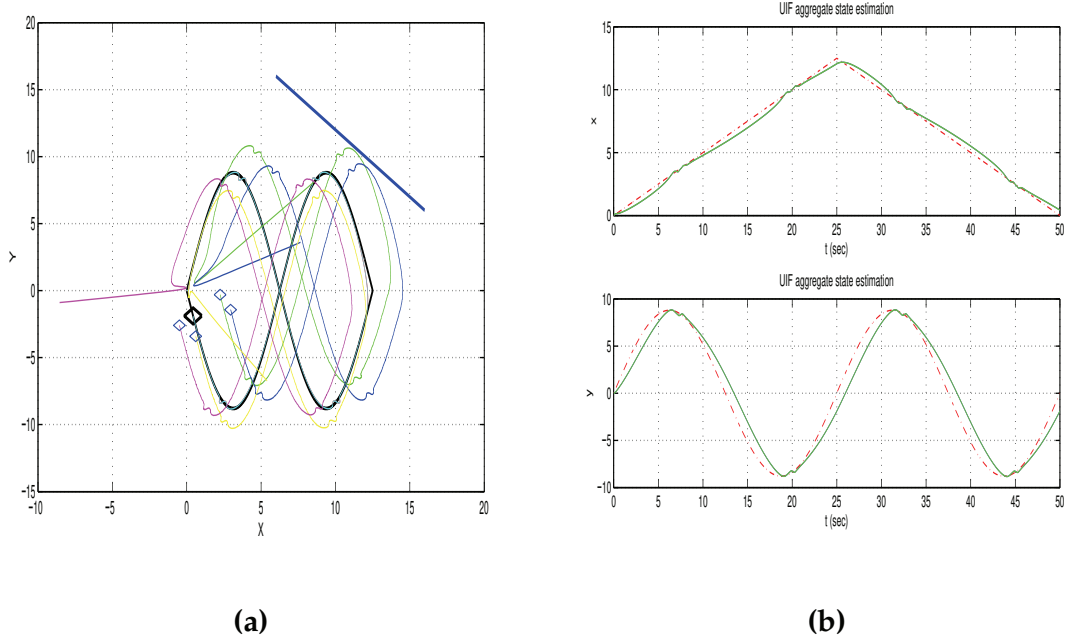

Fig. 16. (a) Distributed target tracking by an ensemble of autonomous vehicles when the target follows an eight-shaped trajectory in an obstacles-free motion space, (b) Aggregate estimation of the target's position with the use of Unscented Information Filtering (continuous line) and target's reference path (dashed line).

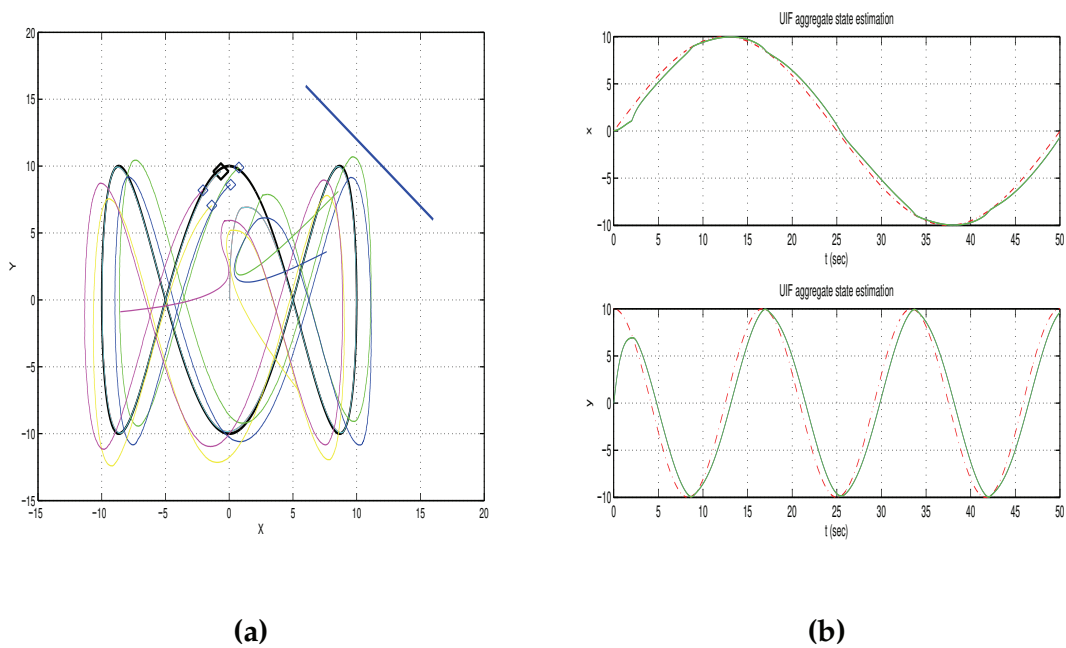
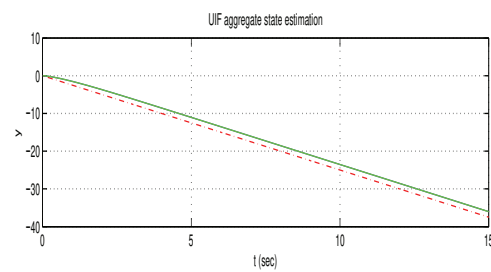
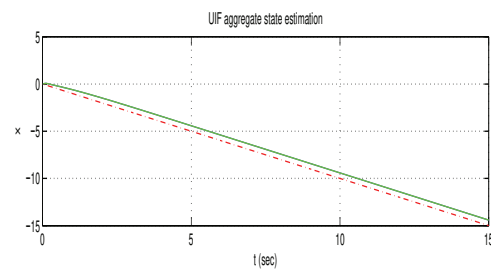
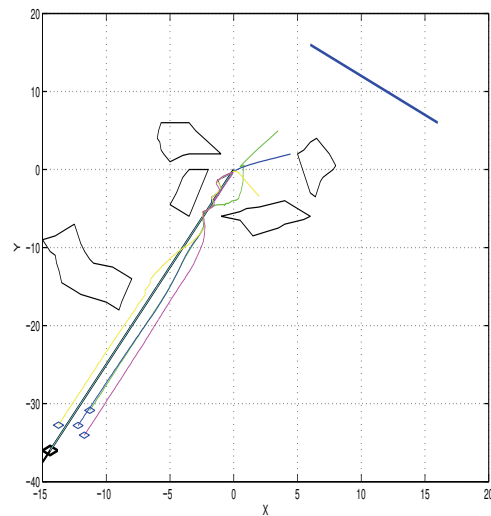

Fig. 17. (a) Distributed target tracking by an ensemble of autonomous vehicles when the target follows a curve-shaped trajectory in an obstacles-free motion space, (b) Aggregate estimation of the target's position with the use of Unscented Information Filtering (continuous line) and target's reference path (dashed line).



(a)

(b)

Fig. 18. (a) Distributed target tracking by an ensemble of autonomous vehicles when the target follows a line path in a motion space with obstacles, (b) Aggregate estimation of the target's position with the use of Unscented Information Filtering (continuous line).

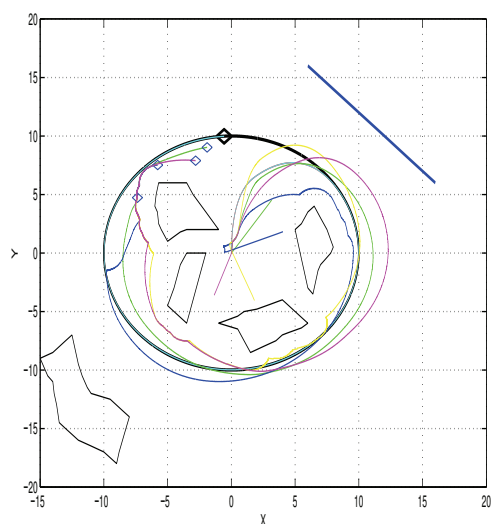

(a)

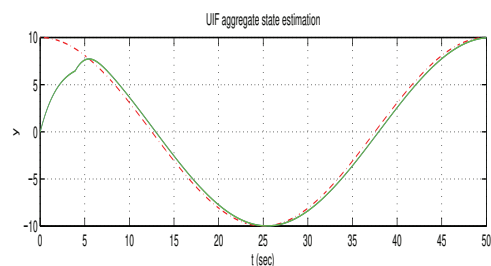
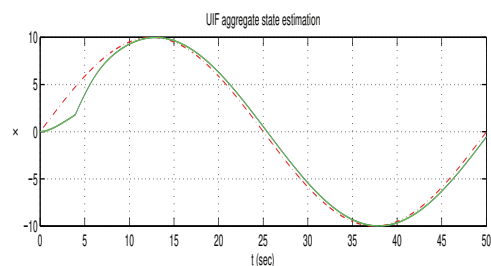

(b)

Fig. 19. (a) Distributed target tracking by an ensemble of autonomous vehicles when the target follows a circular path in a motion space with obstacles, (b) Aggregate estimation of the target's position with the use of Unscented Information Filtering (continuous line) and target's reference path (dashed line).



are summarized as follows: (i) Scalability: since there are no limits imposed by centralized computation bottlenecks or lack of communication bandwidth, every mobile robot (mobile sensor) can easily join or quit the system, (ii) Robustness: in a decentralized fusion architecture no element of the system is mission-critical, so that the system is survivable in the event of on-line loss of part of its partial entities (mobile robots), (iii) Modularity: every partial entity is coordinated and does not need to possess a global knowledge of the network topology.

Using distributed EKF or UKFs and fusion through the Extended Information Filter and the Unscented Kalman Filter respectively, is more robust comparing to the centralized EKF and centralized UKF since (i) if a local processing unit is subject to a fault then state estimation of the target's position is still possible and can be used for planning of the mobile robot's motion towards the target, (ii) communication overhead remains low even in the case of a large number of mobile robots, because the greatest part of state estimation is performed locally and only information matrices and state vectors are communicated between the local processing units.

## 8. References

- Benveniste, A.; Métivier, M. & Priouret, P. (1990). *Adaptive algorithms and stochastic approximations*, Springer.
- Bishop, B.E. (2003). On the use of redundant manipulator techniques for control of platoons of cooperative robotic vehicles. *IEEE Transactions on systems, Man and Cybernetics - Part A*, Vol. 33, No. 5, pp. 608-615, 2003.
- Comets, F. & Meyre, T. (2006). *Calcul stochastique et modèles de diffusions*. Dunod, 2006.
- Duflo, M. (1996). *Algorithmes stochastiques*, Mathématiques et Applications. Vol. 23, Springer, 1996.
- Elston, J. & Frew, E. (2007). Net-centric cooperative tracking of moving targets. *American Institute of Aeronautics and Astronautics (AIAA) 2007 Conference and Exhibit*, California, USA, May 2007.
- Gazi, V. & Passino, K. (2004). Stability analysis of social foraging swarms. *IEEE Transactions on Systems, Man and Cybernetics - Part B: Cybernetics*, Vol. 34, No. 1, pp. 539-557, 2004.
- Groß, R.; Bonani, M.; Mondada, F. & Dorigo, M. (2006). Autonomous self-assembly in swarm-bots, *IEEE Transactions on Robotics*, Vol. 22, No.6, pp. 1115-1130, 2006.
- Hong, Y.; Gao, L.; Cheng, D. & Hu, J. (2007). Luapunov-based approach to multi-agent systems with switching jointly connected interconnection. *IEEE Transactions on Automatic Control*, Vol.52, No.5, pp. 943-948, 2007.
- Fliess, M. & Mounier, H. (1999). Tracking control and  $\pi$ -freeness of infinite dimensional linear systems. *Dynamical Systems, Control, Coding and Computer Vision*, G. Picci and D.S. Gilliam (Eds.), Vol. 258, pp. 41-68, Birkhäuser, 1999.
- Julier, S.; Uhlmann, J. & Durrant-Whyte, H.F. (2000). A new method for the nonlinear transformations of means and covariances in filters and estimators. *IEEE Transactions on Automatic Control*, Vol.45, No.3, pp. 477-482, 2000.
- Julier, S.J. & Uhlmann, J.K. (2004). Unscented Filtering and Nonlinear Estimation. *Proceedings of the IEEE*, Vol.92, pp. 401-422, 2004.
- Khalil, H. (1996). *Nonlinear Systems*, Prentice Hall, 1996.
- Léchevin, N. & Rabbath, C.A. (2006). Sampled-data control of a class of nonlinear flat systems with application to unicycle trajectory tracking. *ASME Journal of Dynamical Systems, Measurement and Control*, Transactions of the ASME, Vol. 128, No. 3, pp. 722-728, 2006.

- Lee, D.J. (2008a). Nonlinear estimation and multiple sensor fusion using Unscented Information Filtering. *IEEE Signal Processing Letters*, Vol. 15, pp. 861-864, 2008.
- Lee, D.J. (2008b). Unscented Information Filtering for Distributed Estimation and multiple sensor fusion. *AIAA Guidance, Navigation and Control Conference and Exhibit*, Hawaii, USA, Aug. 2008.
- Manyika, J. and Durrant-Whyte, H. (1994). *Data fusion and sensor management: a decentralized information theoretic approach*. Englewood Cliffs, NJ, Prentice Hall, 1994.
- Masoud, S.A. & Masoud, A.A. (2002). Motion planning in the presence of directional and regional avoidance constraints using nonlinear, anisotropic, harmonic potential fields: a physical metaphor. *IEEE Transactions on Systems, Man and Cybernetics - Part A*, Vol. 32, No.6, pp. 705-723, 2002.
- Olfati-Saber, R. (2005). Distributed Kalman Filter with Embedded Consensus Filters. In: *Proc. 44th IEEE Conference on Decision and Control*, pp. 8179-8184, Seville, Spain, 2005.
- Olfati-Saber, R. (2007). Distributed tracking for mobile sensor networks with information-driven mobility. *American Control Conference, ACC 2007*, pp.4606-4612, New York, USA, 2007.
- Oriolo, G.; De Luca, A. & Vendittelli, M. (2002). WMR Control Via Dynamic Feedback Linearization: Design, Implementation and Experimental Validation. *IEEE Transactions on Control Systems Technology*, Vol. 10, No.6, pp. 835-852, 2002.
- Pagello, E.; D' Angelo, A. & Menegatti, E. (2006). Cooperation issues and distributed sensing for multi-robot systems. *Proceedings of the IEEE*, Vol. 94, No. 7, pp. 1370-1383, 2006.
- Rigatos, G.G. & Tzafestas, S.G. (2007). Extended Kalman Filtering for Fuzzy Modeling and Multi-Sensor Fusion. *Mathematical and Computer Modeling of Dynamical Systems*, Taylor and Francis, Vol. 13, No. 3, 2007.
- Rigatos, G.G. (2008a). Distributed gradient and particle swarm optimization for multi-robot motion planning. *Robotica*, Cambridge University Press, Vol. 26, No 3, pp. 357-370, 2008.
- Rigatos, G.G. (2008b). Coordinated motion of autonomous vehicles with the use of a distributed gradient algorithm. *Journal of Applied Mathematics and Computation*, Elsevier, Vol. 199, N. 2, pp. 494-503, 2008.
- Rigatos, G.G. (2008c). Distributed gradient and particle swarm optimization for multi-robot motion planning. *Robotica*, Cambridge University Press, Vol. 26, No. 3, pp. 357-370, 2008.
- Rigatos, G.G. (2009a). Particle Filtering for State Estimation in Nonlinear Industrial Systems. *IEEE Transactions on Instrumentation and Measurement*, Vol. 58, No. 11, pp. 3885-3900, 2009.
- Rigatos, G.G. (2009b). Sigma-point Kalman Filters and Particle Filters for integrated navigation of unmanned aerial vehicles. *Intl. Workshop on Robotics for Risky Interventions and Environmental Surveillance, RISE 2009*, Brussels, Belgium, Jan. 2009.
- Rigatos, G. & Zhang, Q. (2009) Fuzzy model validation using the local statistical approach. *Fuzzy Sets and Systems*, Elsevier, Vol. 60, No.7, pp. 882-904, 2009.
- Rigatos, G.G. (2010a). Distributed particle filtering over sensor networks for autonomous navigation of UAVs. In: *"Robot Manipulators"*, SciYo Publications, Croatia, 2010.
- Rigatos, G.G. (2010b). Extended Kalman and Particle Filtering for sensor fusion in motion control of mobile robots. *Mathematics and Computers in Simulation*, Elsevier, doi:10.1016/j.matcom.2010.05.003, 2010.
- Särrkä, S. (2007). On Unscented Kalman Filtering for state estimation of continuous-time

- nonlinear systems. *IEEE Transactions on Automatic Control*, Vol.52, No.9, pp.1631-1641, 2007.
- Sepulchre, R., Paley, D.A. & Leonard, N.E. (2007). Stabilization of planar collective motion: all to all communication, *IEEE Transactions on Automatic Control*, Vol. 52, No.5, pp. 811-824, 2007.
- Shima, T.; Rasmussen, S.J. & Chandler, P. (2007). UAV team decision and control using efficient collaborative estimation. *Journal of Dynamic Systems, Measurement and Control*, Transactions of the ASME, Vol. 129, No. 5, pp. 609-619, 2007.
- Sinha, A. & Ghose, D. (2006). Generalization of Linear Cyclic Pursuit with Application to Rendezvous of Multiple Autonomous Agents. *IEEE Transactions on Automatic Control*. Vol.51, No. 11, pp. 1819-1824, 2006.
- Vercauteren, T. & Wang, X. (2005). Decentralized Sigma-Point Information Filters for Target Tracking in Collaborative Sensor Networks. *IEEE Transactions on Signal Processing*. Vol.53, No.8, pp. 2997-3009, 2005.
- Villagra, J.; D'Andrea-Novell, B.; Mounier, H.; & Pengov, M. (2007). Flatness-based vehicle steering control strategy with SDRE feedback gains tuned via a sensitivity approach. *IEEE Transactions on Control Systems Technology*, Vol. 15, 554-565, 2007.
- Vissière, D.; Bristeau, P.-J.; Martin, A.P. & Petit, N. (2008). Experimental autonomous flight of a small-scaled helicopter using accurate dynamics model and low-cost sensors. *Proceedings of the 17th World Congress The International Federation of Automatic Control Seoul, Korea, July 6-11, 2008.*

IntechOpen

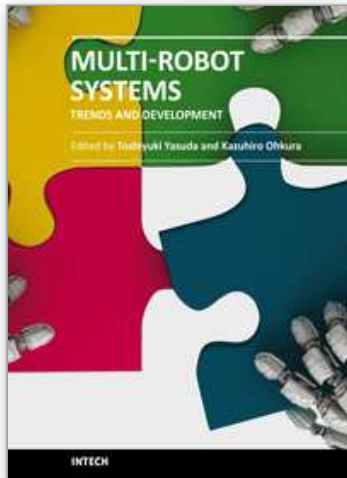

## **Multi-Robot Systems, Trends and Development**

Edited by Dr Toshiyuki Yasuda

ISBN 978-953-307-425-2

Hard cover, 586 pages

**Publisher** InTech

**Published online** 30, January, 2011

**Published in print edition** January, 2011

This book is a collection of 29 excellent works and comprised of three sections: task oriented approach, bio inspired approach, and modeling/design. In the first section, applications on formation, localization/mapping, and planning are introduced. The second section is on behavior-based approach by means of artificial intelligence techniques. The last section includes research articles on development of architectures and control systems.

### **How to reference**

In order to correctly reference this scholarly work, feel free to copy and paste the following:

Gerasimos Rigatos (2011). Target Tracking for Mobile Sensor Networks Using Distributed Motion Planning and Distributed Filtering, Multi-Robot Systems, Trends and Development, Dr Toshiyuki Yasuda (Ed.), ISBN: 978-953-307-425-2, InTech, Available from: <http://www.intechopen.com/books/multi-robot-systems-trends-and-development/target-tracking-for-mobile-sensor-networks-using-distributed-motion-planning-and-distributed-filteri>

# **INTECH**

open science | open minds

### **InTech Europe**

University Campus STeP Ri  
Slavka Krautzeka 83/A  
51000 Rijeka, Croatia  
Phone: +385 (51) 770 447  
Fax: +385 (51) 686 166  
[www.intechopen.com](http://www.intechopen.com)

### **InTech China**

Unit 405, Office Block, Hotel Equatorial Shanghai  
No.65, Yan An Road (West), Shanghai, 200040, China  
中国上海市延安西路65号上海国际贵都大饭店办公楼405单元  
Phone: +86-21-62489820  
Fax: +86-21-62489821

© 2011 The Author(s). Licensee IntechOpen. This chapter is distributed under the terms of the [Creative Commons Attribution-NonCommercial-ShareAlike-3.0 License](#), which permits use, distribution and reproduction for non-commercial purposes, provided the original is properly cited and derivative works building on this content are distributed under the same license.

IntechOpen

IntechOpen