

# We are IntechOpen, the world's leading publisher of Open Access books Built by scientists, for scientists

**4,800**

Open access books available

**122,000**

International authors and editors

**135M**

Downloads

Our authors are among the

**154**

Countries delivered to

**TOP 1%**

most cited scientists

**12.2%**

Contributors from top 500 universities



**WEB OF SCIENCE™**

Selection of our books indexed in the Book Citation Index  
in Web of Science™ Core Collection (BKCI)

Interested in publishing with us?  
Contact [book.department@intechopen.com](mailto:book.department@intechopen.com)

Numbers displayed above are based on latest data collected.

For more information visit [www.intechopen.com](http://www.intechopen.com)



# Monitoring of human movements for fall detection and activities recognition in elderly care using wireless sensor network: a survey

Stefano Abbate

*IMT Institute for Advanced Studies Lucca  
Italy*

Marco Avvenuti, Paolo Corsini and Alessio Vecchio

*University of Pisa  
Italy*

Janet Light

*University of New Brunswick  
Canada*

## 1. Introduction

The problem with accidental falls among elderly people has massive social and economic impacts. Falls in elderly people are the main cause of admission and extended period of stay in a hospital. It is the sixth cause of death for people over the age of 65, the second for people between 65 and 75, and the first for people over 75. Among people affected by Alzheimer's Disease, the probability of a fall increases by a factor of three.

Elderly care can be improved by using sensors that monitor the vital signs and activities of patients, and remotely communicate this information to their doctors and caregivers. For example, sensors installed in homes can alert caregivers when a patient falls. Research teams in universities and industries are developing monitoring technologies for in-home elderly care. They make use of a network of sensors including pressure sensors on chairs, cameras, and RFID tags embedded throughout the home of the elderly people as well as in furniture and clothing, which communicate with tag readers in floor mats, shelves, and walls.

A fall can occur not only when a person is standing, but also while sitting on a chair or lying on a bed during sleep. The consequences of a fall can vary from scrapes to fractures and in some cases lead to death. Even if there are no immediate consequences, the long-wait on the floor for help increases the probability of death from the accident. This underlines the importance of real-time monitoring and detection of a fall to enable first-aid by relatives, paramedics or caregivers as soon as possible.

Monitoring the activities of daily living (ADL) is often related to the fall problem and requires a non-intrusive technology such as a wireless sensor network. An elderly with risk of fall can be instrumented with (preferably) one wireless sensing device to capture and analyze the

body movements continuously, and the system triggers an alarm when a fall is detected. The small size and the light weight make the sensor network an ideal candidate to handle the fall problem.

The development of new techniques and technologies demonstrates that a major effort has been taken during the past 30 years to address this issue. However, the researchers took many different approaches to solve the problem without following any standard testing guidelines. In some studies, they proposed their own guidelines.

In this Chapter, a contribution is made towards such a standardization by collecting the most relevant parameters, data filtering techniques and testing approaches from the studies done so far. State-of-the-art fall detection techniques were surveyed, highlighting the differences in their effectiveness at fall detection. A standard database structure was created for fall study that emphasizes the most important elements of a fall detection system that must be considered for designing a robust system, as well as addressing the constraints and challenges.

### 1.1 Definitions

A *fall* can be defined in different ways based on the aspects studied. The focus in this study is on the kinematic analysis of the human movements. A suitable definition of a fall is “Unintentionally coming to the ground or some lower level and other than as a consequence of sustaining a violent blow, loss of consciousness, sudden onset of paralysis as in stroke or an epileptic seizure.” (Gibson et al., 1987). It is always possible to easily re-adapt this definition to address the specific goals a researcher wants to pursue.

In terms of human anatomy, a fall usually occurs along one of two planes, called *sagittal* and *coronal* planes. Figure 1(a) shows the sagittal plane, that is an X-Z imaginary plane that travels vertically from the top to the bottom of the body, dividing it into left and right portions. In this case a fall along the sagittal plane can occur forward or backward. Figure 1(b) shows the coronal Y-Z plane, which divides the body into dorsal and ventral (back and front) portions. The coronal plane is orthogonal to the sagittal plane and is therefore considered for lateral falls (right or left). Note that if the person is standing without moving, that is, he or she is in a *static* position, the fall occurs following in the down direction. The sense of x, y and z are usually chosen in order to have positive z-values of the acceleration component when the body is falling.

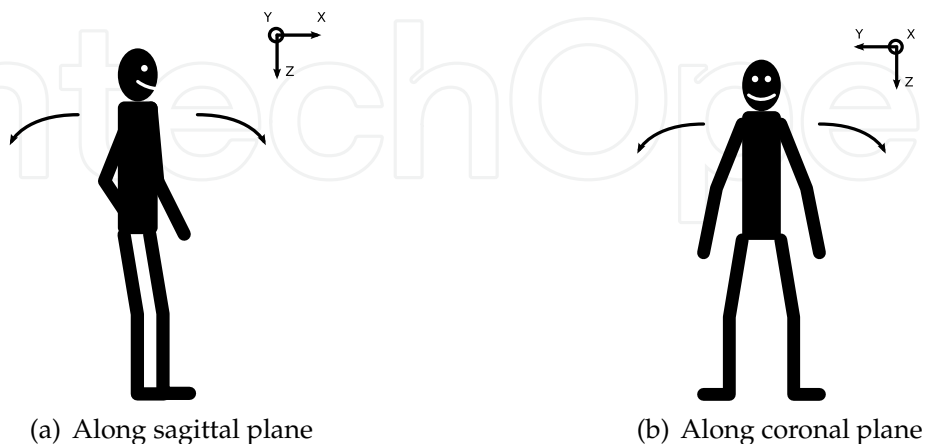

Fig. 1. Fall directions

*Toppling* simply refers to a loss in balance. Figure 2(a) shows the body from a kinematic point of view. When the vertical line through the center of gravity lies outside the base of support the body starts *toppling*. If there is no reaction to this loss of balance, the body falls on the ground (Chapman, 2008).

Let us now consider the fall of a body from a stationary position at height  $h = H$ . Initially the body has a potential energy  $mgh$  which is transformed into kinetic energy during the fall with the highest value just before the impact on the floor ( $h = 0$ ). During the impact the energy is totally absorbed by the body and, after the impact, both potential and kinetic energy are equal to zero. If the person is conscious the energy can be absorbed by the his muscles, for example, using the arms (see Figure 2(b)), whereas if the person is unconscious it can lead to sever injuries (see Figure 2(c)).

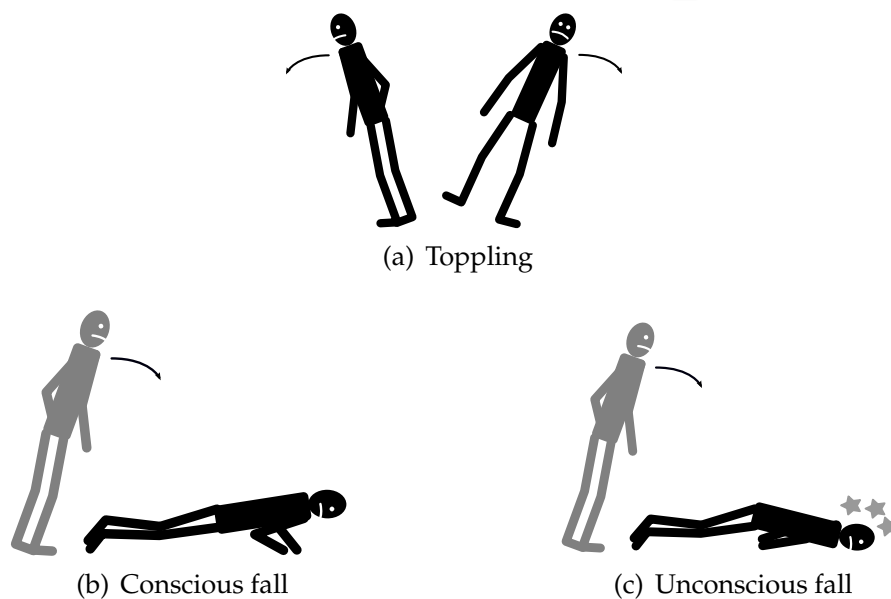

Fig. 2. Kinematic analysis of a fall

Strictly related to a fall is the *posture*, a configuration of the human body that is assumed intentionally or habitually. Some examples are standing, sitting, bending and lying. A posture can be determined by monitoring the tilt transition of the trunk and legs, the angular coordinates of which are shown in Figure 3(a) and Figure 3(b) (Li et al., 2009; Yang & Hsu, 2007). The ability to detect a posture helps to determine if there has been a fall.

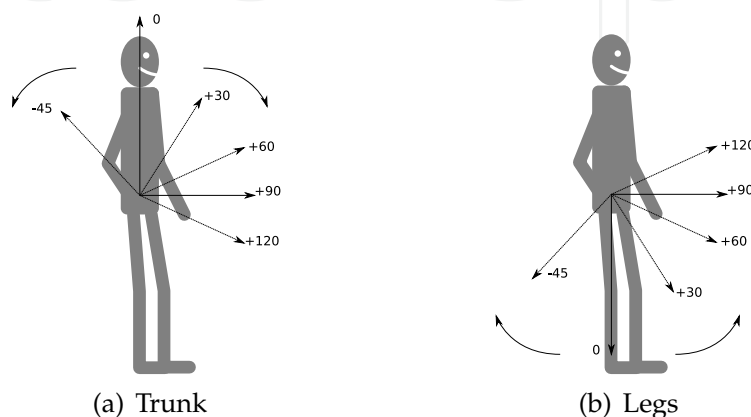

Fig. 3. Angular coordinates

## 1.2 Related Surveys of Research on Patient Monitoring Technologies

So far, a few surveys on fall detection systems have been written and extended. Some of them propose their own standards and this is useful for people already working on the problem of fall detection. This survey provides a comprehensive, if not exhaustive, guide from the first-hand approach of the problem, highlighting the best practices to merge valid but heterogeneous procedures.

The first survey on fall detection by Noury et al. (2007) describes the systems, algorithms and sensors used in the detection of a fall in elderly people. After an overview of the state-of-the-art techniques, they discovered the lack of a common framework and hence proposed some performance evaluation parameters in order to compare the different systems. These parameters had to be evaluated for a set of falling scenarios that included real falls and actions related to falls.

Yu (2008) focused on a classification of the approaches and principles of existing fall detection methods. He also provided a classification of falls and a general framework of fall detection, alert device and system schema.

The authors of Noury et al. (2007) described the in-depth sequence of falling (Noury et al., 2008). They stated that it was difficult to compare academic studies because the conditions of assessment are not always reported. This led to the evaluation of not only the above described parameters and scenarios, but also of other objective criteria such as detection method, usability and lifespan of a device.

In applications involving accelerometers, Kangas et al. (2007) used accelerometry-based parameters to determine thresholds for fall detection. The posture information was used to distinguish between falls and activities of daily living. Their experiments showed the most suitable placement for the sensor to be waist and the head, whereas placing the sensor on the wrist gave rise to additional problems.

## 2. Fall risk factors

A person can be more or less prone to fall, depending on a number of risk factors and hence a classification based on only age as a parameter is not enough. In fact, medical studies have determined a set of so called *risk factors*:

- Intrinsic:
  - Age (over 65)
  - Low mobility and bone fragility
  - Poor balance
  - Chronic disease
  - Cognitive and dementia problems
  - Parkinson disease
  - Sight problems
  - Use of drugs that affect the mind
  - Incorrect lifestyle (inactivity, use of alcohol, obesity)
  - Previous falls
- Extrinsic:
  - Individual (incorrect use of shoes and clothes)
  - Drugs cocktail

- Internal Environment:
  - Slipping floors
  - Stairs
  - Need to reach high objects
- External Environment:
  - Damaged roads
  - Crowded places
  - Dangerous steps
  - Poor lighting

There is a clear correlation between the above list and the probability of fall. The number of people that fall are as follows (Tinetti et al., 1988):

- 8% of people without any of risk factors
- 27% of people with only one risk factor
- 78% of people with four or more risk factors

The history of the falls is also important since people who have already fallen two times are more at risk to fall again. This can be due to psychological (fear, shame, loss of self-esteem), and/or physical (injuries, lack of exercise) reasons.

### 3. How, where and why people fall

Among elderly people that live at home, almost half of the falls take place near or inside the house (Campbell et al., 1990; Lipsitz et al., 1991). Usually women fall in the kitchen whereas men fall in the garden (Lord et al., 1993).

The rate of falls increases significantly among elderly people living in nursing homes: at least 40% of the patients fell twice or more within 6 months. This rate is five times more with respect to the rate of fall when people live at home. This may be due to people having to acquaint themselves with the new living environment and its obstacles.

#### 3.1 Physical causes

The factors that lead to most of the falls in people over 65 are to stumble on obstacles or steps and to slip on a smooth surface. The fall is usually caused by loss of balance due to dizziness. Approximately 14% of people do not know why they fall and a smaller number of people state that the fall is due to the fragility of the lower limbs (Lord et al., 1993).

Further researchers determined that traditional fall prevention measures such as bed rails can make the fall worse (Masud & Morris, 2001).

#### 3.2 Activities

Most of the falls happen during the activities of daily living (ADL) that involve a small loss of balance such as standing or walking. Fewer falls happen during daily activities that involve a more significant movement such as sitting on a chair or climbing the stairs. Conversely, activities usually defined "dangerous", such as jogging or physical exercises are less likely to increase the probability of a fall (Tinetti et al., 1988). There are more falls during the day than during the night (Campbell et al., 1990).

### **3.3 Consequences**

Accidental falls are the main cause of admission in a hospital and the sixth cause of death for people over 65. For people aged between 65 and 75 accidental falls are the second cause of death and the first cause in those over 75 (Bradley et al., 2009).

#### **3.3.1 Physical damage**

Scratches and bruises are the soft injuries due to a fall (Bradley et al., 2009). In the worst cases the injuries are concentrated on the lower part of the body, mainly on the hip. On the upper part of the body the head and the trunk injuries are the most frequent. About 66% of admissions to an hospital are due to at least one fracture. The fracture of elbow and forearm are more frequent but hip fracture is the most difficult to recover from. Such a fracture in fact requires a long recovery period and involves the loss of independence and mobility.

Sometimes, when a person falls and is not able to stand up by himself, he lies down on the floor for long time. This leads to additional health problems such as hypothermia, confusion, complications and in extreme cases can cause death (Lord et al., 2001).

#### **3.3.2 Psychological damage**

A fall also involves hidden damages that affect the self-confidence of a person (Lord et al., 2001). Common consequences are fear, loss of independence, limited capabilities, low self-esteem and generally, a lower quality of life.

#### **3.3.3 Economic damage**

The direct costs associated with falls are due to the medical examinations, hospital recoveries, rehabilitation treatments, tools of aid (such as wheelchairs, canes etc.) and caregivers service cost (Englander & Hodson, 1996).

Indirect costs concern the death of patients and their consequences. Recent studies have determined that in the year 2000 alone fall-related expenses was above 19 billion dollars and it is estimated to reach 54.9 billion in 2020. This shows that year by year, health costs due to the falls are increasing dramatically (Massachusetts Department of Public Health, 2008).

### **3.4 Anatomy of a fall**

A fall is generally the consequence of a normal activity of daily living and is triggered by a hard-predictable event such as tripping over, slipping or loss of balance. Once the fall and thus the impact on the floor occur, the subject usually lies down for some seconds or even hours and then tries to recover by himself or with the help of someone else. Just before the impact, the body of the subject is in a free-fall, its acceleration is the same as the gravitational acceleration. Thus, it is possible to distinguish five phases as depicted in Figure 4:

1. Activity of Daily Living
2. Hard-predictable event
3. Free-fall
4. Impact
5. Recovery (optional)

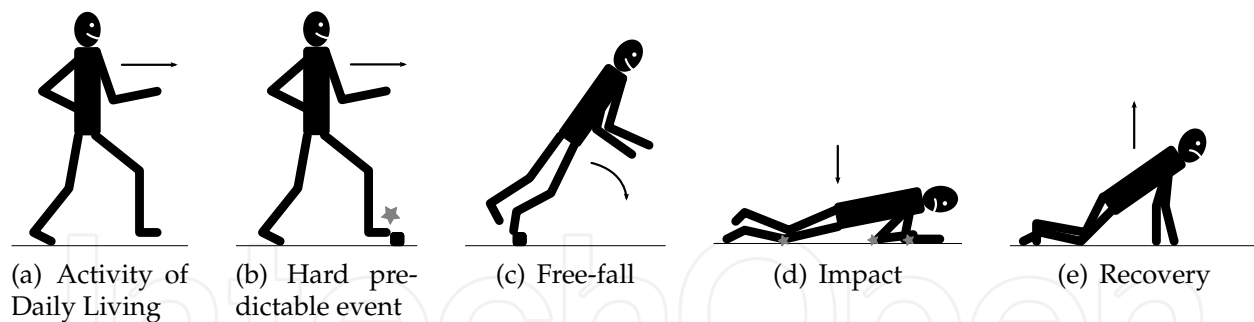

Fig. 4. Anatomy of a fall

Note that there are activities of daily living that can be wrongly detected as falls, e.g. “falling” on a chair.

#### 4. Typical fall scenarios

The most important scenarios of falls are described by Yu (2008) in detail:

- **Fall from standing**

1. It lasts from 1 to 2 seconds.
2. In the beginning the person is standing. At the end the head is stuck on the floor for a certain amount of time.
3. A person falls along one direction and the head and the center of mass move along a plane.
4. The height of the head varies from the height while standing and the height of the floor.
5. During the fall the head is in free-fall.
6. After the fall the head lays in a virtual circle that is centered in the position of the feet before the fall and has radius the height of the person.

- **Fall from chair**

1. It lasts from 1 to 3 seconds.
2. In the beginning the height of the head varies from the height of the chair to the height of the floor.
3. During the fall the head is in free-fall.
4. After the fall the body is near the chair.

- **Fall from bed**

1. It lasts from 1 to 3 seconds.
2. In the beginning the person is lying.
3. The height of the body varies from the height of the bed to the height of the floor.
4. During the fall the head is in free-fall.
5. After the fall the body is near the bed.



With the description of the main falls it is possible to simplify the complexity of a fall. This enables in turn to focus on the resolution of the detection fall problem, rather than on the reconstruction of a detailed scenario. The simplified and theoretical description often reflects the practical sequence of a fall.

## 5. Risk assessment tools

A risk assessment tool determines which people are at risk of falls that invoke specific countermeasures, to avoid or at least reduce any injuries (Perell et al., 2001; Vassallo et al., 2008). There are three fundamental types:

1. Medical exams performed by a geriatrician or other qualified people.
2. Risk factors evaluation performed in a hospital.
3. Evaluation of movement ability performed by a physiotherapist.

Medical exams take into account many parameters including the history of falls, drug therapy, strength, balance, diet and chronic diseases. However, they are only “descriptive” tools and hence do not provide numerical indexes. The risk factors evaluation is performed once a patient is admitted to a hospital and is based on specific methods and indexes. The evaluation is then periodically updated and is therefore more useful than the single assessment in the previous category. The analysis of a person at home performed by a physiotherapist can be more detailed but also more intrusive. Nevertheless, many researchers do not agree on the validity of such tools. Oliver (2008) suggests the characteristics essential to an effective risk assessment tool:

- Short-time period to be completed
- Parameters to address:
  1. High-risk faller
  2. Low-risk faller
  3. Falls prediction probability
  4. Non-falls prediction probability
  5. Prediction accuracy

An integrated and on-line monitoring service would provide updated data about the condition of a patient, a condition that can vary frequently especially in elder people. A step further from the monitoring of human movements is the monitoring of physiological parameters.

## 6. Technological approaches to fall detection

There are three main categories of devices based on the technology used:

- Vision-based
- Environmental
- Wearable

A *Vision-based* approach uses fixed cameras that continuously record the movement of the patients. The acquired data is submitted to specific image algorithms that are able to recognize the pattern of a fall to trigger an alarm. Vision-based approaches can be classified as:

1. *Inactivity detection*, based on the idea that after a fall, the patient lies on the floor without moving.
2. *Body shape change analysis*, based on the change of posture after the fall.
3. *3D head motion analysis*, based on the monitoring the position and velocity of the head.

The main limits of this approach are the time and cost of installation, the limited space of application (only where there are the cameras) and privacy violation.

The use of *Environmental* devices is an approach based on the installation of sensors in the places to be monitored. When people interact with the environment, infrared or pressure sensors on the floor are able to detect a fall. The problem here is the presence of false-negatives, for example, a fall that occurs on a table is not detected.

Both Visual-based and Environmental device approaches require a pre-built infrastructure, and this enables their use in hospitals and houses, but it is hard to use them outdoor.

In the *Wearable* approach, one or more wearable devices are worn by the patient. They are usually equipped with movement sensors such as accelerometers and gyroscopes, whose values are transmitted via radio and analyzed. This solution offers advantages such as low installation cost (indoor and outdoor), small size and offers the possibility to also acquire physiological data (blood pressure, ECG, EEG etc.).

## 7. Wireless sensor networks and general system architecture

A wireless sensor network is a set of spatially distributed sensing devices, also called nodes, that are able to communicate with each other in a wireless ad-hoc network paradigm (Akyildiz et al., 2002). Each device is usually battery-powered and can be instrumented with one or more sensors which enable acquisition of physical data such as temperature, body acceleration and so on. The nodes are able to organize themselves in order to create an ad-hoc routing tree, whose root is represented by a *sink* node. The sink node is usually connected to a personal computer, also called the *base station*, that will receive all the data sent by nodes (see Figure 5). Besides the sensing and wireless communication capabilities, the nodes feature a processing unit that enables local data treatment and filtering. This is important in order to reduce the use of the radio communication which is the most energy expensive task performed by a node with respect to sensing and processing.

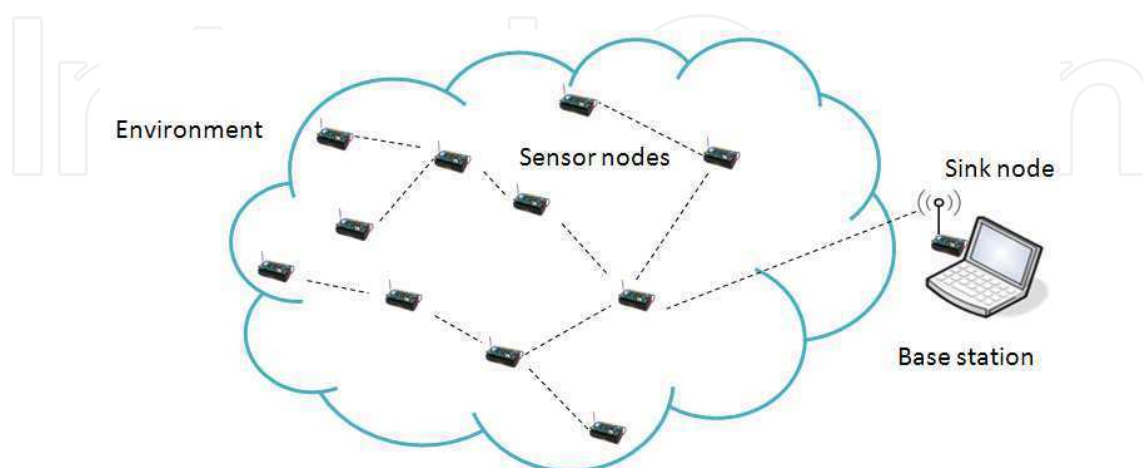

Fig. 5. Wireless Sensor Network topology

The light-weight characteristics of a wireless sensor network perfectly fit the needs of a fall detection system based on the wearable approach. The size, shape and weight of the nodes enable them to be worn easily by a person. Moreover, many general purpose nodes are commercially available at low-cost. According to the specific need of the study it is possible to obtain customized hardware with reduced form factor still maintaining the same functional characteristics. Figure 6(a) shows Tmote-Sky, a general purpose node that is able to sense temperature, humidity and light (Polastre et al., 2005), whereas Figure 6(b) shows SHIMMER, a smaller size version of the Tmote Sky which is more suitable to be worn by a person (Realtime Technologies LTD, 2008). The SHIMMER is equipped with a tri-axial accelerometer for movement monitoring and a Secure Digital (SD) slot to locally log a large amount of data. These platforms enable addition of other sensors such as gyroscopes, in the same board.

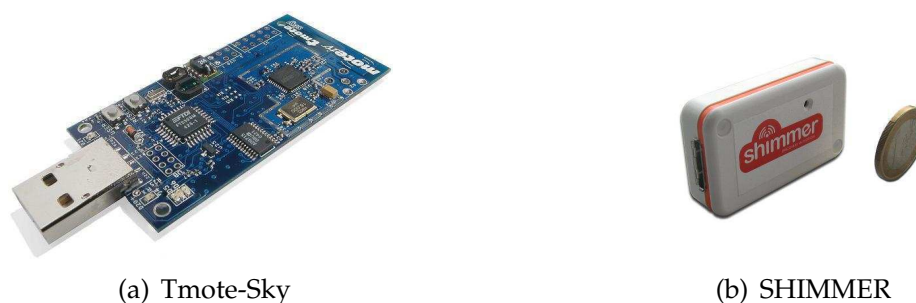

Fig. 6. Examples of nodes

Figure 7 shows the general architecture for a human movement monitoring system based on a wireless sensor network. One or more sensing nodes are used to collect raw data. Analysis of the data can be performed on the node or on the base station by a more powerful device such as a smartphone or a laptop. The wireless connectivity standard between the nodes (e.g. ZigBee) can be different from the one that connects the sink node with the base station (e.g. Bluetooth). The base station in turn acts as a gateway to communicate with the caregivers through wireless and/or wired data connection (e.g. Internet or other mobile phones).

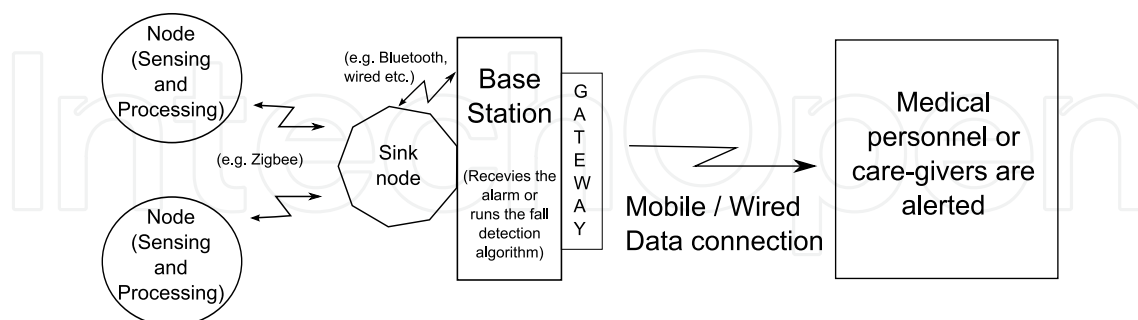

Fig. 7. Traditional system architecture

### 7.1 Node sensors and position

A node for kinematic monitoring is typically instrumented with the following sensors:

- Accelerometer, to measure the acceleration.
- Gyroscope, to measure the angular velocity.

In particular, the gyroscope requires more energy than the accelerometer. If we connect the acceleration of the movements with the position of the node worn by the patient, it would be possible to detect the posture of a person.

The placement of one or more nodes on the body is the key to differentiate the influences of various fall detection algorithms. It is not possible to neglect the usability aspect, since it strongly affects the effectiveness of the system. A node placed on the head gives an excellent impact detection capability, but more hardware efforts are required to ensure its usability for wearing the node continuously. The wrist is not recommended to be a good position, since it is subject to many high acceleration movements that would increase the number of false positives. The placement at the waist is more acceptable from the user point of the view, since this option fits well in a belt and it is closer to the center of gravity of the body. There are many other node locations selected by researchers, such as the armpit, the thigh or the trunk, quoting their own advantages and disadvantages as explained later. Sometimes the nodes are inserted in clothes, for example jackets, or in accessories such as watches or necklaces.

## 8. Performance evaluation parameters and scenarios

### 8.1 Indexes

A real working fall detection system requires to be sufficiently accurate in order to be effective and alleviate the work of the caregivers. The quality of the system is given by three indexes that have been proposed based on the four possible situations shown in Table 1:

	A fall occurs	A fall does not occur
A fall is detected	<i>True Positive (TP)</i>	<i>False Positive (FP)</i>
A fall is not detected	<i>False Negative (FN)</i>	<i>True Negative (TN)</i>

Table 1. Possible outputs of a Fall Detection system

- *Sensitivity* is the capacity to detect a fall. It is given by the ratio between the number of detected falls and the total falls that occurred:

$$\text{Sensitivity} = \frac{TP}{TP + FN} \quad (1)$$

- *Specificity* is the capacity to avoid false positives. Intuitively it is the capacity to detect a fall only if it really occurs:

$$\text{Specificity} = \frac{TN}{TN + FP} \quad (2)$$

- *Accuracy* is the ability to distinguish and detect both fall (TP) and non-fall movement (TN):

$$\text{Accuracy} = \frac{TP + TN}{P + N} \quad (3)$$

Where  $P$  and  $N$  are, respectively, the number of falls performed and the number of non-falls performed.

Accuracy (Equation 3) is a global index whereas sensitivity and specificity (Equations 1 and 2) enable a better understanding of the some limits of a system.

A fall exhibits high acceleration or angular velocity which are not normally achievable during the ADL. If we use a fixed low threshold to detect a fall, the sensitivity is 100% but the specificity is low because there are fall-like movements like sitting quickly on a chair, a bed or a sofa which might involve accelerations above that threshold.

## 8.2 Amplitude parameters

The logged data is sometimes pre-processed by applying some filters: a low-pass filter is used to perform posture analysis and a high-pass filter is applied to execute motion analysis. However, this processing is not mandatory and it strongly depends on the fall detection algorithm. The calibration of the sensors is sometimes neglected or not mentioned in research studies, but it is an important element that ensures a stable behavior of the system over time.

Amplitude parameters are useful during specific phases of the fall (Dai et al., 2010; Kangas et al., 2007; 2009).

The *Total Sum Vector* given in Equation 4 is used to establish the start of a fall:

$$SV_{TOT}(t) = \sqrt{(A_x)^2 + (A_y)^2 + (A_z)^2} \quad (4)$$

where  $A_x$ ,  $A_y$ ,  $A_z$  are the gravitational accelerations along the x, y, z-axis.

The *Dynamic Sum Vector* is obtained using the Total Sum Vector formula applied to accelerations that are filtered with a high-pass filter taking into account fast movements.

The *MaxMin Sum Vector* given in Equation 5 is used to detect fast changes in the acceleration signal, which are the differences between the maximum and minimum acceleration values in a fixed-time ( $\Delta t = t_1 - t_0$ ) sliding window for each axis.

$$SV_{MaxMin}(\Delta t) = \max_{t_0 \leq i \leq t_1} SV_{TOT}(i) - \min_{t_0 \leq j \leq t_1} SV_{TOT}(j) \quad (5)$$

*Vertical acceleration* given in Equation 6 is calculated considering the sum vectors  $SV_{TOT}(t)$  and  $SV_D(t)$  and the gravitational acceleration  $G$ .

$$Z_2 = \frac{SV_{TOT}^2(t) - SV_D^2(t) - G^2}{2G} \quad (6)$$

## 8.3 Fall Index

Fall Index in Equation 7 is proposed by (Yoshida et al., 2005). For any sample  $i$  in a fixed time window, the Fall Index can be calculated as:

$$FI_i = \sqrt{\sum_{i-19}^i ((A_x)_i - (A_x)_{i-1})^2 + \sum_{i-19}^i ((A_y)_i - (A_y)_{i-1})^2 + \sum_{i-19}^i ((A_z)_i - (A_z)_{i-1})^2} \quad (7)$$

Since the Fall Index (FI) requires high sampling frequency and fast acceleration changes, it will miss falls that happen slowly. Hence, FI is not used unless researchers want to compare the performances of their systems with previous studies that have used it.

#### 8.4 Standard trial scenarios and characteristics

Researcher should agree on a common set of trials in order to test and compare different fall detection systems. In Table 2 we propose a set of actions for which a fall detection system should always detect a fall. In Table 3 we propose a set of fall-like activities of daily living that can lead the system to output false positives. In addition to performing tests on all the listed 36 actions, each research group can combine them in sequential protocols, called *circuits* (e.g. sitting, standing, walking, falling).

#	Name	Symbol	Direction	Description
1	Front-lying	FLY	Forward	From vertical going forward to the floor
2	Front-protecting-lying	FPLY	Forward	From vertical going forward to the floor with arm protection
3	Front-knees	FKN	Forward	From vertical going down on the knees
4	Front-knees-lying	FKLY	Forward	From vertical going down on the knees and then lying on the floor
5	Front-right	FR	Forward	From vertical going down on the floor, ending in right lateral position
6	Front-left	FL	Forward	From vertical going down on the floor, ending in left lateral position
7	Front-quick-recovery	FQR	Forward	From vertical going on the floor and quick recovery
8	Front-slow-recovery	FSR	Forward	From vertical going on the floor and slow recovery
9	Back-sitting	BS	Backward	From vertical going on the floor, ending sitting
10	Back-lying	BLY	Backward	From vertical going on the floor, ending lying
11	Back-right	BR	Backward	From vertical going on the floor, ending lying in right lateral position
12	Back-left	BL	Backward	From vertical going on the floor, ending lying in left lateral position
13	Right-sideway	RS	Right	From vertical going on the floor, ending lying
14	Right-recovery	RR	Right	From vertical going on the floor with subsequent recovery
15	Left-sideway	LS	Left	From vertical going on the floor, ending lying
16	Left-recovery	LR	Left	From vertical going on the floor with subsequent recovery
17	Syncope	SYD	Down	From standing going on the floor following a vertical trajectory
18	Syncope-wall	SYW	Down	From standing going down slowly slipping on a wall
19	Podium	POD	Down	From vertical standing on a podium going on the floor
20	Rolling-out-bed	ROBE	Lateral	From lying, rolling out of bed and going on the floor

Table 2. Actions to be detected as falls

#	Name	Symbol	Direction	Description
21	Lying-bed	LYBE	Lateral	From vertical lying on the bed
22	Rising-bed	RIBE	Lateral	From lying to sitting
23	Sit-bed	SIBE	Backward	From vertical sitting with a certain acceleration on a bed (soft surface)
24	Sit-chair	SCH	Backward	From vertical sitting with a certain acceleration on a chair (hard surface)
25	Sit-sofa	SSO	Backward	From vertical sitting with a certain acceleration on a sofa (soft surface)
26	Sit-air	SAI	Backward	From vertical sitting in the air exploiting the muscles of legs
27	Walking	WAF	Forward	Walking
28	Jogging	JOF	Forward	Running
29	Walking	WAB	Backward	Walking
30	Bending	BEX	Forward	Bending of about X degrees (0-90)
31	Bending-pick-up	BEP	Forward	Bending to pick up an object on the floor
32	Stumble	STU	Forward	Stumbling with recovery
33	Limp	LIM	Forward	Walking with a limp
34	Squatting-down	SQD	Down	Going down, then up
35	Trip-over	TRO	Forward	Bending while walking and than continue walking
36	Coughing-sneezing	COSN	-	-

Table 3. Activities that must not be detected as falls

#### 8.4.1 Participant characteristics

Different people have different physical characteristics and therefore it is extremely important to specify, for each trial, the following five parameters:

- Gender
- Age
- Weight
- Height
- Body Mass Index <sup>1</sup>

#### 8.4.2 Hardware characteristics

Variation among the technology of the nodes depends on their level of the development and manufacturing cost. It is therefore important to define some basic characteristics for the hardware used in trials:

- Model
- Sampling frequency
- Update rate
- Movement detection delay time
- Range of measurement
- Size

<sup>1</sup> Body mass index (BMI) is a measure of body fat based on height and weight that applies to adult men and women.

- Weight
- Wired/wireless communication protocol

### 9. Falls study database

Data acquisition is probably the most difficult and time-consuming portion in a fall-detection study. In the best case, log files of fall trials contain raw accelerations measured during the simulation of an action (fall or ADL). If other researchers want to access and use such raw accelerations, it is necessary to provide an accurate description of the trials. Moreover, previous studies generally describe the tests performed and the results obtained, but the acceleration data is usually not publicly made available. This points out the need for a database with a standard structure to store all the logs. Such a database is intended to be available to the scientific community and has two main advantages: on one hand the possibility of storing and sharing data coming from sensors following a standard format; on the other hand, the availability of raw sensed data before, during, and after a fall or an activity of daily living that enables the researchers to test and validate fall detection algorithms using the same test-beds. A trial or *experiment* is described in terms of the *action* performed, the *configuration* used for the wearable device and the *user's profile*. Human actions under study are all characterized by the following aspects: *i) posture*: users have a particular body orientation before and after the action is performed; *ii) surface*: user's body is supported by a particular kind of surface before and after the action is performed. A configuration establishes a particular way to sense kinematic data, and it can be described in terms of the following: *i) position*: the device is worn at some body position; *ii) device used*: the type of sensor node adopted for the collection of data. The Entity-Relationship model depicted in Figure 8 is derived from the previous considerations.

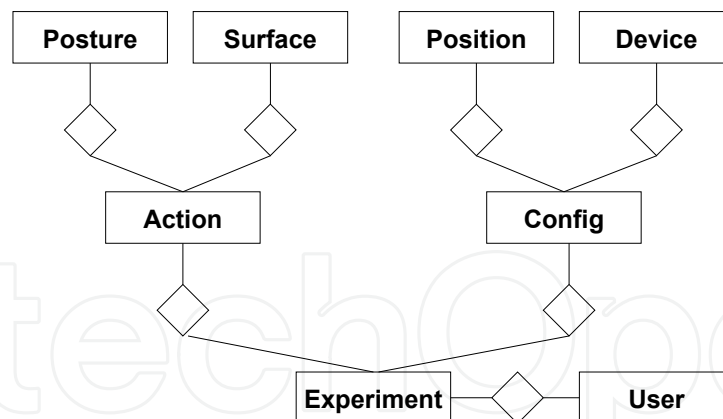

Fig. 8. Database Entity-Relationship diagram

A possible structure of the table is the following:

Postures (ID, posture)

Surfaces (ID, surface)

Action (ID, starting\_posture, starting\_surface, ending\_posture, ending\_surface, description)



Position (ID, position)

Device (ID, manufacturer, model, description, characteristics)

Configuration (ID, record\_content, Mote, scale\_G, sample\_frequency,  
Body\_position, x\_direction, y\_direction, z\_direction)

Users (ID, age, gender, height\_cm, weight\_kg, body\_mass\_index)

Experiments (ID, Configuration, Action, User, content)

Note that we decided to collect, represent, and store extra information, such as the posture of the user before and after a potential fall, the separate acceleration values and acceleration magnitude as-well. This has been done to foster the reuse of the collected data and to enable the evaluation of future techniques on the same sets of data.

## 10. Overview of fall detection algorithms

From what has been explained so far, many different approaches have been taken to solve the fall detection problem using accelerometers. The basic and trivial system uses a threshold to establish if a person falls, which is subject to many false positives. Some researchers have tried to introduce computationally-hard type of intensive algorithms but the goal has been always to find a trade-off between the system accuracy and the cost.

Depeursinge et al. (2001) used a two-level neural network algorithm to analyze the accelerations given by two sensors placed in distinct parts of the body. Such accelerations are translated into spatial coordinates and fed into the algorithm. The output of the system represents the probability that a fall is happening: if the probability is low, the system continues monitoring whereas if the probability is medium or high, the system generates an alarm unless the person presses a button.

Clifford et al. (2007) developed a system composed of a series of accelerometers, a processor and a wireless transceiver. The acquired acceleration data is constantly compared with some standard values. If there is a fall event, the processor sends an alarm signal to a remote receiver. A similar approach is given by Lee et al. (2007) using a sensor module and an algorithm to detect posture, activity and fall. For long range communication with the base station, there are intermediate nodes that act as repeaters. The sensitivity was 93.2%.

Lindemann et al. (2005) used an acoustic device on the rear side of the ear, to measure velocity and acceleration. Also Wang et al. (2008) used a sensor on the head of the patient since it increases the accuracy of the detection.

The Inescapable Smart Impact detection System ISIS (Prado-Velasco et al., 2008) used a sensor with an accelerometer and a smartphone as base station. Moving the processing to the smartphone extended the lifetime of the batteries and the usability of the sensor. They achieved 100% sensitivity with reduction in specificity.

Other methods are based on the body posture and use more than one sensor. Some researchers divided the human activities into two parts: static position and dynamic transition (Li et al., 2009). They used two sensors both with an accelerometer and a gyroscope, one placed on the chest and the other on the thigh. The gyroscope helped to decrease the false positives.

Noury et al. (2003) used a sensor with two accelerometers, one orthogonal to the other and placed under the armpit. The fall is detected on the basis of the inclination of the chest and its velocity. The alarm is not raised if the patient presses a button on time, avoiding thus false alarms. An experimental evaluation showed levels of sensitivity and specificity equal to 81%.

In a similar study researchers used a device with three different sensors for body posture detection, vibration detection and to measure vertical acceleration (Noury et al., 2000). Data was processed by the base station. The sensitivity and specificity here were 85%.

Other researchers developed a real-time algorithm for automatic recognition of physical activities and their intensities (Tapia et al., 2007). They used five accelerometers placed on the wrist, the ankle, the upper arm, the upper thigh and the hip. In addition, they used a heart rate monitor placed on the chest. Trials have been conducted on 21 people for 30 different physical activities such as lying down, standing, walking, cycling, running and using the stairs. Data analyzed both in time and frequency domain were classified using the Naive Bayes classifier. Results showed an accuracy of 94.6% for a person using the training set of that person, whereas the accuracy was 56.3% using the training sets of all the other people.

Another research work exploited an accelerometer placed on the waist (Mathie et al., 2001). The device was so small that it fitted in a belt. The authors analyzed the duration, velocity, angle of a movement and its energy consumption to distinguish between activity and rest. The processing of the information was conducted by a base station. The authors used a threshold of 2.5G to detect a fall under the assumption that the subjects are not in good health and therefore unable to perform actions with acceleration above that threshold. This means that, to avoid false positives, they had to reduce the activity recognition capability of the system.

Hwang et al. (2004) used a node placed on the chest featuring an accelerometer, a gyroscope, a tilt sensor, a processing unit and a Bluetooth transmitter. The accelerometer measured the kinetic force whereas the tilt sensor and the gyroscope estimated the body posture. The goal was to detect some activities of daily living and falls. The authors experimented on three people, aged over 26 years, studying the four activities: forward fall, backward fall, lateral fall and sit-stand. In this study, the system could distinguish between fall and daily activities. The accuracy of fall detection was 96.7%.

Recently, smartphones with embedded accelerometers have been used to act both as fall detector and as gateway to alert the caregivers (Dai et al., 2010; Sposaro & Tyson, 2009). The problems associated with this approach are related to the device placement (in a fixed position or not) and to the short battery lifetime. Usually in these applications there is a trivial fall detection algorithm and to avoid false positives, the user should press a button to dismiss the alarm when there is no real fall.

## 11. Issues and challenges for designing a robust system

The review of the above proposed solutions shows some pitfalls for a real implementation. The system found more promising is the one that takes into account postures given by the accelerometers and gyroscopes to reduce false positives (Li et al., 2009). But the authors used two nodes and did not detect activities of daily living such a “falling” on a chair or a bed. The reported sensitivity is 92% and specificity 91%.

Hence the first challenge is to improve the performance of systems, to assist the patient only when there is a real fall. If we imagine to deploy the system in a hospital, it would be very annoying to run frequently to a patient because of false alarms.

The next challenge is to take into account the usability. The ideal system should be based on only one wearable sensor with small form factor, possibly placed in a comfortable place such as a belt. This may complicate the posture detection. Moreover the energy consumption must be low to extend the battery lifetime. This requires careful management of radio communications (the activity with the highest consumption of energy), flash storage and data sampling

and processing. To support clinical requirements battery lifetime is a major concern: the minimum battery lifetime should be at least one day, in order to avoid stressing the caregivers with the tasks of recharging and replacing the devices, considering that longer the battery life better the continuity and the effectiveness of the system.

## 12. Conclusion

The development of a fall detection system requires a non-negligible warm-up time to fully understand the problem of falls. In this survey the basics of the fall-problem together with the most relevant approaches have been described. The aim is to provide guidelines to speed-up the design process of a new fall detection system by compiling the merits of efforts taken during the past 30 years in developing a fall detection system. The researchers took many different approaches to solve the problem of falls among elderly with the lack of any standard testing guidelines. They proposed their own guidelines but they did not cover the problem from the beginning. The review shows the different approaches and presents a standard procedure by collecting the most relevant parameters, data filtering and testing protocols. This study also provided a standard structure for a database considering the issues and challenges of a fall detection system.

A step further from the *detection* is the *prediction* of non-accidental falls. Some papers left prediction as a future work, suggesting consideration of the physiological state of elderly. The first problem to face is the selection of the physiological measurements that are relevant to a fall and the ways to measure them. It is presumable that even if the complexity of such a predictive system increases, the advantages are much more.

## 13. References

- Akyildiz, I. F., Su, W., Sankarasubramaniam, Y. & Cayirci, E. (2002). Wireless sensor networks: a survey, *Computer Networks* **38**: 393–422.
- Bradley, C., Pointer, S., of Health, A. I., Welfare. & of South Australia., F. U. (2009). *Hospitalisations due to falls by older people, Australia, 2005-06 / Clare Bradley, Sophie Pointer*, Australian Institute of Health and Welfare, Canberra .:
- Campbell, A. J., Borrie, M. J., Spears, G. F., Jackson, S. L., Brown, J. S. & Fitzgerald, J. L. (1990). Circumstances and Consequences of Falls Experienced by a Community Population 70 Years and over during a Prospective Study, *Age Ageing* **19**(2): 136–141.
- Chapman, A. (2008). *Biomechanical Analysis of Fundamental Human Movements*, Human Kinetics, United States.
- Clifford, M. A., Borrás, R. L. & Gomez, L. (2007). System and method for human body fall detection.  
**URL:** <http://www.freepatentsonline.com/7248172.html>
- Dai, J., Bai, X., Yang, Z., Shen, Z. & Xuan, D. (2010). Perfallid: A pervasive fall detection system using mobile phones, *Pervasive Computing and Communications Workshops (PERCOM Workshops)*, 2010 8th IEEE International Conference on, pp. 292 –297.
- Depeursinge, Y., Krauss, J. & El-khoury, M. (2001). Device for monitoring the activity of a person and/or detecting a fall, in particular with a view to providing help in the event of an incident hazardous to life or limb.  
**URL:** <http://www.freepatentsonline.com/6201476.html>
- Englander, F. and Terregrossa, R. & Hodson, T. (1996). Economic dimensions of slip and fall injuries, *Journal of Forensic Sciences (JOFS)* **41**(05): 733–746.

- Gibson, M., Andres, R., Isaacs, B., Radebaugh, T. & Worm-Petersen, J. (1987). The prevention of falls in later life. a report of the kellogg international work group on the prevention of falls by the elderly., *Danish Medical Bulletin* **34**(4): 1–24.
- Hwang, J., Kang, J., Jang, Y. & Kim, H. (2004). Development of novel algorithm and real-time monitoring ambulatory system using bluetooth module for fall detection in the elderly, *Engineering in Medicine and Biology Society, 2004. IEMBS '04. 26th Annual International Conference of the IEEE*, Vol. 1, pp. 2204 –2207.
- Kangas, M., Konttila, A., Winblad, I. & Jamsa, T. (2007). Determination of simple thresholds for accelerometry-based parameters for fall detection, *Engineering in Medicine and Biology Society, 2007. EMBS 2007. 29th Annual International Conference of the IEEE*, pp. 1367 – 1370.
- Kangas, M., Vikman, I., Wiklander, J., Lindgren, P., Nyberg, L. & Jämsä, T. (2009). Sensitivity and specificity of fall detection in people aged 40 years and over., *Gait Posture* .
- Lee, Y., Kim, J., Son, M. & Lee, M. (2007). Implementation of accelerometer sensor module and fall detection monitoring system based on wireless sensor network, *Engineering in Medicine and Biology Society, 2007. EMBS 2007. 29th Annual International Conference of the IEEE*, pp. 2315–2318.
- Li, Q., Stankovic, J. A., Hanson, M. A., Barth, A. T., Lach, J. & Zhou, G. (2009). Accurate, fast fall detection using gyroscopes and accelerometer-derived posture information, *BSN '09: Proceedings of the 2009 Sixth International Workshop on Wearable and Implantable Body Sensor Networks*, IEEE Computer Society, Washington, DC, USA, pp. 138–143.
- Lindemann, U., Hock, A., Stuber, M. & Keck, W. (2005). Evaluation of a fall detector based on accelerometers: A pilot study, *Medical and Biological Engineering and Computing* **43**(5): 548–551.
- Lipsitz, L. A., Jonsson, P. V., Kelley, M. M. & Koestner, J. S. (1991). Causes and Correlates of Recurrent Falls in Ambulatory Frail Elderly, *Journal of Gerontology* **46**(4): M114–M122.
- Lord, S., C., S. & Menz, H. (2001). Falls in older people: Risk factors and strategies for prevention, *Ageing and Society* **21**(05): 667–675.
- Lord, S., Ward, J., Williams, P. & Anstey, K. (1993). An epidemiological study of falls in older community-dwelling women: the Randwick falls and fractures study, *Australian Journal of Public Health* **17**(3): 240–245.
- Massachusetts Department of Public Health (2008). *Unintentional Fall-Related Injuries among Massachusetts Older Adults*, Commonwealth of Massachusetts, Department of Public Health.
- Masud, T. & Morris, R. (2001). Epidemiology of falls, *Age Ageing* **30**(4): 3–7.
- Mathie, M., Basilakis, J. & Celler, B. (2001). A system for monitoring posture and physical activity using accelerometers, *Engineering in Medicine and Biology Society, 2001. Proceedings of the 23rd Annual International Conference of the IEEE*, Vol. 4, pp. 3654 – 3657 vol.4.
- Noury, N., Barralon, P., Virone, G., Boissy, P., Hamel, M. & Rumeau, P. (2003). A smart sensor based on rules and its evaluation in daily routines, *Engineering in Medicine and Biology Society, 2003. Proceedings of the 25th Annual International Conference of the IEEE*, Vol. 4, pp. 3286–3289 Vol.4.
- Noury, N., Fleury, A., Rumeau, P., Bourke, A., Laighin, G., Rialle, V. & Lundy, J. (2007). Fall detection - principles and methods, *Engineering in Medicine and Biology Society, 2007. EMBS 2007. 29th Annual International Conference of the IEEE*, pp. 1663–1666.

- Noury, N., Herve, T., Rialle, V., Virone, G., Mercier, E., Morey, G., Moro, A. & Porcheron, T. (2000). Monitoring behavior in home using a smart fall sensor and position sensors, *Microtechnologies in Medicine and Biology, 1st Annual International Conference On. 2000*, pp. 607–610.
- Noury, N., Rumeau, P., Bourke, A., ÓLaighin, G. & Lundy, J. (2008). A proposal for the classification and evaluation of fall detectors, *IRBM* **29**(6): 340 – 349.
- Oliver, D. (2008). Falls riskprediction tools for hospital inpatients. time to put them to bed?, *Age Ageing* **37**(3): 248–250.
- Perell, K., Nelson, A., R.L., G., Luther, S., Prieto-Lewis, N. & Rubenstein, L. (2001). Fall risk assessment measures: an analytic review, *Journal of Gerontology* **56A**(12): M761–M766.
- Polastre, J., Szewczyk, R. & Culler, D. (2005). Telos: enabling ultra-low power wireless research, *IPSN '05: Proceedings of the 4th international symposium on Information processing in sensor networks*, IEEE Press, Piscataway, NJ, USA.
- Prado-Velasco, M., del Rio-Cidoncha, M. G. & Ortiz-Marin, R. (2008). The inescapable smart impact detection system (isis): An ubiquitous and personalized fall detector based on a distributed ?divide and conquer strategy?, *Engineering in Medicine and Biology Society, 2008. EMBS 2008. 30th Annual International Conference of the IEEE*, pp. 3332–3335.
- Realtime Technologies LTD (2008). Shimmer: Sensing health with intelligence modularity, mobility and experimental reusability.
- Sposaro, F. & Tyson, G. (2009). ifall: An android application for fall monitoring and response, *Engineering in Medicine and Biology Society, 2009. EMBC 2009. Annual International Conference of the IEEE*, pp. 6119 –6122.
- Tapia, E. M., Intille, S. S., Haskell, W., Larson, K., Wright, J., King, A. & Friedman, R. (2007). Real-time recognition of physical activities and their intensities using wireless accelerometers and a heart rate monitor, *ISWC '07: Proceedings of the 2007 11th IEEE International Symposium on Wearable Computers*, IEEE Computer Society, Washington, DC, USA, pp. 1–4.
- Tinetti, M. E., Speechley, M. & Ginter, S. F. (1988). Risk factors for falls among elderly persons living in the community, *New England Journal of Medicine* **319**(26): 1701–1707.
- Vassallo, M., Poynter, L., Sharma, J. C., Kwan, J. & Allen, S. C. (2008). Fall riskassessment tools compared with clinical judgment: an evaluation in a rehabilitation ward, *Age Ageing* **37**(3): 277–281.
- Wang, C.-C., Chiang, C.-Y., Lin, P.-Y., Chou, Y.-C., Kuo, I.-T., Huang, C.-N. & Chan, C.-T. (2008). Development of a fall detecting system for the elderly residents, *Bioinformatics and Biomedical Engineering, 2008. ICBBE 2008. The 2nd International Conference on*, pp. 1359–1362.
- Yang, C.-C. & Hsu, Y.-L. (2007). Algorithm design for real-time physical activity identification with accelerometry measurement, *Industrial Electronics Society, 2007. IECON 2007. 33rd Annual Conference of the IEEE*, pp. 2996 –3000.
- Yoshida, T., Mizuno, F., Hayasaka, T., Tsubota, K., Wada, S. & Yamaguchi, T. (2005). A wearable computer system for a detection and prevention of elderly users from falling, *The 12th International Conference on Biomedical Engineering* .
- Yu, X. (2008). Approaches and principles of fall detection for elderly and patient, *e-health Networking, Applications and Services, 2008. HealthCom 2008. 10th International Conference on*, pp. 42–47.



## **Wireless Sensor Networks: Application-Centric Design**

Edited by Yen Kheng Tan

ISBN 978-953-307-321-7

Hard cover, 492 pages

**Publisher** InTech

**Published online** 14, December, 2010

**Published in print edition** December, 2010

Over the past decade, there has been a prolific increase in the research, development and commercialisation of Wireless Sensor Networks (WSNs) and their associated technologies. WSNs have found application in a vast range of different domains, scenarios and disciplines. These have included healthcare, defence and security, environmental monitoring and building/structural health monitoring. However, as a result of the broad array of pertinent applications, WSN researchers have also realised the application specificity of the domain; it is incredibly difficult, if not impossible, to find an application-independent solution to most WSN problems. Hence, research into WSNs dictates the adoption of an application-centric design process. This book is not intended to be a comprehensive review of all WSN applications and deployments to date. Instead, it is a collection of state-of-the-art research papers discussing current applications and deployment experiences, but also the communication and data processing technologies that are fundamental in further developing solutions to applications. Whilst a common foundation is retained through all chapters, this book contains a broad array of often differing interpretations, configurations and limitations of WSNs, and this highlights the diversity of this ever-changing research area. The chapters have been categorised into three distinct sections: applications and case studies, communication and networking, and information and data processing. The readership of this book is intended to be postgraduate/postdoctoral researchers and professional engineers, though some of the chapters may be of relevance to interested master's level students.

### **How to reference**

In order to correctly reference this scholarly work, feel free to copy and paste the following:

Stefano Abbate, Marco Avvenuti, Paolo Corsini, Janet Light and Alessio Vecchio (2010). Monitoring of Human Movements for Fall Detection and Activities Recognition in Elderly Care Using Wireless Sensor Network: a Survey, *Wireless Sensor Networks: Application-Centric Design*, Yen Kheng Tan (Ed.), ISBN: 978-953-307-321-7, InTech, Available from: <http://www.intechopen.com/books/wireless-sensor-networks-application-centric-design/monitoring-of-human-movements-for-fall-detection-and-activities-recognition-in-elderly-care-using-wi>

**INTECH**  
open science | open minds

### **InTech Europe**

University Campus STeP Ri  
Slavka Krautzeka 83/A  
51000 Rijeka, Croatia

### **InTech China**

Unit 405, Office Block, Hotel Equatorial Shanghai  
No.65, Yan An Road (West), Shanghai, 200040, China  
中国上海市延安西路65号上海国际贵都大饭店办公楼405单元

Phone: +385 (51) 770 447  
Fax: +385 (51) 686 166  
[www.intechopen.com](http://www.intechopen.com)

Phone: +86-21-62489820  
Fax: +86-21-62489821

IntechOpen

IntechOpen

© 2010 The Author(s). Licensee IntechOpen. This chapter is distributed under the terms of the [Creative Commons Attribution-NonCommercial-ShareAlike-3.0 License](#), which permits use, distribution and reproduction for non-commercial purposes, provided the original is properly cited and derivative works building on this content are distributed under the same license.

IntechOpen

IntechOpen