

We are IntechOpen, the world's leading publisher of Open Access books Built by scientists, for scientists

4,800

Open access books available

122,000

International authors and editors

135M

Downloads

Our authors are among the

154

Countries delivered to

TOP 1%

most cited scientists

12.2%

Contributors from top 500 universities



WEB OF SCIENCE™

Selection of our books indexed in the Book Citation Index
in Web of Science™ Core Collection (BKCI)

Interested in publishing with us?
Contact book.department@intechopen.com

Numbers displayed above are based on latest data collected.

For more information visit www.intechopen.com



An Energy-aware Clustering Technique for Wireless Sensor Networks

Wibhada Naruephiphat and Chalermopol Charnsripinyo
*National Electronics and Computer Technology Center,
 National Science and Technology Development Agency,
 Thailand*

1. Introduction

A wireless sensor network (WSN) is a specialized wireless network that composes of a number of sensor nodes deployed in a specified area for monitoring environment conditions such as temperature, air pressure, humidity, light, motion or vibration, and so on. The sensor nodes are usually programmed to monitor or collect data from surrounding environment and pass the information to the base station for remote user access through various communication technologies. Figure 1 shows general wireless sensor network architecture. Typically, a sensor node is a small device that consists of four basic components as shown in Figure 2: 1) sensing subsystem for data gathering from its environment, 2) processing subsystem for data processing and data storing, 3) wireless communication subsystem for data transmission and 4) energy supply subsystem which is a power source for the sensor node. However, sensor nodes have small memory, slow processing speed, and scarce energy supply. These limitations are typical characteristics of sensor nodes in wireless sensor networks.

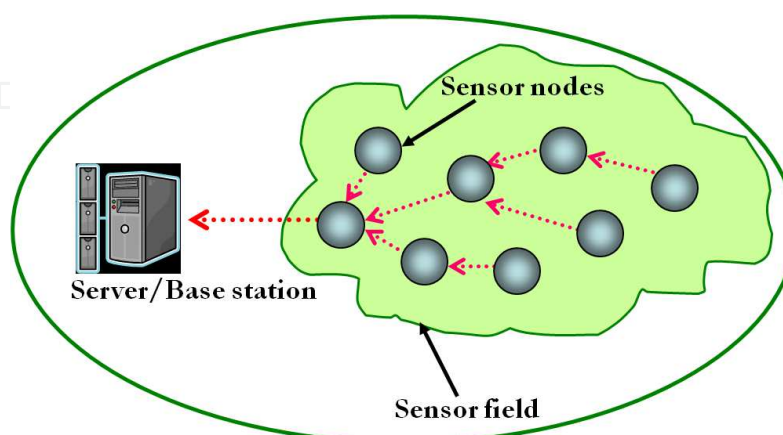

Fig. 1. Wireless Sensor Network

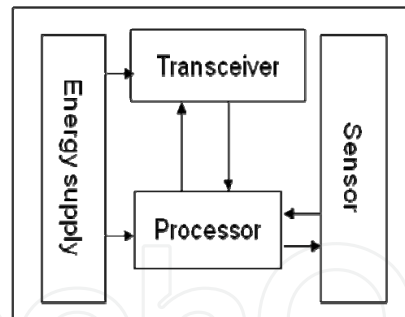

Fig. 2. Overview of sensor node components

A wireless sensor network usually has energy constrained due to each sensor node requires battery with a limited energy supply to operate. In addition, recharging or replacing sensor battery may be inconvenient and impossible in some environments. However, the wireless sensor network should function long enough to accomplish the application requirements. Therefore, energy conservation is a main issue in the design of wireless sensor networks. There are different approaches to preserve energy usage and prolong the network lifetime in WSN. The key approach to improve energy usage in WSNs is the development of energy-aware network protocols.

In this paper we present a review of routing and clustering algorithms for energy conservation in wireless sensor networks. We also present an energy-aware clustering technique for enhancing the network lifetime as well as increasing the number of successfully delivered packets and decreasing the network delay time.

2. Review of Routing and Clustering Algorithms

A routing protocol in wireless sensor networks usually coordinates the activities of sensing nodes in the network for data transmission to the base station. Routing protocols in WSN can be grouped into three models as follows (Ibriq&Margoub, 2004).

1) One-hop model: every node in the network transmits data directly to the base station. This is the simplest model representing direct communication from the sensor node to the base station as shown in Figure 3. However, the direct communication may not be practical for routing in wireless sensor networks because each sensor node has limited transmission range.

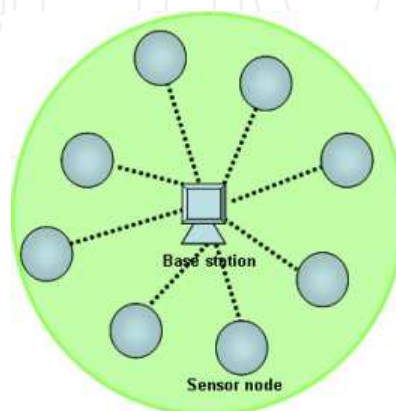

Fig. 3. One-hop model

2) Multi-hop model: a sensor node transmits data to the base station by forwarding its data to one of its neighbors which are closer to the base station. The data packet from the source node is forwarded hop-by-hop from one node to another node until the data packet arrives at the base station as shown in Figure 4.

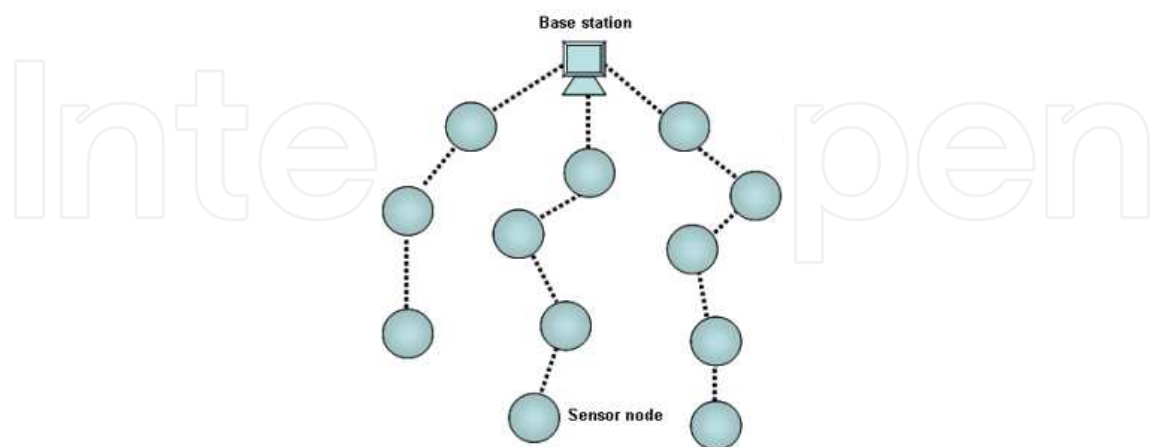

Fig. 4. Multi-hop model

3) Cluster-based Hierarchical Model: each cluster consists of a single cluster head (CH) and multiple member nodes. Nodes are grouped into clusters with a cluster head that has the responsibility of routing data packets from the cluster to another cluster heads toward the base station. A node can be both the cluster head in one cluster, and a member in another cluster which is closer to the base station. The cluster-based hierarchical is shown in Figure 5.

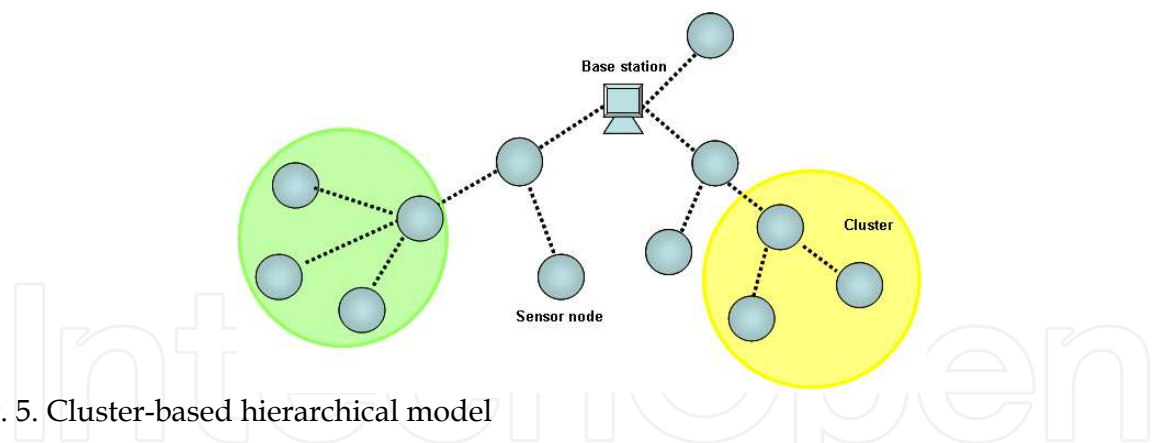

Fig. 5. Cluster-based hierarchical model

Many routing protocols have appeared recently which mainly concentrated on how to find a shorter path between a source and destination node when performing route discovery. The shortest path normally requires minimum number of intermediate forwarding nodes which result in minimum total energy consumption. However it is possible that some particular nodes are unfairly burdened. This hot spot node may consume more energy and stop running earlier than other nodes. (Fedor & Collier, 2007) explored when multi-hop routing is more energy-efficient than direct transmission to the sink and conditions which the two-hop strategy is optimal. The experiments showed that the two-hop communication is more advantageous than the single hop (direct communication) when the relay is equally distant from the source to the sink. (Jia et al., 2007) proposed a novel Hole Avoiding In advance

Routing protocol (HAIR) to decrease both the delay and energy consumption. The proposed protocol has two stages. In the first stage, a node finds barriers and informs its neighbor nodes about holes to avoid the missing path. In the second stage, if few sensor nodes can not find their routes at the first stage, they can find other existing paths in the network. The HAIR protocol can make the packets avoid meeting the “hole” in advance, so it decreases both the routing distance and the energy consumption. (Shen et al., 2009) proposed to improve the Geographical and Energy Aware Routing (GEAR) protocol. The proposed routing mechanism improves the GEAR protocol to reduce the energy consumption and extend the network lifetime. (Hu et al., 2007) proposed to avoid selecting the forwarding node with lower residual battery power than the threshold value. The approach maximizes the lifetime of WSN and equally balances the total energy consumption among all nodes in the network. (Wang et al., 2007) presented a Local Update-based Routing Protocol (LURP) that allows the sink node to move and update its location information. Since the sensor nodes close to the sink deplete their energy quickly by forwarding messages originating from many other nodes, the moving sink node can maintain the energy consumption of sensor nodes close to the sink. (Kai, 2009) proposed an energy-efficient routing called Leaping-Base Routing algorithm. This routing algorithm focuses on the load balancing problems in wireless sensor networks. Its routing table contains the information of neighbor nodes such as nodes’ ID, hop length to the base station, and residual energy. A node selects its neighbor by considering the information of routing table.

A routing protocol usually requires updates from path search processes and stores information in the routing table. Therefore, the routing algorithms can affect the processing, memory, and energy consumption. Due to scarce energy supply, less processing power and memory, the routing algorithms should avoid overheads of storing routing table, avoid path search processes to reduce energy usage, and consider energy-efficient approach to preserve energy consumption as shown in Figure 6.

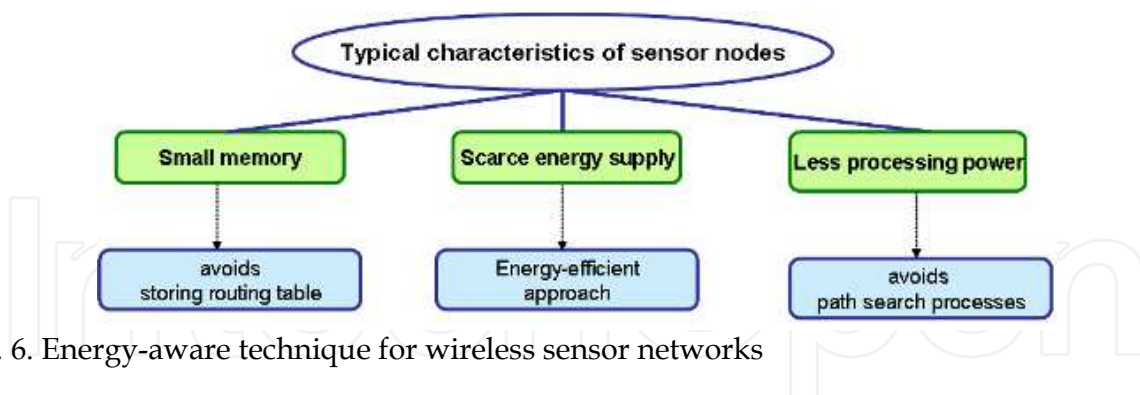

Fig. 6. Energy-aware technique for wireless sensor networks

One of the energy-efficient techniques used in wireless sensor networks is the clustering algorithm. A cluster-based routing protocol can avoid intensive message exchanges of path search update processes and overhead of storing routing table or other information that could be expensive to update.

Typical clustering algorithms divide WSN nodes into two types: member nodes and cluster-heads. The member nodes send data to their cluster-head, then a cluster-head aggregates the data and relays to the base station. Several clustering algorithms have been proposed for wireless sensor networks such as Low-Energy Adaptive Clustering Hierarchy (LEACH)

(Handy et al., 2002) and Hybrid Energy-Efficient Distributed (HEED) Clustering Approach (Younis & Fahmy 2004). (Qiu et al., 2009) presented a tree routing to avoid flooding network with path search and update message in order to conserve energy by using only link information between cluster head and members for packet forwarding. By using the cluster-head and member link information only, it avoids intensive message exchanges of path search update processes and overhead of storing routing table or other information that is expensive to update. An unequal clustering and multi-hop routing scheme was presented by (Gong et al. 2008) to extend the network lifetime of WSNs. The authors presented the cluster head selection approach based on a cost function which considers the distance and energy usage. (Dali & Chan, 2007) proposed an approach to balance and reduce the energy consumption of clustered sensor networks. Since the energy consumption of sensor nodes depend on transmission range, the cluster-heads are normally maintained at the center of cluster. In each cluster, the node located in the center area with the highest residual battery level is selected as the cluster-head. A maximum-Votes and Load-balance Clustering Algorithm (VLCA) was presented by (Zhang et al., 2008) to reduce the number of clusters and prolong network lifetime. To balance the workload among cluster-heads, this algorithm selects the cluster-head by considering the number of member nodes and the residual battery level. (Murthy et al., 2008) proposed a level controlled clustering to reduce the number of messages toward the base station and increase the network lifetime of WSN. This method assumes that the base station is able to transmit at various power levels. The cluster head selection method is also based on the maximum residual battery level.

In previous clustering algorithms discussed above, sensor nodes in the network are assigned to each cluster before the cluster heads are selected. The node with the best parameter value will typically be selected as a cluster head for data gathering and forwarding at each cycle. This could be a heavy burden of the selected cluster head as depicted in Figure 7 where node A and M are selected as the cluster head of other sensor nodes.

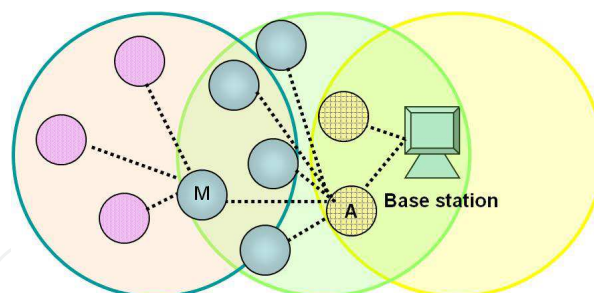

Fig. 7. A cluster-head and member links in typical schemes

3. Efficient Energy-aware Clustering Technique

In the design of energy-aware clustering techniques for wireless sensor networks, a clustering algorithm is used for cluster head selection. A simple clustering algorithm may select a cluster head with minimum distance or maximum residual battery level. A minimum cost function was presented in a previous research work (Chang & Tassiulas, 2004). The minimum cost function combining both energy consumption and battery level for cluster head selection was given as follows.

$$C(i) = (E_{TOT}(i))^1 (B_{init})^1 (B(i))^{-1} \quad (1)$$

Where $E_{TOT}(i)$ is the energy consumption at node i , B_{init} is initial battery level of sensor node and $B(i)$ is residual battery at node i .

The minimum cost function algorithm will select a cluster head with minimum cost in order to increase the network lifetime. As a result, the selected cluster head has high residual battery level and low energy consumption.

In this paper, we present a clustering technique called the Limiting member node Clustering (LmC) which considers a maximum number of member nodes for each cluster head. We divide sensor nodes into groups where nodes within the base station's transmission range are defined in "level 1" and nodes far from the base station are defined in a higher level depending on the distance to the base station. Figure 8 shows an example of two-level WSN with limited member nodes for each cluster head.

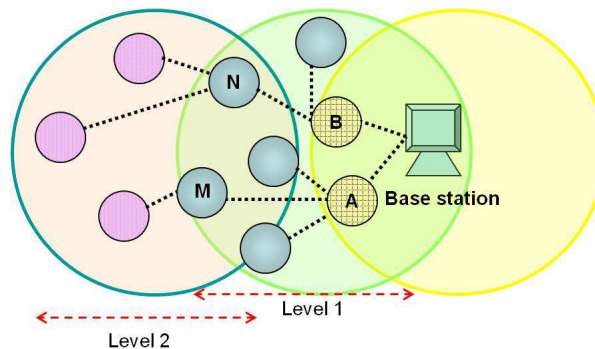

Fig. 8. Cluster-heads and member links in the LmC scheme

In the LmC approach, each sensor node selects a cluster head from the candidate list of cluster heads based on a cost function which takes battery level, energy consumption and distance to the base station into consideration. The LmC will limit the number of member nodes of each cluster head to be less than a threshold value in order to distribute the burden of each cluster head. Consequently, this technique can prolong network lifetime and reduce the time used to forward data packet to the base station.

Each sensor node within "level 1" transmission range selects a cluster head from candidate cluster heads using a new cost function which considers both battery level and distance to the base station. The new cost function is given as

$$C(i) = \frac{B_{init}}{B(i)} + \frac{T_{BS}(i)}{T_{max}} \quad (2)$$

where $T_{BS}(i)$ is the distance between node i and the base station and T_{max} is the maximum transmission range.

Other nodes in a higher level which can not connect to node in "level 1" will select a cluster head from a lower level node which is closer to the base station. The cluster selection will be based on another cost function defined as

$$C(i) = E_{TOT}(i) \frac{B_{init}}{B(i)} + \frac{T_{BS}(i)}{T_{max}} \quad (3)$$

Figure 9 shows the Limiting member node Clustering (LmC) method with cost functions for different layers.

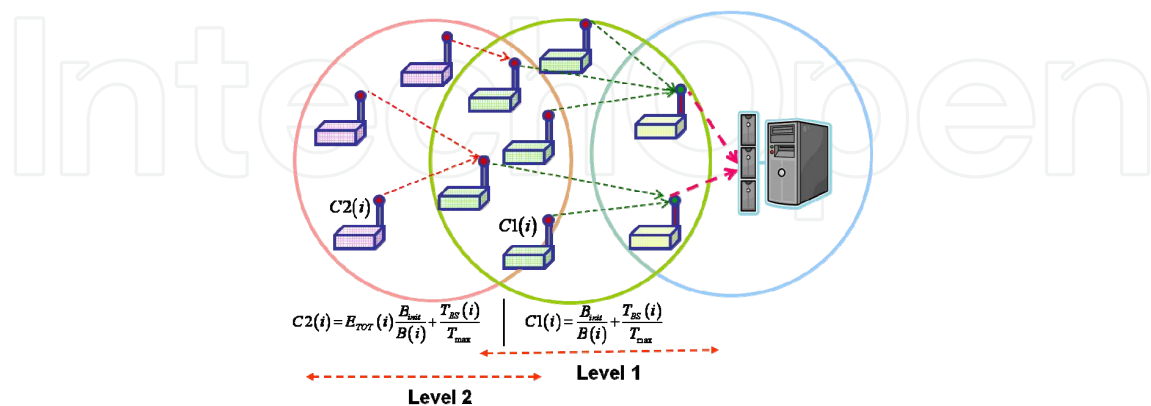

Fig. 9. The Limiting member node Clustering method

Note that the maximum number of member nodes for each cluster head is set to a threshold value. We have investigated different approaches to find the appropriate threshold value. By varying the percentage of the total number of sensor nodes in wireless sensor networks, we found that the appropriate threshold value is around 10 percents.

In LmC algorithm, after a cluster head is selected by nodes in a higher level, the node which has the minimum cost may be disregard if the maximum number of member nodes is attained. The limiting member node clustering algorithm can distribute member nodes to each cluster head. Therefore less data packets will be aggregated in each cluster head. This approach can reduce the time used to send packets to the base station. Since the proposed algorithm selects a cluster head based on the cost function, the selected cluster head can keep high residual battery level and short distance to the base station. The limiting member node clustering is a design approach to enhance network lifetime and also reduce communication delay.

4. Experiments and Performance Evaluation

In this section, we present the experiment results and performance evaluation of our proposed clustering technique. We first describe our experimental design and performance metrics used for evaluating clustering techniques. We then present the experimental results comparing different clustering approaches.

4.1 Experimental design and Performance metrics

We implemented a simulation program using C programming language for evaluating energy-aware clustering techniques. In our experiments, a number of sensor nodes are grouped into clusters where they are within a transmission range.

Nodes select a cluster head and form a cluster according to the self-organized manner. The communication process is described by (Ergen, 2004). Note that the energy usage during the

communication process is not considered in our experiments, since we are focusing on the energy usage for sending data packets and the energy used by the communication process is the same amount for all algorithms.

We adopt the “radio model” discussed by (Muruganathan et al., 2005) for the energy consumption of each node in wireless sensor networks. The transmitting and receiving energy required for transmission of a data message of b -bits between two nodes in a transmission range of d meters is given by

$$E_{TOT}(i) = E_{TX} + E_{RX} \quad (4)$$

Where $E_{TOT}(i)$ is the energy consumption at node i , E_{TX} is the energy dissipated in the transmitter of the sending node given by

$$E_{TX}(b,d) = (E_{elec} \times b) + (\epsilon_{fs} \times b \times d^2) \quad (5)$$

The term E_{RX} is the energy consumption at the receiving node given by

$$E_{RX}(b) = E_{elec} \times b \quad (6)$$

where E_{elec} is the energy expended in the radio electronics which is equal to 50 nJ/bits. $\epsilon_{fs} = 10\text{pJ/bit/m}^2$ is the energy consumed in free space at the output transmitter antenna for a transmitting range of one meter in wireless sensor networks.

We assumed that each node knows the location of its neighbor nodes within the maximum transmission range by using arrival time of “Hello message” during the connection setup process. The information of energy consumption, residual battery level, and distance to the base station (assuming that all nodes know the position of the base station) will be also learnt from the connection setup process.

When each sensor node cooperatively monitors or collects environmental data or conditions (i.e., temperature or humidity), it sends information to a base station via a cluster head selected from a cluster head selection algorithm. We set the length of datagram packets to be 500 Kbits. The data rate for communications is 250 Kbps. The duty cycle is one read per 30 second. The neighbor node information is updated every 60 second. Each sensor node has an initial battery level of 500 J. A node whose battery is depleted will be disconnected from the network and cannot be immediately recharged from any external power supply.

In each experiment, the period of sensing devices to monitor or collect environmental data is 1 day. Each experiment is executed for 10 runs using randomly generated network topologies.

We use the following performance metrics to evaluate and compare among routing/clustering algorithms.

1) Number of successfully delivered packets is the number of times that packets can be successfully delivered to the base station more than 80% of total packets sent by all sensor nodes in the network

- 2) Network lifetime is the duration from the start up time until the first node is disconnected from the network due to it runs out of battery
- 3) Delay time is the period of time that the base station takes to receive packets successfully (more than 80% of total packets are delivered)
- 4) Average number of packets arrived at the base station (Avg_{pkt}) is the average number of packets received at base station (BS). Since each node in the network will send 1 packet at a time, it can be calculated from

$$Avg_{pkt} = \frac{\text{Total \# of packet received}}{\text{Total \# of sending times}} \quad (7)$$

4.2 Experimental Results with Different Clustering Techniques

In this section, we present our experimental results with different cluster head selection approaches in order to compare their performances with our proposed Limiting member node Clustering (LmC) technique. We consider three other cluster head selection techniques, namely, Minimum distance Clustering (MdC), Maximum battery Clustering (MbC), and Minimum cost function Clustering (McC).

In the Minimum distance Clustering (MdC) technique, the cluster head selection is based on the distance between sensor nodes and candidate cluster heads. Each sensor node will select a cluster head which has the shortest distance to the sensor node. There is no limit on the number of member nodes for each selected cluster head.

In the Maximum battery Clustering (MbC) technique, the cluster head selection is based on the residual battery level of candidate cluster heads. Each sensor node will select a cluster head which has the maximum residual battery level. There is no limit on the number of member nodes for each selected cluster head.

In the Minimum cost function Clustering (McC) technique, the cluster head selection is based on the minimum cost function previously defined in equation (1) of section 3. Each sensor node will select a cluster head from the candidate cluster heads which has the minimum cost. There is no limit on the number of member nodes for each selected cluster head.

In our experiments, we consider a wireless sensor network with 100 sensor nodes randomly generated and distributed in a square area of 400 meters by 400 meters. The base station is located in the center of the area. Each node has a transmission range of 120 meters. A link is formed between any pair of nodes within this transmission range. The simulation results of the Limiting member node Clustering (LmC) compared with different clustering techniques are illustrated in Figure 10-13 as follows.

A. The network lifetime

The network lifetime of different cluster head selection schemes is shown in Figure 10. The results show that the proposed Limiting member node Clustering (LmC) algorithm has the longest network lifetime and the Minimum distance Clustering (MdC) algorithm has the shortest network lifetime. The reason is because the LmC algorithm considers the distance, energy usage and residual battery level in the cost function for the cluster head selection while other algorithms select the cluster head by considering only energy usage, battery

level or distance separately. Since the cluster heads located in the transmission range of the base station will have heavy load from aggregated data packets which are forwarded to the base station, it is suggested that all parameters including energy usage, battery level and distance should be incorporated in the cost function.

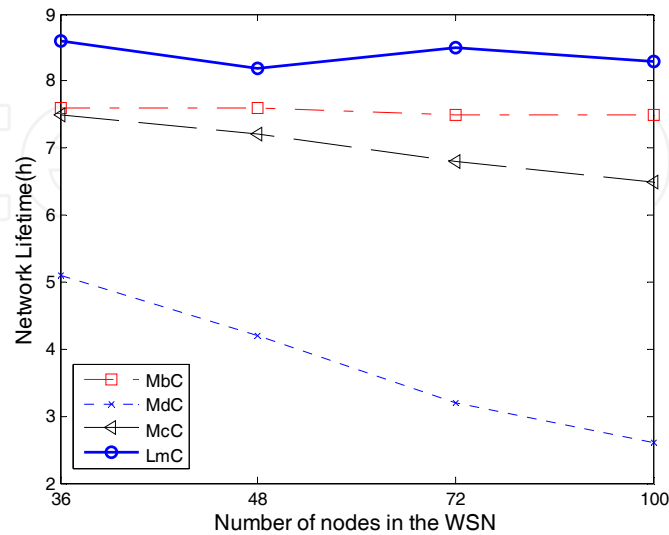

Fig. 10. Comparison of the network lifetime

B. The delay time

Figure 11 shows the delay time of different clustering schemes by varying the number of sensor nodes in the wireless sensor network. It can be seen that the LmC algorithm has the shortest delay time while other algorithms have obviously higher delay time. The reason is because the LmC algorithm can equally balance the number of member nodes for each cluster head. On the other hand, other algorithms select the cluster head based on each parameter constraint which yields a single cluster head in each cycle. Therefore, the single selected cluster head is heavily loaded by aggregated data packets and uses more time to forward those data packets to the base station.

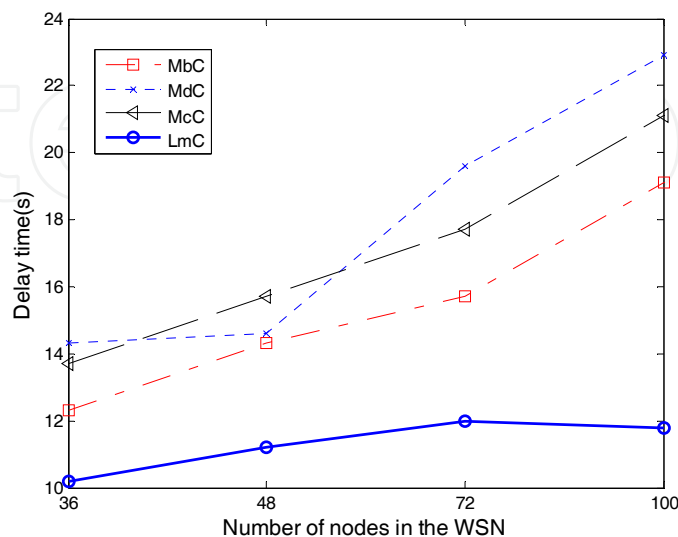

Fig. 11. Comparison of the delay time (s)

C. Number of successfully delivered packets

Figure 12 shows the number of successfully delivered packets for different clustering algorithms. It can be observed that the results of the LmC and MbC algorithms are very close and much higher than the other two methods. Note that the larger number of sensor nodes in the network, a higher number of successfully delivered packets will be attained. The reason is because increasing the number of sensor nodes will also increase the chance to connect with the base station directly and have higher number of candidates for cluster heads.

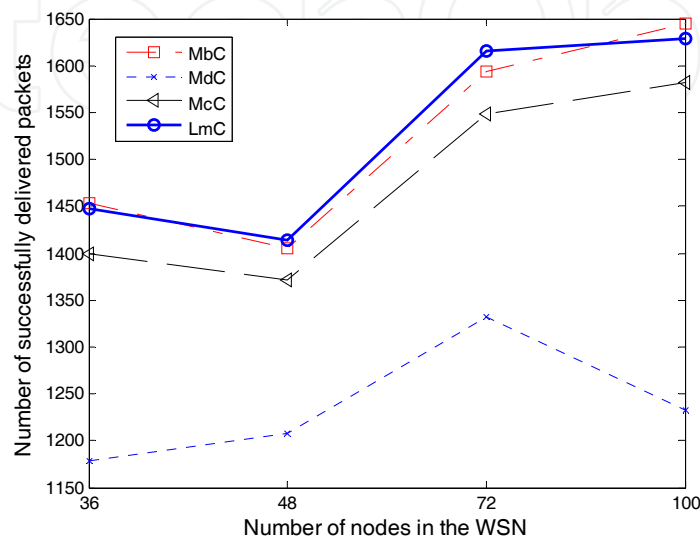

Fig. 12. Comparison of number of successfully delivered packets

D. Average number of packets arrived to the base station per cycle

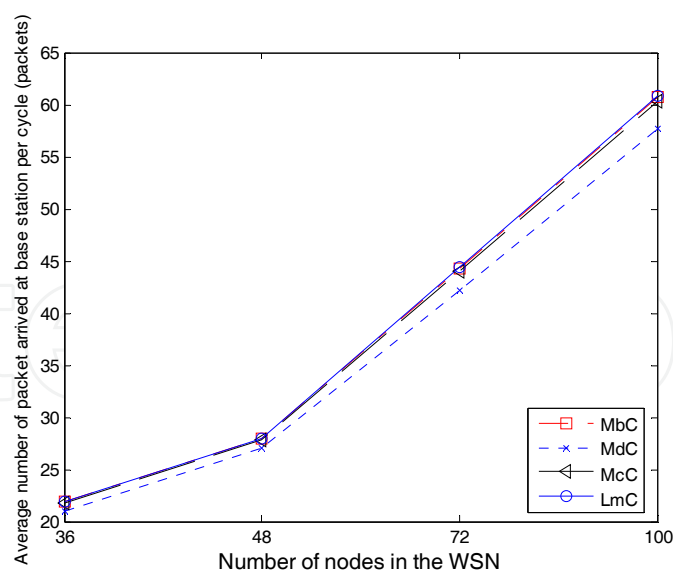

Fig. 13. Comparison of average number of packets arrived to the base station per cycle

Figure 13 compares the average number of packets arrived to the base station per cycle as the number of sensor nodes in the network increases. The results show that the MdC algorithm give the lowest average number of packet arrived to the base station due to this

algorithm selects a cluster head based on distance, so the selected cluster head is not changed for static network topology. Therefore, the cluster head with more member nodes will have heavy load and the ability of the cluster head in forwarding packets to the base station is decreased. On the other hand, three remaining algorithms select a cluster head based on a cost function (i.e., energy consumption or battery level) which depends on connection time and energy usage, so cluster head could be changed at each cycle of packets sent. Note that the higher the number of sensor nodes in the network, the higher average number of packets arrived to the base station will be obtained.

4.3 Experimental Results with Transmission Range Extension

In this section, we study the impact of transmission range control and extension in wireless sensor networks. To evaluate the transmission range control, we consider three scenarios as shown in Figure 14: 1) the base station and each sensor node have a transmission range of 120 meters 2) the base station extends its transmission range to 250 meters while each sensor node has a transmission range of 120 meters 3) the base station and sensor nodes extend their transmission range to 250 meters.

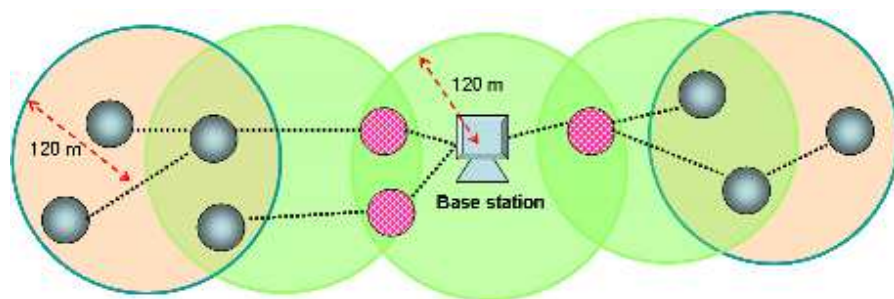

(a) Scenario1: the base station and all sensor nodes have the same transmission range (120m)

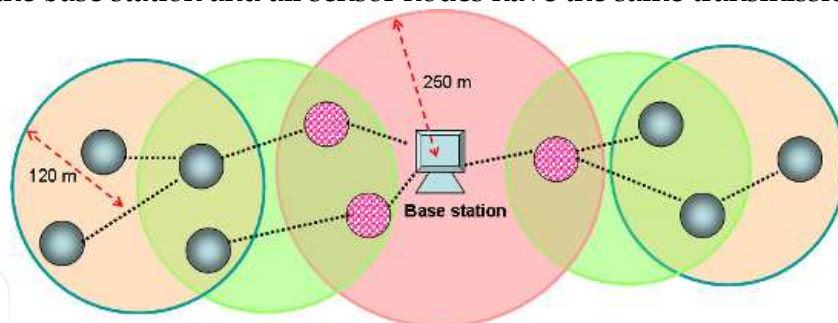

(b) Scenario2: only the transmission range of base station is extended (250m)

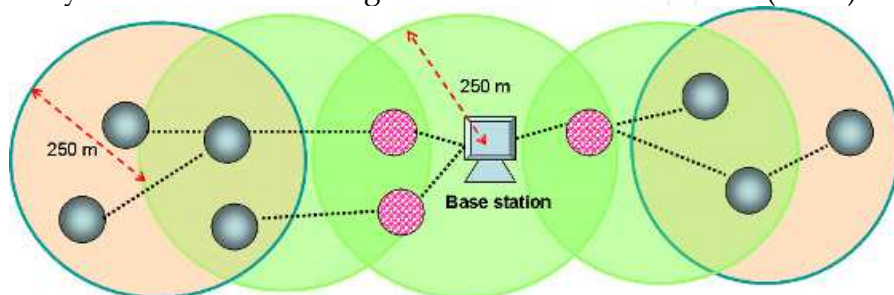

(c) Scenario3: the transmission range of both base station and all sensor nodes are extended (250m)

Fig. 14. WSNs with transmission range control

In our experiments, we compare performances of our proposed Limiting member node Clustering (LmC) with other three clustering techniques, namely, Minimum distance Clustering (MdC), Maximum battery Clustering (MbC), and Minimum cost function Clustering (McC). We conduct experiments in three cases: 1) extending the transmission range of the base station, 2) expanding the network area with the fixed number of sensor nodes, and 3) varying the number of sensor nodes in a fixed area. The simulation results of the three cases are discussed as the following.

4.3.1 Transmission range extension

We consider the impact of extending the transmission range of the base station only by comparing between scenario1 and scenario2.

A. Network lifetime

Figure 15 shows the network lifetime of different clustering techniques using transmission range control for only the base station. It can be observed that all techniques in scenario2 with transmission range extension for the base station have longer network lifetime than scenario1 (without extending the transmission range for the base station). The reason is because extending the transmission range will increase the number of nodes within the base station's transmission range. Therefore, it reduces the amount of aggregated data packets which are forwarded to the base station since nodes can connect with the base station directly.

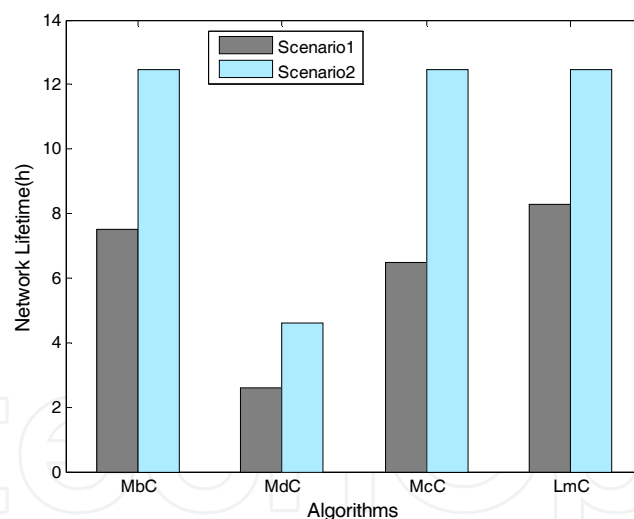

Fig. 15. The network lifetime in scenario1 and 2

B. Delay time

Figure 16 compares the delay time of different techniques. The results show that the extended transmission range of the base station to connect with nodes in "level 1" (scenario2) gives much shorter delay time than the limited transmission range (scenario1). The reason is due to the extension of the transmission range will also increase the number of nodes in "level 1" to connect with the base station directly and reduce the number of member nodes in higher layers.

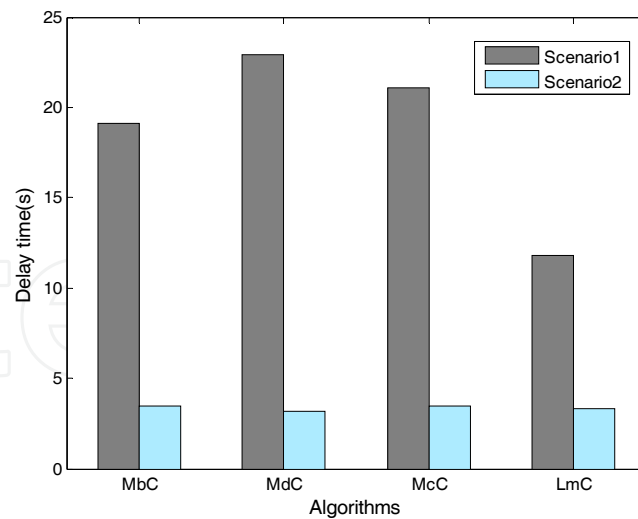

Fig. 16. The delay time in scenario1 and 2

C. Number of successfully delivered packets

Figure 17 compares the number of successfully delivered packets for different algorithms. It can be seen that all algorithms in scenario2 allow more sensor nodes to have direct connectivity with the base station. Therefore, the number of successful packets delivered in the network also increases.

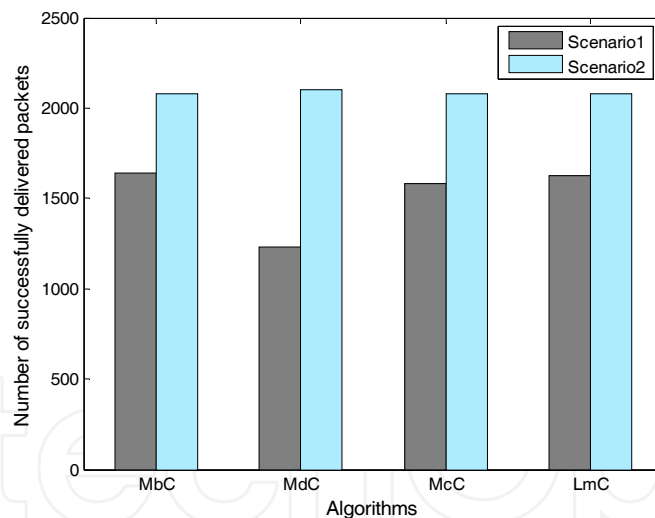

Fig. 17. Number of successfully delivered packets in scenario 1 and 2

4.3.2 Expansion of network area

From the previous case of transmission range control, we found that all clustering techniques perform better when we extend the transmission range of the base station. Therefore, we further extend the transmission range of both the base station and sensor nodes. To study the expansion of network area, the number of sensor nodes is fixed at 100 nodes while the network area is expanded. The simulation results for the scenario2 and scenario3 are compared and discussed as the following.

A. Network lifetime

Figure 18 shows network lifetime of different clustering techniques. It can be observed that, with the area 400x400m (Figure 18a), all techniques in both scenario2 and scenario3 can prolong the network lifetime. However, when we expand the area to 900x900m, the network lifetime is shorter than those in the smaller area. The reason is because in the very large network area, it reduces a chance of sensor nodes to connect with the base station directly. Therefore, each cluster-head has a large number of member nodes and cluster heads near the base station have higher burden to receive and forward data packets. However, when transmission ranges of both the base station and sensors are extended, this can help improving the network lifetime in a large size area (Figure 18b). Note that the Limiting member node Clustering (LmC) technique has the longest network lifetime in a large network area because the proposed technique can balance the number of member node in each cluster head.

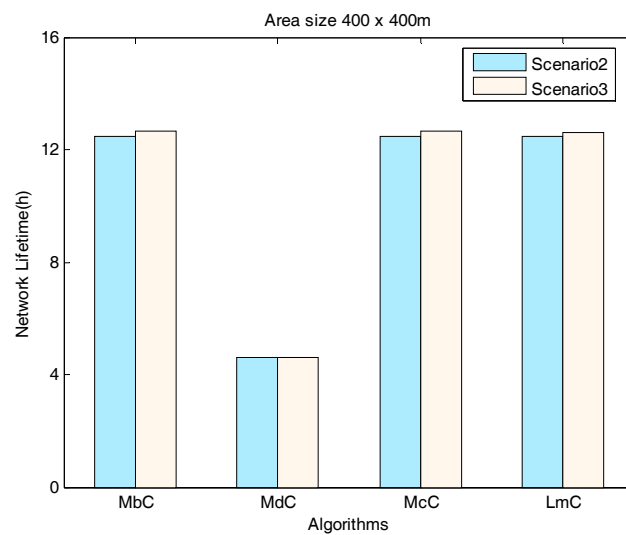

(a) Network area size 400x400m

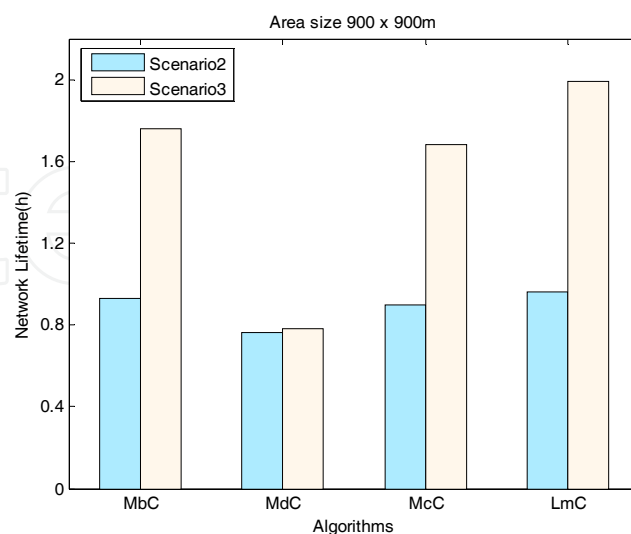

(b) Network area size 900x900m

Fig. 18. The network lifetime with the expansion of network area size

B. Delay time

Figure 19 compares the delay time of different techniques when the network area is expanded. The results show that an extension of the transmission range for both the base station and sensor nodes can reduce the delay time but the expansion of network area increases the delay time. This is because a large number of nodes are in higher levels and there are more packets relayed to the cluster head at each level. Therefore, the cluster heads in “level 1” have higher burden. However, it can be seen that the Limiting member node Clustering (LmC) technique has the shortest delay time while the delay time of other techniques is obviously higher when the size of network area is increased.

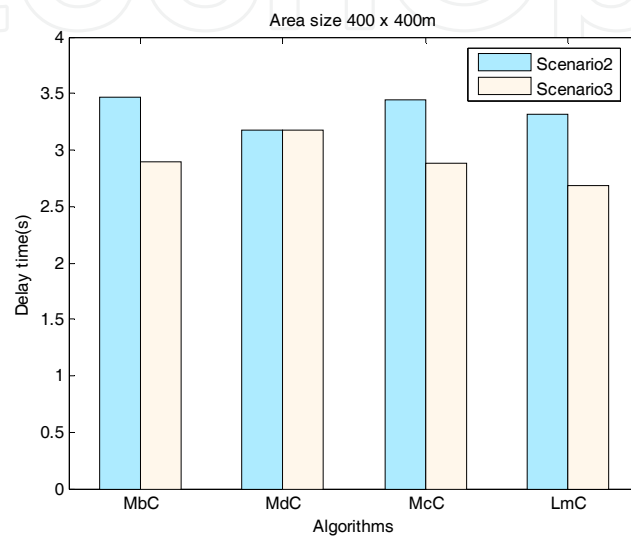

(a) Network area size 400x400m

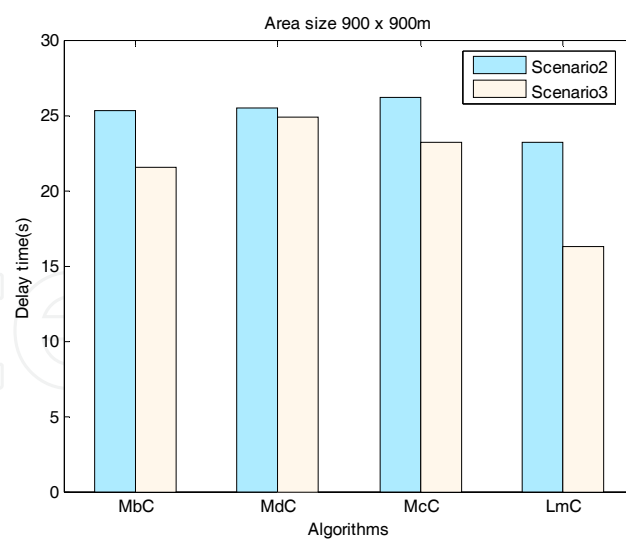

(b) Network area size 900x900m

Fig. 19. The delay time with the expansion of network area size

C. Number of successfully delivered packets

Figure 20 compares the number of successfully delivered packets for different clustering techniques when the network area size is expanded. It can be observed that the number of successfully delivered packets for all clustering techniques is improved due to the transmission range of both the base station and sensor nodes are extended. However, in the larger network area, a lower number of successfully delivered packets will be attained. The reason is because increasing the area size will also reduce the connectivity between sensor nodes in the network. Therefore, it decreases a chance that nodes can connect to the base station directly and have lower number of candidates for cluster heads.

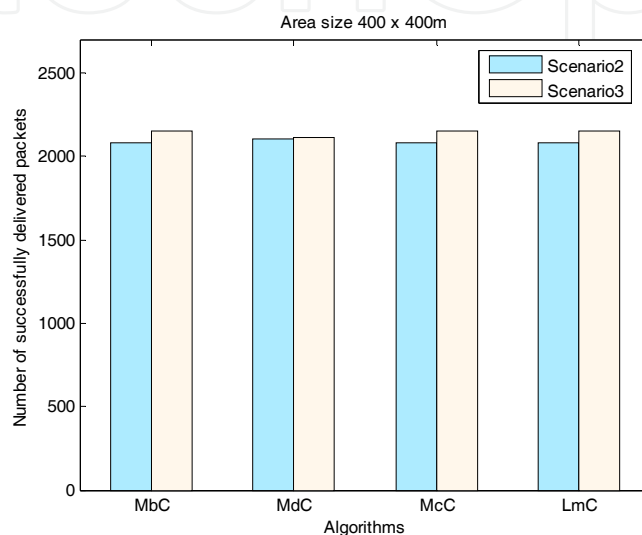

(a) Network area size 400x400m

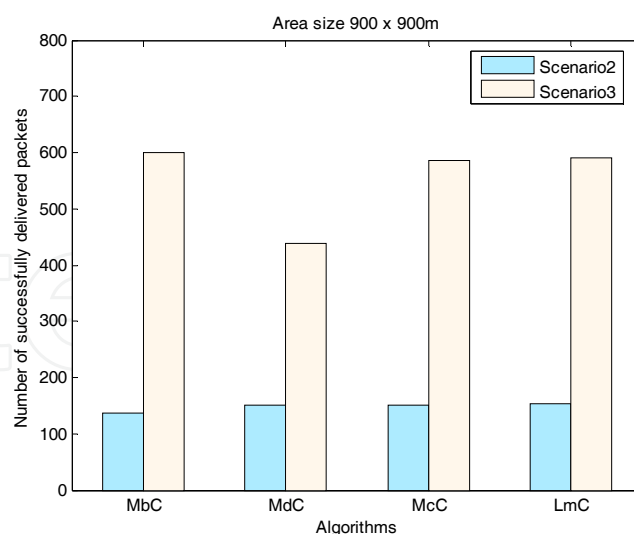

(b) Network area size 900x900m

Fig. 20. The number of successfully delivered packets with the expansion of network area size

4.3.3 Effect of network size

From the simulation results of previous cases discussed above, we found that the performances have been improved in term of the number of successfully delivered packets, the network lifetime and the delay time when we extend the transmission range of both the base station and sensor nodes. To study effect of network size, we vary the number of sensor nodes randomly generated and distributed in a square area of 400 meters by 400 meters. The simulation results of the scenario2 and scenario3 are compared and shown in the following.

A. Network lifetime

Figure 21 compares the network lifetime of clustering techniques for different number of nodes in the network. The results show that Minimum distance Clustering (MdC) has the shortest network lifetime. The reason is because the MdC selects the nearest cluster head so the selected cluster head is often used and the battery level is exhausted quickly. Note that the cluster heads located in the transmission range of the base station will have heavy load from aggregated data packets which are forwarded to the base station. On the other hand, the LmC has the longest network lifetime. The reason is because the LmC technique considers the distance, energy usage and residual battery level in the cost function for the cluster head selection. However, all clustering techniques have improved network lifetime when the transmission range is extended.

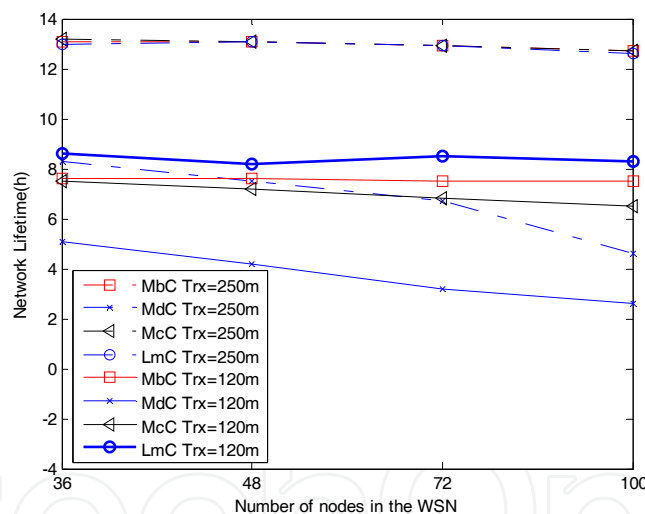

Fig. 21. Network lifetime

B. Delay time

Figure 22 shows the delay time of different clustering techniques by varying the number of sensor nodes in the wireless sensor network. The simulation results show that the LmC has the shortest delay time while other techniques have obviously higher delay time since the transmission range is limited. The reason is because the LmC can equally balance the number of member nodes for each cluster head. On the other hand, other techniques select the cluster head based on each parameter constraint which yields a single cluster head in each cycle. Therefore, the single selected cluster head is heavily loaded by aggregated data packets and uses more time to forward those data packets to the base station.

However, in the case of extending the transmission range to 250m, all techniques have improved delay time to the same level. The reason is because in the small area with the extension of transmission range, most sensor nodes are located within the base station's range so they can connect with the base station directly.

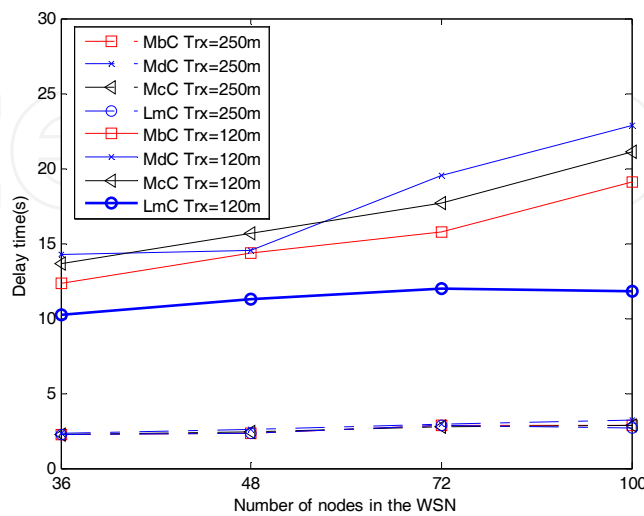

Fig. 22. The delay time

C. Number of successfully delivered packets

Figure 23 shows the number of successfully delivered packets for different clustering techniques. It can be observed that the MdC has less number of successfully delivered packets than the other three techniques. This suggests that the number of successfully delivered packets is related to the network lifetime. Since the MdC cluster head selection based on distance between nodes can not balance the burden of cluster heads, the battery of cluster heads within the base station's range will be exhausted early. Therefore, some packet losses occur at the cluster heads. On the other hand, the LmC can maintain high number of successfully delivered packets.

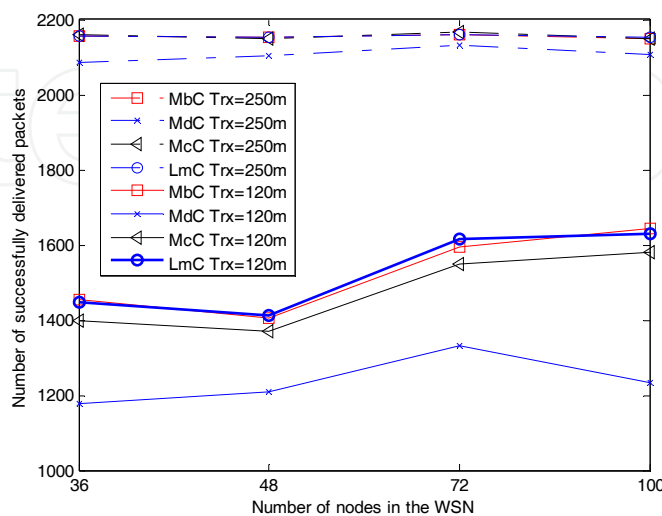

Fig. 23. The number of successfully delivered packets

5. Conclusion

In this chapter, we introduce the background of wireless sensor network and the characteristic of sensor node. A review of routing and clustering algorithms is given. We present a new energy-efficient clustering technique called Limiting member node Clustering (LmC) to balance the burden of each cluster head by limiting the number of member nodes assigned to each cluster head. The proposed LmC technique selects a cluster head based on the cost function which takes residual battery level, energy consumption and distance to the base station into consideration. We also present simulation results to compare the performance of LmC with other three cluster head selection techniques which are Minimum distance Clustering (MdC), Maximum battery Clustering (MbC) and Minimum cost function Clustering (McC). Simulation results show that the proposed limiting member node clustering (LmC) approach can achieve high number of successfully delivered packets as well as the highest network lifetime while give the shortest delay time. Hence, the LmC is an energy-aware clustering technique and capable of providing good performances for cluster head selection in wireless sensor networks.

6. Reference

- Yoo S., Kim J., Kim T., Ahn S., Sung J., Kim D.; A2S: Automated Agriculture System based on WSN; Consumer Electronics; 2007. ISCE 2007; Page(s):1 - 5
- Galmes S.; Lifetime Issues in Wireless Sensor Networks for Vineyard Monitoring; Mobile Adhoc and Sensor Systems (MASS); 2006 Oct. 2006; Page(s):542 - 545
- Guo Y., Corke P., Poulton G., Ark T., Bishop-Hurley G., Swain D.; Animal Behavior Understanding using Wireless Sensor Networks; Local Computer Networks; Proceedings 2006 31st IEEE; Page(s):607 - 614
- Xuemei L., Liangzhong J., Jincheng L.; Home healthcare platform based on wireless sensor networks; Technology and Applications in Biomedicine; 2008. ITAB 2008; Page(s):263 - 266
- Fariborzi H., Moghavvemi M.; Architecture of a Wireless Sensor Network for Vital Signs Transmission in Hospital Setting; Convergence Information Technology; 2007; Page(s):745 - 749
- Arjan D., Mimoza D., Leonard B.; Secure Mobile Communications for Battlefields; Complex Intelligent and Software Intensive Systems, 2008. CISIS 2008; Page(s):205 - 210
- Lee S. H., Lee S., Song H., Lee H. S.; Wireless sensor network design for tactical military applications : Remote large-scale environments; Military Communications Conference 2009. MILCOM2009. IEEE; Page(s): 1 - 7
- Hongwen X., Qizhi Z.; Wireless Sensors Network Design for Real-time Abrupt Geological Hazards Monitoring; Computer Science and Information Technology; 2008. ICCSIT'08; Page(s):959 - 962
- Chayon M., Rahman T., Rabbi M.F., Masum M.; Automated river monitoring system for Bangladesh using wireless sensor network; Computer and Information Technology, 2008. ICCIT 2008.; Page(s):1 - 6
- Ibriq J. , Margoub L.; Cluster-Based Routing in Wireless Sensor Networks: Issues and Challenges; SPECTS 2004; Page(s): 759-766

- Fedor S., Collier M.; On the Problem of Energy Efficiency of Multi-Hop vs One-Hop Routing in Wireless Sensor Networks; *Advanced Information Networking and Applications Workshops, 2007; AINAW '07. 21st International Conference*; Page(s): 380 - 385
- Jia W., Wang T., Wang G., Guo M.; Hole Avoiding in Advance Routing in Wireless Sensor Networks; *Wireless Communications and Networking Conference, 2007.WCNC 2007*; Page(s):3519 - 3523
- Shen Y., Wu Q., Wang X., Bi H.; Wireless sensor network energy-efficient routing techniques based on improved GEAR; *Network Infrastructure and Digital Content, 2009. IC-NIDC 2009. IEEE International*; Page(s): 114 - 118
- Hu L., Li Y., Chen Q., Liu J. and Long K.; A New Energy-Aware Routing Protocol for Wireless Sensor Networks; *Wireless Communications, Networking and Mobile Computing 2007*; Page(s): 2444 - 2447.
- Wang G., Wang T., Jia W., Guo M., Chen H.-H., Guizani M.; Local Update-Based Routing Protocol in Wireless Sensor Networks with Mobile Sinks; *Communications, 2007*; Page(s): 3094 - 3099.
- Kai L.; A Mine-Environment-Based Energy-Efficient Routing Algorithm for Wireless Sensor Network; *Hybrid Intelligent Systems, 2009. HIS '09. Ninth International*; Page(s): 215 - 218
- Handy M. J., Haase M., Timmermann D.; Low-Energy Adaptive Clustering Hierarchy with Deterministic Cluster-Head Selection; 2002
- Younis O., Fahmy S.; HEED:A Hybrid Energy-Efficient Distributed Clustering Approach for Ad-hoc Sensor Networks, *Mobile Computing*; *IEEE Transactions on Volume 3*; Issue 4; Oct.-Dec. 2004; Page(s): 366 - 379
- Qiu W., Skafidas E., Hao P., Kumar D.; Enhanced tree routing for wireless sensor networks *Ad Hoc Networks*; Volume 7; Issue 3; May 2009; Page(s): 638-650
- Gong B., Li L., Wang S., Zhou X.; Multihop Routing Protocol with Unequal Clustering for Wireless Sensor Networks; *Computing, Communication, Control and Management*; 2008; *ISECS International Colloquium on Volume 2*; Page(s): 552 - 556
- Dali W., Chan H. A.; Clustering Algorithm to Balance and to Reduce Power Consumptions for Homogeneous Sensor Networks; *Wireless Communications; Networking and Mobile Computing, 2007. WiCom 2007*; Page(s): 2723 - 2726
- Zhang R., Jia Z., Wang L.; A Maximum-Votes and Load-Balance Clustering Algorithm for Wireless Sensor Networks; *Wireless Communications, Networking and Mobile Computing, 2008. WiCOM '08. 4th International Conference*; Page(s): 1 - 4
- Murthy G.R., Iyer V., Radhika B.; Level controlled clustering in wireless sensor networks; *Sensing Technology, 2008. ICST 2008. 3rd International Conference 2008*; Page(s): 130 -134
- Chang J.-H., Tassiulas L.; Maximum lifetime routing in wireless sensor networks; *Networking IEEE/ACM Transactions on Volume 12*; Issue 4, Aug. 2004; Page(s): 609-619
- Muruganathan S.D., Daniel C.F., Bhasin R.I., Fapojuwo A.O.; A centralized energy-efficient routing protocol for wireless sensor networks; *Communications Magazine, IEEE Volume 43*; Issue 3, March 2005; Page(s): S8 - S13.
- Ergen S. C.; *ZigBee/IEEE802.15.4 Summary*; Sep 2004

IntechOpen

IntechOpen

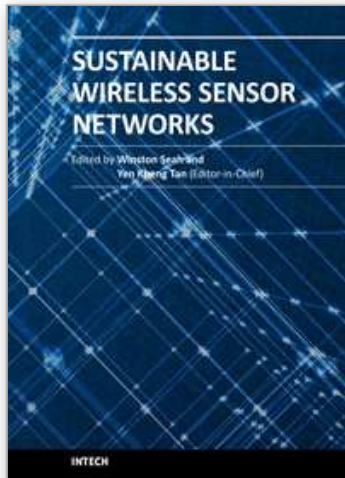

Sustainable Wireless Sensor Networks

Edited by Yen Kheng Tan

ISBN 978-953-307-297-5

Hard cover, 574 pages

Publisher InTech

Published online 14, December, 2010

Published in print edition December, 2010

Wireless Sensor Networks came into prominence around the start of this millennium motivated by the omnipresent scenario of small-sized sensors with limited power deployed in large numbers over an area to monitor different phenomenon. The sole motivation of a large portion of research efforts has been to maximize the lifetime of the network, where network lifetime is typically measured from the instant of deployment to the point when one of the nodes has expended its limited power source and becomes in-operational – commonly referred as first node failure. Over the years, research has increasingly adopted ideas from wireless communications as well as embedded systems development in order to move this technology closer to realistic deployment scenarios. In such a rich research area as wireless sensor networks, it is difficult if not impossible to provide a comprehensive coverage of all relevant aspects. In this book, we hope to give the reader with a snapshot of some aspects of wireless sensor networks research that provides both a high level overview as well as detailed discussion on specific areas.

How to reference

In order to correctly reference this scholarly work, feel free to copy and paste the following:

Wibhada Naruephiphat and Chalermopol Charnsripinyo (2010). An Energy-aware Clustering Technique for Wireless Sensor Networks, Sustainable Wireless Sensor Networks, Yen Kheng Tan (Ed.), ISBN: 978-953-307-297-5, InTech, Available from: <http://www.intechopen.com/books/sustainable-wireless-sensor-networks/-energy-aware-clustering-techniques-for-wireless-sensor-networks->

INTECH
open science | open minds

InTech Europe

University Campus STeP Ri
Slavka Krautzeka 83/A
51000 Rijeka, Croatia
Phone: +385 (51) 770 447
Fax: +385 (51) 686 166
www.intechopen.com

InTech China

Unit 405, Office Block, Hotel Equatorial Shanghai
No.65, Yan An Road (West), Shanghai, 200040, China
中国上海市延安西路65号上海国际贵都大饭店办公楼405单元
Phone: +86-21-62489820
Fax: +86-21-62489821

© 2010 The Author(s). Licensee IntechOpen. This chapter is distributed under the terms of the [Creative Commons Attribution-NonCommercial-ShareAlike-3.0 License](https://creativecommons.org/licenses/by-nc-sa/3.0/), which permits use, distribution and reproduction for non-commercial purposes, provided the original is properly cited and derivative works building on this content are distributed under the same license.

IntechOpen

IntechOpen