

We are IntechOpen, the world's leading publisher of Open Access books Built by scientists, for scientists

4,800

Open access books available

122,000

International authors and editors

135M

Downloads

Our authors are among the

154

Countries delivered to

TOP 1%

most cited scientists

12.2%

Contributors from top 500 universities



WEB OF SCIENCE™

Selection of our books indexed in the Book Citation Index
in Web of Science™ Core Collection (BKCI)

Interested in publishing with us?
Contact book.department@intechopen.com

Numbers displayed above are based on latest data collected.
For more information visit www.intechopen.com



Reactive Robot Control with Hybrid Operational Techniques in a Seaport Container Terminal Considering the Reliability

Satoshi Hoshino and Jun Ota

*Tokyo Institute of Technology and The University of Tokyo
Japan*

1. Introduction

In a seaport container terminal system, there are various types of container-handling and transport machines (Guenter, 2005). Machine reliability is a particularly serious concern due to the fact that the system is subjected to salt erosion. The reliability of an item is expressed by the probability that the item will perform its required function under given conditions for a stated time interval (Biolini, 2007).

In research that deals with flexible manufacturing systems (FMSs), system reliability has already been investigated from the viewpoint of the endurance and fault tolerance of robots or machines (Beamon, 1998) (Sun, 1994). Savsar has described the importance of preventive and corrective maintenance for system reliability (Savsar, 2005). On the other hand, few investigations of seaport container terminal systems consider reliability; one of these studies by Hoshino et al. deals with the reliability design of intelligent machines, i.e., operating robots (Hoshino & Ota, 2007), and another, by Bruzzone et al., deals with container logistics node design (Bruzzone et al., 2007). However, although operating robots are preventively maintained on the basis of the confidence level, robot failure has not been considered at all (Hoshino & Ota, 2007).

In an actual seaport container terminal system, in order to minimize the loss of operating efficiency even when a robot undergoes maintenance, a large number of robots are readied and used on the assumption that operating robots fail fortuitously. However, such a policy increases the required number of robots, and, therefore, the initial investment. Therefore, in this paper, we approach this issue from the system management aspect.

Fig.1 shows a horizontal transportation system with automated guided vehicles (AGVs), namely, the AGV transportation system in one berth. A seaport container terminal generally consists of several berths what are arranged along a wharf. The effectiveness of the system has been shown compared to the vertical one by controlling the operating robots including the AGV efficiently (Hoshino et al., 2007). Thus, we address and manage the horizontal system considering efficient maintenance of the operating robots.

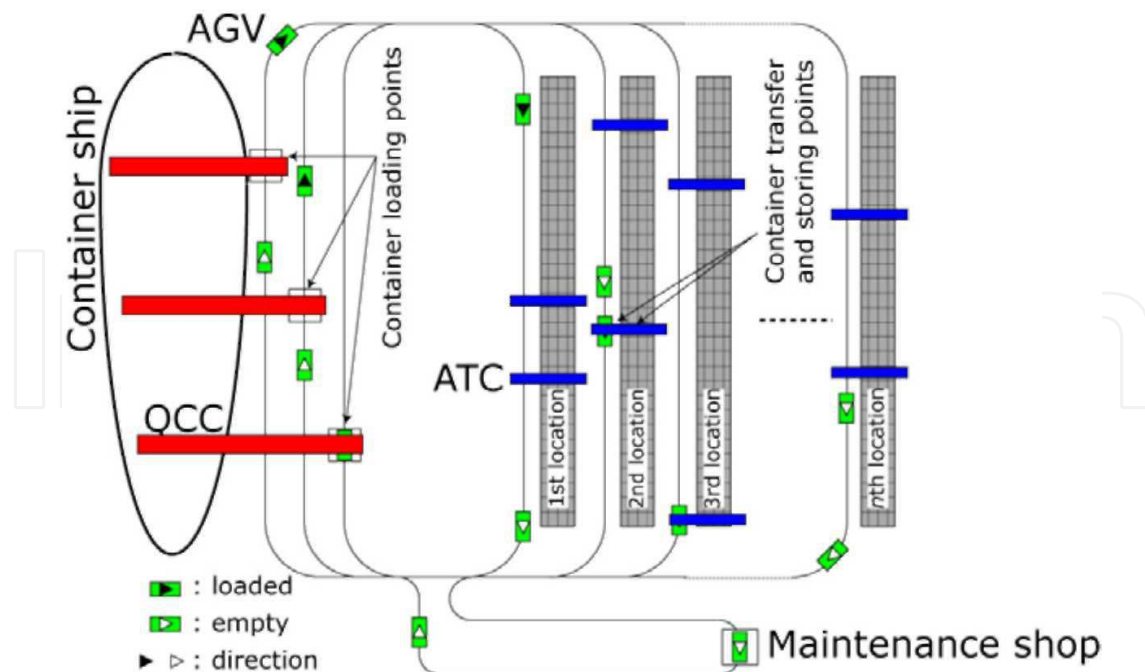

Fig. 1. Horizontal AGV transportation system in a seaport container terminal (top view)

2. Seaport Container Terminal

2.1 Horizontal AGV transportation system

In the horizontal AGV transportation system shown in Fig.1, quay container cranes (QCCs) at the quay side, automated transfer cranes (ATCs) at the container storage yard side, and AGVs for container transport between the quay and yard sides are in operation. In this paper, we refer to the AGV and ATC as operating robots. Since each robot has a radio communication device, the robots are able to share their information with neighbors based on the distributed blackboard, namely, 'sign-board' model (Wang, 1994). A container storage location consists of a 320 [TEU (Twenty-foot Equivalent Unit)] container space. There are three QCCs at the quay side in a general berth, and two ATCs of different sizes are operating at one location.

While Qiu, Hsu, and Zeng have focused on a transportation system with a bidirectional path layout to take into account inter-berth operations (Qiu & Hsu, 2001) (Zeng and Hsu, 2008), in this paper, we focus on a unidirectional path layout because the layout is suitable for more conflict-free container routing even if a simple and feasible routing rule for the system automation is applied. Thus, we do not address a multiple berth scenario, such as a traffic pattern of distributing into and gathering from different berths.

2.2 Container-handling operation

We limit container movement to one-way flow, i.e., from the quay side to the yard side in the course of container loading, transport, transfer, and storing operations as follows:

- 1) A QCC loads a container from the container ship to the AGV.
- 2) The AGV transports the container from the quay side to a destination location in the container storage yard.

- 3) Right after the AGV goes into an adjacent yard lane to the container storing location, an ATC in an idle state is called by the AGV.
- 4) The AGV begins container transfer to the ATC after the ATC arrives at the container transferring position.
- 5) The AGV that has completed the container transferring goes back to a QCC.
- 6) The ATC to which the container has been transferred stores it at the storage position; it then becomes an idle state for a next operation.

The effectiveness of the container assignment and order scheduling methods has been shown by the authors (Hoshino et al., 2005) (Hoshino et al., 2006). Thus, the operating robots perform container-handling tasks as follows: regardless of the operational state, the tasks are equally given from three QCCs; in other words, containers are equally loaded onto the AGVs by the QCCs. In addition, the containers are equally assigned to each location in the container storage yard. An execution order of the tasks is scheduled so that the total moving distance of the ATCs is minimized.

3. Challenges

Fig.2 shows the container-handling simulation result with the AGVs and ATCs. Fig.2(a) indicates the throughput of an ideal system in which, although the operating robots are not maintained preventively, they do not fail at all. Fig.2(b) indicates the throughput of a system in which preventive maintenance of the operating robots and corrective maintenance for a failed robot are done. Here, the mean time between failures (MTBFs) of the AGV and ATC in the simulation (Fig.2(b)) are 50 and 40 hours, respectively. From the results shown in Fig.2(a), it is evident that the throughput increases as the number of AGVs and ATCs increases, and, then, the throughput converges at 130 [TEU/hour]. On the other hand, from the results shown in Fig.2(b), it is evident that the maximum throughput is less than 120 [TEU/hour]; sometimes the throughput does not converge. In addition, it is clear that the throughput decreases significantly due to the maintenance activity.

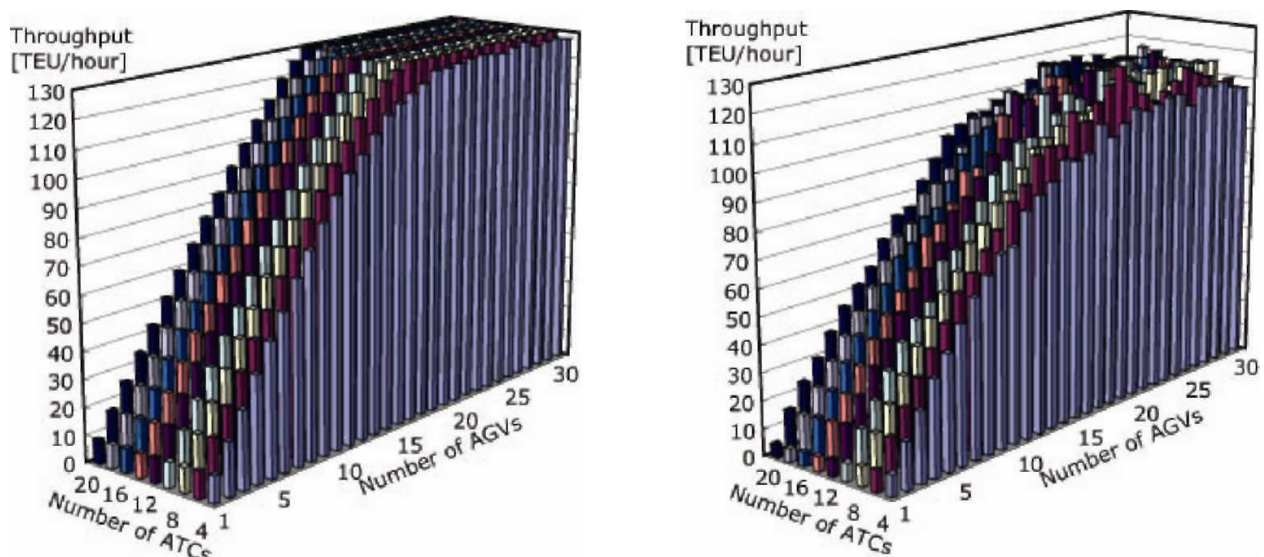

(a) Ideal system without any maintenance

(b) Actual system with preventive and corrective maintenance.

Fig. 2. Container-handling simulation result: system throughputs

These results denote that the system shown in Fig.2(b) is insufficient for a system in which the operating robots have to be maintained in consideration of robot reliability. Hence, for the realization of efficient and flexible container handling, we address the following challenge:

- Even in a case in which a robot has to be maintained due to decreased operational function or failure, ideally, the system should continue operation as efficiently as possible without interruption, as shown in Fig.2(a). Hopefully, this is done by controlling other robots and preventing the system from being obstructed by the robot undergoing maintenance.

For this challenge, we focus on operational techniques in order to utilize the mutual substitutability of the operation among robots that have similar functions. We define the system operational states as follows: 1. normally operating, 2. preventive maintenance, and corrective maintenance, and develop suitable operational techniques for the three states. By applying the developed hybrid operational techniques, each robot is able to respond to the dynamically changing states 1 to 3 reactively. This is a reactive robot control system that takes reliability into account.

4. Robot Reliability

In this paper, we assume that the probability density function on the time span of a normally operating robot in the system follows an exponential distribution. Thus, the failure rate of the operating robot ($\lambda(t)$) at time t is constant (see Eq.(1)). Each operating robot, on the basis of the failure rate λ_0 , fails fortuitously (corrective maintenance state). Furthermore, the confidence level $R(t)$, which is the probability that the robot has not failed by time horizon, t , is derived from Eq.(2). Therefore, based on the confidence level, each robot stops operating and enters the preventive maintenance mode when its confidence level is under a given threshold value (preventive maintenance state). In other words, we decide the robot preventive maintenance timing on the basis of $R(t)$.

$$\lambda(t) = \lambda_0 \quad (1)$$

$$R(t) = e^{-\lambda_0 t} \quad (2)$$

The MTBF of the operating robot, $MTBF$, is derived from Eq.(3). From Eq.(1), Eq.(2), and Eq.(3), the failure rate $\lambda(t)$ and confidence level $R(t)$ can be derived from the reciprocal number of the MTBF.

$$MTBF = \int_0^{\infty} R(t) dt = \int_0^{\infty} e^{-\lambda_0 t} dt = \frac{1}{\lambda_0} \quad (3)$$

Note that although we assume the constant failure rate (CFR) in the bathtub curve and use the exponential distribution as the probability density function, these are not limited in this research framework. Other distributions, e.g., normal distribution and Weibull distribution are also available under the assumption of the decreasing or increasing failure rate (DFR or IFR) as necessary.

5. Reactive Robot Control with Hybrid Operational Techniques

5.1 Operational technique in the normal state

In the normally operating state, the robots are controlled with the use of the operational technique as follows: the AGV selects the shortest lane to the destination and does not change the destination and lane while moving. The ATC has its own operation area on the location, and, thus, the ATC does not operate in another ATC operational area.

5.2 Operational technique in the preventive maintenance state

Since there are a limited number of maintainers, in this paper, only one AGV and one ATC in the preventive maintenance mode are maintained. Hence, in a case in which multiple AGVs and ATCs enter the preventive maintenance mode at the same time, it is necessary to preventively maintain the robots efficiently in order to take advantage of the mutual substitutability of the operation among robots.

As for the AGV, if an AGV is preventively maintained on every transport lane, the AGV becomes an obstacle to other AGVs. To solve this problem, we parallelized the system by providing a maintenance shop as shown in Fig.3. By doing this, the system is able to keep operating except in a case in which all AGVs are in the maintenance mode and go to the maintenance shop. Here, an AGV that arrives at the maintenance shop first is maintained according to the First-In First-Out (FIFO) rule.

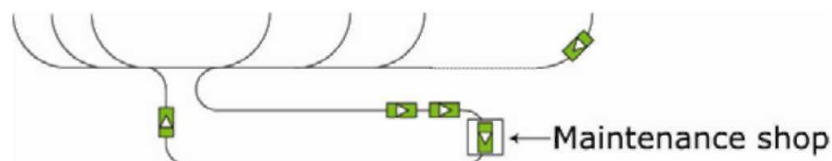

Fig. 3. Maintenance shop provided for the prevention of the operating AGVs

On the other hand, since there are two ATCs at one location, even if an ATC at the location is in the preventive maintenance mode, another ATC is able to perform its task instead by sharing their operation areas. Fig.4 shows container transfer and storing operations among the AGVs and ATCs in a case in which one ATC at the location enters the preventive maintenance mode. In Fig.4(a), two ATCs are normally operating; then, in Fig.4(b), one (small) ATC is in the preventive maintenance mode at the edge of the location. For this situation, if the other (large) ATC is in a standby state, the ATC moves to support the other's operation with the waiting AGV (see Fig.4(c)) in communication with the small ATC. However, if both ATCs at the location are in the preventive maintenance mode at the same time, the flow of incoming AGVs is disrupted on the adjacent yard lane to the location. As a result, the whole system operation might be interrupted. To solve this problem, we developed the following preventive maintenance rules:

- If there is a location where two ATCs are both in the preventive maintenance mode, one of two ATC at the location is selected for maintenance according to priority.

- If either ATC operates at every location, an ATC that enters the preventive maintenance mode first is maintained by rotation.

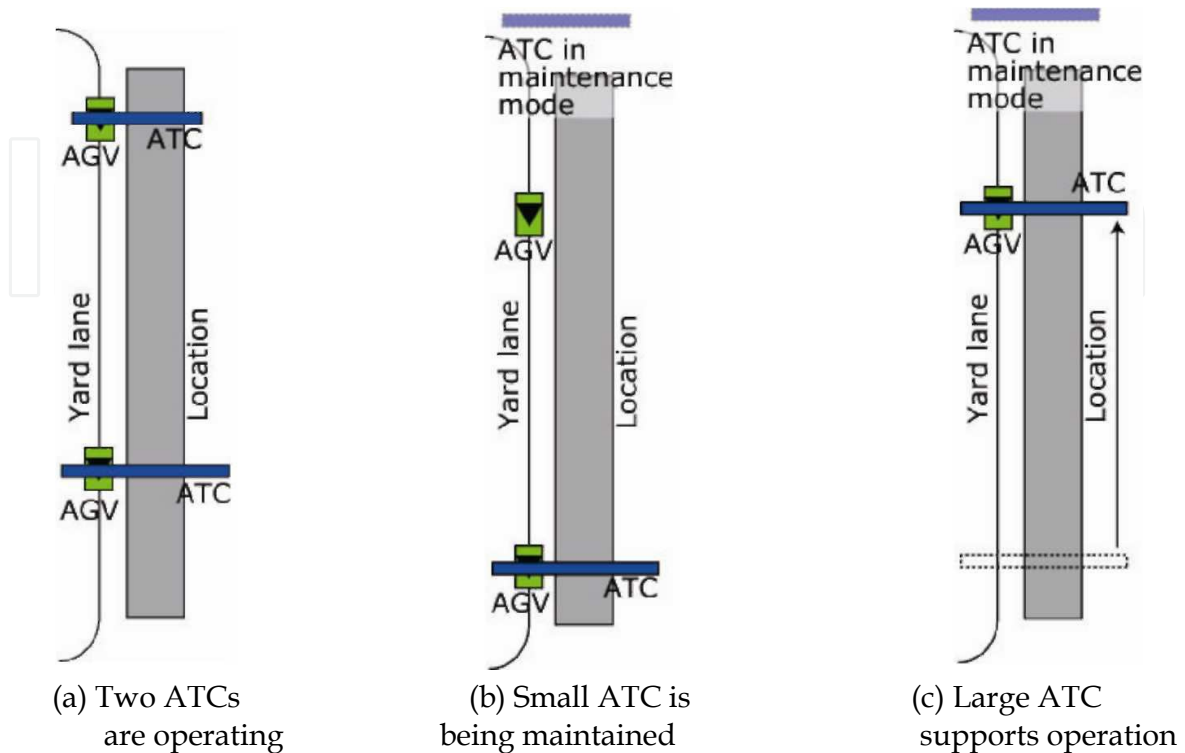

Fig. 4. Alternative operation performed by an operating ATC instead

5.3 Operational technique in the corrective maintenance state

It is difficult to completely prevent the accidental failure of the operating robots even if they are maintained for prevention regularly. A failed robot stops at the current position for the corrective maintenance. Therefore, as well as the operational technique in the preventive maintenance state, we consider an operational technique in the corrective maintenance state in order to take advantage of the mutual substitutability of the operation. In this paper, we focus on operational techniques for the AGV in the quay and container storage yard sides, where there are multiple lanes. In communication with each other on a communication lane, an AGV is able to identify whether any failed AGVs or ATCs exist in the quay and container storage yard sides.

5.3.1 Operational technique in the quay side

- If there is a failed AGV at a destination (QCC) or on the lane, the normally operating AGV changes the destination to another QCC closest to the current destination as a new destination according to priority and selects a new lane.
- However, if there are several QCCs that have same priority, the AGV changes the current destination to a QCC located on the yard side and selects a new lane as well in consideration of the moving distance of the AGV.

Fig.5 shows an example of the operation when an AGV fails in the quay side. Here, in the quay side, there are three QCCs operating on three quay lanes (QLs). Fig.5(a) shows that the quay side destination (QD) of an AGV moving on the (red) communication lane is QD 3.

However, the AGV notices that a failed AGV exists on QL 3 in communication with AGVs; hence, the AGV changes the destination from QD 3 to QD 2 and selects QL 2. Fig.5(b) shows a case in which, while the AGV on the communication lane is moving to destination QD 3, there are failed AGVs on QLs 3 and 2. In this case, the AGV changes the destination to QD 1 and selects QL 1.

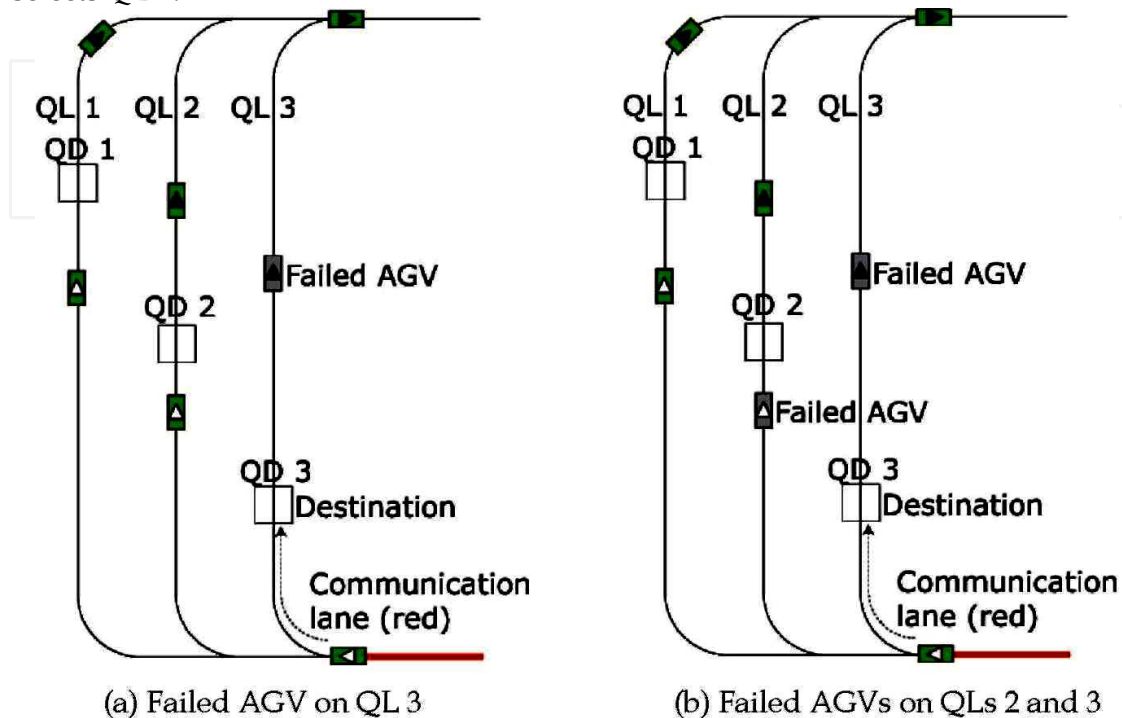

Fig. 5. Operation at the quay side in the corrective maintenance state

5.3.2 Operational technique in the yard side

- If there are failed ATCs and AGVs at a destination (location) or on the lane, the normally operating AGV changes its destination to another location closer to the current destination from the locations located on the quay side in comparison to the current destination according to priority and selects a new lane.
- However, if there are failed ATCs and AGVs at every location or on every lane located on the quay side, the normally operating AGV changes the destination to another location closer to the current destination from the locations located on the land side according to priority and selects a new lane.
- The container transfer and storing points at a location are not changed even if the destination is changed.

Fig.6 shows an example of the operation in a case in which the AGVs and ATCs failed in the container storage yard. Fig.6(a) shows that the yard side destination (YD) of an AGV moving on the (red) communication lane is YD 3, located at the adjacent 3rd location to the yard lane (YL) 3. However, the AGV notices that there is a failed AGV on YL 3 through communication with other AGVs and ATCs; hence, the AGV changes the destination from YD 3 to YD 2 from the candidates YD 1, 2, 4, and 5 and selects YL 2. In Fig.6(b), there are one failed ATC at the first location and failed AGVs on YL 3 and 2. In this case, the destination is changed to YD 4, and then YL 4 is selected as well.

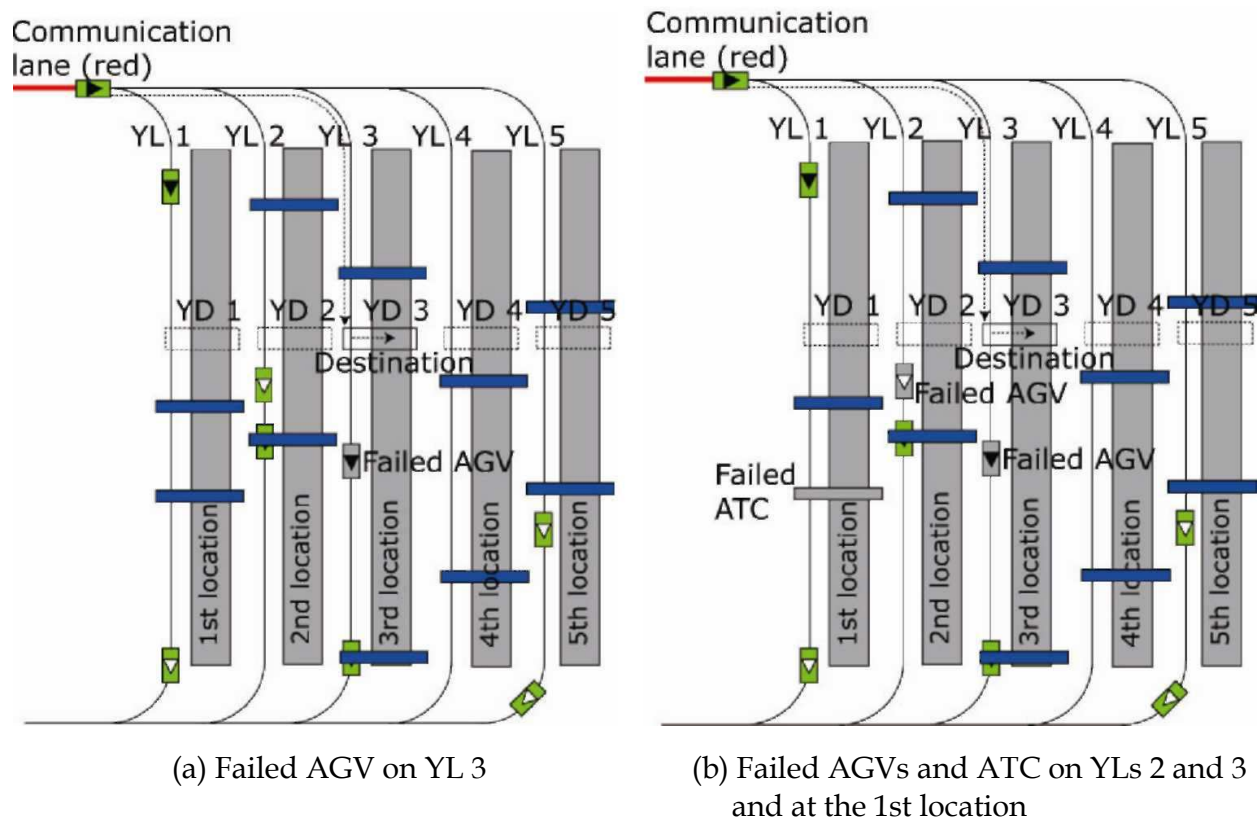

Fig. 6. Operation at the container storage yard in the corrective maintenance state

6. Simulation Experiment

6.1 Experimental condition

The MTBFs of the AGV and ATC are 50 and 40 hours, respectively. These are minimum parameters given in our previous work (Hoshino & Ota, 2007). Each operating robot is preventively maintained at time t when the confidence level is less than 0.9, that is, $R(t) < 0.9$. The $R(t)$ of a robot, which was once preventively maintained, is reset to one ($R(t) = 1.0$). Here, the initial confidence level of each operating robot at the start of a simulation is given randomly as follows: $0 < R(t) < 1$.

As for preventive maintenance, we assume parts inspection, consumable parts replacement, and main parts replacement; thus, 0.3 to 0.5 [hour] for the AGV and 0.2 to 0.4 [hour] for the ATC are required. These preventive maintenance times are randomly determined with a uniform probability. As for the failed robots, 0.5 to 1.0 [hour] for the AGV and 0.4 to 1.0 [hour] for the ATC are required for their correction. These corrective maintenance times are also determined in a random manner with a uniform probability.

The number of containers that must be unloaded from a containership, that is, the number of tasks, is 600 [TEU]. Here, because there is a 320 [TEU] container space at one location, two locations, i.e., at least four ATCs, are needed in the system. In this experiment, we do a 10-time simulation for 10 incoming container ships. The maximum numbers of AGVs and ATCs used in the container-handling simulation are 30 and 20, respectively. As for the performance of the AGV for the container transport, the maximum traveling speeds are given as 5.56 (loaded) and 6.94 (empty) [m/s] depending on the presence of a container. The acceleration and deceleration speeds are 0.15 and 0.63 [m/s²] regardless of the presence of a

container. The maximum moving speed of the ATC is 2.5 [m/s], and the acceleration and deceleration speeds are 0.1 and 0.4 [m/s²], respectively. The container unloading/loading time by the QCC, the container transfer time from the AGV to the ATC, and the container storing time by the ATC, which are described in 2.2, are 60, 30, and 30 seconds, respectively. To discuss the effectiveness of the proposed reactive robot control system with the developed three hybrid operational techniques, we compare the proposed system to (I) the ideal system, in which, although the operating robots are not preventively maintained, they do not fail at all with the use of the operational technique described in 5.1 (see Fig.2(a)), and (II) a system in which, although the operating robots are preventively maintained with the use of the two operational techniques described in 5.1 and 5.2, they are not efficiently controlled in the corrective maintenance state (see Fig.2(b)).

6.2 Simulation result

Fig.7 shows the comparison result of the systems on the basis of the throughput. The blue (and diamond-shaped) plot denotes the throughput of the ideal system (I); the red bar graph denotes the throughput of the system (II); and the white bar graph denotes the throughput of the proposed system, in which the operating robots are reactively controlled even in the corrective maintenance state by switching three hybrid operational techniques, described in 5.1, 5.2, and 5.3.

From the result, for the system in which the robots, which have to be maintained for the prevention and correction in consideration of the reliability, are operating, we can see that the proposed system throughput for the all combination of AGVs and ATCs is higher than the throughput of the system (II). From the results of Fig.7(d) to Fig.7(f), we obtained several higher throughputs near the ideal system throughputs. This is because the robots failed on the lanes in the quay or yard sides. In addition, the other operating robots successfully responded to the corrective maintenance state with the third operational technique. These results indicate that the robots are successfully controlled with the use of the hybrid operational techniques. On the other hand, we also obtained several throughputs near the throughputs of the system (II), e.g., as shown in Fig.7(a) with 26 AGVs. The reason for this result is that there were AGVs that failed on a single lane, such as the communication lane, and not on multiple lanes, such as the quay and yard lanes. In this case, it is needed to develop the fourth operational technique on a single lane to avoid a failed robot.

6.3 Effectiveness of the proposed system

Table 1 shows the increase of the throughput of the proposed system relative to the throughput of system (II) on the basis of the result shown in Fig.7. To discuss the effectiveness of the proposed system, the increase of the throughput is calculated after the throughput of the ideal system with a certain number of AGVs becomes nearly flat (see blue and diamond-shaped plots in Fig.7). In other words, the increase of the throughput when the number of AGVs is more than 20 in the result of Fig.7(a) and 17 in other results Fig.7(b) to Fig.7(i) is examined. In the table, 'average' represents the average value of the difference between the proposed system throughput and the system throughput of (II), 'max.' represents the maximum value of the difference, and 'min.' represents the minimum value of the difference.

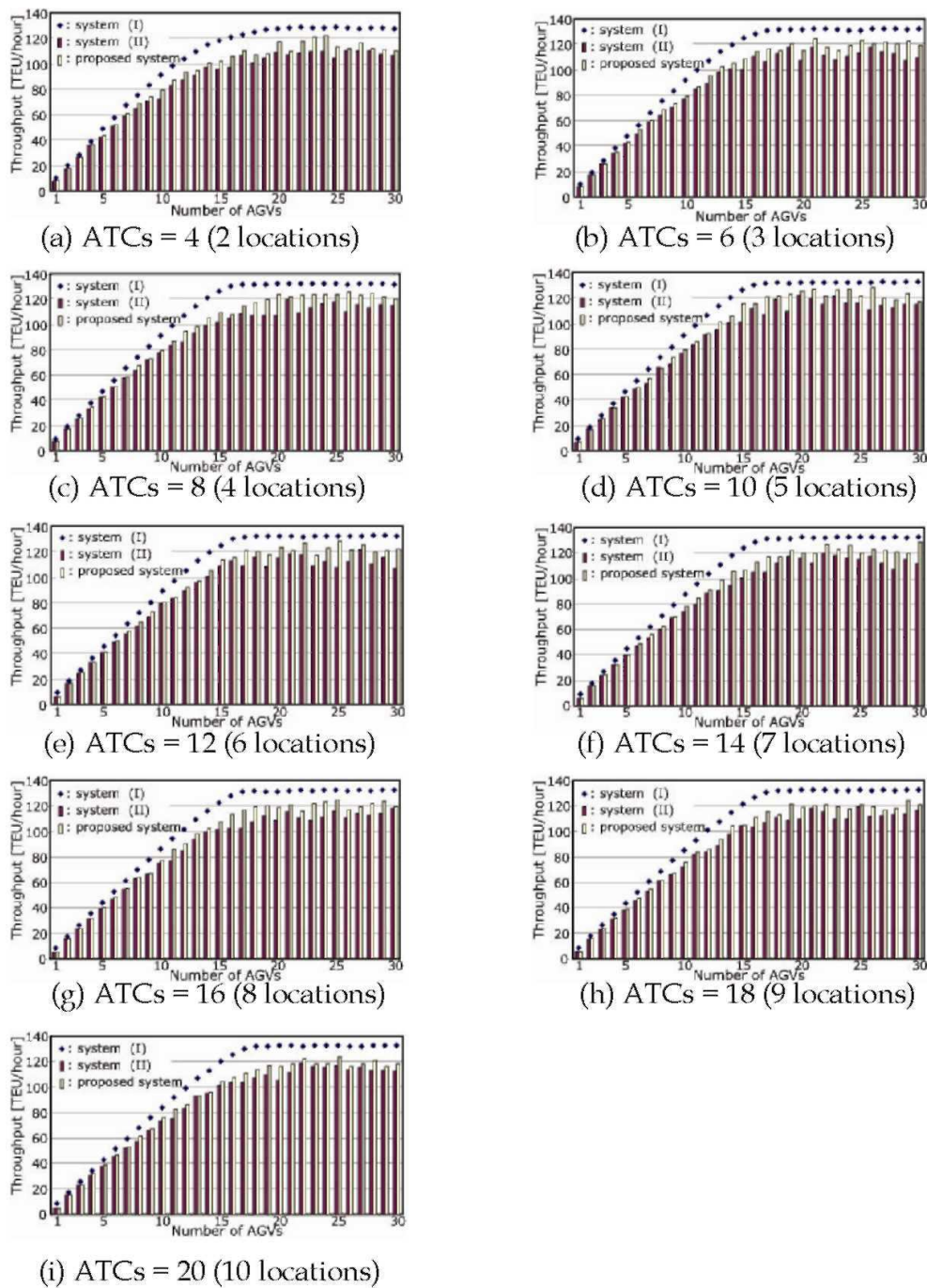

Fig. 7 Comparison result of systems on the basis of the throughputs

From Table 1, we can see that the increase of the proposed system throughput is 5.4 to 9.2 (average), 11.6 to 20.5 (max.), and 0.9 to 4.0 (min.). The average increase of 9.2 [TEU/hour] produces an increase of 100 [TEU] container volume within 10 hours of system operating time. From the result of the maximum value, the increase in container volume within 10 hours of system operating time was up to 200 [TEU].

# of ATCs (locations)	Average [TEU/hour]	Max. [TEU/hour]	Min. [TEU/hour]
4 (2)	6.0	12.3	0.9
6 (3)	7.5	15.0	2.6
8 (4)	9.2	16.6	1.9
10 (5)	7.5	16.7	2.1
12 (6)	9.2	20.5	2.4
14 (7)	7.8	17.2	4.0
16 (8)	8.6	14.2	1.3
18 (9)	6.4	13.0	1.0
20 (10)	5.4	11.6	2.1

Table 1. Increase of the system throughput

Furthermore, we can see that the proposed system is particularly effective when the 6 to 16 ATCs were used. This is because the number of yard lanes increases or decreases according to the number of locations in the container storage yard. In the proposed system, since the robots perform the given tasks by switching three hybrid operational techniques reactively, the AGVs could not change and select their destinations and lanes appropriately in a case in which there were few yard lanes in the yard side, e.g., four ATCs and two lanes (locations). As a result, the increase of the throughput was comparatively low. In a case in which 18 or 20 ATCs were used, i.e., there were 9 or 10 yard lanes and locations, the AGVs did not go into the yard lane successively even if an AGV or ATC failed on the yard lane or location because the tasks are assigned to each location equally for the AGVs, as described in 2.2. Hence, the increase of the throughput was low in the system with many ATCs. However, from the result that the entire throughput was higher than that of the system (II), finally, the effectiveness of the proposed system in the dynamically changing states was shown.

7. Conclusion

In this paper, we proposed a reactive robot control system with hybrid operational techniques in a seaport container terminal considering the robots' reliability. We developed operational techniques in the normal, preventive maintenance, and corrective maintenance states in order to utilize the mutual substitutability of the operation among robots. In the system, each robot was able to respond to the dynamically changing states reactively with the use of the hybrid operational techniques. Finally, for flexible and efficient container handling, we showed the effectiveness of the proposed system through a simulation experiment.

In future works, we will additionally take into account: (I) a multiple berth scenario in the systems which consist of a bidirectional path layout by developing more complex container routing rule and (II) a fluctuation of the lulls and peaks in the workload for the robots in the maintenance of them, for a highly efficient system.

8. References

- Guenter, H.-O. & Kim, K.H. (2005). Container terminals and automated transport systems, Springer, ISBN 3-540-22328-2, Berlin Heidelberg Germany.
- Birolini, A. (2007). Reliability engineering: theory and practice, Springer, ISBN 978-3-540-49388-4, Berlin Heidelberg Germany.
- Beamon, B.M. (1998). Performance, reliability, and performability of material handling systems. *International Journal of Production Research*, Vol. 3, No. 2, pages 377-393.
- Sun, Y. (1994). Simulation for maintenance of an FMS: an integrated system of maintenance and decision-making. *The International Journal of Advanced Manufacturing Technology*, Vol. 9, No. 1, pages 35-39.
- Savsar, M. (2005). Performance analysis of an FMS operating under different failure rates and maintenance policies. *International Journal of Flexible Manufacturing Systems*, Vol. 16, No. 3, pages 229-249.
- Hoshino, S. & Ota, J. (2007). Design of an automated transportation system in a seaport container terminal for the reliability of operating robots, *IEEE/RSJ International Conference on Intelligent Robots and Systems*, pages 4259-4264.
- Bruzzone, A.G., Bocca, E., Longo, F., & Massei, M. (2007). Training and recruitment in logistics node design by using web-based simulation. *International Journal of Internet Manufacturing and Services*, Vol. 1, No. 1, pages 32-50.
- Hoshino, S., Ota, J., Shinozaki, A., & Hashimoto, H. (2007). Hybrid design methodology and cost-effectiveness evaluation of AGV transportation systems. *IEEE Transactions on Automation Science and Engineering*, Vol. 4, No. 3, pages 360-372.
- Wang, J. (1994). On sign-board based inter-robot communication in distributed robotic systems, *IEEE International Conference on Robotics and Automation*, pages 1045-1050.
- Qiu, L. & Hsu, W.-J. (2001). A bi-directional path layout for conflict-free routing of AGVs. *International Journal of Production Research*, Vol. 39, No. 10, pages 2177-2195.
- Zeng, J. & Hsu W.-J. (2008). Conflict-free container routing in mesh yard layouts. *Robotics and Autonomous Systems*, Vol. 56, No. 5, pages 451-460.
- Hoshino, S., Ota, J., Akiko, S., & Hashimoto, H. (2005). Highly efficient AGV transportation system management using agent cooperation and container storage planning, *IEEE/RSJ International Conference on Intelligent Robots and Systems*, pages 2330-2335.
- Hoshino, S., Ota, J., Akiko, S., & Hashimoto, H. (2006). Design of an AGV transportation system by considering management model in an ACT, In: *Intelligent Autonomous Systems 9*, Eds. Arai, T., Pfeifer, R., Balch, T., & Yokoi, H., pages 505-514, IOS, ISBN 978-1-58603-595-2, Amsterdam Netherlands.

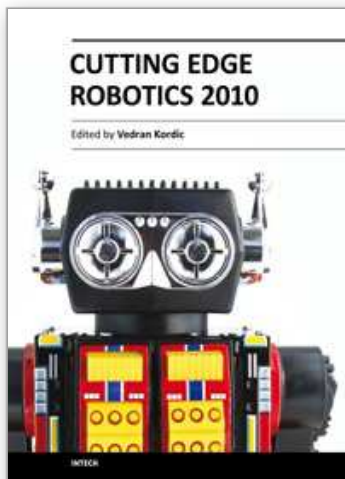

Cutting Edge Robotics 2010

Edited by Vedran Kordic

ISBN 978-953-307-062-9

Hard cover, 440 pages

Publisher InTech

Published online 01, September, 2010

Published in print edition September, 2010

Robotics research, especially mobile robotics is a young field. Its roots include many engineering and scientific disciplines from mechanical, electrical and electronics engineering to computer, cognitive and social sciences. Each of this parent fields is exciting in its own way and has its share in different books. This book is a result of inspirations and contributions from many researchers worldwide. It presents a collection of a wide range of research results in robotics scientific community. We hope you will enjoy reading the book as much as we have enjoyed bringing it together for you.

How to reference

In order to correctly reference this scholarly work, feel free to copy and paste the following:

Satoshi Hoshino and Jun Ota (2010). Reactive Robot Control with Hybrid Operational Techniques in a Seaport Container Terminal Considering the Reliability, Cutting Edge Robotics 2010, Vedran Kordic (Ed.), ISBN: 978-953-307-062-9, InTech, Available from: <http://www.intechopen.com/books/cutting-edge-robotics-2010/reactive-robot-control-with-hybrid-operational-techniques-in-a-seaport-container-terminal-considerin>

INTECH

open science | open minds

InTech Europe

University Campus STeP Ri
Slavka Krautzeka 83/A
51000 Rijeka, Croatia
Phone: +385 (51) 770 447
Fax: +385 (51) 686 166
www.intechopen.com

InTech China

Unit 405, Office Block, Hotel Equatorial Shanghai
No.65, Yan An Road (West), Shanghai, 200040, China
中国上海市延安西路65号上海国际贵都大饭店办公楼405单元
Phone: +86-21-62489820
Fax: +86-21-62489821

© 2010 The Author(s). Licensee IntechOpen. This chapter is distributed under the terms of the [Creative Commons Attribution-NonCommercial-ShareAlike-3.0 License](#), which permits use, distribution and reproduction for non-commercial purposes, provided the original is properly cited and derivative works building on this content are distributed under the same license.

IntechOpen

IntechOpen