

We are IntechOpen, the world's leading publisher of Open Access books Built by scientists, for scientists

4,800

Open access books available

122,000

International authors and editors

135M

Downloads

Our authors are among the

154

Countries delivered to

TOP 1%

most cited scientists

12.2%

Contributors from top 500 universities



WEB OF SCIENCE™

Selection of our books indexed in the Book Citation Index
in Web of Science™ Core Collection (BKCI)

Interested in publishing with us?
Contact book.department@intechopen.com

Numbers displayed above are based on latest data collected.

For more information visit www.intechopen.com



Indoor Radio Network Optimization

Lajos Nagy

*Department of Broadband Communications and Electromagnetic Theory
Budapest University of Technology and Economics
Hungary*

1. Introduction

The new focus of wireless communication is shifting from voice to multimedia services. User requirements are moving from underlying technology to the simply need reliable and cost effective communication systems that can support anytime, anywhere, any device. The most important trends in global mobile data traffic forecast are:

Globally, mobile data traffic will double every year through 2014, increasing 39 times between 2009 and 2014.,

Almost 66 percent of the world's mobile data traffic will be video by 2014. (Cisco, 2010)

While a significant amount of traffic will migrate from mobile to fixed networks, a much greater amount of traffic will migrate from fixed to mobile networks. In many countries mobile operators are offering mobile broadband services at prices and speeds comparable to fixed broadband. Though there are often data caps on mobile broadband services that are lower than those of fixed broadband, some consumers are opting to forgo their fixed lines in favor of mobile.

There is a growing interest in providing and improving radio coverage for mobile phones, short range radios and WLANs inside buildings. The need of such coverage appears mainly in office buildings, shopping malls, train stations where the subscriber density is very high. The cost of cellular systems and also the one of indoor wireless systems depend highly on the number of base stations required to achieve the desired coverage for a given level of field strength. (Murch 1996)

The other promising technique is the Hybrid Fiber Radio (HFR)-WLAN which is combines the distribution and radio network. The advantages of using analogue optical networks for delivering radio signals from a central location to many remote antenna sites have long been researched and by using the high bandwidth, low loss characteristics of optical fiber, all high frequency and signal processing can be performed centrally and transported over the optical network directly at the carrier frequency. The remote site simplicity makes possible the network cheap and simple, requiring only optoelectronic conversion (laser diodes and photo-detectors), filtering and amplification. Such Remote Units (RU) would also be cheap, small, lightweight, and easy to install with low power consumption.

The design objectives can list in the priority order as RF performance, cost, specific customer requests, ease of installation and ease of maintenance. The first two of them are close related to the optimization procedure introduced and can take into account at the design phase of the radio network.

Source: Communications and Networking, Book edited by: Jun Peng,
ISBN 978-953-307-114-5, pp. 434, September 2010, Sciyo, Croatia, downloaded from SCIYO.COM

There are already numerous optimization methods published which can be applied to the optimal design of such indoor networks (Wu 2007, Adickes 2002, Portilla-Figuera 2009, Pujji 2009). The recently published methods use any heuristic technique for finding the optimal Access Point (AP) or RU positions. Common drawback of the methods are the slow convergence in a complex environment like the indoor one because all of the methods are using the global search space i.e. the places for AP-s are searched globally.

This chapter presents approaches in optimizing the indoor radio coverage using multiple access points for indoor environments. First the conventional Simple Genetic Algorithm (SGA) is introduced and used to determine the optimal access point positions to achieve optimum coverage. Next to overcome the disadvantage of SGA two optimization methods are applied Divided Rectangles (DIRECT) global optimization technique and a new hierarchic optimization method is introduced and comparisons are made for the methods deployed.

The main advantage of the proposed method is the reduction of the search space by using two step procedure starting with simple radio propagation method based AP position estimation and thereafter heuristic search using Motley Keenan radio propagation method with heuristic search.

2. Hybrid fiber radio architecture

Microwave radio-frequency transport over fibre, is an already widely used approach which allows the radio functionality of several Base Stations (BS) to be integrated in a centralised headend unit (Schuh, 1999).

Moreover, it offers fixed and mobile wireless broadband access with a radio-independent fibre access network. Different radio feeder concepts such as Intermediate Frequency (IF) over fibre with electrical frequency conversion at the RAU or direct Radio Frequency (RF) transport are possible.

Few existing Hybrid Fiber Radio interfaces are

DECT - narrowband access for indoor multi-cell cordless telephony, with indoor range from 20 up to 50 metres, and for outdoor Wireless Local Loop (WLL) with a radio range up to a few kilometres.

GSM cellular mobile system provides narrowband access for speech and data services. Typical indoor DCS-1800 cell radius is from about 10 to 50 m and outdoor cell radius for GSM-900/DCS-1800 vary often between 50 to 1000 m.

W-LANs (IEEE 802.11) operate in 80 MHz of spectrum using the 2.4 GHz ISM band, giving indoor access originally designed to high data rates, up to 2 Mbit/s, with coverage areas up to 250 m.

UMTS will operate at ~2 GHz with up to 60 MHz of spectrum. It can provide features like 2nd generation mobile systems but will also offer multimedia services like video telephony, up to 2 Mbit/s for low mobility. Supported cell sizes for indoor applications are up to ~100 metres, and for outdoor applications cell size can be up to a few tens of kilometres (suburban areas), by supporting different mobility features. UMTS will be a public operated system.

One possible application of the HFR network is using analog optical links to transmit modulated RF signals. It serves to transmit the RF signals down- and uplink, i.e. to and from central units (CU) to base stations (BS) called also radio ports. Basic design is shown in Fig. 1, using wavelength duplex fiber star (T1) and fiber bus (T2) topology. This technique is the mostly used one in cellular HFR networks. [1,6]

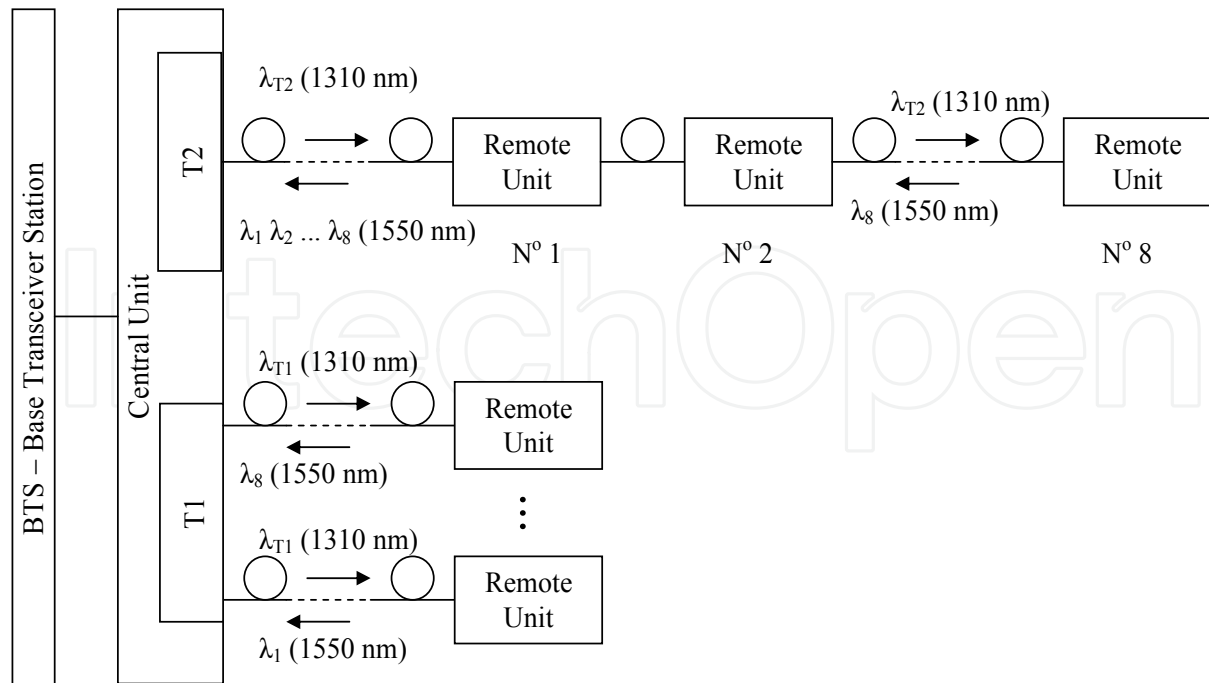

Fig. 1. HFR cellular architecture using one fiber star (T1) and one fiber bus (T2) topology

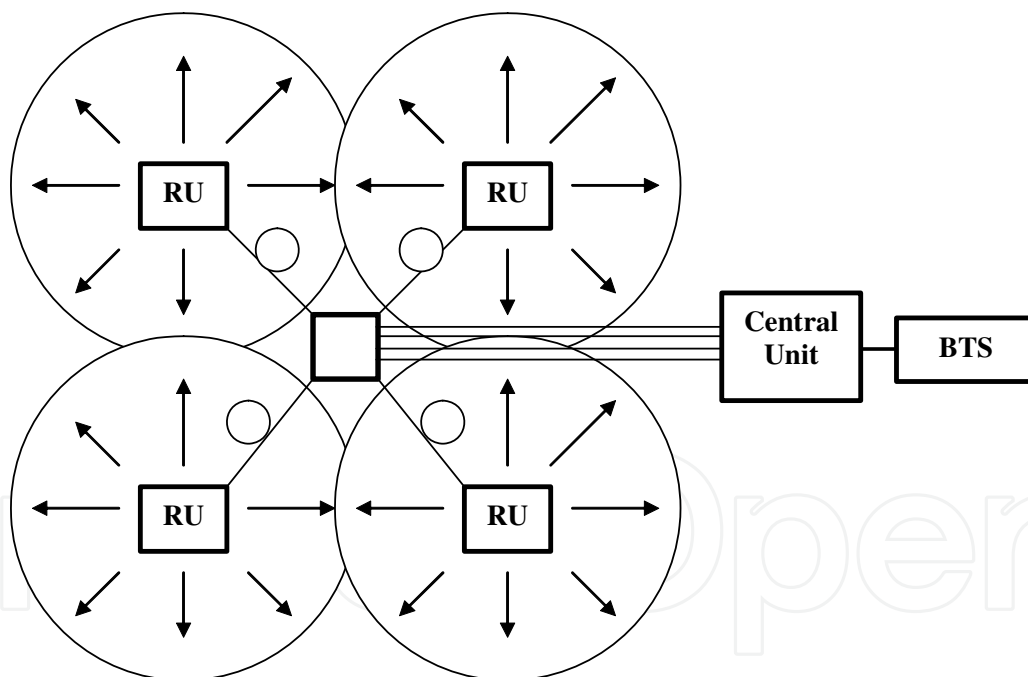

Fig. 2. HFR cellular architecture with Remote Units and Central Units

The other technique uses direct modulation of laser diode and more suitable for WLAN applications. The Fig. 3. shows the combination of IEEE 802.11a and 11.g WLAN services using HFR technology.

The main parts of the HFR network in Fig. 3. are the Local Transceiver Unit with circulator, electro-optical converters and the Remote Unit with electro-optical converters, antennas. The IEEE 802.11a and 11.g WLAN access points are used in unchanged form accessing to the wired internet network.

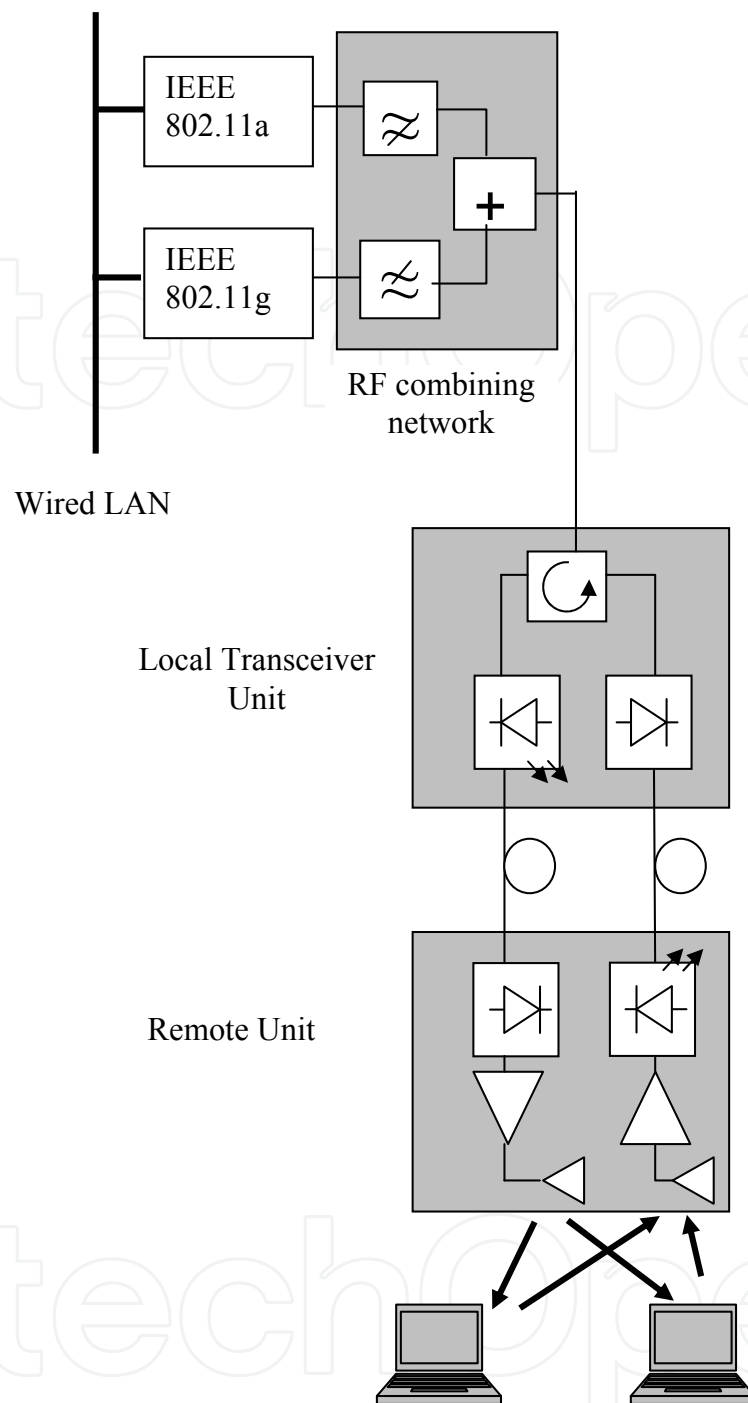

Fig. 3. HFR WLAN architecture

The indoor radio coverage of HFR network is basically determined by the RU positions. There are many factors on choosing these positions such as RF performance, cost, specific customer requests, ease of installation, ease of maintenance, but the optimal radio coverage achievable by a minimum number of the RUs is the most important one.

The next parts introduces the radio propagation modeling used in indoor environment and the optimization method for determining optimum RU positions for best radio coverage which is usually the main aim of the wireless design but the optimization method proposed can be easily amended of further objectives.

3. The indoor radiowave propagation model and the building database

In our article the Motley-Keenan (Keenan & Motley, 1990) model was used to analyze indoor wave propagation. This empirical type prediction model based on considering the influence of walls, ceilings and floors on the propagation through disparate terms in the expression of the path loss.

The overall path loss according to this model can be written as

$$L = L_F + L_a \quad (1)$$

where L_F is the free space path loss and L_a is an additional loss expressed as

$$L_a = L_c + \sum_{i=1}^I k_{wi} L_{wi} + \sum_{j=1}^J k_{ff} L_{ff} \quad (2)$$

where L_c is an empirical constant term, k_{wi} is the number of penetrated i type walls, k_{ff} is the number of penetrated floors and ceilings of type j , I is the number of wall types and J is the number of floor and ceiling types.

For the analyzed receiver position, the numbers k_i and k_j have to be determined through the number of floors and walls along the path between the transmitter and the receiver antennas. In the original paper (Keenan & Motley, 1990) only one type of walls and floors were considered, in order for the model to be more precise a classification of the walls and floors is important. A concrete wall for example could present very varying penetration losses depending on whether it has or not metallic reinforcement.

It is also important to state that the loss expressed in (Eq. 2) is not a physical one, but rather model coefficients, that were optimized from measurement data. Constant L_c is the result of the linear regression algorithm applied on measured wall and floor losses. This constant is a good indicator of the loss, because it includes other effects also, for example the effect of furniture.

For the considered office type building, the values for the regression parameters have been found. (Table 1.)

The Motley-Keenan model regression parameters have been determined using Ray Launching deterministic radiowave propagation model. These calculations were made for the office-type building floor of the Department of Broadband Infocommunication and Electromagnetic Theory at Budapest University of Technology and Economics (Fig. 4.). The frequency was chosen to 2450 MHz with a $\lambda/2$ transmitter dipole antenna mounted on the 3m height ceiling at the center of the floor.

The receiver antenna has been applied to evaluate the signal strength at $(80 \times 5) \times (22 \times 5) = 44000$ different locations in the plane of the receiver. At each location the received signal strength was obtained by RL method using ray emission in a resolution of 1° . A ray is followed until a number of 8 reflections are reached and the receiver resolution in pixels has an area of $0.2 \times 0.2 \text{ m}^2$. The receiver plane was chosen at the height of 1.2 m.

The wall construction is shown on Fig. 4. made of primarily brick and concrete with concrete ceiling and floor, the doors are made of wood. The coefficients of the model have been optimized on the data gathered by the RL simulation session described above.

The floor view and polygonal partitioning is shown on Fig. 5., which is based on the concept described next.

Wall type	Nr. of Layers	Layer widths	Regression parameter [dB]
Brick	1	Brick - 6 cm	4.0
Brick	1	Brick - 10 cm	5.58
Brick	1	Brick - 12 cm	6.69
Brick+ Concrete	3	Brick - 6 cm Concrete - 20 cm Brick - 6 cm	11.8
Brick+ Concrete	3	Brick - 10 cm Concrete - 12 cm Brick - 10 cm	14.8
Brick+ Concrete	3	Brick - 6 cm Concrete - 10 cm Brick - 6 cm	9.3
Brick	1	Brick - 15 cm	8.47
Concrete	1	Concrete - 15 cm	6.56
Concrete	1	Concrete - 20 cm	8
Concrete	3	Concrete - 15 cm Air - 2 cm Concrete - 15 cm	12.47
Glass	3	Glass - 3 mm Air - 10 cm Glass - 3 mm	0
Plasterboard	1	Plasterboard - 5 cm	4.5
Wood	1	Wood - 6 cm	0.92
Wood	1	Wood - 10 cm	0.17

Table 1. The regression parameters

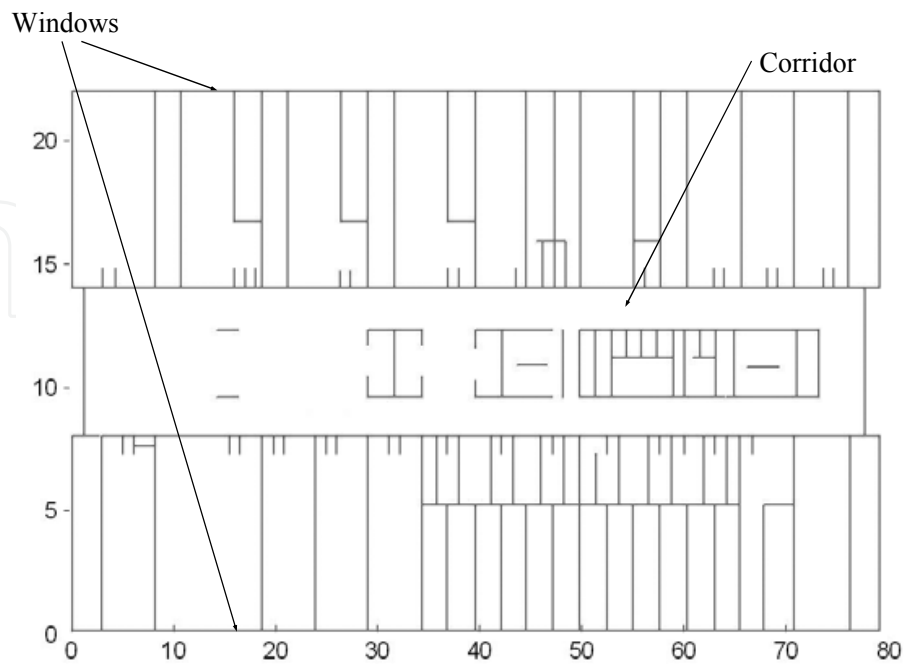

Fig. 4. The building database



Fig. 5. Floor view and polygon data base of V2 building at BUTE

The geometrical description of the indoor scenario is based on the same concept that the walls has to be partitioned to surrounding closed polygons and every such polygons are characterized by its electric material parameters.

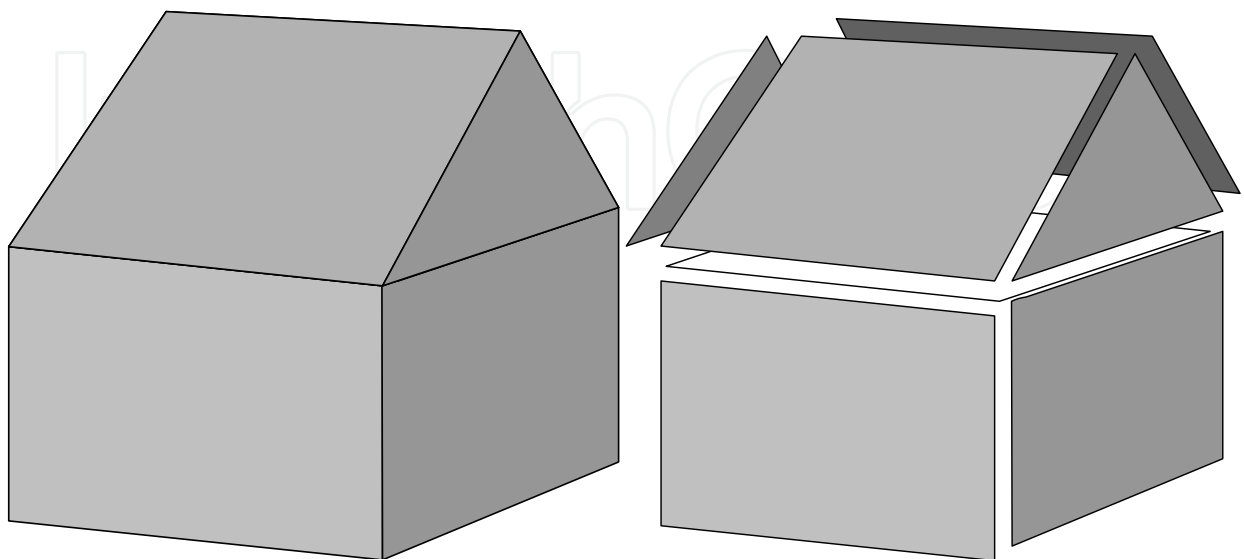

Fig. 6. Polygon representation of building structure

The data base for the ray tracing method in our applications can not contain cut-out surfaces directly, such as windows, doors. Therefore the cut-out surface description is based on surface partitioning of the geometry as can be seen in Fig. 7.

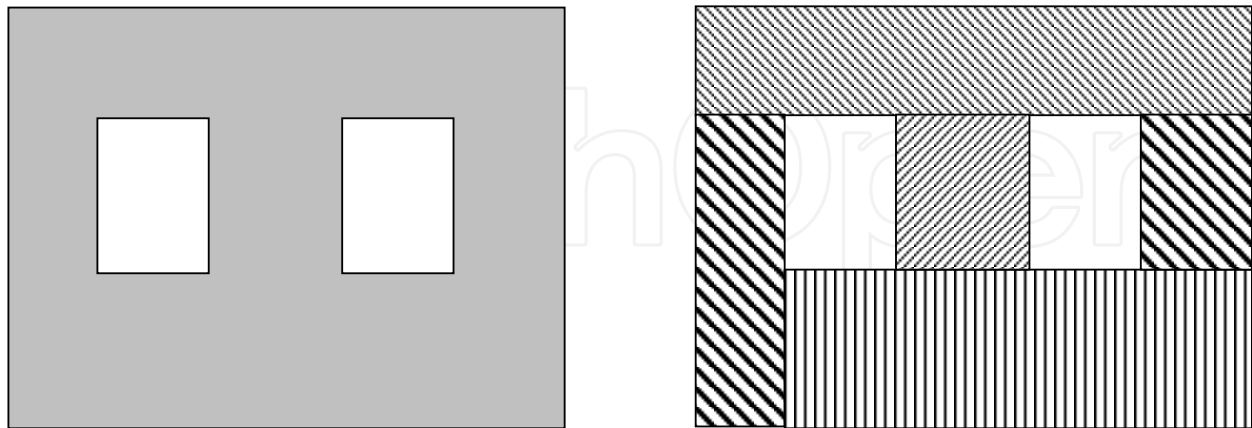

Fig. 7. A possible polygonal partitioning of windowed walls for ray tracing method

4. Optimization methods

There are already numerous optimization methods published which can be applied to the optimal design of such Hybrid Fiber Radio indoor networks (Wu 2007, Adickes 2002, Portilla-Figueras 2009, Pujji 2009). The recently published methods use any heuristic technique for finding the optimal Access Point (AP) or RU positions. Common drawback of the methods are the slow convergence in a complex environment like the indoor one because all of the methods are using the global search space i.e. the places for AP-s are searched globally.

Heuristic search and optimization is an approach for solving complex and large problems that overcomes many shortcomings of traditional (gradient type) optimization techniques. Heuristic optimization techniques are general purpose methods that are very flexible and can be applied to many types of objective functions and constraints. Another advantage of heuristic methods is their simplicity because of its gradient-free nature. Gradient free optimization methods are primarily based on the objective function values and are suitable for problems either with many parameters or with computationally expensive objective functions.

In the paper two global optimization methods the Simple Genetic Algorithm (SGA) and a method using Divided Rectangles (DIRECT) global search algorithm are used with wave propagation solver as can be seen in Fig. 8.

4.1 Optimization method through Simple Genetic Algorithms (SGA)

Genetic Algorithms (GA) are increasingly being applied to complex problems. Genetic Algorithm optimizers are robust, stochastic search methods modeled on the principles and concepts of natural selection. (Nagy 2000, Farkas 2001, Michielssen 1999, Michalewicz 1996) Genetic Algorithms (GA) are increasingly being applied to difficult optimization problems. GA optimizers are robust, stochastic search methods modeled on the principles and concepts of natural selection.

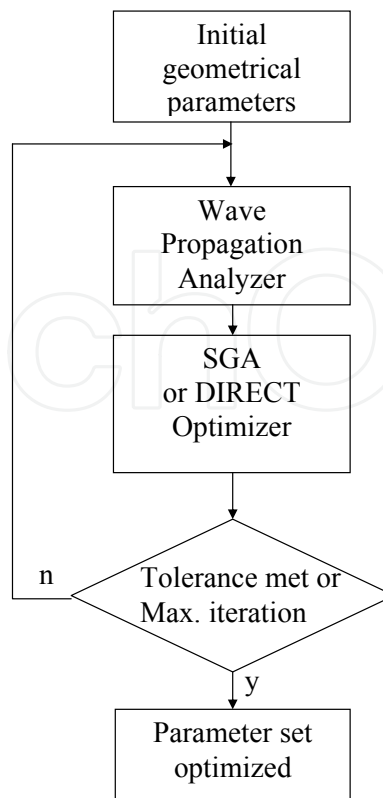

Fig. 8. Diagram of Wave Propagation analyzer and optimizer

If a receiver position that is fully described by N_{par} parameters arranged in a vector $x = \{x_i | i=1, \dots, N_{par}\}$ is considered, then the knowledge of x permits the evaluation of the objective function $f(x)$, which indicates the worth of a design (the area coverage percentage). It is assumed that x_i take on either real or discrete values, and that $f(x)$ needs to be maximized.

The GA does not operate on x but on a discrete representation or chromosome $p = \{g_i | i=1, \dots, N\}$ of x , each parameter x_i being described by a gene g_i . Each gene g_i in turn consists of a set of N_{all}^i all that are selected from a finite alphabet and that together decode a unique x_i .

The GA does not limit themselves to the iterative refinement of a single coded design candidate; instead the simple GA (SGA) simultaneously acts upon a set of candidates or population

$$\bar{p} = \{p(i) | i = 1, \dots, N_{pop}\} \quad (3)$$

where N_{pop} is the population size.

Starting from an initial population \bar{p}^0 , the SGA iteratively constructs populations $\bar{p}^k, k=1..N_{gen}$, with N_{gen} denoting the total number of SGA generations. Subsequent generations are constructed by iteratively acting upon \bar{p}^0 with a set of genetic operators. The operators that induce the transition $\bar{p}^k \rightarrow \bar{p}^{k+1}$ are guided solely by knowledge of the vector of objective function values

$$f^k = \left\{ f(x(p^k(i))) \middle| i = 1..N_{pop} \right\} \quad (4)$$

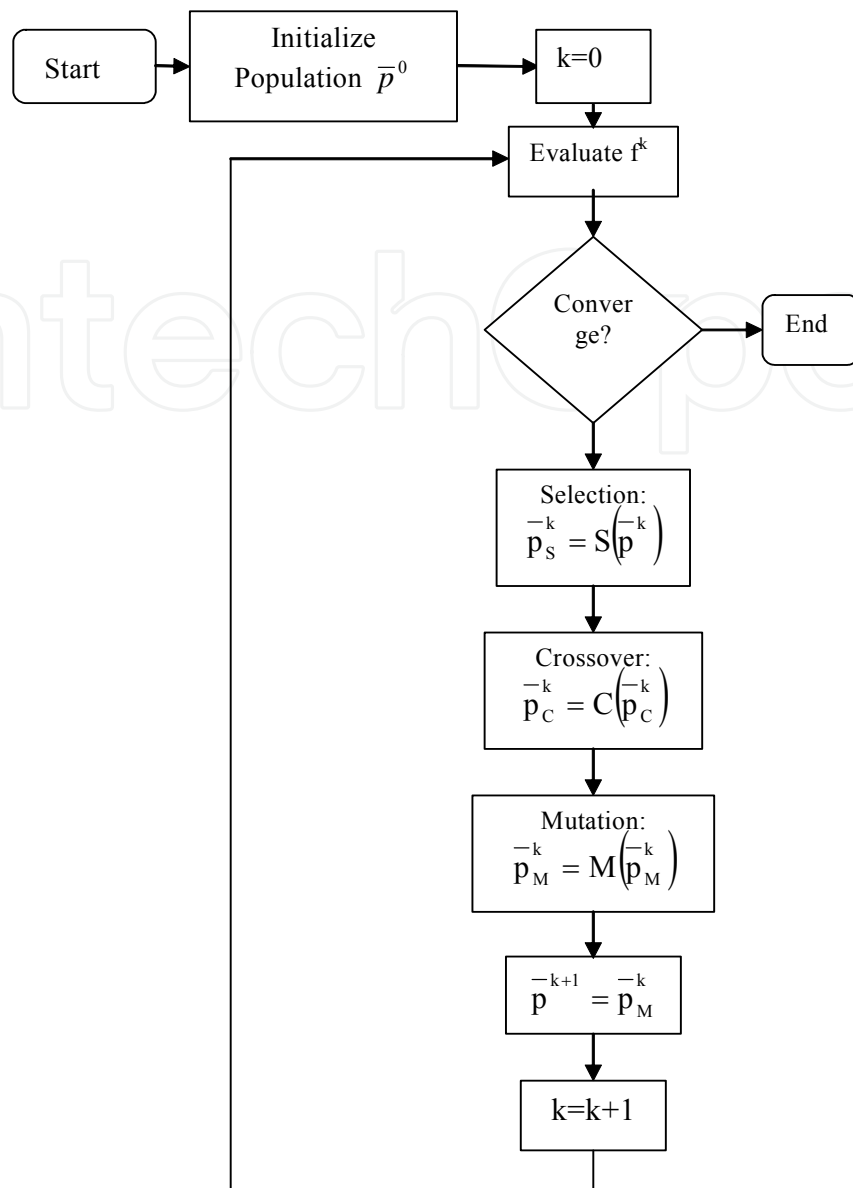

Fig. 9. The flowchart of a simple GA

and induce changes in the genetic makeup of the population leading to a \bar{p}^{k+1} comprising individuals that are, on average better adapted to their environment than those in \bar{p}^k , i.e., they are characterized by higher objective function values.

This change is effected by three operators mentioned in the introduction: selection (S), crossover (C), and mutation (M).

The selection operator implements the principle of survival of the fittest. Acting on \bar{p}^k , S produces a new population $\bar{p}_S^k = S(\bar{p}^k)$ again of size N_{pop} that is, on average, populated by the better-fit individuals present in \bar{p}^k . Among the many existing schemes tournament selection has been chosen. The crossover operator mimics natural procreation. Specifically, C acts upon the population \bar{p}_S^k by mating its members, thereby creating a new population

$$\bar{p}_C^k = \bigcup_{i=1}^{N_{pop}/2} C\left(ch\left(\bar{p}_S^k\right), ch\left(\bar{p}_S^k\right)\right) \quad (5)$$

where the chromosome crossover operator C selects a random crossover allele $\alpha_{N_{cross}}$ between the two chromosomes to be crossed upon which it acts with probability P_{cross} . The mutation operator generates a new population of size by introducing small random changes into \bar{p}_C^k . The action of M can be represented in operator form as

$$\bar{p}_M^k = \bigcup_{i=1}^{N_{pop}} M\left(\bar{p}_C^k(i)\right) \quad (6)$$

The cost function of the optimization procedure has been the coverage percentage of the points for which the received power is greater than a given level.

$$c(P_{rec}) = \frac{\text{Number of points } (P_{thresh.} < P_{rec})}{\text{Total number of test points}} \quad (7)$$

The number of test points to evaluate the cost function above was 12000 on the floor level, and the P_{thresh} level was -70 dBm, respectively.

4.2 DIRECT algorithm

The DIRECT optimization algorithm is a derivative-free global algorithm that yields a deterministic and unique solution (Daniel E. Finkel, 2003). Its attribute of possessing both local and global properties make it ideal for fast convergence. An essential aspect of the DIRECT algorithm is the subdivision of the entire design space into hyper-rectangles or hyper-cubes for multidimensional problems.

The iteration starts by choosing the center of the design space as the starting point. Subsequently, at each iteration step, DIRECT selects and subdivides the set of hyper-cubes that are most likely to produce the lowest objective function. This estimation is based on Lipschitzian optimization method. Basically for one dimension a function is called Lipschitz continuous on domain R with Lipschitz constant α if

$$|f(x_1) - f(x_2)| \leq \alpha |x_1 - x_2| \quad x_1, x_2 \in R \quad (8)$$

where

$f(x)$ is the objective function for the optimization problem.

The complementary of the coverage percentage which has to be minimized was chosen as objective function for the DIRECT algorithm.

$$f(x) = 1 - c(P_{rec}) \quad (9)$$

The Lipschitzian function finds the global minimum point provided the constant α is specified to be greater than the largest rate of change of the objective function within the design space and that the objective function value is continuous. Within DIRECT, all possible values of the Lipschitzian constant α are used with the larger values of α chosen for global optimization (to find the basin of convergence of the optimum) followed by smaller values of α for local optimizations within this basin of convergence. As mentioned above, DIRECT divides the domain into multiple rectangles at each iteration. Thus, the convergence process is greatly sped up and the optimization algorithm achieves both local and global searching properties.

As illustration of subdividing the search region into hyper-rectangles and sampling, two dimensional problem optimization steps are shown in Fig. 10.

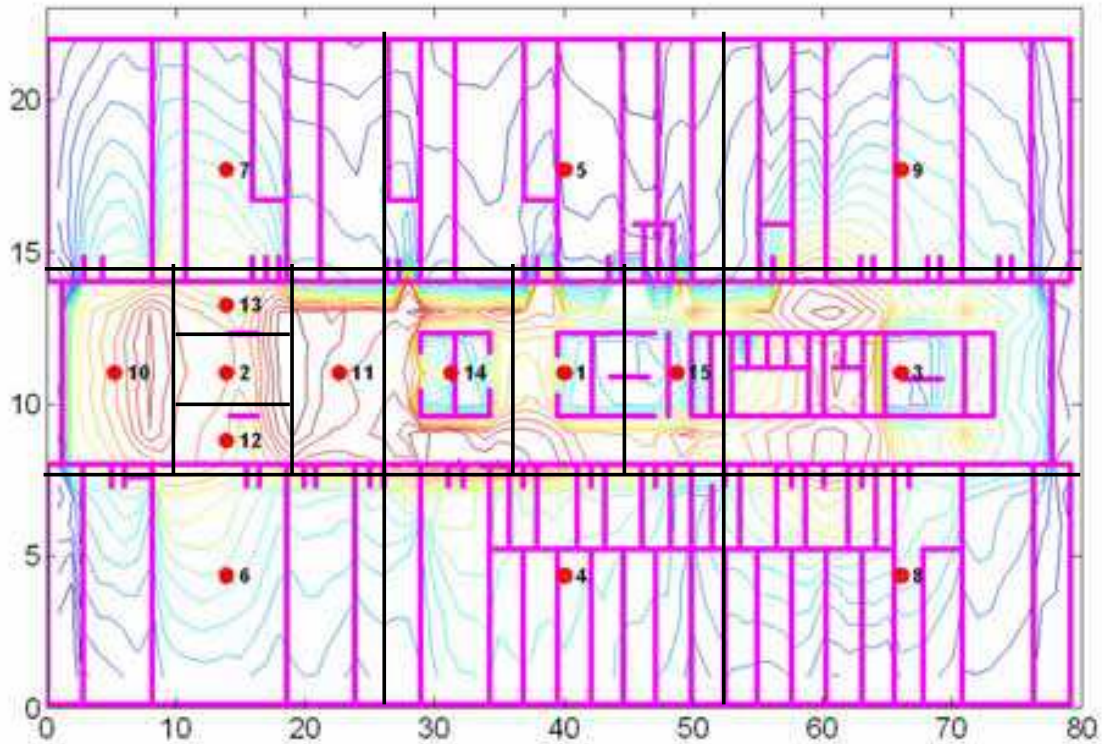

Fig. 10. DIRECT global optimizer search steps

The Algorithm DIRECT is stated as follows.

Algorithm DIRECT

Start point at the center of the user defined area ($0 \leq x \leq 80; 0 \leq y \leq 22$)

while $f_{\text{objective}} > f_{\text{limit}}$ **and** $\text{iteration steps} < \text{iteration steps}_{\text{limit}}$

 Divide the area of investigation space into three rectangles

 Set the centers of the three rectangles

 Use the Lipschitz constant α to select the rectangle has to be divided

end while

4.3 Hierarchic two level optimization method

The new proposed hierarchic optimization method uses a two level optimization procedure, in which the radio wave propagation models differ. The propagation models are:

indoor power law,

Motley-Keenan, (Motley & Keenan 1990)

The optimization procedure is based on simple GA and starts with simple power law model. At the point of non changing cost function the procedure switches to the more sophisticated model to Motley-Keenan model. In line with model change the mutation and crossover probabilities are decreased also.

A single approach of ITU-R model is used (ITU, 1238), except that the propagation exponent is accounted for explicitly by changing the path loss exponent. The model is assumed to produce the following total path loss model (in decibels)

$$L = 20 \log(f_c^{[MHz]}) + 30 \log(r^{[m]}) - 28 \quad (10)$$

where r is the distance between transmitter and receiver antennas.

The indoor power law model takes only account the distance to predict the received power therefore the first level of optimization procedure ends a coverage picture as can be seen on Fig. 11. for five AP-s. In this way the expensive propagation model take place only at refinement of the AP positions.

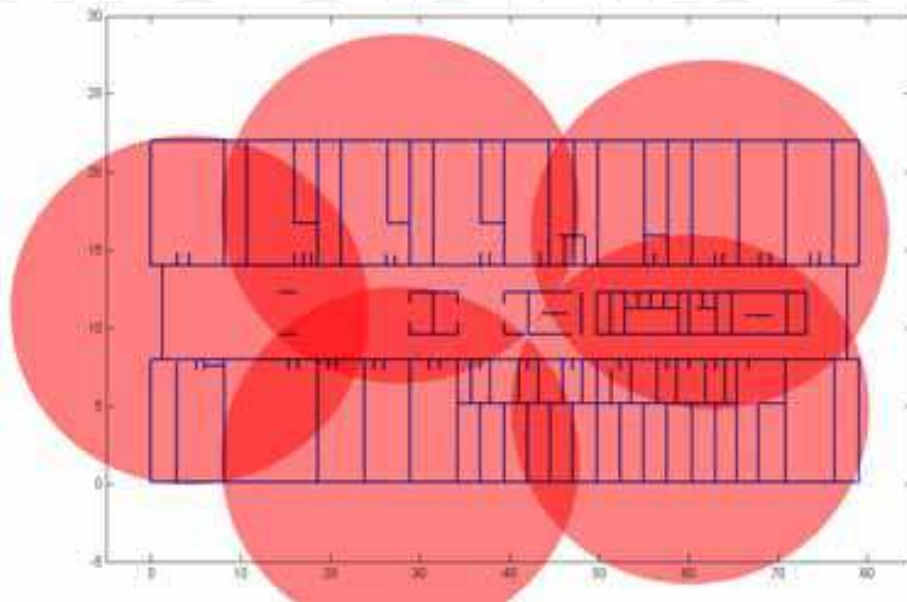

Fig. 11. Access Points positions after the first level optimization

The second optimization step assigns the AP regions based on the previous AP positions, as can be seen on Fig. 12.

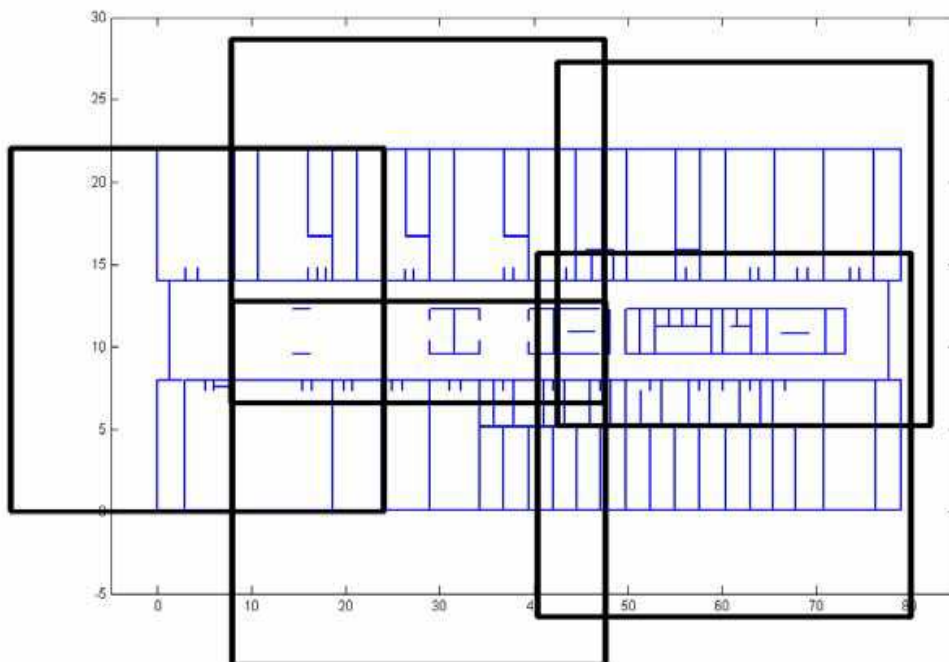

Fig. 12. AP regions for second level optimization

The second optimization step uses the Motley-Keenan model, which regression parameters have been determined using Ray Launching deterministic radiowave propagation model. The most important innovation of the two steps method is the decrease the search area in the first search period using a homogeneous wave propagation model and to get quick results on candidate areas for access points for the second phase of search which is using genetic algorithm as well.

5. Results

The testing of the SGA optimization has been done with two testing cases at the office building in which first optimizing the coverage for part of the floor area and secondly for the whole level.

The results are shown for population size of 14, crossover probability - 0.12, mutation probability - 0.01, simple roulette wheel selection and simple elitist strategy.

The first scenario is an optimization on AP positions (circles in Fig. 13.) of the half part of the floor. The Fig. 13 shows the original 4 AP positions which were chosen to best coverage in laboratories and the corridor coverage was not an aim. The Fig. 14. shows the optimal AP positions using the cost function of (Eq. 7). The simulated distribution of received power for the two geometries is shown in Fig. 15-16. with the measured results.

To make the measurements we have chosen WLAN APs and the power levels were measured using laptops with external wireless adapter moved on the area of investigation. 90 sampling points in distances of 1 m were chosen on the level and the comparison of Fig. 15. and 16. show a good agreement for the received power distribution.

The most important change in the distributions of optimized and not optimized cases is increased number of points with proper coverage. (Table 2.)

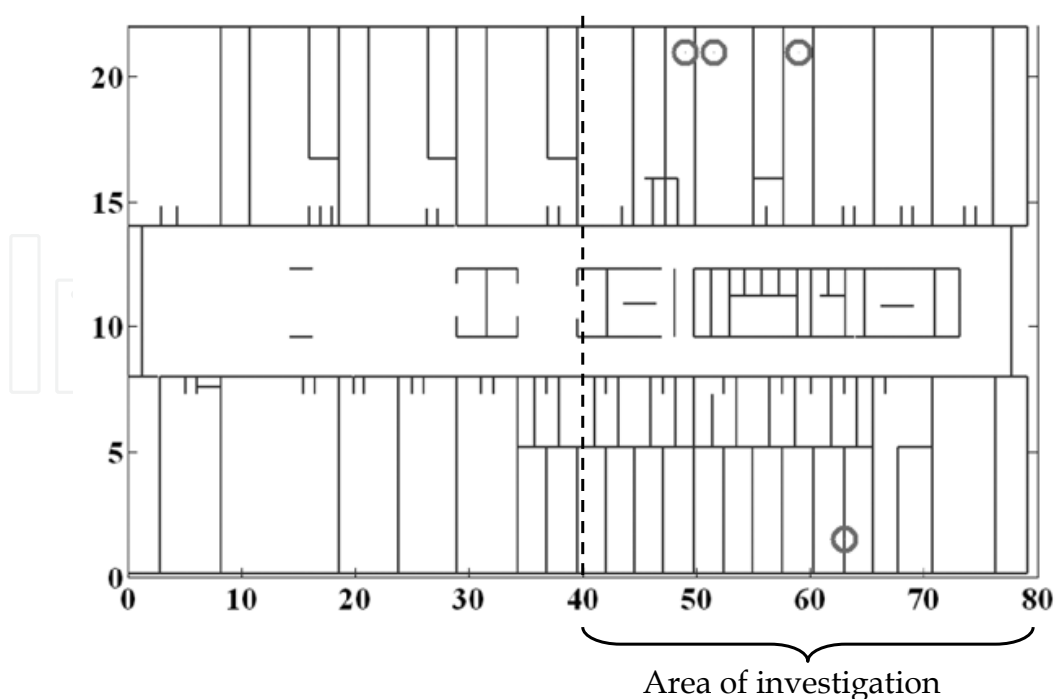

Fig. 13. Original (not optimized) AP positions

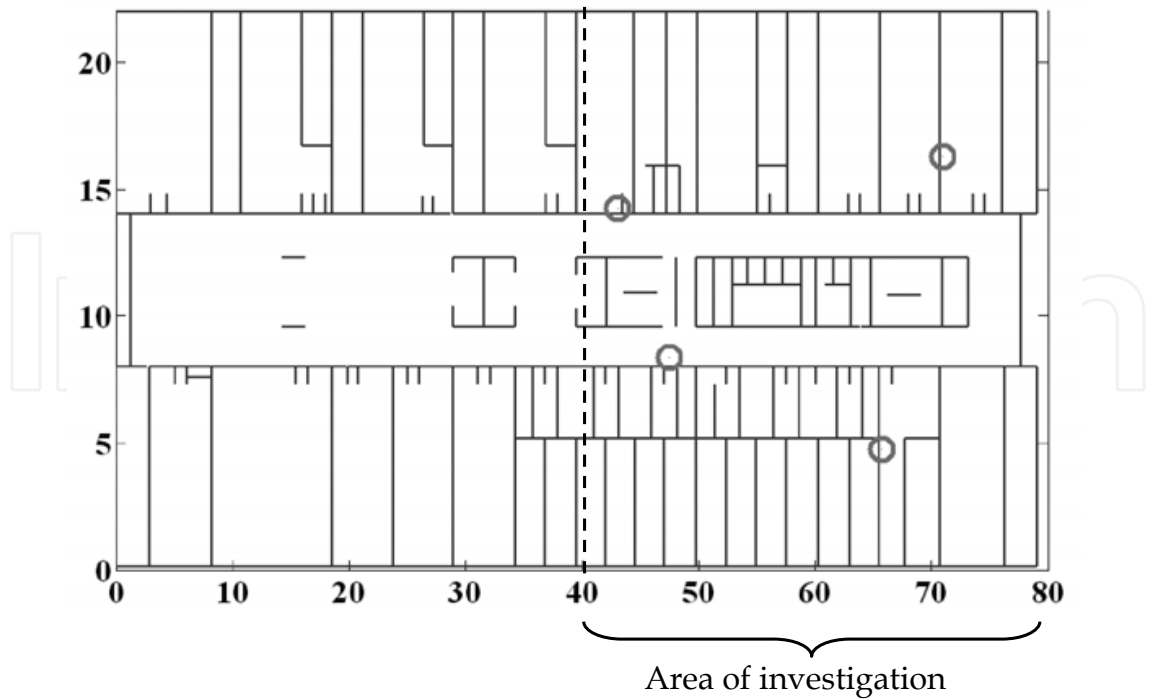

Fig. 14. Optimized AP positions

Configuration	Not optimized	Optimized
Coverage for $P_{rec} > -60\text{dBm}$ (simulation)	40%	75%
Coverage for $P_{rec} > -60\text{dBm}$ (measurement)	50%	80%

Table 2. Area Coverage for Optimized and not Optimized Case

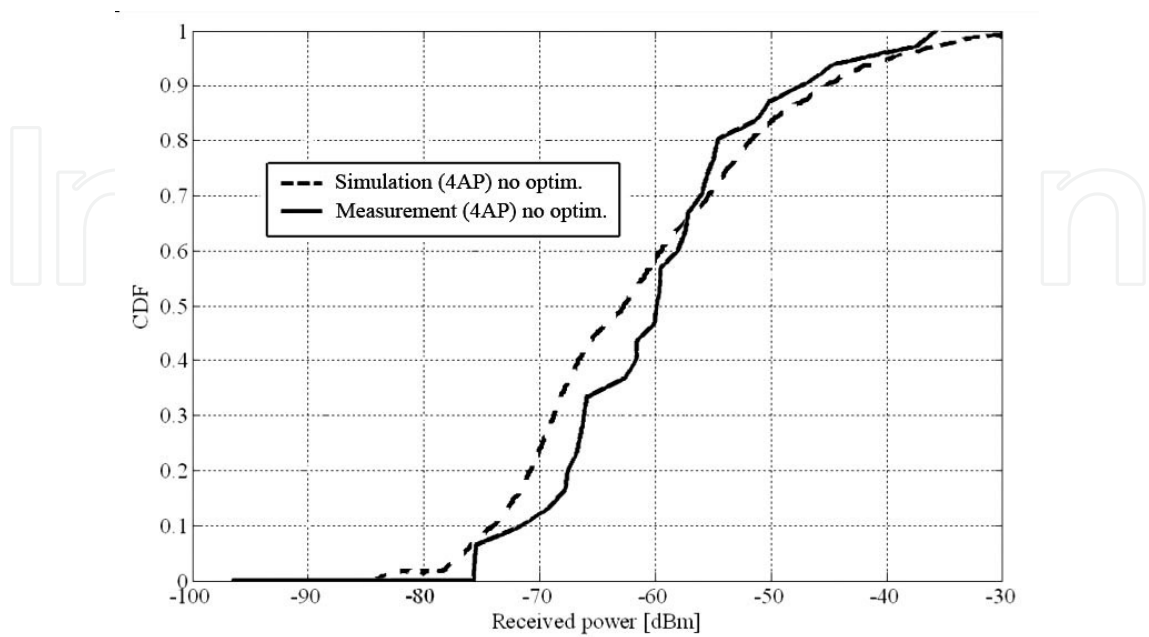

Fig. 15. Cumulative Density Function of received power level (not optimized)

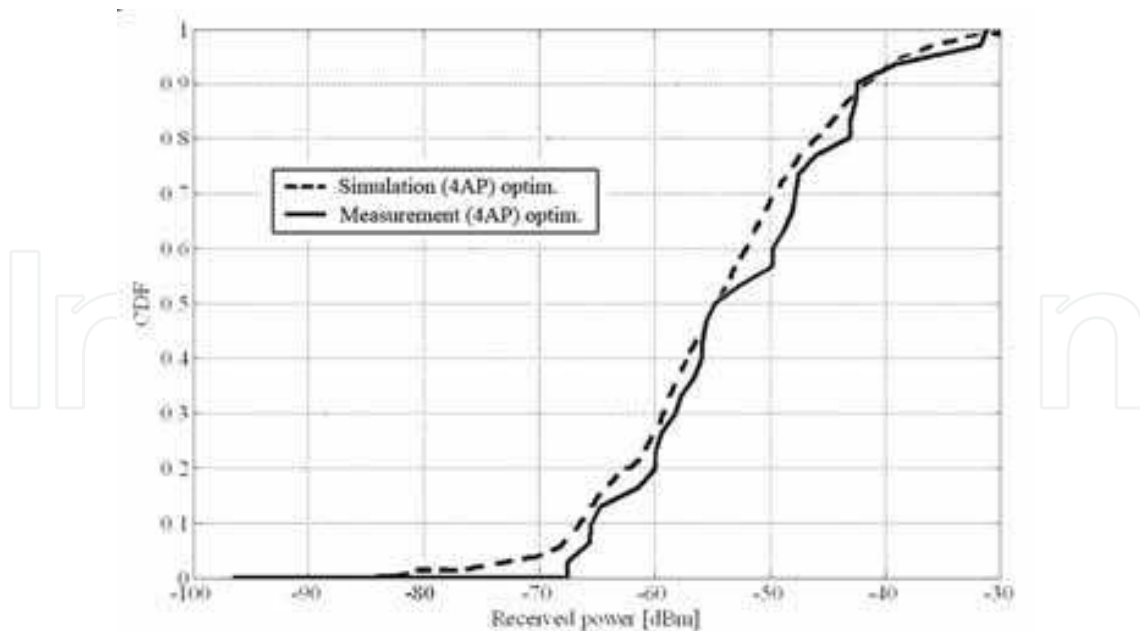

Fig. 16. Cumulative Density Function of received power level (optimized)

The convergence of the Genetic Algorithm can be improved by adjusting the crossover and mutation probability. The Fig. 17. shows the convergence dependence on these parameters for the same generation size.

The Fig. 17. shows a significant dependence of convergence on GA parameters and this results in a 1 to 10 running time ratio. The iteration step means that the number of necessary objective function evaluation can be calculated by multiplying with the population size.

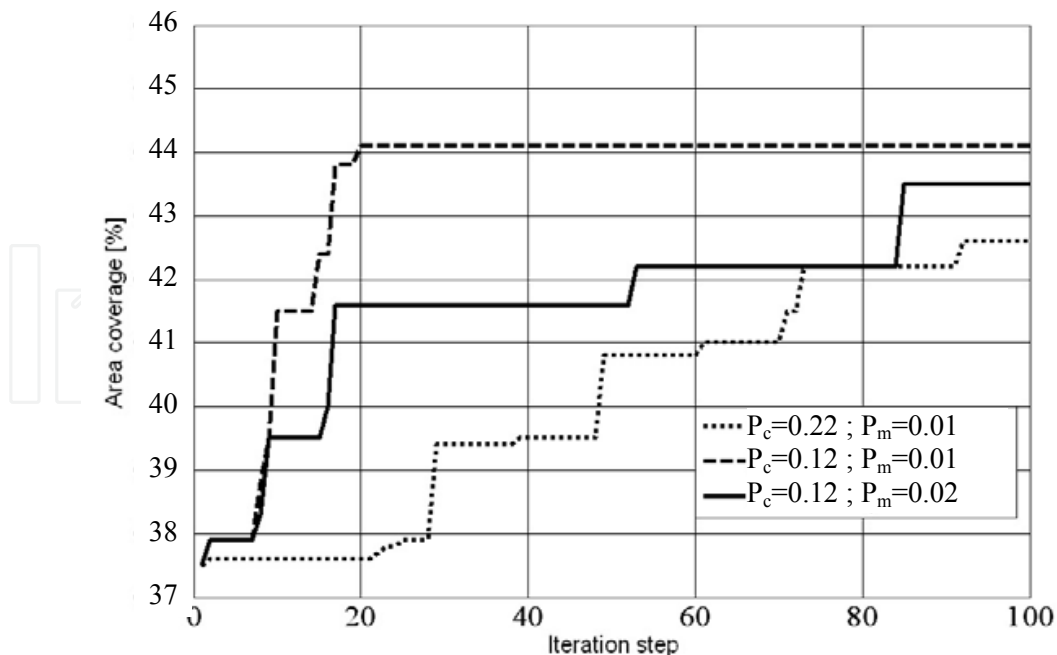

Fig. 17. Genetic Algorithm convergence

The second simulation is on the entire floor level and the aim of the simulation is to compare the necessary number of APs for the same area coverage.

The Fig. 18. shows plausible positions of APs and the Fig. 19. the optimized ones.

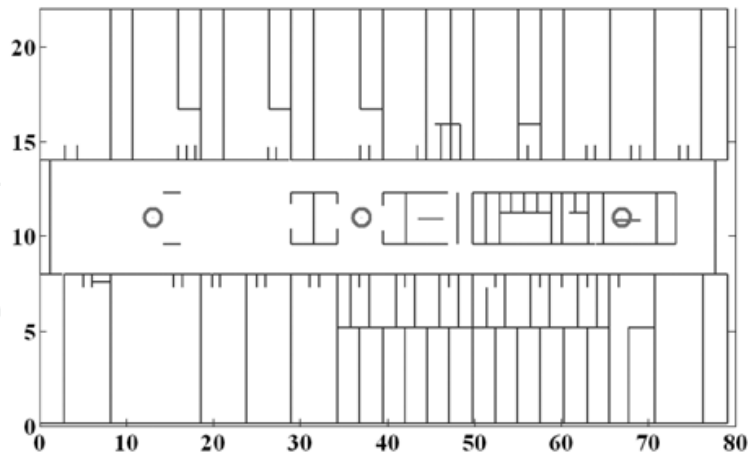

Fig. 18. Plausible AP positions

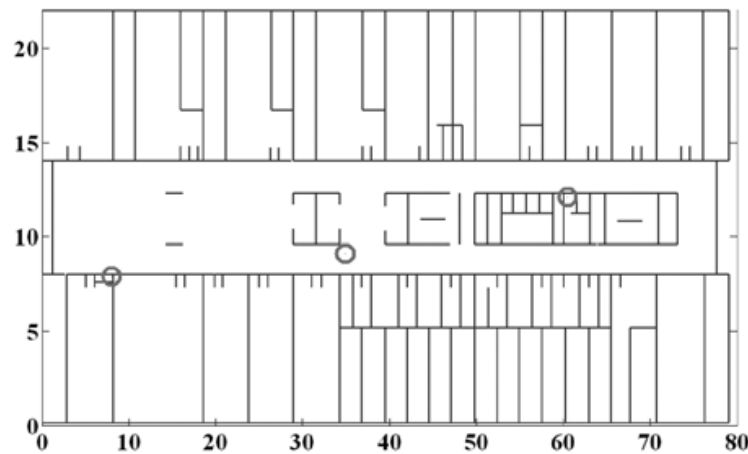

Fig. 19. Optimized AP positions

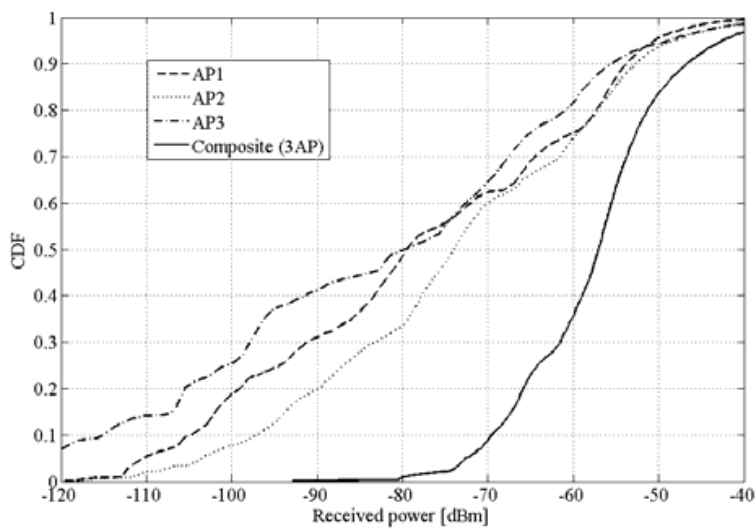

Fig. 20. Independent and composite CDF (optimized AP positions)

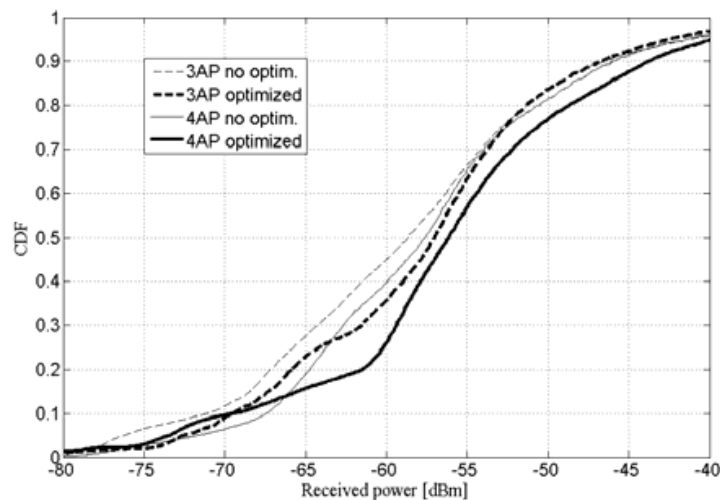

Fig. 21. Optimized and not optimized CDF using 3 and 4 APs

The Fig. 21. and Table 3 summarizes the importance of RU position of HFR. With the proper choice of the placement the optimized 3 AP network configuration results nearly the same coverage as the configuration 6 AP with APs installed in plausible positions.

Configuration	3AP	4AP	6AP
Coverage (not optimized)	55%	60%	66%
Coverage (optimized)	65%	75%	87%

Table 3. Area coverage for optimized and not optimized cases

These results (Table 3.) illustrate and justify well the importance of Remote Unit or Access Point installation positions in HFR networks in order to maximize the wireless coverage. Using the mentioned optimization procedure the network cost can be significantly reduced and the optical distribution network also can be simplified.

As we have shown the SGA is a powerful global optimization tool to improve the indoor coverage for HFR and other mobile radio systems. The main drawback of the method is the ambiguous convergence and therefore its application needs experience of the user. The DIRECT global optimization algorithm is a derivative-free global algorithm that yields a deterministic and unique solution. In the next simulation results will be shown using DIRECT for the same indoor AP position optimization problem. We are comparing DIRECT to SGA and the main point of comparison is the number of evaluation of objective function.

It is worth to investigate the candidate points for the AP position by the DIRECT algorithm. The simplest case is analyzed for one AP network and the investigated and best candidate points are shown in accordance with the objective function the area of coverage % in Fig. 24. The objective function was only evaluated 1 by 1 m resolution. It is well appreciable the testing of the attractive AP positions with high area coverage property.

Next the convergence of SGA and DIRECT will be compared in Fig. 25, 26 and 27. It can be point out that the DIRECT algorithm behaves well for 1 or 2 AP optimization problems (i.e. for 2 and 4 dimensional optimizations) but the convergence rate achieve is far below the SGA for 3 AP problem. Similar behavior can be experienced for higher dimensional optimization problems. Based on this investigations DIRECT algorithm can be proposed for

low dimensional cases till 4 dimensions but the theoretically guaranteed fast and unique solution of global problem has to analyzed further.

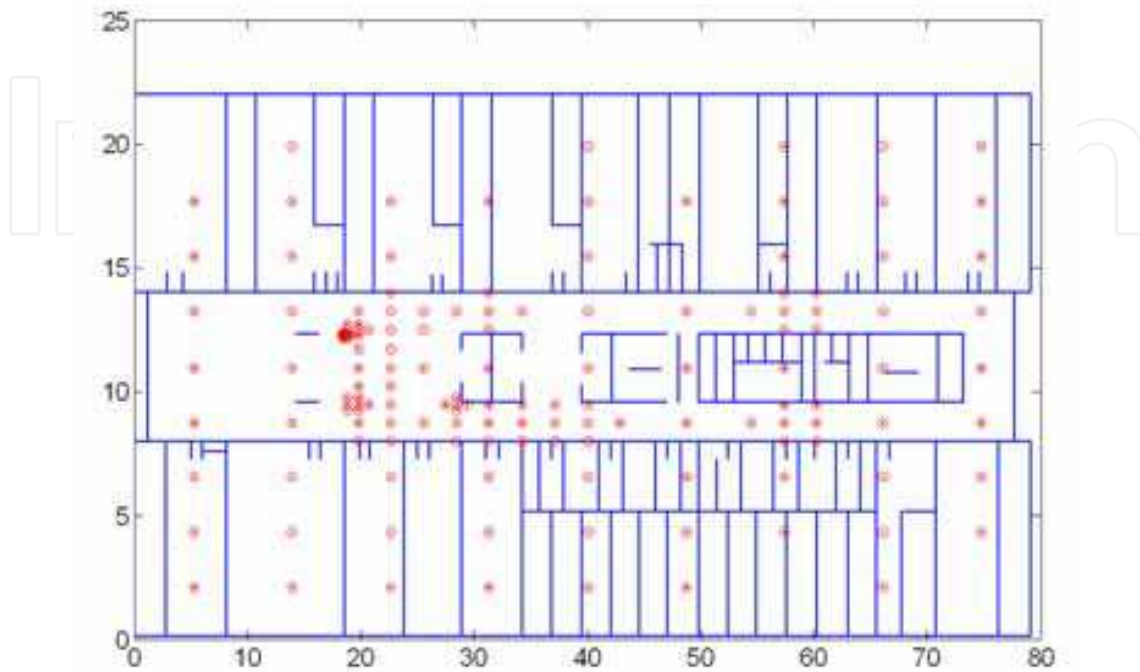

Fig. 22. Candidate points for AP position (after 12, 24, 36...iterations, DIRECT)

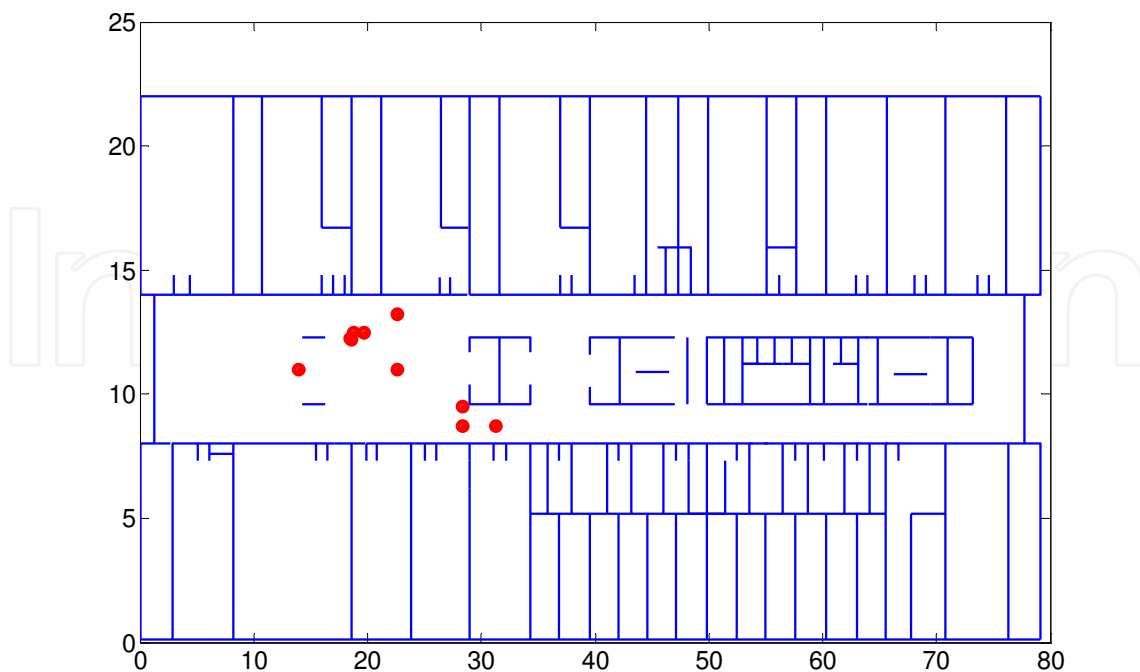

Fig. 23. Best candidate point for AP position (after 12, 24, 36...iterations, DIRECT)

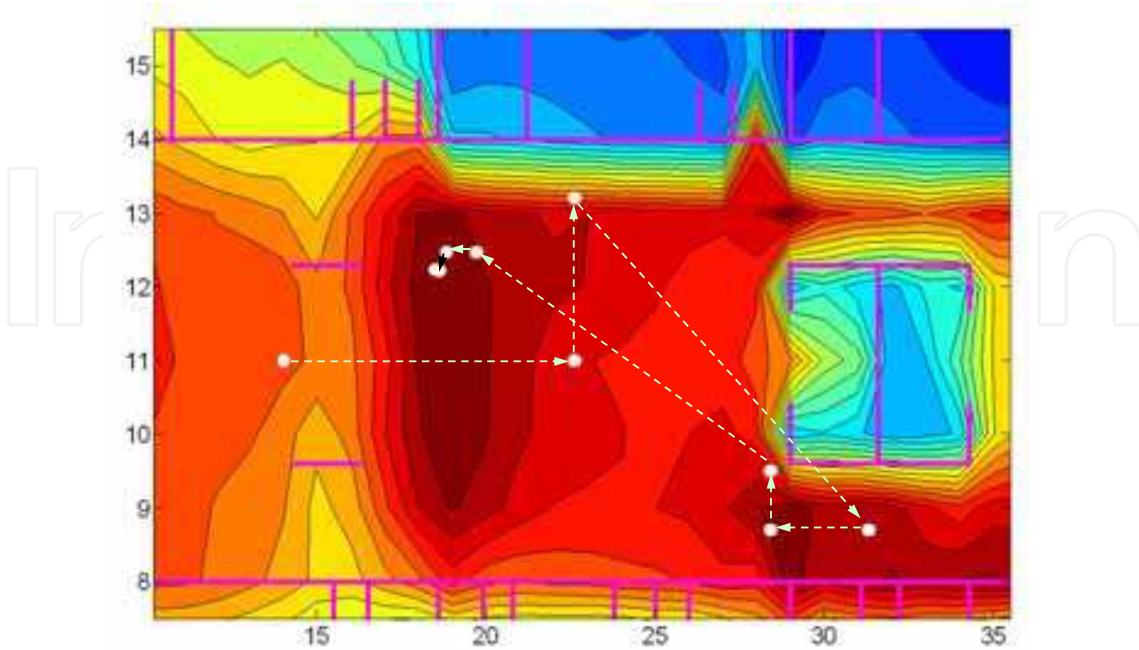

Fig. 24. Best candidate points for AP position (Area of coverage % is also shown)

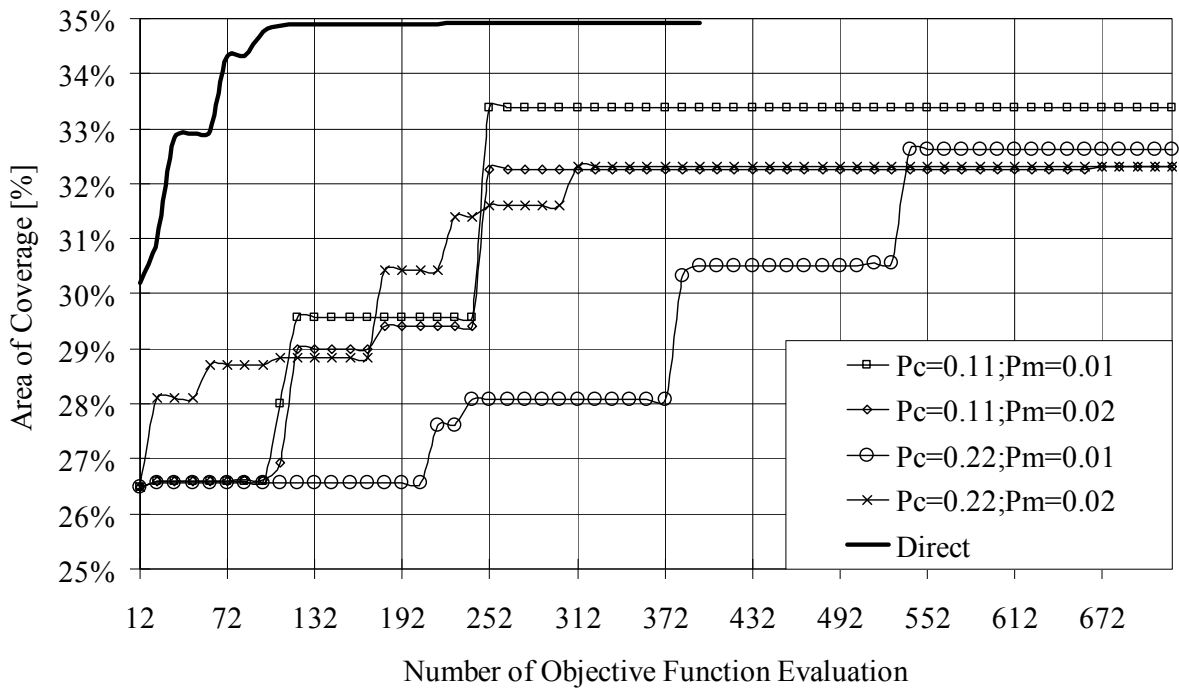

Fig. 25. Convergence of SGA and DIRECT for 1 Access Point

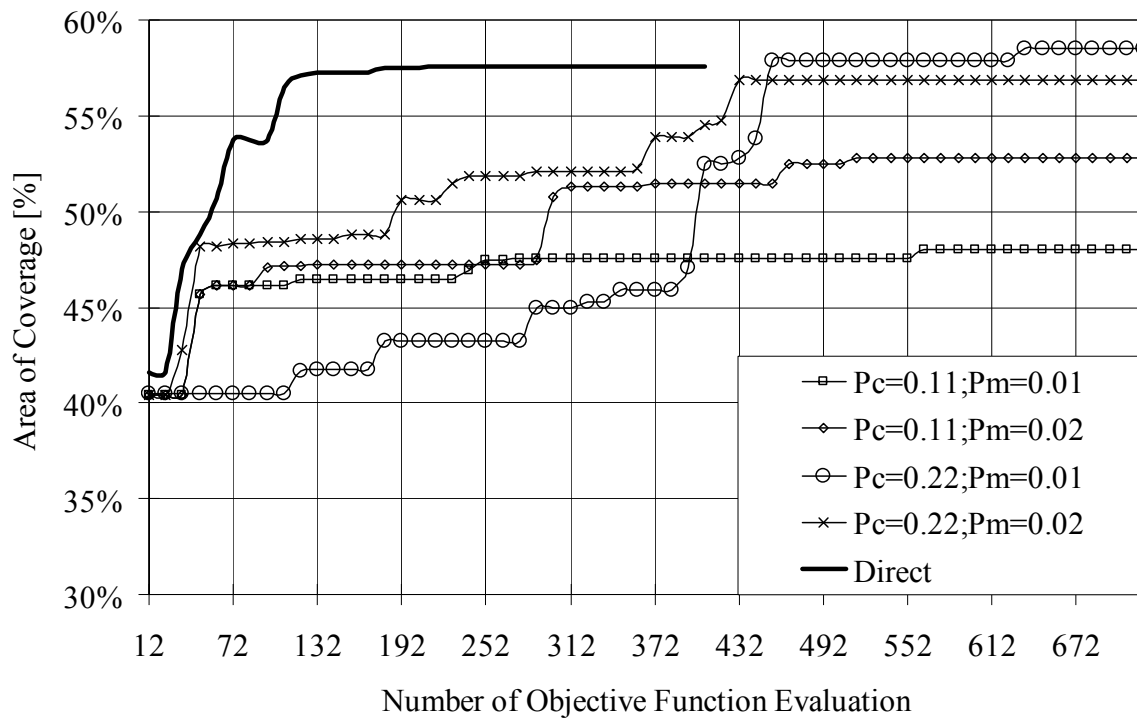

Fig. 26. Convergence of SGA and DIRECT for 2 Access Points

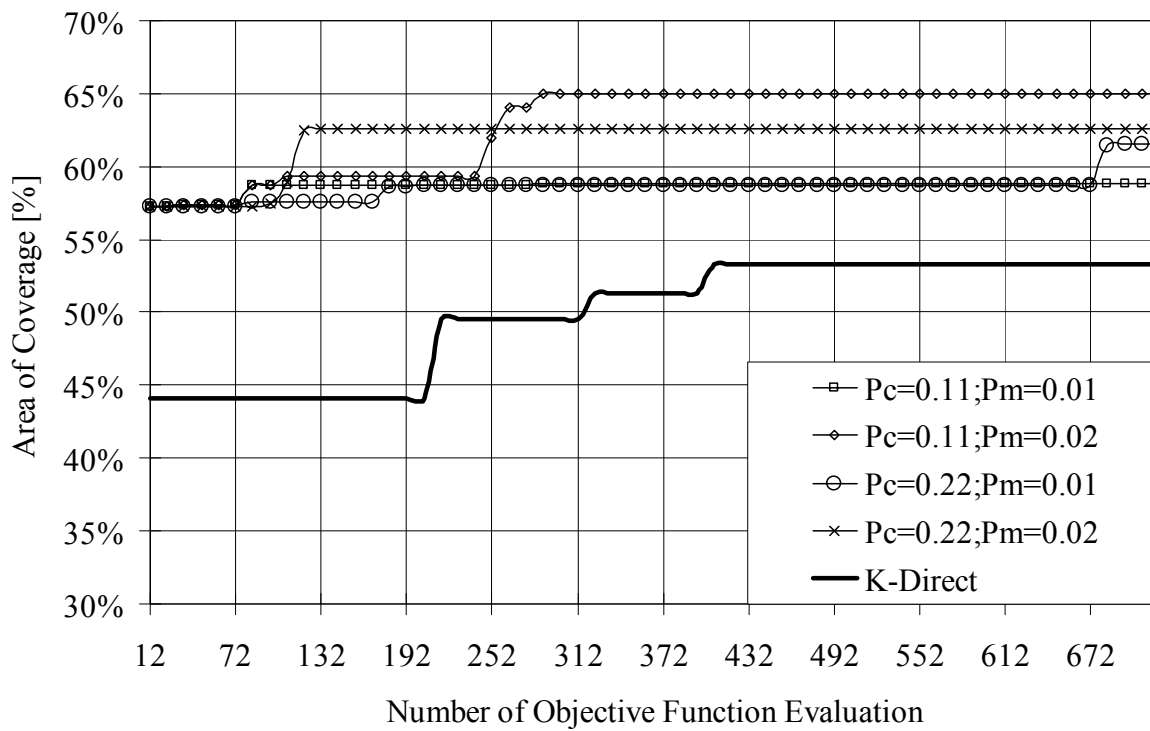

Fig. 27. Convergence of SGA and DIRECT for 3 Access Points

The next part shows the comparisons of SGA and the proposed hierarchic two steps optimization method, first the convergence of the simple Genetic Algorithm for different population sizes (Fig. 28.). Now we investigate 6 AP optimization cases in order to validate the two step method. As we have seen problems of dimensions above 4 can not be analyzed with DIRECT and therefore for comparison this 12 dimensional problem will be investigated. First the GA optimization is shown after performing the AP search by using power law path loss model i.e. the hierarchic approach. Finally the optimization results are analyzed.

Fig. 28 presents effect of values population size, crossover (C) and mutation (M) probability on convergence for 6 APs placement single GA optimization in our simulations.

The population size extension effect a better convergence (Figure 28) but the calculation time increase polynomial.

The most important observations are that the crossover and mutation probabilities have optimal values in this case for the geometry investigated these values are $P_c=0.22$ and $P_m=0.01$. (Fig. 28-29)

Next the proposed hierarchic optimization model is shown after performing the AP search by using power law path loss model. The limitation of the optimization areas for the AP positions results in much better convergence for each configuration (Fig. 30-31).

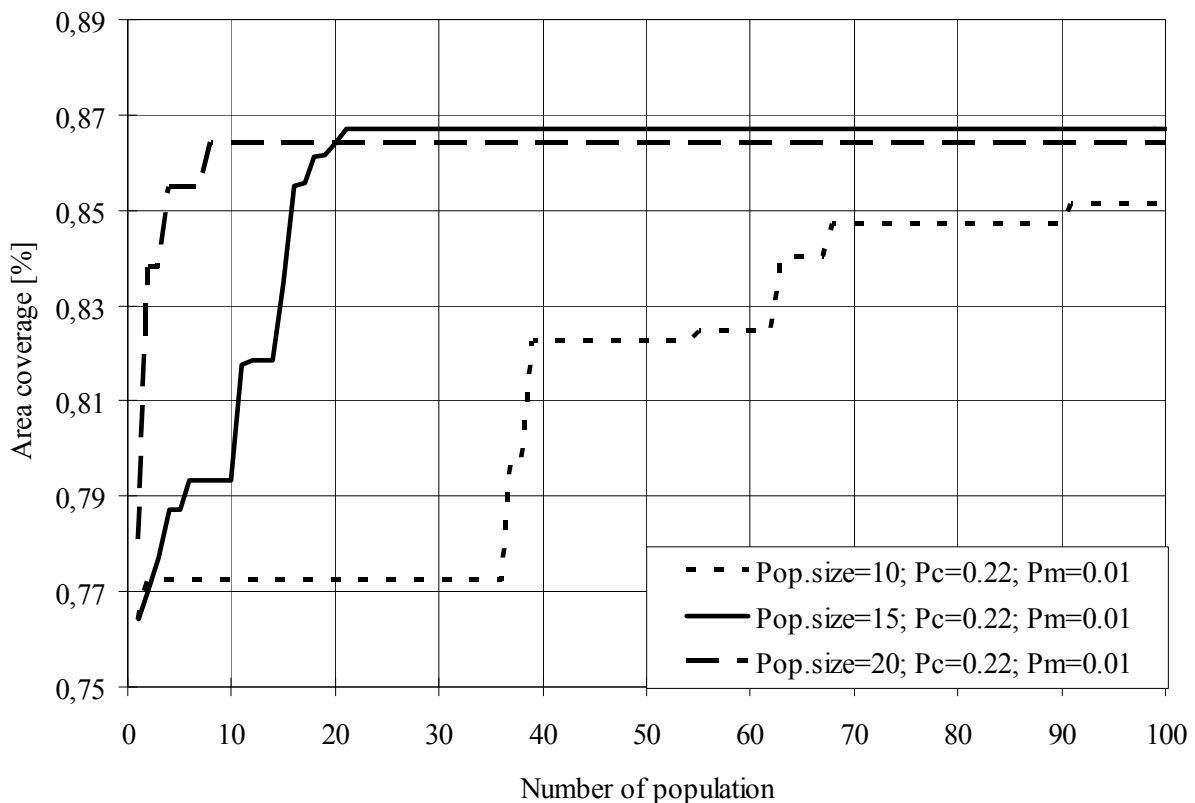

Fig. 28. Genetic Algorithm convergence (6AP whole floor)

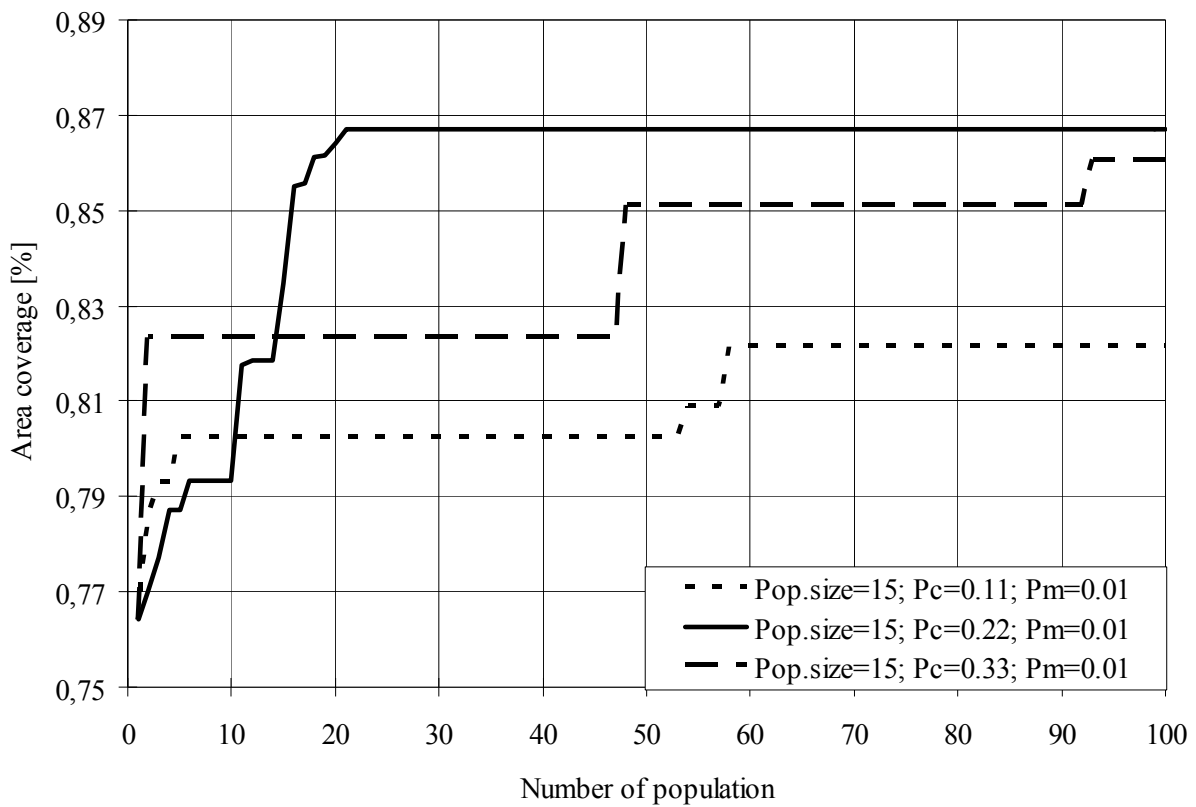

Fig. 29. Genetic Algorithm convergence (6AP whole floor)

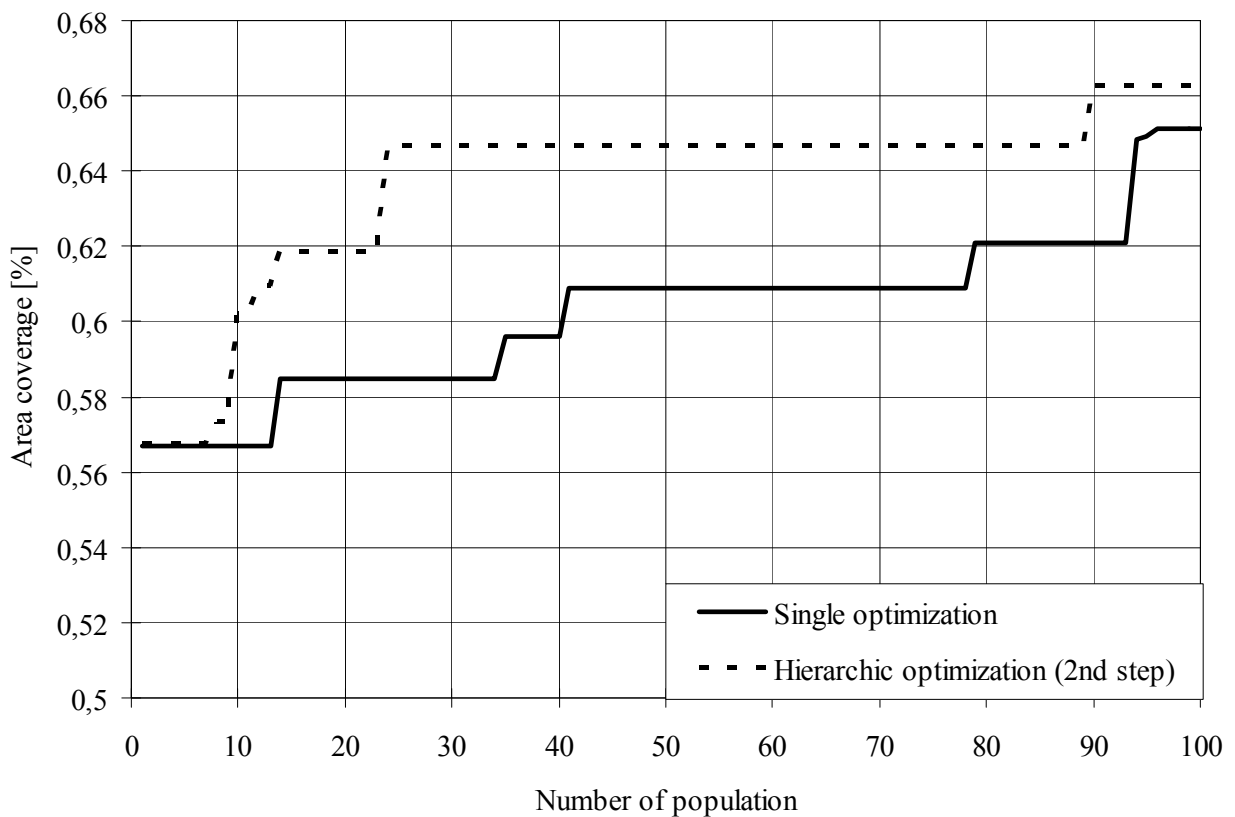

Fig. 30. Genetic Algorithm convergence (3AP whole floor)

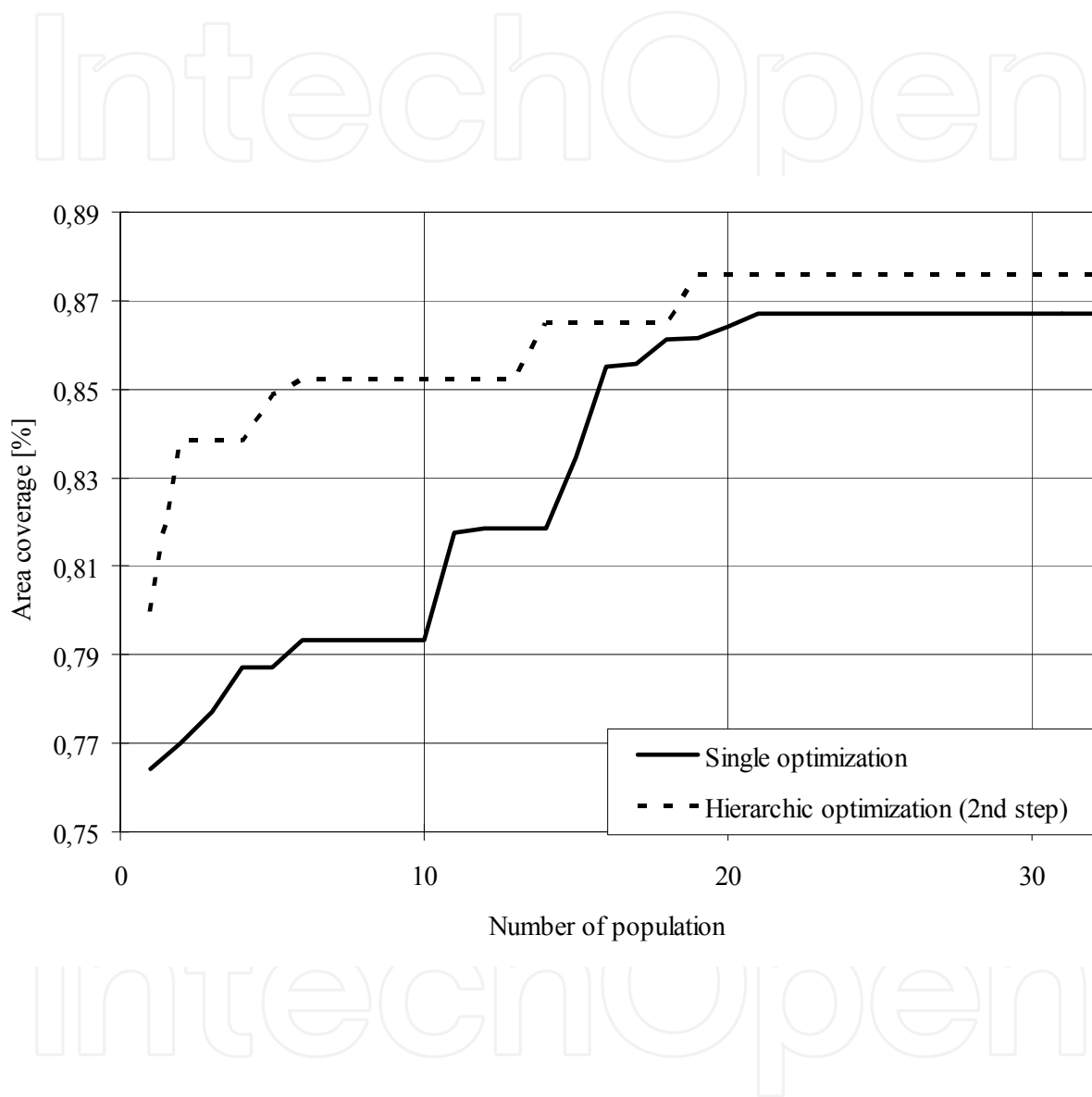

Fig. 31. Genetic Algorithm convergence (6AP whole floor)

6. Conclusion

The optimal Remote Unit position of Hybrid Fiber Radio is investigated for indoor environment. The article illustrates the possibility of optimization of HFR network using Genetic Algorithm in order to determine positions of APs. Two new approaches are introduced to solve the global optimization problem the DIRECT and a hierarchic two step optimization combined with genetic algorithm. The methods are introduced and investigated for 1,2, 3 and 6 AP cases. The influence of Genetic Algorithm parameters on the convergence has been tested and the optimal radio network is investigated. It has been shown that for finding proper placement the necessary number of APs can be reduced and therefore saving installation cost of WLAN or HFR.

It has been shown that for finding proper placement the necessary number of RU can be reduced and therefore saving installation cost of HFR. The results clearly justify the advantage of the method we used but further investigations are necessary to combine and to model other wireless network elements like leaky cables, fiber losses. Other promising direction is the extension of the optimization cost function with interference parameters of the wireless network part and with outer interference.

7. References

- Martin D. Adickes, Richard E. Billo, Bryan A. Norman, Sujata Banerjee, Bartholomew O. Nnaji, Jayant Rajgopal (2002). Optimization of indoor wireless communication network layouts, *IIE Transactions*, Volume 34, Number 9 / September, 2002, Springer,
- Cisco Visual Networking Index: Global Mobile Data Traffic Forecast Update, 2009-2014, (white paper), 2010
http://cisco.biz/en/US/solutions/collateral/ns341/ns525/ns537/ns705/ns827/white_paper_c11-520862.pdf
- Lóránt Farkas, István Laki, Lajos Nagy (2001). Base Station Position Optimization in Microcells using Genetic Algorithms, *ICT'2001*, 2001, Bucharest, Romania
- Daniel E. Finkel (2003). DIRECT Optimization Algorithm User Guide,
<http://www.ncsu.edu/crsc/reports/ftp/pdf/crsc-tr03-11.pdf>
- J.M. Keenan, A.J. Motley (1990). Radio Coverage in buildings, *BT Tech. J.*, 8(1), 1990, pp. 19-24.
- Z. Michalewicz (1996). *Genetic Algorithms + Data Structures = Evolution Programs*, Springer-Verlag, Berlin, 1996.
- E. Michielssen, Y. Rahmat-Samii, D.S. Weile (1999). *Electromagnetic System Design using Genetic Algorithms*, Modern Radio Science, 1999.
- R.D. Murch, K.W. Cheung (1996). Optimizing Indoor Base-station Locations, XXVth General Assembly of URSI, 1996, Lille, France
- Lajos Nagy, Lóránt Farkas (2000). Indoor Base Station Location Optimization using Genetic Algorithms, *PIMRC'2000 Proceedings*, Sept. 2000, London, UK
- A. Portilla-Figuerras, S. Salcedo-Sanz, Klaus D. Hackbarth, F. López-Ferreras, and G. Esteve-Asensio (2009). Novel Heuristics for Cell Radius Determination in WCDMA Systems and Their Application to Strategic Planning Studies, *EURASIP Journal on Wireless Communications and Networking*, Volume 2009 (2009)

- Liza K. Pujji, Kevin W. Sowerby, Michael J. Neve (2009). A New Algorithm for Efficient Optimization of Base Station Placement in Indoor Wireless Communication Systems, 2009 Seventh Annual Communication Networks and Services Research Conference, Moncton, New Brunswick, Canada, ISBN: 978-0-7695-3649-1
- R. E. Schuh, D. Wake, B. Verri and M. Mateescu, Hybrid Fibre Radio Access (1999) A Network Operators Approach and Requirements, 10th Microcoll Conference, Microcoll'99, Budapest, Hungary, pp. 211-214, 21-24 March, 1999
- Yufei Wu, Samuel Pierre (2007). Optimization of 3G Radio Network Planning Using Tabu Search, Journal of Communication and Information Systems, Vol. 22, No. 1, 2007

IntechOpen

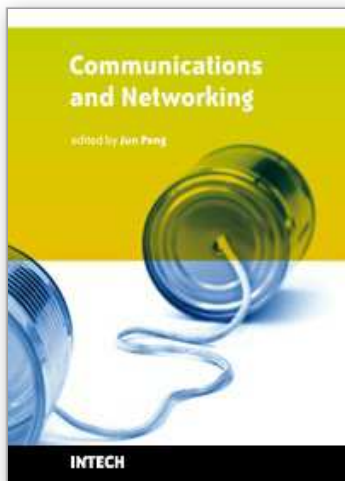

Communications and Networking

Edited by Jun Peng

ISBN 978-953-307-114-5

Hard cover, 434 pages

Publisher Sciyo

Published online 28, September, 2010

Published in print edition September, 2010

This book "Communications and Networking" focuses on the issues at the lowest two layers of communications and networking and provides recent research results on some of these issues. In particular, it first introduces recent research results on many important issues at the physical layer and data link layer of communications and networking and then briefly shows some results on some other important topics such as security and the application of wireless networks. In summary, this book covers a wide range of interesting topics of communications and networking. The introductions, data, and references in this book will help the readers know more about this topic and help them explore this exciting and fast-evolving field.

How to reference

In order to correctly reference this scholarly work, feel free to copy and paste the following:

Lajos Nagy (2010). Indoor Radio Network Optimization, Communications and Networking, Jun Peng (Ed.), ISBN: 978-953-307-114-5, InTech, Available from: <http://www.intechopen.com/books/communications-and-networking/indoor-radio-network-optimization>

INTECH
open science | open minds

InTech Europe

University Campus STeP Ri
Slavka Krautzeka 83/A
51000 Rijeka, Croatia
Phone: +385 (51) 770 447
Fax: +385 (51) 686 166
www.intechopen.com

InTech China

Unit 405, Office Block, Hotel Equatorial Shanghai
No.65, Yan An Road (West), Shanghai, 200040, China
中国上海市延安西路65号上海国际贵都大饭店办公楼405单元
Phone: +86-21-62489820
Fax: +86-21-62489821

© 2010 The Author(s). Licensee IntechOpen. This chapter is distributed under the terms of the [Creative Commons Attribution-NonCommercial-ShareAlike-3.0 License](#), which permits use, distribution and reproduction for non-commercial purposes, provided the original is properly cited and derivative works building on this content are distributed under the same license.

IntechOpen

IntechOpen