

We are IntechOpen, the world's leading publisher of Open Access books Built by scientists, for scientists

4,800

Open access books available

122,000

International authors and editors

135M

Downloads

Our authors are among the

154

Countries delivered to

TOP 1%

most cited scientists

12.2%

Contributors from top 500 universities



WEB OF SCIENCE™

Selection of our books indexed in the Book Citation Index
in Web of Science™ Core Collection (BKCI)

Interested in publishing with us?
Contact book.department@intechopen.com

Numbers displayed above are based on latest data collected.

For more information visit www.intechopen.com



Joint Subcarrier Matching and Power Allocation for OFDM Multihop System

Wenyi Wang and Renbiao Wu

*Tianjin Key Lab for Advanced Signal Processing, Civil Aviation University of China
China*

1. Introduction

Relay networks have recently attracted extensive attention due to its potential to increase coverage area and channel capacity. In a relay network, a source node communicates with a destination node with the help of the relay node. The performances of improving the channel capacity and coverage area have been explored and evaluated in the literature (Sendonaris et al., 2003)-(Laneman et al., 2004). There are two main forwarding strategies for relay node: amplify-and-forward (AF) and decode-and-forward (DF) (Laneman et al., 2004). The AF cooperative relay scheme was developed and analyzed in (Shastry & Adve, 2005), where a significant gain in the network lifetime due to node cooperation was shown. Power allocation is studied and compared for AF and DF relaying strategies for relay networks, which improves the channel capacity (Serbetli & Yener, 2006). However, DF means that the signal is decoded at the relay and recoded for retransmission. It is different from AF, where the signal is magnified to satisfy the power constraint and forwarded at the relay. This has the main advantage that the transmission can be optimized for different links, separately. In this chapter, the relay strategy DF is used.

In wideband systems, orthogonal frequency division multiplexing (OFDM) is a mature technique to mitigate the problems of frequency selectivity and intersymbol interference. The optimization of power allocation for different subcarriers offers substantial gain to the system performance. Therefore, the combination of relay network and OFDM modulation is an even more promising way to improve capacity and coverage area. However, as the fading gains for different channels are mutually independent, the subcarriers which experience deep fading over the source-relay channel may not be in deep fading over the relay-destination channel. This motivates us to consider adaptive subcarrier matching and power allocation schemes, where the bits on the subcarriers from the source to the relay are reassigned to the subcarriers from the relay to the destination. The system architecture of OFDM two-hop relay system is demonstrated in the Fig.1.

A fundamental analysis of cooperative relay systems was done by Kramer (Kramer et al., 2006), who has given channel capacity of several schemes. Relaying for OFDM systems was considered theoretically in (Shastry & Adve, 2005). Multi-user OFDM relay networks were studied by Zhu (Zhu et al., 2005), where the subcarrier was allocated to transmit own information and forward other nodes' information. Relay selection in OFDM relay networks was studied by Dai (Dai et al., 2007), which indicated the maximum diversity by selecting different relay for the different subcarrier. Radio resource allocation algorithm for relay

Source: Communications and Networking, Book edited by: Jun Peng,
ISBN 978-953-307-114-5, pp. 434, September 2010, Sciyo, Croatia, downloaded from SCIYO.COM

The worse subcarrier decreases the capacity of the matched subcarriers without subcarrier matching.

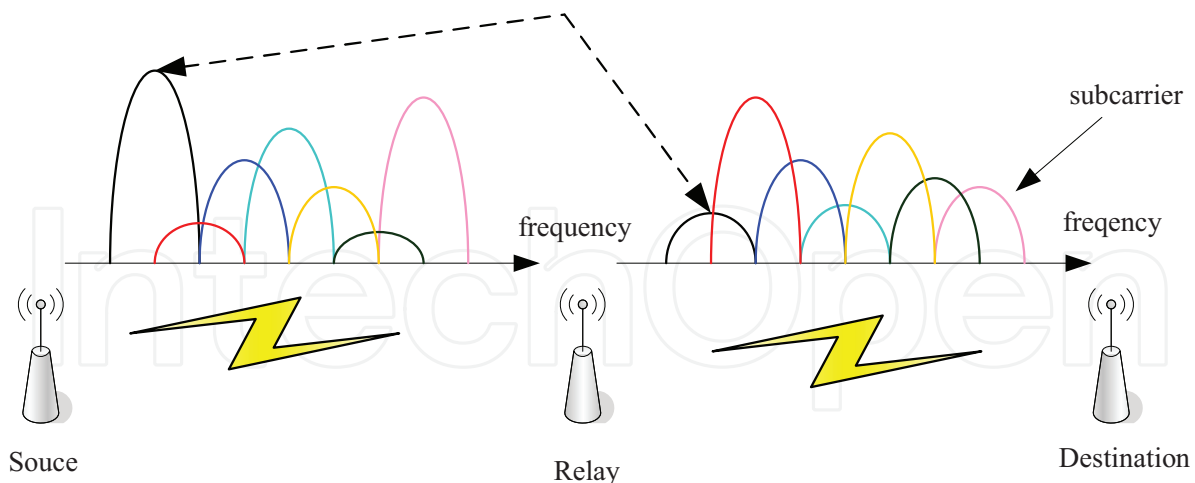

Fig. 1. System architecture of OFDM two-hop relay system

aided cellular OFDMA system was done in (Kaneko & Popovski, 2007). Adaptive relaying scheme for OFDM that taking channel state information into account has been proposed in (Herdin, 2006), where subcarrier matching was considered for OFDM amplify-and-forward scheme but the power allocation was not considered. Performances of OFDM dual-hop system with and without subcarrier matching were studied in (Suraweera & Armstrong, 2007) and (Athaudage et al., 2008), separately. The problems of resource allocation were considered in OFDMA cellular and OFDMA multihop system (Pischella & Belfiore, 2008) and (Kim et al., 2008). Bit loading algorithms were studied in (Ma et al., 2008) and (Gui et al., 2008). The subcarrier matching was also utilized to improve capacity in cognitive radio system (Pandharipande & Ho, 2007)-(Pandharipande & Ho, 2008).

In this chapter, the resource allocation problem is studied to maximize the system capacity by joint subcarrier matching and power allocation for the system with system-wide and separate power constraints. The schemes of optimal joint subcarrier matching and power allocation are proposed. All the proposed schemes perform better than the several other schemes, where there is no subcarrier matching or no power allocation.

The rest of this chapter is organized as follows. Section 2 discusses the optimal subcarrier matching and power allocation for the system with system-wide power constraint. Section 3 discusses the optimal subcarrier matching and power allocation for the system with separate power constraints. Section 6 compares the capacities of optimal schemes with that of several other schemes. Conclusions are drawn in section 5.

2. The system with system-wide power constraint

2.1 System architecture and problem formulation

An OFDM multihop system is considered where the source communicates with the destination using a single relay. The relay strategy is decode-and-forward. All nodes hold one antenna. It is assumed that the destination receives signal only from the relay but not from the source because of distance or obstacle. A two-stage transmission protocol is adopted. This means that the communication between the source and the destination covers two equal time slots. Fig.2 shows the block diagram of joint subcarrier matching and power allocation. The source transmits an OFDM symbol over the source-relay channel during the first time slot. At the same time, the relay receives and decodes the symbol. During the

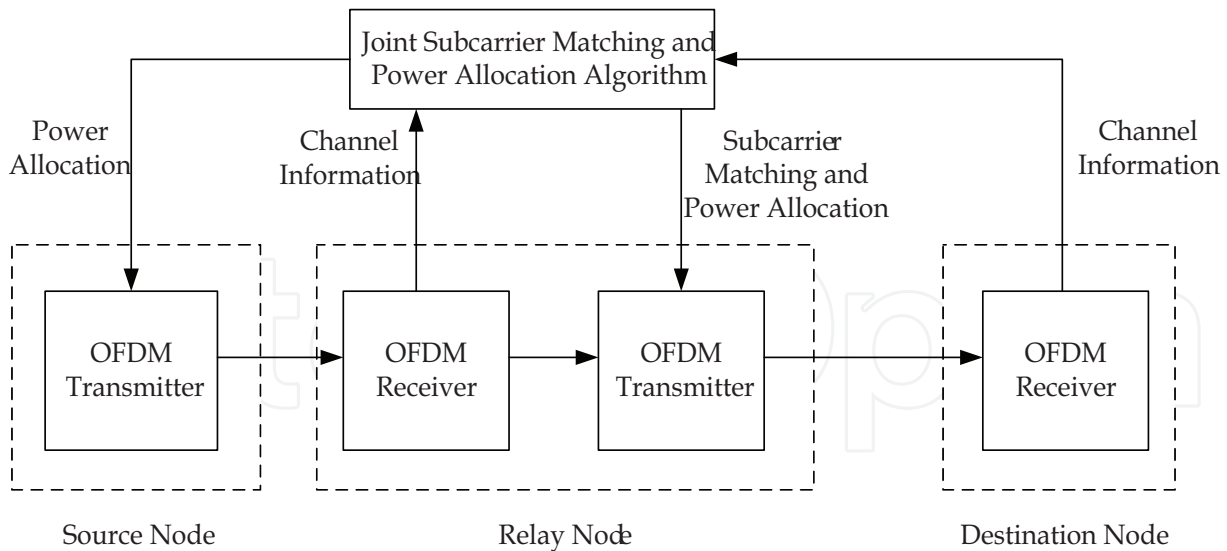

Fig. 2. Block diagram of joint subcarrier matching and power allocation

second time slot, the relay reencodes the signal with the same codebook as the one used at the source, and transmits it towards the destination over the relay-destination channel. The destination decodes the signal based on the received signal only from the relay. Furthermore, full channel state information (CSI) is assumed. The source transmits the signal to the relay with power allocation among the subcarriers based on the algorithm of joint subcarrier matching and power allocation. The relay receives the signal and decodes the signal. Then, the relay reorders the subcarrier to match subcarrier, and allocates power among the subcarriers according to the algorithm of joint subcarrier matching and power allocation. At last, the destination decodes the signal.

In this chapter, it is assumed that the different channels experience independent fading. The system consists of N subcarriers with total system power constraint. The power spectral densities of additive white Gaussian noise (AWGN) are equal at the relay and the destination. The channel capacity of the subcarrier i over the source-relay channel is given as follows

$$R_{s,i}(P_{s,i}) = \frac{1}{2} \log_2 \left(1 + \frac{P_{s,i} h_{s,i}}{N_0} \right) \tag{1}$$

where $P_{s,i}$ is the power allocated to the subcarrier i ($1 \leq i \leq N$) at the source, $h_{s,i}$ is the corresponding channel power gain, and N_0 is the power spectral density of AWGN. Similarly, the channel capacity of the subcarrier j over the relay-destination channel is given as follows

$$R_{r,j}(P_{r,j}) = \frac{1}{2} \log_2 \left(1 + \frac{P_{r,j} h_{r,j}}{N_0} \right) \tag{2}$$

where $P_{r,j}$ is the power allocated to the subcarrier j ($1 \leq j \leq N$) at the relay, and $h_{r,j}$ is the corresponding channel power gain.

Consequently, when the subcarrier i over the source-relay channel is matched to the subcarrier j over the relay-destination channel, the channel capacity of this subcarrier pair is given as follows

$$R_{ij} = \min\{R_{s,i}(P_{s,i}), R_{r,j}(P_{r,j})\} \tag{3}$$

Theoretically, the bits transmitted at the source can be reallocated to the subcarriers at the relay in arbitrary way. But for simplification, an additional constraint is that the bits transported on a subcarrier over the source-relay channel can be reallocated to only one subcarrier over the relay-destination channel, i.e., only one-to-one subcarrier matching is permitted. This means that the bits on different subcarriers over the source-relay channel will not be reallocated to the same subcarrier at the relay.

For the optimal joint subcarrier matching and power allocation problem, we can formulate it as an optimization problem. The optimization problem is given as

$$\begin{aligned} & \max_{P_{s,i}, P_{r,j}, \rho_{ij}} \sum_{i=1}^N \min \left\{ R_{s,i}(P_{s,i}), \sum_{j=1}^N \rho_{ij} R_{r,j}(P_{r,j}) \right\} \\ & \text{subject to } \sum_{i=1}^N P_{s,i} + \sum_{j=1}^N P_{r,j} \leq P_{tot} \\ & \quad P_{s,i}, P_{r,j} \geq 0, \forall i, j \\ & \quad \sum_{j=1}^N \rho_{ij} = 1, \rho_{ij} \in \{0, 1\}, \forall i, j \end{aligned}$$

where P_{tot} is the total system power constraint, and ρ_{ij} can only be either 1 or 0, indicating whether the bits transmitted on the subcarrier i at the source are retransmitted on the subcarrier j at the relay. The last constraint shows that only one-to-one subcarrier matching is permitted. By introducing the parameter C_i , the optimization problem can be transformed into

$$\begin{aligned} & \max_{P_{s,i}, P_{r,j}, \rho_{ij}, C_i} \sum_{i=1}^N C_i \\ & \text{subject to } R_{s,i}(P_{s,i}) \geq C_i \\ & \quad \sum_{j=1}^N \rho_{ij} R_{r,j}(P_{r,j}) \geq C_i \\ & \quad \sum_{i=1}^N P_{s,i} + \sum_{j=1}^N P_{r,j} \leq P_{tot} \\ & \quad P_{s,i}, P_{r,j} \geq 0, \forall i, j \\ & \quad \sum_{j=1}^N \rho_{ij} = 1, \rho_{ij} \in \{0, 1\}, \forall i, j \end{aligned}$$

Consequently the original maximization problem is transformed into a mixed binary integer programming problem. It is prohibitive to find the global optimum in terms of computational complexity. However, when ρ_{ij} is given, the objective function and all constraint functions are convex, so the optimization problem is a convex optimization problem. Then the optimal power allocation can be achieved by interior-point algorithm. Therefore, the optimal joint subcarrier matching and power allocation can be found by finding the largest objective function among all subcarrier matching possibilities, and the corresponding subcarrier matching as well as power allocation is jointly optimal. But, it has

been proved to be NP-hard and is fundamentally difficult (Korte & Vygen, 2002). In next subsection, with analytical argument, a low complexity and optimal joint subcarrier matching and power allocation scheme is given, where the optimal subcarrier matching is to match subcarriers by the order of the channel power gains and the optimal power allocation among the subcarrier pairs is based on water-filling.

2.2 Optimal joint subcarrier matching and power allocation for the system including two subcarriers

Supposing that the system includes only two subcarriers ($N = 2$): the channel power gains over the source-relay channel are $h_{s,1}$ and $h_{s,2}$, and the channel power gains over the relay-destination channel are $h_{r,1}$ and $h_{r,2}$. Without loss of generality, we assume that $h_{s,1} \leq h_{s,2}$ and $h_{r,1} \leq h_{r,2}$. The total system power constraint is also P_{tot} . As discussed in the subsection 2.1, the optimal joint subcarrier matching and power allocation can be found by two steps: (1) for every matching possibility (i.e., ρ_{ij} is given), find the optimal power allocation and the total channel capacity; (2) compare the all the total channel capacities, the largest one is the largest total channel capacity, whose subcarrier matching and power allocation are jointly optimal. But this process is prohibitive in terms of complexity. In this subsection, an analytical argument is given to prove that the optimal subcarrier matching is to match subcarrier by the order of the channel power gains and the optimal power allocation between the matched subcarrier pairs is based on water-filling. The more important is that they are jointly optimal. Before giving the scheme, the equivalent channel power gain is given for any matched subcarrier pair. For any given matched subcarrier pair, with the total power constraint, an equivalent channel power gain can be obtained by the following proposition, whose channel capacity is equivalent to the channel capacity of this subcarrier pair.

Proposition 1: For any given matched subcarrier pair, with total power constraint, an equivalent subcarrier channel power gain (e.g., h'_i) can be obtained, which is related to the channel power gains (e.g., $h_{s,i}$ and $h_{r,j}$) of the subcarrier pair as follows

$$\frac{1}{h'_i} = \frac{1}{h_{s,i}} + \frac{1}{h_{r,j}} \tag{4}$$

Proof: With the total power constraint P'_i , the channel capacity of this subcarrier pair is

$$R'_i = \max_{P_{s,i}} \min \left\{ \frac{1}{2} \log_2 \left(1 + \frac{P_{s,i} h_{s,i}}{N_0} \right), \frac{1}{2} \log_2 \left(1 + \frac{(P'_i - P_{s,i}) h_{r,i}}{N_0} \right) \right\} \tag{5}$$

where $P_{s,i}$ is the power allocated to the subcarrier i at the source, $P'_i - P_{s,i}$ is the remainder power allocated to the subcarrier j at the relay.

The first term is a monotonically increasing function of $P_{s,i}$ and the second term is a monotonically decreasing function of $P_{s,i}$. Therefore, the optimal power allocation between the corresponding subcarriers can be obtained easily

$$\frac{1}{2} \log_2 \left(1 + \frac{P_{s,i} h_{s,i}}{N_0} \right) = \frac{1}{2} \log_2 \left(1 + \frac{(P'_i - P_{s,i}) h_{r,j}}{N_0} \right) \tag{6}$$

which means that $h_{s,i}P_{s,i} = h_{r,j} (P'_i - P_{s,i})$. As a result, the channel capacity of the subcarrier pair is

$$R'_i = \frac{1}{2} \log_2 \left(1 + \frac{h_{s,i}h_{r,j}P'_i}{(h_{s,i} + h_{r,j})N_0} \right) \quad (7)$$

It can be seen that the subcarrier pair is equivalent to a single subcarrier channel with the same total power constraint. The equivalent channel power gain h'_i can be expressed

$$h'_i = \frac{h_{s,i}h_{r,j}}{h_{s,i} + h_{r,j}} \quad (8)$$

or

$$\frac{1}{h'_i} = \frac{1}{h_{s,i}} + \frac{1}{h_{r,j}} \quad (9)$$

Here, there are two ways to match the subcarriers: (i) the subcarrier 1 over the source-relay channel is matched to the subcarrier 1 over the relay-destination channel, and the subcarrier 2 over the source-relay channel is matched to the subcarrier 2 over the relay-destination channel (i.e., $h_{s,1} \sim h_{r,1}$ and $h_{s,2} \sim h_{r,2}$); (ii) the subcarrier 1 over the source-relay channel is matched to the subcarrier 2 over the relay-destination channel, and the subcarrier 2 over the source-relay channel is matched to the subcarrier 1 over the relay-destination channel (i.e., $h_{s,1} \sim h_{r,2}$ and $h_{s,2} \sim h_{r,1}$).

For the two ways of matching subcarriers, the equivalent channel power gains are denoted as $h'_{k,i}$ which can be obtained easily based on the proposition 1. Here, k implies the method of matching subcarrier and i is the equivalent subcarrier index. Then, the power allocation between the subcarrier pairs can be reformed as follow

$$\begin{aligned} \max_{P'_i} \quad & \sum_{i=1}^2 \frac{1}{2} \log_2 \left(1 + \frac{h'_{k,i}P'_i}{N_0} \right) \\ \text{subject to} \quad & \sum_{i=1}^2 P'_i \leq P_{tot} \end{aligned}$$

where P'_i is the power allocated to the equivalent subcarrier i .

It's clear that the optimal power allocation is based on water-filling (Cover & Thomas, 1991). Therefore, once the subcarrier matching is provided, the optimal power allocation is easily obtained. The remainder task is to decide which way of subcarrier matching is better. The better method can be found by getting the channel capacities of the two ways and comparing them. But, here, we give an analytical argument to prove that the optimal subcarrier matching way is the first way.

Before giving the optimal subcarrier matching way, based on the proposition 1, we can get following lemma.

Lemma 1: For the two ways of matching subcarrier, the relationship between the equivalent channel power gains can be expressed

$$\frac{1}{h'_{1,1}} + \frac{1}{h'_{1,2}} = \frac{1}{h'_{2,1}} + \frac{1}{h'_{2,2}} \tag{10}$$

Proof: Based on the proposition 1, the equivalent channel power gains of the two ways can be expressed $\frac{1}{h'_{1,1}} = \frac{1}{h_{s,1}} + \frac{1}{h_{r,1}}$, $\frac{1}{h'_{1,2}} = \frac{1}{h_{s,2}} + \frac{1}{h_{r,2}}$ and $\frac{1}{h'_{2,1}} = \frac{1}{h_{s,1}} + \frac{1}{h_{r,2}}$, $\frac{1}{h'_{2,2}} = \frac{1}{h_{s,2}} + \frac{1}{h_{r,1}}$. By summing up the corresponding terms, it is clearly that the relationship can be derived. By making use of the lemma 1, the following proposition can be proved, which states the optimal subcarrier matching way.

Proposition 2: For the system including two subcarriers, the optimal subcarrier matching is to match the subcarriers by the order of channel power gains. Together with the optimal power allocation for this subcarrier matching, they are optimal joint subcarrier matching and power allocation. In this case, the optimal subcarrier matching is as $h_{s,1} \sim h_{r,1}$ and $h_{s,2} \sim h_{r,2}$.

Proof: For the two ways of matching subcarrier, based on the lemma 1, the equivalent channel power gains satisfy the following constraint, $\frac{1}{h'_{k,1}} + \frac{1}{h'_{k,2}} = H (H \geq 0)$, where the parameter H is a constant. For the the first way, we can get $\frac{1}{h'_{1,1}} - \frac{1}{h'_{1,2}} = x_1 (H \geq x_1 \geq 0)$. For the second way, without loss of generality, it is assumed that $\frac{1}{h'_{2,1}} - \frac{1}{h'_{2,2}} = x_2 (H \geq x_2 \geq 0)$.

Therefore, the $h'_{k,i}$ can be expressed as $h'_{k,1} = \frac{2}{H+x_k}$ and $h'_{k,2} = \frac{2}{H-x_k}$. The corresponding total channel capacity is

$$R_{tot,k}(P'_1, P'_2) = \frac{1}{2} \log_2 \left(1 + \frac{P'_1}{(H+x_k) \frac{N_0}{2}} \right) + \frac{1}{2} \log_2 \left(1 + \frac{P'_2}{(H-x_k) \frac{N_0}{2}} \right) \tag{11}$$

For denotation simplicity, we denote $\frac{N_0}{2}$ as σ_2^2 . The partial derivative of the channel capacity with respect to x_k can be gotten by making use of $P'_2 = P_{tot} - P'_1$

$$\frac{\partial R_{tot,k}(P'_1, P'_2)}{\partial x_k} = \frac{1}{2 \ln 2} \frac{2P'_1 x_k (P_{tot} - P'_1) + (H^2 \sigma_2^2 - x_k^2 \sigma_2^2)(P_{tot} - 2P'_1) + 2P_{tot} H x_k \sigma_2^2}{(H^2 - x_k^2) [(H+x_k) \sigma_2^2 + P'_1] [(H-x_k) \sigma_2^2 + (P_{tot} - P'_1)]} \tag{12}$$

It is noted that, because of $h'_{k,1} \leq h'_{k,2}$, $P'_1 \leq \frac{1}{2} P_{tot}$. Therefore, it is clear that $\frac{\partial R_{tot,k}(P'_1, P'_2)}{\partial x_k}$ is

greater than 0. Therefore, the total channel capacity is a monotonically increasing function of x_k . This means that, the larger is the difference between the equivalent channel power gains, the larger is the total channel capacity. At the same time, it is clearly that the difference between the equivalent channel power gains of the first way is larger than the one of the second way. Therefore, the relationship of the total channel capacities of the two ways can be expressed

$$R_{tot,2}(P'_1, P'_2) \leq R_{tot,1}(P'_1, P'_2) \tag{13}$$

Therefore, we can get the following relationship

$$\max_{P'_i} R_{tot,2}(P'_1, P'_2) = R_{tot,2}(\bar{P}'_1, \bar{P}'_2) \leq R_{tot,1}(\bar{P}'_1, \bar{P}'_2) = \max_{P'_i} R_{tot,1}(P'_1, P'_2) \quad (14)$$

where \bar{P}'_1 and \bar{P}'_2 are the optimal power allocation for the first term. Note that the first term is the total channel capacity of the first way and the last term is the one of the second way. It proves that the first way, whose difference between the equivalent channel power gains is larger, is optimal subcarrier matching way. The more important is that, as the total channel capacity of the first way is the larger one, this subcarrier matching and the corresponding power allocation are the optimal joint subcarrier matching and power allocation. Specially, the optimal subcarrier matching is to match subcarriers by the order of the channel power gains. The optimal joint subcarrier matching and power allocation scheme has been given by now. Specially, the optimal subcarrier matching is to match the subcarriers by the order of the channel power gains and the optimal power allocation between the matched subcarrier pairs is according to the water-filling. The power allocation between the matched subcarrier pair is to make the channel capacities of the two subcarriers equivalent.

2.3 Optimal joint subcarrier matching and power allocation for the system including unlimited number of subcarriers

This subsection extends the method in the subsection 2.2 to the system including unlimited number of the subcarriers. The number of the subcarriers is finite, where the subcarrier channel power gains are $h_{s,i}(i \geq 2)$ and $h_{r,j}(j \geq 2)$. First, the optimal power allocation among the matched subcarrier pair is proposed for given subcarrier matching. Second, we prove that the subcarrier matching by the order of the channel power gains is optimal.

When the subcarrier matching is given, the equivalent channel gains of the subcarrier pairs can be gotten based on the proposition 1, e.g., $h'_i(1 \leq i \leq N)$. The power allocation can be formulated as

$$\begin{aligned} \max_{P'_i} \quad & \sum_{i=1}^N \frac{1}{2} \log_2 \left(1 + \frac{h'_i P'_i}{\sigma_N^2} \right) \\ \text{subject to} \quad & \sum_{i=1}^N P'_i \leq P_{tot} \end{aligned} \quad (15)$$

where the $\sigma_N^2 = N_0$. It is clearly that the power allocation is also based on water-filling. Therefore, the optimal power allocation among the matched subcarrier pairs is according to the water-filling.

Here, without loss of generality, the channel power gains are assumed $h_{s,i} \leq h_{s,i+1}$ and $h_{r,j} \leq h_{r,j+1}$. The following proposition gives the optimal subcarrier matching.

Proposition 3: For the system including unlimited number of the subcarriers, the optimal subcarrier matching is

$$h_{s,i} \sim h_{r,i} \quad (16)$$

Together the optimal power allocation for this subcarrier matching, they are optimal joint subcarrier matching and power allocation

Proof: This proposition will be proved in the contrapositive form. Assuming that there is a subcarrier matching method whose matching result including two matched subcarrier pairs $h_{s,i} \sim h_{r,i+n}$ and $h_{s,i+n} \sim h_{r,i}(n > 0)$, which means that $h_{s,i} \leq h_{s,i+n}$, $h_{r,i} \leq h_{r,i+n}$, and the total capacity is larger than that of the matching method in proposition 3.

When the power allocated to other subcarrier pairs and the other subcarrier matching are constant, the total channel capacity of this two subcarrier pair can be improve based on proposition 2, which imply the channel capacity can be improved by rematching the subcarriers to $h_{s,i} \sim h_{r,i}$ and $h_{s,i+n} \sim h_{r,i+n}$. It is contrary to the assumption. Therefore, there is no subcarrier matching way is better than the way in proposition 3. At the same time, as the total capacity of this subcarrier matching and the corresponding optimal power allocation scheme is the largest, this subcarrier matching together with the corresponding optimal power allocation are the optimal joint subcarrier matching and power allocation.

For the system including unlimited number of the subcarriers, the optimal joint subcarrier matching and power allocation scheme has been given by now. Here, the steps are summarized as follow

- Step 1. Sort the subcarriers at the source and the relay in ascending order by the permutations π and π' , respectively. The process is according to the channel power gains, i.e., $h_{s,\pi(i)} \leq h_{s,\pi(i+1)}, h_{r,\pi'(i)} \leq h_{r,\pi'(i+1)}$.
- Step 2. Match the subcarriers into pairs by the order of the channel power gains (i.e., $h_{s,\pi(i)} \sim h_{r,\pi'(i)}$), which means that the bits transported on the subcarrier $\pi(i)$ over the sourcerelay channel will be retransmitted on the subcarrier $\pi'(i)$ over the relay-destination channel.
- Step 3. Based on the proposition 1, get the equivalent channel power gain $h'_{\pi(i)}$ according to the matched subcarrier pair, i.e., $h'_{\pi(i)} = \frac{h_{s,\pi(i)}h_{r,\pi'(i)}}{h_{s,\pi(i)}+h_{r,\pi'(i)}}$.
- Step 4. For the equivalent channel power gains, the power allocation is based on water-filling as follow

$$P'_{\pi(i)} = \left(\frac{1}{2\lambda \ln 2} - \frac{\sigma_N^2}{h'_{\pi(i)}} \right)^+ \tag{17}$$

where $(a)^+ = \max(a,0)$ and λ can be found by the following equation

$$\sum_{i=1}^N P'_{\pi(i)} = P_{tot} \tag{18}$$

The power allocation between the subcarriers in the matched subcarrier pair is as follow

$$P_{s,\pi(i)} = \frac{h_{r,\pi'(i)}P'_{\pi(i)}}{h_{s,\pi(i)} + h_{r,\pi'(i)}} \tag{19}$$

$$P_{r,\pi'(i)} = \frac{h_{s,\pi(i)}P'_{\pi(i)}}{h_{s,\pi(i)} + h_{r,\pi'(i)}} \tag{20}$$

- Step 5. The total system channel capacity is

$$R_{tot} = \frac{1}{2} \sum_{i=1}^N \log_2 \left(1 + \frac{h'_{\pi(i)}P'_{\pi(i)}}{\sigma_N^2} \right) \tag{21}$$

3. The system with separate power constraints

3.1 System architecture and problem formulation

The system architecture adopted in this section is same as the forward section. The difference is the power constraints are separate at the source node and relay node.

It is also noted that there are three ways for the relay to forward the information to the destination. The first is that the relay decodes the information on all subcarriers and reallocates the information among the subcarriers, then forwards the information to the destination. Here, the relay has to reallocate the information among the subcarriers. At the same time, as the number of bits reallocated to a subcarrier are different as that of any subcarrier at the source, different modulation and code type have to be chosen for every subcarrier at the relay. The second is that the information on a subcarrier can be forwarded on only one subcarrier at the relay, but the information on a subcarrier is only forwarded by the same subcarrier. However, as independent fading among subcarriers, it reduces the system capacity. The third is the same as the second according to the information on a subcarrier forwarded on only one subcarrier, but it can be a different subcarrier. Here, for the matched subcarrier pair, as the bits forwarded at the relay are same as that at the source, the relay can utilize the same modulation and code as the source. It means that the bits of different subcarrier may be for different destination. Another example is relay-based downlink OFDMA system. In this system, the second hop consists of multiple destinations where the relay forwards the bits to the destinations based on OFDMA. For this system, subcarrier matching is more preferable than bits reallocation. The bits reallocation at the relay will mix the bits for different destinations. The destination can not distinguish what bits belong to it.

According to the system complexity, the first is the most complex as information reallocation among all subcarriers; the third is more complex than the second as the third has a subcarrier matching process and the second has no it. On the other hand, according to the system capacity, the first is the greatest one without loss by reallocating bits; the third is greater than the second by the subcarrier matching. The capacity of matched subcarrier is restricted by the worse subcarrier because of different fading. In this section, the third way is adopted, whose complexity is slight higher than the second. The subcarrier matching is very simple by permutation, and the system capacity of the third is almost equivalent to the greatest one according to the first and greater than that of the second. The block diagram of system is demonstrated in the Fig.3.

Throughout this section, we assume that the different channels experience independent fading. The system consists of N subcarriers with individual power constraints at the source and the relay, e.g., P_s and P_r . The power spectrum density of additive white Gaussian noise (AWGN) on every subcarrier are equal at the source and the relay.

To provide the criterion for capacity comparison, we give the upper bound of system capacity. Making use of the max-flow min-cut theory (Cover & Thomas, 1991), the upper bound of the channel capacity can be given as

$$C_{upper} = \min \left\{ \max_{P_{s,i}} \sum_{i=1}^N R_{s,i}(P_{s,i}), \max_{P_{r,j}} \sum_{j=1}^N R_{r,j}(P_{r,j}) \right\} \quad (22)$$

It is clear that the optimal power allocations at the source and the relay are according to the water-filling algorithm. By separately performing water-filling algorithm at the source and the relay, the upper bound can be obtained. According to the upper bound, the power allocations are given as following

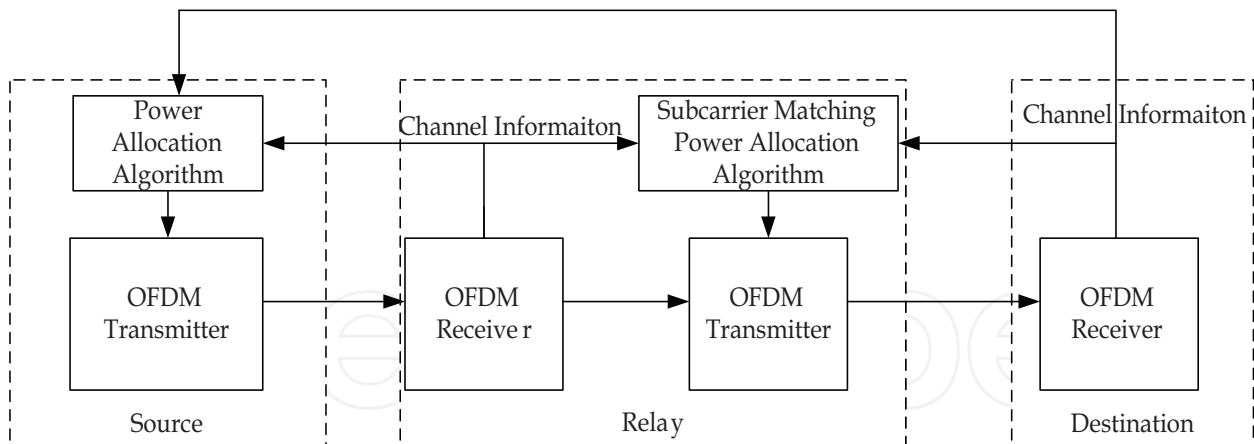

Fig. 3. Details of algorithm block diagram of joint subcarrier matching and power allocation

$$P_{s,i}^{up} = \frac{1}{\lambda_s} - \frac{N_0}{h_{s,i}} \tag{23}$$

$$P_{r,j}^{up} = \frac{1}{\lambda_r} - \frac{N_0}{h_{r,j}} \tag{24}$$

where $P_{s,i}^{up}$ and $P_{r,j}^{up}$ are the power allocations for i and j at the source and the relay. The parameters λ_s and λ_r can be obtained by the following equations

$$\sum_{i=1}^N P_{s,i}^{up} = P_s \tag{25}$$

$$\sum_{j=1}^N P_{r,j}^{up} = P_r \tag{26}$$

Here, the details are omitted, which can be referred to the reference (Cover & Thomas, 1991). Theoretically, the bits transmitted at the source can be reallocated to the subcarriers at the relay in arbitrary way, which is the first way mentioned. However, to simplify system architecture, an additional constraint is that the bits transported on a subcarrier from the source to the relay can be reallocated to only one subcarrier from the relay to the destination, i.e., only one-to-one subcarrier matching is permitted. This means that the bits on different subcarriers at the source will not be forwarded to the same subcarrier at the relay. Later, simulations will show that this constraint is approximately optimal.

The problem of optimal joint subcarrier and power allocation can be formulated as follows

$$\begin{aligned} & \max_{P_{s,i}, P_{r,j}, \rho_{ij}} \sum_{i=1}^N \min \left\{ R_{s,i}(P_{s,i}), \sum_{j=1}^N \rho_{ij} R_{r,j}(P_{r,j}) \right\} \\ \text{subject to } & \sum_{i=1}^N P_{s,i} \leq P_s, \sum_{j=1}^N P_{r,j} \leq P_r \\ & P_{s,i}, P_{r,j} \geq 0, \forall i, j \\ & \sum_{j=1}^N \rho_{ij} = 1, \rho_{ij} \in \{0, 1\}, \forall i, j \end{aligned}$$

where ρ_{ij} , being either 1 or 0, is the subcarrier matching parameter, indicating whether the bits transmitted in the subcarrier i at the source are retransmitted on the subcarrier j at the relay. Here, the objective function is system capacity. The first two constraints are separate power constraints at the source and the relay, which is different from the constraint in the previous section where the two constraints is incorporated to be a total power constraint. The last two constraints show that only one-to-one subcarrier matching is permitted, which distinguishes the third way from the first way mentioned.

For evaluation, we transform the above optimization to another one. By introducing the parameter C_i , the optimization problem can be transformed into

$$\begin{aligned} & \max_{P_{s,i}, P_{r,j}, \rho_{ij}, C_i} \sum_{i=1}^N C_i \\ \text{subject to } & \frac{1}{2} \log_2 \left(1 + \frac{P_{s,i} h_{s,i}}{N_0} \right) \geq C_i \\ & \sum_{j=1}^N \rho_{ij} \frac{1}{2} \log_2 \left(1 + \frac{P_{r,j} h_{r,j}}{N_0} \right) \geq C_i \\ & \sum_{i=1}^N P_{s,i} \leq P_s, \sum_{j=1}^N P_{r,j} \leq P_r \\ & P_{s,i}, P_{r,j} \geq 0, \forall i, j \\ & \sum_{j=1}^N \rho_{ij} = 1, \rho_{ij} \in \{0, 1\}, \forall i, j \end{aligned}$$

That is, the original maximization problem is transformed to a mixed binary integer programming problem. However, it is prohibitive to find the global optimum in terms of computational complexity. In order to determine the optimal solution, an exhaustive search is needed which has been proved to be NP-hard and is fundamentally difficult to solve (Korte & Vygen, 2002). For each subcarrier matching possibility, find the corresponding system capacity, and the largest one is optimal. The corresponding subcarrier matching and power allocation is optimal joint subcarrier matching and power allocation.

In following subsection, by separating subcarrier matching and power allocation, the optimal solution of the above optimization problem is proposed. For the global optimum, the optimal subcarrier matching is proved; then, the optimal power allocation is provided for the optimal subcarrier matching. Additionally, a suboptimal scheme with less complexity is also proposed to better understand the effect of power allocation, and the capacity of suboptimal scheme delivering performance is close to the upper bound of system capacity.

3.2 Optimal subcarrier matching for global optimum

First, the optimal subcarrier matching is provided for system including two subcarriers. Then, the way of optimal subcarrier matching is extended to the system including unlimited number of subcarriers.

3.2.1 Optimal subcarrier matching for the system including two subcarriers

For the mixed binary integer programming problem, the optimal joint subcarrier matching and power allocation can be found by two steps: (1) for every matching possibility (i.e., ρ_{ij} is

given), find the optimal power allocation and the total channel capacity; (2) compare the all channel capacities, the largest one is the ultimate system capacity, whose subcarrier matching and power allocation are jointly optimal. But, this process is prohibitive to find global optimum in terms of complexity. In this subsection, an analytical argument is given to prove that the optimal subcarrier matching is to match subcarrier by the order of the channel power gains.

Here, we assume that the system includes only two subcarriers, i.e., $N = 2$. The channel power gains over the source-relay channel are denoted as $h_{s,1}$ and $h_{s,2}$, and the channel power gains over the relay-destination channel are denoted as $h_{r,1}$ and $h_{r,2}$. Without loss of generality, we assume that $h_{s,1} \geq h_{s,2}$ and $h_{r,1} \geq h_{r,2}$, i.e., the subcarriers are sorted according to the channel power gains. The system power constraints are P_s and P_r at the source and the relay, separately.

In this case, the mixed binary integer programming problem can be reduced to the following optimization problem.

$$\begin{aligned} & \max_{P_{s,i}, P_{r,j}, \rho_{ij}, C_i} \sum_{i=1}^2 C_i \\ \text{subject to } & \frac{1}{2} \log_2 \left(1 + \frac{P_{s,i} h_{s,i}}{N_0} \right) \geq C_i \\ & \sum_{j=1}^2 \rho_{ij} \frac{1}{2} \log_2 \left(1 + \frac{P_{r,j} h_{r,j}}{N_0} \right) \geq C_i \\ & \sum_{i=1}^2 P_{s,i} \leq P_s, \sum_{j=1}^2 P_{r,j} \leq P_r \\ & P_{s,i}, P_{r,j} \geq 0, \forall i, j \\ & \sum_{j=1}^2 \rho_{ij} = 1, \rho_{ij} = \{0, 1\}, \forall i, j \end{aligned}$$

Here, there are two possibilities to match the subcarriers: (1) the subcarrier 1 over the sourcerelay channel is matched to the subcarrier 1 over the relay-destination channel, and the subcarrier 2 over the source-relay channel is matched to the subcarrier 2 over the relay-destination channel (i.e., $h_{s,1} \sim h_{r,1}$ and $h_{s,2} \sim h_{r,2}$); (2) the subcarrier 1 over the source-relay channel is matched to the subcarrier 2 over the relay-destination channel, and the subcarrier 2 over the source-relay channel is matched to the subcarrier 1 over the relay-destination channel (i.e., $h_{s,1} \sim h_{r,2}$ and $h_{s,2} \sim h_{r,1}$). As there are only two possibilities, the optimal subcarrier matching can be obtained by comparing the capacities of two possibilities. However, the process has to be repeated when the channel power gains are changed. Next, optimal subcarrier matching way will be given without computing the capacities of all subcarrier matching possibilities, after Lemma 2 is proposed and proved.

Lemma 2: For global optimum of the upper optimization problem, the capacity of the better subcarrier is greater than that of the worse subcarrier, where better and worse are according to the channel power gain at the source and the relay.

Proof: We will prove this *Lemma* in the contrapositive form. First, for the global optimum, we assume the power allocations at the source are $P'_{s,1}$ and $P_s - P'_{s,1}$, and assume $R'_{s,1} \leq R'_{s,2}$, i.e., the capacity of better subcarrier is less than that of worse subcarrier, which means

$$\log_2 \left(1 + \frac{h_{s,1} P'_{s,1}}{N_0} \right) \leq \log_2 \left(1 + \frac{h_{s,2} (P_s - P'_{s,1})}{N_0} \right) \quad (27)$$

As the capacity of optimum is the greatest one, the capacity is greater than any other power allocation. When the subcarrier matching is constant, there are no other power allocations to the two subcarriers denoted as $P_{s,1}^*$ and $P_s - P_{s,1}^*$, which make the capacities of two subcarrier satisfied with following relations

$$R_{s,1}^* \geq R'_{s,2} \quad (28)$$

$$R_{s,2}^* \geq R'_{s,1} \quad (29)$$

If the power allocation $P_{s,1}^*$ and $P_s - P_{s,1}^*$ exist, we can rematch the subcarriers to improve system capacity by exchanging the subcarrier 1 and subcarrier 2, i.e., changing the subcarrier matching. According to the new subcarrier matching and power allocation, it is clear that the system capacity can be improved.

Here, we will prove that there exist the power allocations which are satisfied with the equations (28) and (29).

$$\log_2 \left(1 + \frac{h_{s,1} P_{s,1}^*}{N_0} \right) \geq \log_2 \left(1 + \frac{h_{s,2} (P_s - P'_{s,1})}{N_0} \right) \quad (30)$$

$$\log_2 \left(1 + \frac{h_{s,2} (P_s - P_{s,1}^*)}{N_0} \right) \geq \log_2 \left(1 + \frac{h_{s,1} P'_{s,1}}{N_0} \right) \quad (31)$$

By solving the above inequalities, we can get the following inequation

$$\frac{h_{s,2}}{h_{s,1}} (P_s - P'_{s,1}) \leq P_{s,1}^* \leq P_s - \frac{h_{s,1}}{h_{s,2}} P'_{s,1} \quad (32)$$

At the same time, to satisfy the inequality (27), the following relation has to be satisfied

$$P'_{s,1} \leq \frac{h_{s,2} P_s}{h_{s,1} + h_{s,2}} \quad (33)$$

By making use of the above inequality, we can get

$$\begin{aligned} \frac{h_{s,2}}{h_{s,1}} (P_s - P'_{s,1}) - \left(P_s - \frac{h_{s,1}}{h_{s,2}} P'_{s,1} \right) &= \frac{h_{s,2}}{h_{s,1}} P_s - P_s + \frac{(h_{s,1} + h_{s,2})(h_{s,1} - h_{s,2})}{h_{s,1} h_{s,2}} P'_{s,1} \\ &\leq \frac{h_{s,2}}{h_{s,1}} P_s - P_s + \frac{(h_{s,1} + h_{s,2})(h_{s,1} - h_{s,2})}{h_{s,1} h_{s,2}} \frac{h_{s,2} P_s}{h_{s,1} + h_{s,2}} \\ &= \frac{h_{s,2}}{h_{s,1}} P_s - P_s - \frac{h_{s,2}}{h_{s,1}} P_s + P_s \\ &= 0 \end{aligned}$$

Therefore, the following inequality is proved

$$\frac{h_{s,2}}{h_{s,1}}(P_s - P'_{s,1}) \leq P_s - \frac{h_{s,1}}{h_{s,2}}P'_{s,1} \tag{34}$$

This means that we can always find $P_{s,1}^*$ which satisfies the inequality (32). The new power allocation $P_{s,1}^*$ makes the inequalities (28) and (29) satisfied.

Then, we can rematch the subcarriers by exchanging the subcarrier 1 and subcarrier 2 at the source to improve the system capacity. This means that the system capacity of the new subcarrier matching and power allocation is greater than that of the original power allocation.

Therefore, for any power allocations which make the subcarrier capacity of worse subcarrier is greater than that of the better subcarrier, we always can find new power allocation to improve system capacity and make the subcarrier capacity of better subcarrier greater than that of worse subcarrier.

At the relay, for the global optimum, the similar process can be used to prove that the capacity of better subcarrier is greater than that of the worse subcarrier.

Therefore, for the global optimum at the source and the relay, we can conclude that the subcarrier capacity of better subcarrier is greater than that of the worse subcarrier with any channel power gains.

By making use of *Lemma 2*, the following proposition can be proved, which states the optimal subcarrier matching way for the global optimum.

Proposition 4: For the global optimum in the system including only two subcarriers, the optimal subcarrier matching is that the better subcarrier is matched to the better subcarrier and the worse subcarrier is matched to the worse subcarrier, i.e., $h_{s,1} \sim h_{r,1}$ and $h_{s,2} \sim h_{r,2}$.

Proof: Following *Lemma 2*, we know that the capacity of the better subcarrier is greater than the capacity of the worse subcarrier for the global optimum, i.e., $R_{s,1}^* \geq R_{s,2}^*, R_{r,1}^* \geq R_{r,2}^*$. There are two ways to match subcarrier: first, the better subcarrier is matched to the better subcarrier, i.e., $h_{s,1} \sim h_{r,1}$ and $h_{s,2} \sim h_{r,2}$; second, the better subcarrier is matched to the worse subcarrier, i.e., $h_{s,1} \sim h_{r,2}$ and $h_{s,2} \sim h_{r,1}$.

We can prove the optimal subcarrier matching is the first way by proving the following inequality

$$\min(R_{s,1}^*, R_{r,1}^*) + \min(R_{s,2}^*, R_{r,2}^*) \geq \min(R_{s,1}^*, R_{r,2}^*) + \min(R_{s,2}^*, R_{r,1}^*) \tag{35}$$

where the left is the system capacity of the first subcarrier matching and the right is that of the second subcarrier matching.

To prove the upper inequality, we can list all possible relations of $R_{s,1}^*, R_{r,1}^*, R_{s,2}^*$ and $R_{r,2}^*$. Restricted to the relations $R_{s,1}^* \geq R_{s,2}^*$ and $R_{r,1}^* \geq R_{r,2}^*$, there are six possibilities (1) $R_{s,1}^* \geq R_{s,2}^* \geq R_{r,1}^* \geq R_{r,2}^*$; (2) $R_{s,1}^* \geq R_{r,1}^* \geq R_{s,2}^* \geq R_{r,2}^*$; (3) $R_{s,1}^* \geq R_{r,1}^* \geq R_{r,2}^* \geq R_{s,2}^*$; (4) $R_{r,1}^* \geq R_{r,2}^* \geq R_{s,1}^* \geq R_{s,2}^*$; (5) $R_{r,1}^* \geq R_{s,1}^* \geq R_{r,2}^* \geq R_{s,2}^*$; (6) $R_{r,1}^* \geq R_{s,1}^* \geq R_{s,2}^* \geq R_{r,2}^*$. For the every possibility, it is easy to prove the inequality (35) satisfied. Details are omitted for sake of the length.

So far, for the system including two subcarriers, the optimal joint subcarrier matching has been given. Specially, the optimal subcarrier matching is to match the subcarriers by the order of the channel power gains.

3.2.2 Optimal subcarrier matching for the system including unlimited number of subcarriers

This subsection extends the method in the previous subsection to the system including unlimited number of the subcarriers. The number of the subcarriers is finite (e.g., $2 \leq N \leq \infty$), where the subcarrier channel power gains are $h_{s,i}$ and $h_{r,j}$.

As before the channel power gains are assumed $h_{s,i} \geq h_{s,i+1}$ ($1 \leq i \leq N-1$) and $h_{r,j} \geq h_{r,j+1}$ ($1 \leq j \leq N-1$). For the global optimum, the following proposition gives the optimal subcarrier matching.

Proposition 5: For the global optimum in the system including unlimited number of the subcarriers, the optimal subcarrier matching is

$$h_{s,i} \sim h_{r,i} \quad (36)$$

Together with the optimal power allocation for this subcarrier matching, they are optimal joint subcarrier matching and power allocation

Proof: This proposition will be proved in the contrapositive form. For the global optimum, assuming that there is a subcarrier matching method whose matching result including two matched subcarrier pairs $h_{s,i} \sim h_{r,i+n}$ and $h_{s,i+n} \sim h_{r,i}$ ($n > 0$), and the total capacity is greater than that of the matching method in *Proposition 4*.

When the power allocated to other subcarriers and the other subcarrier matching are constant, the total channel capacity of the two subcarrier pairs can be improved based on *Proposition 4*, which implies the channel capacity can be improved by rematching the subcarriers to $h_{s,i} \sim h_{r,i}$ and $h_{s,i+n} \sim h_{r,i+n}$. It is contrary to the assumption. Therefore, there is no subcarrier matching way better than the way in *Proposition 4*. At the same time, as the total capacity of this subcarrier matching and the corresponding optimal power allocation scheme is the largest one, this subcarrier matching together with the corresponding optimal power allocations is the optimal joint subcarrier matching and power allocation.

Therefore, for the system including unlimited number of the subcarriers, the optimal subcarrier matching is to match the subcarrier according to the order of channel power gains, i.e., $h_{s,i} \sim h_{r,i}$. As it is optimal subcarrier matching for the global optimum, together with the optimal power allocation for this subcarrier matching, they are optimal joint subcarrier matching and power allocation.

3.3 Optimal power allocation for optimal subcarrier matching

When the subcarrier matching is given, the parameters ρ_{ij} in optimization problem (9) is constant, e.g., $\rho_{ii} = 1$ and $\rho_{ij} = 0$ ($i \neq j$). Therefore, the optimization problem can be reduced to as follows

$$\begin{aligned} & \max_{P_{s,i}, P_{r,i}, C_i} \sum_{i=1}^N C_i \\ \text{subject to} & \frac{1}{2} \log_2 \left(1 + \frac{P_{s,i} h_{s,i}}{N_0} \right) \geq C_i \\ & \frac{1}{2} \log_2 \left(1 + \frac{P_{r,i} h_{r,i}}{N_0} \right) \geq C_i \\ & \sum_{i=1}^N P_{s,i} \leq P_s, \sum_{i=1}^N P_{r,i} \leq P_r \\ & P_{s,i}, P_{r,i} \geq 0, \forall i, j \end{aligned}$$

It is easy to prove that the above optimization problem is a convex optimization problem (Boyd & Vanderberghe, 2004). By this way, we have transformed the mixed binary integer programming problem to a convex optimization problem. Therefore, we can solve it to get the optimal power allocation for the optimal subcarrier matching.

Consider the Lagrangian

$$L(\mu_{s,i}, \mu_{r,i}, \gamma_s, \gamma_r) = -\sum_{i=1}^N C_i + \sum_{i=1}^N \mu_{s,i} \left(C_i - \frac{1}{2} \log_2 \left(1 + \frac{P_{s,i} h_{s,i}}{N_0} \right) \right) + \gamma_s \left(\sum_{i=1}^N P_{s,i} - P_s \right) + \sum_{i=1}^N \mu_{r,i} \left(C_i - \frac{1}{2} \log_2 \left(1 + \frac{P_{r,i} h_{r,i}}{N_0} \right) \right) + \gamma_r \left(\sum_{i=1}^N P_{r,i} - P_r \right)$$

where $\mu_{s,i} \geq 0, \mu_{r,i} \geq 0, \gamma_s \geq 0, \gamma_r \geq 0$ are the Lagrangian parameters.

By making the derivations of $P_{s,i}$ and $P_{r,i}$ equal to zero, we can get the following equations

$$P_{s,i} = \frac{\mu_{s,i}}{2\gamma_s \ln 2} - \frac{N_0}{h_{s,i}} \tag{37}$$

$$P_{r,i} = \frac{\mu_{r,i}}{2\gamma_r \ln 2} - \frac{N_0}{h_{r,i}} \tag{38}$$

By making the derivation of C_i equal to zero, we can get the following equations

$$\mu_{s,i} + \mu_{r,i} = 1 \tag{39}$$

At the same time, for the Lagrangian parameters, we can get the following equations based on KKT conditions (Boyd & Vanderberghe, 2004)

$$\mu_{s,i} \left(C_i - \frac{1}{2} \log_2 \left(1 + \frac{P_{s,i} h_{s,i}}{N_0} \right) \right) = 0 \tag{40}$$

$$\mu_{r,i} \left(C_i - \frac{1}{2} \log_2 \left(1 + \frac{P_{r,i} h_{r,i}}{N_0} \right) \right) = 0 \tag{41}$$

For the summation of subcarrier allocated power at the source and the relay, we make the unequal equation be equal, i.e.,

$$\sum_{i=1}^N P_{s,i} = P_s \tag{42}$$

$$\sum_{i=1}^N P_{r,i} = P_r \tag{43}$$

It is noted that we make the summations of subcarrier power equal to the power constrains at the source and the relay, separately. It is clear that the system capacity will not be reduced by this mechanism.

By making use of the equations (35)-(43), the parameters $\mu_{s,i}$, $\mu_{r,i}$, γ_s and γ_r can be provided. Therefore, the optimal power allocation is achieved. From the expression of power allocation, the power allocation is like based on water-filling. But for different subcarrier, the water surface is different, which is because of the parameters $\mu_{s,i}$ and $\mu_{r,i}$ in power expressions. The power computation is more complex than water-filling algorithm.

In the proof of optimal subcarrier matching, we proved that the optimal subcarrier matching is globally optimal for joint subcarrier matching and power allocation. Therefore, the optimal subcarrier matching is optimal for the optimal power allocation. For optimal joint subcarrier matching and power allocation scheme, it means that the subcarrier matching parameters have to be $\rho_{ii} = 1$ and $\rho_{ij} = 0 (i \neq j)$. Then, the optimal power allocation is obtained according to the globally optimal subcarrier matching parameters. Therefore, the joint subcarrier matching and power allocation scheme is globally optimal. It is different from iterative optimization approach for different parameters where optimization has to be utilized iteratively.

For the system including any number of the subcarriers, the optimal joint subcarrier matching and power allocation scheme has been given by now. Here, the steps are summarized as follows

- Step 1. Sort the subcarriers at the source and the relay in descending order by the permutations π and π' , respectively. The process is according to the channel power gains, i.e., $h_{s,\pi(i)} \geq h_{s,\pi(i+1)}$, $h_{r,\pi'(i)} \geq h_{r,\pi'(i+1)}$.
- Step 2. Match the subcarriers into pairs by the order of the channel power gains (i.e., $h_{s,\pi(i)} \sim h_{r,\pi'(i)}$), which means that the bits transported on the subcarrier $\pi(i)$ over the sourcerelay channel will be retransmitted on the subcarrier $\pi'(i)$ over the relay-destination channel.
- Step 3. Using *Proposition 2*, get the optimal power allocation for the subcarrier matching based on the equations (24) and (25).
- Step 4. According to the optimal joint subcarrier matching and power allocation, get the capacities of all subcarrier at the source and the relay. The capacity of a matched subcarrier pair is

$$C_i = \min \left\{ \frac{1}{2} \log_2 \left(1 + \frac{P_{s,\pi(i)} h_{s,\pi(i)}}{N_0} \right), \frac{1}{2} \log_2 \left(1 + \frac{P_{r,\pi'(i)} h_{r,\pi'(i)}}{N_0} \right) \right\} \quad (44)$$

- Step 5. The total system channel capacity is

$$R_{tot} = \sum_{i=1}^N C_i \quad (45)$$

3.4 The suboptimal scheme

In order to obtain the insight about the effect of power allocation and understand the effect of power allocation, a suboptimal joint subcarrier matching and power allocation is proposed. In optimal scheme, the power allocation is like water-filling but with different water surface at different subcarrier. We infer that the power allocation can be obtained according to water-filling at least at one side. The different power allocation has little effect on the system capacity.

In section 4, the simulations will show that the capacity of optimal scheme is almost equal to the upper bound of system capacity. However, the upper bound is the less one of the capacities of source-relay channel and relay-destination channel. These results motivate us to give the suboptimal scheme. In the suboptimal scheme, the main idea is to make the capacity of the suboptimal scheme as close to the less one as possible of the capacities of source-relay channel and relay-destination channel. Therefore, we hold the power allocation at the less side and make the capacity of the matched subcarrier at the greater side close to the corresponding subcarrier at the less one. At the same time, it is noted that the better subcarrier will need less power than the worse subcarrier to achieve the same capacity improvement. It means that the better subcarrier will have more effect on system capacity by reallocating the power. Therefore, the power reallocation will be made from the best subcarrier to the worst subcarrier at the greater side.

The globally optimal subcarrier matching can be accomplished by simple permutation. Therefore, the same subcarrier matching as the optimal scheme is adopted. The power allocation is different from the optimal scheme. First, to maximize the capacity, we perform water-filling algorithm at the source and the relay separately to get the maximum capacities of source-relay channel and relay-destination channel. In order to close the less one, we keep the power allocation and capacity at the less side, and try to make the greater side equal to the less side. The power reallocation will be made from the best subcarrier to the worst subcarrier at the greater side. Without loss of generality, we assume that the capacity of source-relay channel is less than that of relay-destination channel after applying water-filling algorithm. This means that we keep the power allocation at the source and reallocate power at the relay to make the subcarrier capacity equal to the corresponding subcarrier from the best subcarrier to the worst subcarrier at the relay. Therefore, the less one of them is the capacity of suboptimal scheme. It is noted that the suboptimal scheme still separates the subcarrier matching and power allocation and the subcarrier matching is the same as that of optimal scheme.

The scheme can be described in detail as follows:

- Step 1. Sort the subcarriers at the source and the relay in descending order by permutations π and π' , respectively. The process is according to the channel gains, i.e., $h_{s,\pi(i)} \geq h_{s,\pi(i+1)}$, $h_{r,\pi'(j)} \geq h_{r,\pi'(j+1)}$. Then, match the subcarriers into pairs at the same order of both nodes (i.e., $\pi(k) \sim \pi'(k)$), which means that the bits transported on the subcarrier $\pi(k)$ at the source will be retransmitted on the subcarrier $\pi'(k)$ at the relay.
- Step 2. Perform the water-filling algorithm to get the respective channel capacity at the source and the relay. Without loss of generality, we assume the channel capacity over source-relay channel is less than the total channel capacity over relay-destination channel.
- Step 3. From $k = 1$ to N , reallocate the power to subcarrier $\pi'(k)$ so that $R_{r,\pi'(k)} = R_{s,\pi(k)}$ until $\sum_{i=1}^k P_{r,\pi'(i)} \geq P_r$ or $k = N$. The power allocated to the k th subcarrier is $P_r - \sum_{i=1}^k P_{r,\pi'(i)}$ if $k < N$ and $\sum_{i=1}^k P_{r,\pi'(i)} \geq P_r$, and the power allocated to the other subcarriers is zero.

The power allocation of the suboptimal scheme includes performing water-filling algorithm twice and some line operations, which is easier than that of optimal joint subcarrier matching and power allocation. Next, the simulations will prove that the capacity of

suboptimal is close to that of optimal scheme. The main reasons include two: (1) The subcarrier matching of the suboptimal scheme is globally optimal as that of the optimal scheme. (2) The method of power allocation is to make the capacity as close to the upper bound as possible. The subcarrier with more effect on the capacity is considered firstly through power allocation.

4. Simulation

In this section, the capacities of the optimal and suboptimal schemes are compared with that of several other schemes and the upper bound of system capacity with separate power constraints by computer simulations. These schemes include:

- i. No subcarrier matching and no water-filling with separate power constraints: the bits transmitted on the subcarrier i at the source will be retransmitted on the subcarrier i at the relay; the power is allocated equally among the all subcarriers at the source and the relay, separately. It is denoted as *no matching & no water-filling* in the figures.
- ii. Water-filling and no subcarrier matching with separate power constraints: the bits transmitted on the subcarrier i at the source will be retransmitted on the subcarrier i at the relay; the power allocation is according to water-filling at the source and the relay, separately. It is denoted as *water-filling & no matching* in the figures.
- iii. Subcarrier matching and no water-filling with separate power constraints: the bits transmitted on the subcarrier $\pi(i)$ at the source will be retransmitted on the subcarrier $\pi'(i)$ at the relay; the power is allocated equally among the all subcarriers at the source and the relay, separately. It is denoted as *matching & no water-filling* in the figures.
- iv. Subcarrier matching and water-filling with separate power constraints: the bits transmitted on subcarrier $\pi(i)$ at the source will be retransmitted on the subcarrier $\pi'(i)$ at the relay; the power is allocated according to water-filling algorithm at the source and the relay, separately. It is denoted as *matching & water-filling* in the figures.
- v. Optimal joint subcarrier matching and power allocation with total power constraint. Here, the power constraint is system-wide. It is denoted as *optimal & total* in the figures.

Here, the subcarrier matching is the same as that of optimal and suboptimal schemes, which can be complemented according to the *Step 1 - Step 2* in the optimal scheme. The water-filling means that the water-filling algorithm is performed at the source and the relay only once.

According to the complexity, the suboptimal scheme has less complexity than the optimal scheme, where the difference comes from different power allocation. For the optimal scheme, the optimal power allocation is like based on water-filling, which can be obtained by multiwaterlevel water-filling solution with complexity $\mathcal{O}(2n)$ according to the reference (Palomar & Fonollosa, 2005). The power allocation of suboptimal scheme can be obtained by water-filling and some linear operation with complexity $\mathcal{O}(n)$ according to the reference (Palomar & Fonollosa, 2005). Therefore, the suboptimal has less complexity than optimal scheme. The other schemes without power allocation or subcarrier matching have less complexity compared with the optimal and suboptimal schemes.

In the computer simulations, it is assumed that each subcarrier undergoes identical Rayleigh fading independently and the average channel power gains, $E(h_{s,i})$ and $E(h_{r,j})$ for all i and j , are assumed to be one. Though the Rayleigh fading is assumed, it is noted that the proof of optimal subcarrier matching utilizes only the order of the subcarrier channel power gains.

The concrete fading distribution has nothing to do with the optimal subcarrier matching. The optimal power allocation for the optimal subcarrier is not utilizing the Rayleigh fading assumption. Therefore, the proposed scheme is effective for other fading distribution, and the same subcarrier matching and power allocation scheme can be adopted. The total bandwidth is $B = 1\text{MHz}$. The SNR_s is defined as $P_s/(N_0B)$ and SNR_r is defined as $P_r/(N_0B)$. To obtain the average data rate, we have simulated 10,000 independent trials.

Fig. 4 shows the capacity versus $SNR_s = SNR_r$. In Fig.4, for the system with separate power constraints, it is noted that the capacity of optimal scheme is approximately equal to upper bound of capacity, which proves that the one-to-one subcarrier matching is approximately optimal. Furthermore, the one-to-one subcarrier matching simplifies the system architecture. The capacity of suboptimal scheme is also close to that of optimal scheme. This can be explained by the approximate equality of capacity of suboptimal scheme to the upper bound of system capacity. Meanwhile, it is also noted that the capacity of suboptimal scheme is greater than that of *subcarrier matching & water-filling*. Though the power allocations at the less side of the two schemes are in same way, the power reallocation at the greater side can improve the system capacity for the suboptimal scheme. The reason is that the capacity of the matched subcarrier over the greater side may be less than that of the corresponding subcarrier over the less side, and limit the capacity of the matched subcarrier pair. However, it is avoided in the suboptimal scheme by power reallocation at the greater side. Another result is that the capacities of optimal and suboptimal schemes are higher than that of other schemes. If there is no subcarrier matching, power allocation by water-filling algorithm decreases the system capacity, which can be obtained by comparing the capacity of

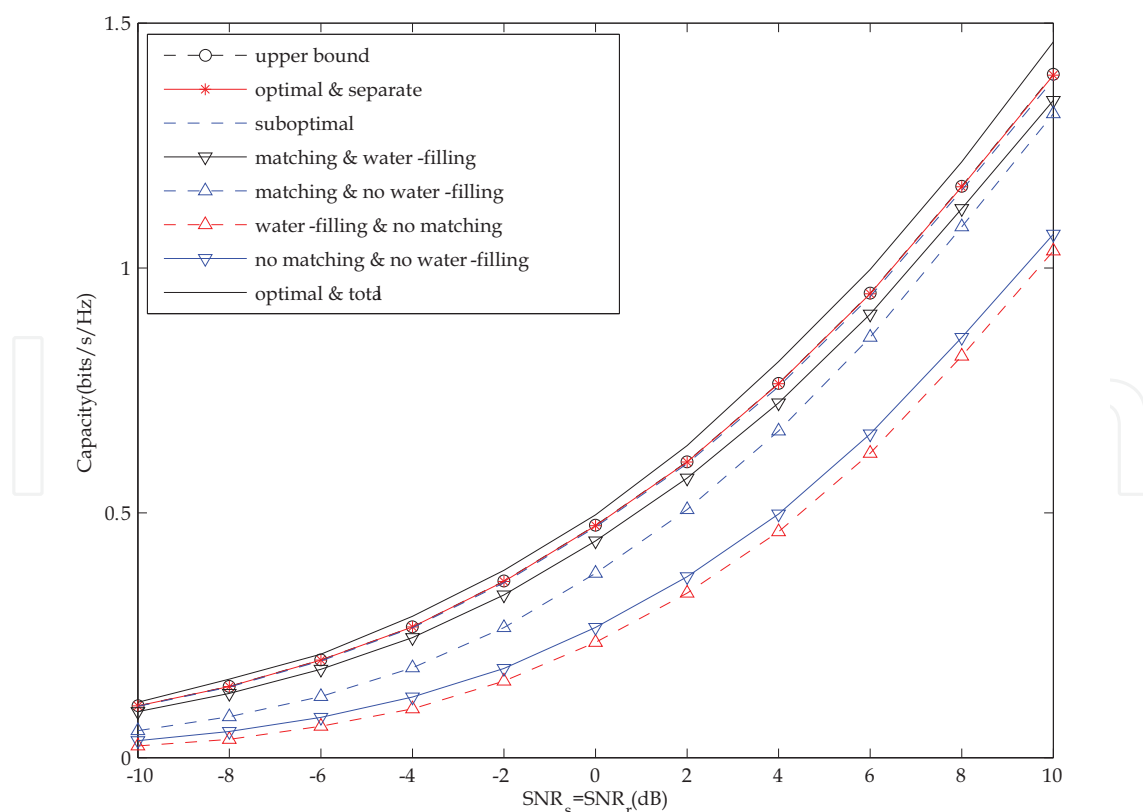

Fig. 4. Channel capacity against $SNR_s = SNR_r$ ($N = 16$)

scheme (i) to that of scheme (ii). The reason is that the water-filling can amplify the capacity imbalance between that of the subcarriers of matched subcarrier pair. For example, when a better subcarrier is matched to a worse subcarrier, the capacity of the matched subcarrier pair is greater than zero with equal power allocation. But the capacity may be zero with water-filling because the worse subcarrier may have no allocated power according to water-filling. The subcarrier matching can improve capacity by comparing the capacity of scheme (i) to that of scheme (iii). However, when only one method is permitted to be used to improve capacity, the subcarrier matching is preferred, which can be obtained by comparing the capacity of scheme (ii) to that of scheme (iii). When $SNR_s = SNR_r$, the capacity of optimal scheme with total power constraint is greater than that of optimal scheme with separate power constraints. Though $SNR_s = SNR_r$ in the system with separate power constraints, the different channel power gains of subcarriers can still lead to different capacities of the source-relay channel and the relay-destination channel. The less one will still limit the system capacity. When the system has the total power constraints, the power allocation can be always found to make the capacities of source-relay channel and relay-destination channel equal to each other. It can avoid the capacity imbalance between that of source-relay channel and relay-destination channel, and improve the system capacity.

The relation between the system capacity and SNR at the source is shown in Fig.5, where the SNR at the relay is constant. The SNR difference may be caused by the different distance at source-relay and relay-destination or different power constraint at the source and the relay. Here, for the system with separate power constraints, the capacity of optimal scheme is still almost equal to the upper bound of capacity and the capacity of suboptimal scheme is still close to that of optimal scheme. The greater is the SNR difference between the source and the relay, the smaller is the difference between the optimal scheme and suboptimal scheme. This proves that the suboptimal scheme is effective. The capacities of optimal and suboptimal schemes are still higher than that of other schemes. When the SNR difference is great between the source and the relay, the capacity of scheme (i) is close to the scheme (ii). It is because of the power allocation has less effect on the difference of subcarrier capacity. But, the subcarrier matching always can improve system capacity with any SNR difference between the source and the relay. It is also noted the capacity of optimal scheme with total power constraint is always improving with the SNR at the source. The reason is that total power be increased as the power at the source.

In order to evaluate the effect of the different power constraint at the source and the relay, the relations between the system capacity and SNR at the relay is also shown in Fig.6. Almost same results as those shown in the Fig.5 can be obtained by exchanging the role of SNR at the source and that at the relay. For the system with separate power constraints, the capacity of optimal scheme is still almost equal to the upper bound of system capacity and the capacity of suboptimal scheme is still close to that of optimal scheme. The greater is the SNR difference between the source and the relay, the smaller is the difference between the optimal scheme and suboptimal scheme. This prove that the suboptimal scheme is effective. The capacities of optimal and suboptimal schemes are still higher than that of other schemes. When the SNR difference is great between the source and the relay, the capacity of scheme (i) is close to the scheme (ii). It is because of the power allocation has little effect on the difference of subcarrier capacity with great SNR difference. But, the subcarrier matching can always increase system capacity with any SNR difference between the source and the

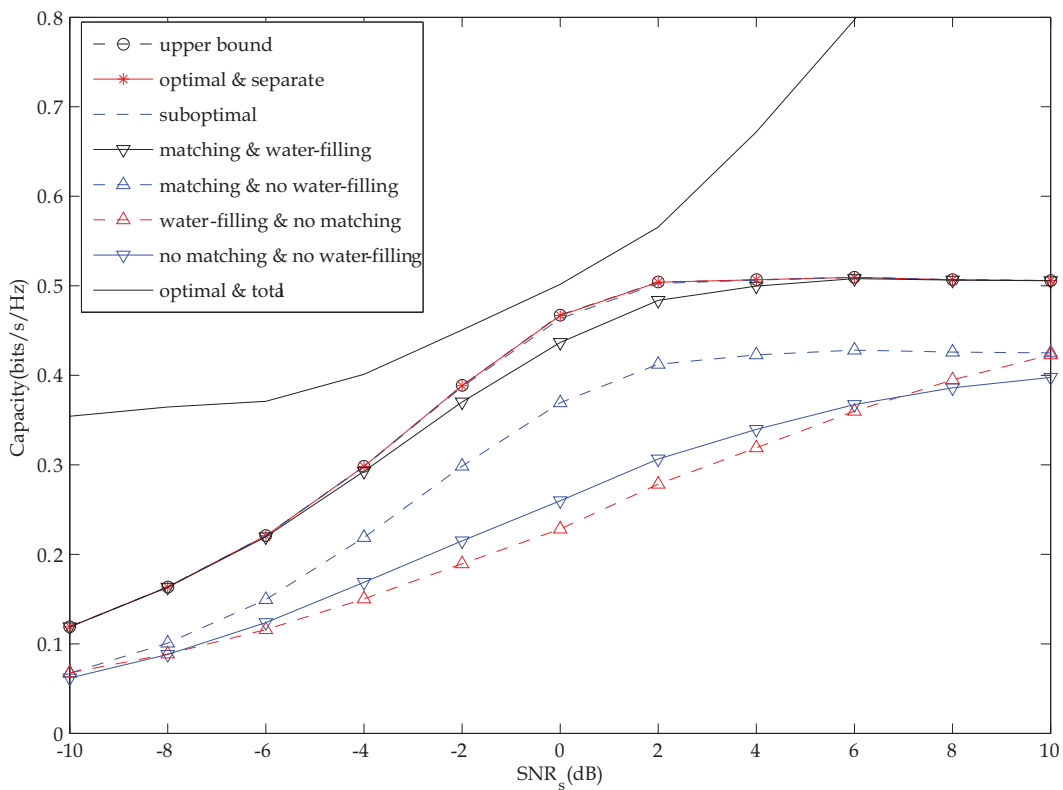

Fig. 5. Channel capacity against SNR_s ($SNR_r = 0dB, N = 16$)

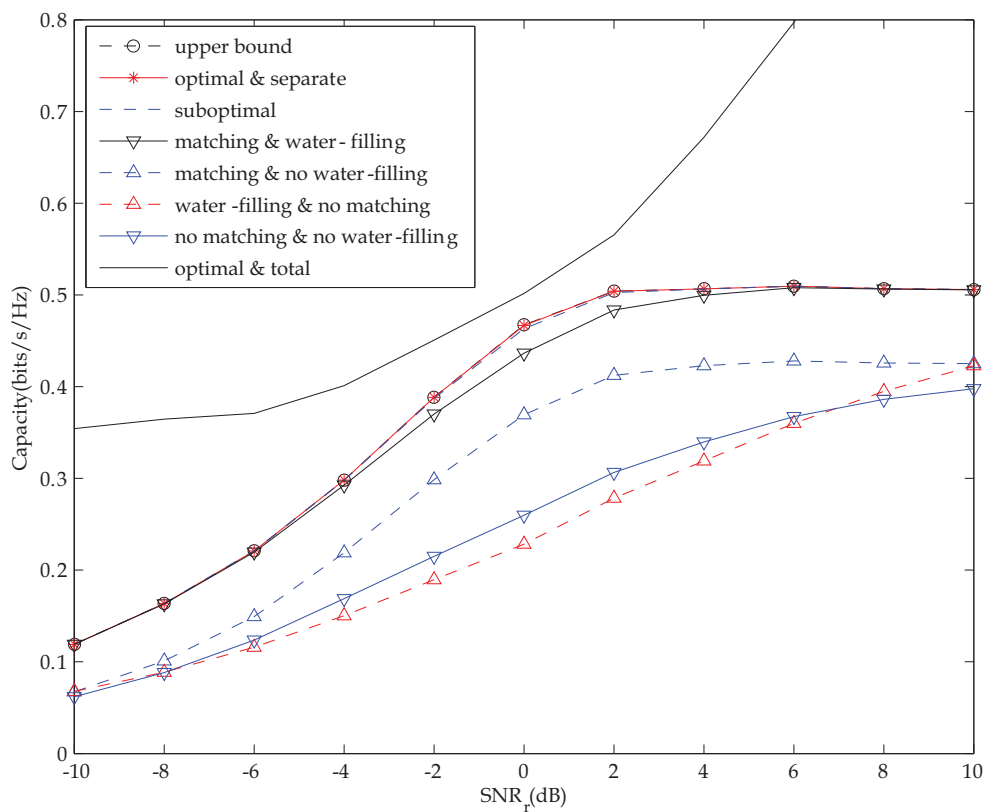

Fig. 6. Channel capacity against SNR_r ($SNR_s = 0dB, N = 16$)

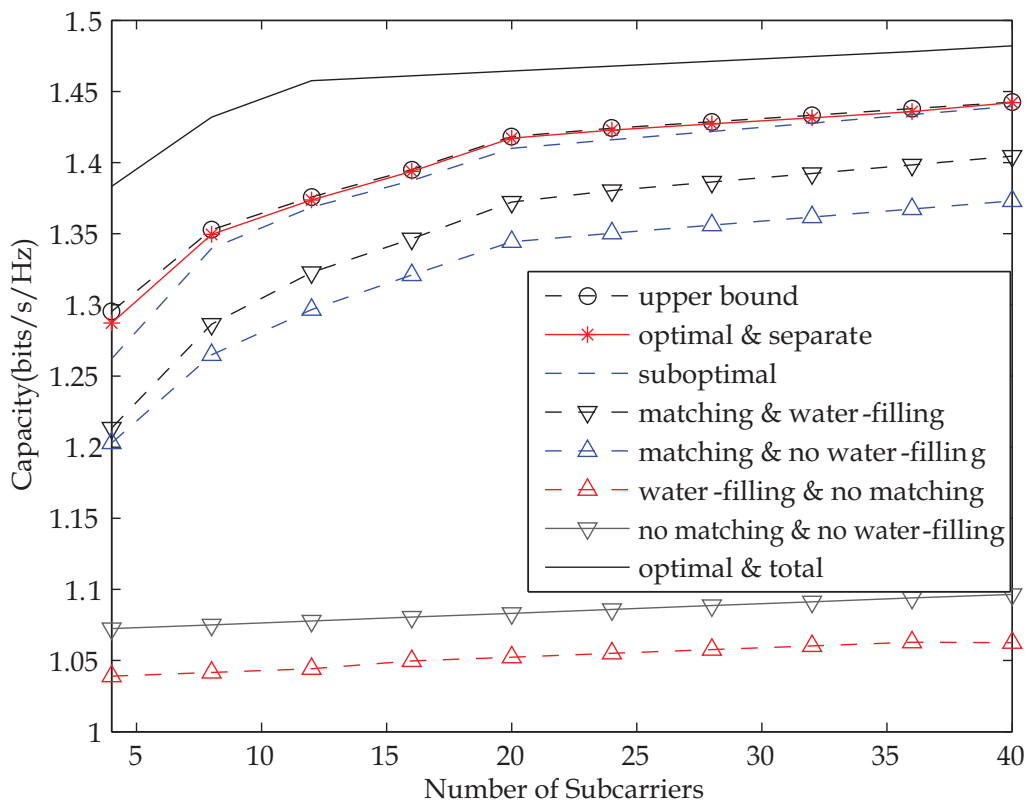

Fig. 7. Channel capacity against the number of subcarriers ($SNR_s = SNR_r = 10dB$)

relay. It is also noted the capacity of optimal scheme with total power constraint is always improved with increasing of the SNR at the source. The reason is that total power will be improved with the power at the relay. The similarity between the Fig. 5 and Fig. 6 proves that the power constraints at the source and the relay have similar effect on the system capacity. It is because that the system capacity will be limited by any less capacity between that of the source-relay channel and the relay-destination channel. When the any node has the less power, the corresponding capacity over the channel will be less than the other and limit the system capacity.

The relation between the system capacities and the number of subcarriers is shown in Fig.7, where the $SNR_s = SNR_r = 10dB$. According to the comparisons among the schemes, similar conclusions can be obtained. With the increasing of number of subcarriers, the system capacity is increasing slowly, which is because of the constant total bandwidth and SNR. For the any number of subcarriers, the capacity of *optimal & total* is greater than that of *optimal & separate*. For the total power constraint, the power can be allocated between the source and the relay, which can avoid the capacity imbalance between that of source-relay channel and relay-destination channel.

In conclusion, the capacity of optimal scheme is approximately equal to the upper bound of system capacity at any circumstance. Therefore, we can always simply the system architecture by only one-to-one subcarrier matching and careful power allocation.

5. Conclusion

The resource allocation problem has been discussed, i.e., joint subcarrier matching and power allocation, to maximize the system capacity for OFDM two-hop relay system. Though the

optimal joint subcarrier matching and power allocation problem is a binary mixed integer programming problem and prohibitive to find global optimum, the optimal joint subcarrier matching and power allocation schemes are provided by separating the subcarrier matching and power allocation. For the global optimum, the optimal subcarrier matching is to match subcarrier according to the channel power gains of subcarriers. The optimal power allocation for the optimal subcarrier matching can be obtained by solving a convex optimization problem. For the system with separate power constraints, the capacity of optimal scheme is almost close to the upper bound of system capacity, which prove that one-to-one subcarrier matching is approximately optimal. The simulations shows that the optimal schemes increase the system capacity by comparing them with several other schemes, where there is no subcarrier matching or power allocation.

6. References

- A. Sendonaris, E. Erkip and B. Aazhang (2003), "User cooperation diversity - Part I and II," *IEEE Transactions Communication*, vol. 51, no. 11, pp. 1927-1948.
- G. Kramer, M. Gastpar, P. Gupta(2006), "Cooperative strategies and capacity theorems for relay networks," *IEEE Transactions on Information Theory*, vol. 51, no. 9, pp. 3037-3063.
- J. N. Laneman, D. N. C. Tse, and G. W. Wornell (2004), "Cooperative diversity in wireless networks: efficient protocols and outage behavior," *IEEE Transactions on Information Theory*, vol. 50, no. 12, pp. 3062- 3080.
- N. Shastry and R. S. Adve (2005), "A theoretical analysis of cooperative diversity in wireless sensor networks," *IEEE Global Telecommunications Conference, GlobeCom'05*, vol. 6, pp. 3269-3273.
- S. Serbetli, A. Yener (2006), "Power Allocation and Hybrid Relaying Strategies for F/TDMA Ad Hoc Networks," *IEEE International Conference on Communications, ICC'06*, vol. 4, pp. 1562-1567.
- G. Li, J. Liu (2004), "On the capacity of broadband relay networks," *Proc. Asilomar Conf. on Signals, Systems and Computers*, pp. 1318-1322.
- H. Zhu, T. Himsoon, W. P. Siriwongpairat, K. J. R. Liu (2005), "Energy-efficient cooperative transmission over multiuser OFDM networks: who helps whom and how to cooperate," *IEEE Wireless Communications and Networking Conference, WCNC'05*, vol. 2, pp. 1030-1035.
- L. Dai, B. Gui and L. J. C., Jr. (2007), "Selective Relaying in OFDM multihop cooperative networks," *IEEE Wireless Communications and Networking Conference, WCNC '07*, pp. 963-968.
- M. Kaneko and P. Popovski. (2007), "Radio resource allocation algorithm for relay-aided cellular OFDMA system," *IEEE International Conference on Communications, ICC'07*, pp. 4831-4836.
- M. Herdin (2006), "A chunk based OFDM amplify-and-forward relaying scheme for 4G mobile radio systems," *IEEE International Conference on Communications, ICC'06*, pp. 4507 -4512.
- T. Cover, J. Thomas (1991), *Elements of Information Theory*, John Wiley & Sons, Inc., New York.

- B. Korte, J. Vygen (2002), *Combinatorial Optimization: Theory and Algorithms*, 3rd ed. New York: Springer-Verlag.
- I. Hammerstrom and A. Wittneben (2006), "On the Optimal Power Allocation for Nonregenerative OFDM Relay Links," *IEEE International Conference on Communications, ICC'06*, pp. 4463-4468.
- B. Gui and L. J. Cimini, Jr. (2008), "Bit Loading Algorithms for Cooperative OFDM Systems," *EURASIP Journal on Wireless Communications and Networking*, vol. 2008, Article ID 476797, 9 pages.
- Y. Ma, N. Yi, and R. Tafazolli (2008), "Bit and Power Loading for OFDM-Based Three-Node Relaying Communications," *IEEE Transactions on Signal Processing*, vol. 56, no. 7, pp. 3236-3247.
- S. -J. Kim, X. Wang, and M. Madhian (2008), "Optimal Resource Allocation in Multi-hop OFDMA Wireless Networks with Cooperative Relay," *IEEE Transactions on Wireless Communications*, vol. 7, no. 5, pp. 1833-1838.
- M. Pischella, and J. -C. Belfiore (2008), "Power Control in Distributed Cooperative OFDMA Cellular Networks," *IEEE Transactions on Wireless Communications*, vol. 7, no. 5, pp. 1900-1906.
- H. A. Suraweera, and J. Armstrong (2007), "Performance of OFDM-Based Dual-Hop Amplify-and- Forward Relaying," *IEEE Communications Letter*, vol. 11, no. 9, pp. 726-728.
- C. Athaudage, M. Saito, and J. Evans (2008), "Performance Analysis of Dual-Hop OFDM Relay Systems with Subcarrier Mapping, " *IEEE International Conference on Communications, ICC'08*.
- W. Wang, S. Yan, and S. Yang (2008). "Optimally Joint Subcarrier Matching and Power Allocation in OFDM Multihop System," *EURASIP Journal on Advances in Signal Processing*, vol. 2008, Article ID 241378, 8 pages.
- W. Wang, and R. Wu (2009). "Capacity Maximization for OFDM Two-Hop Relay System With Separate Constraints," *IEEE Transactions on Vehicular Technology*, vol. 58, no. 9, pp. 4943-4954.
- A. Pandharipande, and Chin K. Ho (2007). "Spectrum pool reassignment for a cognitive OFDM-based relay system," *2nd International Conference on Cognitive Radio Oriented Wireless Networks and Communications, CrownCom'2007*, pp. 90-94.
- A. Pandharipande, and Chin K. Ho (2008). "Spectrum pool reassignment for wireless multihop relay systems," *3rd International Conference on Cognitive Radio Oriented Wireless Networks and Communications, CrownCom'2008*, pp. 1-5.
- S. Boyd and L. Vanderberghe (2004), *Convex Optimization*. Cambridge, U.K.: Cambridge Univ. Press.
- D. P. Palomar and J. R. Fonollosa (2005), "Practical algorithms for a family of waterfilling solutions," *IEEE Transactions on Signal Processing*, vol. 53, no. 2, pp. 686-695.



Communications and Networking

Edited by Jun Peng

ISBN 978-953-307-114-5

Hard cover, 434 pages

Publisher Sciyo

Published online 28, September, 2010

Published in print edition September, 2010

This book "Communications and Networking" focuses on the issues at the lowest two layers of communications and networking and provides recent research results on some of these issues. In particular, it first introduces recent research results on many important issues at the physical layer and data link layer of communications and networking and then briefly shows some results on some other important topics such as security and the application of wireless networks. In summary, this book covers a wide range of interesting topics of communications and networking. The introductions, data, and references in this book will help the readers know more about this topic and help them explore this exciting and fast-evolving field.

How to reference

In order to correctly reference this scholarly work, feel free to copy and paste the following:

Wenyi Wang and Renbiao Wu (2010). Joint Subcarrier Matching and Power Allocation for OFDM Multihop System, Communications and Networking, Jun Peng (Ed.), ISBN: 978-953-307-114-5, InTech, Available from: <http://www.intechopen.com/books/communications-and-networking/joint-subcarrier-matching-and-power-allocation-for-ofdm-multihop-system>

INTECH
open science | open minds

InTech Europe

University Campus STeP Ri
Slavka Krautzeka 83/A
51000 Rijeka, Croatia
Phone: +385 (51) 770 447
Fax: +385 (51) 686 166
www.intechopen.com

InTech China

Unit 405, Office Block, Hotel Equatorial Shanghai
No.65, Yan An Road (West), Shanghai, 200040, China
中国上海市延安西路65号上海国际贵都大饭店办公楼405单元
Phone: +86-21-62489820
Fax: +86-21-62489821

© 2010 The Author(s). Licensee IntechOpen. This chapter is distributed under the terms of the [Creative Commons Attribution-NonCommercial-ShareAlike-3.0 License](#), which permits use, distribution and reproduction for non-commercial purposes, provided the original is properly cited and derivative works building on this content are distributed under the same license.

IntechOpen

IntechOpen