

# We are IntechOpen, the world's leading publisher of Open Access books Built by scientists, for scientists

**4,800**

Open access books available

**122,000**

International authors and editors

**135M**

Downloads

Our authors are among the

**154**

Countries delivered to

**TOP 1%**

most cited scientists

**12.2%**

Contributors from top 500 universities



**WEB OF SCIENCE™**

Selection of our books indexed in the Book Citation Index  
in Web of Science™ Core Collection (BKCI)

Interested in publishing with us?  
Contact [book.department@intechopen.com](mailto:book.department@intechopen.com)

Numbers displayed above are based on latest data collected.  
For more information visit [www.intechopen.com](http://www.intechopen.com)



# Panomorph Based Panoramic Vision Sensors

Simon Thibault  
*Laval University & ImmerVision  
Canada*

## 1. Introduction

During the last few years, innovative vision strategies to generate and control image mapping have been successful in producing high-resolution digital vision system. This success has, in turn, increased the interest in the high-resolution camera and absolute measurement with high-resolution larger and larger field of view. New generation of panoramic vision sensor includes multi-cameras, catadioptric panoramic lenses, panoramic annular lenses, fisheye lenses, anamorphic wide-angle attachments, and panomorph lenses. The increasing trend to use panoramic vision sensors in various applications is driven by the need to have complete information about our surrounding environment. Seeing of what surrounds a vehicle can directly increase our safety, providing hemispheric vision endoscopic functionality can provide a higher patient comfort and better surgeon procedure. Indeed, video and vision processing have become a growing technologies deployed in various applications. Increased integration of electronic and optical components and the declining prices of electronics in general are the primary enablers of this trend. This chapter presents the most recent advances in the panomorph vision sensor from the sky lens to the multi-task cameras.

A panomorph lens is a hemispheric wide-angle lens with enhanced resolution in a predefined zone of interest. Because panomorph lenses feature an optimal pixel-per-degree relationship, the resulting vision systems provide ideal area coverage, which in turn reduces and maximizes the processing. For example: a single panomorph sensor on the front of a vehicle could provide all the information necessary for assistance in crash avoidance, lane tracking, early warning alerts, parking aids, road sign and pedestrian detection, as well as various video monitoring views for difficult areas such as blind spots.

## 2. From the “Sky Lens” to the “Panomorph Lens”

It is well know that adding a large negative meniscus element mounted on the head of a compact positive component will create a system with a long back focal distance and a short focal length, which is namely a reversed telephoto (Kingslake, 1985). These lenses were very popular, since any lens used with a 35 mm camera had to have a back focal length of at least 35-40 mm to clear the rocking mirror on the camera. Consequently, any lens with a focal length of less than approximately 40 mm is a reversed telephoto type. Fortunately, this type is favourable for a wide-angle field of view. Wide-angle lenses are generally considered to be lenses with a field of view greater than 60 degrees.

However, for angles larger than 100 degrees, the barrel distortion becomes difficult to correct. With an extended field of view, the reversed telephoto lens will cover a hemispherical field -- we will call such lens a fisheye lens. This lens is not really an extension of a wide-angle lens. The fisheye lens has inherent large distortion, but this distortion should not be considered an aberration but rather the result of the projection of a hemispheric field on a circle, which is not possible *without* distortion.

The classical example of a fisheye lens “type” of image formation is an actual fish eye under water (Miyamoto, 1964). Robert W. Wood described in his book, *Physical Optics* (1911), a water-filled pinhole camera that was capable of simulating a fish’s view of the world (Figure 1A). Bond added a hemispheric lens with a pupil at the centre of the curvature in place of the water (Figure 1B). In 1924, Hill developed his Sky lens by adding a diverging meniscus lens (Figure 1C) before the hemispheric lens to improve the field curvature (thereby reducing the Peztlval sum). This lens was a first prototype of the modern fisheye lenses (Figure 1D) which was patented by Schultz (1932) and Merté (1935). Some 40 years later, the now famous afocal wide-angle door viewer was patented (Artonne, 2005).

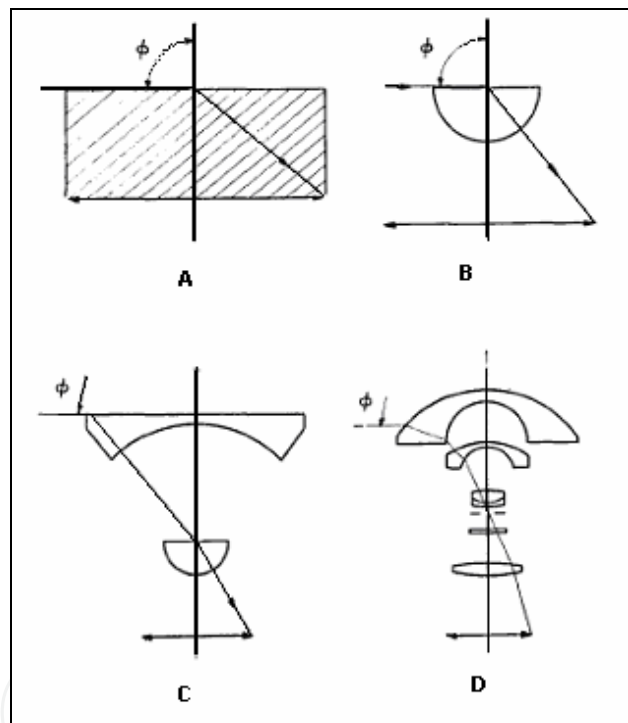

Fig. 1. Development of wide angle views (Miyamoto, 1964)

At that time a severe drawback was encountered when the fisheye was facing up or down, because in these positions the subject of interest might have appeared at the edge (large angle) of the field where the barrel distortion is very large. We will see later in this chapter how the modern high-resolution lens design can now control this distortion, to improve the field coverage of a panoramic lens and solve this historical concern.

Motivated by the need to record a distortion-free panoramic image, the flat cylinder perspective was born (Greguss, 1991). The panoramic feature is different from the fisheye in that there is no longer imaging of a hemispheric field onto a circle, but instead a 360° cylindrical field of view imaged onto a two-dimensional annular format (Figure 2). This kind of image will still suffer from severe image deformation. The annular image produced

by such a geometrical transformation will not produce (theoretically) radial distortion (cylinder height); however, the horizontal (circle circumference) direction will suffer from compression, from the edge to the centre of the image plane (see figure 4).



Fig. 2. Flat cylinder image

There are many known panoramic viewing optical arrangements that use this cylinder perspective. In particular, Greguss' patent was one of the most promising approaches (Greguss, 1986). The main disadvantages are the limited dimension of the annular image on the sensor and the blind zones above and below the device.

Another approach to getting a flat cylinder perspective is to rotate a conventional camera around the vertical axis. This technique requires several frames with proper synchronization for the camera to complete a full rotation. This method is useful and widely used today in the production of high-quality panoramic photography. The technique is time consuming because it requires a long time for the image acquisition and extensive image processing to stitch all the images together.

Ideally, the goal in panoramic imaging is to be able to capture the entire scene in a single image from a single camera. This ideal imaging system would allow more than one hemisphere to be visible, similar to some insects' vision system (Horridge, 1977) as figure 3. In reality, this can be achieved by using a multi-lens system with individual consecutive fields-of-view, totally covering a hemisphere. One of the major problems with this concept is the very complex image processing required, particularly on a moving platform.

Reflective optics offers an alternative to panoramic imaging. A standard camera placed below a convex mirror will image a large field-of-view, the properties of which will depend on the shape of the reflective surface (Chahl and Srinivasan, 1997). This approach has been used predominantly for producing panoramic TV displays. The projected images are captured by another equivalent optical arrangement (the reversibility property of light). For such an arrangement, the surface shape is not important as long as the projection mirror and the acquisition mirror are equivalent.

Systems with spherical and conical mirrors have been used to capture wide-angle images for robotics and machine vision devices (omnidirectional vision system). The mirror shape design is important and can provide a global image on the sensor, which presents a polar image with elevation and azimuth linearly distributed to radius and angle respectively.

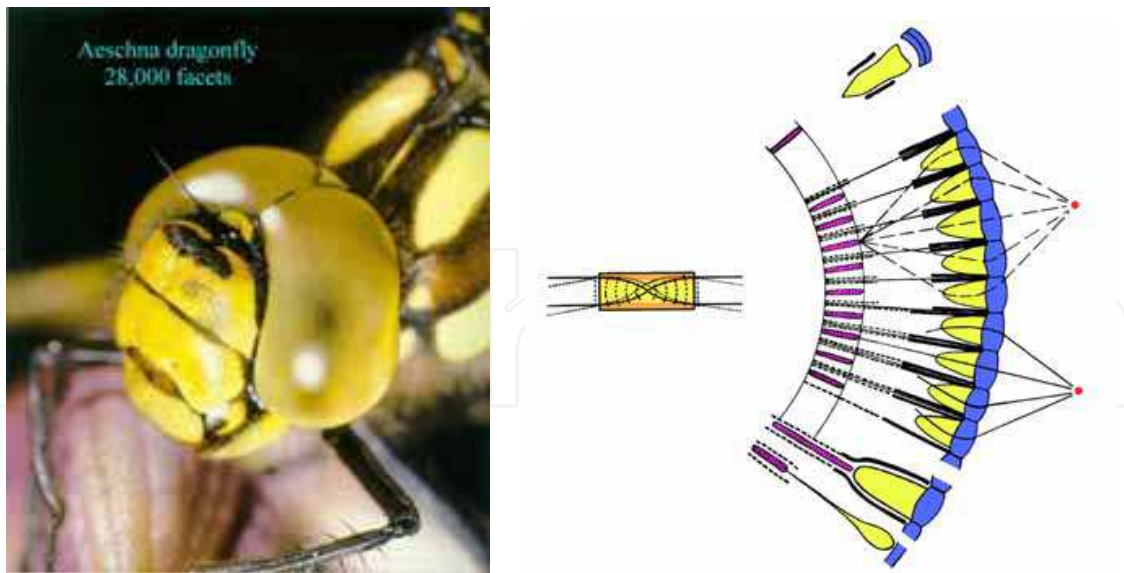

Fig. 3. Compound eye allow light to travel through several facts before striking the light sensitive surface.

These systems are called omnidirection camera. An omnidirectional camera (from omni, meaning all) is a camera with a 360-degree field of view in the horizontal plane (flat cylinder perspective), or with a visual field that covers (approximately) the entire sphere. Omnidirectional cameras are important in areas where large visual field coverage is needed, such as in panoramic photography and robotics. In robotics, omnidirectional cameras are frequently used for visual odometry that can be used for navigation. Visual odometry is the process of determining the position and orientation of a robot or a car by analyzing the associated camera images. It has been used in a wide variety of robotic applications, such as on the Mars Exploration Rovers.

Modern panoramic lenses are now able to add a distortion control which is considered a major enhancement in panoramic vision (Thibault, 2005). The distortion is not anymore a consequence of the panoramic vision that we have to manage but it can be used to increase the sensor performances. Specifically, the panoramic sensor can be designed to increase the number of pixels in the zones of interest (ZOI) using a distortion control approach. By controlling the distortion, we change the effective magnification of the sensor in the ZOI. Consequently, the sensor can be custom-designed to meet real and very specific needs required by a specific application.

The Panomorph lens uses this distortion control approach and an anamorphic image mapping to provide a unique full hemispheric field coverage. In contrast to other types of panoramic imagers that suffer from blind zone (catadioptric cameras), low-image numerical aperture and high distortion, the Panomorph lens uses distortion as a design parameter, in order to provide a high-resolution coverage where it is needed. It also features an anamorphic image mapping of the full hemispheric field, which produces an ellipse image footprint rather than a circle (or annular footprint) as do all other types of panoramic imagers. This feature provides an immediate 30% gain in pixels used on the sensor (the ellipse footprint matches the 4:3 ratio of a standard CCD or CMOS imager). The combination of distortion control and anamorphic design provides an important gain in resolution, and an advantage over all other types of panoramic imagers. The figure 4 shows the panoramic lens evolution over the last 30 years. Each panoramic image falls on the same sensor size from the same scene. The Panomorph lens image (right), clearly covers a larger area on the sensor.



Fig. 4. Panoramic Lens Evolution

### 3. Panomorph lens theoretical background

**Panomorph** (from the Greek word **pan** meaning *all*, **horama** meaning *view*, and **morph** meaning *form*) lens is a particular type of panoramic lens. It features two important parameters, the amount and location of the resolution within the panoramic field of view.

The human eye could be the most common panomorph device. Indeed, with its field of view close to  $180^\circ$ , we can classify the human eye as a very wide angle imager. Furthermore, the visual acuity is not linear across the field of view.

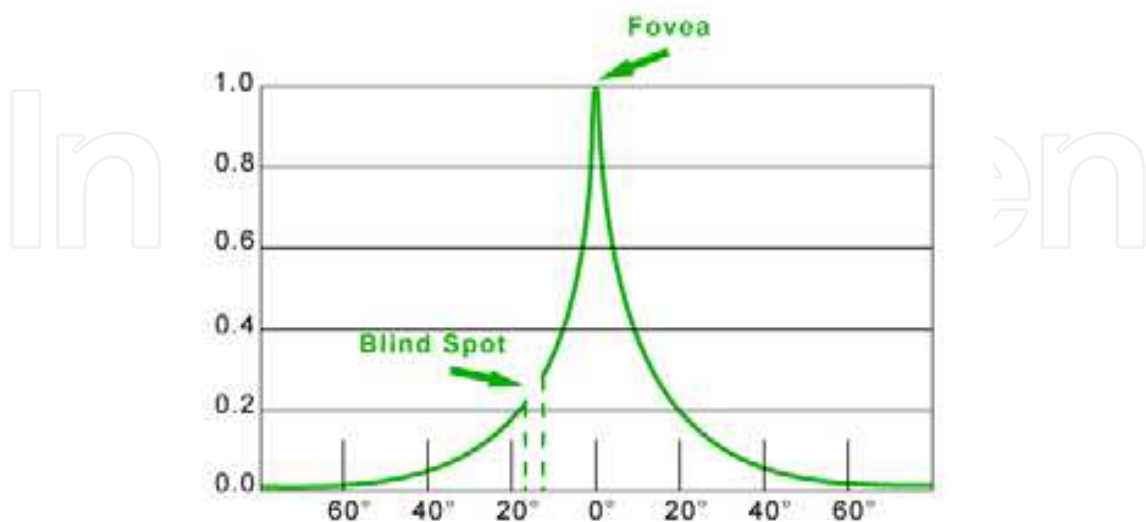

Fig. 5. The relative acuity of the right human eye (horizontal section) in degrees from the fovea

Natural evolution shaped the human eye to provide a higher visual acuity where needed. The fovea located in the center of the macula region of the retina sees only the central two degrees of the visual field but takes up over 50% of the visual cortex. The fovea is an augmented resolution (Ross 2006) area in the middle of the field of view.

As opposed to human eyes, in the case of a panomorph lens, the resolution is directly related to the lens magnification and not the variable sensor pixel size. The magnification variation across the field of view can be described by the distortion function or by the relation between the hemispheric field of view projected into the sensor plane.

The following figure shows different images capture by different panomorph lenses which have various resolution distribution within the field of view. In each case, the original scene is the same, only the location of the augmented resolution is different ranging from the center to the edge of the field of view.



Fig. 6. Resolution zone by zone - Examples

### 3.1 Hemispheric field of view projected into a plane

A panoramic lens has inherent distortion, however this distortion should not be considered as an aberration but as a result of projection of a hemisphere on a plane. Consider the angle of incidence  $\theta$  (in radian) of a light coming from an object at a long distances, the coordinates in the image plane of the image will be  $(u,v)$ . The lens will image the objet has a function of the angle  $\theta$ . This function can be linear but not necessarily ( $u=v= \text{constant} \times \theta$  for

an ideal fisheye). In the case of a panomorph lens, the relation between  $u$  and  $v$  is proportional to the anamorphic ratio but a polynôme within  $\theta$ . The variation across the field of view ( $\theta$ ) is the main advantageous of the panomorph lens. The derivative of  $u$  or  $v$  with respect to  $\theta$  is the lens resolution. For a fisheye, the resolution is constant (ideal fisheye) but for a panomorph lens, the resolution is also a polynomial function with  $\theta$ .

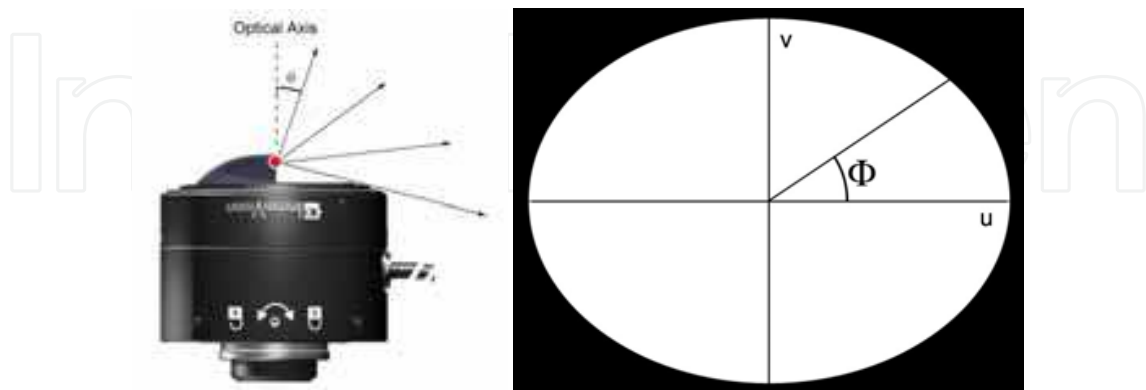

Fig. 7. Image Formation.

### 3.2 Panomorph image projection model

To be effective, the panoramic video-viewing library corrects image distortion from cameras equipped with a panomorph lens for display and control of one or more standard views, such as a PTZ (Figure 8) in real time. The viewing library allows simultaneous display of as many views as desired from one or more cameras (Figure 9).

Consequently, the viewing process must unwrap the image in real time in order to provide views that reproduce real world proportions and geometrical information. The algorithms can be customized and adapted for each specific application, which is then related to human vision (display) or artificial vision (analytic function).

The viewing process can be decomposed into three main steps:

- the definition of the panomorph geometrical model (PGM) associated to each custom panomorph lens application;
- the projection of the recorded image onto the PGM to provide a discretized mapping based on the recorded pixel position on the sensor;
- finally, the rendering, which uses well-known standard rendering techniques.



Fig. 8. Real-time distortion-free display (left: original image produced by the panomorph lens).





Fig. 9. Four PTZ views (left), and two strips to display a 360° total camera surround in one single view (right).

The image produced by each panomorph lens is unique to its application. The image mapping can be defined by a unique 3D geometrical model (Panomorph Geometrical Model, or PGM), which reproduces the panomorph lens design characteristics.

The PGM is a geometric representation (surface) of the relative magnification of the lens as a function of the angles, expressed in spherical or polar coordinates ( $R, \theta, \phi$ ). In other words, if the surface is represented by vector  $R$ , the length of the vector is proportional to the lens magnification (resolution) in the direction defined by the polar angles. This model depends on lens parameters such as the anamorphic ratio, the field of view, as well as position, size, and the magnification in the zones of interest.

The PGM is a mathematical transformation of the image footprint  $I(u,v)$  into a surface  $S(R, \theta, \phi)$  representation using spherical coordinates:

$$I(u,v) \rightarrow S(R,\theta,\phi), \quad (1)$$

The anamorphic ratio is used only as a scale factor, which is function of the angle  $\phi$  (Figure 10) This angle defines the azimuth direction of the recorded image taken by the panomorph lens.

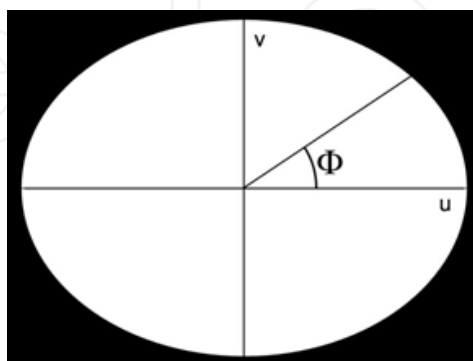

Fig. 10. Panomorph elliptical footprint  $I(u,v)$ ; scaling defined with  $\phi$  angle.

The field of view, or FOV, determines the angular limit (theta) of the PGM. The FOV of the panomorph lens is about 180 degrees and can be more or less, depending on the application. Figure 11 shows two schematic PGMs with 180 degree and 250 degree FOVs respectively.

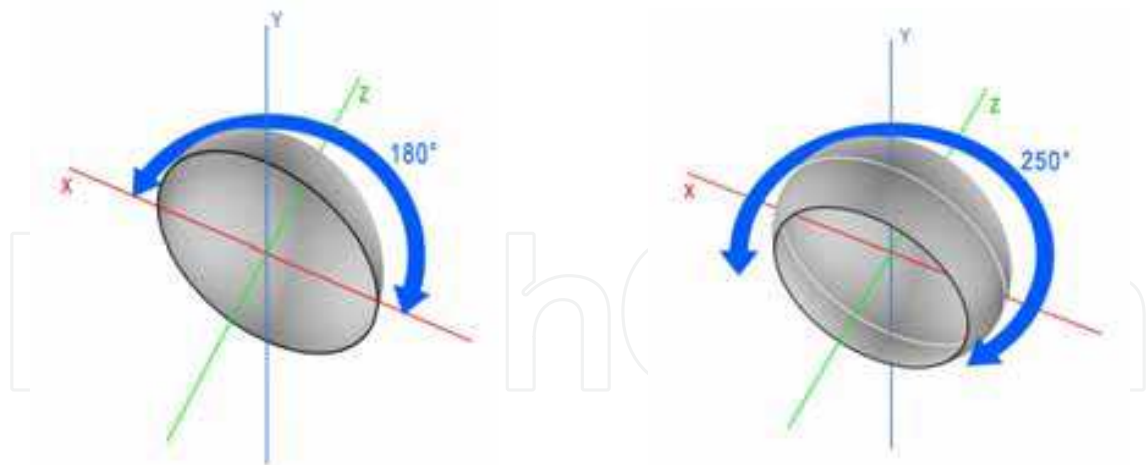

Fig. 11. PGM with 180 and 250 degree FOVs respectively.

The panomorph lens uses distortion or resolution as a design parameter, in order to provide high-resolution coverage in a specific zone of interest. In other words, the FOV can be divided into different zones, each with a defined resolution as discussed in the next section. To illustrate the impact of the distortion profile on the PGM, we will study two examples. In these examples, the FOV is 180 degrees wide, the zone of interest is 30 degrees wide, and the resolution is two times greater in the zone of interest than it is in the rest of the FOV (2:1). From one example to another, only the position of the zone of interest changes.

#### Example 1:

The first example is based on the design of a front view camera (Figure 12). In this case, the zone of interest is the central part of the image, even though the entire 180-degree FOV is still recorded. A panomorph lens with this feature can be used on a cell phone (for video conferencing) or on an ATM surveillance camera.

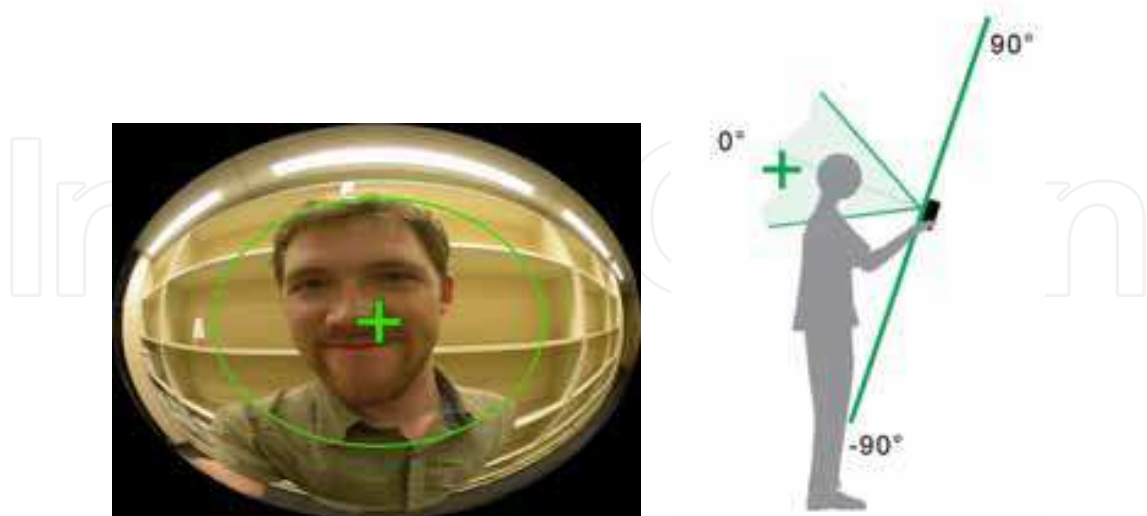

Fig. 12. Panomorph lens for a front-view camera.

The panomorph lens resolution in the central zone is twice that of the resolution in the periphery. Figure 13 shows the image footprint with the proper resolution for each zone. On the left of Figure 13, we have a Cartesian plot of the resolution as a function of the view

angle (defined from the centre). We note that a transition zone exists between the central and the periphery areas. Theoretically, this transition can be very small, but as the panomorph lens is a real product, this transition can extend over 10 degrees.

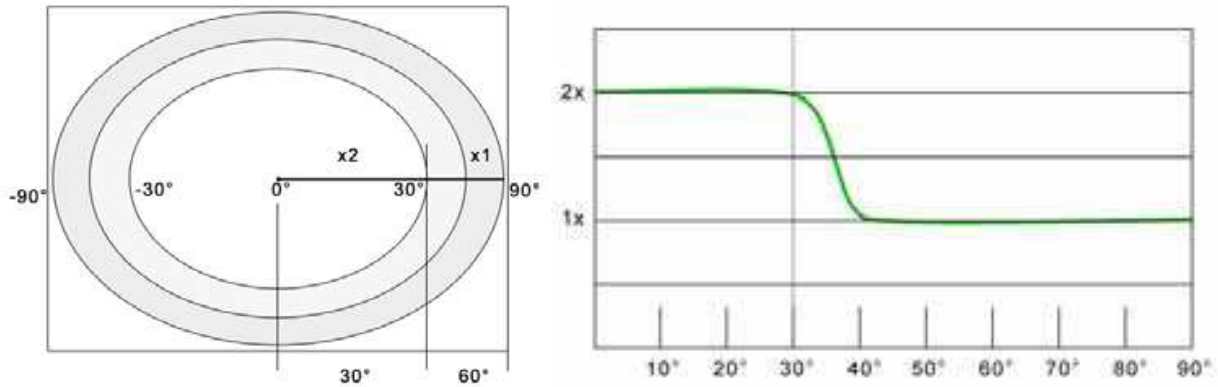

Fig. 13. Image footprint (left) and resolution graph (right) for the front-view panomorph lens.

As defined, the PGM in the polar coordinate space represents the resolution of the panomorph lens, or a surface in space where the spatial resolution is constant in terms of azimuthal ( $\theta$ ) direction. Mathematically, it means that the Cartesian graph (Figure 13, right side) is transposed into the spherical coordinate plane. Figure 14 shows the 3D PGM representation.

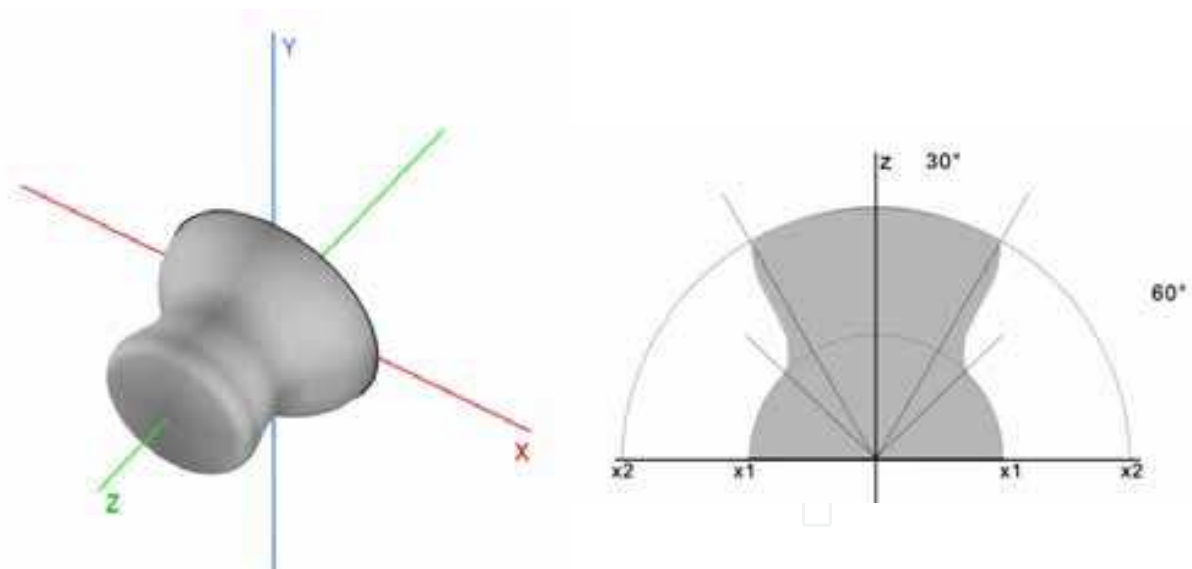

Fig. 14. 3D PGM (left), 2D view in Y-Z plane.

#### Example 2:

The second example demonstrates a panomorph lens optimized for video conferencing, where the zone of interest is not in the centre but on the edge of the field of view. Figures 15, 16 and 17 show the image footprint, the resolution and the corresponding PGM respectively.

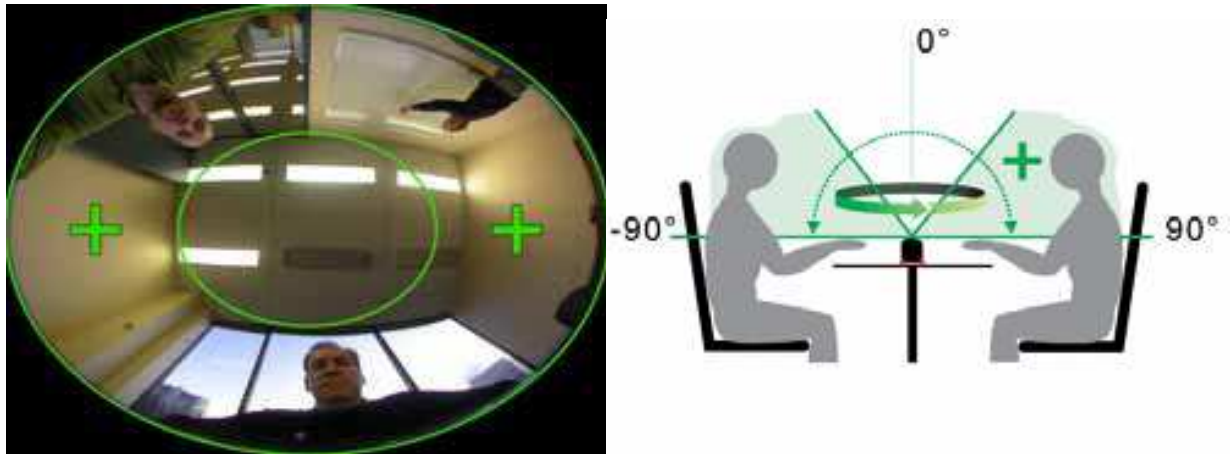

Fig. 15. Panomorph lens for video conferencing.

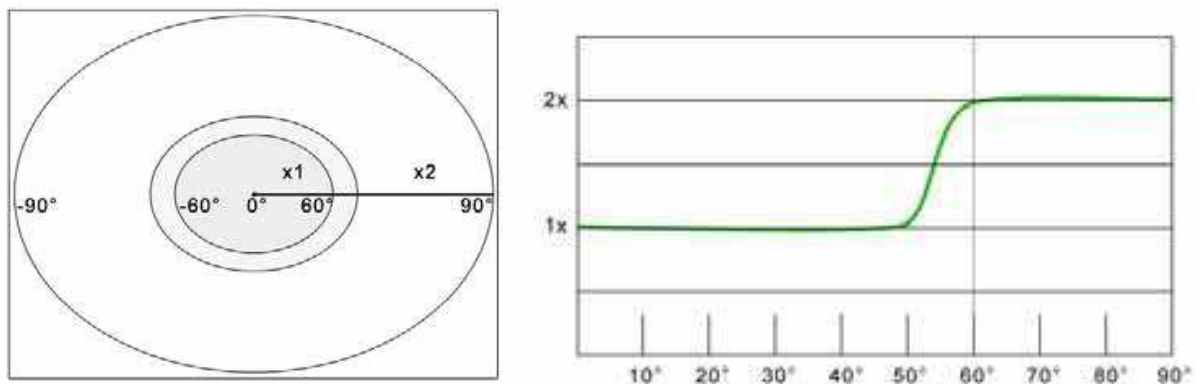

Fig. 16. Image footprint (left) and resolution graph (right) for the video-conferencing panomorph lens.

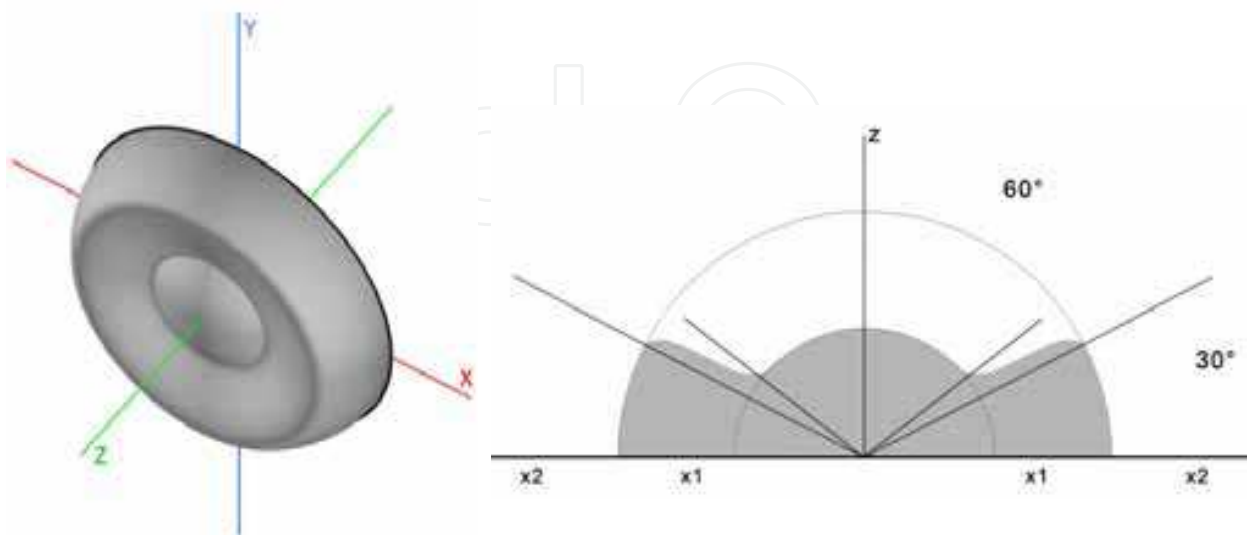

Fig. 17. 3D PGM (left), 2D view in Y-Z plane (right).

The panomorph lens can be used with any sensor format (VGA, XGA, etc.) as long as the lens performance matches the Nyquist frequency of the sensor. The number of pixels will have an impact on the discretization of the model for the PGM. Up until now, the PGM has been defined by a continuous mathematical surface, however, on sensor we have a finite number of pixels.

The continuous PGM will be sampled by the pixels. The number of pixels required to map the entire surface of the PGM is equal to the number of pixels on the sensor. Figure 18 shows a 2D sampling of the PGM using only 22 elements. You should note that the pixel dimension is constant over the entire PGM, and the pixels are always perpendicular to the direction of regard (direction of the vector  $R$ ). With a higher number of pixels, the discrete PGM will be closer to the continuous PGM, as shown in Figure 19.

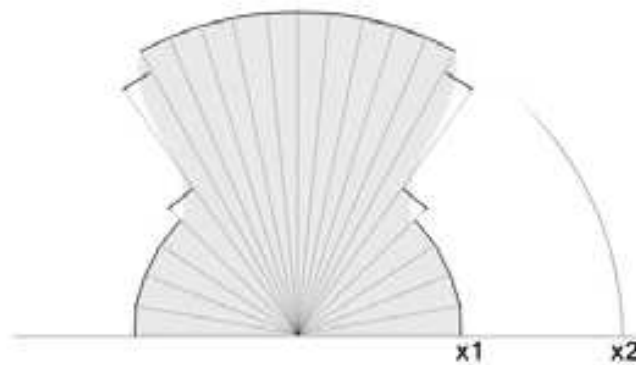

Fig. 18. Discrete PGM with 22-unit (pixels) sample

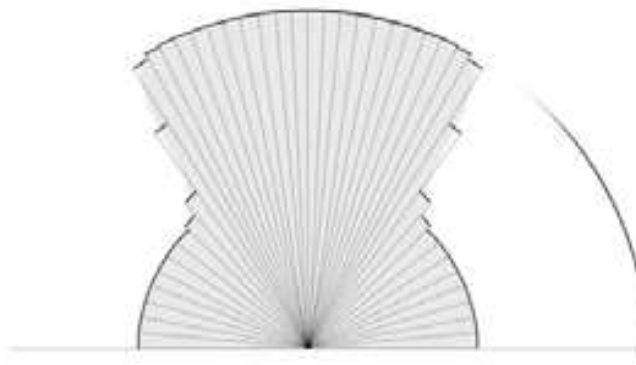

Fig. 19. Discrete PGM with 44-unit (pixels) sample

The image  $I(u,v)$  from the panomorph lens is projected onto the PGM, as shown in Figures 18 and 19. The final result is a discrete surface. The PGM is mapped with the panomorph image and can then be viewed using any classical 3D visualization techniques.

Each pixel of the panomorph image is projected onto a discrete element of the PGM. The pixel position in the 3D space (on the surface) represents the real object position in the recorded scene. The projection uses the adapted azimuthal projection technique (see *MathWorld*-A Wolfram Web Resource) with anamorphosis and distortion parameters added.

The final goal is to visualize the recorded scene without distortion. The PGM can be used to achieve this goal using a standard algorithm (Horaud & Monga, 1995). A virtual camera is

placed at the central position (0,0,0). Viewing the scene with this virtual camera requires first selecting the angle ( $\theta, \phi$ ) of viewing direction. Figure 20 shows two cameras pointing in two different directions. The camera pointed at the centre of the PGM will show a total of four elements (1D, 16 elements in 2D). The camera pointed at the edge of the PGM will show only two elements. This is the distortion effect. The resolution is twice in the centre than it is on the edge. A zoom can also be applied to change the  $\Delta\theta$  and provide virtual functionalities.

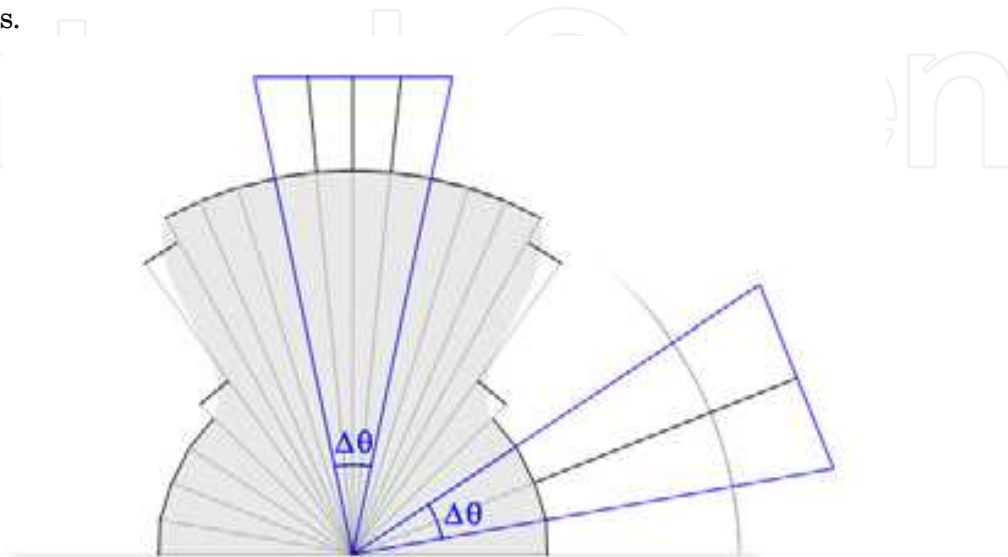

Fig. 20. Virtual camera at the centre of the mapped PGM

The following Figure 21 shows the final projection on a 2D plane of each virtual view. This 2D view can be sent to a display monitor.

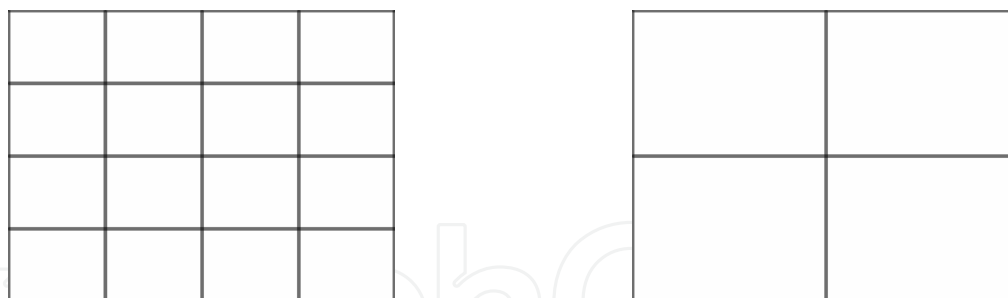

Fig. 21. Viewing pixel as a function of the pointing direction of the virtual camera (left = centre, right = edge).

### 3.3 Panomorph lens resolutions

As shown in the last section, an efficient panomorph lens, the coverage area is divided into different zones. A specific resolution requirement as well as a particular field of view is defined for each individual zone. Figure 1 shows a typical surveillance scenario.

For this particular scenario, the panoramic coverage area is divided into five adjacent and continuous zones. Zones B and C are symmetrical with the vertical axis. The five adjacent zones, while still providing full hemispheric coverage together, each feature a different resolution requirement, as the most significant objects are in Zone B. (Zone B in a surveillance application enables facial recognition and identification.) An object in Zone B is

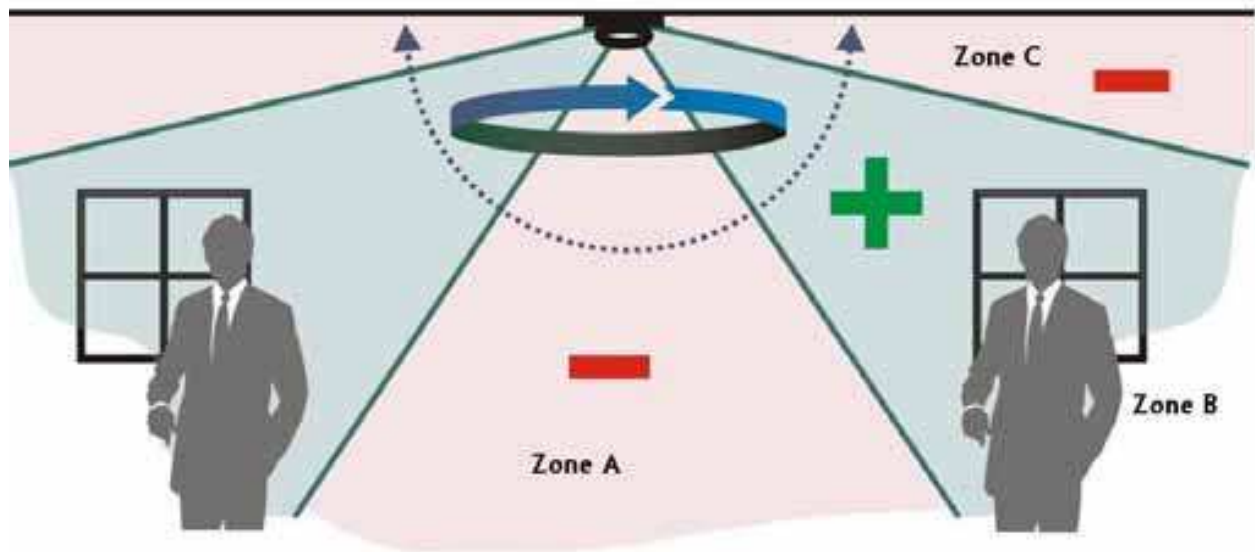

Fig. 22. Specific security zones.

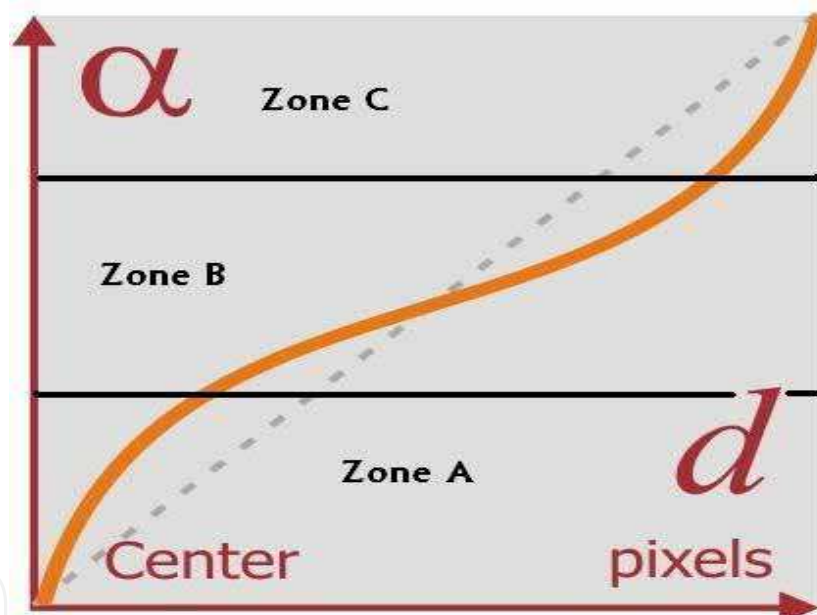

Fig. 23. The ideal FOV ( $\alpha$ ) vs. the position ( $d$ ) on the sensor for the scenario presented in Figure 22.

also more distant from the camera than an object in Zone A. This means that the relative angular resolution (pixels/ degree) in Zones A and B should be different.

For example: A human face in Zone B (located at 60 degrees from the vertical axis) will subtend an angle by half the amount that it would in Zone A (above the camera). To get the same number of pixels per face in both Zones A and B, the pixels/ degree in Zone B must be twice the pixels/ degree in Zone A. This means that the number of pixels required on the sensor to image Zone B is twice the number of pixels required to image Zone A.

It is difficult to evaluate the exact resolution as a function of the sensor, because this would depend on the resolution chosen for the zone of interest. However, if we define  $i$  zones (1 to

n) where each zone covers an angle ( $\theta_i$ , up to  $\theta_{\max}$ ) with a number of pixels ( $N_i$ , #pixels is the number of pixel used on the sensor) we can describe the resolution ( $R_i$ ) for each zone:

$$R_i = \frac{N_i}{\theta_i} \quad (2)$$

with the following limit conditions:

$$\sum_{i=1}^n N_i = \sum_{i=1}^n R_i \cdot \theta_i = \# \text{ pixels} \quad (3)$$

and

$$\sum_{i=1}^n \theta_i = \theta_{\max} \quad (4)$$

showing that if you increase the resolution in the  $i$  zone, the result is less resolution in the other zones. The figure 24 and 25 show a graphical view of the process. In real system, a transition zone exists to connect but zone A-B and B-C. Consequently, these zones should also be considered within the calculation.

#### 4. Panomorph based vision sensor - examples

As a new technologie, the design of a Panomorph based visual sensor requires particular attention. The following section shows a number of examples that illustrated how the panomorph vision sensor can be used in various applications. These examples can also be considered as starting point to design any custom applications.

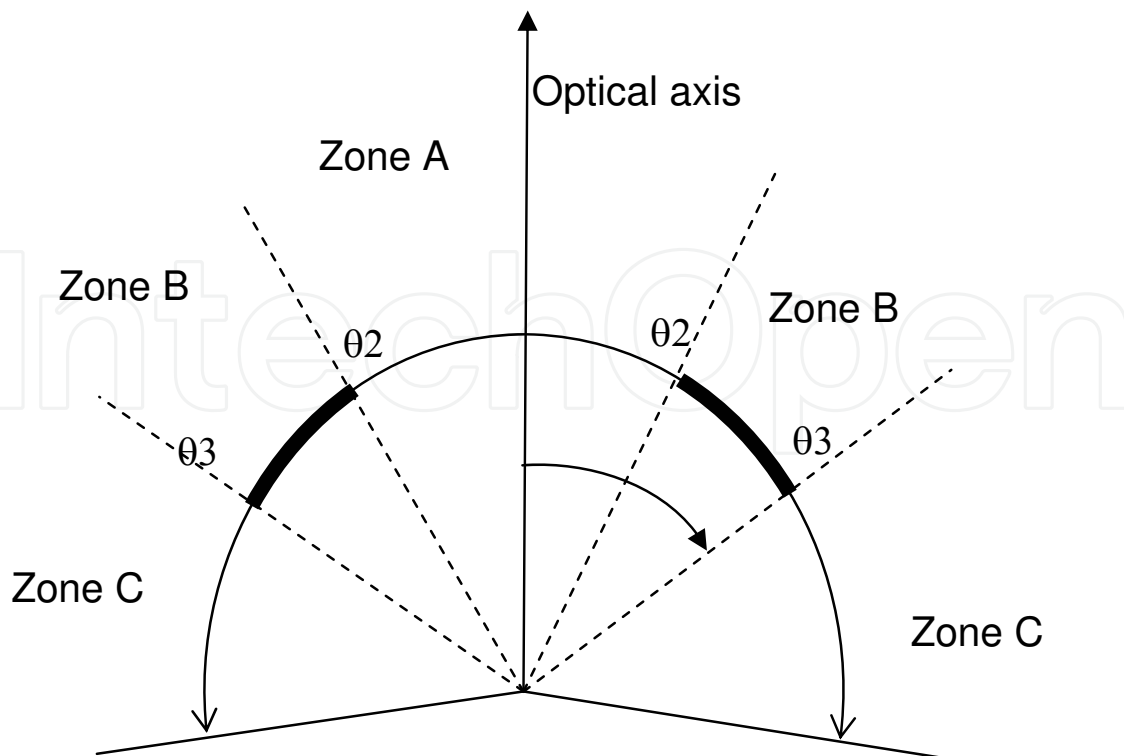

Fig. 24. Zone definition



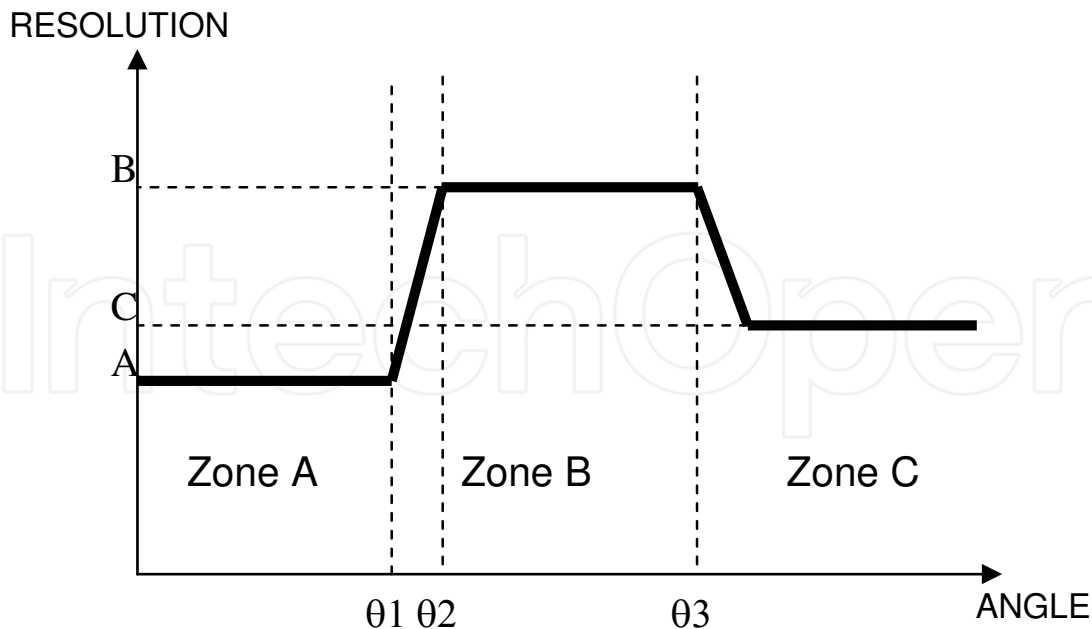

Fig. 25. Resolution graph per zone

#### 4.1 Surveillance & security applications

The security application is probably to most important up to now for the panomorph technology. To illustrate an application, we can base the panomorph lens resolution requirement on the detection range. The detection range is a function of the number of pixels on the target used to recognize, identify or detect. Based on Figure 22, we define the range detection vertically (height of the people). Range detection can also be defined as the number of horizontal pixels on the target (width). This last definition uses the number of pixels on a circumference at a given angle to define, for a given FOV angle, the detection range. Because the number of pixels on the perimeter of an ellipse is larger than on the circumference of a circle, the detection range for horizontal detection is also always larger when using a Panomorph lens.

In order to understand the detection range we will further develop this example. We want to define the distance from which the face of a human body might have at least 30 pixels per dimension. Using simple mathematical expressions we can calculate this distance for each FOV angle. The distances then define a surface that is illustrated in Figure 26 for a 360 KPx CCD sensor (NTSC).

This example shows how a well designed Panomorph lens can provide a facial recognition range as far as 3 meters away from the camera (3 m calculated on the floor for a 30 pixel/ face resolution). This means an extended range for detecting, identifying and recognizing a target. This extended range also provides an extended coverage rate for following the target. The red circle marks the detection area, which has a constant pixel to angle function similar to a fisheye lens.

Defining the resolution requirements for surveillance systems is not necessarily a simple task. A rough indication of the practical meaning of resolution can be defined from the following correlation between the resolution criteria and pixels on the sensor (Johnson's criteria) (Johnson, 1958).

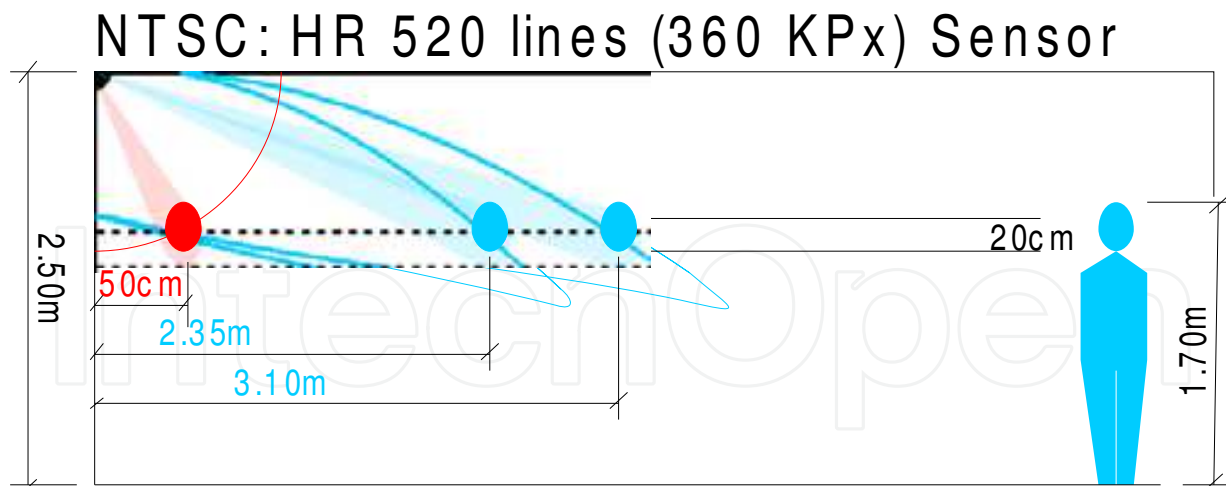

Fig. 26. Detection range (30 pixels/ dimension). The red curve (constant) corresponds to a lens with a constant resolution on this sensor. The blue curves correspond to a Panomorph lens axis (two curves for long and short axis).

The criteria usually used are:

Detection	2 pixels per target
Orientation	3 pixels per target
Aim	5 pixels per target
Recognition	8 pixels per target
Identification	12-16 pixels per target
Recognition with 50% accuracy	15 pixels per target
Recognition with 90% accuracy	24 pixels per target

#### 4.2 Automotive

The increasing trend to use vision sensors in transportation is driven both by legislation and consumer demands for higher safety and better driving experiences. Awareness of what surrounds an automotive vehicle can directly affect the safe driving and maneuvering of that vehicle. Consequently, panoramic 360° imaging is becoming an industry prerequisite. However, to obtain a complete view of the area around a vehicle, several sensor systems are necessary. This section presents how panomorph based vision sensor can satisfy the needs of various vision applications with only one sensor or panomorph lens configuration.

Consider the simplified situation of a camera flush-mounted on the front of a vehicle. The goal of this section is to determine the appropriate parameters of the panomorph lens and the projection (un-warping) algorithms which correspond to the application requirements.

Lens and algorithm parameters to be determined:

- Field-of-view (FoV) of the application
- Lens distortion, anamorphosis ratio and resolution
- Lens mathematical model and calibration
- Software projection type, treatment and performance

Applications requirements:

- Lane departure and lane curvature recognition:

- Large FoV: Larger than 180° to increase the robustness of line tracking
- Projection algorithms to rectify the image and provide a straight line for recognition
- Collision warning using vehicle detection:
  - Large FoV to detect oncoming vehicles from all sides of a road intersection
  - 2-meter vehicle width must cover 10 to 40 pixels wide
- Road sign detection and recognition:
  - Large FoV to detect road signs at different locations
  - 0.5-meter sign width must cover 12 to 24 pixels wide
- Blind zone avoidance:
  - Large FoV: Larger than 180° to avoid blind zones
  - Projection algorithms to rectify the image and provide a user-friendly view to the driver

A collision warning application needs to have at least 10 pixels to define a two-meter wide object (vehicle). As defined by Thibault (Thibault, 2007), a fisheye lens is 5.04 pixels/ degree on the targeted sensor (1280\*960) over the entire FoV.

$$\alpha = \frac{Size_p}{Res_{p/o}} \quad (5)$$

Where  $Size_p$  is the object size on the sensor in pixels, and  $Res_{p/o}$  is the resolution of the system lens-sensor in pixels/ degree: A 10-pixel object represents a  $\alpha=1.98^\circ$  FoV and a 40-pixel object represents a  $\alpha=7.9$  FoV.

$$d = \frac{Size_m}{Tan(\alpha)} \quad (6)$$

Where  $Size_m$  is the object size in meters: A 10-pixel object is  $d=57.8$  meters from the car. This means that a two-meter wide object will illuminate 10 pixels or more when the objects are within 57.8 meters.

With a panomorph lens, we can customize the distortion mapping to provide better resolution where required. Based on Figure 27, we define three zones of interest in the horizontal plane. The first area of interest in which we would like to increase resolution is the forward view.

For a collision warning application, there is a need to see farther on both sides when crossing an intersection. One needs also to see farther right in the middle, to detect a vehicle in the same lane. Figure 27 shows the resulting areas of interest over the entire FoV. The resolution of this type of lens is 8.42 pixels/ degree on the targeted sensor within the zone of interest (Thibault, 2007). Using formulas (5) and (6), a 10-pixel object would be 97 meters from the car, a 70% increase compared to a theoretical fisheye lens within the same area of interest.

The safe distance between two vehicles is based on the driver's reaction time; some governments have determined that this reaction time is at least the distance travelled during two seconds. We can deduce the following formula:

$$ds_{meter} = 0.56 \times V_{km/h} \quad (7)$$

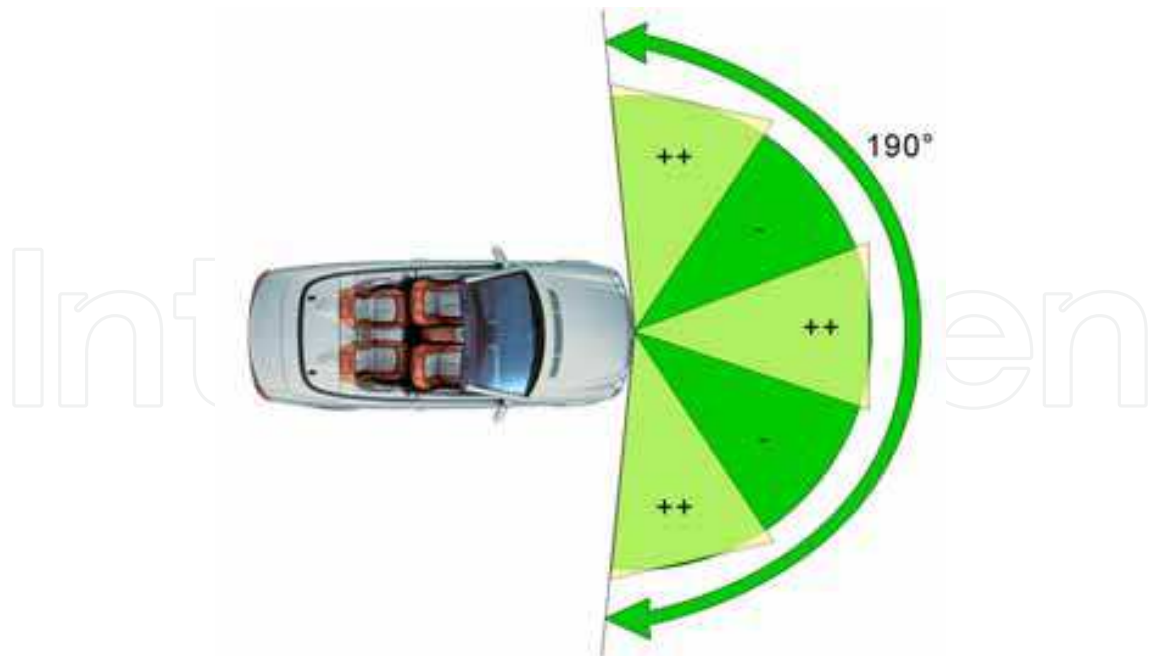

Fig. 27. Augmented-resolution areas of interest for a panomorph front view lens.

Speed	50 km/ h	70 km/ h	90 km/ h	110 km/ h	130 km/ h
Safe distance	28 m	39 m	50 m	62 m	73 m

Table 1. Safe distance between two vehicles at conventional speed limits

Road sign detection and recognition applications need to have at least 12 pixels to define road signs of widths from one meter up to 1.5 meters.

With a fisheye lens, using formulas (5) and (6):

- For a one-meter wide road sign, a 12-pixel object is 24 meters from the car and a 24-pixel object is 12 meters from the car.
- For a 1.5-meter wide road sign, a 12-pixel object is 36 meters from the car and a 24-pixel object is 18 meters from the car.

With a panomorph lens, using formulas (5) and (6):

- For a one-meter wide road sign, a 12-pixel object is 40 meters from the car and a 24-pixel object is 21 meters from the car.
- For a 1.5-meter wide road sign, a 12-pixel object is 60 meters from the car and a 24-pixel object is 30 meters from the car.

Again, because of the specific panomorph resolution pattern suggested in this case study, panomorph optics will increase the distance in its areas of interest (++ areas on Figure 27) by a factor of 70% compared to a theoretical fisheye lens.

For side views (blind spot monitoring), a higher resolution image will significantly enhance the viewing for long distance objects and vehicles on the periphery.

For example, to avoid a blind zone at a garage entrance created by vehicles parked on the street side.

Using the PGM (section 3.2), different software projection types can be created, depending on OEM requirements. The two following figures show ways to display a view of the intersection to the driver while avoiding the blind zone created by a parked vehicle. This

type of projection is simply a pixel displacement that has been computed during the calibration phase on a production chain. This can be hard coded in a lookup table in the camera module. No special CPU horse power is required.

Figures 29 and 30 show ways to avoid a blind zone. The driver can see everything in the blind zone using his/ her on-board display. The panomorph lens design suggested in this

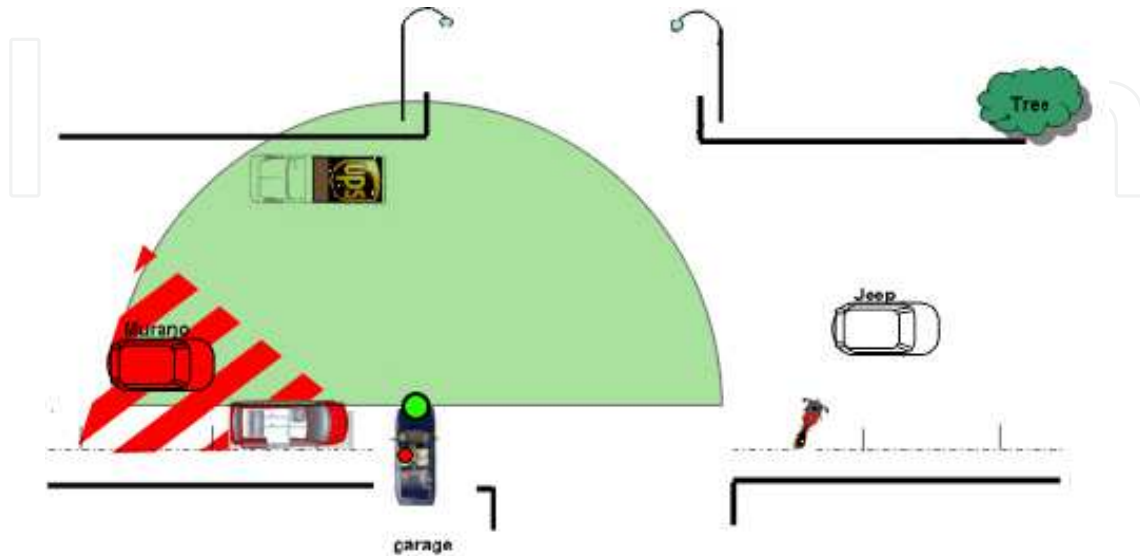

Fig. 28. Panomorph coverage of a blind zone created by a parked vehicle

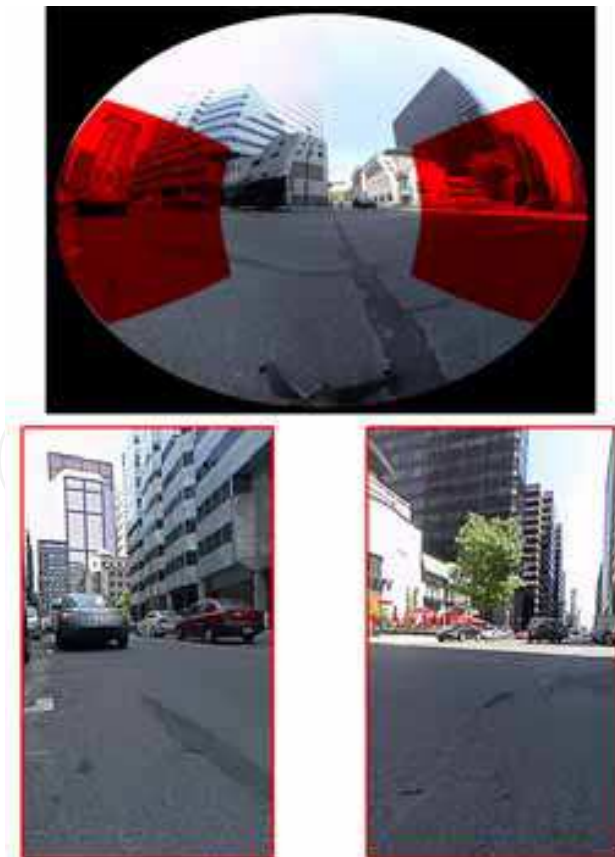

Fig. 29. Two views rendering either side of the intersection

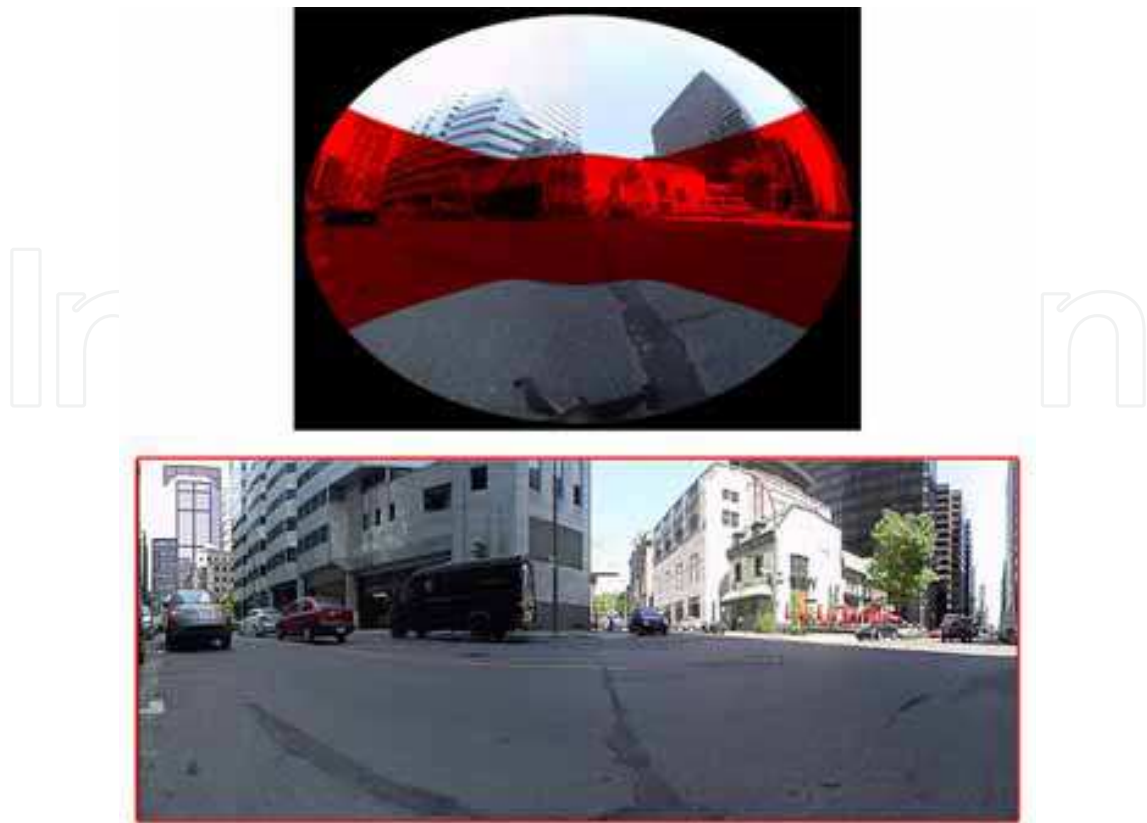

Fig. 30. 190° strip integrating full intersection

example increases the resolution of objects along the border and right in the middle. Where the resolution is higher, the camera is able to see for a longer distance. The panomorph distortion is optimized for this type of application. The driver is able to see far down each side of the street.

The final example for automotive is one could mount four (4) panomorph lenses all around the vehicle to provide a complete view with the added benefits of panomorph technology's augmented resolution (figure 31).

#### 4.3 Endoscopy

The last example of this section is about medical imaging. Researchers and physicians are always looking for the most effective and least invasive techniques to benefit the patient. For example, single-incision laparoscopic surgery - which is a critical advancement in minimally-invasive surgery (MIS), may soon become a preferred method. Minimally invasive surgical procedures or examinations require increasingly sophisticated devices to explore the interior of the patient's body while limiting the impact on the human body.

Recently, optic miniaturization and sensor improvements in size and resolution have led to the development of new smaller and improved videoscopes for medical imaging in various procedures. These modern visual instruments benefit from sensor miniaturization to increase their resolution up to 1.3Megapixel (HD).

Even with such high resolution, the endoscopic vision remains quite different than human vision, especially regarding the field of view and the type of viewing projection. The limited field of view produces poor visualization for the clinician and increases the scope manipulations and procedure time. These drawbacks have driven industry to design

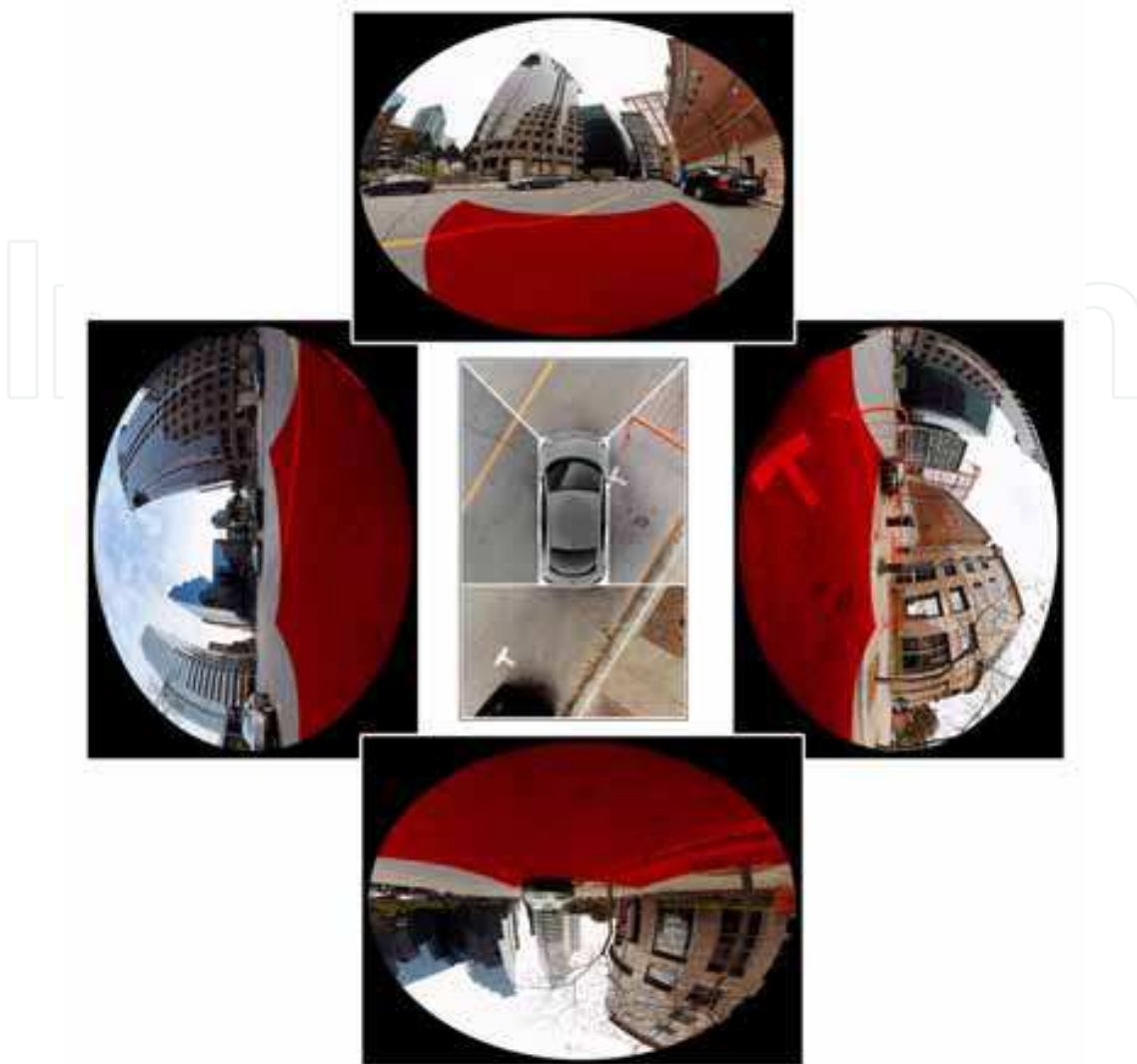

Fig. 31. View of area surrounding vehicle using four (4) panomorph lenses.

endoscopes with a larger field of view. Several optical systems have been developed featuring convex mirrors, prisms or wide angle lenses to meet large field of view requirements. However most of these optical systems suffer from low resolution or poor quality. A particular concern in the optical design of these types of wide angle imager is the uniformity of the image quality and the fact that the more the field of view is enlarged, the more distortion is created on the viewing display.

Recently a new approach that can play a significant role in improving endoscopic procedures based on the use of the Panomorph technology have been proposed (Roulet, 2010).

During an open surgery, the surgeon uses the wide field of view of his eyes to analyse the situation. He has a bird's eye view of the surgery and he always has his tool in his field of view. However in MIS, using a standard endoscope causes a narrow viewing angle (figure 32). With its wide field of view, the panomorph lens increases the coverage of the operating area. Then, the surgeon observes a hemispheric field of view in the front of the endoscope. By increasing the coverage, this device decreases the number of manipulations and repositioning of tools and endoscope (figure 33). For example, by placing the endoscope near the insertion point, the surgeon has an overview of the whole body cavity. He can well appreciate each tool position in the operating area.

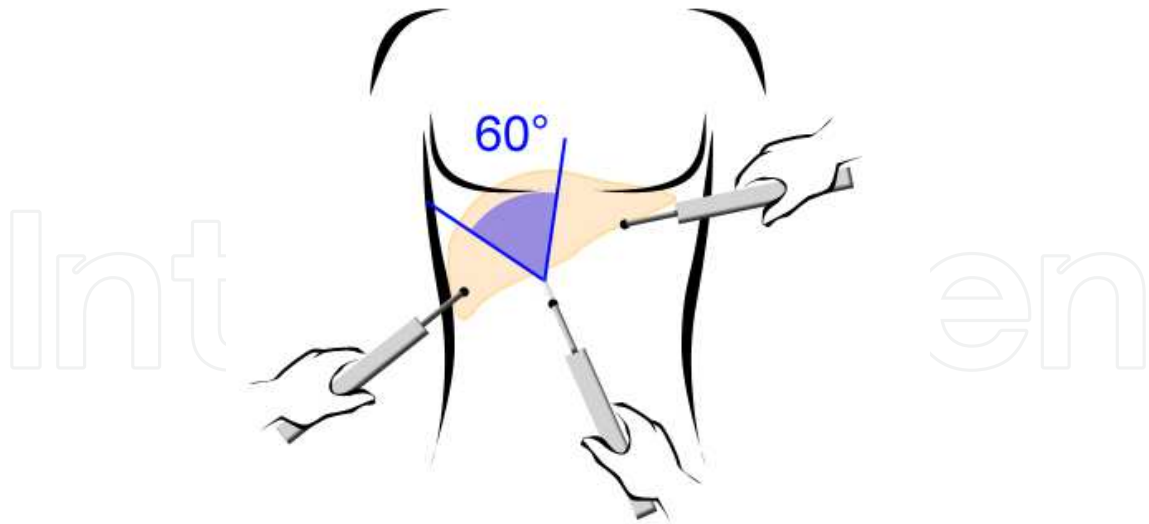

Fig. 32. Cholecystectomy procedure field of view with a classic laparoscope

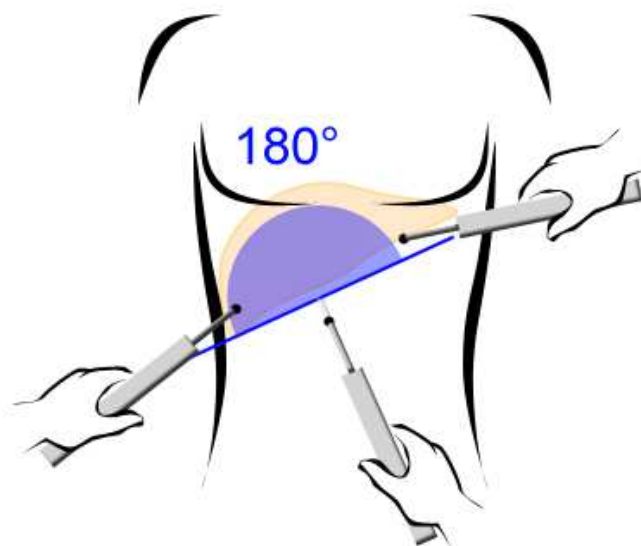

Fig. 33. Cholecystectomy procedure field of view with a panomorph laparoscope

Furthermore, the panomorph endoscope displays more anatomical landmarks which help to localise the dissection plan and increases the perception of depth. Being able to keep an eye on his/ her tools all along the procedure is a major improvement for the surgeon, to avoid manipulation mistakes.

For MIS, we could design a laparoscope panomorph lens with augmented resolution in the center. This resolution distribution enhances the operating area (center area) while keeping the large field to survey the whole scene. The following figures (34-35) show the simulated panomorph lens images with increased resolution in the center. This augmentation is close to human eye behaviour. Figure 36 shows the normalised resolution ratio of the lens (pixels ratio/ degrees) across the field of view. The resolution along the center is 3 times higher than in the periphery. Consequently the object's magnification in the center is larger and more details can be analysed in this part of the image.



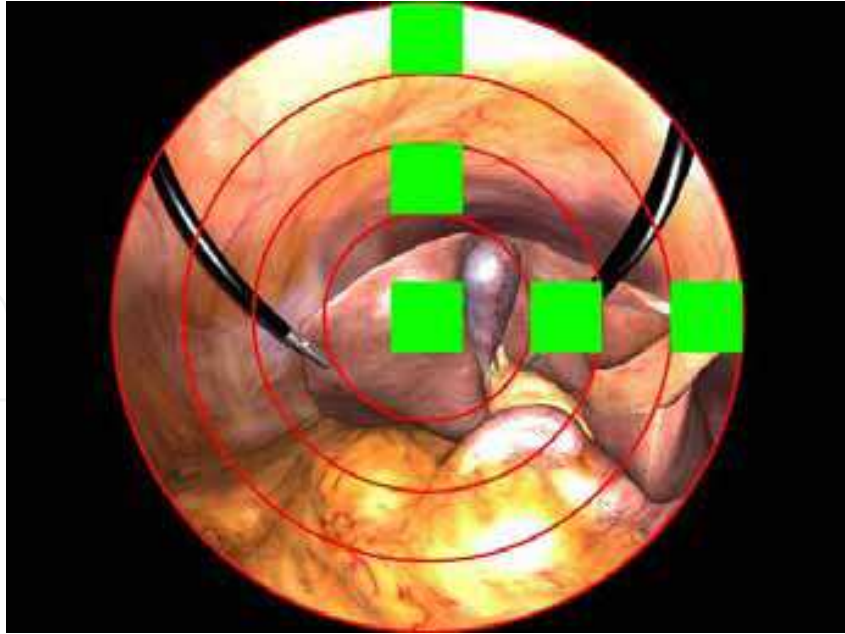

Fig. 34. Linear resolution wide angle lens

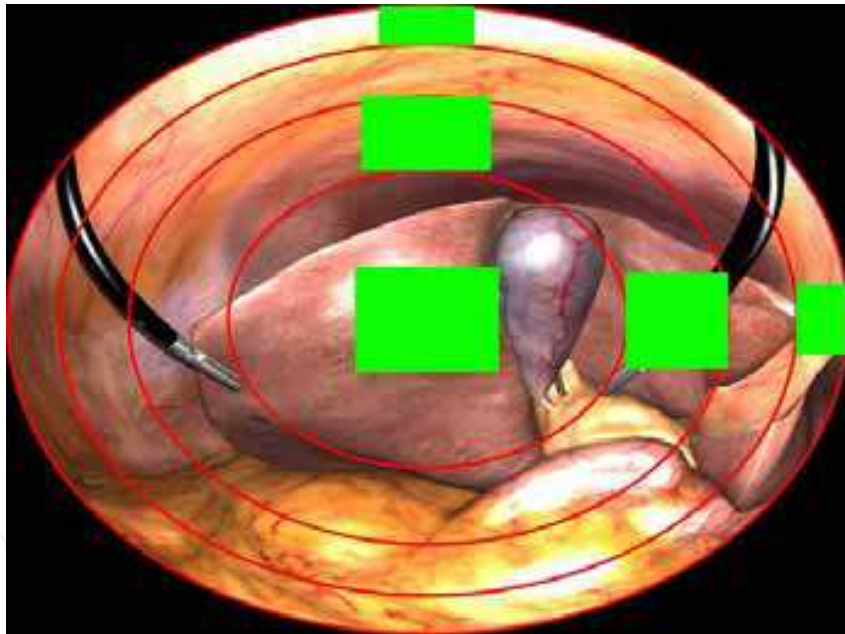

Fig. 35. Panomorph lens with an augmented resolution in the center and 4:3 anamorphic ratio

The image display on the screen for the surgeon is an improved representation of the image captured by the panomorph lens and the sensor. The associated video-viewing algorithms will correct the image distortion to provide a rectilinear view (or a more natural view). These unwarping algorithms project pixels from the endoscope sensor to the display and produce one or more standard virtual views in real time. The viewing algorithms allow simultaneous display of as many views as desired from one endoscope as shown in figure 37.

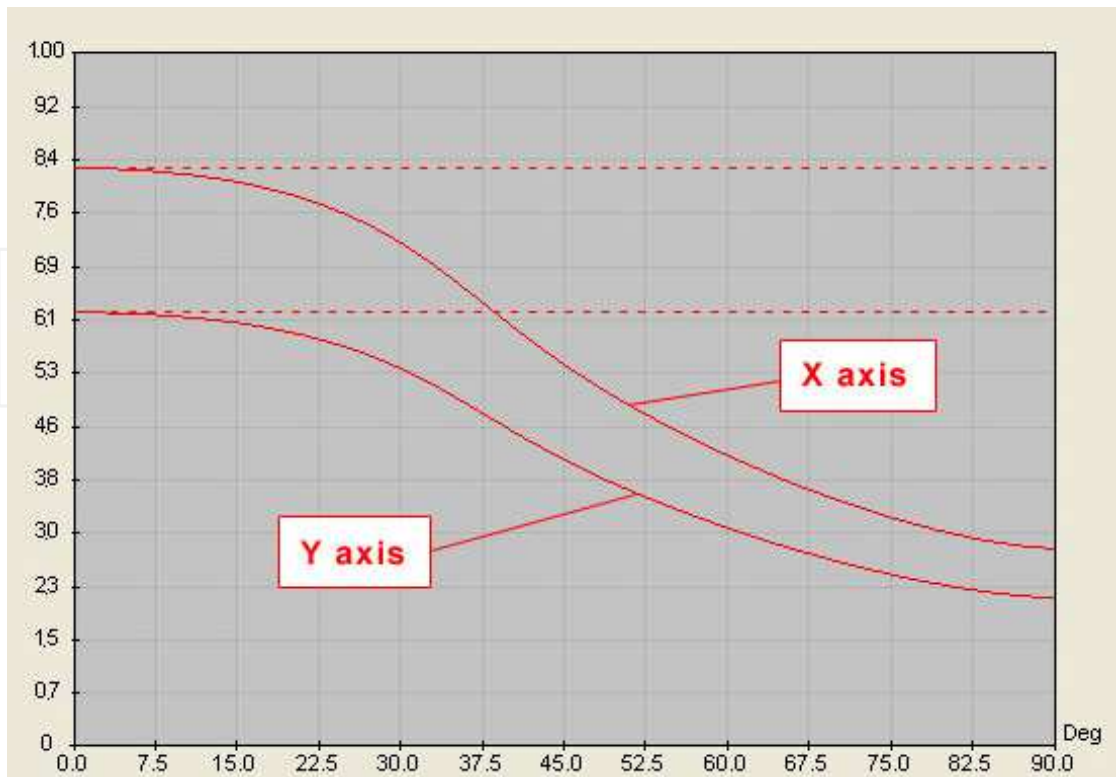

Fig. 36. Normalized resolution across the field of view

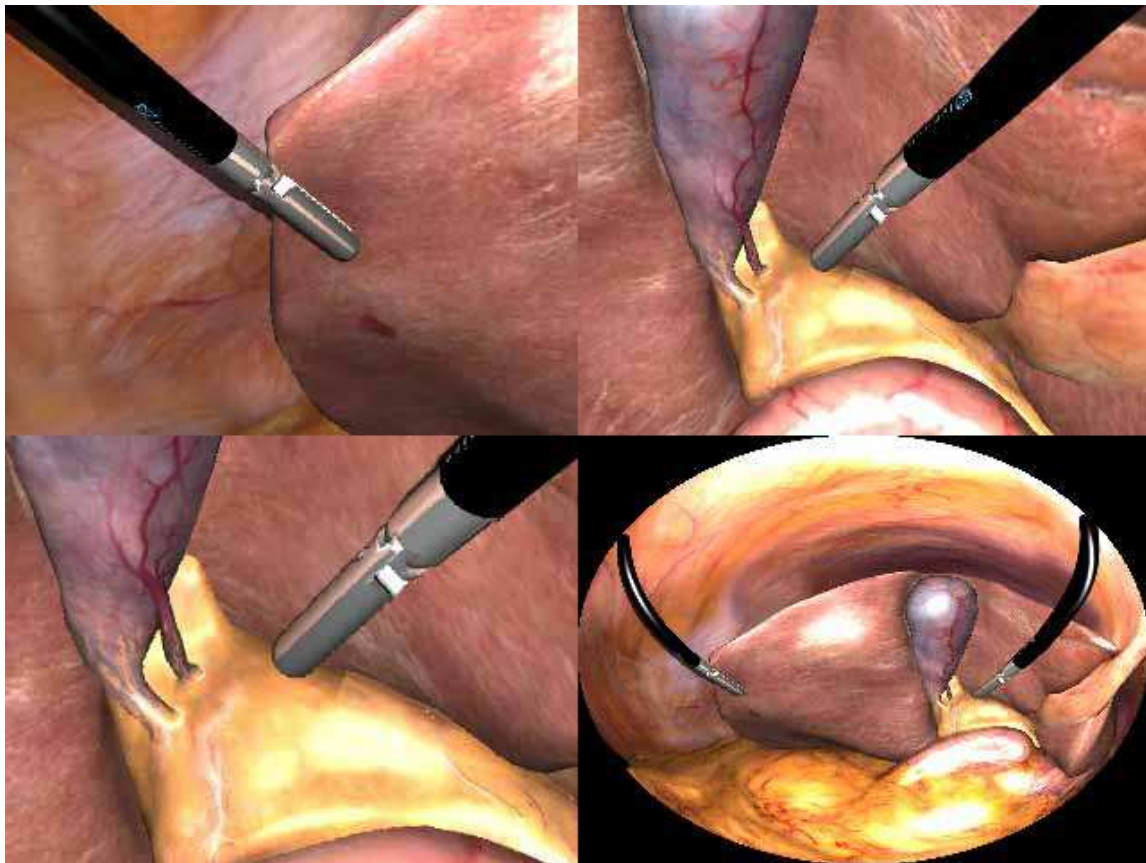

Fig. 37. Different views processed from the same endoscope

Consequently, the viewing process unwraps the image in real time in order to provide views that reproduce real world proportions and geometrical information. These projection algorithms can be adapted for each specific surgical procedure, which is then related to human vision (display) or artificial vision (analytic function).

It is possible for the surgeon to easily choose the best view (projection algorithm configuration) which best fit his/ her psycho-motor skills, his/ her position and the intervention conditions without having to manipulate the laparoscope. For example, trocar positioning could be achieved by moving the view (virtual camera) without moving the panomorph laparoscope.

Surgeons and assistants have to deal with counter-intuitive endoscope manipulations. For example, in the case of a laparoscope with a 30 degree view, by rotating the laparoscope the assistant changes the viewing angle of the scene. With panomorph technology, views are based on image processing, and virtual camera movements can be performed without any endoscope movement.

Moreover, the surgeon could arrange each view on several screens to have a global overview of the surgery. For example, the following screen configuration well known in flight simulation software respects the aspect ratio, proportion and orientation of each object and would increase the surgeon's perception of depth and surrounding positions. Previous work demonstrates that panoramic visualisation increases the surgeon's accuracy (Naya et al, 2008). In this case the panoramic view consists in different videos calculated from only one laparoscope which provides a surrounding view of the working area in real time. This concept is presented in figure 38.

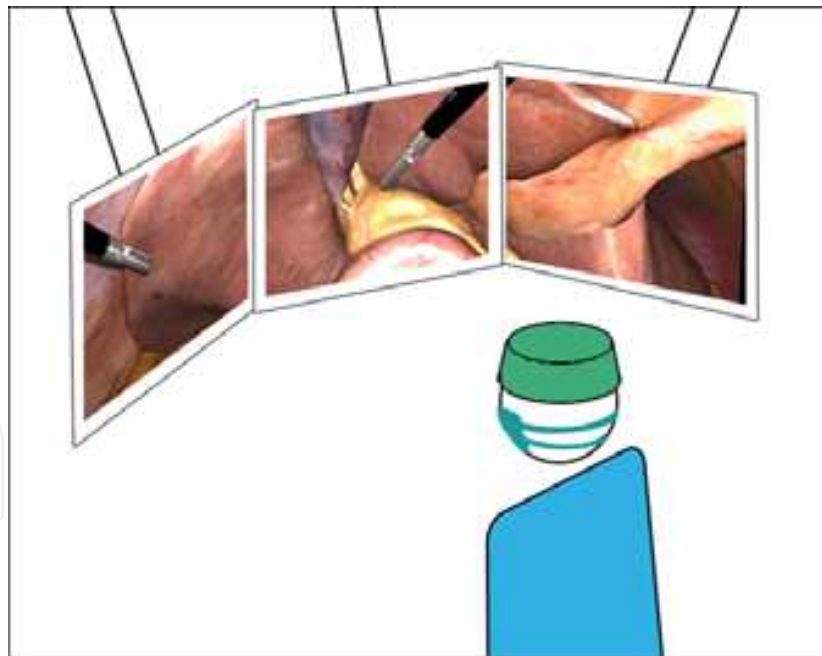

Fig. 38. Immersive screen configuration sample

## 5. Conclusion

Panomorph lens development has led to new types of panoramic imager that can be customized to enhance any panoramic imager application. The design features full

hemispheric coverage, better use of sensor areas and increased resolution in the zone of interest. During the last few years, several research teams have developed custom applications using the Panomorph lens differentiator. This chapter has presented state of the art example of recent development using this technology. Panomorph lens based sensor make application more and more feasible in various application fields. Combines with proper viewing process, the Panomorph sensor can play a significant role in the future of visual sensor.

The viewing process is composed of three steps. The first step is the definition of the panomorph geometrical model (PGM) associated with each custom panomorph lens application. The second step is the projection of the recorded image onto the PGM to provide a discretized mapping based on the recorded pixel position on the sensor. The third is a final rendering based on an azimuthal projection technique. The algorithms developed over the years have been optimized for use on small CPU and memory, enabling embedded processing. The algorithms are available thru a SDK running on Linux and Windows operating systems, and can be ported to many processors and systems.

In conclusion, a panoramic imaging sensor contributes most to our perception of the world. Several sensor systems are necessary to obtain a complete vision of the environment around a vehicle, a robot, an airplane, or a security vehicle; however, a 360° visual sensor using panomorph lenses is probably one of the most promising ways to fuse many sensors into one, and thus reduce risk and cost.

## 6. References

- Artonne, J.C., Moustier, C., Blanc, B., (2005) US Patent 6,844,990. Method for capturing and displaying a variable resolution digital panoramic image, issued, January 18, 2005.
- Chahl JS and Srinivasan MV., (1997) Reflective surfaces for panoramic imaging. *Applied Optics* Vol. 36, No. 31, pp. 8275-8285.
- Greguss P. (1986), Panoramic imaging block for three-dimensional space. US Patent 4,566,763.
- Greguss, Pal. (1991), Panoramic Security. *SPIE* Vol. 1509, pp. 55-66 (1991).
- Horaud, R and Monga, O., (1995), Vision par Ordinateur - Outils fondamentaux, Ed. Hermès.
- Horridge GA., (1977), The compound eye of insects. *Sci Am* Iss. 237, p 108-120.
- J. Johnson, (1958), Analysis of image forming systems, in Proc. Image Intensifier Symp., pp. 249-273.
- Kingslake R. (1985), Development of the photographic objective. *Proc SPIE* Vol. 0531, pp. 60-67, 1985.
- Miyamoto K. (1964), Fish Eye Lens, Letters to the Editor. *JOSA*, Vol. 54, pp. 1060-1061, 1964.
- Naya, Y., Nakamura, K., Araki, K., Kawamura, K., Kamijima, S, Imamoto, T., Nihei, N, Suzuki, H., Ichikawa, T., and Igarashi, T., (2008) "Usefulness of panoramic views for novice surgeons doing retroperitoneal laparoscopic nephrectomy," *International Journal of Urology*, vol. 16, no2, 177-180.
- Roulet, P., Konen, P., Villegas, M., Thibault, S., Garneau, P. Y., (2010), "360° endoscopy using panomorph lens technology" in *Endoscopic Microscopy V*, edited by Guillermo J Tearney, Thomas D. Wang, Proceedings of SPIE Vol. 7558 (SPIE, Bellingham, WA 2010) 75580T.

- Russ, J.C. (2006), *The Image Processing Handbook*. CRC Press, Inc. Boca Raton, FL, USA, Fifth Edition.
- Thibault S., (2005), Distortion Control Offers Optical System Design a New Degree of Freedom. *Photonics Spectra* May 2005, pp. 80-82.
- Thibault, S. (2007), "360 degree vision system: opportunities in transportation". *Photonics in the Transportation Industry: Auto to Aerospace*. Edited by Kazemi, Alex A.; Baldwin, Christopher S. *Proceedings of the SPIE*, Volume 6758, pp. 67580H.

IntechOpen

IntechOpen

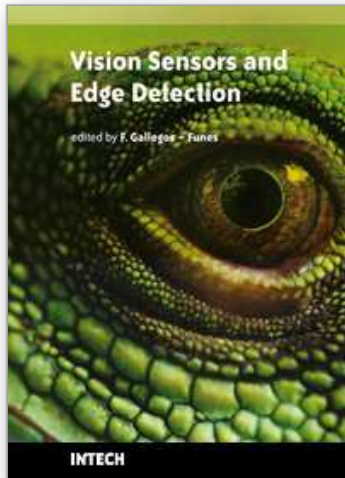

## **Vision Sensors and Edge Detection**

Edited by Francisco Gallegos-Funes

ISBN 978-953-307-098-8

Hard cover, 196 pages

**Publisher** Sciyo

**Published online** 12, August, 2010

**Published in print edition** August, 2010

Vision Sensors and Edge Detection book reflects a selection of recent developments within the area of vision sensors and edge detection. There are two sections in this book. The first section presents vision sensors with applications to panoramic vision sensors, wireless vision sensors, and automated vision sensor inspection, and the second one shows image processing techniques, such as, image measurements, image transformations, filtering, and parallel computing.

### **How to reference**

In order to correctly reference this scholarly work, feel free to copy and paste the following:

Simon Thibault (2010). Panomoprh Based Panoramic Vision Sensors, Vision Sensors and Edge Detection, Francisco Gallegos-Funes (Ed.), ISBN: 978-953-307-098-8, InTech, Available from:  
<http://www.intechopen.com/books/vision-sensors-and-edge-detection/panomoprh-based-panoramic-vision-sensors>

**INTECH**  
open science | open minds

### **InTech Europe**

University Campus STeP Ri  
Slavka Krautzeka 83/A  
51000 Rijeka, Croatia  
Phone: +385 (51) 770 447  
Fax: +385 (51) 686 166  
[www.intechopen.com](http://www.intechopen.com)

### **InTech China**

Unit 405, Office Block, Hotel Equatorial Shanghai  
No.65, Yan An Road (West), Shanghai, 200040, China  
中国上海市延安西路65号上海国际贵都大饭店办公楼405单元  
Phone: +86-21-62489820  
Fax: +86-21-62489821

© 2010 The Author(s). Licensee IntechOpen. This chapter is distributed under the terms of the [Creative Commons Attribution-NonCommercial-ShareAlike-3.0 License](#), which permits use, distribution and reproduction for non-commercial purposes, provided the original is properly cited and derivative works building on this content are distributed under the same license.

IntechOpen

IntechOpen