

We are IntechOpen, the world's leading publisher of Open Access books Built by scientists, for scientists

4,800

Open access books available

122,000

International authors and editors

135M

Downloads

Our authors are among the

154

Countries delivered to

TOP 1%

most cited scientists

12.2%

Contributors from top 500 universities



WEB OF SCIENCE™

Selection of our books indexed in the Book Citation Index
in Web of Science™ Core Collection (BKCI)

Interested in publishing with us?
Contact book.department@intechopen.com

Numbers displayed above are based on latest data collected.

For more information visit www.intechopen.com



Dimensional Synthesis and Analysis of the 2-UPS-PU Parallel Manipulator

Yunfeng Zhao, Yanhua Tang and Yongsheng Zhao¹
*School of Mechanical Engineering, Yanshan University
Qinhuangdao 066004 Hebei China*

1. Introduction

Compare with conventional serial robots, parallel manipulators has the advantages of higher accuracy, higher stiffness, and higher ratio of force-to-weight, so it has been intensively researched and evaluated by industry and intuitions over the last two decades [1].

It is well known that a main drawback of parallel manipulator is their reduced workspace. Furthermore computing this workspace is not an easy task as, at the opposite of classical serial robot, the translational and orientation workspace are coupled [2]. A number of authors have described the workspace of a parallel mechanism by discretizing the Cartesian workspace [3]. In the case of three degree of freedom (3-DOF) manipulators, the workspace is limited to a region of the three-dimensional Cartesian space.

A more challenging problem is designing a parallel manipulator for a given workspace. Merlet [4] propounded an algorithm to determine all the possible geometries of Gough-type 6-DOF parallel manipulators whose workspace must include a desired one. Boudreau and Gosselin [5] proposed an algorithm that allows for the determination of some parameters of the parallel manipulators using a genetic algorithm method in order to obtain a workspace as close as possible to a prescribed one. Kosinska et al. [6] presented a method for the determination of the parameters of a Delta-4 manipulator, where the prescribed workspace has been given in the form of a set of points. Snyman et al. [7] proposed an algorithm for designing the planar 3-RPR manipulator parameters, for a prescribed two-dimensional physically reachable output workspace. Laribi et al. [8] presented an optimal dimensional synthesis method of the DELTA parallel manipulator for a prescribed workspace. This problem was generally solved numerically, and none of the authors mentioned above took driving force into account.

In this paper, the 2-UPS-PU Parallel manipulator is designed to have a specified workspace. The algorithm is proposed to solve the optimization problem, which not only takes into account the leg-length limits, the mechanical limits on the passive joints, and interference between links, but also the driving forces of the three legs.

¹ Corresponding author. Tel./Fax: +86-335-807-4581.

E-mail address: yszhao@ysu.edu.cn

This paper is organized as follows: Section 2 is devoted to the description of the 2-UPS-PU Parallel manipulator. Section 3 deals with the position analysis of the Parallel manipulator. Section 4 is devoted to the kinematic analysis of the Parallel manipulator. Section 5 deals with the Statics analysis of the Parallel manipulator. In Section 6, we carry out the formulation of the optimization problem. Section 7 contains some conclusions.

2. Displacement analysis

The 2-UPS-PU parallel manipulator is shown in Fig. 1. This manipulator consists of three kinematic chains, including two UPS legs with identical topology and one PU leg, connecting the fixed base to a moving platform. In this parallel manipulator, the UPS legs, from base to platform, consist of a fixed Universal joint, an actuated prismatic joint and a spherical joint attached to the platform. The PU leg connecting the base center to the platform consists of a prismatic joint attached to the base, a universal joint attached to the platform. This branch is used to constrain the motion of the platform to the three degrees of freedom.

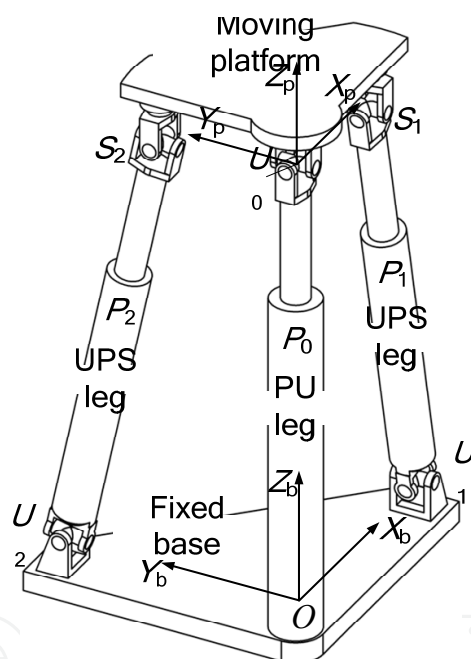

Fig. 1. The 2-UPS-PU parallel manipulator

The reference frame $O-X_bY_bZ_b$ is fixed on the base and mobile frame $U_0-X_pY_pZ_p$ is fixed on the moving platform (see Fig. 1). At the initial position, the X_p -axis and Y_p -axis of mobile frame are coincidence with the axes of the Universal joints U_0 respectively. The orientation of the first axis of U_0 is fixed. The orientation of the mobile frame can be represented by θ_1 and θ_2 shown in Fig. 2, which are two Euler angles about two axes of U_0 , respectively. Such Euler angles are defined by first rotating the mobile frame about the base x_p -axis (first axis of U_0) by an angle θ_1 , then about the mobile y_p -axis by an angle. For this choice of Euler angles, the rotation matrix is defined as

$$\mathbf{R} = \mathbf{R}_{X_p}(\theta_1) \cdot \mathbf{R}_{Y_p}(\theta_2) = \begin{bmatrix} \cos \theta_2 & 0 & \sin \theta_2 \\ \sin \theta_1 \sin \theta_2 & \cos \theta_1 & -\sin \theta_1 \cos \theta_2 \\ -\cos \theta_1 \sin \theta_2 & \sin \theta_1 & \cos \theta_1 \cos \theta_2 \end{bmatrix} \quad (1)$$

where $\mathbf{R}_{X_p}(\cdot)$ and $\mathbf{R}_{Y_p}(\cdot)$ are the basic rotation matrices.

The position of the mobile frame can be represented by l_0 , which is the distance between the Universal joint U_0 and reference point O . The homogeneous transform matrix \mathbf{T} , which represents the orientation and position of the mobile frame, is

$$\mathbf{T} = \text{Trans}_{Z_p}(l_0) \mathbf{R}_{X_p}(\theta_1) \cdot \mathbf{R}_{Y_p}(\theta_2) = \begin{bmatrix} \cos \theta_2 & 0 & \sin \theta_2 & 0 \\ \sin \theta_1 \sin \theta_2 & \cos \theta_1 & -\sin \theta_1 \cos \theta_2 & 0 \\ -\cos \theta_1 \sin \theta_2 & \sin \theta_1 & \cos \theta_1 \cos \theta_2 & l_0 \\ 0 & 0 & 0 & 1 \end{bmatrix} \quad (2)$$

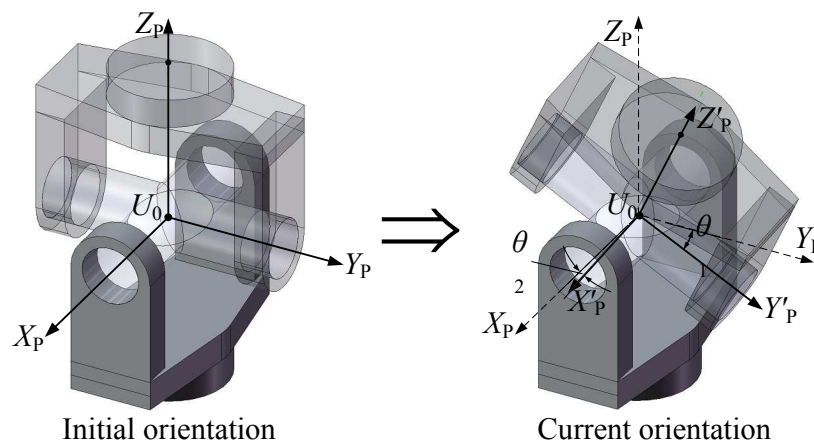

Fig. 2. The 2-UPS-PU parallel manipulator

The spherical joints (S_1 and S_2) of the UPS legs are arranged on the moving platform and their distances to the Universal joint U_0 on the moving platform is r . The Universal joints (U_1 and U_2) are fixed on the base platform and the distances to the reference point O on the base is R . The coordinate of U_0 , S_1 and S_2 in mobile frame and the coordinate of U_1 and U_2 in reference frame are expressed as:

$$\mathbf{U}_0 = \begin{pmatrix} 0 \\ 0 \\ 0 \end{pmatrix} \quad \mathbf{S}_1 = \begin{pmatrix} r \cos \alpha \\ r \sin \alpha \\ 0 \end{pmatrix} \quad \mathbf{S}_2 = \begin{pmatrix} r \cos \beta \\ r \sin \beta \\ 0 \end{pmatrix} \quad \mathbf{U}_1 = \begin{pmatrix} R \cos \alpha \\ R \sin \alpha \\ 0 \end{pmatrix} \quad \mathbf{U}_2 = \begin{pmatrix} R \cos \beta \\ R \sin \beta \\ 0 \end{pmatrix} \quad (3)$$

2.1 Inverse kinematics

For a given position and orientation of the mobile platform, we can compute the related link lengths, denoted by l_i , using the following relation:

$$\begin{aligned}
 l_0 &= l_0 \\
 l_1 &= \|\mathbf{T} \cdot \mathbf{S}_1 - \mathbf{U}_1\| = \sqrt{a^2 + b^2 + c^2} \\
 l_2 &= \|\mathbf{T} \cdot \mathbf{S}_2 - \mathbf{U}_2\| = \sqrt{d^2 + e^2 + f^2}
 \end{aligned} \tag{4}$$

where

$$\begin{aligned}
 a &= r \cos \alpha \cos \theta_2 - R \cos \alpha \\
 b &= r \cos \alpha \sin \theta_1 \sin \theta_2 + r \sin \alpha \cos \theta_1 - R \sin \alpha \\
 c &= r \sin \alpha \sin \theta_1 - r \cos \alpha \cos \theta_1 \sin \theta_2 + l_0 \\
 d &= r \cos \beta \cos \theta_2 - R \cos \beta \\
 e &= r \cos \beta \sin \theta_1 \sin \theta_2 + r \sin \beta \cos \theta_1 - R \sin \beta \\
 f &= r \sin \beta \sin \theta_1 - r \cos \beta \cos \theta_1 \sin \theta_2 + l_0
 \end{aligned}$$

Eq. (4) is the solution of the so-called inverse kinematics problem.

2.2 Direct kinematics

If set the second axis of Universal joint U_0 pass through either S_1 or S_2 ($\alpha = 0^\circ$ or $\alpha = 90^\circ$), we can simply get analytical direct kinematics solution. For example, let $\alpha = 90^\circ$, then $\cos \alpha = 1$ and $\sin \alpha = 0$. As a result, Eq. (4) for $\alpha = 90^\circ$ is simplified as:

$$\begin{aligned}
 l_1^2 &= r^2 + R^2 + l_0^2 + 2rl_0 \sin \theta_1 - 2rR \cos \theta_1 \\
 l_2^2 &= 2rl_0 \sin \beta \sin \theta_1 - 2rR \sin \beta \sin \beta \cos \theta_1 - 2rR \cos \beta \sin \beta \sin \theta_1 \sin \theta_2 \\
 &\quad - 2rl_0 \cos \beta \cos \theta_1 \sin \theta_2 - 2rR \cos \beta \cos \beta \cos \theta_2 + r^2 + R^2 + l_0^2
 \end{aligned} \tag{5}$$

Then, we can calculate θ_1 and θ_2 by

$$\begin{aligned}
 \theta_1 &= \sin^{-1} \left(\frac{l_2^2 - r^2 - R^2 - l_0^2}{2r\sqrt{l_0^2 + R^2}} \right) + \tan^{-1} \left(\frac{R}{l_0} \right) \\
 \theta_2 &= \sin^{-1} \left(\frac{a + b}{\sqrt{c^2 + d^2}} \right) - \tan^{-1} \left(\frac{d}{c} \right)
 \end{aligned} \tag{6}$$

where

$$\begin{aligned}
 a &= \frac{r^2 + R^2 + l_0^2 - l_1^2}{2r} \\
 b &= l_0 \sin \beta \sin \theta_1 - R \sin^2 \beta \cos \theta_1 \\
 c &= l_0 \cos \beta \cos \theta_1 + R \cos \beta \sin \beta \sin \theta_1 \\
 d &= R \cos^2 \beta
 \end{aligned}$$

It is easy to see that Eq. (6) must satisfy:

$$\begin{aligned}
 \theta_1 &\in [-90^\circ \quad 90^\circ] \\
 \theta_2 &\in [-90^\circ \quad 90^\circ]
 \end{aligned}$$

Obviously, the same calculation can be drawn when $\alpha = 0^\circ$.

3. Velocity equation

To differentiate Eq. (4) allows us to obtain the velocities equation as:

$$\begin{pmatrix} \dot{l}_1 \\ \dot{l}_2 \\ \dot{l}_0 \end{pmatrix} = [\mathbf{q}] \begin{pmatrix} \dot{\theta}_1 \\ \dot{\theta}_2 \\ \dot{l}_0 \end{pmatrix} = \begin{bmatrix} q_{11} & q_{12} & q_{13} \\ q_{21} & q_{22} & q_{23} \\ 0 & 0 & 1 \end{bmatrix} \begin{pmatrix} \dot{\theta}_1 \\ \dot{\theta}_2 \\ \dot{l}_0 \end{pmatrix} \quad (7)$$

where $[\mathbf{q}]$ is the kinematic jacobian matrix, and

$$q_{11} = \frac{l_0 r (\cos \alpha \sin \theta_1 \sin \theta_2 + \sin \alpha \cos \theta_1) + R r \sin \alpha (\sin \alpha \sin \theta_1 - \cos \alpha \cos \theta_1 \sin \theta_2)}{l_1}$$

$$q_{12} = \frac{r \cos \alpha [R \cos \alpha \sin \theta_2 - R \sin \alpha \sin \theta_1 \cos \theta_2 - l_0 \cos \theta_1 \cos \theta_2]}{l_1}$$

$$q_{13} = \frac{l_0 + r (\sin \alpha \sin \theta_1 - \cos \alpha \cos \theta_1 \sin \theta_2)}{l_1}$$

$$q_{21} = \frac{l_0 r (\sin \beta \cos \theta_1 + \cos \beta \sin \theta_1 \sin \theta_2) + R r \sin \beta (\sin \beta \sin \theta_1 - \cos \beta \cos \theta_1 \sin \theta_2)}{l_2}$$

$$q_{22} = \frac{r \cos \beta [R \cos \beta \sin \theta_2 - l_0 \cos \theta_1 \cos \theta_2 - R \sin \beta \sin \theta_1 \cos \theta_2]}{l_2}$$

$$q_{23} = \frac{l_0 + r (\sin \beta \sin \theta_1 - \cos \beta \cos \theta_1 \sin \theta_2)}{l_2}$$

4. Statics analysis

The workloads can be simplified as a wrench F_w applied onto moving platform at U_0 .

$$F_w = (F_x \quad F_y \quad F_z \quad M_x \quad M_y \quad M_z)^T$$

When ignoring the friction in all the joints and the mass of all the parts, the wrench F_w is balanced by three active forces f_i ($i = 1, 2, 3$), two constrained forces f_x and f_y , and a constrained torque m_z . Each of f_i is applied on and along the axes of three legs; f_x , f_y and m_z are applied on the moving platform about X_p , Y_p , Z_p , respectively. the formulae for solving active forces and constrained forces are derived as

$$\begin{pmatrix} F_x \\ F_y \\ F_z \\ M_x \\ M_y \\ M_z \end{pmatrix} = \begin{bmatrix} S_1 & S_2 & S_z & S_x & S_y & 0 \\ S_{01} & S_{02} & 0 & 0 & 0 & S_z \end{bmatrix} \cdot \begin{pmatrix} f_1 \\ f_2 \\ f_0 \\ f_x \\ f_y \\ m_z \end{pmatrix} \quad (8)$$

where

$$\mathbf{S}_x = \begin{pmatrix} 1 \\ 0 \\ 0 \end{pmatrix}; \quad \mathbf{S}_y = \begin{pmatrix} 0 \\ 1 \\ 0 \end{pmatrix}; \quad \mathbf{S}_z = \begin{pmatrix} 0 \\ 0 \\ 1 \end{pmatrix};$$

$$\mathbf{S}_i = \frac{\mathbf{T} \cdot \mathbf{S}_i - \mathbf{U}_i}{l_i}; \quad \mathbf{S}_{0i} = \frac{\mathbf{S}_i \times (\mathbf{T} \cdot \mathbf{S}_i - \mathbf{U}_i)}{\|\mathbf{S}_i \times (\mathbf{T} \cdot \mathbf{S}_i - \mathbf{U}_i)\|} \quad (i=1,2)$$

5. Workspace

5.1 Mechanical constraints

There are four main mechanical constraints that limit the workspace of a parallel manipulator [1]: (i) Workspace singularities, (ii) the actuators stroke, (iii) the range of the passive joints, and (iv) the link interference.

5.1.1 Workspace singularities

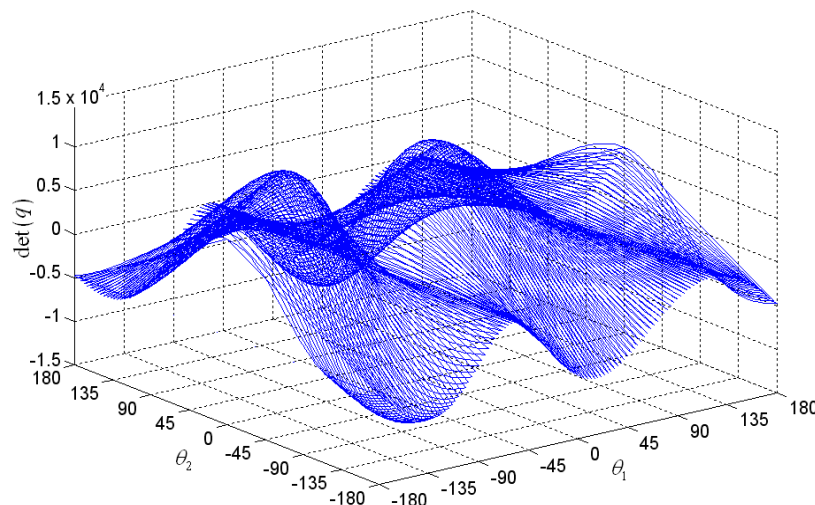

Fig. 3. The relationship between the determinant of jacobian matrix and θ_1 , θ_2

The theoretical workspace of the manipulator is surrounded by singular surface. In the theoretical workspace, the determinant of jacobian matrix ($|q|$) should be always greater or less than zero. The relationship between the determinant of jacobian matrix and parameters of θ_1 , θ_2 , for $r=150$, $R=200$, $a=\pi/2$, $\beta=\pi/6$ and $l_0=300$, is shown in Fig. 3. If we set $\theta_1=\theta_2=0$ as the initial orientation, the determinant of jacobian matrix should be always greater than zero.

$$|q| > 0 \quad (9)$$

5.1.2 Actuators' stroke

The limited stroke of actuator i imposes a length constraint on link i , such that

$$\frac{l_{i\max} - l_{i\min}}{l_{i\min}} \leq 0.8 \quad i = 0,1,2 \quad (10)$$

where l_{\min} and l_{\max} are, respectively, the minimum and maximum lengths of leg i .

5.1.3 Range of the passive joints

Each passive joint has a limited range of motion. Let the maximum misalignment angle of the Universal joint U_i be $\theta_{iU\max}$. Then, the limits on Universal joint U_i impose a constraint, such that

$$\theta_{iU} \leq \theta_{iU\max} \quad (11)$$

Similarly, Let the maximum misalignment angle of the spherical joint S_i be $\theta_{iS\max}$. Then, the limits on spherical joint S_i impose a constraint, such that

$$\theta_{iS} \leq \theta_{iS\max} \quad (12)$$

5.1.4 Link interference

Let us assume that the links can be approximated by cylinders of diameter D . This imposes a constraint on the relative position of all pairs of links, such that

$$\text{distance}(l_i, l_j) \geq D \quad i, j = 0, 1, 2 \quad i \neq j \quad (13)$$

or the minimum distance between every two line segments corresponding to the links of the parallel manipulator should be greater than or equal to D . The minimum distance between two line segments is not given by a simple formula but can be obtained through the application of a multi-step algorithm. Due to space limitations, we will not present that algorithm here but refer the reader to the well-detailed one given in [9].

5.2 Workspace representation

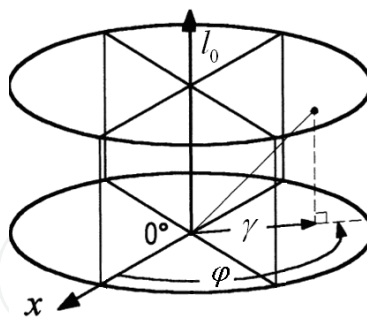

According to the characteristics of the 2-UPS-PU parallel manipulator, we present a cylindrical coordinate system (see Fig. 4), where φ and γ are exactly the polar coordinates representing the orientation of the moving platform and l_0 is the z-coordinate.

The unit vector of Z_p -axis in reference frame is expressed as:

$$\mathbf{Z}_p = \begin{pmatrix} \sin \gamma \cos \varphi \\ \sin \gamma \sin \varphi \\ \cos \gamma \end{pmatrix} = \begin{pmatrix} \sin \theta_2 \\ -\sin \theta_1 \cos \theta_2 \\ \cos \theta_1 \cos \theta_2 \end{pmatrix} \quad (14)$$

Then, we can calculate θ_1 and θ_2 by

$$\begin{aligned}\theta_2 &= \sin^{-1}(\sin \gamma \cos \varphi) \\ \theta_1 &= -\sin^{-1}\left(\frac{\sin \gamma \sin \varphi}{\cos \theta_2}\right)\end{aligned}\quad (15)$$

5.3 Algorithm for the workspace

- Step 1:** Initialize double arrays A , B and Z , with dimensions $(n+2) \times m$, where n is the number of equally spaced planes l_0 between $l_{0\min}$ and $l_{0\max}$ at which the workspace will be computed, and m is the number of points to be computed at each plane $l_0 = \text{const}$. These arrays will store, respectively, the values of φ , γ and l_0 for the points defining the workspace boundary.
- Step 2:** Set r , R , h , α , β and D .
- Step 3:** Set $\theta_{u\max}$, $\theta_{s\max}$, $l_{i\min}$ and $l_{i\max}$, Where $i = 0, 1, 2$.
- Step 4:** Set $l_0 = l_{0\min}$.
- Step 5:** For the current l_0 , construct a polar coordinate system at (φ, γ) . Starting at m equally spaced angles, increment the polar ray, solve the inverse kinematics, and apply the constraint checks defined by Eqs. (8) ~ (12) until a constraint is violated. The values for φ , γ and l_0 at the point of constraint violation are written into the three double arrays.
- Step 6:** Set $l_0 = l_0 + \Delta l_0$, where $\Delta l_0 = \frac{l_{0\max} - l_{0\min}}{n}$.
- Step 7:** Repeat steps 5-6 until l_0 becomes greater than $l_{0\max}$.
- Step 8:** Transfer A and B into X and Y , so that $X(i, j) = B(i, j) \cdot \cos[A(i, j)]$ and $Y(i, j) = B(i, j) \cdot \sin[A(i, j)]$, where $i = 1 \dots n+1$ and $j = 1 \dots m$.

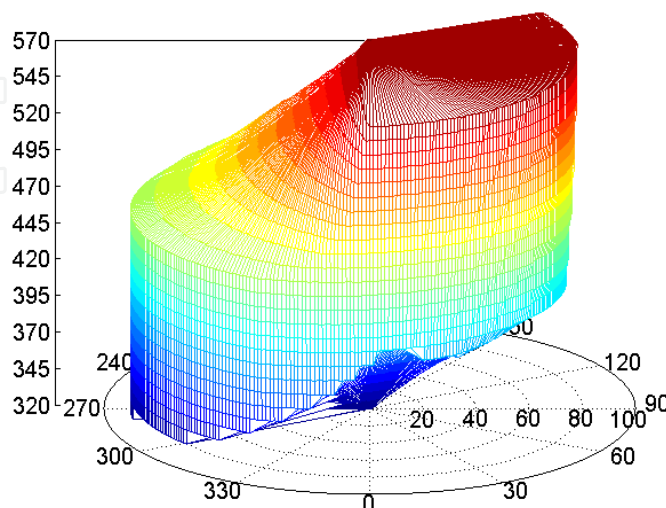

Fig. 5. Isometric view of the Parallel manipulator's workspace.

The proposed algorithm was implemented in MATLAB for the 2-UPS-PU parallel manipulator whose data are $r = 100$, $R = 120$, $\alpha = 90^\circ$, $\beta = 25^\circ$, $D = 5$, $l_{\min} = 320$, $l_{\max} = 578$, $l_{0\min} = 320$, $l_{0\max} = 570$, $\theta_{U\max} = 90^\circ$, and $\theta_{S\max} = 60^\circ$. The workspace of the manipulator is presented in Fig. 5. and the approximated projected workspaces for $l_0=350$, 450 and 500 shown in Fig. 6.

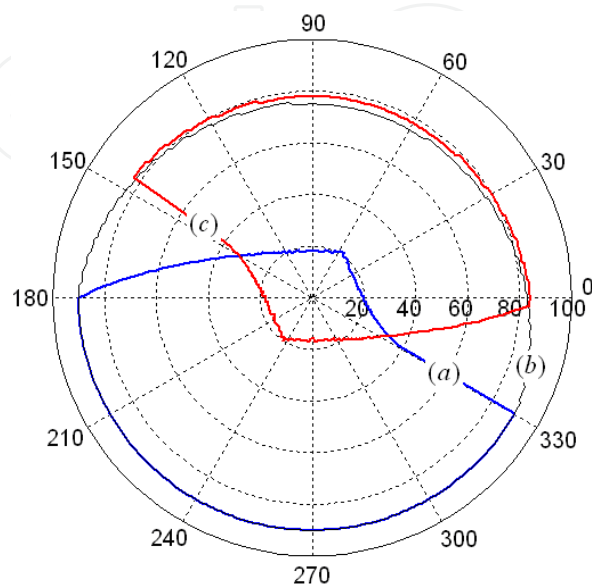

Fig. 6. The projected workspace of the Parallel manipulator for the positions (a) $l_0=350$, (b) $l_0=450$ and (c) $l_0=500$

6. Optimal design

The aim of this section is to develop and to solve the multidimensional optimization problem of selecting the geometric design variables for the 2-UPS-PU parallel manipulator having a prescribed workspace with better driving capability.

The prescribed workspace of the parallel manipulator is defined as a cylinder with radius γ and height h (see Fig.7) and the actual workspace is convex (see Fig.5). The prescribed workspace is inside the workspace of the parallel manipulator if all the points in the boundary curves are inside the actual workspace.

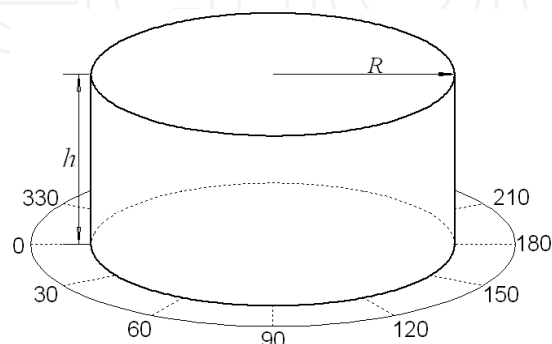

Fig. 7. The scheme of the prescribed workspace.

6.1 Objective function

The parameters to be optimized are the minimum lengths of three legs ($l_{0\min}$, $l_{1\min}$ and $l_{2\min}$), the dimension of the base and the platform (R , r), and the relative angular position of the two UPS chains (α , β). Without losing generality, let r be normalized by h , and R , $l_{0\min}$ be normalized by r such that

$$k_r = \frac{r}{h} \quad k_R = \frac{R}{r} \quad k_{l_0} = \frac{l_{0\min}}{r} \quad (16)$$

The objective function of the multi-parameter optimization problem, can be stated as

$$\min \quad k = \pi R^2 l_{0\min} F \quad (17)$$

Subject to $f(\mathbf{I}, p) \leq 0$ for all the points p inside the specified workspace.

where \mathbf{I} is the unknown vector of parameters, and F is the maximum of the driving force of the three legs.

6.2 Algorithm for dimensional synthesis

- Step 1:** Initialize double arrays A , B , C and D , with dimensions 361×1 . Set the parameters γ_u and h representing the prescribed workspace.
- Step 2:** Set $\alpha = 90^\circ$, $k = 0$, and the allowable parameter ranges for β , k_r , k_R and k_{l_0} .
- Step 3:** Set the cycle number n .
- Step 4:** Random select the parameters β , k_r , k_R and k_{l_0} by Monte Carlo method in ranges.
- Step 5:** Set $l_0 = k \cdot l_{0\min}$ and $\gamma = \gamma_u$. Starting at 360 equally spaced angles, increment the angle φ , solve the inverse kinematics, write the length of the UPS legs into array A and B . set $l_{1\min} = l_{2\min} = \min(\min(A), \min(B))$, and $l_{1\max} = l_{2\max} = 1.8 \cdot l_{1\min}$.
- Step 6:** Set flag=0. For the current l_0 , construct a polar coordinate system at (φ, γ) . Starting at 360 equally spaced angles, increment the polar ray, solve the inverse kinematics, and apply the constraint checks defined by Eqs. (8)-(12) until $\gamma > \gamma_u$. Set flag=1 at the point of constraint violation and return to Step 12.
- Step 7:** If flag=0, then set $l_0 = k \cdot l_{0\min} + h$. For the current l_0 , construct a polar coordinate system at (φ, γ) . Starting at 360 equally spaced angles, increment the polar ray, solve the inverse kinematics, and apply the constraint checks defined by Eqs. (8)-(12) until $\gamma > \gamma_u$. Set flag=1 at the point of constraint violation and return to Step 12.
- Step 8:** If flag=0, then set $l_0 = k \cdot l_{0\min}$ and $\gamma = \gamma_u$. Starting at 360 equally spaced angles, increment the angle φ , solve the Statics, and write the maximum driving forces of the three legs into array C .
- Step 9:** If flag=0, then set $l_0 = k \cdot l_{0\min} + h$ and $\gamma = \gamma_u$. Starting at 360 equally spaced angles, increment the angle φ , solve the Statics, and write the maximum driving forces of the three legs into array D .

Step 10: Set $F = \max(\max(C), \max(D))$, and $k_d = FRl_{0\min}$.

Step 11: If $k = 0$ or $k_d < k$, set $O_r = k_r, O_R = k_R, O_{l_0} = k_{l_0}, O_{l_{\min}} = l_{1\min}$ and $O_{l_{\max}} = l_{1\max}$.

Step 12: Repeat steps 4-11 until the cycle time is n.

The proposed algorithm was again implemented in MATLAB. The optimal solution obtained for this example is presented in Table 1 for $\gamma_u = 60^\circ$ and $h = 100$.

Fig. 8 shows the workspace of the 2-UPS-PU parallel manipulator.

Fig. 9 shows the relationship between the minimum of γ and l_0 . One can notice the actual workspace include the prescribed workspace.

β	R	r	$l_{1,2\min}$	$l_{1,2\max}$	$l_{0\min}$	$l_{0\max}$
27°	186	124	396	712	450	650

Table 1. The optimal dimensions of 2-UPS-PU parallel manipulator

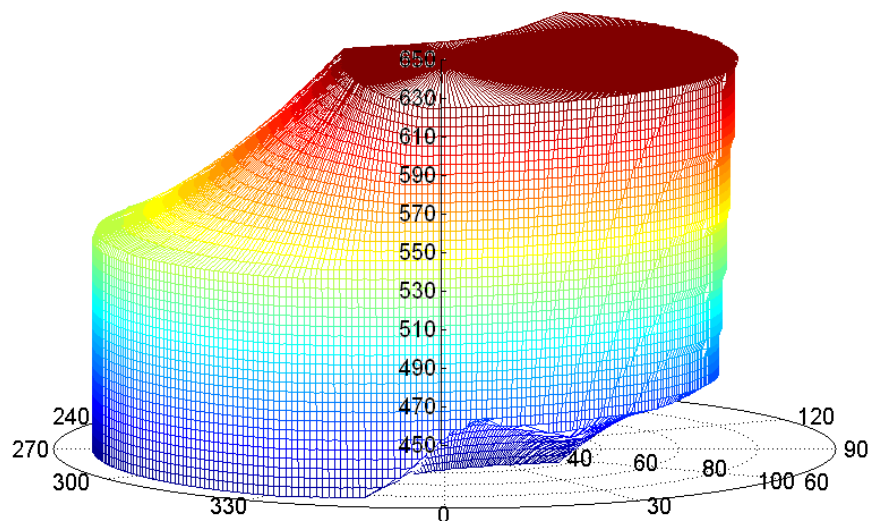

Fig. 8. Isometric view of the Parallel manipulator's workspace.

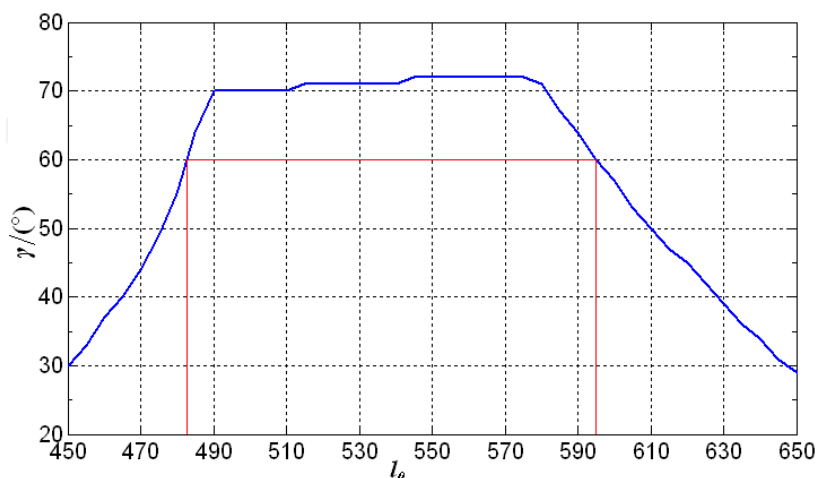

Fig. 9. The relationship between the minimum of γ and l_0

7. Conclusion

This paper proposed a novel 2-UPS-PU parallel manipulator with simple structure, high rotational capability, high load carrying capacity.

Based on the cylindrical coordinate system, an algorithm for computing three-dimensional workspace of the manipulator has been proposed in this paper. The boundary of the workspace on the specific plan is found out quickly by step-searching along the selected ray line.

An optimal dimensional synthesis method was presented to optimize this manipulator for a prescribed workspace. The driving force parameters were introduced into the object function. All the dimensional parameters, including the length of the legs, were included into the optimizing algorithm.

The methods proposed in this paper can be adopted universally. The results of this paper provide solid theoretical basis for further theoretical studies and practical application of this manipulator.

8. References

1. Z. Huang, L.F. Kong, Y.F. Fang, Theory on Parallel Robotics and Control[M], Machinery Industry Press, Beijing, China, 1997. (in Chinese)
2. J-P. Merlet. Still a long way to go on the road for parallel mechanisms [R]. ASME DETC Conference, 2002 Montréal.
3. T. Huang, J.S. Wang, D.J. Whitehouse, Closed form solution to the position workspace of Stewart parallel manipulators[J], Science in China, Series E: Technological Sciences 41 (4) (1998) 394–403.
4. Merlet J-P. Designing a parallel manipulator for a specific workspace[J]. International Journal of Robotics Research, 1997, 16(8): p 545-556.
5. R. Boudreau, C.M. Gosselin, The synthesis of planar parallel manipulators with a genetic algorithm[J]. ASME J. Mech. 1999; 121:533–537.
6. A. Kosinska, M. Galicki, K. Kedzior, Design and optimization of parameters of Delta-4 parallel manipulator for a given workspace[J]. J. Robot. Syst. 20 (9) (2003) 539–548.
7. J.A. Snyman, A.M. Hay, Optimal synthesis for a continuous prescribed dexterity interval of 3-DOF parallel planar manipulator for different prescribed output workspaces[C]. In: Proceeding of CK2005, 12th International Workshop on Computational Kinematics Cassino, May 2–6, 2005.
8. M.A. Laribi, L. Romdhane, S. Zeghloul. Analysis and dimensional synthesis of the DELTA robot for a prescribed workspace[J]. Mechanism and Machine Theory 2007, 42:P859-870
9. Masory O, Wang J. Workspace evaluation of Stewart platforms[J]. ASME, Design Engineering Division, 1992, 45:337~345



Advances in Robot Manipulators

Edited by Ernest Hall

ISBN 978-953-307-070-4

Hard cover, 678 pages

Publisher InTech

Published online 01, April, 2010

Published in print edition April, 2010

The purpose of this volume is to encourage and inspire the continual invention of robot manipulators for science and the good of humanity. The concepts of artificial intelligence combined with the engineering and technology of feedback control, have great potential for new, useful and exciting machines. The concept of eclecticism for the design, development, simulation and implementation of a real time controller for an intelligent, vision guided robots is now being explored. The dream of an eclectic perceptual, creative controller that can select its own tasks and perform autonomous operations with reliability and dependability is starting to evolve. We have not yet reached this stage but a careful study of the contents will start one on the exciting journey that could lead to many inventions and successful solutions.

How to reference

In order to correctly reference this scholarly work, feel free to copy and paste the following:

Yunfeng Zhao, Yanhua Tang and Yongsheng Zhao (2010). Dimensional Synthesis and Analysis of the 2-UPS-PU Parallel Manipulator, *Advances in Robot Manipulators*, Ernest Hall (Ed.), ISBN: 978-953-307-070-4, InTech, Available from: <http://www.intechopen.com/books/advances-in-robot-manipulators/dimensional-synthesis-and-analysis-of-the-2-ups-pu-parallel-manipulator>

INTECH
open science | open minds

InTech Europe

University Campus STeP Ri
Slavka Krautzeka 83/A
51000 Rijeka, Croatia
Phone: +385 (51) 770 447
Fax: +385 (51) 686 166
www.intechopen.com

InTech China

Unit 405, Office Block, Hotel Equatorial Shanghai
No.65, Yan An Road (West), Shanghai, 200040, China
中国上海市延安西路65号上海国际贵都大饭店办公楼405单元
Phone: +86-21-62489820
Fax: +86-21-62489821

© 2010 The Author(s). Licensee IntechOpen. This chapter is distributed under the terms of the [Creative Commons Attribution-NonCommercial-ShareAlike-3.0 License](https://creativecommons.org/licenses/by-nc-sa/3.0/), which permits use, distribution and reproduction for non-commercial purposes, provided the original is properly cited and derivative works building on this content are distributed under the same license.

IntechOpen

IntechOpen