

We are IntechOpen, the world's leading publisher of Open Access books Built by scientists, for scientists

4,800

Open access books available

122,000

International authors and editors

135M

Downloads

Our authors are among the

154

Countries delivered to

TOP 1%

most cited scientists

12.2%

Contributors from top 500 universities

**WEB OF SCIENCE™**Selection of our books indexed in the Book Citation Index
in Web of Science™ Core Collection (BKCI)

Interested in publishing with us?
Contact book.department@intechopen.com

Numbers displayed above are based on latest data collected.

For more information visit www.intechopen.com

Intelligent Energy Management in Hybrid Electric Vehicles

Hamid Khayyam¹, Abbas Kouzani¹, Saeid Nahavandi¹,
Vincenzo Marano² and Giorgio Rizzoni²
Deakin University Australia¹ and The Ohio State University USA²

1. Introduction

Energy management in vehicles is an important issue because it can significantly influence the performances of the vehicles. Improving energy management in vehicles can deliver important benefits such as reducing fuel consumption, decreasing emission, lower running cost, reducing noise pollution, and improving driving performance and ease of use. According to Mainins (Manins, 2000), each year more than 50 million new cars are produced in the world. However, usually only 30% to 40% of the energy produced by the engine is used to drive a car. The large energy waste of around 60% is the result of having an engine powerful enough to cope with the maximum power demand despite the fact that such power is required for only a very small percentage of vehicles' operating time. In addition, vehicle emissions are a source of greenhouse gas pollution emitting 70% to 90% of urban air pollution (SOE, 2006). Fuel economy benchmarks and emission regulations have encouraged vehicle manufactures and researchers to investigate new technologies to enhance fuel economy and minimise emissions. The energy efficiency of vehicles can be improved by enhancing the efficiency of the vehicle. Implementing energy management strategies in classical vehicles does not fully deliver the expected benefits. Hybrid electric vehicles, on the other hand, offer a platform that can accommodate advanced energy management strategies giving rise to full realization of the stated benefits. Intelligent energy management methods can observe and learn driver behavior, environmental and vehicle conditions, and intelligently control the operation of the hybrid electric vehicle.

A Hybrid Electric Vehicle (HEV) takes advantage of an Internal Combustion Engine (ICE) and an Electric Motor (EM) to deliver fuel consumption and exhaust emission reduction. An EM is powered by on-board battery packs to drive the vehicle. From the consumers overall perspective, the HEV is essentially the same as a Conventional Vehicle (CV). Moreover, HEVs are refuelled in the same way as a CV. A HEV has the advantage over a pure Electric Vehicle (EV) in both travelling range and convenience, as there is no need to recharge the battery through a power point for long hours. Importantly, a HEV has the potential to improve fuel economy by almost 50%, while also possessing all the advantages and flexibility of a CV (Ehsani et al., 2005). Hence, HEVs solve the problems of EVs whilst minimising the shortcoming of CVs providing the benefits of both electric and conventional

vehicles. HEVs are categorised into three groups: Series (S-HEV), Parallel (P-HEV), and Series/Parallel (S/P-HEV) as shown in Fig. 1.

In an S-HEV, there is no mechanical link between the ICE and drive train. This means that the ICE can run continuously in its preferred operating range, whereas the drivetrain is driven by an electric machine. For the electric power request, it relies on the battery plus the generator. The generator is driven by the ICE and maintains an appropriate energy level in the battery. A disadvantage of this configuration is that energy is first converted from mechanical power to electric power with the generator and then back to mechanical power by the electric machine, both introducing losses.

The P-HEV establishes a parallel connection between the ICE and the electric machine that both are allowed to give force to the drive the vehicle. The power through the EM can be positive as well as negative. This allows the EM to operate in motor mode and generator mode. At a top-level view, the P-HEV configuration looks similar to a conventional vehicle, although the EM in a conventional vehicle operates only in generator mode.

Finally, the last vehicle configuration is an S/P-HEV. It merges the topology of a series and a parallel HEV. S/P-HEVs have the highest complexity since power to the drivetrain can follow various trajectories. Recently plug-in hybrid electric vehicle (PHEV) has come to market. A PHEV is a hybrid electric vehicle that described above. The PHEV batteries can be recharged by plugging into an electric power source. A PHEV combines type of conventional hybrid electric vehicles and battery electric vehicles, possessing both an internal combustion engine and batteries for power. The desire strategy using PHEV can be employed as follows: in short distance travelling electric vehicle (EV) mode operation such as urban and for long distance travelling hybrid electric vehicle (HEV) mode operation such as highways.

The most important challenge for the development of P-HEV is the synchronization of multiple energy sources and conversion of power flow control for both the mechanical and electrical paths in optimal fuel efficiency and battery areas. The difficulty in the development of hybrid electric vehicles is the coordination of multiple sources such as mechanical and electrical. The reason why a P-HEV is considered in this work is that it has fewer disadvantages and less complexity (Kessels, J, 2007) (Ehsani et al., 2005).

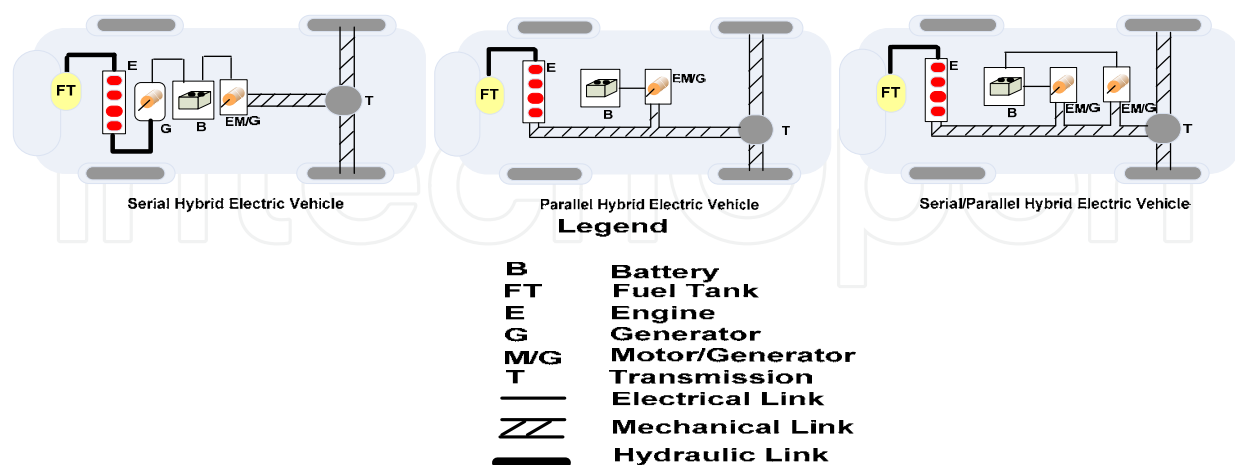

Fig. 1. Three HEVs structures.

Nevertheless, any vehicle needs to deal with uncertain factors such as environment conditions and also driver behaviour. HEVs are a highly complex systems comprising a

large number of mechanical, electronic, and electromechanical elements (Zhu et al.,2002). Hence a HEV can be considered as a Complex System (CS).

A Complex System is a system that can be analyzed into many components having relatively many relations among them, so that the behaviour of each component depends on the behaviour of others (Simon. A.H,1973).

In the real world, many problems and systems exist that are too complex or uncertain to be represented by complete and accurate mathematical models. However, such systems need to be designed, optimized, and controlled. CSs can be handled by Intelligent Systems (ISs). ISs can learn from examples, are fault tolerant, are able to deal with non-linear problems, and once trained can perform prediction and generalization at high speed. Intelligence systems have been used in diverse applications in control, robotics, pattern recognition, forecasting, medicine, power systems, manufacturing, optimization, signal processing, and social/psychological sciences. They are useful in system modelling such as in implementing complex mappings and system identification. ISs comprise areas like expert systems, artificial neural networks, genetic algorithms, fuzzy logic and various hybrid systems, which combine two or more of these techniques. ISs play an important role in modelling and prediction of the performance and control of energy and renewable energy processes. According to literature, ISs have been applied to energy and renewable energy engineering.

ISs can be developed through modelling and simulation. The modelling and simulation approach has become an essential tool for mechanical engineers and automotive researches in improving efficiency and timing of vehicle design and development, resulting in the delivery of significant cost saving as well as environmental benefits. The modelling and simulation is generally defined as mathematical realisation and computerised analysis of abstract representation of systems. The modelling and simulation helps achieve insight into the functionality of the modelled systems, and investigate the systems' behaviours and performances. The modelling and simulation is used in a variety of practical contexts relating to the design, development, and use of conventional as well as advanced vehicles including: design and evaluation of vehicle performance, fuel consumption, emission, energy storage devices, internal combustion engine, hybrid engine, accessories, composite materials, determination of drag using wind tunnel, training drivers through virtual vehicle, collecting and analysing sensory information, identifying critical test conditions, investigating crash factors, characterising road topology, testing and analysing energy management strategies, and so on.

This work employs the modelling and simulation approach to develop an Intelligent Energy Management System (IEMS) for a P-HEV.

The main objective is to optimize fuel consumption and reduce emissions. The work involves the analysis of the role of drivetrain, energy management control strategy and the associated impacts on the fuel consumption with combined wind/drag, slope, rolling, and accessories loads.

2. Literature Review and Background

This section provides a review of the main approaches used in modelling and control of energy management of HEVs. In a CV, energy can be dissipated in a number of ways including (Kessels.J, 2007):

- i. Brake utilisation: The brake is applied by the driver to decelerate the vehicle resulting in the loss of kinetic energy in the form of heat.

- ii. Engine start/stop: The engine often runs idle during the utilisation of vehicle resulting in an unnecessary consumption of fuel.
- iii. Uneconomic engine operating condition: An engine often demonstrates non-linear fuel consumption behaviour in certain operating conditions that causes an excessive use of fuel.
- iv. Unscheduled load: Certain mechanical and electrical loads get activated outside the economic operating point of engine increasing the fuel consumption.

P-HEVs provide a platform to reduce the wasted energy. The most important challenge for the development of P-HEV is the synchronization of multiple energy sources and conversion of power flow control for both the mechanical and electrical paths. Control in HEVs is recognized as two levels of actions: supervisory control and component control. In this study supervisory control is investigated as a suitable control strategy in energy management.

The control strategy is an algorithm that is used for issuing a sequence of instructions from the vehicle central controller to operate the drivetrain of the vehicle. The control strategy needs to monitor uncertain events. Moreover, in order to improve the system, the control strategy can provide optimized energy management. The control strategies in a P-HEV can be classified in two main groups as follows.

2.1 Rule-Based Control

The control rules techniques are based on mathematical, heuristics, and human expertise generally with an analytical knowledge of a predefined driving cycle. Control rules can be categorized in three methods.

A. Rule-Based

This method is based on an examination of the power requirements, ICE efficiency, fuel or emission maps. Human knowledge is used to design rules to split the requested power between converters. The method can be categorized into three groups: on/off control (Ehsani et al., 2005), base line control (Zhu et al., 2002) (Sciarretta et al., 2004) (Linl et al., 2004) (Lyshevski, 1999) (Barsali et al., 2004) (Khayyam et al., 2008), and discrete time events (Zhang & Chen, 2001) approaches.

B. Fuzzy logic

Fuzzy logic control has a nonlinear structure that can deal with the nonlinear structure of the power split problem. Fuzzy logic has a more robust structure and offers more design flexibility. The problem with fuzzy logic is the optimization and mathematical manipulation of defuzzification system. The defuzzification process consumes memory and time in controller. Some fuzzy logic controller have been developed for HEVs including (Baumann et al., 2000) (Farrokhi & Mohebbi, 2005) (Langari & won, 2005) (Mohebbi et al., 2005) (Salman et al., 2000) (Schouten et al., 2002) (Hajimiri et al., 2008).

C. Neuro-Fuzzy

There are also combinations of fuzzy logic and artificial neural called neuro-fuzzy control (Mohebbi et al., 2005) and fuzzy discrete event control (Bathae et al., 2005).

2.2 Optimal Control

In optimal control the controller is optimized according to a cost function of the system. Therefore, optimal control strategies are almost perfect. However, the optimal controllers are sensitive to parameter changes and also to noise. To perform the optimization process, all the dynamic and static behaviours of the system components are taken into consideration. Calculations are usually simplified by introducing assumptions which means that the solution is optimum only under the assumptions. On the other hand, the discrete time events method is simple and more robust. System behaviours are divided into discrete events. Each event is connected to another by certain rules (Mohebbi & Farrokhi, 2007).

If this optimal control is performed over a fixed driving cycle, a global optimum solution can be found. In fact, the optimal control system solution is noncasual in that it achieves the reduction of fuel consumption using information of future and past power demands. Obviously, this technique cannot be used directly for real-time energy management. Optimal control can be divided in two groups as follows.

A. Global Optimization (off line)

There are several reported solutions to achieve performance targets by optimization of a cost function representing efficiency over a drive cycle, yielding global optimal operating points. The global optimization techniques are not directly applicable for real-time problems, considering the fact that they are casual solutions. This is due to their computational complexity. Some of the global optimization methods are given below:

A.1 Neural Networks

Neural networks have the ability to be trained online or offline, but online training consumes memory in a controller. This trainability characteristic makes neural networks as a good candidate for adaptive energy management systems. As an example, the work presented in (Mohebbi & Farrokhi, 2007) developed a neural network for optimal control. Prokhorov (Prokhorov D.V , 2008) used a neural network controller for improved fuel efficiency of the Toyota Prius hybrid electric vehicle. A new method to detect and mitigate a battery fault was also presented. The developed approach was based on recurrent networks and included the extended Kalman filter.

A.2 Classical Optimal Control

(Delprat et al., 2004) used the optimal control theory based on Lewis and Syrmos (Lewis & Syrmos., 1995) work. This method is directly applied to find a global solution for the energy management problem in a parallel torque-addition arrangement. The analytical nature of this method makes it a good one. However, variation of drivetrain structure makes it difficult to find an analytical solution, compared with numerical and iterative-based methods. Some optimal control have been developed for HEVs including (Wei et al., 2007) (Pisu & Rizzoni, 2007) (Musardo et al., 2007).

A.3 Linear Programming

This method can formulate the problem of optimizing the fuel efficiency as a nonlinear convex optimization problem that is approximated by a large linear program (Tate &

Boyd,1998). The approximations used for transformations and the fact that LP may not be applicable to a more sophisticated drivetrain degrade the proposed approach.

A.4 Dynamic and Stochastic Programming

Dynamic Programming (DP) method utilizes the minimizing cost function over a driving cycle. (Lin et al.,2003) demonstrated that the approach does not give a real-time solution by nature. A family of random driving cycles needs to be used to find an optimal solution.

A.5 Genetic Algorithm

The Genetic Algorithm (GA) has been used to solve a constrained nonlinear programming problem. (Piccolo et al.,2001) showed that GA is very useful for complex nonlinear optimization problems. This is because GA leads to a more accurate exploration of the solution space than a conventional gradient-based procedure. But GA does not give the necessary view to the designer of the powertrain, unlike an analytical approach. Montazeri et al. (Montazeri et al., 2006) described the application of genetic algorithm for optimization of control parameters in P-HEV.

B. Real Time Optimization (on line)

In order to develop a cost function for real-time optimization, the following methods can be used.

B.1 Model Predictive Control

(Salman et al., 2005) utilized a look-ahead window to find a real-time predictive optimal control law. This approach can be used for superior fuel economy by previewing the driving pattern and road information.

B.2 Decoupling Control

(Barbarisi et al.,2005) proposed a novel strategy to assure acceptable drivability of the vehicle that was based on the vehicle's dynamic model. Based on the proposed decoupling methods, the controller's output is composed of different components.

B.3 Genetic-Fuzzy

The genetic-fuzzy control strategy is a fuzzy logic controller that is tuned by a genetic algorithm. Poursamad et al. (Poursamad et al.,2008) and Montazeri et al. (Montazeri et al., 2008) applied these control strategy model to minimize fuel consumption and emission.

2.3 Discussions

The presented work is focused on a control strategy to reduce fuel consumption though considering performance and driveability. Our optimal control strategy is found in two steps, first finding the control which results in the reduction of fuel consumption together and offering the best performance, and second taking vehicle driveability into consideration. Among the control strategies for the best fuel economy, dynamic programming is the only one that assures global optimality if the driving cycle is known in advance.

However, it does not apply to real-time problems. On the other hand, fuzzy logic, rule-based, and neuro-fuzzy controllers are not generally optimized, but applied to real-time

problems. If the future driving conditions of a few minutes ahead can be predicted then the optimal controller can help find a suboptimal solution.

3. Factors Involved in Energy Management of Hybrid Electric Vehicles

Bandivadekar and Heywood (Bandivadekar & Heywood, 2007) presented an analysis that shows the possibility of halving the fuel consumption of new vehicles by 2035. Enhancement in vehicle control and management strategies is considered to be an influential mean in reducing the fuel consumption of vehicles. Energy management approaches in vehicles can be realised through considering a number of factors including (Cacciabue et al., 2009): environmental conditions, driver behaviour, vehicle specifications, and intelligent transportation approach (EPA, 2004). In order to develop an energy management system, a number of models need to be implemented and used. These models are described in the following.

3.1 Main factors involved in energy management system of HEVs

A HEV can be considered as a complex system consisting of subsystems. In the development of energy management systems, model of the HEV subsystems are developed and used. Fig. 2 shows an overview of the energy management model for HEVs.

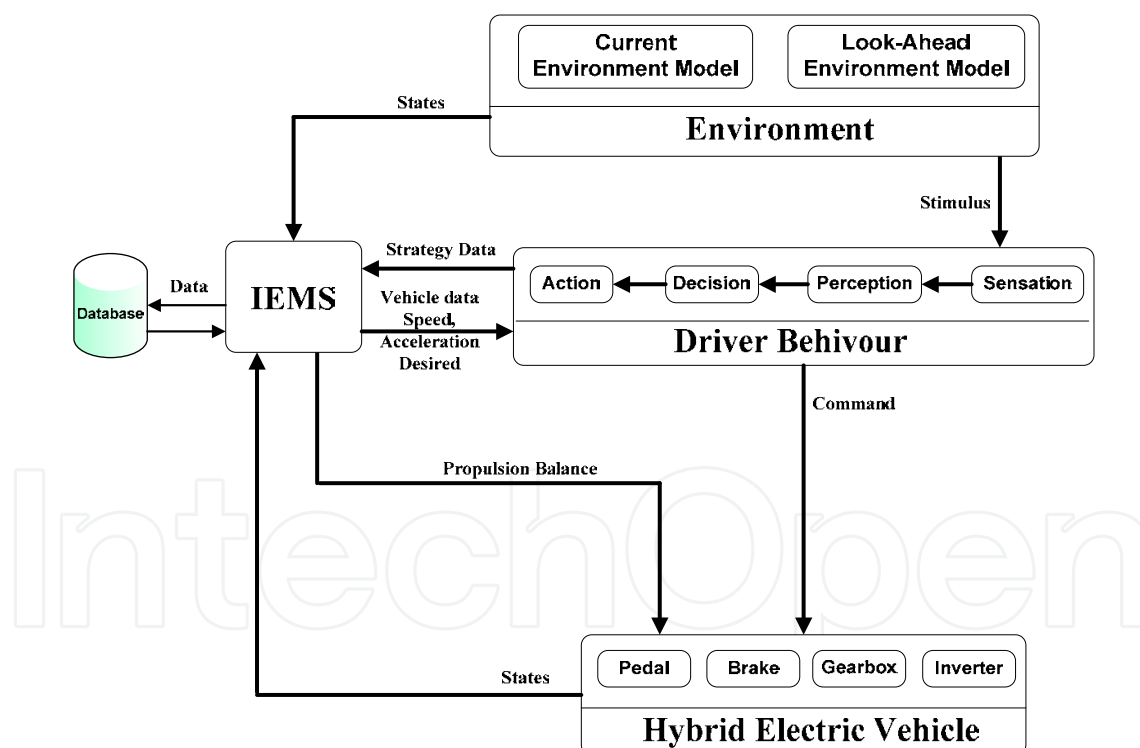

Fig. 2. Overview of the energy management model for HEVs.

3.2 Model of Environment

Among the factors that are involved in HEV systems, the environment conditions such as road geometrical specifications and wind behaviour are often unknown and uncertain during drives. The information about the geometrical specification and wind behaviour of the road

ahead of the vehicle can be used by an intelligent system to reduce fuel consumption of the vehicles (Khayyam et al., 2008). However, this information is often unavailable to the intelligent system on-board of a vehicle in real-time. Thus, utilising on-line and off-line prediction and monitoring of the geometrical specifications and wind behaviour of the road ahead of vehicles can improve their performances. Environmental information can be categorized in two groups: current and look-ahead. The data include road geometry, road friction, wind drag, and ambient temperature. It has been demonstrated that look-ahead environment information can be employed by the energy management system to achieve reduction of fuel consumption (Hellstrom et al., 2009). Khayyam et al. (Khayyam et al., 2008) presented a Slope Prediction Unit (SPU) to calculate the slope angle of the road within the distance of 50-300 meters away from the vehicle. This information reduced fuel consumption about 6.1% liter/100 km during simulation. Global Positioning Systems (GPS) and Geographic Information Systems (GIS) can provide static and dynamic road information.

Current Environment Model (CEM) is an algorithm that creates data associated with environmental conditions and frictions. Look-ahead Environment model (LEM) is an algorithm that creates data associated with future environmental conditions and frictions encountered by the vehicle.

In order to model environment, a number of methods can be used. Khayyam et al. (Khayyam et al., 2009a) proposed a method that can be used to produce authentic highway height data using a set of probability distributions. They considered a highway as a complex road which can have any kind of possible geometrical variations. The presented method models highway heights by Rayleigh probabilistic distribution function. In addition, highway geometric design laws were employed to modify the created highway data making it consistent with the real highway situation. The proposed model is then used to produce a 3D realistic road. The method is called a Probabilistic Highway Modelling (PMH) technique. PMH is capable of creating artificial highway and wind data that possess statistical characteristics of real highway and wind situations. A highway is considered to contain a collection of road segments. The Poisson Probability Distribution Function (PDF) is used to produce a random number that determines the number of road segments. Segments can then have different lengths. For each segment, the exponential PDF produces a random number that represents the segment length. In addition, for each segment, two other random numbers are generated and used to form the geometry of the segment. The Rayleigh PDF is employed to produce a random number that represents the height change of the segment. Also, the Gaussian PDF is used to form a random number that gives the bend deflection change in the segment. The random numbers for height and bend could be small or large injecting varying degrees of heights and bends into different road segments. Also, highway geometric design laws are used to modify the created highway data to make it consistent with the real physical highway situation.

A wind is constructed using a collection of regions of differing lengths. A wind creation algorithm is an iterative routine. The algorithm creates wind speed and direction values for each region. The exponential PDF produces a random number that represents the region length. The Weibull PDF is employed to produce a random number that represents the wind speed value in the region. Also, the uniform PDF is used to form a random number that gives the wind direction value in the region.

The PHM can be employed in simulation of problems involving highway roads such as energy optimization of conventional and hybrid electric vehicles. Fig. 3 displays a flowchart

diagram description of the highway creation algorithm using the PHM. The result of the highway creation algorithm demonstrates in Fig. 4 that show a 3D representation of the constructed sample highway using the PHM. Fig. 5 displays a flowchart diagram description of the wind creation algorithm using the developed PHM concept.

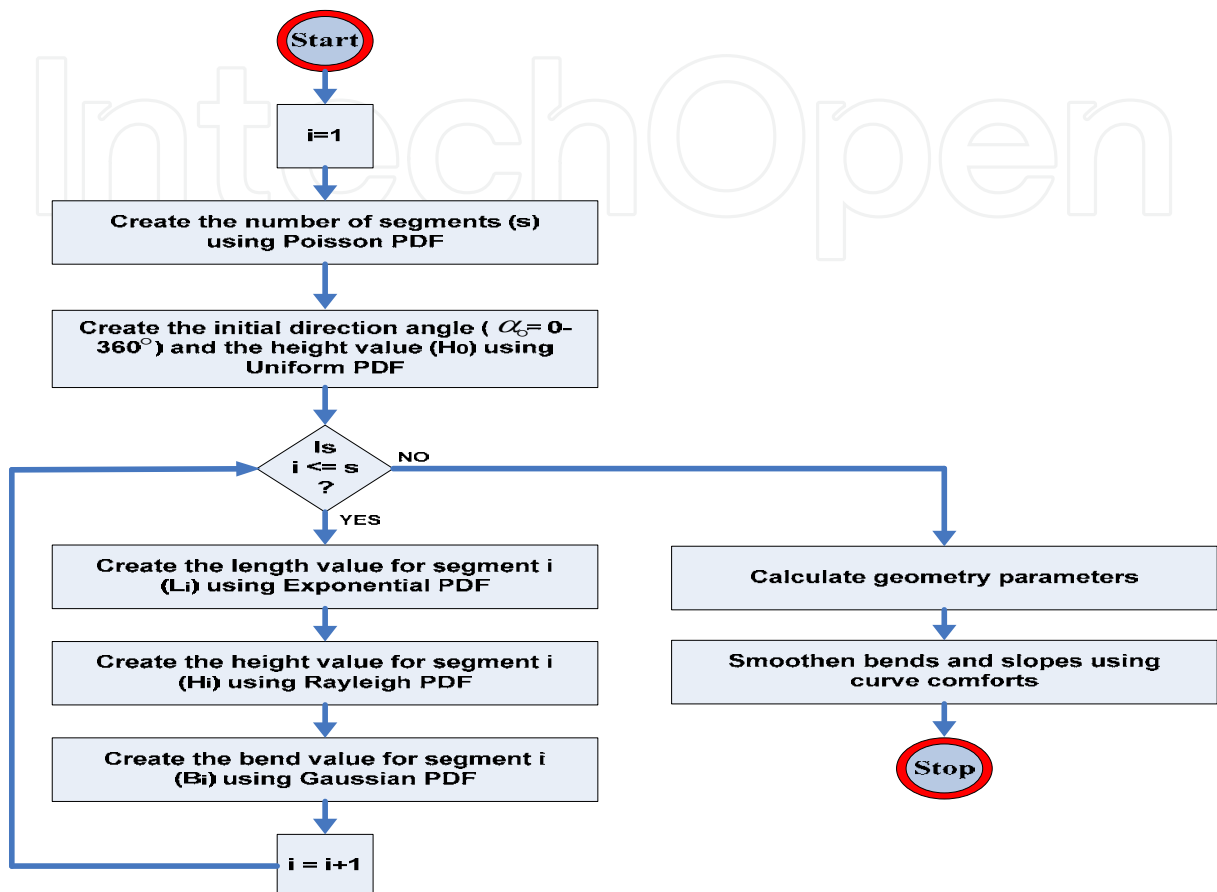

Fig. 3. Highway creation algorithm using the developed PHM.

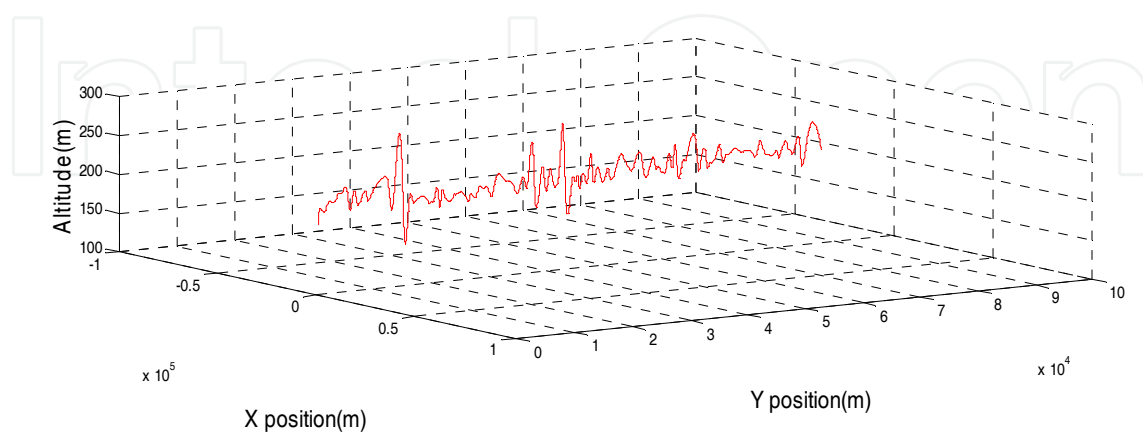

Fig. 4. 3D representation of the constructed sample highway using PMH technique.

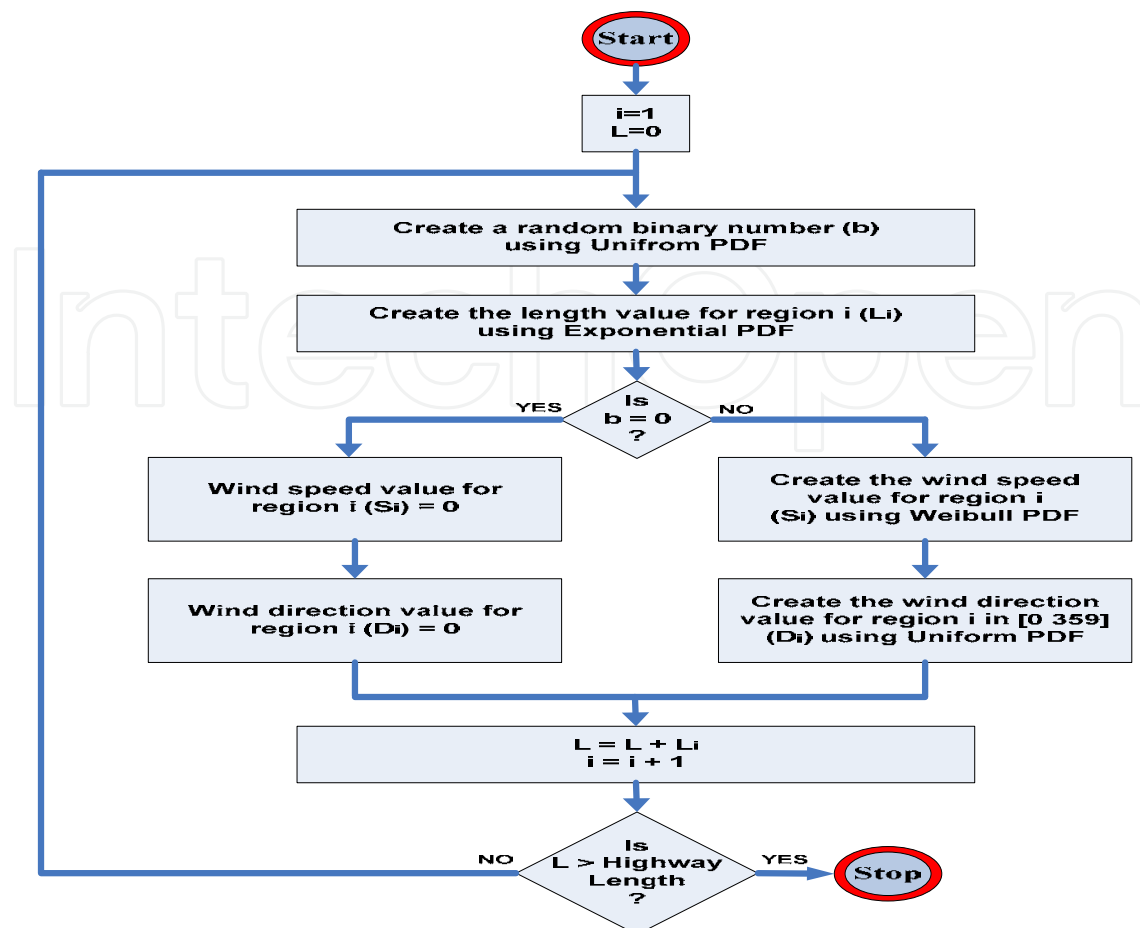

Fig. 5. Wind creation algorithm using the developed PHM.

3.3 Model of Driver

Driver behaviour has a strong influence on emissions and fuel consumption of the vehicle. Modelling driver behaviour can be done using different methods. As an example, the Driver-Vehicle-Environment (DVE) (Cacciabue, 2007) (Lin et al., 2005) method models human machine interaction and associated taxonomies for classifying human behaviour. De. Vlieger et al. (De. Vlieger et al., 2000) identified three types of driving behaviour as follows:

- 1- Calm driving that implies anticipating other road user's movement, traffic lights, speed limits, and avoiding hard acceleration.
- 2- Normal driving that implies moderate acceleration and braking.
- 3- Aggressive driving that implies sudden acceleration and heavy braking.

Moreover, they note that emissions obtained from aggressive driving in urban and rural traffic are much higher than those obtained from normal driving. A similar trend is observed in relation to fuel consumption. It is stated that the driving style affects the emission rate and the fuel consumption rate.

Average acceleration and Standard Deviation (SD) of acceleration over a specific driving range are used to identify the driving style. Acceleration criteria for the classification of the

driver's style are based on the acceleration ranges proposed by De Vlieger et al. (De Vlieger et al. 2000). They defined the typical ranges of average accelerations as describe in table 1.

Acceleration	Calm Driving	Normal Driving	Aggressive Driving
City Journey(m/s ²)	4.85-6.9	6.98-8.6	9.15-11.8
Highway Journey(m/s ²)	0.85	1.0	2.16

Table 1. Overview of the tested acceleration (De Vlieger et al., 2000).

Our objective is to use support dynamic real-time driver behaviour system in the energy management system. A driver first determines the drive strategy, selects the engine specifications, starts the vehicle motion, and controls the mass flow rate of fuel into ICE by changing the pedal, gear, brake, and clutch. Also, the driver sends this data as drive strategy to IEMS.

3.4 Model of Vehicle (Quasi-Static)

In a P-HEV, both the Internal Combustion Engine (ICE) and the Integrated Starter/Generator (ISG) can give tractive force to the wheels. Furthermore, the ISG will be used as a generator to supply the electric loads. A schematic drawing of the vehicle configuration is shown in Fig. 6.

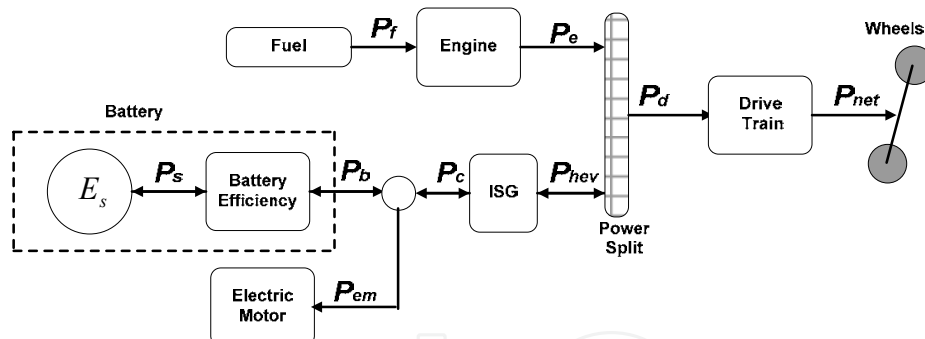

Fig. 6. P-HEV topology (Kessels,J,2007).

The power demand of the drivetrain P_d covers all the elements of the drivetrain, including the transmission and the clutch. The engine speed ω and the drivetrain torque t_d are calculated back from the vehicle speed and denote the driver's power demand:

$$P_d = \omega \tau_d \quad (1)$$

The power split device is assumed to have no energy losses and establishes the following power balance:

$$P_e = P_d + P_{hev} \quad (2)$$

Where : P_{hev} is hybrid power and P_e is engine power.

3.4.1 Conventional Vehicle Specification

A vehicle ICE can be treated as a controlled volume system whose energy balance is given as follows:

$$\begin{aligned}\dot{Q}_{combustion} &= (\dot{Q}_{fuel} + \dot{Q}_{air} - \dot{Q}_{exhaust}) \\ &= P_{road-friction} + P_{drag} + P_{slope} + P_{accessory} + P_{driving} + \dot{Q}_{water/oil} + \dot{Q}_{heatloss}\end{aligned}\quad (3)$$

In order to include all losses, Equation (3) is reformed into the following equation where the effect of different losses is taken into account by corresponding efficiencies:

$$\begin{aligned}(\dot{Q}_{combustion}) \times \eta_{otto} \times \eta_{fuel-air} \times \eta_{mechanical} \times \eta_{heat loss} &= P_{net} \\ &= P_{road-friction} + P_{drag} + P_{slope} + P_{accessory} + P_{driving}\end{aligned}\quad (4)$$

where: P_{net} = Power output of engine

$$\eta_{otto} = \text{Otto cycle efficiency} = 1 - \frac{1}{r_c^{(\gamma-1)}} = 0.529 \text{ (Pullkrabek,1997)}$$

$$\eta_{fuel-air} = \text{Real fuel air engine efficiency} = 0.75 \text{ (Yaodong Wang,2007)}$$

$$\eta_{mechanical} = \text{Mechanical efficiency} = 0.9 \text{ (Plint,1997)}$$

$$\eta_{heat loss} = \text{Heat loss efficiency} = 0.8 \text{ (Pullkrabek,1997)}$$

These efficiency are depend on some variable factors and situations. They can be measured by industrial vehicle companies. In the section 3.4.3 we will select specific efficiency in our model. To calculate $\dot{Q}_{combustion}$ Equation (3) is used:

$$\dot{Q}_{combustion} = \dot{m}_{fuel} \times q_{combustion}\quad (5)$$

where $q_{combustion}$ is the combustion energy. In this model, the fuel is assumed to be $C_nH_{1.87n}$ in (Wang et al., 2007). The complete combustion of $C_8H_{14.96}$ with $1+k$ percent theoretical air is written as:

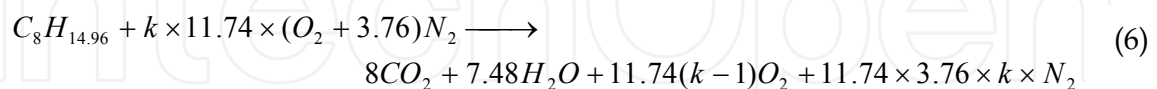

If the heat transfer was accurately measured, the released energy would be 109100 kJ/kg per 8 mole of CO_2 (Heywood .B.J, 1998). The result of Equation (6) gives:

$$q_{combustion} + \sum n_i [h_f + \Delta h]_i = W_{C.V.} + \sum n_e [h_f + \Delta h]_e\quad (7)$$

Where:

$$\sum n_i [h_f + \Delta h]_i = h_f C_8H_{14.96} + 1.2 \times 11.74 (O_2 + 3.76 \times N_2) = 793.23 \text{ kJ / kg}$$

Description	Type	Symbol	Value
Combustion			
Enthalpy of formation	E-F	\bar{h}_f°	Thermodynamic tables
Sensible formation	E-F	$\Delta \bar{h}$	Thermodynamic tables
Combustion energy	E-F	$q_{combustion}$	38017 kJ/kg
Mass flow rate of fuel combustion	V-O	\dot{m}_{fuel}	kg/s
Temperature of fuel	V-S	T_{fuel}	27 °C
Temperature of air	V-S	T_{air}	27 °C
Temperature of exhaust	V-S	$T_{exhaust}$	450 °C
Engine compression ratio	E-F	r_c	8.6
Air compression ratio	E-F	γ	1.35
Ratio of nitrogen per oxygen	E-F	$r_{N2/O2}$	3.76
Excess air	V-O	$E_{excessair}$	20%
Road			
Road friction	E-F	$F_{friction}$	$C_{rolling} mg \cos \Phi$
Road friction coefficient	E-F	$C_{rolling}$	0.01
Gravity acceleration	E-F	g	9.8 m/s ²
Vehicle velocity	V-O	V_1	16.6 m/s
Vehicle angle	V-O	θ_1	0°
Drag			
Drag friction	E-F	F_{drag}	$C_{drag}(\theta) \times \frac{1}{2} \rho V^2 A(\theta)$
Wind angle of attack	E-F	θ_2	Random direction (0-360°)
Wind velocity	E-F	V_2	0-6 m/s
Result wind and vehicle angle	V-O	θ	Calculate in simulation IEMS
Result of wind and vehicle speed	V-O	V_t	Calculate in simulation IEMS
Result of wind and vehicle speed	V-O	V_{t-1}	Calculate in simulation IEMS
Drag coefficient (By simulation)	V-S	$C_{drag}(\theta)$	$-(0.00005) \times (\theta) + 0.0097 \times (\theta) + 0.31$
Front surface area	V-S	$A(\theta)$	$1.8 \times 1 / \cos(\theta)$
Vehicle + passenger mass	V-O	m	1280 kg
Air density	E-F	ρ	1.225 kg/m ³
Slope			
Slope friction	R-O	F_{slope}	$mg \sin \Phi$
Road slope angle	R-O	Φ	$-1\% \leq \text{atan}(\Phi) \leq +0.6\%$
Radius of Comfort requirement	R-O	R	100 m
Accessory			
Accessory	V-O	$P_{accessory}$	0-4250 watt

V-S vehicle specification; V-O vehicle operation; E-F environment factors; R-O road condition.

Table 2. Parameters involved in energy balance equation

and

$$\sum n_e [h_f + \Delta h] e = 8CO_2 [h_f + \Delta_h] CO_2 + 7.48H_2O [h_f + \Delta_h] H_2O + 11.74 \times (0.2) O_2 [\Delta_h] O_2 + 11.74 \times 3.76 \times 1.2 \times N_2 [\Delta_h] N_2 = 37219.70 \text{ kJ / kg}$$

and $W_{C.V} = 0$

$$q_{combustion} = |-37219.70 + 793.23| = 38017.93 \text{ kJ / kg} \quad (8)$$

Substituting the terms stated in Table 2, the mass flow rate fuel consumption of the vehicle can be calculated as follows :

$$\dot{m}_{fuel} = \frac{P_{road\text{-}friction} + P_{drag} + P_{slope} + P_{accessory} + P_{driving}}{(q_{combustion}) \times \eta_{otto} \times \eta_{fuel\text{-}air} \times \eta_{mechanical} \times \eta_{heat\text{-}loss}} \quad (9)$$

The total fuel consumption in this process is:

$$m_{fuel} = \int_0^T \dot{m}_{fuel} \times dt \quad (10)$$

$$P_{net} = [F_{friction} + F_{drag} + F_{slope} + F_{accessory}] \times V_t + \frac{1}{\Delta t} [1/2 \times m \times (V_{t-1}^2 - V_t^2)]$$

where t is the total numbers of steps involved in the simulation.

The symbols given in these equations are described in Table 2. The acceleration of the vehicle in Δt time can be calculated as:

$$a_t = \frac{V_t - V_{t-1}}{\Delta t} = \frac{dV}{dt} \quad (11)$$

Also, the distance traversed by vehicle in Δt is:

$$X_t = \frac{1}{2} \times a_t \times \Delta t^2 + V_{t-1} \times \Delta t \quad (12)$$

3.4.2 Parallel Hybrid Electric Vehicle Specification

The ISG is mounted on the crankshaft of the ICE and therefore, it is also coupled to the drive train of the vehicle. Since the ISG model uses power based signals, it is not possible to observe speed-dependent characteristics. The ISG operates similar to the electric machine. It can operate in two modes: generator mode ($P_{hev} \geq 0$) and motor mode ($P_{hev} < 0$).

The electric power net connects the ISG with the electric loads and the battery. No losses are assumed in the electrical wires, leaving the following description:

$$P_c = P_{em} + P_b \quad (13)$$

Where: P_{em} is electric machine power, P_b battery power, and P_c electric loads.

The battery model consists of two subsystems: a static efficiency block and a dynamic energy storage block, see Fig. 7. The battery model is used where the losses grow proportionally with the power during charging ($P_b > 0$) and discharging ($P_b < 0$).

The efficiency block incorporates the energy losses during charging and discharging, whereas the energy storage block keeps track of the actual energy level E_s in the battery. At this point an integrator is used:

$$E_s(t_e) = E_s(0) + \int_0^t P_s(t) dt, P_b = \max(\eta^- P_s, \frac{1}{\eta^+} P_s) \tag{14}$$



Fig. 7. Battery Model

To indicate the actual charging level of the battery, the State of Charge (SOC) is often used. However, the physical background of SOC has a strong relation with battery models based on current and voltage. Because the proposed battery model is power based, the State of Energy (SOE) is more appropriate. The SOE expresses the relative energy status as follows:

$$SOE = \frac{E_s}{E_{cap}} \times 100 \% \tag{15}$$

Depending on the control strategy from the EM system, three different representations of the internal battery losses are taken into account, which approximate the relation between the power P_b at the battery terminals and the net internal power P_s . Table 3 provides the specifications of the battery and EM. The battery efficiency is considered as:

$$\eta_{bat} = \frac{2547600}{2881008} = 88 \% \tag{16}$$

Feature	Symbo l	Type
Battery (NHW11)		
Cells per module		6
Total Volts	Vmax	273.6
Capacity (Amp hours)		6.5
Capacity (Watt hours)		1778.4
Electric Motor		
Operating Voltage (V)	Vmin	273
Power (W)		33000-44000

Table 3. Parameters involved in energy balance equation

3.4.3 Control strategy and optimal torque

The control strategy involves calculation of the torque produced by ICE based on various parameters such as road load and battery SOC. This includes the calculation of an optimal torque based on contending ICE parameters, and deciding the actual torque output by later modifying the optimal torque based on road load and battery SOC. The optimal torque map is shown in Fig. 8.

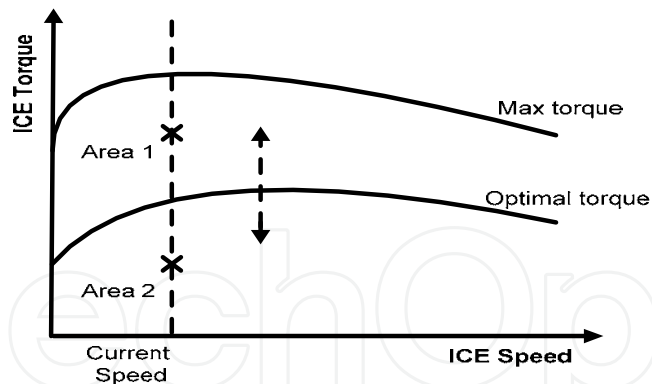

Fig. 8. Optimal torque map

At the same current speed, if the required torque is above the optimal torque (Area 1), the ICE torque should be decreased bringing it near the optimal torque point. It means that EM should be run as a motor to make up for the remaining torque, provided there is enough battery charge.

At the same current speed, if the required torque is below the optimal torque (Area 2), the ICE torque should be increased bringing it near to the optimal torque point. This is possible only if SOC is not high. We can run the EM as a generator, while running the ICE at its optimum.

In order to modeling, the following specification of engine and Motor/Inverter will be considered. Figs 9 and 10 show that the fuel converter efficiency operation and as well Motor/Inverter Efficiency.

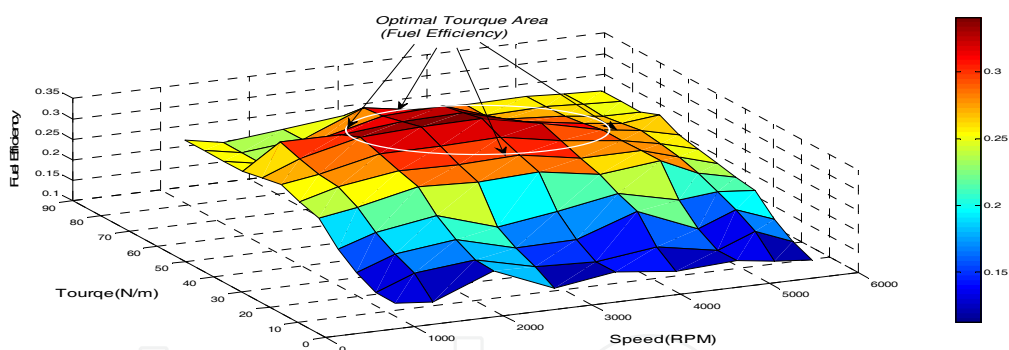

Fig. 9. Fuel Converter Operation Honda Insight 1.0i VTEC-E SI from ANL Test Data .

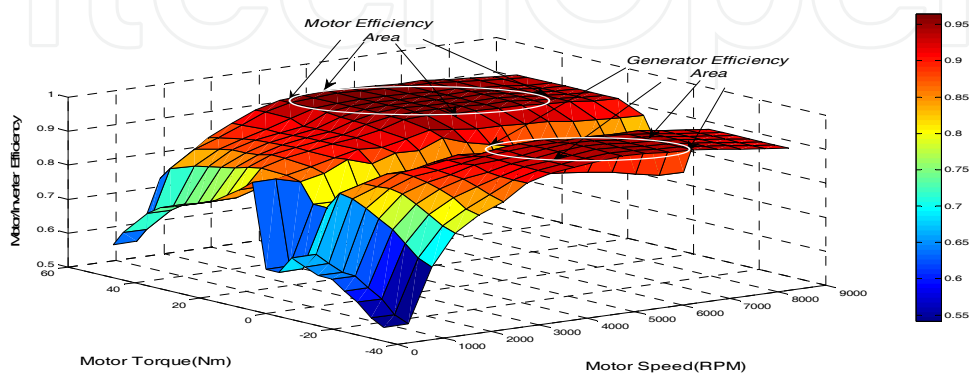

Fig. 10. Motor/Inverter Efficiency and Condition Torque Capability (Preliminary Model of Honda 10kw).

3.4.4 On-line adaptive strategy

The general control strategy for a parallel HEV can be summarized as follows (Shi et al.,2006):

- i. When the speed of the vehicle is small, ICE stops and electric motor gives the driving power required which avoids higher fuel consumption and reduce emission (It is assumed that SOC is sufficient).
- ii. When the speed of the vehicle is high enough, electric motor stops, ICE starts and gives the driving power required. Currently, ICE works along optimum curve depending on the cost function.
- iii. If the power required is larger than what ICE can give, ICE and electric motor work together and electric motor takes additional required power from the battery (It is assumed that SOC is sufficient).
- iv. If SOC of the battery drops under the safe level, ICE supplies both the energy required for travelling and extra power to charge the battery through electric motor (electric motor is at generator mode).
- v. In brake state, energy floats from vehicle body to drivetrain. Electric motor works as a generator and transforms braking energy to electricity to charge the battery.

4. Intelligent System Methods in Energy Management

Intelligent energy management methods can observe and learn driver behavior, environmental and vehicle conditions, and intelligently control the operation of the hybrid vehicle. This section describes intelligent system approaches with applications to design optimization, modeling, and control of complex systems and processes.

4.1 Introduction of Complex and Uncertain System

A Complex System is (Simon. H,1973) "A system that can be analyzed into many components having relatively many relations among them, so that the behaviour of each component depends on the behaviour of others".

In the real world, we can find many problems and systems that are too complex or uncertain to be represented in complete and accurate mathematical models. And yet, we still have the need to design, optimize, or control the behaviour of such systems. Complex system can be solved by artificial intelligent systems.

Advances in intelligent systems have brought new opportunities and challenges for researchers to deal with complex and uncertain problems and systems, which could not be solved by traditional methods. Methods developed for mathematically well-defined problems with precise models may lack in autonomy and thus cannot give adequate solutions under uncertain environments (Shin &Xu, 2009). Intelligent systems are defined with high degree of autonomy, reasoning with uncertainty, higher performance, high level of abstraction, data fusion, learning and adaptation (Shoureshi & Wormley,1990).

4.2 Soft Computing Techniques

Various soft computing based techniques have emerged as useful tools for solving engineering problems that were not possible or convenient to handle by traditional methods. The soft computing techniques give computationally efficient modelling, analysis, and decision making. The techniques that belong to the soft computing include artificial neural networks (ANNs), Fuzzy sets and systems, and evolutionary computation.

4.2.1 Artificial neural networks (ANNs)

ANNs are collections of small individually interconnected processing units. Information is passed between these units along interconnections. An incoming connection has two values associated with it, an input value and a weight. The output of the unit is a function of the summed value. ANNs while implemented on computers are not programmed to perform specific tasks. Instead, they are trained with respect to data sets until they learn patterns used as inputs. Once they are trained, new patterns may be presented to them for prediction or classification. ANNs can automatically learn to recognize patterns in data from real systems or from physical models, computer programs, or other sources. They can handle many inputs and produce answers that are in a form suitable for designers.

4.2.2 Genetic Algorithms (GA)

GA is based on the way living organisms adapt to life by evolution and inheritance. GA imitates the process of evolution of population by selecting fit individuals for reproduction. Thus, GA is an optimum search technique based on the concepts of natural selection and survival of the fittest. It works with a fixed-size population of possible solutions of a problem, called individuals, which are evolving in time. A genetic algorithm utilizes three principal genetic operators: selection, crossover, and mutation.

4.2.3 Fuzzy Logic (FL)

FL is used in control engineering. It is based on reasoning which employs linguistic rules in the form of IF-THEN statements. FL provides a simplification of a control methodology description. This allows the human language to be used to describe the problem and its solutions. In many control applications, the model of the system is unknown or the input parameters are variable and unstable. In such cases, fuzzy controllers can be applied. These are more robust and cheaper than conventional PID controllers. It is also easier to understand and modify fuzzy controller rules, which not only use human operator's strategy but, are expressed in natural linguistic terms.

4.2.4 Hybrid system (HS)

Techniques	Advantage	Limitation
Expert Systems also called Knowledge-Based Systems (KBS)	-Cost reduction in achieving a complex task	-The lack of expertise
Artificial Neural Networks (ANNs)	-Most of the problems are now able to be solved -Representing I/O relationships for nonlinear systems.	-Is only a special mathematical technique
Fuzzy logic (FL)	-Applied successfully in large number of uncertain applications	-Input/output controls of process are complicated
Genetic Algorithms (GAs)	-Optimisation	-Successful for some applications
Hybrid System (ANNs & FLS), (FLS & ANNs), (GAs & FLS) and (GAs & ANNs)	-Combination technique is capable to solve all problems of engineering discipline	-No

Table 4. Intelligent system methods.

HS combines multiple soft computing methods. For example, neuro-fuzzy controllers use neural networks and fuzzy logic, whereas in a different hybrid system a neural network may be used to derive some parameters and a genetic algorithm may be used subsequently to find an optimum solution to a problem. Table 4 presents a comparison of features of soft computing methods.

5. Proposed Intelligent Energy Management System

This work employs the analysis and simulation approach to develop an Intelligent Energy Management System (IEMS) for a HEV. The overview of IEMS is shown in Fig12. IEMS calculates the energy distribution and power flows in the powertrain of the vehicle and related losses. It indicates the ways to minimise the vehicles' fuel consumption under various driving conditions. IEMS learns when it is run, and makes proper adjustments to the way it operates to ensure that fuel consumption optimisation is achieved.

The developed model includes the following components:

5.1 Look-Ahead Environment Model Unit (LEM):

This unit employs an imaging sensor and a vision algorithm to calculate the slope angle of the road ahead within the distance of 300 meters away from the vehicle, and forward this information to IEMS.

5.2 Current Environment Model Unit (CEM):

This unit employs the following data from environment situation.

- i. Current Road Slope Module (CRSM): This module specifies the actual slope angle of the road at the current location of the vehicle.
- ii. Road Friction Module (RFM): This module gives road friction coefficient, gravity acceleration, and motion angle.
- iii. Wind Drag Module (WDM): This module provides the following wind parameters: wind speed, wind direction, and drag coefficient.

5.3 Friction Management Unit (FMU):

This module obtains CEM data and also the following data to calculate and send them to IEMS.

- i. Combustion Module (CM): This module employs the combustion process from the vehicle as described in Equation (6-8), and calculates and returns the amount of combustion energy needed.
- ii. Accessory Module (AM): This module represents the accessories embedded within the vehicle such as electrical devices and air conditioning.
- iii. Vehicle Efficiencies Module (VEM): This module defines the values of the otto cycle, real fuel air engine, mechanical and heat loss efficiencies.

5.4 Battery State of Charge (SOC):

This module provides the amount of current, temperature and voltage of the battery continuously. Figure 11 displays only that the useable area of charge on the hybrid battery, displayed "empty" is about 40% and displayed "full" is about 85%.

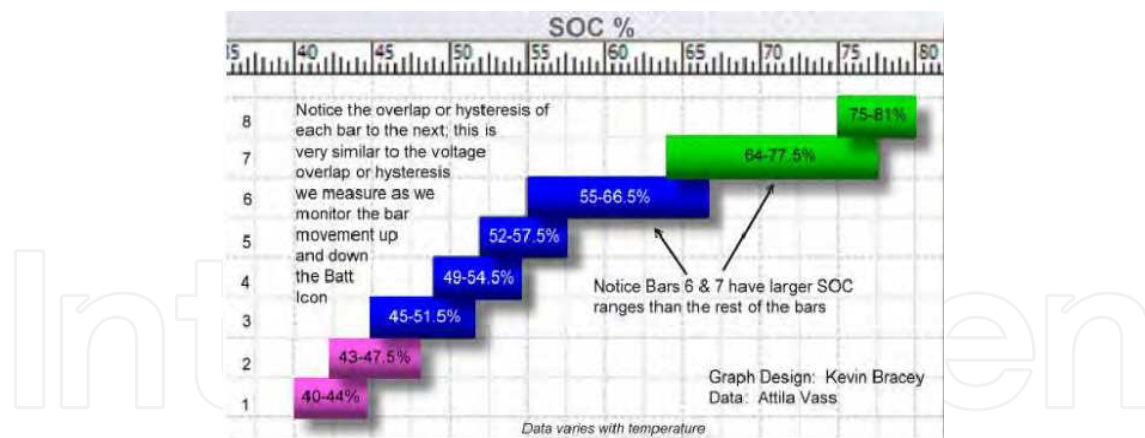

Fig. 11. The useable area of charge and discharge on the hybrid battery.

5.5 Control Strategy

In this work, the on-line adaptive strategy which was discussed in section 3.4.4, has been considered.

5.6 IEMS Algorithm

The overview of the simulation algorithm for IEMS is displayed in Fig. 13. The simulation starts with initialising several variables including normal power and primal kinetic energy for a moving vehicle. The data includes arrays of 7200 elements (steps). One iteration occurs in each step representing the time interval of 0.05 sec. Then the slope prediction data is retrieved from LEM. If the predicted slope angle is different from the current slope angle, STI block increases or decreases the power. Next, the vehicle/environment/friction data is retrieved from FMU. If the current total friction energy is different from the energy associated with the slope prediction, FTI block is triggered calculating the amount of power for all frictions. Otherwise, fuzzy logic controller (FLC) block is entered. FLC controls and optimises the fuel consumption with respect to the vehicle/efficiencies, speed, acceleration, and gear data. Also the FLC intelligently consider with drive strategy (see section 5.7) and control strategy. If the comparison is satisfied then these data will be forwarded to the next block where they overwrite the results of the previous iteration. Otherwise, the power of engine and inverter operation is corrected by decreasing or increasing. Once either of speed or acceleration is found to be greater than the desired limit, and then FLC will control the engine power and inverter operation by its algorithm. When either of speed or acceleration becomes smaller than the desired control strategy limit, the engine power is increased with regard to control strategy. In the assignment block, the old data is overwritten with the new data. The Inverter algorithm, shown in Fig. 14, synchronises the battery with EM, Gen. With regard to the battery SOC and IEMS Interpreter Load (IIL), inverter starts charging or discharging the battery in each time. It then informs the IEMS about its result via SOC. If SOC is high, and at times of high load, the generator can be switched off and EM can provide mechanical power via the battery by the inverter's instruction. The parameters of the FLC controller are optimized by genetic algorithm optimizer (GAO).

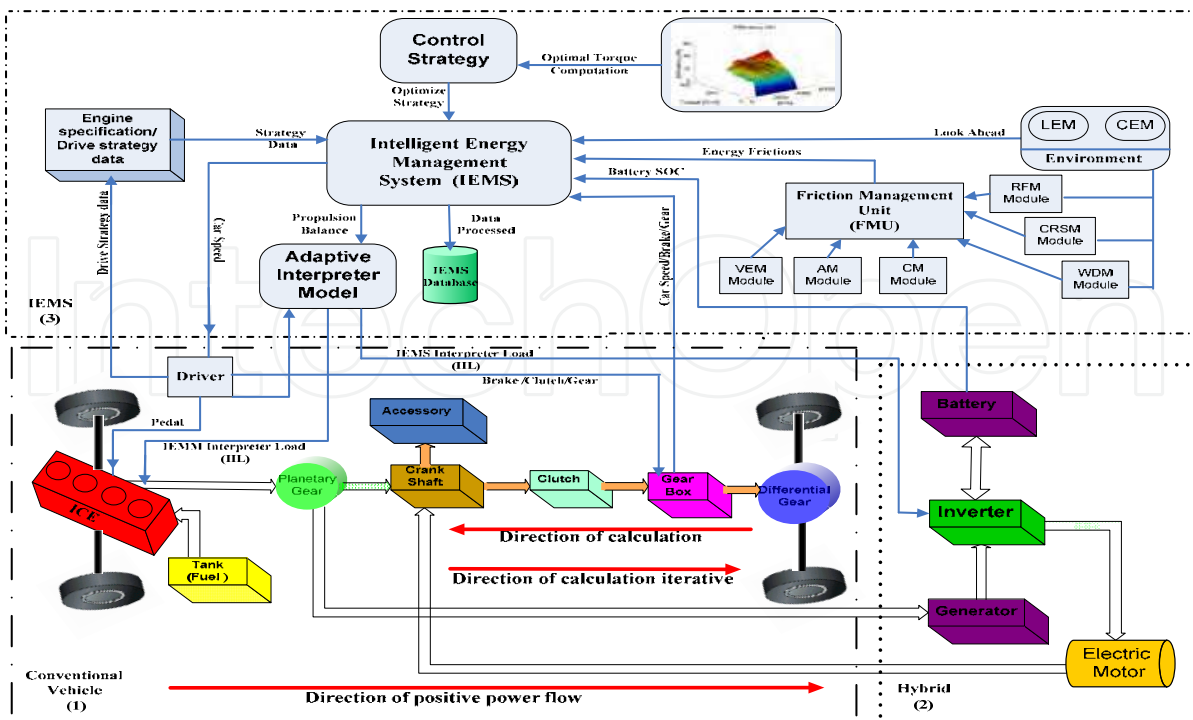

Fig. 12. Overview of the IEMS model.

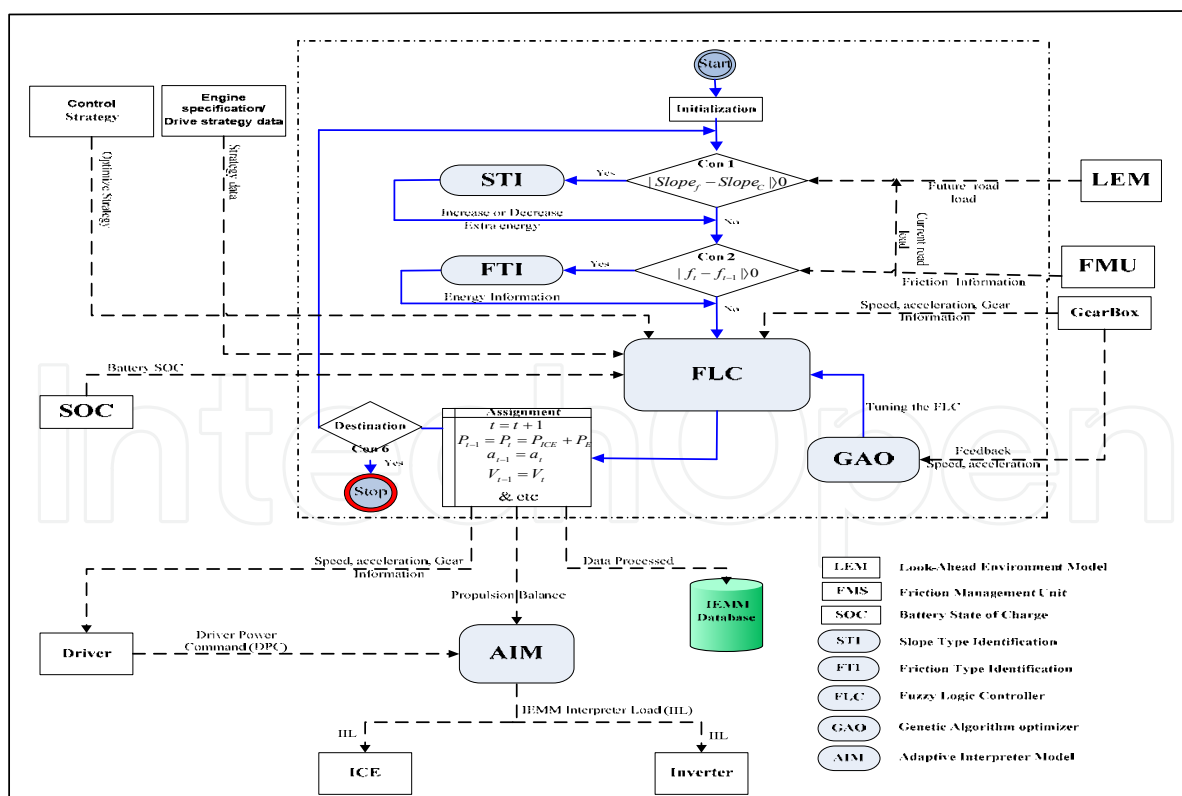

Fig. 13. Overview of the IEMS algorithm.

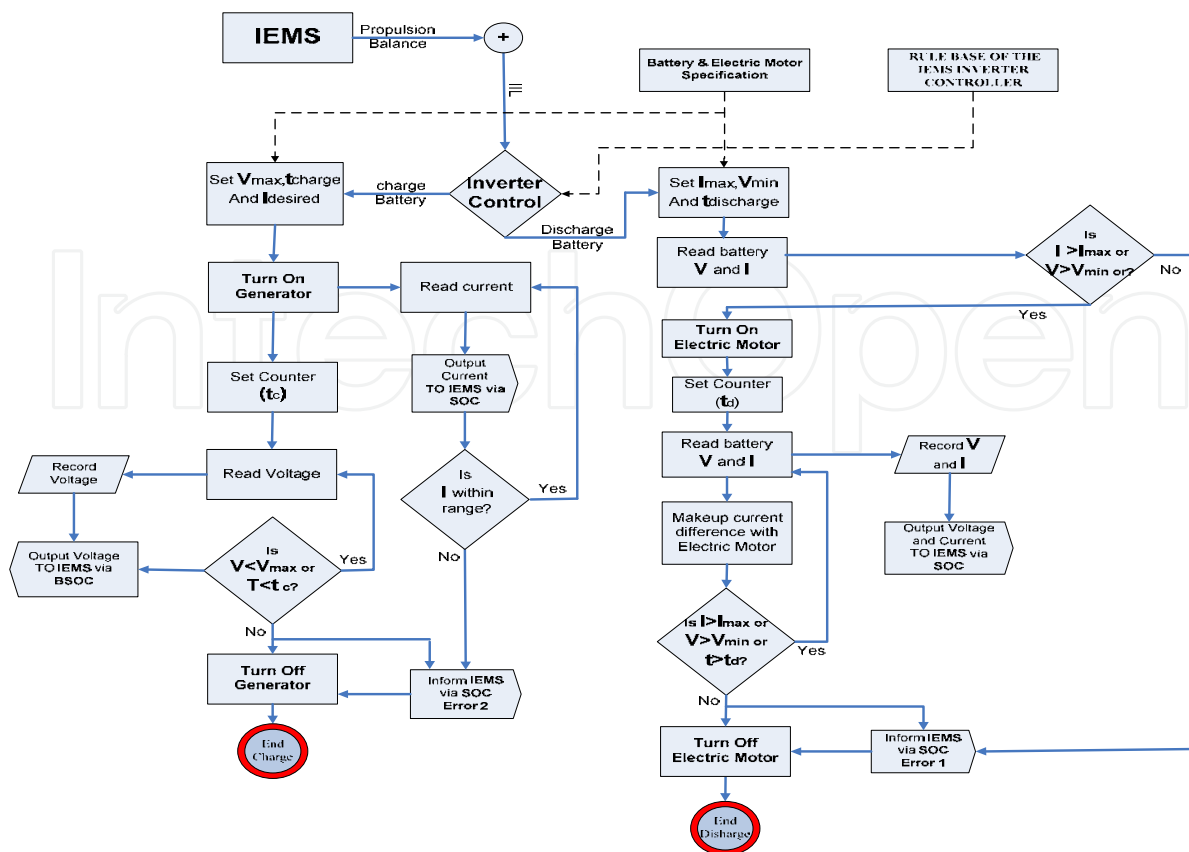

Fig. 14. Overview of the inverter algorithm.

5.7 Engine and EM/Gen Specification and Drive Strategy

In this work, we have considered a vehicle with the engine and specification as given in Table 5.

Parameters	Min	Max	Average
Engine size (litre)	----	1.1	-----
Engine RMP (Rev/min)	3000	4000	3500
Engine power (kW)	9.8	10.5	10
Engine Torque (N/m)	25	29	27
EM/Gen RPM (Rev/min)	3000	4000	3500
EM/Gen Torque(N/m)	8	12	10

Table 5. Engine and EM/Gen specification.

We have also formulated a set of parameters called “Drive Strategy” as shown in Table 6.

Parameters	Min	Max	Average
Engine size (litre)	----	1.2	-----
Speed (m/s)	16.38	16.94	16.66
Acceleration (m/s ²)	-0.98	0.98	0.5
Travel Time	-----	7200	0.05(s)
Travel Distance (m)		6000	

Table 6. Drive strategy parameters.

6. Simulation and optimization of hybrid vehicle

6.1 Simulation

6.1.1 Simulation 1

Khayyam et al (Khayyam et al, 2009b) demonstrated a Air Condition system simulation that, the vehicle was tested under sunny condition first for 1200 step for the vehicle speed around 20 m/s. Next, the fan and the air conditioning are turned on. The parameters given in Tables 7-9 were employed to achieve the comfort temperature in the cabin room for 6000 step. The air condition energy consumption shown in Fig 15(d).

Parameters	Min	Max	Normal
C.O.P	1.45	1.71	1.38
CAP (KW)	3.8	8.15	7.9
RMP (<i>rev / min</i>)	3000	4000	3500
Evaporator (KW)	5.51	13.93	10.90
Temperature (C) Gas R-134	0 Sub Cool	10 superheat	
Pressure (kPa) Gas R-134	310 Charge	2415 Discharge	

Table 7. Compressor specifications.

Parameters	Min	Max	Average
Volts	12.5	12.6	12.5
Amp	20	25	24
RMP (<i>rev / min</i>)	1000	1800	1200
Engine power (W)	250	315	300

Table 8. Blower specifications.

Parameters	Min	Max	Average
Temperature (C)	20	25.6	21.5
Humidity (%)	40	60	50
Air speed (m/s)	1	5	2.5

Table 9. Comfort cabin room specifications.

As discussed in section 3.2, some data has been created by PMH technique. The data created is associated with a slopped-windy-sunny condition. HEV was tested on this data, where the hybrid electric components were included. The road was set to be slopped with various slope angles within the range $-1\% \leq \text{atan}(\theta) \leq +0.6\%$. Moreover, the environmental wind was assumed to be non-zero. The wind angle of attack, θ_2 , was varied within the range 0 to 360°. Considering the wind velocity, however, different conditions were implemented: $V_2=0$ to 6. The Current Environment Model (CEM) component monitored the current slope. The following parameters were also considered: road-friction, combustion, and air conditioning accessory (Table1). Fig. 15 illustrates the slope angle, wind-speed, wind direction as well as A/C energy consumption data used in the simulation.

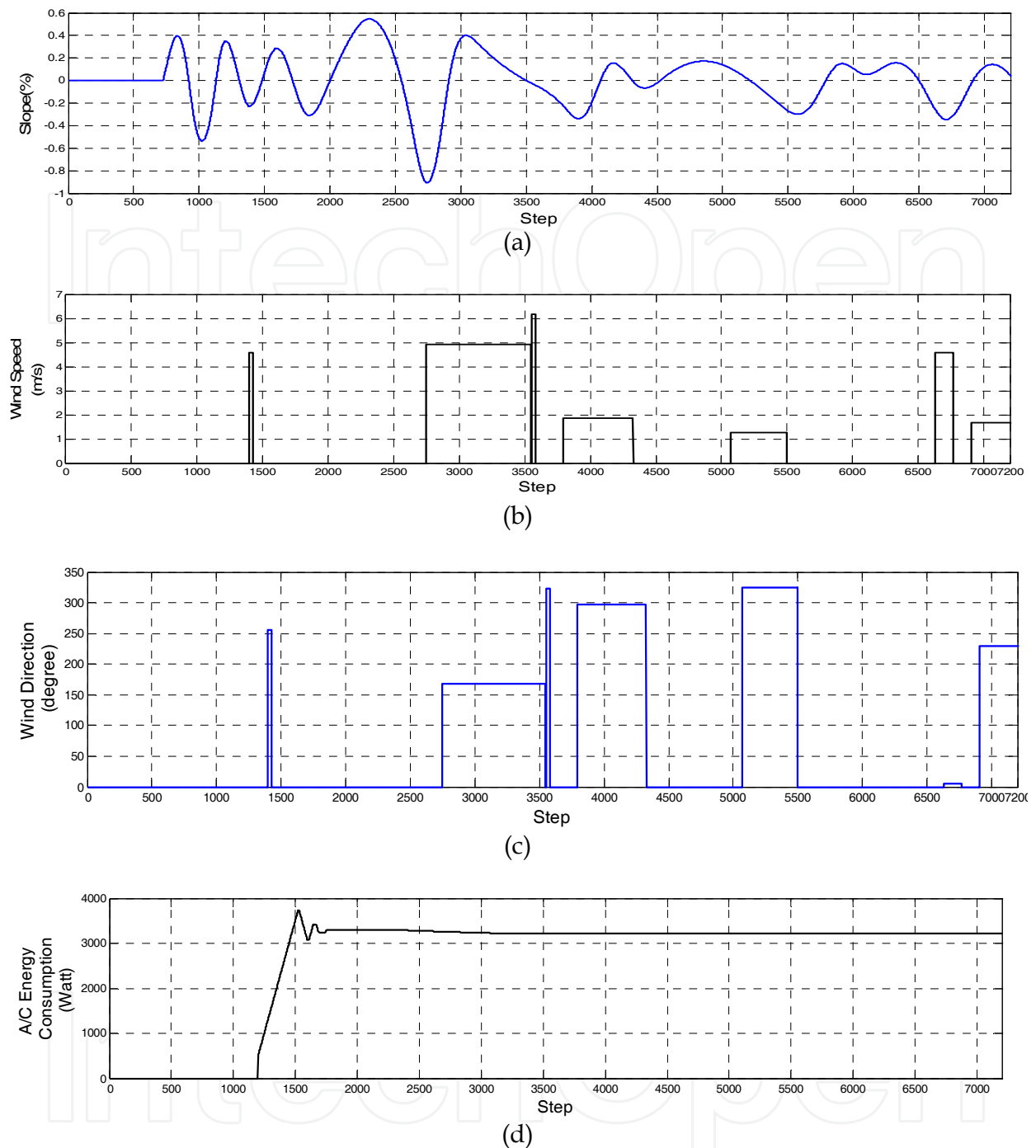

Fig. 15. (a) Slope (Road) angle data, (b) wind-speed data ,(c) wind-direction and (d) A/C energy consumption.

6.1.2 Simulation 2

IEMS-HEV was tested on a set of data associated with a sloped prediction (look-ahead within a 300 meter distance)-windy-warmed employing the hybrid electric components. The management of the battery, EM, and Gen is conducted by the inverter algorithm. This enables ICE and EM to output power simultaneously when the load is greater than 10 kW or a slope of greater than 0.1% is climbed by the vehicle. The following parameters were also

considered: road-friction, combustion, and air conditioning accessory. The predicted slope angle data is similar to the actual slope angle data.

6.2 Discussions

6.2.1 Simulation 1 Results

The power and fuel consumption results for the first simulation are shown in Fig. 16. Initially, 7800 W of energy is given to the vehicle so that the initial speed of 16.6 m/s is achieved. The energy consumption remained constant at 7800 W where the condition was flat-windless (e.g. steps 0-600). Depending on the condition of the road slope angle, the wind speed, angle of attack, and accessory energy consumption, the power consumption varied as shown in Fig. 16. The HEV was informed about the current slope by CEM.

Fig. 16 shows that the air conditioning system and slope friction have a significant impact on the fuel consumption. The reason is that it requires more fuel in a transit time. HEV can measure how much energy is needed in each step, and works out a desired fuel rate for the engine so that the power brake would not be needed. Using Equation (10), the average fuel consumption for Simulation 1 was found to be around 6.65 liter/100 km.

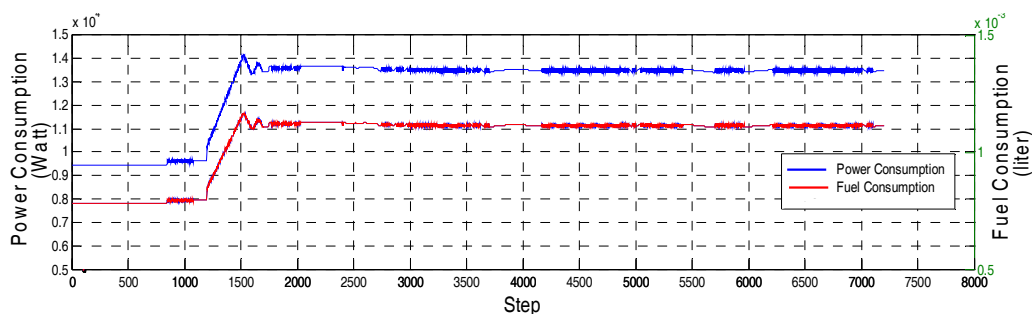

Fig. 16. Power and fuel consumption results for Simulation 1.

6.2.2 Simulation 2 Results

The power and fuel consumption results for the second simulation are shown in Fig. 17. Similarly, 7800 W of energy is initially given to the vehicle so that the initial speed of 16.6 m/s is achieved. Also, the Look-Ahead informed IEMS about any slope ahead. IEMS calculates and FLC investigates, and if the load is found to be greater than 10 kW or the slope greater than 0.1%, the propulsion balance requests ILL to switch on EM through inverter. The outcome of this simulation shows that the vehicle speed and acceleration are smoother than those of Simulation 1. Using Equation (10), the average fuel consumption for Simulation 2 was found to be around 6.11 liter/100 km. Fig. 18 shows the SOC of battery during the travel. It goes up to 85% and then comes down to the same level when used.

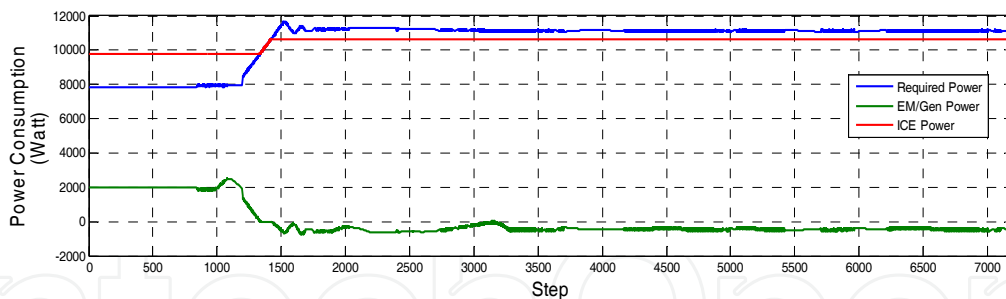

Fig. 17. Power consumption results for Simulation 2.

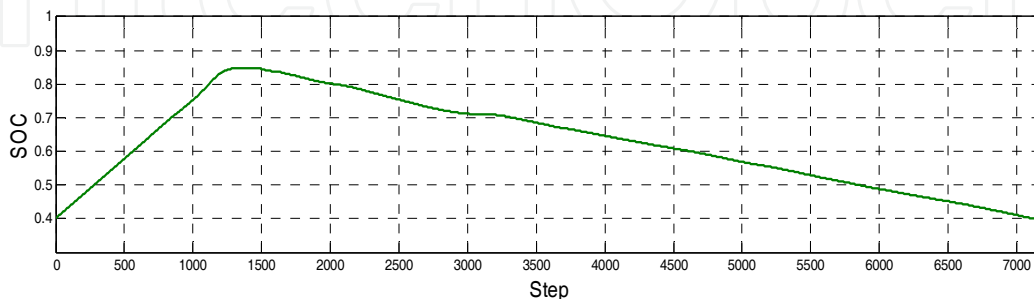

Fig. 18. SOC of battery.

7. Conclusions

This chapter presented a description of intelligent energy management systems for hybrid electric vehicles. In addition, an intelligent energy management model for a parallel hybrid electric vehicle was described. The model takes into account the role of combined wind/drag, slope, rolling, and accessories loads to minimize the fuel consumption under various driving conditions. Two simulation studies were conducted. They show that the vehicle speed and acceleration were smoother when the hybrid section was included. The average fuel consumption for Simulation 1 and 2 were found to be around 6.65 and 6.11 liter/100 km, respectively.

8. References

- A. Bandivadekar and J. Heywood,(2007) "Factor of two : halving the fuel consumption of new U.S. automobiles by 2035," Report from Laboratory for energy and the environment (MIT), vol. LFEE/.
- A. Piccolo, L. Ippolito, V. Galdi, and A. Vaccaro,(2001) "Optimization of energy flow management in hybrid electric vehicles via genetic algorithms," Proc. IEEE/ASME Int. Conf. Italy, pp. 434-439,.
- A. Sciarretta, M. Back, and L. Guzzella,(2004)"Optimal Control of Parallel Hybrid Electric Vehicles," IEEE Trans. on Control Systems Technology, vol. 12,.
- B. M. Baumann, G. Washington, B. C. Glenn, and G. Rizzoni,(2005) "Mechatronic design and control of hybrid electric vehicles," IEEE/ASME Transactions on Mechatronics, vol. 5, pp. 58-72, 2000.
- C. Musardo, G. Rizzoni, Y. Guezennec, B Staccia.(2005)"A-ECMS: An Adaptive Algorithm for Hybrid Electric Vehicle Energy Management"; European Journal of Control, Fundamental Issues in Control, Special Issue, Volume 11, Number 4-5.

- C. C. Lin, H. Peng, and J. W. Grizzle,(2003) "Power management strategy for a parallel hybrid electric truck," IEEE Trans. on Control Systems Technology, vol. 11, pp. 839-849,.
- C. C. Linl, H. Pengl, and J. W. Grizzle, (2004)"A Stochastic Control Strategy for Hybrid Electric Vehicles," Proceeding of the 2004 American Control Conference Boston, Massachusetts, vol. 4710-4715,.
- E. D. Tate and S. P. Boyd,(1998) "Finding ultimate limits of performance for hybrid electric vehicles," SAE, vol. 00FTT-50,.
- E. Hellstrom, M. Ivarsson, J. Aslund, and L. Nielsen,(2009) "Look-ahead control for heavy trucks to minimize trip time and fuel consumption," control Engineering Practice, vol. 17, pp. 245-254,.
- EPA, (2004)"Assessing the emission and fuel consumption impacts of intelligent transportation system(ITS)," EPA, vol. 231, pp. 98-007,.
- G. J. v. Wylen and R. E. Sonntag,(1990)"fundamentals of classical thermodynamics " vol. Third edition SI version.
- G. Shi, Y. Jing, A. Xu, and J. Ma, (2006)"Study and Simulation of Based-fuzzy-logic Parallel Hybrid Electric Vehicles Control Strategy," Proceedings of the Sixth International Conference on Intelligent Systems Design and Applications pp. 280-284,.
- H. Khayyam, A. Z. Kouzani, and E. J. Hu,(2008) "An intelligent energy management model for a parallel hybrid vehicle under combined loads," in IEEE International conference on vehicular electronics and safety Columbus, OH, USA 2008, pp. 145-150.
- H. Khayyam, A. Z. Kouzani, and E. J. Hu,(2009b) "Reducing energy consumption of vehicle air conditioning system by an energy management system," IEEE The 4th Internationnal Green Energy Conferance Beijing, China, vol. 1
- H. Khayyam, A. Z. Kouzani, H. Abdi, and S. Nahavandi,(2009a) "Modeling of highway heits for vehicle modeling and simulation " Proc. ASME/IEEE Int. Conf. MESA09 USA.
- J. B. Heywood, (1998)"Internal combustion engine fundamentals," McGraw-Hill, New York,.
- J. S. Won, (2003)."Intelligent energy management agent for a parallel hybrid vehicle," PhD Thesis 2003.
- J. T.B.A. Kessels, (2007) "Energy Management for Automotive Power Nets," PhD thesis 2007.
- L. L. Yaodong Wang, (2007)"An analytic study of applying Miller cycle to reduce Nox emission from petrol engine " Applied Thermal Engineering, vol. 27, pp. 1779-1789,.
- Lewis, Frank L. & Syrmos, Vassilis L. (1995) "Optimal Control" Hohn Wiley & Sons Inc. Newyork.
- M. Ehsani, Y. Gao, S. E. Gay, and A. Emadi, (2005) "Modern electric, hybrid electric, and fuel cell vehicles", New York CRC PRESS.
- M. Farrokhi and M. Mohebbi, (2005) "Optimal Fuzzy Control of Parallel Hybrid Electric Vehicles," ICCAS2005 June 2-5.
- M. Mohebbi and M. Farrokhi,(2007) "Adaptive neuro control of parallel hybrid electric vehicles," Int. J. Electric and Hybrid Vehicles, vol. 1,.
- M. Mohebbi, M. Charkhgard, and M. Farrokhi,(2005)"Optimal neuro-fuzzy control of parallel hybrid electric vehicles," Vehicle Power and Propulsion, 2005 IEEE Conference, pp. 26-30.
- M. Plint and A. Martyr,(1997) "Engine testing theory and practice," Butter worth-Heinemann British Library .

- M. Salman, F. Change, and J. S. Chen,(2005) "Predictive energy management strategies for hybrid vehicles," IEEE Conf. Decision Control pp. 21-25,.
- M. Salman, N. J. Schouten, and N. A. Kheir, (2000) "Control strategies for parallel hybrid vehicles", American Control Conference, vol. 1, pp. 524-528.
- Manins ,P.C.(2000)."Environmental impact of the new Australian Hybrid Cars " Proceedings of the 15th International Clean Air and Environment Conference vol. 26-30, pp. 117-122,.
- N. J. Schouten, M. A. Salman, and N. A. Kheir,(2002)"Fuzzy logic control for parallel hybrid vehicles," IEEE Transactions on Control Systems Technology, vol. 10, pp. 460-468, .
- O. Barbarisi, E. R. Westervelt, F. Vasca, and G. Rizzoni,(2005) "Power management decoupling control for a hybrid electric vehicle," IEEE Conf on Decision and Control, Spain, pp. 2012-2017.
- P. C. Cacciabue, (2007)"Modelling driver behaviour in automotive environments ": Springer 2007.
- P. Pisu, G. Rizzoni, (2007) "A Comparative Study of Supervisory Control Strategies For Hybrid Electric Vehicles" IEEE Transactions on Control Systems Technology, Special Issue on Control Applications in Automotive Engineering,
- Q. R. Riley, (1994)"Alternative cars in the 21 century a new personal transportaion paradigm," SAE International, vol. 1994,.
- R. Langari and J.-s. W. Won, (2005)"Intelligent Energy Management Agent for a Parallel Hybrid Vehicle-Part 1 : System Architecture and Design of the Driving Situation Identification Process," IEEE Transactions on Vehicular Technology vol. 54, pp. 925-934,.
- R. Shoureshi and D. Wormley,(1990) "Intelligent control systems," Final report of NSF/EPRI,.
- R. Zhang and Y. Chen, (2001) "Control of hybrid dynamical systems for electric vehicles,"American Control Conference, vol. 4, pp. 2884-2889,
- S. Barsali, C. Miulli, and A. Possenti, (2004)"A control strategy to minimize fuel consumption of series hybrid electric vehicles," IEEE Transaction on Energy Conversion, vol. 19, pp. 187-195,
- S. Delprat, J. Lauber, T. M. Guerra, and J. Rimaux,(2004) "Control of a Parallel Hybrid Powertrain: Optimal Control," IEEE Transaction on vehicular technology, vol. 53, pp. 872-881,.
- S. E. Lyshevski,(1999)"Diesel-Electric Drivetrains for Hybrid-Electric Vehicles: New Challenging Problems in Multivariable Analysis and Control," Proceedings of the 1999 IEEE International Conference on Control Applications vol. 1, pp. 840-845,.
- S. M. T. Bathaee, A. H. Gastaj, S. R. Emami, and M. Mohammadian,(2005) "A fuzzy-based supervisory robust control for parallel hybrid electric vehicles," Vehicle Power and Propulsion, 2005 IEEE Conference, pp. 694-700,.
- Simon, Herbert A., (1973) "The Organization of Complex Systems," in Hierarchy Theory, ed. by Howard H. Pattee, New York: George Braziller,
- SOE,(2006) "Independent report to the Australian Government Minister for the Environment and Heritage " <<http://www.environment.gov.au/soe/2006/publications/report/index.html>>, 2006.
- W. W. Pullkrabek,(1997)"Engineering fundamentals of the internal combustion engine " Prentice Hall.

- X. Wei, L. Guzzella*, V. I. Utkin and G. Rizzoni, (2007) "Model-based Fuel Optimal Control of Hybrid Electric Vehicle Using Variable Structure Control Systems", ASME Transactions. Journal of Dynamic Systems, Measurement, and Control - Volume 129, Issue 1, pp. 13-19.
- Y. C. Shin and C. Xu,(2009)" Intelligent Systems modeling, optimization, and control" Boca Raton : CRC Press,.
- Y. Lin, P. Tang, W. J. Zhang, and Q. Yu,(2005)"Artificial neural network modelling of driver handling behaviour in a driver-vehicle-environment system," International Journal of Vehicle Design, vol. 37, pp. 24-45,.
- Y. Wang, L. Lin, and A. rosily(2007). "An analytic study of applying Miller cycle to reduce Nox emission from petrol engine " Applied Thermal Engineering, vol. 27, pp. 1779-1789
- Y. Zhu, Y. Chen, and Q. Chen,(2002) "Analysis and Design of an Optimal Energy Management and Control System for Hybrid Electric Vehicles," Proc. of the 19th Electric Vehicles Symposium, Busan, Korea,.

IntechOpen

IntechOpen

IntechOpen



Energy Management

Edited by Francisco Macia Perez

ISBN 978-953-307-065-0

Hard cover, 246 pages

Publisher InTech

Published online 01, March, 2010

Published in print edition March, 2010

Forecasts point to a huge increase in energy demand over the next 25 years, with a direct and immediate impact on the exhaustion of fossil fuels, the increase in pollution levels and the global warming that will have significant consequences for all sectors of society. Irrespective of the likelihood of these predictions or what researchers in different scientific disciplines may believe or publicly say about how critical the energy situation may be on a world level, it is without doubt one of the great debates that has stirred up public interest in modern times. We should probably already be thinking about the design of a worldwide strategic plan for energy management across the planet. It would include measures to raise awareness, educate the different actors involved, develop policies, provide resources, prioritise actions and establish contingency plans. This process is complex and depends on political, social, economic and technological factors that are hard to take into account simultaneously. Then, before such a plan is formulated, studies such as those described in this book can serve to illustrate what Information and Communication Technologies have to offer in this sphere and, with luck, to create a reference to encourage investigators in the pursuit of new and better solutions.

How to reference

In order to correctly reference this scholarly work, feel free to copy and paste the following:

Hamid Khayyam, Abbas Kouzani, Saeid Nahavandi, Vincenzo Marano and Giorgio Rizzoni (2010). Intelligent Energy Management in Hybrid Electric Vehicles, Energy Management, Francisco Macia Perez (Ed.), ISBN: 978-953-307-065-0, InTech, Available from: <http://www.intechopen.com/books/energy-management/intelligent-energy-management-in-hybrid-electric-vehicles>

INTECH
open science | open minds

InTech Europe

University Campus STeP Ri
Slavka Krautzeka 83/A
51000 Rijeka, Croatia
Phone: +385 (51) 770 447
Fax: +385 (51) 686 166
www.intechopen.com

InTech China

Unit 405, Office Block, Hotel Equatorial Shanghai
No.65, Yan An Road (West), Shanghai, 200040, China
中国上海市延安西路65号上海国际贵都大饭店办公楼405单元
Phone: +86-21-62489820
Fax: +86-21-62489821

© 2010 The Author(s). Licensee IntechOpen. This chapter is distributed under the terms of the [Creative Commons Attribution-NonCommercial-ShareAlike-3.0 License](#), which permits use, distribution and reproduction for non-commercial purposes, provided the original is properly cited and derivative works building on this content are distributed under the same license.

IntechOpen

IntechOpen