

We are IntechOpen, the world's leading publisher of Open Access books Built by scientists, for scientists

4,800

Open access books available

122,000

International authors and editors

135M

Downloads

Our authors are among the

154

Countries delivered to

TOP 1%

most cited scientists

12.2%

Contributors from top 500 universities



WEB OF SCIENCE™

Selection of our books indexed in the Book Citation Index
in Web of Science™ Core Collection (BKCI)

Interested in publishing with us?
Contact book.department@intechopen.com

Numbers displayed above are based on latest data collected.
For more information visit www.intechopen.com



Motor Energy Management based on Non-Intrusive Monitoring Technology and Wireless Sensor Networks

Hu Jingtao

Key Laboratory of Industrial Informatics

Shenyang Institute of Automation, Chinese Academy of Sciences

China

1. Introduction

Induction motors are widely used in industry as essential driving machines. There are many motor driven systems in plants, such as pumping systems, compressed air systems, and fan systems, etc. These motor driven systems use over 70% of the total electric energy consumed by industry. Because of the oversized installation or under-loaded conditions, motors generally operate at low efficiency which results in wasted energy. To improve the motor energy usage in industry, motor energy management should be done.

The motor energy management is based on the motor energy usage evaluation and condition monitoring. Over the years, many methods have been proposed. But these methods are too intrusive for in-service motor monitoring, because they need either expensive speed and/or torque transducers, or an accurate motor equivalent circuit. Non-intrusive methods should be developed.

Another problem comes from the communication network. Energy usage evaluation and condition monitoring systems in industrial plants are usually implemented with wired communication networks. Because of the high cost of installation and maintenance of these cables, it is desired to look for a low-cost, robust, and reliable communication network.

This paper presents a motor energy management system based on non-intrusive monitoring technologies and wireless sensor networks. In the following sections, some key technologies for motor energy management are discussed. At first, a three-layer system architecture is proposed to build a motor energy management system. And an in-service motor condition monitoring system based on non-intrusive monitoring technologies and wireless sensor networks is presented. Then wireless sensor networks and its application in motor energy management are discussed. The design and implementation of a WSN node are presented. Thirdly, non-intrusive motor current signature analysis technology is introduced to make motor energy usage evaluation. Applying the efficiency estimation method introduced, a front-end device used to monitor motors is developed. At last, the motor monitoring and energy management system is deployed in a laboratory and some tests are made to verify the design. The system is also applied in a plant to monitor four pumping motors.

2. In-Service Motor Monitoring and Energy Management System

2.1 Motor Energy Management Architecture

Motor energy management is a complicated program which embodies optimal design, operation, and maintenance of motor driven systems to use energy efficiently. The system optimization is based on the motor condition monitoring, energy usage evaluation, and energy saving analysis. Such work is so complex that before developing a motor energy management system, we need to construct a system architecture to guide the system development.

This paper presents a three-layer system architecture which is composed of a data acquisition platform, a condition monitoring platform, an energy consumption and saving analysis platform, a communication platform, and a motor energy data management platform, as illustrated in Fig. 1.

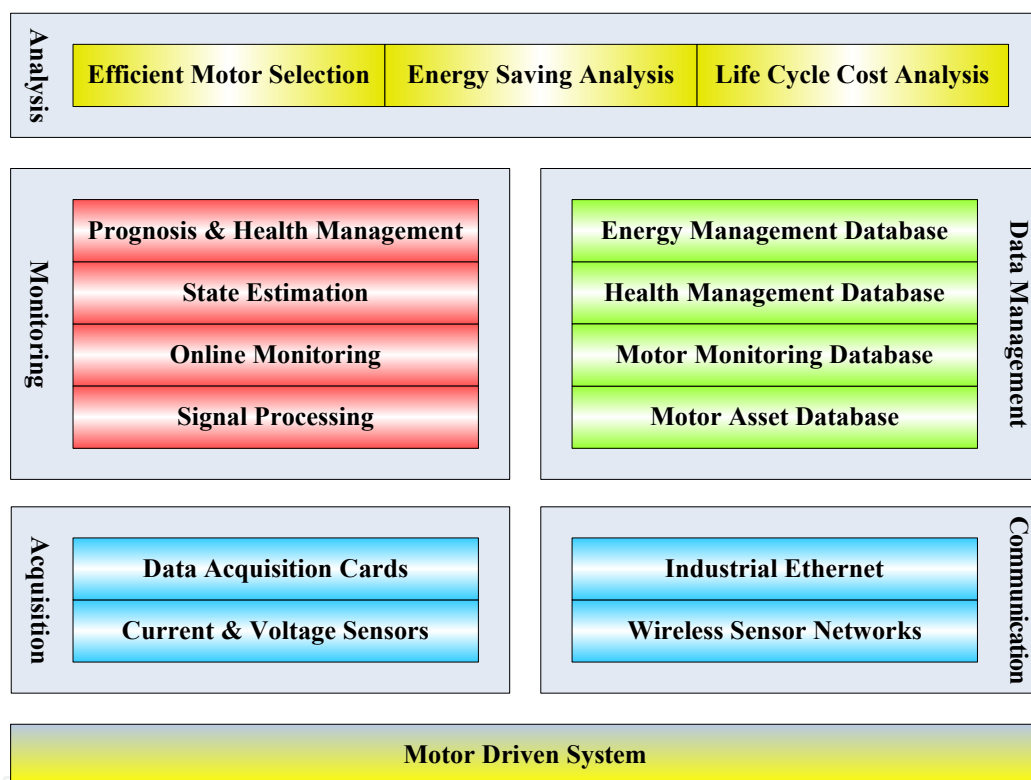

Fig. 1. Motor energy management architecture

The need of data acquisition comes first to monitor the operation of a motor driven system. We need data acquisition cards to collect raw signals coming from sensors, such as current and voltage sensors, and transmit them to the monitoring system over a communication network. There are many ways to build a network, such as field bus, industrial Ethernet, and wireless sensor networks. The data acquisition and communication platforms form the base of a motor energy management system.

Upon the data acquisition is the motor condition monitoring platform. Based on the digital signal processing (DSP) technologies, the operation conditions of motors are monitored, and the health state and the energy usage of motors are evaluated. Such functions need data management abilities. So some databases are created and maintained, including motor asset database, motor monitoring database, health management database, and energy

management database, etc. The condition monitoring platform and data management platform form the main body of a motor energy management system.

At the top level are some applications to make motor energy management. To replace the inefficient motors currently used, motor selection can be made based on the energy usage evaluation of the motors. Energy saving analysis and life cycle cost analysis can be done for the replacement. That's the energy consumption and saving analysis platform.

2.2 In-Service Motor Monitoring System

An in-service motor monitoring and energy management system was developed based on the architecture presented in section 2.1. The system has two subsystems: a data acquiring and analysis subsystem deployed at the motor control centre (MCC), and a condition monitoring and energy management subsystem running at a central supervisory station (CSS), as illustrated in Fig. 2.

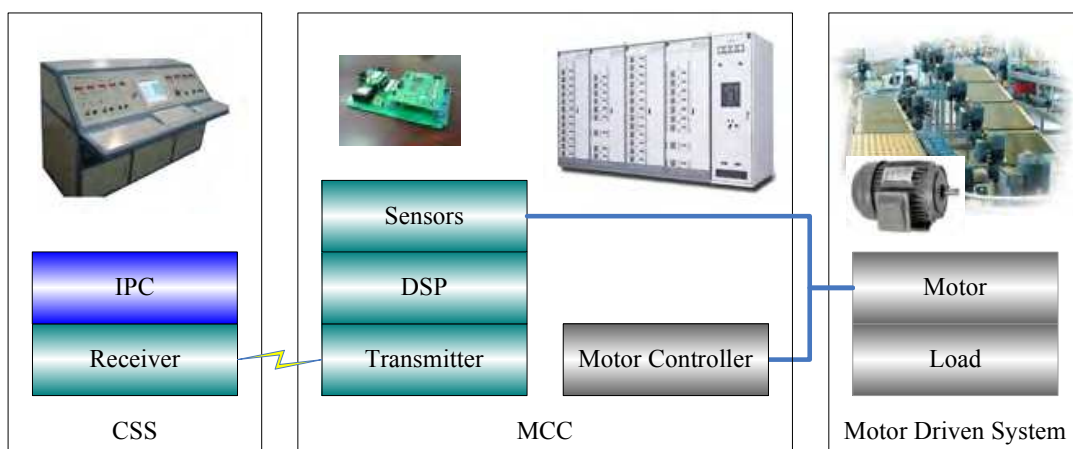

Fig. 2. In-service motor monitoring and energy management system

The data acquiring and analysis subsystem consists of some front-end devices which are used to acquire data and analyze the motors conditions. One front-end device is composed of three parts: a sensor unit, a processing unit and a communication unit.

The sensor unit is used to detect the line current and line voltage signals from the power supplied to a motor. Only the current and voltage sensors are used. Without any other sensors, the motor system is disturbed minimally.

The processing unit based on digital signal processing technologies gathers and analyzes those signals to determine the condition of motors. Some signal processing and inferential models are used to evaluate the energy and health conditions of the motors, as illustrated in Fig. 3.

The communication unit is used to send the results to the condition monitoring and energy management subsystem running at a central supervisory station, which gathers and stores the analysis results, evaluates the energy usage, and analyzes the energy savings. Here the communication is based on the wireless sensor networks.

The condition monitoring and energy management subsystem has a friendly graphic user interface (GUI). The condition of a motor is monitored on the main screen by 8 parameters, including the rotor speed, torque, current root-mean-square, voltage root-mean-square, power factor, input power, output power, and efficiency. They are displayed in two ways:

instantaneous values and iscillograms, as illustrated in Fig. 4. For multi-motors monitored, one can selected which motor's condition is displayed by a drop-down box on the screen.

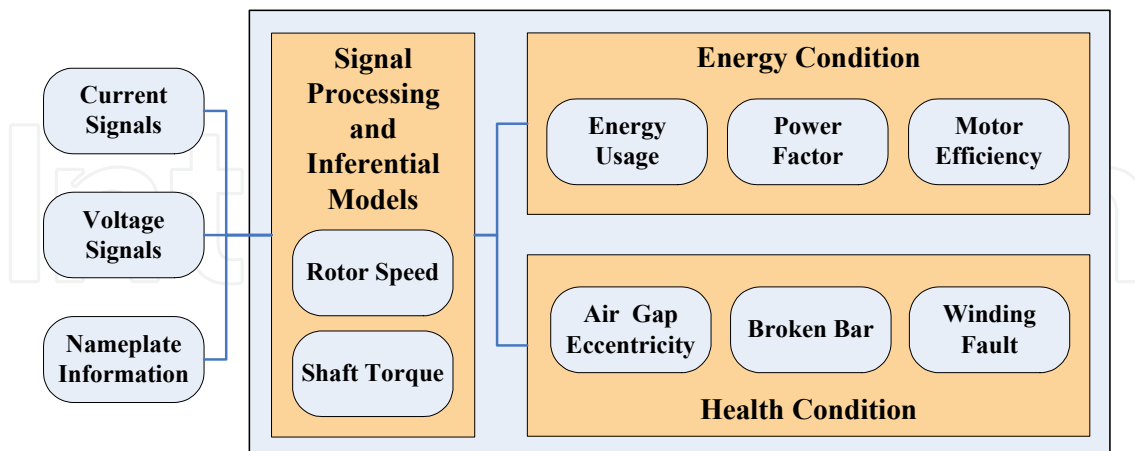

Fig. 3. Functions of the processing unit

All the data are stored in the database and can be restored to make further analysis. Furthermore, motor performance could be analyzed and six performance curves could be obtained. They are efficiency-rotor speed, torque-rotor speed, input power-rotor speed, output power-rotor speed, torque-output power, and efficiency-output power curves, as illustrated in Fig. 5.

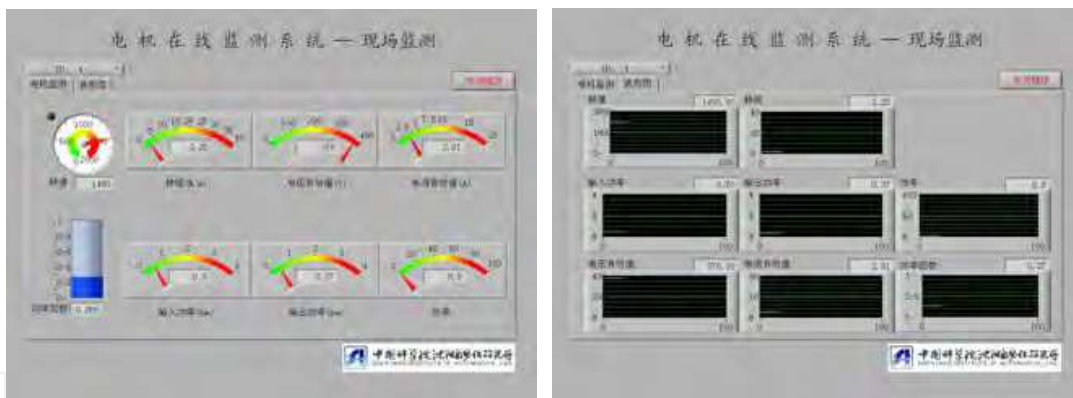

Fig. 4. In-service motor condition monitoring (Left: Instant values, Right: Iscillograms)

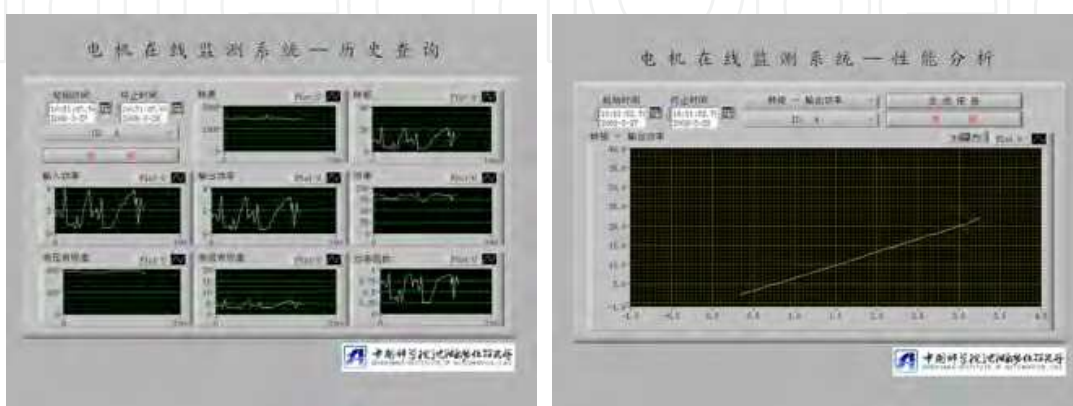

Fig. 5. Motor condition analysis (Left: History data, Right: Performance analysis)

3. Applying Wireless Sensor Networks in Motor Energy Management

The energy evaluation system in industrial plants is usually implemented with wired communication networks so far. Because of the high cost of installation and maintenance of these cables, it is desired to look for a low-cost, robust, and reliable communication network. The wireless sensor networks (WSN) is a self-organized network of small sensor nodes with communication and calculation abilities. As an open architecture, self-configuring, robust, and low cost network, it is suitable to meet the requirement.

Harish Ramanurthy et al. (2005) proposed a wireless smart sensor platform which is an attempt to develop a generic platform with 'plug-and-play' capability to support hardware interface, payload and communications needs of multiple inertial and position sensors, and actuators/motors used in instrumentation systems and predictive maintenance applications.

James E. Hardy et al. (2005) discussed the robust, self-configuring wireless sensors networks for energy management and concluded that WSN can enable energy savings, diagnostics, prognostics, and waste reduction and improve the uptime of the entire plant.

Nathan Ota and Paul Wright (2006) discussed the application trends in wireless sensor networks for manufacturing. WSNs can make an impact on many aspects of predictive maintenance (PdM) and condition-based monitoring. WSNs enable automation of manual data collection. PdM applications of WSNs enable increased frequency of sampling. Condition-based monitoring applications benefit from more sensing points and thus a higher degree of automation.

Bin Lu et al. (2005) and Jose A Getierrze et al. (2006) applied wireless sensor networks in industrial plant energy management systems. A simplified prototype WSN system was developed using the prototype WSN sensors devices, which were composed of a sensor unit, an A/D conversion unit, and a radio unit. However, because the IEEE 802.15.4 standard is designed to provide relaxed data throughput, it is not acceptable in some real-time cases for the large amount of raw data to be transmitted from the motor control centre to the central supervisory station.

3.1 Wireless sensor networks

The WSN is a self-organized network with dynamic topology structure, which is broadly applied in the areas of military, environment monitoring, medical treatment, space exploration, business, and household automation (YU HAIBIN et al., 2006).

The IEEE802.15.4 standard is the physical layer and MAC sub-layer protocol for WSN, which supports three frequency bands with 27 channels as shown in Fig. 6. The 2.4GHz band defines 16 channels with a data rate of 250KBps. It is available worldwide to provide communication with large data throughput, short delay, and short working cycle. The 915MHz band in North America defines 10 channels with a data rate of 40Kbps. And the 868MHz band in Europe defines only 1 channel with a data rate of 20Kbps. They provide communication with small data throughput, high sensitivity, and large scales.

The IEEE 802.15.4 supports two network topologies as shown in Fig. 7. The star topology is simple and easy to implement. But it can only cover a small area. The peer-to-peer topology, on the other hand, can cover a large area with multiple links between nodes. But it is difficult to implement because of its network complexity.

An IEEE 802.15.4 data packet, called physical layer protocol data unit (PPDU), consists of a five-byte synchronization header (SHR) which contains a preamble and a start of packet

delimiter, a one-byte physical header (PHR) which contains a packet length, and a payload field, or physical layer service data unit (PSDU), which length varies from 2 to 127 bytes depending on the application demand, as shown in Fig. 8.

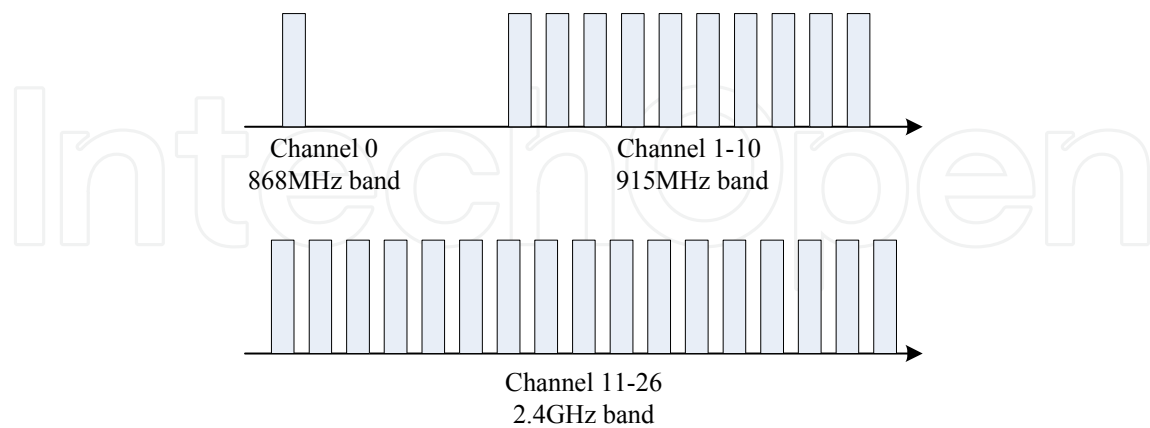

Fig. 6. IEEE 802.15.4 frequency bands and channels

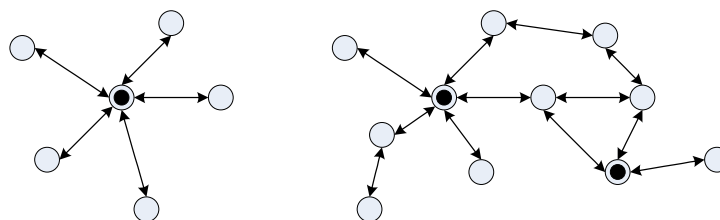

Fig. 7. Star (L) and peer-to-peer (R) topologies

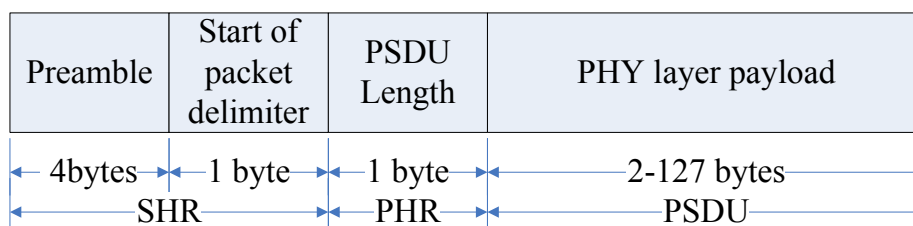

Fig. 8. IEEE 802.15.4 packet structure

3.2 Design and implement of WSN nodes

A WSN node is implemented with a Cirronet ZMN2400HP wireless module to build a communication network between MCC and CSS. The ZMN2400HP consists of an 8-bit Atmel Mega128 microcontroller, which has 128KB flash memory, 4KB EEPROM and 4KB internal SRAM, and a Chipcon CC2420 radio chip, which is compatible with the IEEE 802.15.4 standard and works at 2.4 GHz band. A more detailed structure of the node is shown in Fig. 9.

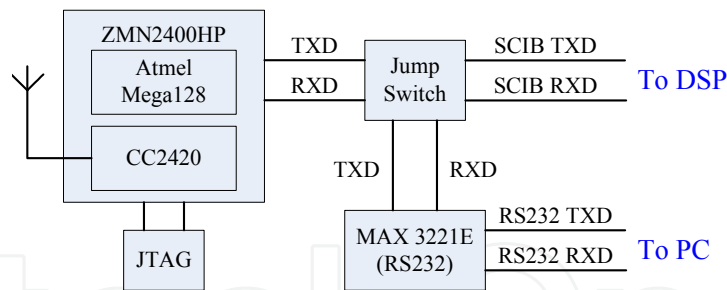

Fig. 9. Design of WSN nodes

Generally there are three kinds of nodes in a wireless sensor network: transmitter nodes, which have both sensing and wireless communicating capabilities, the receiver nodes, which have both wireless and wire communicating capability, and relay nodes which have only the wireless communicating capability to relay the data packets in the case that the distances between the transmitter and receiver nodes are beyond the communication range. In the in-service motor monitoring system, most of the WSN nodes are transmitter ones used as the communication unit of the front-end device in the MCC, to transmit the processing results to the CSS. As a few receiver and relay nodes are used in the system, all of the three kinds of nodes are implemented based on the same hardware structure to simplify the design. Those full-capability nodes can be configured to act as transmitter, receiver or relay nodes. This gives the reason why the communication unit is separated from the signal processing unit in the design of the front-end devices.

Power consumption is the dominating factor in the design of WSN nodes. However in this specific application, the power consumption is no longer a problem to be considered because the WSN nodes are installed at such locations as a MCC or a CSS, where the power supply is available. So the WSN nodes are designed to be powered by AC/DC converters.

Additionally, as the WSN nodes are used either with the processing unit or individually, it is designed to be supplied either by the processing unit or an AC/DC converter.

3.3 Communication protocol

Generally the data transmitting is initiated by the front-end devices. When the signal processing unit gets the results ready, it makes an interrupt request to the communication unit, which acknowledges the request and receives the data through the asynchronous serial ports and then transmits them to the CSS. There are nine kinds of communication packets, as illustrated in Table 1.

There are two kinds of data transmitting which are initiated by the CSS. The first one is the raw data transmitting. When more detailed analysis needs to be made, the raw currents data must be sent to the CSS, where the raw data are processed and analyzed by the more powerful PC. When this situation occurs, a raw data request is sent by the CSS to a given front-end device, which then gathers some raw data and divides them into several packets to send to the CSS one by one. Each time, the front-end device waits for an acknowledge packet sent back by the CCS before continuing to send the next one. The raw data transmitting ends when the CSS gets the last packet and sends back an ending packet.

Type	Description	Direction
0x00	Processing results request	CSS → Nodes
0x11	Raw data request	CSS → FED
0x12	Configuration	CSS → FED
0x13	Raw data acknowledge	CSS → FED
0x14	Raw data ending acknowledge	CSS → FED
0x21	Processing data	FED → CSS
0x22	Raw data	FED → CSS
0x23	Configuration acknowledge	FED → CSS
0x2A	Log data	Nodes → CSS

Note: FED stands for “front-end devices”

Table 1. Communication packet types

The second data transmitting initiated by the CSS is the configuration. A configuration packet is sent to the front-end devices which guided them to configure the processing parameters, such as the motor poles, motor slots, current and/or voltage sensors errors, etc. Additionally, some log data are transmitted, including the conditions of the nodes, repeaters (routers), and coordinators. When the network fails, the log data are stored in the EEPROM temporarily and sent to the CSS as soon as the connection is rebuilt.

3.4 Motor monitoring network management

The central WSN node used at CSS is called a coordinator, which manages all the nodes in the network by an ID table. A node registers to the coordinator by reporting its ID after it powers on or resets. The coordinator communicates with each node in the ID table in turn to get the processing results from the front-end devices. In this way, the communicating conflict can be avoided. If the coordinator couldn't receive any data from a node in a given period of time, it deletes its ID from the table.

The ID table is defined as follows:

```
typedef struct
{
    // node ID
    USIGN8 ucNodeID;
    // node address
    USIGN16 uNodeShortAddr;
    // request fail counter
    USIGN8 ucReqFailCounter;
}NODE_ID;

typedef struct
{
    // node counter
    USIGN8 nodeNum;
    NODE_ID nodeId[MAX_NODE_NUM];
}NODE_ID_TABLE;
```

The ID table is updated according to the combination of three conditions as described in Table 2. Here condition 1 (C1) is that the node ID is in the table. Condition 2 (C2) is that the node address is in the table. Condition 3 (C3) is that the node address changed.

C1	C2	C3	Update
N	N	-	Add new node ID
N	Y	-	Set the node ID in the record
Y	N	-	Set the node address in the record
Y	Y	Y	Set new node address in the record
Y	Y	N	No action

Table 2. ID table updating

To maintain the network alive, some abnormal conditions are detected and handled. A communication unit of the front-end device, also called a front-end node, resets its main CPU and the CC2420 chip and searches for the network again in three cases. First, it can't connect to the network in a given period of time after it powered on. Second, it can't receive the acknowledgement when it tries to register its ID to the coordinator at CSS after connecting to the network. Last, it doesn't receive the processing results request in a given period of time during a connecting session.

A repeater (router) transmits data between the front-end nodes and the coordinator. It's more complex to judge a repeater's condition because both the front-end nodes and the coordinator could reset in some cases. Some actions are made according to the combination of five conditions as described in Table 3. Here condition 1 (C1) is that the repeater has received data from the coordinator. Condition 2 (C2) is that the repeater has received data from front-end nodes. Condition 3 (C3) is that the repeater has got an overtime during transmitting data with the coordinator. Condition 4 (C4) is that the repeater has got an overtime during transmitting data with front-end nodes. And condition 5 (C5) is that the repeater has got an overtime during registering to the network.

The coordinator handles abnormal situations in two cases. It resets its main CPU and CC2420 chip to rebuild the network if no nodes register to it in a given period of time when network initiating or all IDs are deleted from its records.

C1	C2	C3	C4	C5	Action
N	N	-	-	N	Wait for data
				Y	Reset
N	Y	-	N	-	Wait for data
			Y		Reset
Y	N	N	-	-	Wait for data
		Y			Reset
Y	Y	N	N	-	No
		N	Y		Reset
		Y	N		
		Y	Y		

Table 3. Repeater abnormal processing

4. Non-intrusive Motor Energy Usage Condition Monitoring

The motor energy usage condition monitoring plays an important role in the motor energy management. And the efficiency estimation is the key for the motor energy usage monitoring and evaluation.

The motor efficiency is defined as the ratio of the motor shaft output power P_O to the input power P_I as (1), and the difference between them is the power losses which are classified as stator copper loss W_S , rotor copper loss W_R , core loss W_C , friction and windage loss W_{FW} , and stray load loss W_{LL} , as given by (2).

$$\eta = \frac{P_O}{P_I} \times 100\% \quad (1)$$

$$W_L = P_I - P_O = W_S + W_R + W_C + W_{FW} + W_{LL} \quad (2)$$

Over the years, many methods have been proposed to determine the motor efficiency. Generally they can be divided into three groups: direct detection, indirect detection, and inference methods. The direct detection methods measure the motor input and output power with power meters and calculate the motor efficiency directly. The indirect detection methods, also known as segregated loss methods, measure losses by various tests, such as load test, no-load test, and locked-rotor test, etc. The motor efficiency is then obtained by loss analysis. Many direct and indirect methods have been adopted by some international standards such as IEEE 112-B, IEC 34-2, and JEC 37. The Chinese national standard for motor efficiency determination is GB1032-2005. The methods defined in the standards are agreement. The main difference of them is how to determine the stray load loss.

The inference methods determine the motor efficiency with estimation models after some simple experiments. The slip method (John S. Hus, 1998) presumed that the percentage of the load is proportional to the ratio of the measured slip to the full-load slip. Thus the motor efficiency is approximated using (3). The current method (John S. Hus, 1998) assumed that the percentage of load is proportional to the ratio of the measured current to full-load current. The motor efficiency is approximated using (4). Both of the methods are simple and low-intrusive, but poor precise. Some improvements have been made to give a more accurate efficiency estimate.

$$\eta = \frac{\text{slip}}{\text{slip}_{\text{rated}}} \cdot \frac{P_{O,\text{rated}}}{P_I} \quad (3)$$

$$\eta = \frac{I}{I_{\text{rated}}} \cdot \frac{P_{O,\text{rated}}}{P_I} \quad (4)$$

4.1 Non-intrusive Motor Efficiency Estimation

The methods described above are bench testing which requires the motor to be tested in a laboratory environment that may be different from the original working site. Another disadvantage is that they require the motor to be removed from service. They cannot be directly used for the in-service motors.

The motor current signature analysis (MCSA) method is a non-intrusive testing method to evaluate the condition of motors by processing the motor stator current and voltage signals collected at the power supply while a motor is running. The motor is tested in situ, that means motor's original working condition is maintained. As no sensors are need to place in

motors, it's also called the sensorless method. The MCSA method can be used to estimate motor efficiency and diagnose motor faults.

Bin Lu (2006) made a survey of efficiency estimation methods of in-service induction motors, and classified more than 20 of the most important methods into 9 categories according to their physical properties. Based on the survey results, he proposed the air gap torque method, one of the reference methods, as one of candidates for the nonintrusive in-service motor efficiency estimation.

The motor efficiency can be defined as (5) in terms of the shaft torque and the rotor speed, since the output power is the product of them. This is the basic principle of torque methods. But it's difficult, even impossible in most cases, to measure the shaft torque while a motor is in service.

$$\eta = \frac{T_{shaft} \cdot \omega_r}{P_i} \quad (5)$$

J. Hsu & B.P. Scoggins (1995) proposed an air gap torque (AGT) method which takes the output shaft torque as the air gap torque less the torque losses associate with friction, windage, and stray load losses caused by rotor currents. The motor efficiency can be obtained by (6) where the air gap torque (T_{AG}) is calculated using (7) from the motor instantaneous input line currents and voltages.

$$\eta = \frac{T_{AG} \cdot \omega_r - (L_{FW} + L_S)}{P_i} \quad (6)$$

$$T_{AG} = \frac{Poles}{2\sqrt{3}} \left\{ (i_A - i_B) \cdot \int [u_{CA} - R(i_C - i_A)] dt - (i_C - i_A) \cdot \int [u_{AB} - R(i_A - i_B)] dt \right\} \quad (7)$$

As the rotor speed (ω_r) and stator resistance (R) measurements are required and a no-load test must be run to measure losses L_{FW} and L_S , the AGT method is still a highly intrusive method difficult to use in the in-service motor monitoring. To overcome these problems, a "nonintrusive" method is developed by making the following improvements to the original AGT method (Bin Lu, 2006).

- a) Without direct measurement, the rotor speed is estimated from motor current spectrum analysis extracting slot harmonics from stator currents.
- b) The stator resistance is estimated from the input line voltages and phase currents using an on-line DC signal injection method.
- c) The losses are estimated from empirical values using only motor nameplate data. The friction and windage loss is 1.2% of the rated output power; and the stray-load loss is estimated from the recommended values in IEEE standard 112.

4.2 Rotor Speed estimation

The main approach for speed estimation in induction motors uses the machine model to design observers (M.A. Gallegos et al., 2006). Luenberger observers, model reference adaptive systems, adaptive observers, Kalman filtering techniques, and estimation based on parasitic effects are some techniques to deal with the problem of speed estimation.

Rotor slot harmonics spectrum estimation technique is a kind of sensorless speed detection method. The rotor slot produces harmonic components in the air gap field, which modulate the flux interlacing on the stator with a frequency proportional to the rotor speed. Thus the speed can be estimated using the slot harmonics frequency (f_{sh}) by (8) (Azzeddine Ferrah et al., 1992).

$$n = \frac{60}{z_r} (f_{sh} \pm f_1) \quad (8)$$

We developed a rotor speed estimator based on slot harmonics spectrum estimation, as illustrated in Fig. 10. (X.Z. Che & J.T. Hu et al, 2008)

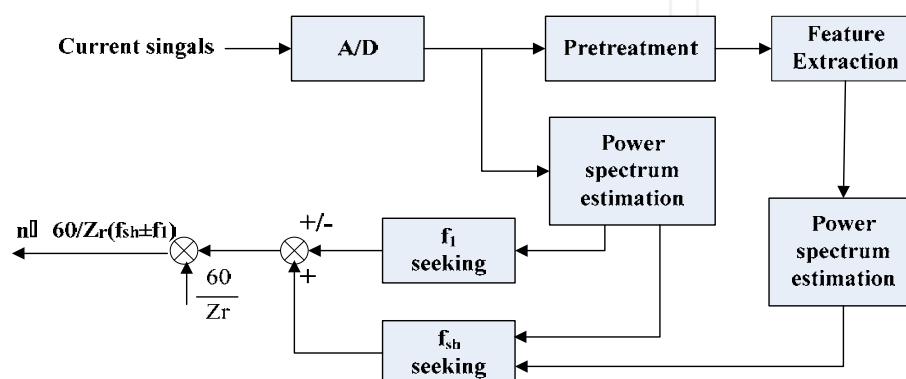

Fig. 10. Rotor speed estimation based on slot harmonics spectrum estimation

To extract feature more accurately, pretreatment is made before spectrum analysis. First, a band-pass filter is designed based on Chebyshev uniform approximation to filter out the fundamental component and upper and lower frequency noise signals. And then frequency aliasing is used to enhance the slot harmonics signal. The slot harmonics appear in the spectrum at $2f_1$ intervals, so the raw signals are downsampled to $2f_1$. Here f_1 is the original sampling frequency. As the sampling frequency is lower than the slot harmonics frequency after the downsampling, the frequency aliasing occurs that enhances the paired slot harmonics and weakens noises.

After the pretreatment, the frequency offset of the slot harmonics in the aliasing spectrum is detected with maximum entropy spectrum estimation, which is a modern power spectrum estimation method based in AR model. The frequency with the max amplitude in the aliasing spectrum is the frequency offset of the slot harmonics. Then the slot harmonics frequency is determined by matching the offset on the original spectrum.

4.3 Design and implement of motor monitoring front-end devices

Based on the non-intrusive efficiency estimation method mentioned above, the front-end device is developed with the digital signal processing (DSP) techniques. It is divided into three parts: sensing, signal processing and communication unit, as shown in Fig. 11

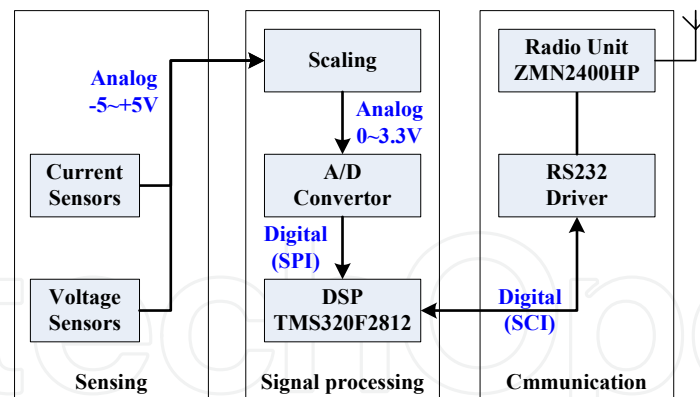

Fig. 11. The design of the front-end device

The three parts of the front-end devices are designed and implemented separately on individual PCB's. When constructing the front-end devices, the signal processing unit and the communication unit are mounted on the sensing unit and linked by cables with each other, as shown in Fig. 12. The flexible design could meet the requirement for different sensors while different motors are monitored. And moreover the sensing unit could be omitted in the case that the current and voltage sensors are already equipped in the MCC in industrial plants. In that case, the communication unit can be mounted on the signal processing unit.

The sensing unit consists of two current sensors and two voltage sensors. Both of them are highly accurate Hall effect ones. In the prototype devices used in the laboratory, the current sensor is HNC025A with 0-36 amps RMS current range, $\pm 0.6\%$ accuracy, and $<0.2\%$ linearity, and the voltage sensor is HNV025A with 100-2500V volts RMS current range, $\pm 0.6\%$ accuracy, and $<0.2\%$ linearity.



Fig. 12. Implementation of the sensing, processing and communication unit

The signal processing unit contains three main subunits. The -5v - +5v analogue voltage signals coming from the sensing unit are firstly scaled into analogue signals in the range of 0-3.3 volts to meet the requirement of the ADC chip. And then a 12-bit 8-channel ADC is used to sample the analogue waveforms at a certain frequency, which can be configured as 2, 4 or 8 KHz in the prototype devices, and convert them into digital signals.

The kernel of the signal processing unit is a 32-bit fixed-point DSP chip TMS320F2812, which has 128KB flash memory, 18KB internal SRAM. It controls the signal processing and spectrum estimation programs running in a μ OS/II system.

In order to evaluate the energy usage, 8 motor condition parameters are estimated and/or calculated, including the current root mean square (I_{rms}), the voltage root mean square (U_{rms}), the input power (P_i), the power factor ($\cos \varphi$), the rotor speed (ω_r), the shaft torque (T_{shaft}), the output power (P_o), and the efficiency (η), as shown in Fig. 13.

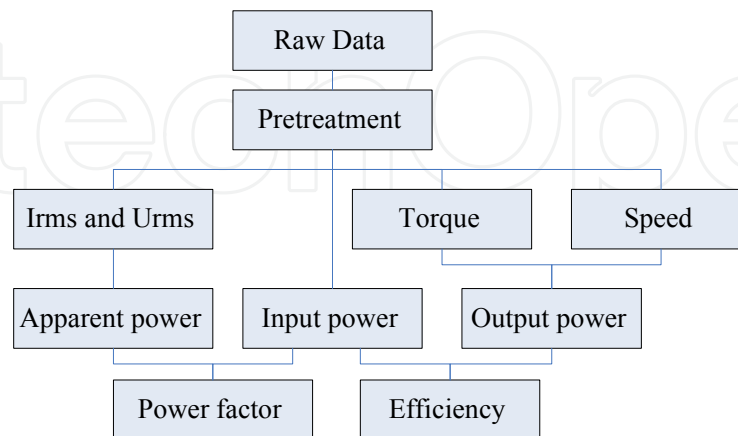

Fig. 13. Motor condition parameters calculation

The output power is calculated from rotor speed and shaft torque. The rotor speed is estimated by the method described in section 4.2. The shaft torque is obtained by subtracting the torque losses associated with the friction and windage loss L_{FW} and rotor stray-load loss L_S from the calculated air-gap torque, as given by (9). In this implement, the combined losses of L_{FW} and L_S are assumed to be 3.5% of rated output power from empirical values. And the stator resistance is assumed to be the same as the resistance measured at cool state. Other parameters can be obtained by (10)-(13). At last, the motor efficiency is calculated by (1).

$$T_{shaft} = T_{AG} - \frac{L_{FW}}{\omega_r} - \frac{L_S}{\omega_r} \quad (9)$$

$$I_{rms} = \sqrt{\frac{1}{N} \sum_{m=1}^N i_m^2} \quad (10)$$

$$U_{rms} = \sqrt{\frac{1}{N} \sum_{m=1}^N u_m^2} \quad (11)$$

$$P_i = \frac{1}{N} \sum_{m=1}^N u_m i_m \quad (12)$$

$$\cos \varphi = \frac{P}{S} = \frac{P}{\sqrt{3} \cdot U \cdot I} \quad (13)$$

5. Laboratory Test and Plant Application

The system are tested in the laboratory with four Y100L2-4 induction motors (4-pole, 3KW, 380V, 6.8A) with four 4KW DC generators as their loads, and applied in a plant to monitor four pumping motors as illustrated in Fig. 14.

In the CCS, a WSN receiver node is used as a coordinator of the network. Four front-end devices are installed in the MCC to acquire the current and voltage signals of the four test motors. When started, they search and connect to the coordinator automatically to setup a star wireless network. Then the coordinator sends a query packet to one of the 4 front-end nodes every second and receives a data packet sent back on the request. In this way, the motor monitoring results are successfully transmitted to the CSS constantly.

The motors are tested from no load to full load with intervals of 12.5% load. And signals are sampled and analyzed for 120 seconds at each load point. That means totally $4 \text{ (motors)} * 9 \text{ (load point per motor)} * 120 \text{ (seconds per load point)} / 3 \text{ (seconds for one packet)} = 1440$ packets are transmitted from 4 front-end devices to the CCS. As only one packet is sent to the coordinator from one of the 4 front-end monitoring devices every second, the data throughput is enough to transmit the data packets, and there is no packet lost in the laboratory test.



Fig. 14. Laboratory testing system (L) and the pumping motors in a plant (R)

5.1 Data throughput over the WSN

As described in section 3.1, the PSDU length can vary from 2 to 127 bytes in a IEEE 802.15.4 data packet. In the proposed system, the PSDU is totally 32 bytes long with 1-byte motor ID, 1-byte frame type, 2-byte counting number, 4-byte voltage, 4-byte current, 4-byte speed, 4-byte torque, 4-byte input power, 4-byte output power, 2-byte efficiency, and 2-byte power factor. Apparently, one result can be transmitted in one data packet.

To meet the requirement of signal processing, 4 channels of current and voltage signals are sampled synchronously at 4KHz frequency for 1 second to get 50 cycles of 50Hz waveforms. Another 2 seconds are spent on calculating and transmitting the results. So every 3 seconds, a data packet is sent to the CSS from one front-end device.

That transmitting time and data throughput requirement is enough to be implemented in an IEEE 802.15.4 WSN with the standard latency 6-60 ms and data throughput 250KBps.

To check the maximum communication abilities between the WSN nodes, a simple test is made in which real size data packets are continuously sent from a transmitter to a receiver in 300ms with each packet sent within an specified interval (I_s). The packets sent from the transmitter (P_s) and the packets received by the receiver (P_r) are counted. Then the real receiving interval (I_r), average packets received per second (P_a), and the packets lost rate (L_r) are calculated. The test results are illustrated in Table 4.

Is	Ps	Pr	Ir	Pa	Lr
0.100	2976	2976	0.0101	9.92	0.0000%
0.050	5887	5887	0.0051	19.62	0.0000%
0.030	9691	9691	0.0031	32.30	0.0000%
0.025	11567	11567	0.0026	38.56	0.0000%
0.020	14310	14310	0.0021	47.70	0.0000%
0.015	18791	18790	0.0016	62.63	0.0053%
0.010	22577	19537	0.0015	65.12	13.4650%
0.005	29718	18851	0.0016	62.84	36.5671%

Table 4. Communication abilities test

From the test results, it can be seen that the minimum packets receiving interval is about 0.015 seconds. In other words, maximum 66.7 packets can be received every second on average. If the transmitter sends packets faster than that, the communication becomes worse with packets lost rate getting higher.

5.2 Motor efficiency estimation

The test results on motor No.3 and 4 are listed in Table 5 and 6 with estimated values and measured values. The estimated values vs. measured values of speed, torque, and efficiency of motor No. 3 are figured in Fig. 15 to 17.

The detection errors are large when the loads are under 25%. That's because the electromagnetic characteristic of the motor ferromagnetic slope the power factor curve under no load or light loads conditions. Another reason is that the motor load-efficiency curve is sloping in that section and the speed estimation error is enlarged in efficiency calculation process.

Generally the average loads of in-service motors are above 50%, so the larger errors under no load or light loads condition have little effects on the application of the monitoring system in plants.

Loads (%)	speed(r/min)		torque(N.m)		efficiency	
	Estimation	Measurement	Estimation	Measurement	Estimation	Measurement
0	1498.75	1495.80	1.25	1.16	41.40%	43.26%
12.5	1491.50	1494.00	2.75	2.46	62.50%	62.58%
25.0	1482.00	1483.80	5.75	5.34	79.30%	76.82%
37.5	1469.00	1470.60	8.72	9.34	80.10%	85.61%
50.0	1459.50	1460.40	12.00	11.94	84.80%	83.37%
62.5	1450.25	1451.40	14.50	13.69	85.20%	79.72%
75.0	1443.25	1443.00	16.25	16.43	84.00%	84.44%
87.5	1436.75	1435.20	17.50	17.07	82.80%	79.92%
100	1428.50	1428.60	18.50	19.49	81.20%	75.93%

Table 5. Test results on motor No. 3

Loads (%)	speed(r/min)		torque(N.m)		efficiency	
	Estimation	Measurement	Estimation	Measurement	Estimation	Measurement
0	1499.50	1496.40	2.50	1.30	76.20%	43.81%
12.5	1498.75	1492.80	3.25	2.54	72.70%	61.56%
25.0	1478.50	1485.00	6.25	5.61	81.60%	77.54%
37.5	1472.25	1471.80	9.00	9.08	82.80%	84.05%
50.0	1460.75	1462.20	12.00	11.83	85.90%	91.48%
62.5	1450.25	1449.00	14.00	14.33	82.00%	84.27%
75.0	1439.50	1441.00	16.25	16.41	84.40%	85.53%
87.5	1434.00	1434.00	17.75	17.82	84.00%	84.14%
100	1426.75	1427.40	18.75	19.08	82.40%	83.39%

Table 6. Test results on motor No. 4

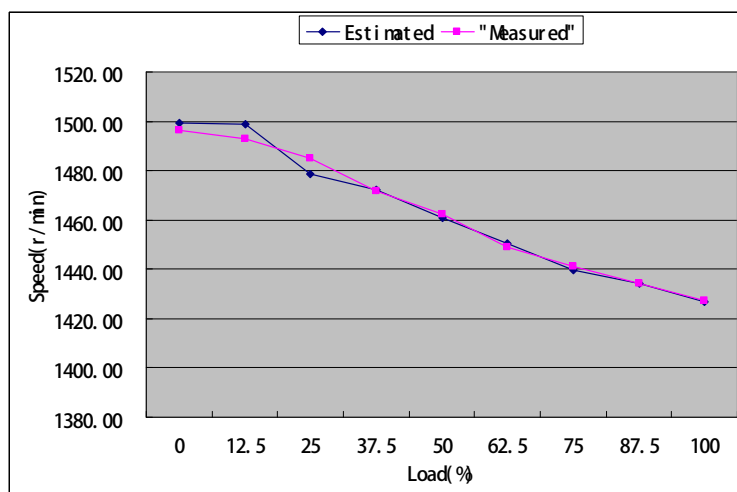

Fig. 15. Estimated vs. Measured Speed Values of Motor No. 3

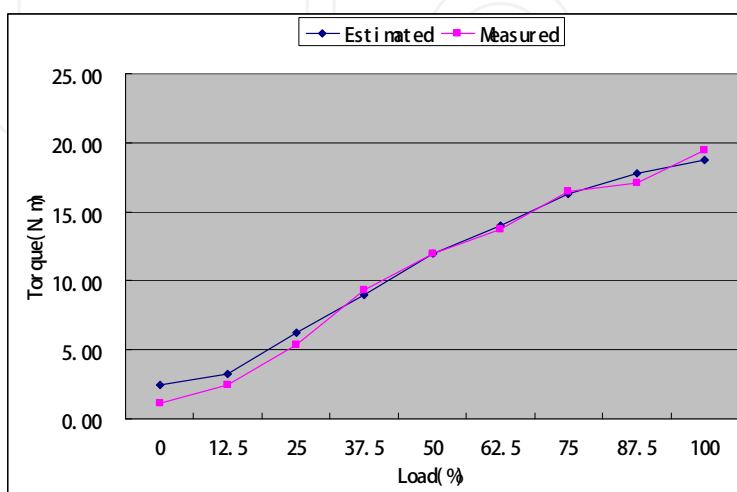

Fig. 16. Estimated vs. Measured Torque Values of Motor No.3

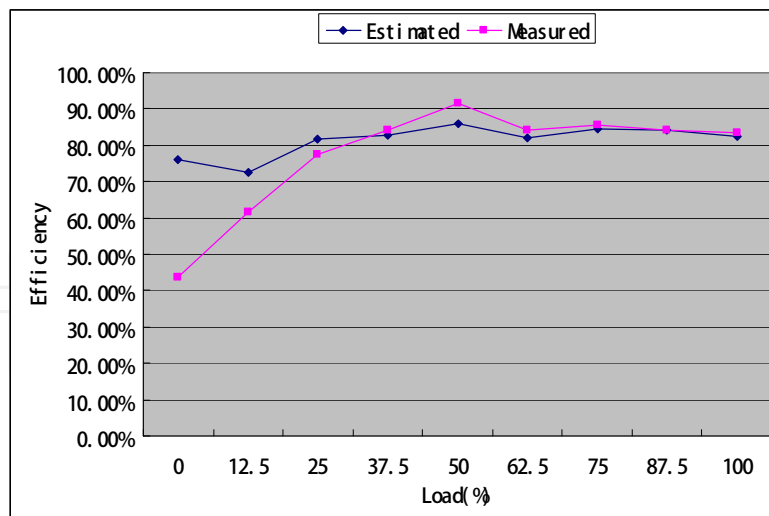

Fig. 17. Estimated vs. Measured Efficiency Values of Motor No.3

6. Conclusion

This paper proposes a motor energy management architecture, which is composed of a data acquisition platform, a condition monitoring platform, an energy consumption and saving analysis platform, a communication platform, and a motor energy data management platform.

Under the guidance of the architecture, an in-service motor monitoring and energy management system is developed based on non intrusive monitoring technologies and wireless sensor networks. The system has two subsystems: a data acquiring and analysis subsystem, and a condition monitoring and energy management subsystem.

To evaluate the in-service motor energy usage, motor efficiency estimation methods are discussed. And a motor monitoring front-end device is developed with the implement of the methods introduced. The device is designed as three separate units, including a sensing unit, a processing unit, and a communication unit. Such a flexible design could meet various requirements in the application.

The wireless sensor network is a self-organized network with dynamic topology. As a low-cost, robust, and reliable communication network, it is used to connect the front-end devices with the central supervisory station. A WSN node is designed and implemented for the in-service motor monitoring system, which can also be used as a unit of the front-end device.

The laboratory tests and plant application show that the system can help the plant managers to improve motor-driven systems.

7. References

- U.S. Department of Energy (2007), *Sensors & Automation 2007 Annual Portfolio Review*, Rosemont, Illinois, June 2007.
- Electrical Industrial Association of China (2006), *The New Trend of Motor Energy-saving*, *Electrical Industry*, April 2006, pp. 50-52
- Ramamurthy, H.; Prabhu, B.S.; Gadh, R. & Madni, A.M., Smart sensor platform for industrial monitoring and control, *Sensors, 2005 IEEE*, Oct. 30 2005-Nov. 3 2005, pp.1116-1119
- James E. Hardy; Wayne W. Manges; Jose A. Gutierrez & Phani Teja V. Kuruganti (2005), *Wireless Sensors and Networks for Advanced Energy Management*, 2005 ACEEE Summer Study on Energy Efficiency in Industry, West Point, New York, July 2005
- Nathan Ota & Paul Wright (2006), Trends in wireless sensor networks for Manufacturing, *Int. J. Manufacturing Research*, Vol. 1, No. 1, (2006), pp. 3-17
- Bin LU; Long Wu; Thomas G. Habetler; Ronald G. Harley & Jose A. Gutierrez (2005), On the Application of Wireless Sensor Network in Condition Monitoring and Energy Evaluation for Electric Machines, *Proceedings of the 31st Annual Conference of the IEEE Industrial Electronics Society (IECON'05)*, pp.2674-2679, Raleigh, NC, Nov. 2005.
- Jose A. Gutierrez; David B. Durocher & Bin Lu (2006), Applying Wireless Sensor Networks in Industrial Plant Energy Evaluation and Planning Systems, *Conference Record of the 2006 IEEE IAS Pulp and Paper Conference*, pp.1-7, Jun. 2006
- Yu Haibin; Zeng Peng & Liang Wei (2006), *Intelligent Wireless Sensor Networks*, Li Wei; Tian Shiyong & Yao Qingshuang, (1st Ed), Science Press, ISBN 7-03-016453-9, Beijing
- John S. Hsu; John D. Kueck; Mitchell Olszewski; Don A. Casada; Pedro J. Otaduy & Leon M. Tolbert, Comparison of Induction Motor Field Efficiency Evaluation Methods, *IEEE Transactions on Industry Applications*, pp.117-125, Vol. 34, No. 1, Jan./Feb. 1998.
- B. Lu; T. G. Habetler & R. G. Harley (2006), A Survey of Efficiency-Estimation Methods for In-Service Induction Motors, *IEEE Trans. Industry Applications*, pp.924-933, vol. 42, no. 4, Jul./Aug. 2006.
- Bin Lu; Thomas G. Habetler & Ronald G. Harley (2006), A Nonintrusive and In-Service Motor Efficiency Estimation Method using Air-Gap Torque with Considerations of Condition Monitoring, *Conference Record of the 2006 IEEE Industry Applications Conference*, pp.1533 - 1540, Volume 3, Oct. 2006
- J. hsu & B.P. Scoggins (1995), Field Test of Motor Efficiency and Load Changes through Air-gap Torque, *IEEE Transactions on Energy Convers*, pp.477-483, vol. 10, no.3, Sep. 1995.
- M.A. Gallegos; R. Alvarez & C.A. Nunez (2006), A survey on speed estimation for sensorless control of induction motors, *10th IEEE International Power Electronics Congress*, pp.1-6, Oct. 2006.
- Azzeddine Ferrah; Kerth J. Bradley & Greg M. Asher (1992), an FFT-Based Novel Approach to Noninvasive Speed Measurement in Induction Motor Drives, *IEEE Transaction on Instrumentation and Measurement*, pp. 797-802, Vol. 41, No. 6, Dec. 1992
- X.Z. Che; J.T. Hu & Q.J. Guo (2008), An Slot Harmonics Detection-Based Approach to Speed Estimation in a Sensorless Induction Motor, *Chinese Journal of Scientific Instrument*, pp. 414-417, Vol.29, No.4S, 2008(4)

IntechOpen

IntechOpen



Energy Management

Edited by Francisco Macia Perez

ISBN 978-953-307-065-0

Hard cover, 246 pages

Publisher InTech

Published online 01, March, 2010

Published in print edition March, 2010

Forecasts point to a huge increase in energy demand over the next 25 years, with a direct and immediate impact on the exhaustion of fossil fuels, the increase in pollution levels and the global warming that will have significant consequences for all sectors of society. Irrespective of the likelihood of these predictions or what researchers in different scientific disciplines may believe or publicly say about how critical the energy situation may be on a world level, it is without doubt one of the great debates that has stirred up public interest in modern times. We should probably already be thinking about the design of a worldwide strategic plan for energy management across the planet. It would include measures to raise awareness, educate the different actors involved, develop policies, provide resources, prioritise actions and establish contingency plans. This process is complex and depends on political, social, economic and technological factors that are hard to take into account simultaneously. Then, before such a plan is formulated, studies such as those described in this book can serve to illustrate what Information and Communication Technologies have to offer in this sphere and, with luck, to create a reference to encourage investigators in the pursuit of new and better solutions.

How to reference

In order to correctly reference this scholarly work, feel free to copy and paste the following:

Hu Jingtao (2010). Motor Energy Management Based on Non-Intrusive Monitoring Technology and Wireless Sensor Networks, Energy Management, Francisco Macia Perez (Ed.), ISBN: 978-953-307-065-0, InTech, Available from: <http://www.intechopen.com/books/energy-management/motor-energy-management-based-on-non-intrusive-monitoring-technology-and-wireless-sensor-networks>

INTECH
open science | open minds

InTech Europe

University Campus STeP Ri
Slavka Krautzeka 83/A
51000 Rijeka, Croatia
Phone: +385 (51) 770 447
Fax: +385 (51) 686 166
www.intechopen.com

InTech China

Unit 405, Office Block, Hotel Equatorial Shanghai
No.65, Yan An Road (West), Shanghai, 200040, China
中国上海市延安西路65号上海国际贵都大饭店办公楼405单元
Phone: +86-21-62489820
Fax: +86-21-62489821

© 2010 The Author(s). Licensee IntechOpen. This chapter is distributed under the terms of the [Creative Commons Attribution-NonCommercial-ShareAlike-3.0 License](#), which permits use, distribution and reproduction for non-commercial purposes, provided the original is properly cited and derivative works building on this content are distributed under the same license.

IntechOpen

IntechOpen