

We are IntechOpen, the world's leading publisher of Open Access books Built by scientists, for scientists

4,800

Open access books available

122,000

International authors and editors

135M

Downloads

Our authors are among the

154

Countries delivered to

TOP 1%

most cited scientists

12.2%

Contributors from top 500 universities



WEB OF SCIENCE™

Selection of our books indexed in the Book Citation Index
in Web of Science™ Core Collection (BKCI)

Interested in publishing with us?
Contact book.department@intechopen.com

Numbers displayed above are based on latest data collected.

For more information visit www.intechopen.com



The idea of the measurement system for quick test of thermal parameters of heat-insulating materials

IntechOpen
Stanislaw Chudzik
Czestochowa University of Technology
Poland

1. Introduction

For the sake of climate and atmosphere conservation the emission of gasses must be bounded. A significant reduction of emission can be obtained by rational heat energy consumption, which is a substantial percent of the world's consumed energy. One of the ways is using in the building engineering and industry suitable insulating materials: foamed polystyrene, mineral wool, glass fiber, polyurethane foam, synthetic clothes, foam glass or cellular concrete. The existing methods of determination of material's thermal parameters are based mainly on stationary heat transfer conditions (Bayazitoğlu & Özişik, 1988; Bejan, 1993; Janna, 2000; Minkina & Chudzik 2004; Platonov, 1986). These methods allow determining in the experiment only a single thermophysical parameter of the tested material. They require the use of big and heavy measuring systems and a long period of time to conduct the measurement. Author do not know a commercial solution of portable measuring system which in relatively short time could assess fulfilling the requirements of insulating materials delivered to building site or leaving the factory from the point of view of thermal conductivity. Therefore, it seems to be crucial to work on design of such a measuring system. The research in this field concentrates, among other things, on possibility of application of artificial neural networks to solve the coefficient inverse problem of diffusion process (Alifanov et al., 1995; Beck, 1985). To determine the usability of network an analysis of its response for known values of thermal parameters is needed. It is necessary to generate input data for network training process using mathematical model of the tested sample of heat insulation material. The discrete model of a nonstationary heat flow process in a sample of material with hot a probe and an auxiliary thermometer based on a two-dimensional heat-conduction model was presented. The minimal acceptable dimensions of the material sample, the probe and the auxiliary thermometer were determined. Furthermore, the presence of the probe handle was considered in the heat transfer model. The next stage of the research is solving the inverse problem in which the thermal parameters will be estimated on the basis of recorded temperatures. Methods employing the classical algorithm of the mean square error minimization in the inverse problem of the heat conduction equation have an advantage of making it possible to take into consideration the arbitrary, varying boundary conditions that occur during the

measurement (Aquino & Brigham, 2006; Chudzik & Minkina, 2001; Chudzik & Minkina, 2001a). Temperature changes of the input can be unbounded and they are taken into consideration in the calculations. The main basic disadvantage of it is the requirement of a portable computer or specially made measuring equipment based on powerful microprocessor (e.g. ARM core). It is conditioned by a great deal of iterative computations conducted in the inverse problem solution algorithm. To reduce the amount of computations and solution time of the inverse problem the application of artificial neural networks was proposed, which would determine a thermophysical parameter on the basis of the time characteristic recorded in the sample of tested material (Daponde & Grimaldi, 1998; Hasiloglu & Yilmaz, 2004; Mahmoud & Ben-Nakhi, 2003; Turias et al., 2005; Chudzik, 1999; Chudzik et al., 2001; Minkina & Chudzik 2004;).

2. Model of Heat Diffusion in the Sample of Insulating Material for Different Probe Designs

In the classic transient line heat source method (LHS), called also hot wire method or the probe method (Boer et al., 1980; Bouguerra et al., 2001; Gobbé et al., 2004; Kubicar & Bohac, 2000; Cintra & Santos, 2000; Tavman, 1999; Ventkaesan et al., 2001), a heated wire is initially inserted into a sample of insulating material at uniform and constant temperature, T_0 . Constant power is then supplied to the line heater element starting at time $t=0$ and temperature adjacent to the line heat source is recorded with respect to time during a short heating interval. The principle of the method is based on the solution of the heat conduction equation in the cylindrical co-ordinate system:

$$\frac{\partial^2 T}{\partial r^2} + \frac{1}{r} \frac{\partial T}{\partial r} = \frac{1}{a} \frac{\partial T}{\partial t} \quad (1)$$

with the following initial and boundary conditions:

$$\begin{aligned} t = 0 \quad r > 0 \quad T &= T_0 = 0 \\ t > 0 \quad r \rightarrow \infty \quad T &= 0 \\ t > 0 \quad r \rightarrow 0 \quad -2\pi r k \frac{\partial T}{\partial r} &= q' = \text{constant} \end{aligned} \quad (2)$$

where: a - thermal diffusivity (m^2/s), k - thermal conductivity ($\text{W}/(\text{m}\cdot\text{K})$), q' - linear power density (W/m). Several variations of the hot wire method are known. The theoretical model is the same as described by (1) and the basic difference among them lies in the temperature measurement procedure. This technique was standardized in 1978 by DIN 51046 Standard-Part 2. The approximate solution of (1) is given by the temperature rise $T(t)$. The thermal conductivity is calculated according to the following equation (Boer et al., 1980):

$$k = \frac{-q'}{4\pi T(t)} E_i \left(\frac{-\rho c_p r^2}{4kt} \right) \quad (3)$$

where: ρ - material bulk density (kg/m^3), c_p - specific heat of the material at constant pressure ($\text{J}/(\text{kg}\cdot\text{K})$), r - distance between the hot wire and the thermocouple (m), t - time elapsed after start of heat release (s), $T(t)$ - temperature rise registered by the thermocouple related to the initial reference temperature (K), $E_i(-x)$ - exponential integral function given by:

$$E_i(-x) = -\int_x^{\infty} \frac{e^{-t}}{t} dt. \quad (4)$$

In the mathematical formulations given by (3), the following assumptions were made: the hot wire (that is the heat source) has negligible mass and heat capacity, it is infinitely thin and long, and the material whose thermal conductivity is determined is half-infinite (Boer et al., 1980; Cintra & Santos, 2000). In the case of measurement of thermoinsulation material properties using the hot probe (Al-Homoud, 2005; Ventkaesan et al., 2001), the approximate solutions of (1) are inaccurate. The conditions mentioned above can not be satisfied in general. Moreover, the heat capacity of the hot probe and the testing sample of material are comparable.

Our proposition of measurement system with hot probe consists in evaluating three thermal parameters simultaneously. It is sufficient to determine two of them, because they are related by equation:

$$a = \frac{k}{\rho \cdot c_p}. \quad (5)$$

The measurement system should record the temperature changes at the heat probe T_H and auxiliary thermometer T_X . The proposed distance between the hot probe and the auxiliary thermometer is 8 mm, the hot probe diameter is 2 mm and diameter of the auxiliary thermometer is 1 mm. A predesign of such thermal probe is presented in Fig. 1. The model of the heat diffusion in the sample of material with hot probe and auxiliary thermometer is given by (Quinn, 1983):

$$\rho c_p \frac{\partial T}{\partial t} - \nabla \cdot (\lambda \nabla T) = Q \quad (6)$$

where Q is the volume power density (W/m^3). The equation was implemented in the Matlab environment using the Partial Differential Equation Toolbox. Several alternative designs were considered and the results are obtained in the next subsections.

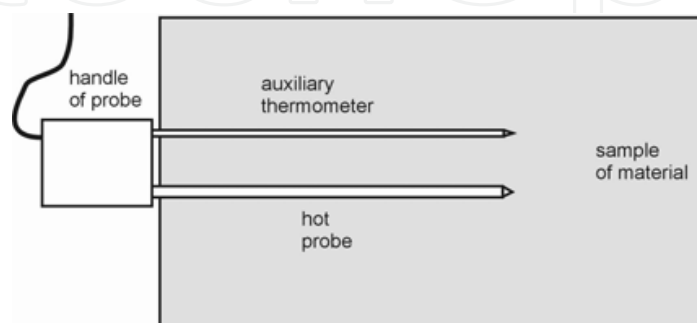

Fig. 1. Predesign of thermal probe

2.1 Heat diffusion in the sample of material for uniform hot probe and auxiliary thermometer references

To obtain the temperature field in the sample the finite element method (FEM) was applied (Alifanov et al., 1995; Aquino & Brigham, 2006; Augustin & Bernhard 1996; Beck, 1985; Jurkowski et al., 1997). In a two-dimensional XY co-ordinate model of the material sample, treated as a square plate, the simplified boundary condition $\partial T/\partial x=0$ was assumed. The values of thermal parameters were set to: $a = 2.3 \cdot 10^{-6} \text{ m}^2/\text{s}$, $k = 0.04 \text{ W}/(\text{m}\cdot\text{K})$ of sample of material ensure negligible influence of the boundary condition. Therefore, the modeled sample can be treated as infinitely extensive. The additional assumptions are as follows: the probe is made of copper with diameter $\varnothing = 2 \text{ mm}$ and thermal parameters $a = 116 \cdot 10^{-6} \text{ m}^2/\text{s}$, $k = 401 \text{ W}/(\text{m}\cdot\text{K})$, heating power is generated in the whole volume of the hot probe, the line power density of the heat source is $P_G(T_G=0) = P_0 = 9 \text{ W}/\text{m}$ and depends on the instantaneous value of temperature increment of heater T_G built-in the probe. The heat power of the probe can be expressed as:

$$P_G(T_G) = \frac{U^2}{R_0 + \alpha T_G} \cdot \frac{1}{l} \quad (7)$$

where: a – average increment of heater resistance, U – supply voltage, R_0 – heater resistance in initial conditions, l – length of probe. Zero values of initial conditions were assumed. It means that the initial temperature of the sample, probe and thermometer equal to ambient temperature. The auxiliary thermometer placed in the tested probe can disturb the thermal field, therefore the temperature measured will not properly indicate real temperature in the sample. For that reason the real thermometer placed at a distance of 8 mm from probe was assumed. The modeled thermometer could be made of stainless steel with the following parameters: diameter $\varnothing = 1 \text{ mm}$, $a = 3.8 \cdot 10^{-6} \text{ m}^2/\text{s}$, $k = 15 \text{ W}/(\text{m}\cdot\text{K})$. The thermal parameters of the sample, probe and thermometer were taken from (Grigoryev, 1991). A half section of the sample with the thermal probe and discrete mesh is presented in Fig. 2 for two cases: the probe without and with the auxiliary thermometer.

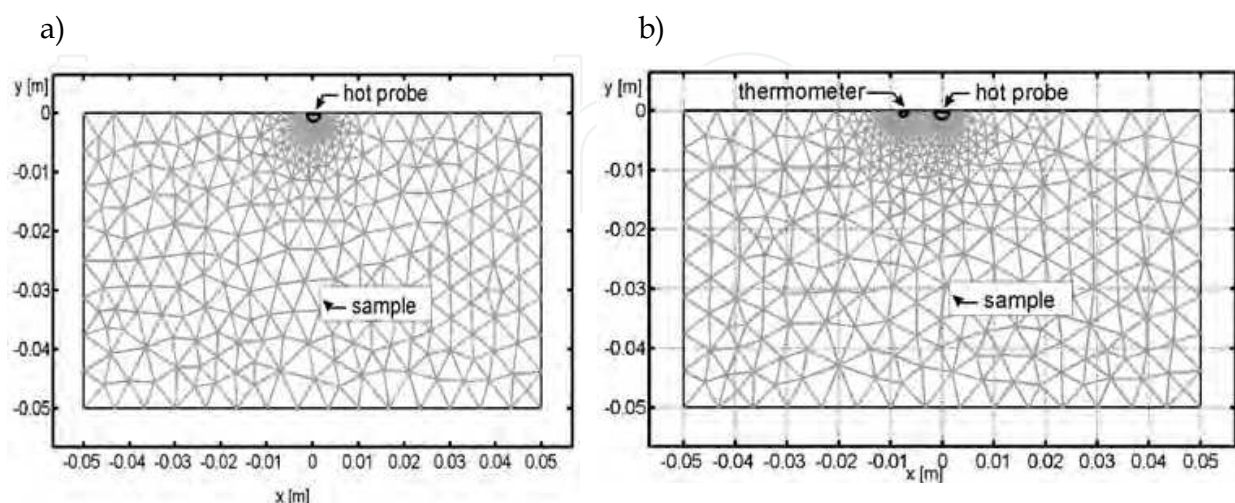

Fig. 2. A half section of sample with thermal probe with discrete mesh for uniform probe: without (a) and with auxiliary thermometer (b)

Fig. 3 presents the temperature profile of the sample after 100 s, where values are related to ambient temperature (difference). The comparison of these figures shows the influence of presence of the auxiliary thermometer on the temperature field in sample, particularly visible in the place of thermometer's location - enlarged part in Fig. 3b.

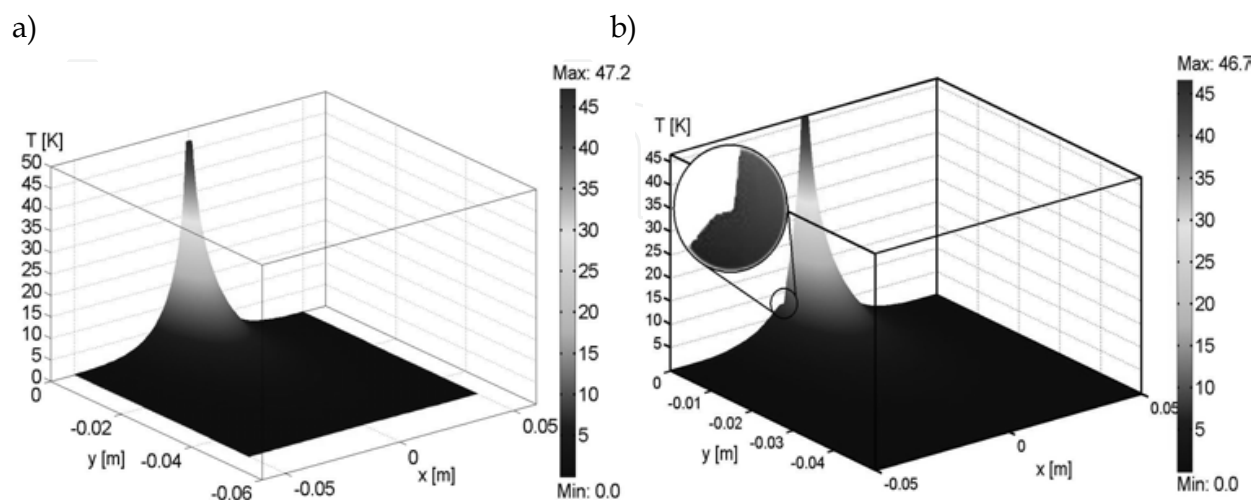

Fig. 3. The temperature profile of sample after 100 s for uniform probe: without (a) and with auxiliary thermometer (b)

Fig. 4 presents changes in temperature of the probe (curve 1), un-disturbing heat diffusion auxiliary thermometer (curve 2) and real auxiliary thermometer (curve 3) in the time period of 0-100 s after the start of sample heating. Curves 2 and 3 in Fig. 4 differ significantly similarly to the previous figure, hence the presence of real auxiliary thermometer must be taken into consideration in the mathematical model of heat diffusion in the sample of the tested material.

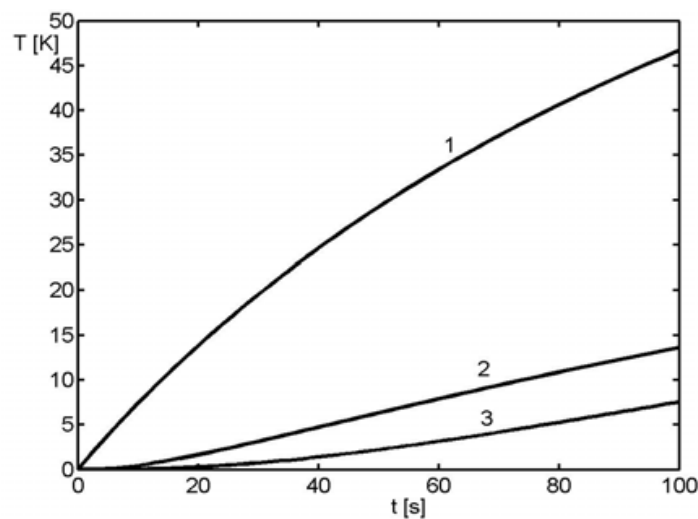

Fig. 4. Changes in temperature of probe (1), un-disturbing auxiliary thermometer (2) and real auxiliary thermometer (3) placed in a distance of 8 mm from the probe

2.2 Heat diffusion in the sample of material for nonuniform (multi-layer) hot probe and auxiliary thermometer

A real probe consists of three-layers: heater, filling material and shield. It must be checked how three-layer construction will have effect on temperature field. Assumed parameters of the modeled probe are: heater (copper) $\varnothing = 1$ mm, $a = 116 \cdot 10^{-6}$ m²/s, $k = 401$ W/(m·K), filling material (epoxide gum) $d = 0.5$ mm, $a = 7.8 \cdot 10^{-7}$ m²/s, $k = 1.3$ W/(m·K), shield (brass) $d = 0.5$ mm, $a = 34.2 \cdot 10^{-6}$ m²/s, $k = 111$ W/(m·K) where d is thickness of the layer. Other simulation conditions are similar to those mentioned in subsection 2.1. Again, a half section of the sample with the thermal probe and discrete mesh are presented in Fig. 5.

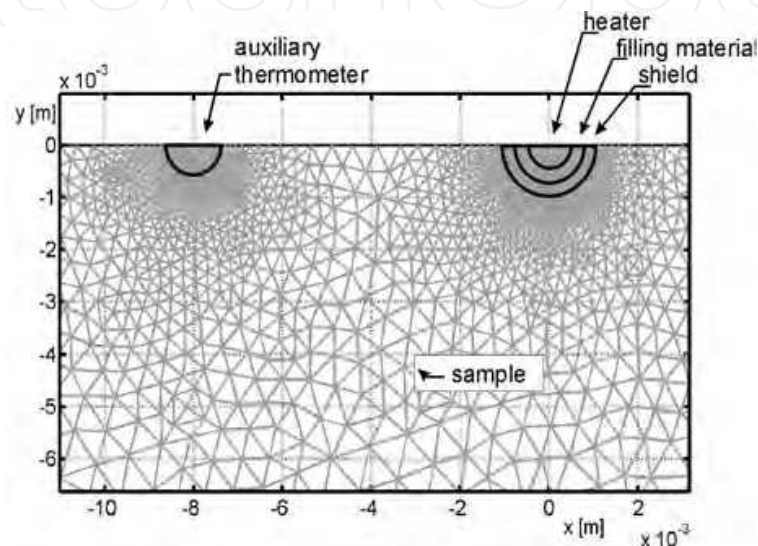

Fig. 5. A half section of sample with thermal probe and discrete mesh for multi-layer probe

Fig. 6 shows the temperature profile of the sample after 100 s (a) and top view of it with marked points 1-4 used to analyze the temperature difference (b).

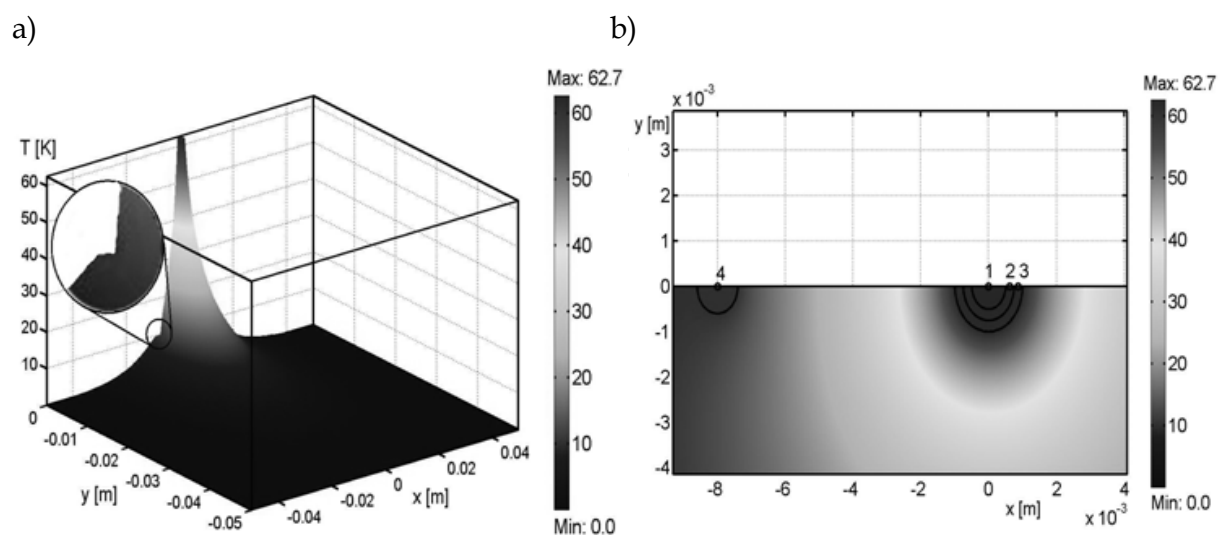

Fig. 6. The temperature profile of sample after 100 s (a) and top view with marked points 1-4 (b)

Fig. 7 presents changes in temperature in arbitrary chosen points 1-4. These numbers correspond to the following curves: heater (curve 1), filling material (curve 2), shield (curve 3) and real auxiliary thermometer (curve 4) in time period 0-100 s after the start of sample heating. In this case the curves 1, 2 and 3 dedicated to the three layers of the probe, overlap each other. It means that the assumption about nonuniform probe is not necessary. The higher temperature value (curve 1) for time instant 100 s in comparison to the value presented in Fig. 4 (also curve 1) is the result of less total heat capacity of nonuniform probe.

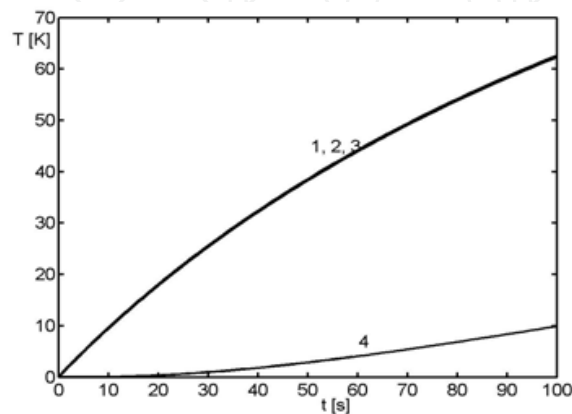

Fig. 7. Changes in temperature of probe parts: heater (1), filling material (2), shield (3) and real auxiliary thermometer (4) placed in a distance of 8 mm from the probe

3. Model of heat diffusion in the sample of insulating material for probe with handle

A typical method of temperature measurement of solid is the contact method, where the sensor is placed into material or has good thermal contact with material surface. Usually, simple sensors are used. They consist of long metal pipe working as a shield and active part assembled inside the pipe. One of the pipes is ended by a header or a handle with wires. Placement of the sensor into checked material causes some disturbance in the temperature field. The case of stationary temperature field measurement needs sufficiently long waiting for transient state to fade. In general, the dynamical error caused by the sensor presence must be taken into consideration. Usually contact temperature sensors have length much bigger than diameter and therefore the heat transfer along the sensor is neglected. This simplification can be erroneous in the case of small heat transfer coefficient of active sensor surface, because the temperature of the probe handle can have relevant impact on sensor measured temperature.

3.1. Model of heat diffusion in the sample of insulating material for probe with significant heat capacity handle

In Fig. 8 a model of uniform probe (copper) of a diameter of 2 mm and length of 10 cm long with handle (plastics) of a diameter of 5 mm and length of 2 cm is presented.

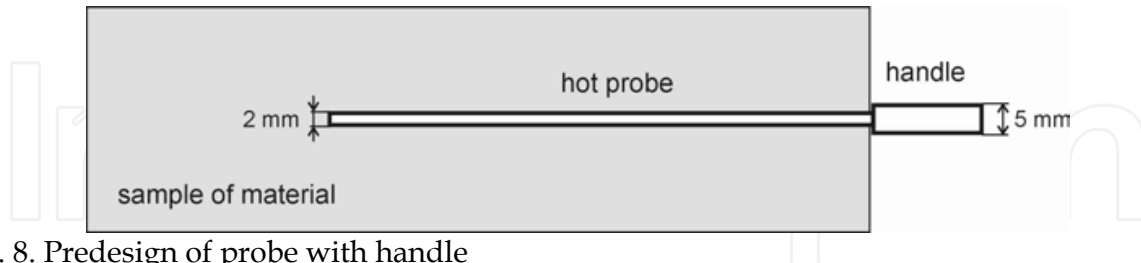
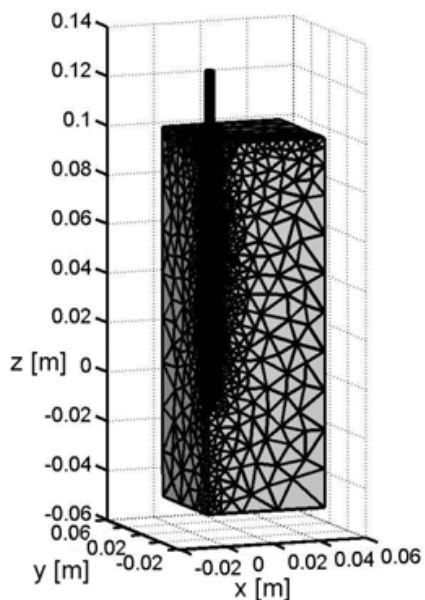

Fig. 8. Pre-design of probe with handle

Fig. 9. presents a quarter of symmetrical model of the probe with handle in XYZ co-ordinates: discrete mesh (a), temperature field after 100 s (b). The considered sample of material is treated as a cuboid which base dimensions are 10 x 10 cm and the height is 15 cm. The third kind of boundary condition (Fourier-Robin) on lateral surfaces of the sample and the probe handle was assumed. The typical value of heat transfer coefficient $\alpha=5$ W/(m²·K) for laminar, natural heat flow close to surface was taken from (Grigoryev, 1991).

a)



b)

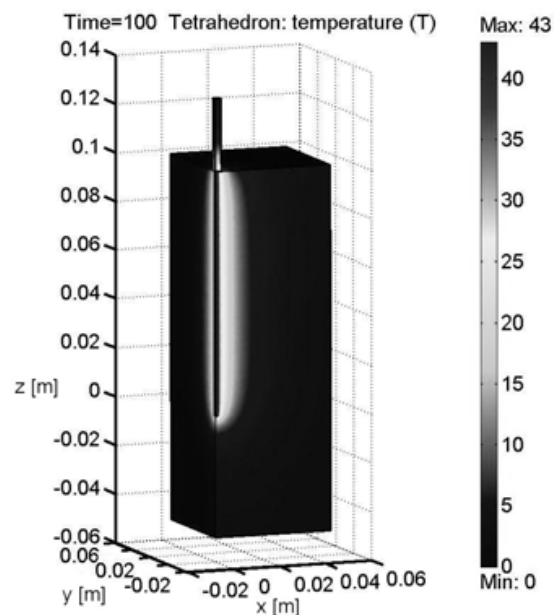

Fig. 9. Quarter of symmetrical model of probe with handle in XYZ co-ordinates: discrete mesh (a), temperature field after 100 s (b)

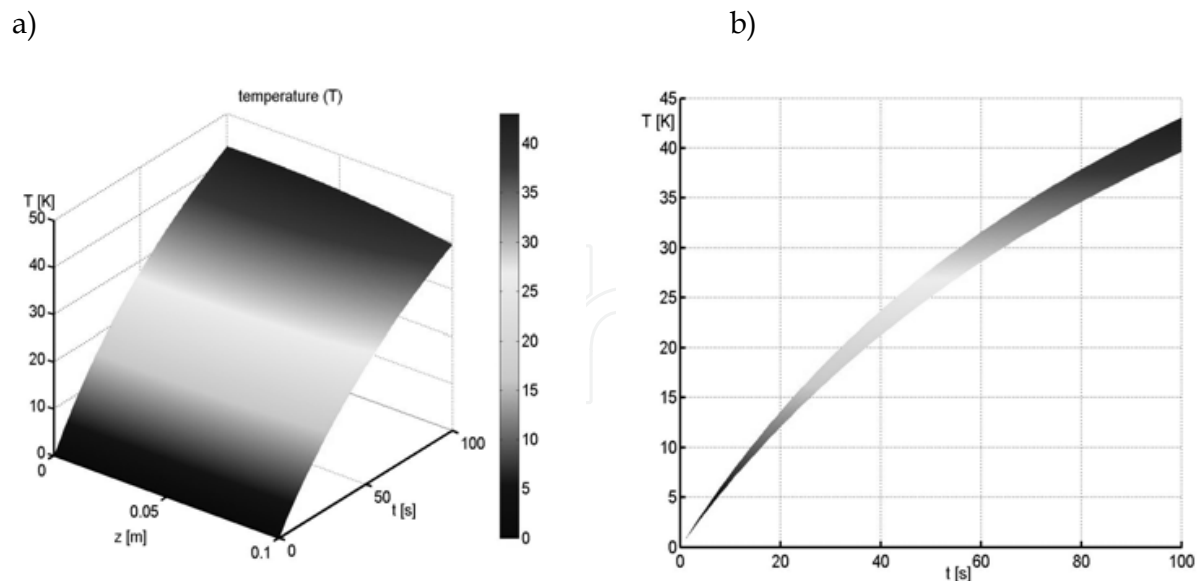

Fig. 10. Temperature changes along probe length (Z axis) after 100 s (a) and Z axis view presenting the changes in temperature along probe (b)

Zero values of initial conditions were assumed. The values of thermal parameters of the probe and the sample of material are the same as those considered in chapter 2. Fig. 10a presents the temperature profile along probe length (Z axis) after 100 s (a). For better visibility the Z axis view presenting the changes in temperature gradient along the probe was additionally showed in Fig. 10b.

It follows from Fig. 10 that change in temperature along probe after 100 s is about 3.5 K. For the probe made of copper this value is relatively big. The probe handle is made of plastic whose thermal conductivity is several times less than for metals. The amount of heat absorbed by handle is considerable in comparison to the heat absorbed by the sample of material. Taking into consideration the presence of the probe handle in model is difficult. The boundary conditions on handle surfaces depend on ambient conditions and generally are not predictable in real measurements. To eliminate this undesirable effect being an additional source of measurement error, the thermal probe handle compensation can be used.

IntechOpen

3.2. Model of heat diffusion in the sample of insulating material for probe with temperature compensated handle

If the handle is temperature compensated, its presence in mathematical model can be neglected. Other simulation conditions are the same as in subsection 3.1. Fig. 11 presents a quarter of symmetrical model of probe without handle (equivalently to temperature compensated handle) in XYZ co-ordinates: discrete mesh (a), temperature field after 100 s (b).

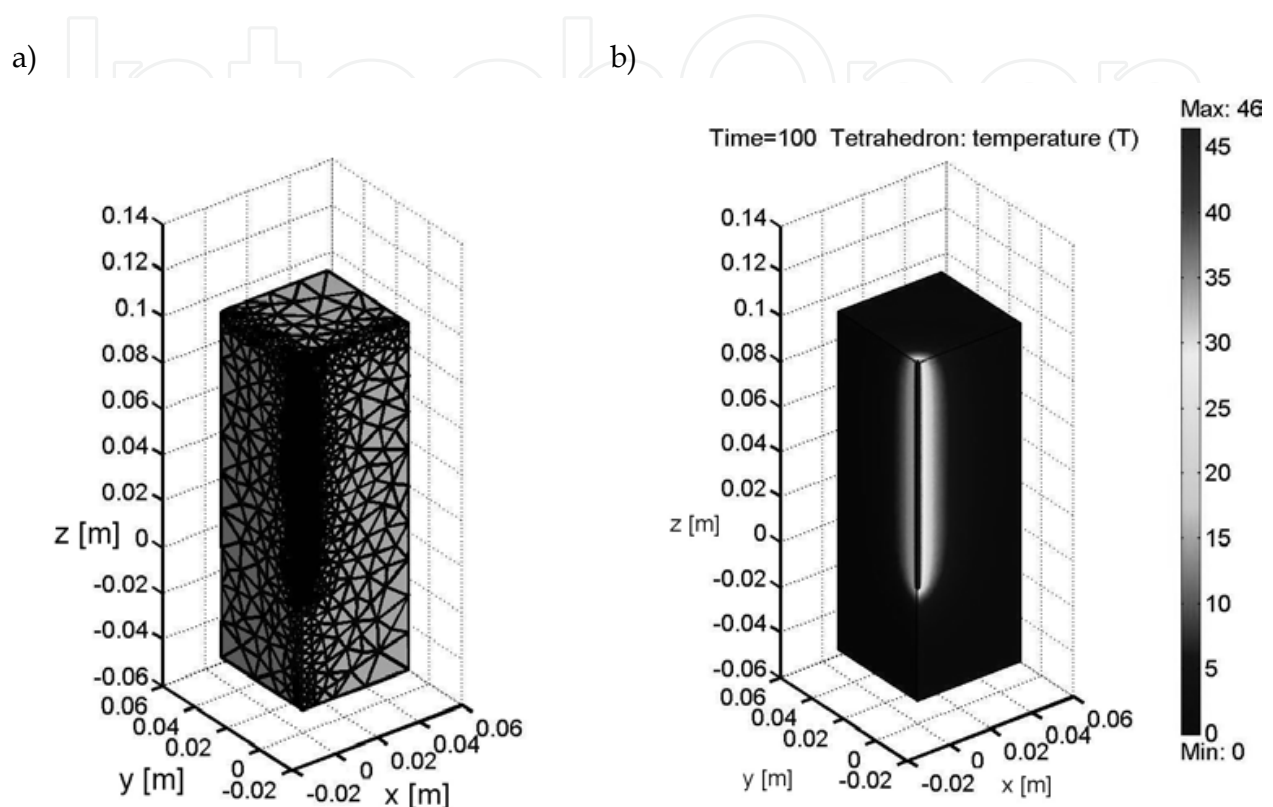

Fig. 11. Quarter of symmetrical model of probe with temperature compensated handle in XYZ co-ordinate: discrete mesh (a), temperature field after 100 s (b)

Fig. 12 presents the changes in temperature gradient along Z-axis after 100 s: probe with handle (curve 1) and probe without handle (curve 2) or temperature compensated handle. It is evident that temperature gradients after 100 s differ from each other significantly. The increase of average temperature in the middle of the probe length for probe with handle is 42.0 K and for the probe without handle is 46.4 K. It shows how presence of the handle influences the temperature field in the sample of material. The curve 2 is almost flat. It let us state that finite length of probe ($z=0$) and boundary condition on sample top surface ($z=10$) have small impact on the temperature field. Similar simulations for the probe with handle for another boundary condition on lateral and bottom surface of the sample were conducted. In this case, the sample is completely thermally insulated from surroundings with the exception of the top surface. No visible difference between corresponding curves 2 was observed hence they are not presented in the paper.

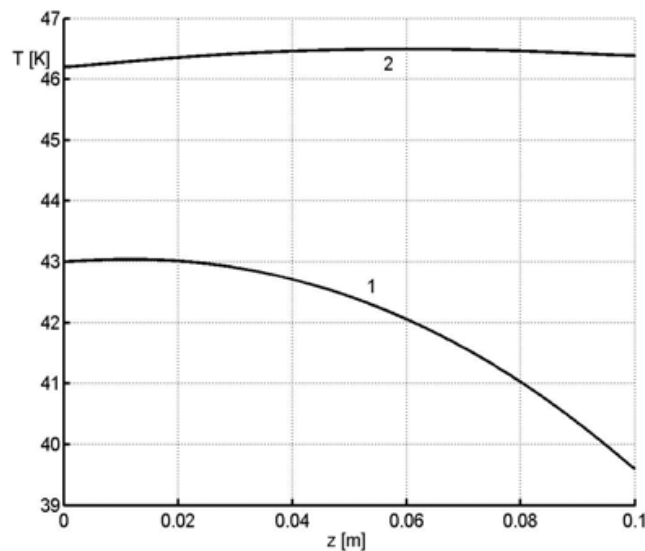

Fig. 12. Changes in temperature along Z-axis after 100 s: probe with handle (curve 1), probe without handle (curve 2)

4. Neural network in inverse problem solution

A neural network can learn a phenomenon model when analytic description is complicated or unknown. It is sufficient to present at the training stage the values of input quantities of the modeled phenomenon or system at the network inputs. There are assumed values of output quantities (responses) of the modeled phenomenon or system at the network outputs. The key problem is optimal selection of the network architecture. Different types of neural network have specific limitations in terms of functions they can represent. A lot of possible applications of neural networks have not been investigated yet or are still under research. In this work, we attempt to investigate the usability of a neural network in solving the coefficient inverse problem. In computer simulations simple network architecture was initially defined and next, its performance for model of heat conduction was tested. The idea of the coefficient inverse problem solution is presented in Fig. 1. The network determines the value of heat diffusivity a and heat conductivity k on the basis of the temperature responses recorded at the hot probe $T_H(t)$ in the symmetry axis and the auxiliary thermometer $T_X(t)$ in the sample and assuming repeatable boundary conditions. The network can be trained with temperature values (or its increments with respect to the initial condition) calculated for given values of a and k which have been taken from predicted ranges of its possible variations.

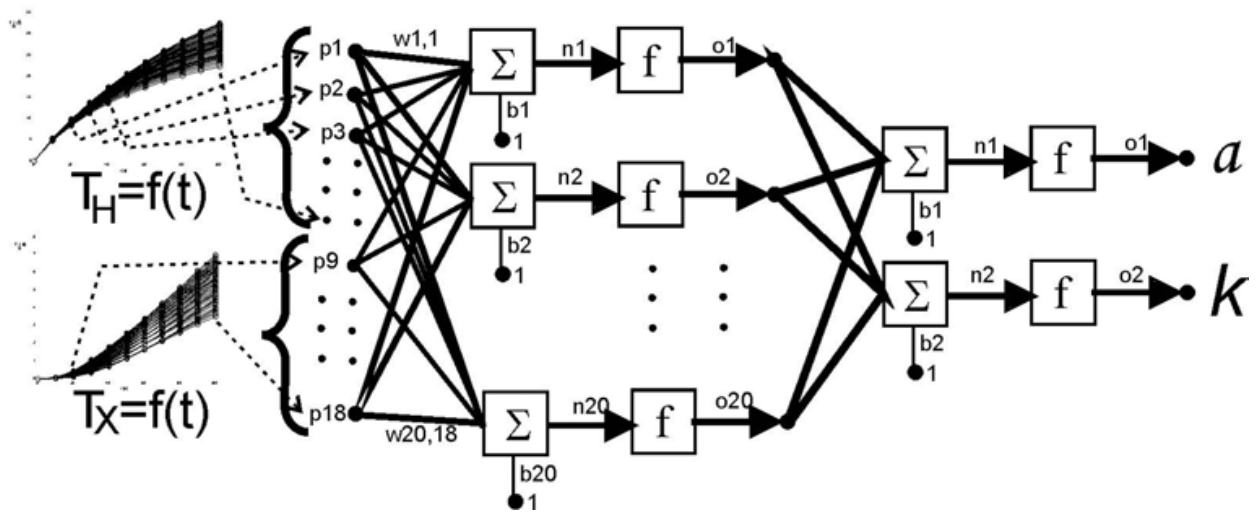

Fig. 1. Hypothetical architecture of the neural network with input and output signals

4.1. Discussion on the neural network architecture

Using the model and the FEM presented in part 1 of the paper there were generated training vectors of nine selected instantaneous values of the temperature responses of the hot probe $T_H(t)$ and the auxiliary thermometer $T_X(t)$ in the sample for 10×10 combinations of values of $a \in (1.0 \div 3.0) \cdot 10^{-6} \text{ m}^2/\text{s}$ and $k \in (3.0 \div 5.0) \cdot 10^{-2} \text{ W}/(\text{m} \cdot \text{K})$ for time interval 100 s. The training input vectors of the instantaneous values of the temperature $T_H(t)$ and $T_X(t)$ are shown in Fig. 2 and Fig. 3.

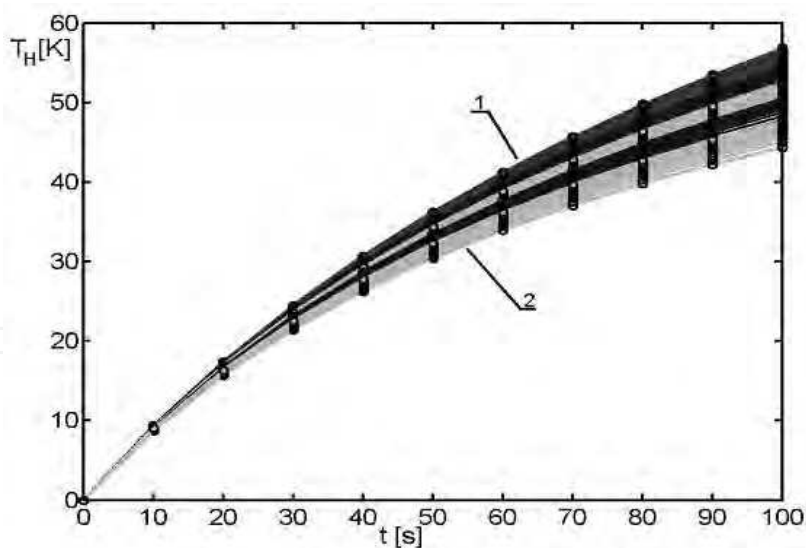

Fig. 2. Temperature changes in the symmetry axis of the hot probe $T_H(t)$: 1) $a=1.0 \cdot 10^{-6} \text{ m}^2/\text{s}$, $k=3.0 \cdot 10^{-2} \text{ W}/(\text{m} \cdot \text{K})$ and 2) $a=3.0 \cdot 10^{-6} \text{ m}^2/\text{s}$, $k=5.0 \cdot 10^{-2} \text{ W}/(\text{m} \cdot \text{K})$

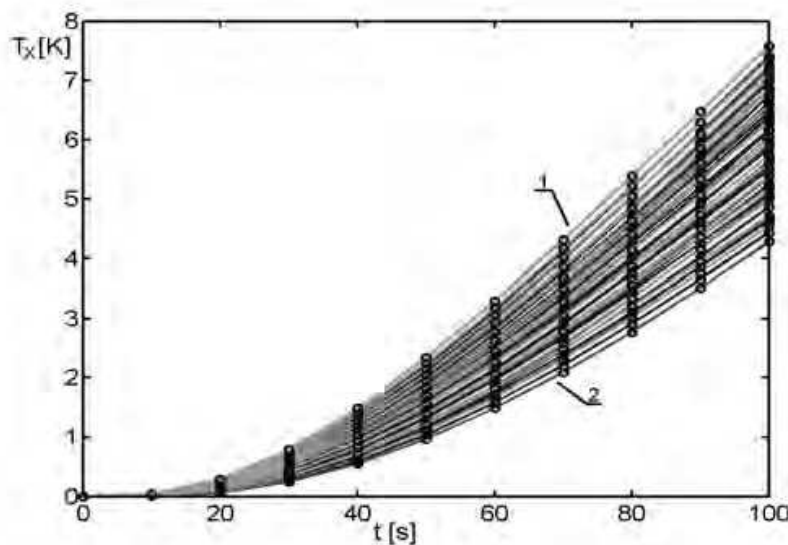

Fig. 3. Temperature changes of the auxiliary thermometer $T_x(t)$: 1) $a=3.0 \cdot 10^{-6} \text{ m}^2/\text{s}$, $k=5.0 \cdot 10^{-2} \text{ W}/(\text{m} \cdot \text{K})$ and 2) $a=1.0 \cdot 10^{-6} \text{ m}^2/\text{s}$, $k=3.0 \cdot 10^{-2} \text{ W}/(\text{m} \cdot \text{K})$

Several architectures of the neural network were tested (all with 2 linear neurons in output layer) (Hagan et al., 1996; Caudill & Butler 1992) :

- two-layer classical nonlinear network with 10 neurons in input layer for 20, 50 and 1000 training epochs,
- two-layer classical nonlinear network with 20 neurons in input layer for 20, 50 and 1000 training epochs,
- three-layer classical nonlinear network with 20 neurons in input layer and 10 neurons in hidden layer for 25 and 1000 training epochs,
- radial basis functions RBF,
- radial basis function RBF with given error goal,
- generalized regression GRNN.

The neural networks were trained by presenting successive training vectors including the values of T_H and T_X at their inputs (input vectors) and the corresponding values of a and k coefficients at their outputs (target vectors).

In the case of classical radial basis function neural network, the results confirm its possibility to appreciatively solve the inverse problem. For some learning parameters the output error is negligible for training and testing data. However, network structure consisting of 100 RBF neurons is relatively big. In the case of GRNN the "overfitting effect" was occurring. The network answered with small error for training vector, but for intermediate values, that are included in testing vector, the output error was very big. Reduction of the number of the neurons or decreasing the size of training vector can remove this disadvantage. The Matlab environment has in this case limited possibilities of parameter selection. Furthermore, the input training vector preprocessing or output vector postprocessing can also be helpful. This extra processing of this data increases the algorithm complexity. A better solution is application of the RBF network with given error goal which automatically choose the number of neurons to draw output error with error goal. Such a solution facilitates looking for the optimal network structure because the amount of neurons is automatically selected. Better results were obtained for classical nonlinear network with

hyperbolic tangent transfer function in input and hidden layers. In the case of hidden layer, it is sufficient to use the linear activity function. Three-layer network reached good performance after 25 epochs. Thanks to its flexibility the overfitting did not occur. Taking 1000 epochs, the output error was very small, both for learning and testing vectors. Performance of two-layer network was also investigated. The output error in this case was somewhat larger than for three-layer network but it can be compensated by longer learning period (more epochs).

4.2. Results of simulation for “optimal” neural network search

The best of considered architectures of the neural network was the classical nonlinear feedforward two-layer neural network: 20 neurons with hyperbolic-tangent transfer function in input layer and two neurons with linear transfer function in output layer. The network has 18 inputs and 2 outputs. The vector of nine instantaneous values of the temperature of the heating probe T_H and the vector of nine instantaneous values of the temperature of the auxiliary thermometer T_X are loaded into 18 inputs of the neural network. The network achieved satisfactory results already after about 50 training epochs. An example of the network training process for the traditional error back propagation algorithm is presented in Fig. 4.

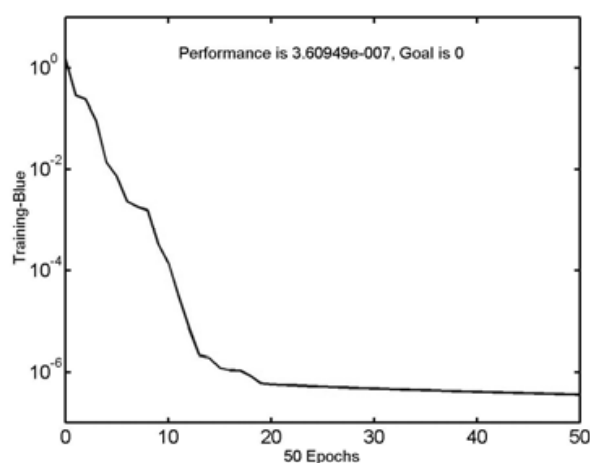

Fig. 4. Error of network learning during 50 epochs

The network outputs were compared to the values of heat diffusivity and heat conductivity coefficients given in the training stage. The relative errors of the network response are presented in Fig. 5.

To verify whether the network response is correct for intermediate values of a and k from the ranges defined above, the responses were simulated for 100 values of heat diffusivity coefficient a from the range $a \in (1.0; 3.0) \cdot 10^{-6}$ m²/s and 100 values of heat conductivity coefficient k from the range $k \in (3.0; 5.0) \cdot 10^{-2}$ m²/s. Consequently, there 10000 different testing vectors were generated. Fig. 7 and Fig. 8 show the relative error of the network response versus target value of the coefficients a and k .

The performance of a trained network was additionally measured using regression analysis between the network response and the corresponding targets. In the posttraining analysis the “Linear regression method” implemented in Matlab was used for network validation.

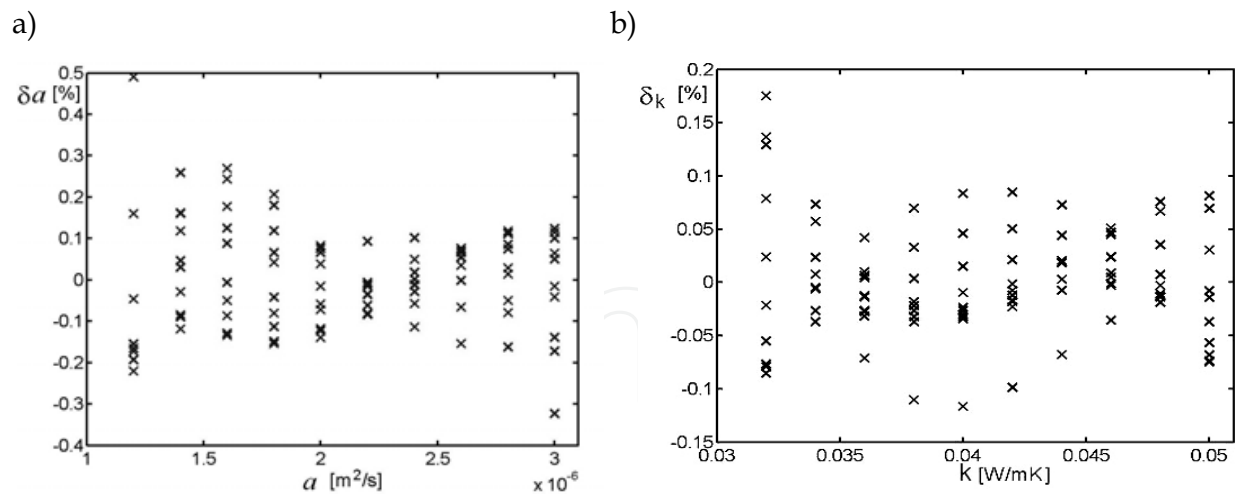

Fig. 5. Relative error of the network response for thermal diffusivity a (a) and for thermal conductivity k (b) for the training stage

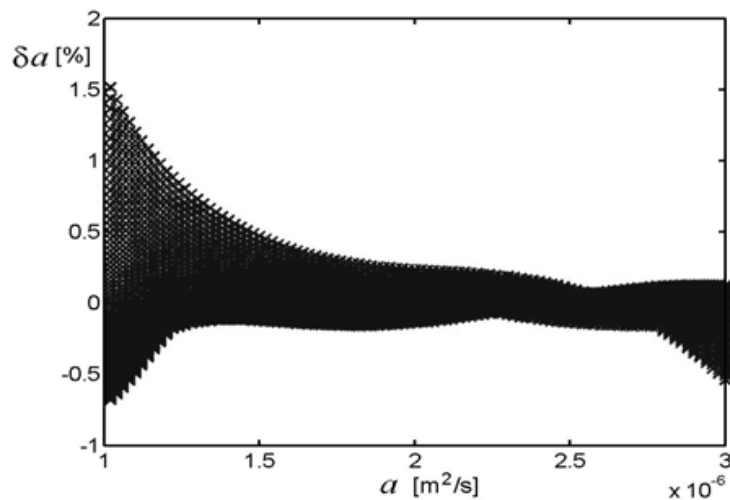

Fig. 7. Relative error of the network response for thermal diffusivity a for the testing stage

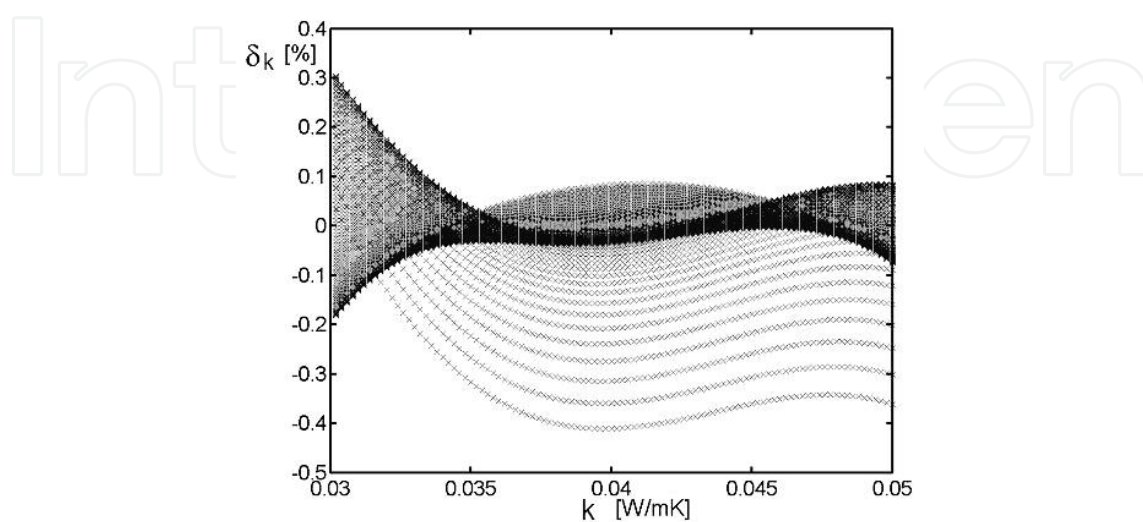

Fig. 8. Relative error of the network response for thermal conductivity k for the testing stage

In Fig. 9 and Fig. 10 the perfect fit (outputs exactly equal to targets) can be seen, the slope is almost 1, and the y -intercept is 0.

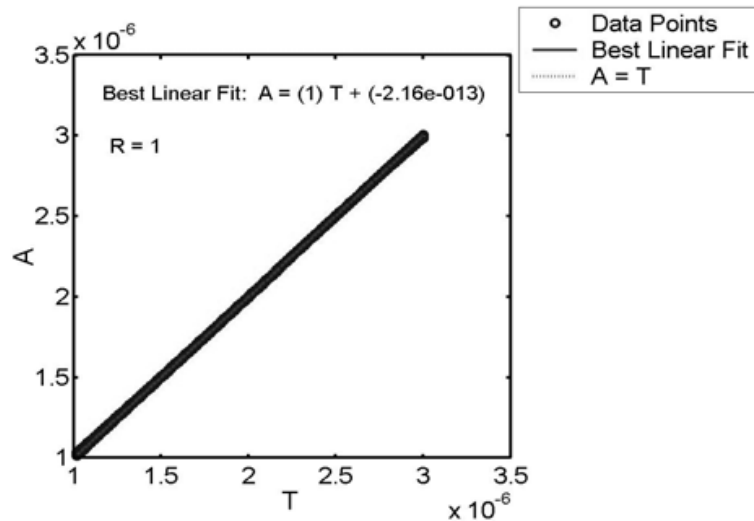

Fig. 9. Linear regression method matching for heat diffusivity: T - given training output value of a , A - network answer

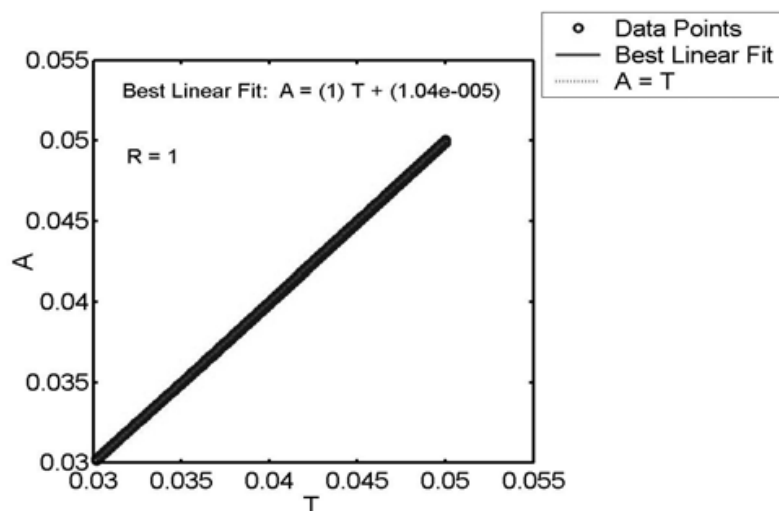

Fig. 10. Linear regression method matching for heat conductivity: T - given training output value of k , A - network answer

Furthermore, the correlation coefficient R that indicates how well the variation in the output is explained by the targets, is equal to 1. Thus, there is perfect correlation between the targets and the outputs. It means that approximation quality of the neural network is very good.

As mentioned earlier, the chosen network architecture was classical nonlinear two-layer neural network. On this stage of the research this architecture cannot be objectively treated as optimal. Generalization ability is one of many conditions a network must satisfy only. A very important issue is determination of sensitivity of the neural network to input quantities disturbance. Good ability of generalization of the chosen network going hand in hand with its small sensitivity must be proved. If it fails, then another network candidate for "optimal network architecture" must be selected and checked.

5. Sensitivity analysis of neural network on input quantities disturbance

Sensitivity analysis of the neural network on existing in real measurement uncertainties is a very essential stage of method validation. The designed instrumentation is dedicated to immediate measurements, hence uncertainty on a level of a few percents is sufficient. In this study, there was assumed, that the following input quantities had influence on the output quantities a and k :

- temperature of the hot probe $T_H(t)$,
- temperature of the auxiliary thermometer $T_X(t)$,
- heat power P_G supplying the hot probe,
- distance r between the hot probe and the auxiliary thermometer.

5.1. Application of Monte Carlo technique in sensitivity analysis

In Ref. (Joint Committee for Guides in Metrology, 2004), treated as supplement to Guide to the Expression of Uncertainty in Measurement (BIPM et al., 1995) an interesting procedure is proposed. It gives recommendation how the uncertainty could be evaluated if the conditions for „law of propagation of uncertainty” are not fulfilled, because of the complexity of the model, for example (Joint Committee for Guides in Metrology, 2004).

The procedure applies to evaluation of 95% coverage interval for the output quantity value.

The described procedure consists of the following stages (BIPM et al., 1995):

- a) define the output quantity, the quantity required to be measured,
- b) decide the input quantities upon which the output quantity depends,
- c) develop a model relating the output quantity to these input quantities,
- d) on the basis of available knowledge assign probability density functions to the values of the input quantities,
- e) propagate the probability density functions for the values of the input quantities through the model to obtain the probability density function for the output quantity value,
- f) obtain from the probability density function for the output quantity value:
 - 1) its expectation, taken as the estimate of the output quantity value;
 - 2) its standard deviation, taken as the standard uncertainty associated with the estimate of the output quantity value,
 - 3) the coverage interval containing the unknown output quantity value with a specified probability.

Generation of input quantities for 10^6 trials (this number is strongly recommended by (Joint Committee for Guides in Metrology, 2004)) and model developing for one pair given thermal parameters were taken over 6 days using modern PC computer. Hence, the analysis was constrained to the following five combinations of values treated as “true” values:

1. $a=2.5 \cdot 10^{-6} \text{ m}^2/\text{s}$ and $k= 4.0 \cdot 10^{-2} \text{ W}/(\text{m} \cdot \text{K})$,
2. $a=1.5 \cdot 10^{-6} \text{ m}^2/\text{s}$ and $k= 3.3 \cdot 10^{-2} \text{ W}/(\text{m} \cdot \text{K})$,
3. $a=3.5 \cdot 10^{-6} \text{ m}^2/\text{s}$ and $k= 4.7 \cdot 10^{-2} \text{ W}/(\text{m} \cdot \text{K})$,
4. $a=3.5 \cdot 10^{-6} \text{ m}^2/\text{s}$ and $k= 3.3 \cdot 10^{-2} \text{ W}/(\text{m} \cdot \text{K})$,
5. $a=1.5 \cdot 10^{-6} \text{ m}^2/\text{s}$ and $k= 4.7 \cdot 10^{-2} \text{ W}/(\text{m} \cdot \text{K})$.

Uniform symmetric distribution of probability of input quantities was assumed with the following half widths: $\Delta T_H(t)=0.1 \text{ K}$, $\Delta T_X(t)=0.05 \text{ K}$, $\Delta P_G=1 \text{ mW}/\text{m}$, $\Delta r=0.1 \text{ mm}$. To obtain distribution function of network output quantities a and k the Monte Carlo simulation technique was applied. For each pair of a and k the output value of the network was

computed and estimates of distribution function $G(a)$ and $G(k)$ were carried out. According to f) point of the above mentioned procedure (underlined text) the recommended parameters: expectation, standard deviation and 95% coverage interval were obtained and presented in Table I.

No.	Heat diffusivity a m ² /s			Heat conductivity k W/(m·K)		
	Expectation	Standard deviation	95 % coverage interval	Expectation	Standard deviation	95 % coverage interval
1	$2.53 \cdot 10^{-6}$	$2.74 \cdot 10^{-8}$	$[2.48 \cdot 10^{-6}; 2.58 \cdot 10^{-6}]$	$4.05 \cdot 10^{-2}$	$4.29 \cdot 10^{-4}$	$[3.97 \cdot 10^{-2}; 4.13 \cdot 10^{-2}]$
2	$1.49 \cdot 10^{-6}$	$2.30 \cdot 10^{-8}$	$[1.45 \cdot 10^{-6}; 1.54 \cdot 10^{-6}]$	$3.29 \cdot 10^{-2}$	$4.16 \cdot 10^{-4}$	$[3.21 \cdot 10^{-2}; 3.37 \cdot 10^{-2}]$
3	$3.41 \cdot 10^{-6}$	$2.95 \cdot 10^{-8}$	$[3.35 \cdot 10^{-6}; 3.45 \cdot 10^{-6}]$	$4.56 \cdot 10^{-2}$	$4.05 \cdot 10^{-4}$	$[4.49 \cdot 10^{-2}; 4.64 \cdot 10^{-2}]$
4	$3.33 \cdot 10^{-6}$	$3.02 \cdot 10^{-8}$	$[3.27 \cdot 10^{-6}; 3.39 \cdot 10^{-6}]$	$3.27 \cdot 10^{-2}$	$4.01 \cdot 10^{-4}$	$[3.19 \cdot 10^{-2}; 3.34 \cdot 10^{-2}]$
5	$1.49 \cdot 10^{-6}$	$2.24 \cdot 10^{-8}$	$[1.44 \cdot 10^{-6}; 1.53 \cdot 10^{-6}]$	$4.70 \cdot 10^{-2}$	$4.65 \cdot 10^{-4}$	$[4.61 \cdot 10^{-2}; 4.79 \cdot 10^{-2}]$

Table 1. Estimated parameters of probability for five combination of parameters a and k and for two layer classical neural network

This table is valid for the previously tested classical nonlinear two-layer neural network: 20 neurons with hyperbolic-tangent transfer function in input layer and two neurons with linear transfer function in output layer. Analysis of data from Table I let us state that the relative extended uncertainty (95% coverage interval) of estimated thermal parameters a and k for all five cases did not exceed 3% and 2.5%, respectively.

Similar analysis was conducted for other network architectures and configurations mentioned and tested in the chapter II. The best results were obtained for RBF network with error goal. They are presented in Table II.

No.	Heat diffusivity a m ² /s			Heat conductivity k W/(m·K)		
	Expectation	Standard deviation	95 % coverage interval	Expectation	Standard deviation	95 % coverage interval
1	$2.50 \cdot 10^{-6}$	$2.73 \cdot 10^{-8}$	$[2.45 \cdot 10^{-6}; 2.55 \cdot 10^{-6}]$	$4.00 \cdot 10^{-2}$	$2.32 \cdot 10^{-4}$	$[3.96 \cdot 10^{-2}; 4.04 \cdot 10^{-2}]$
2	$1.50 \cdot 10^{-6}$	$1.56 \cdot 10^{-8}$	$[1.45 \cdot 10^{-6}; 1.53 \cdot 10^{-6}]$	$3.30 \cdot 10^{-2}$	$2.07 \cdot 10^{-4}$	$[3.26 \cdot 10^{-2}; 3.33 \cdot 10^{-2}]$
3	$3.49 \cdot 10^{-6}$	$3.75 \cdot 10^{-8}$	$[3.43 \cdot 10^{-6}; 3.56 \cdot 10^{-6}]$	$4.70 \cdot 10^{-2}$	$2.56 \cdot 10^{-4}$	$[4.66 \cdot 10^{-2}; 4.75 \cdot 10^{-2}]$
4	$3.48 \cdot 10^{-6}$	$4.98 \cdot 10^{-8}$	$[3.40 \cdot 10^{-6}; 3.57 \cdot 10^{-6}]$	$3.30 \cdot 10^{-2}$	$2.07 \cdot 10^{-4}$	$[3.26 \cdot 10^{-2}; 3.33 \cdot 10^{-2}]$
5	$1.50 \cdot 10^{-6}$	$1.22 \cdot 10^{-8}$	$[1.48 \cdot 10^{-6}; 1.52 \cdot 10^{-6}]$	$4.70 \cdot 10^{-2}$	$2.46 \cdot 10^{-4}$	$[4.66 \cdot 10^{-2}; 4.74 \cdot 10^{-2}]$

Table 2. Estimated Parameters of Probability for Five Combination of Parameters a and k and for RBF neural Network

Analysis of data from Table II let us state that the relative extended uncertainty (95% coverage interval) of estimated thermal parameters a and k for all five cases did not exceed 3% and 1.5%, respectively.

6. Conclusion

The aim of the presented analysis was checking how several details of the considered model of heat diffusion affects the temperature field. The recommendations for the next research stage are:

- assumed dimensions of measuring stand are accurate, hot probe can be treated as uniform (fewer elements of discrete mesh),
- presence of auxiliary thermometer and probe handle must be considered in mathematical model,
- the sample dimensions checked in simulations let treat a real sample as infinitely widespread.

It allows for conducting measurement with no specially prepared sample assuming that the sample dimensions are greater or equal than considered in the paper, i.e. 10 x 10 cm (base) x 15 cm (height). This is the great advantage of proposed method.

The usability of an artificial neural network (ANN) to estimate the coefficients of inverse heat conduction problem for solid will be presented. The network should determine the value of effective thermal conductivity and effective thermal diffusivity on the basis of temperature response of hot probe and auxiliary thermometer. In developing of the ANN model, several configurations of ANN architecture will be checked.

The results obtained in simulations show that is possible to determine the parameters of insulating material using trained neural networks for repeatable input function of the probe and measurement conditions. Such a solution could considerably reduce the cost of the measuring system.

The recommended network architecture for further study is the classical nonlinear two-layer neural network: 20 neurons with hyperbolic-tangent transfer function in input layer and two neurons with linear transfer function in output layer. 50 epochs should be sufficient to achieve a good result of the network training. The relative extended uncertainty (95% coverage interval) of estimated thermal parameters a and k will not exceed 3% and 2.5%, respectively. This network was chosen as a compromise between generalization ability, architecture simplicity, small output error and small sensitivity on input signal disturbances.

The main aim of the research is to determine the three basic thermal parameters on a single portable measuring system in a relatively short time and not only in laboratory (fully controlled) conditions.

The future work will be experimental verification of the proposed method on real samples of insulating material taking into consideration sample size, network architecture, training recommendation and the use of a real probe consisting of a hot probe and an auxiliary thermometer with temperature compensated handle.

7. Acknowledgment

This work was supported by Ministry of Science and Higher Education of Poland under research grant No. N N505 3129 33 realized in years 2007-2009.

8. References

- Boer J., Butter J., Grosskopf B. & Jeschke P. (1980), Hot wire technique for determining high thermal conductivities, *Refractories Journal*, vol. 55, 1980.
- Quinn T.J. (1983) *Temperature*. Academic Press Ltd., London, 1983.
- Beck J.V. (1985). *Inverse Heat Conduction*. A Wiley-Intersc. Publ., 1985.
- Platunov C.E. (1986). *Thermophysical Measurements and Instrumentation* (title in Russian is Теплофизические измерения и приборы), Изд. Машиностроение, San Petersburg, 1986.
- Bayazitoğlu Y. & Özişik M.N. (1988) *Elements of Heat Transfer*. McGraw-Hill Book Company, New York, 1988.
- Grigoryev I.C. (1991). *Physical quantities*. Handbook (title in Russian is Физические величины, Справочник). Энергоатомиздат, Moscow, 1991.
- Caudill M. & Butler C. (1992). *Understanding Neural Networks: Computer Explorations*, Vols. 1 and 2, Cambridge, MA The MIT Press, 1992.
- Bejan A., (1993). *Heat Transfer*. John Wiley & Sons, New York, 1993.
- BIPM, IEC, IFCC, ISO, IUPAC, IUPAP & OIML, (1995). *Guide to the Expression of Uncertainty in Measurement*. 1995.
- Alifanov O., Artyukhin E. & Romyantsev S. (1995). *Extreme Methods for solving Ill-Posed Problems with Applications to Inverse Heat Transfer Problems*, New York, 1995.
- Augustin S. & Bernhard F. (1996). Numerical calculation of static and dynamic parameters of industrial temperature sensors, *Measurement*, vol. 17, pp. 217-228, 1996.
- Hagan M.T., Demuth H.B. & Beale M.H. (1996) *Neural Network Design*, Boston, MA PWS Publishing, 1996.
- Jurkowski J., Jarny Y. & Delanuay Y. (1997). Estimation of thermal conductivity of thermoplastics under moulding conditions: an apparatus and an inverse algorithm, *Int. J. Heat Mass Transfer*, vol. 17, pp. 4169-4181, 1997.
- Daponte P. & Grimaldi D. (1998). Artificial neural networks in measurements, *Measurement*, vol. 23, pp. 93-115, 1998.
- Chudzik S. (1999). Determination of thermal diffusivity of heat-insulating material using neural networks (title in Polish is Okreslenie współczynnika dyfuzyjności cieplnej materiałów termoizolacyjnych z wykorzystaniem sieci neuronowych) *Proc. of 3th Scientific-Technical Conference on Methods and Computer Systems in Automatics and Electrical Engineering*, Poraj (Poland), pp. 126-128, September 1999.
- Tavman I.H. & Tavman S. (1999). Measurement of thermal conductivity of dairy products, *Journal of Food Engineering*, vol. 41, pp. 109-114, 1999.
- Janna W.S. (2000) *Engineering Heat Transfer*. CRS Press, Washington DC, 2000.
- Kubicar L. & Bohac V. (2000) A Step-wise method for measuring thermophysical parameters of materials, *Meas. Sci Technol.*, vol. 11, pp. 252-258, 2000.
- Sylos Cintra J. & Santos W. (2000) Numerical analysis of sample dimensions in hot wire thermal conductivity measurements, *Journal of the European Ceramic Society*, vol. 20, pp. 1871-1875, 2000.
- Bouguerra A., Ait-Mokhtar O., Amiri M. & Diop B. (2001) Measurement of thermal conductivity, thermal diffusivity and heat capacity of highly porous building materials using transient plane source technique, *Int. Comm Heat Mass Transfer*, vol. 28, pp. 1065-1078, 2001.

- Chudzik S. & Minkina W. (2001). Quick quality inspection of thermal parameters of heat-insulating materials, *International Conference Material Testing and Research*, Nuremberg, Germany, pp. 341-347, May 2001.
- Chudzik S. & Minkina W. (2001a). Dynamic method to determine thermal parameters of heat-insulating materials, *TEMPMEKO'2001, 8th International Symposium on Temperature and Thermal Measurements in Industry and Science IMEKO TC 12*, vol. II, pp. 963-968, Berlin, Germany, June 2001.
- Chudzik S., Grys S. & Bąbka R. (2001). Identification of thermal parameters of heat-insulating materials using neural networks" (title in Polish is Identyfikacja parametrow cieplnych materialow termoizolacyjnych z wykorzystaniem sieci neuronowych), *Proc. of 4th Scientific-Technical Conference on Methods and Computer Systems in Automatics and Electrical Engineering*, Poraj (Poland), pp.46-48, September 2001.
- Ventkaesan G., Guang-Pu Jin, (2001). Measurement of thermophysical properties of polyurethane foam insulation during transient method, *Int. J. Therm. Sci.*, vol. 40, pp. 133-144, 2001.
- Mahmoud M. & Ben-Nakhi A. (2003). Architecture and performance of neural networks for efficient A/C control in buildings," *Energy Conversion and Management*, vol. 44, pp. 3207-3226, 2003.
- Hasiloglu A., Yilmaz M., Comakli O. & Ekmekci I. (2004). Adaptive neuro-fuzzy modeling of transient heat transfers in circular duct air flow, *International Journal of Thermal Sciences*, vol. 43, pp. 1075-1090, 2004.
- Joint Committee for Guides in Metrology (2004). *Guide to the Expression of Uncertainty in Measurement. Supplement 1. Numerical Methods for the Propagation of Distributions.*, 2004.
- Gobbé C., Iserna S. & Ladevie B. (2004). Hot strip method: application to thermal characterisation of orthotropic media, *International Journal of Thermal Sciences*, vol. 43, pp. 951-958, 2004.
- Minkina W. & Chudzik S. (2004). *Measurement of Thermal Parameters of Thermoinsulating Materials - Instrumentation and Methods* (title in Polish is *Pomiary parametrow cieplnych materialow termoizolacyjnych - przyrzady i metody*). Publishing House of Czestochowa University of Technology, ISBN 83-7193-216-2, Czestochowa (Poland), 2004.
- Al-Homoud M. (2005). Performance characteristics and practical applications of common building thermal insulation materials, *Building and Environment*, vol. 40, pp. 353-366, 2005.
- Turias I., Gutie´rrez J. & Galindo P. (2005). Modelling the efective thermal conductivity of an unidirectional composite by the use of artificial neural networks, *Composites Science and Technology*, vol. 65, pp. 609-619, 2005.
- Aquino W. & Brigham J. (2006), Self-learning finite elements for inverse estimation of thermal constitutive models, *International Journal of Heat and Mass Transfer*, vol. 49, pp. 2466-2478, 2006.

IntechOpen

IntechOpen



Advances in Measurement Systems

Edited by Milind Kr Sharma

ISBN 978-953-307-061-2

Hard cover, 592 pages

Publisher InTech

Published online 01, April, 2010

Published in print edition April, 2010

How to reference

In order to correctly reference this scholarly work, feel free to copy and paste the following:

Stanislaw Chudzik (2010). The Idea of the Measurement System for Quick Test of Thermal Parameters of Heat-Insulating Materials, *Advances in Measurement Systems*, Milind Kr Sharma (Ed.), ISBN: 978-953-307-061-2, InTech, Available from: <http://www.intechopen.com/books/advances-in-measurement-systems/the-idea-of-the-measurement-system-for-quick-test-of-thermal-parameters-of-heat-insulating-materials>

INTECH

open science | open minds

InTech Europe

University Campus STeP Ri
Slavka Krautzeka 83/A
51000 Rijeka, Croatia
Phone: +385 (51) 770 447
Fax: +385 (51) 686 166
www.intechopen.com

InTech China

Unit 405, Office Block, Hotel Equatorial Shanghai
No.65, Yan An Road (West), Shanghai, 200040, China
中国上海市延安西路65号上海国际贵都大饭店办公楼405单元
Phone: +86-21-62489820
Fax: +86-21-62489821

intechopen

© 2010 The Author(s). Licensee IntechOpen. This chapter is distributed under the terms of the [Creative Commons Attribution-NonCommercial-ShareAlike-3.0 License](https://creativecommons.org/licenses/by-nc-sa/3.0/), which permits use, distribution and reproduction for non-commercial purposes, provided the original is properly cited and derivative works building on this content are distributed under the same license.

IntechOpen

IntechOpen