

# We are IntechOpen, the world's leading publisher of Open Access books Built by scientists, for scientists

**4,800**

Open access books available

**122,000**

International authors and editors

**135M**

Downloads

Our authors are among the

**154**

Countries delivered to

**TOP 1%**

most cited scientists

**12.2%**

Contributors from top 500 universities



**WEB OF SCIENCE™**

Selection of our books indexed in the Book Citation Index  
in Web of Science™ Core Collection (BKCI)

Interested in publishing with us?  
Contact [book.department@intechopen.com](mailto:book.department@intechopen.com)

Numbers displayed above are based on latest data collected.

For more information visit [www.intechopen.com](http://www.intechopen.com)



# Analysis of Power Absorption by Human Tissue in Deeply Implantable Medical Sensor Transponders

Andreas Hennig, Gerd vom Bögel  
*Fraunhofer IMS, Duisburg  
Germany*

## Abstract

The use of sensor transponder systems in medicine opens valuable possibilities in therapy and diagnostics. This chapter is about physical effects by the use of sensor transponder technology for medicine applications, especially for deeply implanted passive powered sensor transponders. This chapter will inform about present and future applications. The influence of human body on the energy transmission in a sensor transponder system is shown. The dielectrical properties of human tissue are discussed. A way how to estimate losses in an analytical way and with the use of a 3D FDTD method is presented. Finally, a design example of an energy transmission for a sensor transponder is shown with a calculation of the optimal frequency and experimental results.

## 1. Introduction

The treatment of cardiovascular diseases can be significantly improved by continuous monitoring of parameters such as blood pressure, temperature, etc. Miniaturized sensor transponders, implanted into the human body, can improve a therapy considerably. These transponders can be located in different places in the body, monitoring the performance of the heart circulation system. Such transponders make a cabling of the whole body unnecessary. Especially so-called passive transponder systems are of interest, because such implants normally stay inside the body for a long period. Thus, a supply by a local battery is not possible. In such systems, the transponder is contactlessly supplied by a field from the reading device located outside the body. The maximum possible distance between the reading device and the implanted transponder is of high interest, e.g. to make such a system suitable for corpulent patients. Because of that, it is essential to estimate the power loss caused by the heat capacity produced in human tissue. Moreover, human tissue has frequency depending properties. One of the most important tasks is to find the best carrier frequency for the wireless energy transmission. Figure 1 shows an example of a model for an implanted sensor transponder near to the heart and a corresponding reader. The coil of the reader produces an alternating magnetic field. A small part of the magnetic flux couples with the transponder coil. In consequence, a voltage is induced in this coil. With this voltage the electronic of the transponder is supplied with power. On the right hand there can be seen a sensor transponder in shape of a stick developed at Fraunhofer IMS. On the chip photo the front end, sensor and digital part are visible.

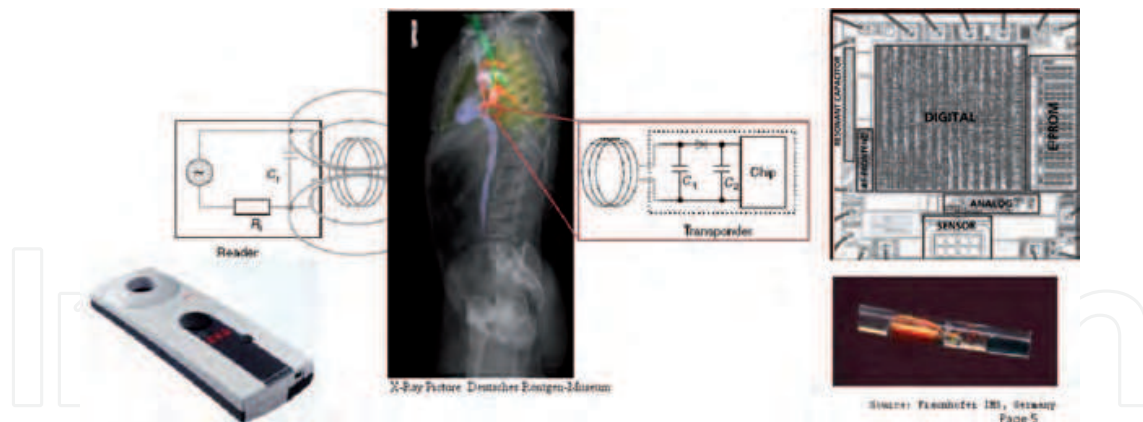

Fig. 1. Model of an inductive sensor transponder system for medical

## 2. Preliminary Considerations

### 2.1 Limitations and Requirements

The dimensions of an implantable transponder should not be more than several millimetres. Otherwise an implantation by a catheter is not possible. From this it follows, that only small antennas in the shape of a stick are supposed. The induced voltage is proportional to the size of the area encircled from the windings. Losses in the energy transmission through human tissue determine the available energy. Transponders with additional sensors consume significantly more energy than simple id transponders. These facts reduces the maximum possible distance. For this application, the distance can reach half a meter.

### 2.2 Frequencies and Antennas

Normally transponder systems work with ISM frequencies. Those are 100 to 150 kHz, in high frequency (HF) 6.78 MHz, 13.56 MHz, 27.125 MHz and 40.68 MHz, as well as 433.92 MHz, 869 MHz and 2.4 GHz in ultra high frequency band (UHF). In LF and HF systems, the distance between reading device and transponder is significantly smaller than the wavelength. This is why it is usually called near-field area. For UHF frequencies the distance is usually bigger than the wavelengths and is thus called far-field. In near-field areas field components are not related to one another and can thus be observed separately. In far-field areas, on the other hand, there are electromagnetic waves. The dimensions of transponder antennas are restricted to a few millimetres. A dipole-antenna to receive electromagnetic waves in ultra high frequency would be too big. Furthermore, an absorption effect is expected, which makes a passive use of the transponder impossible. This is why only low and high frequencies are of interest. For passively working transponder systems usually only the magnetic component is used to transfer energy and data. Once constructed, those antennas can be very small. A transfer via electric components would be very inefficient over such a distance. Antennas for magnetic transfer consist of a coil. There, two different types of concepts can be distinguished: air coils and ferrite coils. The advantage of air coils is that they can also easily be realised with bigger cross sections surfaces. Ferrite coils, on the other hand, show high inductance results on relatively small space. Moreover, there is a loss of ferrite material depending on the frequency.

### 2.3 Regulations for the Emission of Magnetic Fields

The EN regulation 300 330 specifies a maximum strength which is allowed to be created by a device within 10 metres. The exact strength in immediate proximity of the device is not given.

For the dimensioning of reader device antennas it has to be noted that the maximum allowed field strength should not be exceeded but at the same time there has to be enough strength for the transponder. Important parameters that define the strength are the amplitude of voltage over antennas and their geometry. Figure 2 shows a small part of this norm.

Frequency range (MHz)	H-field strength limit (H <sub>f</sub> ) dBμA/m at 10 m
0,009 ≤ f < 0,315	30
0,009 ≤ f < 0,03	72 or according to note 1
0,03 ≤ f < 0,05975 0,06025 ≤ f < 0,07 0,119 ≤ f < 0,135	72 at 0,03 MHz descending 3 dB/oct or according to note 1
0,05975 ≤ f < 0,06025 0,07 ≤ f < 0,119 0,135 ≤ f < 0,140	42
0,140 ≤ f < 0,1485	37,7
0,1485 ≤ f < 30	-5 (see note 4)
0,315 ≤ f < 0,600	-5
3,155 ≤ f < 3,400	13,5
7,400 ≤ f < 8,800	9
10,2 ≤ f < 11,00	9
6,765 ≤ f ≤ 6,795 13,553 ≤ f ≤ 13,567 26,957 ≤ f ≤ 27,283	42 (see note 3)
13,553 ≤ f ≤ 13,567	60 (see notes 2 and 3)

NOTE 1: For the frequency ranges 9 to 70 kHz and 119 to 135 kHz, the following additional restrictions apply to limits above 42 dBμA/m:

- for loop coil antennas with an area ≥ 0,16 m<sup>2</sup> table 4 applies directly;
- for loop coil antennas with an area between 0,05 m<sup>2</sup> and 0,16 m<sup>2</sup> table 4 applies with a correction factor. The limit is: table value + 10 × log (area/0,16 m<sup>2</sup>);
- for loop coil antennas with an area < 0,05 m<sup>2</sup> the limit is 10 dB below table 4.

NOTE 2: For RFID and EAS applications only.

NOTE 3: Spectrum mask limit, see annex G.

NOTE 4: For further information see annex H.

Fig. 2. Limitation of field strength at 10 m meeting EN 300 330

The maximum allowed strength at 10 m is different for every frequency. For example, at 133 KHz there is a strength of 66 dBμA/m allowed. At 6.78 MHz 42 dBμA/m are valid and at 13.56 MHz, 60 dBμA/m. Figure 3 shows a summary of the existing frequency bands. Shaded bars show frequencies for the use in industrial and medical applications (ISM).

### 3. Analysis of Power Absorption in Human Body

In order to operate the passive implant, a transfer of energy from the reading device is necessary. This shall be realised wire-free through the human body directly to the implant. For this, distances of up to half a metre have to be covered within the human tissue. Losses are a normal part of the process. Part of the energy is changed into heat in the body. The aim is to keep losses small in order to enable an ideal energy transfer to a passive transponder. Apart from undesired warming of tissues which, from a medical perspective, could be dangerous, it is also necessary to keep losses small in view of the whole system. Bigger losses would lead

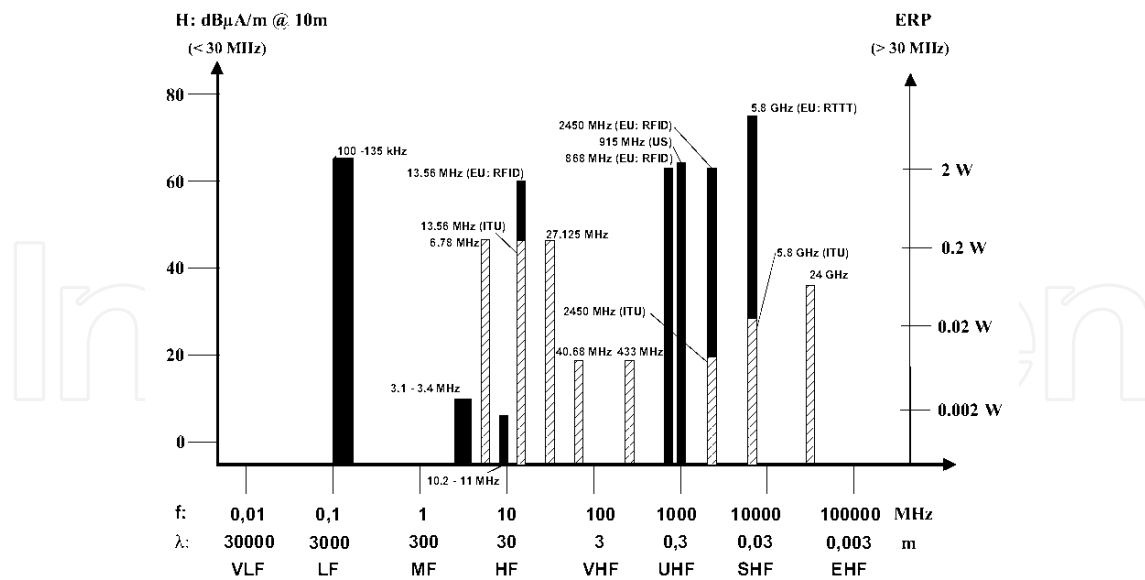

Fig. 3. Frequency areas [4]

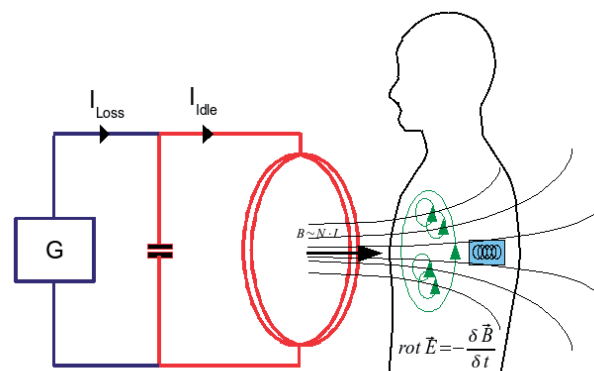

Fig. 4. Induced eddy current caused by magnetic field changing in time

to a reduction of coverage and thus eventually make the system useless for its application. To minimise losses, it is necessary to find frequencies at which the transfer is at its peak.

The antenna coil of a reading device creates an alternating magnetic field. A small part of the magnetic flow which is produced goes through the coil of the transponder. As a consequence there is an induction of voltage in the coil. With the help of this voltage the electronic circuits are operated. If the medium surrounding and in between the coils is not conductive, energy transformation cannot take place in this medium. Only a small part of the energy provided by the generator is used to supply the transponder. A big part is transformed into heat in the antennas and is lost.

When non-magnetic conductive material lies between the antenna coil of the reading device and the transponder, it is permeated by a magnetic flow. Each alternating magnetic field with electricity-conductive material results in electric eddies if it is set vertical to the direction of the magnetic field. These are electric fields which are adjusted to circular paths. They can be

described with the 2nd Maxwell equation.

$$\operatorname{rot} \vec{E} = -\frac{d\vec{B}}{dt} \quad (1)$$

The exact electric field strength depends on temporal change of the magnetic flow. The rotation mathematically describes the development of eddies. Each electric field, which exists in conductive materials, results in current density  $J$ .

$$\vec{J} = \kappa \vec{E} \quad (2)$$

The current flow now takes place along circuit paths. This is why it is also called eddy current. This current flow now also results in an alternating magnetic field. The orientation of the field is opposed to that of the reading device. This leads to a partial loss. Thus, one could say that magnetic fields can permeate through the material without any problems but interfere with another field, which then ultimately leads to a destructive heterodyne. The magnetic field strength at the transponder is thus weakened by eddy currents. Less voltage is induced in the antenna of the transponder. This is why the transponder has less energy at its disposal.

A big part of the energy in conductive materials is transformed into heat. The power dissipation can be described as follows:

$$P = \frac{1}{2} \int_V \frac{\|J^2\|}{\sigma} dV \quad (3)$$

The heat capacity is dependent on the conductivity of the material and its volume. In order to specify losses in the human body very precisely, both conductivity as well as the volume of each tissue, which lies between reading device and implant, has to be known. In the following chapters the conductivity of human tissues is discussed. Afterwards, the losses with various frequencies are assessed.

### 3.1 Characterisation of Human Tissue

Human tissue does not have magnetic properties. The permeability of tissues is tantamount to that of a vacuum. This means that a magnetic field is not directly influenced by it. However, if it is an alternating magnetic field, electrically induced eddy currents have an impact on it. The following chapter thus concentrates on dielectric properties of tissues.

The human body is an inhomogeneous medium. It consists of different types of tissues and liquids. These are, among others, skin, muscles, fat, blood or organs such as lung, liver or heart. Each of these tissues and liquids shows different dielectric properties. Furthermore, these properties also vary in frequency.

In a simplified view, molecules of heterogeneous materials, such as water, can be treated as electric dipoles. If a magnetic field is applied from the outside, they adjust to this field. This process is called dipole polarisation. The impact of the field of adjusted dipoles on the field strength as a whole is expressed with the dielectric constant  $\epsilon$ . The resulting electric field strength is called electric induction density.

$$\vec{D} = \epsilon \vec{E} \quad (4)$$

With temporal-variant electric fields, the adjustment is only reached after a certain period of time. This time is described with the constant  $\tau$  in mathematics. It is also referred to as relaxation time. In a sinusoidal alternating field this relaxation effect is shown by a distortion



of phase between electric induction density and the electric field. This can be expressed with a complex permittivity.

$$\varepsilon = |\varepsilon| \cdot e^{j\delta} = \varepsilon' + j\varepsilon'' \quad (5)$$

If the frequencies are low, dipoles can follow the constructed field. For higher frequencies the re-orientation of dipoles is slowed down and the differences between the phases become bigger. This is shown in the course of real- and imaginary parts via the frequency. Figure 5 shows the distribution qualitatively.  $\varepsilon'_{r0}$  sets the permittivity at frequency zero. The imaginary

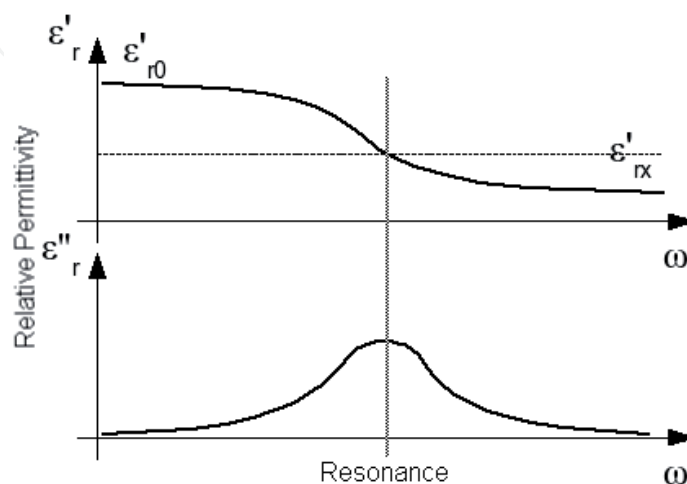

Fig. 5. Real and imaginary part of complex permittivity

part is distinguished from zero as soon as the real part is changing over the frequency. If the imaginary part increases, the phase difference between the outer field and the resulting induction density increases as well. In this case energy is transformed into heat. Thus, if the imaginary part is at its maximum size, the loss is at its maximum, too. In order to specify losses, the electric conductance is needed. The relation between permittivity and conductivity can be derived from Maxwell's equation.

$$\vec{J} = (j\omega\varepsilon + \sigma) \vec{E} \quad (6)$$

After including permittivity in a complex form, conductivity can be divided into real and imaginary parts.

$$\vec{J} = j\omega(\varepsilon' - j\varepsilon'') \vec{E} + \sigma \vec{E} \quad (7)$$

$$= (\sigma + \omega\varepsilon'') \vec{E} + j\omega\varepsilon' \vec{E} \quad (8)$$

$$\text{Real} : \sigma' = \sigma_{stat} + \omega\varepsilon'' \quad (9)$$

$$\text{Imaginary} : \sigma'' = \omega\varepsilon' \quad (10)$$

The real part, which is also called effective conductance value, can be used to characterise losses in conductive materials. The conductivity for low frequencies is tantamount to the

static part  $\sigma_{stat}$ . For higher frequencies, imaginary permittivity exceeds. Thus, if the spectrum of a material's complex permittivity is known, the complex conductance can be determined. Together with geometry, losses for each frequency can be calculated.

Human tissues are heterogeneous materials. A variety of relaxation times exists. For the mathematical description of permittivity, in contrast to water for instance, higher terms are necessary. The frequency behaviour can be foretold with the help of the so-called Cole-Cole equation. This equation is based on the mathematical description of the above described model (1).

$$\hat{\epsilon}(\omega) = \epsilon_{inv} + \sum_n \frac{\Delta\epsilon_n}{1 + (j\omega\tau_n)^{(1-\alpha_n)}} + \frac{\sigma_i}{j\omega\epsilon_0} \quad (11)$$

$\sigma_i$  is the static conductivity and  $\epsilon_0$  the permittivity of the vacuum.  $\tau$  describes the relaxation time. Further concrete parameters for  $n=1..4$  can be seen in (1). Parameters for all tissues, which are of interest here, are available, for instance for fat, heart tissue, lung, muscles and skin. Through the evaluation of this equation, dielectric properties of all interesting frequencies can be measured.

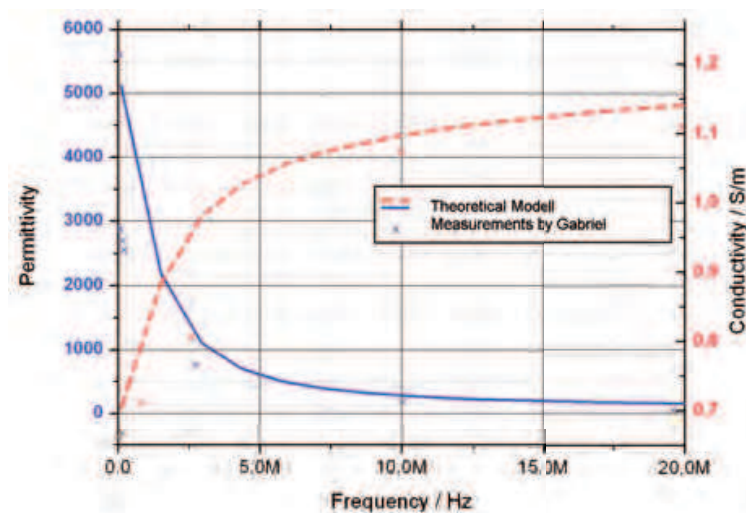

Fig. 6. Permittivity and conductivity of blood

Figure 6 exemplifies the properties of blood. The normal line shows the distribution of permittivity and the dotted line the distribution of conductivity for certain frequencies. Dielectric properties of human tissue were first characterised through an experiment carried out by (1). The crosses mark the measurement values investigated by Gabriel. Data are available for a frequency of 10 Hz to 20 GHz.

The conductance value includes both the static conductance value as well as the above described frequency-dependent value. First, the conductance value is important as the absorption of the field created by the reading device increases with increasing conductivity. According to figure 6 it can be expected that the absorbability in the frequency area shown increases with increasing frequency. This will be analytically evaluated in the next chapter.

### 3.2 Analytical Estimation of Power Absorption

In order to estimate losses for different frequencies, an analytical calculation has to be carried out. For this, a simplified model of the human body is constructed. Afterwards the power



absorption which is transformed into heat is calculated for different frequencies. In order to classify the impact of energy transfer to the transponder, the available energy is set in relation to transfer in air in a FDTD simulation.

### 3.2.1 Simplified Body Model

If a transponder is directly attached to the heart and the reading device on the chest of a patient, there is more than one type of tissue between the antennas. Table 1 shows a list of tissues and their conductance values. In order to calculate the losses, the volume of each tissue, their conductance values and the distribution of current density induced have to be taken into consideration. However, here the aim is to have a simplified estimation, this is why a homogeneous model of the body is used in the following. It only contains one conductance value and consists of a simple geometry. For a “worst case scenario” conductance values of blood can be used because it has the highest conductivity in comparison to other types of tissues. For a second calculation an average conductance value is used. For the analytic calculation of induced eddy currents in bodies, a cylinder is especially useful because of its simple geometric form. Thus, a cylinder is assumed which has a field-creating coil at its front surface. The length is chosen so that the transponder is included and the distance to the field-creating coil is approximately 50cm. The diameter can be chosen accordingly. Figure 7 shows the model.

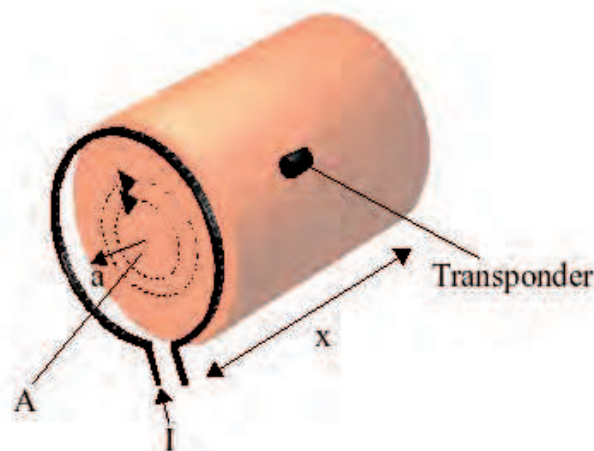

Fig. 7. Modell for estimation of power absorption

A length of  $l = 80$  cm and a radius of  $a = 15$  cm were chosen.

### 3.2.2 Estimation of Power Loss

As described at the beginning, an alternating magnetic field, which occurs within a conductive medium, induces eddy currents. These ultimately lead to heating the medium. The heat capacity which is transformed in a cylinder - figure 7 - needs to be estimated. The heat capacity can be assessed as follows (3):

$$W = \frac{1}{2} f \mu H^2 A x K(a/p) \quad , \text{with} \quad (12)$$

$$K(a/p) = \frac{\text{ber}(\sqrt{2\frac{a}{p}})\text{ber}'(\sqrt{2\frac{a}{p}}) + \text{bei}(\sqrt{2\frac{a}{p}})\text{bei}'(\sqrt{2\frac{a}{p}})}{\text{ber}^2(\sqrt{2\frac{a}{p}}) + \text{bei}^2(\sqrt{2\frac{a}{p}})} \sqrt{2\frac{a}{p}} \quad (13)$$

-  $H$  is the magnetic field strength on the axis of the cylinder,  $\mu$  is the permittivity,  $\sigma$  the conductance value,  $x$  the length of the cylinder and  $K$  a correction factor. The correction factor  $K$  describes the inhomogeneous distribution of current density and depends on the radius of the cylinder and penetration of the skin. The magnetic field within the cylinder is not homogeneous. Furthermore, the current density of eddy currents over the radius is not homogeneous due to energy-displacement effects.

The magnetic field strength  $H$  decreases with increasing distance  $x$  to the field-creating coil. This can be described with the Biot-Savart law.

$$H(x) = I \cdot \frac{a^2}{2(x^2 + a^2)^{\frac{3}{2}}} \quad (14)$$

Here,  $I$  is the intensity of current through the field-creating conductor loop. For an infinitely small part of the cylinder parts of the heating capacity can be described as

$$dW = \frac{1}{2} f \mu A K(a/p) \cdot I^2 \cdot \frac{x \cdot a^4}{4(x^2 + a^2)^{\frac{6}{2}}} dx \quad (15)$$

For a homogeneous cylinder model the heating capacity through integration over the whole length is:

$$\int_0^l \frac{1}{2} f \mu A K(a/p) \cdot I^2 \cdot \frac{x \cdot a^4}{4(x^2 + a^2)^{\frac{6}{2}}} dx \quad (16)$$

With the conductivity of blood and heart the following results could be achieved. The conductivity of heart was chosen, because it has conductivity values near to the mean value of all tissues.

Frequency	133 kHz	3 MHz	6,78 MHz	13,56 MHz	27 MHz	40 MHz
Blood	2.27 $\mu W$	1.17 mW	4.55 mW	9.99 mW	17.91 mW	40.34 mW
Heart	1.80 $\mu W$	0.53 mW	2.81 mW	9.06 mW	19.75 mW	26.38 mW

In comparison, the electronics of the transponder consumes  $90 \mu W$ . The volume of the cylinder in which the heat capacity is transformed is about  $56,5 dm^3$ . The resulting heat capacity per unit volume is about  $80 nW$ . This value is quite safe for medical accounting purposes. In order to analyse the influence to the transponder-system, it is necessary to see the energy, which the transponder has at its disposal, in relation to a transfer via air. This is how the impact of absorption of the human body is visible.

### 3.3 Estimation by FDTD Method

In order to be able to analyse the frequency response in more detail and assess the strength of energy reduction of the transponder, a 3D field simulation was carried out. With a software it is possible to calculate the components of electric and magnetic fields. Furthermore, currents and voltage can be detected. The software is based on the FDTD (Finite Differences Time Domain) method which is based on the rough discretization of Maxwell's equations. A simple 3D model of the human body was constructed which contains all types of tissues that can be found between a reading device and the transponder. In the following this model will be called "inhomogeneous model". For each type of tissue the corresponding permittivity and conductance values were typed in (cf. table 1). In order to make the simulation more realistic, information about the volume of the tissues were extracted from a 2D MRT cross section. Figure 8 shows this process.

Tissue/Freq.	133 KHz	3 MHz	6.78 MHz	13.56 MHz	27 MHz	40 MHz
Skin	0.085347	0.06314	0.14712	0.23802	0.42748	0.45401
Fat	0.024484	0.02595	0.027775	0.030354	0.032909	0.03409
Muscle	0.36889	0.56805	0.6021	0.62818	0.654	0.6692
Lung	0.27613	0.3855	0.42109	0.45158	0.48429	0.50462
Bone	0.084146	0.10256	0.11585	0.12845	0.14185	0.15009
Heart	0.22405	0.41127	0.47134	0.52617	0.58769	0.62687
Blood	0.70494	0.98268	1.0673	1.117	1.158	1.1801

Table 1. Conductivities in S/m of different tissues at different frequencies (2)

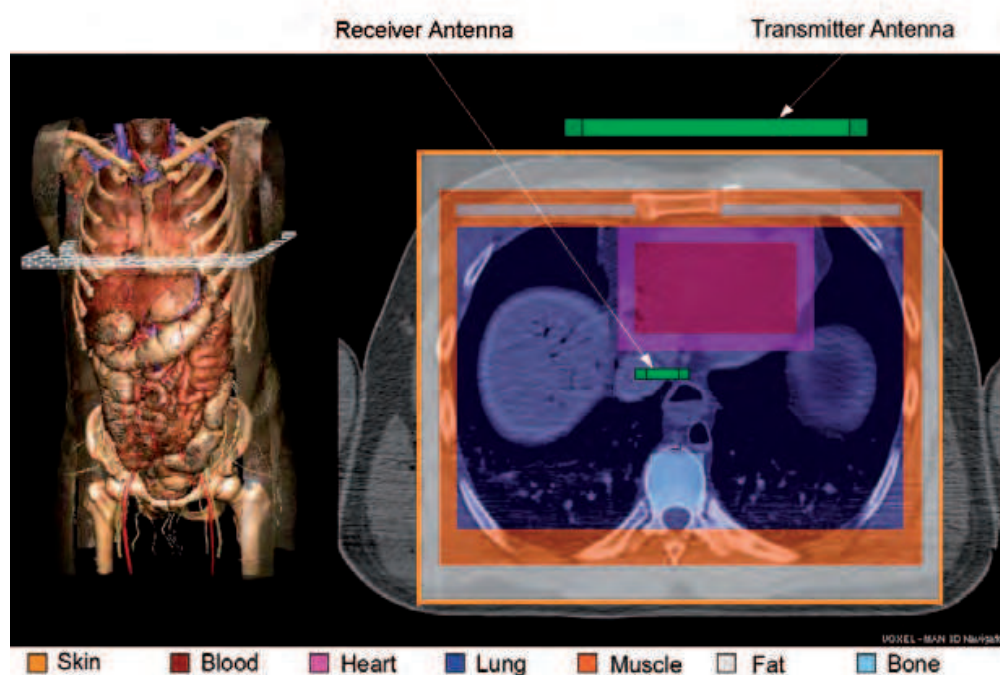

Fig. 8. Approximation der Volumen-Information (MRT-picture: Deutsches Röntgen-Museum)

A cross section of the human body at the level of the heart can be seen. In order to create a field and measure the strength close to the transponder, two types of antenna were used. With this simulation absorption and frequency behaviour can be analysed quickly.

In order to assess the absorption strength of the human body, it is necessary to eliminate factors from the antenna which might have an impact. For this matter, a type of reference simulation was carried out. In this simulation the human body was replaced with air. The measured voltage values at the transponder antenna will then be offset with the results of following simulations.

Simulations with a further model were used to assess absorption effects realistically. In the following this model is referred to as "homogeneous model". It reflects a worst-case scenario. For this purpose dielectric parameters of blood were used for all tissues since blood has a higher conductivity than other tissues.

In order to extract information about frequency-dependent absorption from the results of the three simulations, quotients were made from conductance values of the homogeneous model and the inhomogeneous model based on the reference model.

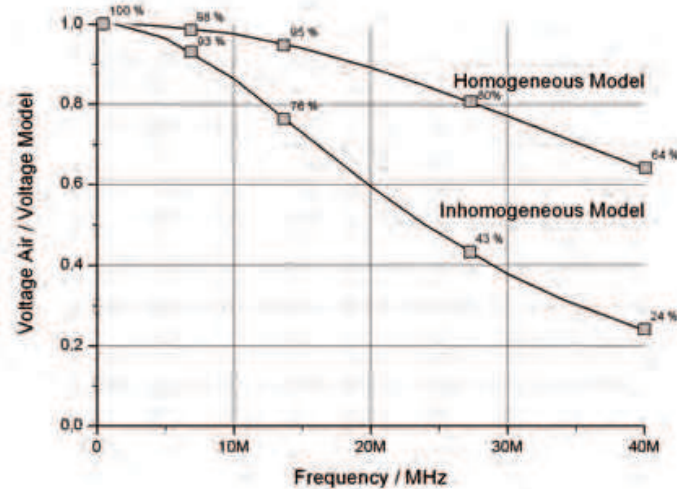

Fig. 9. Frequency depending attenuation

Figure 9 shows the voltage which can be induced in the transponder in comparison to a transfer via air. If there is only air in the transfer system, the quotient is one for all considered frequencies. First, it is clearly visible that the absorption capacity generally increases with higher frequencies and thus induced voltage decreases. For a frequency of 40 MHz the voltage decreases to 24 and 64 per cent respectively in the homogeneous model. In a low-frequency area, on the other hand, absorption is hardly detectable. However, which frequency is best for transferring a maximum of energy does not only depend on the absorption but also on further characteristics of the transmission. According to the induction-law, for instance, the induced voltage stands in proportion to frequency. Thus, it can be expected that there is a frequency at which the induced voltage is at its maximum. Furthermore, the characteristics of the antennas used have to be analysed. The following chapters deal with this topic. In chapter 4.2 the ideal frequency will be established with regard to all findings.

#### 4. Example of Energy Transmission in a Sensor Transponder System

##### 4.1 Frequency Behaviour of Induced Voltage at the Transponder

The voltage induced in the transponder coil is used to provide the power supply to the transponder electronic. To improve the efficiency, a parallel resonant circuit is formed by an additional capacitor connected in parallel with the transponder coil. Figure 10 shows the equivalent circuit of the transponder.

The resistor  $R_i$  represents the natural resistance of the transponder coil  $L_1$  and the current consumption of the transponder electronic is represented by the load resistor  $R_L$ . If a voltage  $U_i$  is induced in the coil  $L_1$ , the voltage  $U_l$  can be measured at the load resistor  $R_L$ . It is a result of the voltage  $U_i$  minus the current  $i$  multiplied with the coil impedance and  $R_i$ . The so called quality factor represents the relationship between the induced voltage at  $L_1$  and the voltage at the transponder electronic. A higher quality factor causes a higher voltage  $u_l$  and a higher

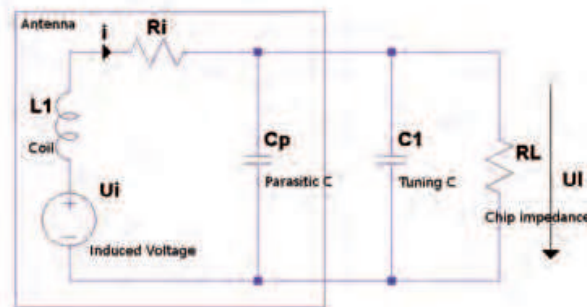

Fig. 10. Equivalent Circuit of a Transponder

maximum possible distance between reader and transponder. It can be calculated with the following formula relating to the equivalent circuit (4):

$$Q = \frac{1}{\frac{R_i}{\omega L_1} + \frac{\omega L_1}{R_L}} \quad (17)$$

By analysis of this formula it can be seen, that for every pair of  $R_i$  and  $R_L$  there is a  $L_1$  at which the quality factor is at its maximum. And this maximum value of the quality factor is different for every frequency. So if the optimal  $L_1$  is calculated for every frequency, the maximum possible quality factor versus frequency could be calculated.

#### 4.2 Optimal Frequency

The induced voltage  $U_i$  is reduced by the loss effects described in chapter 4.1. Because  $U_i$  is proportional to the quality factor, it is allowed to multiply the quality factor calculated with 17 together with the results of the graph's in figure 9. Figure 11 shows the evaluation of equation ?? considering the effects described before.

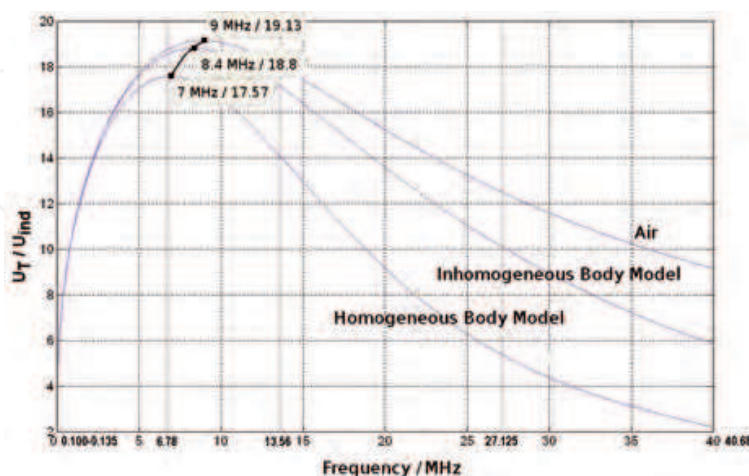

Fig. 11. Influence of the human tissue to the optimum frequency

First of all, a great difference in inducible voltages between LF and HF frequencies can be seen. For low frequencies, the quality factor is much smaller than for the HF case. The simu-



lation shows a maximum quality factor for all simulations between 7 MHz and 9 MHz. If the coils are surrounded by air, there will be an optimal frequency of about 9 MHz. This optimal frequency becomes lower, when human tissue is between the coils. For the homogeneous model, in worst case, an optimal frequency is about 7 MHz. In the inhomogeneous model, that is more realistic, the highest quality factor could be obtained with 8.4 MHz. It can be said, that the human tissue reduces the optimal frequency value, at which the most voltage can be induced respectively the highest transmission range could be achieved. The optimal frequency can be observed near to the 6,78 MHz ISM band. In comparison to LF ISM Band the amount of induced voltage is about 4 times higher. In comparison to 13.56 MHz a power of maximum 20 % less is necessary to get the same transmission range.

#### 4.2.1 Practical Measurement

An experimental measurement shall determine the maximum achievable distance. For this experiment, a circular coil with a single winding and an aperture of 26 cm was used to produce the magnetic field. A frequency of 13,56 MHz was chosen. A test transponder was developed to measure the energy that can be provided to an implanted transponder. It consists of a ferrite rod coil, an HF front-end and a load resistor that simulates the impedance of a transponder circuit. To create a substitute that simulates the electric properties of the human body, a phantom substance was prepared following a recipe described in [2]. The main goal of the experiment is to measure the voltage induced at the transponder coil when it is placed inside this substance at different distances from the reader coil. 50 L of the phantom substance is obtained. It was placed in a container large enough to allow the transponder to be placed in a similar position as in a human body. Following the specifications in the article, the container should be made of an electrical insulator and non-magnetic material. In our case, the container has a cylindrical form, which is sufficiently similar to a human body. Another requirement is a minimum volume of substance. It is specified that a mass of at least 30 kg of phantom material is necessary. Generally, a homogeneous phantom is accurate enough to simulate a human body, in this way it is not necessary to incorporate materials of different conductivity inside the container. Figure 12 (a) shows the measurement setup.

With this measurement it is possible to determine in how much surrounding tissue a transponder can work. To measure the provided energy for different distances from the reader, the voltage at the load resistor in the test-transponder was measured versus the distance. The chip used in sensor transponders usually works with voltages greater than 3 V. Therefore, the transponder would be provided with enough energy at a distance where the voltage is still higher than this voltage. Figure 12 (b) shows the measurement results.

The measurement was done with a voltage amplitude at the reader coil of 300 V and a load resistor in the test transponder of 60 kOhm and 100 kOhm. These values were chosen empirically. The diagram shows the voltage that would be available for a chip in different distances. The voltage is greater than 3 V for distances up to 43 cm.

The experimental measurement shows, that a sensor transponder can work inside a human tissue up to a distance of 40 cm.

## 5. Conclusion

The influence by the human tissue on the inductive energy transmission was considered for the design of a sensor transponder system. For the given constraints to the transponder antenna an optimal frequency could be found. The loss effects decrease this optimum frequency.





(a) Measurement setup

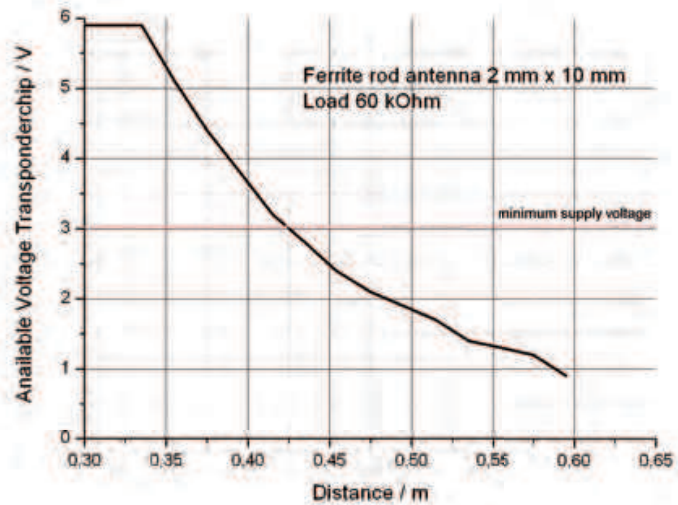

(b) Results

Fig. 12. Practical measurement

A carrier frequency around 6,78 MHz is an optimal choice for our constraints. Measurements have determined the achievable transmission distance through human body.

## 6. References

- [1] S Gabriel, R W Lau und C Gabriel; The dielectric properties of biological tissue; Phys. Med. Biol. 41 (1996) PP 2271-2293
- [2] IFAC ;Dielectric Properties of Body Tissues in the frequency range 10 Hz - 100 GHz; <http://niremf.ifac.cnr.it>
- [3] A. V. Vorst, A. Rosen, Y. Kotsuka; RF/Microwave Interaction with biological Tissues; John Wiley & Sons Inc.; Canada USA; 2006
- [4] Klaus Finkenzeller; RFID-Handbook; Hanser; München Wien; 2006
- [5] A. Hennig; RF Energy Transmission for Sensor Transponders Deeply Implanted in Human Bodies; EmuW IEEE 2008

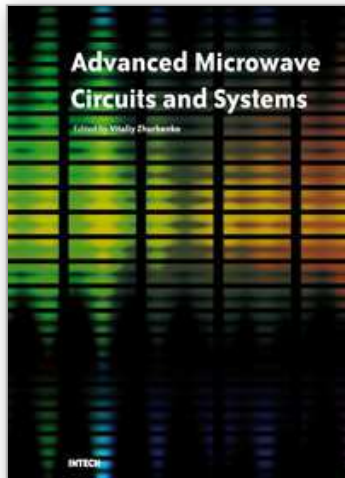

## **Advanced Microwave Circuits and Systems**

Edited by Vitaliy Zhurbenko

ISBN 978-953-307-087-2

Hard cover, 490 pages

**Publisher** InTech

**Published online** 01, April, 2010

**Published in print edition** April, 2010

This book is based on recent research work conducted by the authors dealing with the design and development of active and passive microwave components, integrated circuits and systems. It is divided into seven parts. In the first part comprising the first two chapters, alternative concepts and equations for multiport network analysis and characterization are provided. A thru-only de-embedding technique for accurate on-wafer characterization is introduced. The second part of the book corresponds to the analysis and design of ultra-wideband low-noise amplifiers (LNA).

### **How to reference**

In order to correctly reference this scholarly work, feel free to copy and paste the following:

Andreas Hennig and Gerd vom Bogel (2010). Analysis of Power Absorption by Human Tissue in Deeply Implantable Medical Sensor Transponders, *Advanced Microwave Circuits and Systems*, Vitaliy Zhurbenko (Ed.), ISBN: 978-953-307-087-2, InTech, Available from: <http://www.intechopen.com/books/advanced-microwave-circuits-and-systems/analysis-of-power-absorption-by-human-tissue-in-deeply-implantable-medical-sensor-transponders>

# **INTECH**

open science | open minds

### **InTech Europe**

University Campus STeP Ri  
Slavka Krautzeka 83/A  
51000 Rijeka, Croatia  
Phone: +385 (51) 770 447  
Fax: +385 (51) 686 166  
[www.intechopen.com](http://www.intechopen.com)

### **InTech China**

Unit 405, Office Block, Hotel Equatorial Shanghai  
No.65, Yan An Road (West), Shanghai, 200040, China  
中国上海市延安西路65号上海国际贵都大饭店办公楼405单元  
Phone: +86-21-62489820  
Fax: +86-21-62489821

© 2010 The Author(s). Licensee IntechOpen. This chapter is distributed under the terms of the [Creative Commons Attribution-NonCommercial-ShareAlike-3.0 License](#), which permits use, distribution and reproduction for non-commercial purposes, provided the original is properly cited and derivative works building on this content are distributed under the same license.

IntechOpen

IntechOpen