

# We are IntechOpen, the world's leading publisher of Open Access books Built by scientists, for scientists

**4,800**

Open access books available

**122,000**

International authors and editors

**135M**

Downloads

Our authors are among the

**154**

Countries delivered to

**TOP 1%**

most cited scientists

**12.2%**

Contributors from top 500 universities



**WEB OF SCIENCE™**

Selection of our books indexed in the Book Citation Index  
in Web of Science™ Core Collection (BKCI)

Interested in publishing with us?  
Contact [book.department@intechopen.com](mailto:book.department@intechopen.com)

Numbers displayed above are based on latest data collected.

For more information visit [www.intechopen.com](http://www.intechopen.com)



# A Simulation Study on Balance Maintenance Strategies during Walking

Yu Ikemoto, Wenwei Yu and Jun Inoue  
Chiba University  
Japan

## 1. Introduction

Recently, walking assist systems, such as robotic systems (Kawamoto et al., 2003) and functional electrical stimulation (FES) for hemiplegic walking (Yu et al., 2002; Bajd et al., 1997; Tong et al., 1998), have been widely studied for the purpose of improving activities of daily living (ADL) for paralyzed individuals. However, most systems were unable to address the perturbations resulting from uneven terrain, slips, slopes and obstacles, which frequently occur in daily-life walking; as they have not taken these perturbations into consideration, they are not yet suitable for practical use in real-life situations.

However, it is evident that humans can cope with such perturbations, especially when they cannot be predicted or perceived in advance, by means of reflexes (Zehr and Stein, 1999), which cause relatively fixed, unconscious muscular response patterns to perturbations within a short period of time ranging from several tens of ms to 200 ms.

Our ultimate goal is to realize artificial reflexes in real-world walking support systems for paralyzed individuals, whose afferent and efferent neural pathways are usually weakened, so that the reflexive system is also impaired to a certain degree. This goal requires both a qualitative and quantitative understanding of human reflexive mechanisms during walking. Reflexes of different functional organs and limbs (e.g., upper limbs (Cathers et al., 2004), hearts (Nakamura et al., 1992), and lower limbs (Zehr and Stein, 1999)), in different contexts (e.g., during flexion/extension (Cathers et al., 2004), during free fall (Bisdorff et al., 1999), and during walking (Zehr and Stein, 1999)) have been studied in the fields of kinesiology and neuroscience. It has also been shown that the flexor reflexes play an important role in locomotion, and these reflexes were implemented in several commercially available FES systems (Quintern, 2000).

Although the reflexive responses to perturbation during walking have been an object of study for quite some time (Zehr and Stein, 1999; Berger et al. 1984; Dietz et al. 1987), most studies were concerned with muscle activity recording and data analysis, through which several working hypotheses were generated. For example, electroneurograms (ENG) of high-spinal curarized cats were recorded and analyzed to show that the stimulation of flexor reflex afferents could induce a clear resetting of the locomotion rhythm (Schomburg et al., 1998). However, it is almost impossible to test this hypothesis using the same methods in humans.

Thus, the spatio-temporal relation among neuro-control mechanisms, muscle activities and physical motions remains unknown. Moreover, there is no widely accepted theory on the underlying neural mechanisms of the reflexes during walking, nor are there clear experimental results that could be directly referenced in the disciplines of physiology and motor control. However, neuro-control-level understanding and verification are necessary to artificially realize the reflexes to perturbation during walking.

Our basic hypothesis is that if the muscle activity profile of the reflexive responses to perturbation during walking can be acquired via non-invasive measurement, and if a neuromusculoskeletal walking simulation model able to present conformable behavior to human normal walking could be developed, albeit without the reflexive mechanism pre-wired (as they are still unknown), parts of the candidates for the underlying neural mechanisms can be clarified by investigating which candidate can match the measured muscle activity profile.

In our previous study (Yu et al, 2007), we investigated reflexive responses during walking through the following methods:

- 1) Acquiring muscle activity profiles during normal walking and slip-perturbed walking by recording and processing electromyographic (EMG) signals of several walking-related muscles in a human gait experiment.
- 2) Developing a central pattern generator (CPG)-based neuromusculoskeletal simulation model. Computer simulation has been employed as an approach to study the role of afferent information during human (Taga, 1994) and animal walking (Prochazka et al., 2001). In an animal study, virtual reflexes were realized by a set of if-then rules, and the gait of cat walking with and without the virtual reflexes were compared. The results showed that walking with virtual reflexes was more stable and perturbation-resistive. However, there are few studies employing a hybrid approach coupling human walking simulation with human gait experiment data.
- 3) Comparing joint trajectories of the simulation model with those of a human subject during normal walking to verify the simulation model's conformity with human walking.
- 4) Using muscle activity profiles of reflexive responses (defined as muscular-reflexive-patterns in the present study) extracted from EMG data recorded for slip-perturbed walking in the human gait experiment to construct a rapid responding pathway.

The results indicated that the simulation model could display behavior resembling that of normal human walking, and, on the occurrence of a slip-perturbation, together with the CPG-phase-modulation, the rapid muscular response could improve perturbation-resistance and maintain balance for the simulated walker.

Although these results were quite encouraging, the roles of different reflexive mechanisms have not yet been quantitatively clarified. However, understanding the roles of these functional mechanisms is not only important from the viewpoint of assistive engineering, but also for possible scientific insights into the field of motor control.

In the present study, we focused on the different roles of the reflexive muscle responses and the CPG-phase-modulation mechanism. By using the human walking simulator developed in our previous study, a series of simulation experiments were performed to investigate the roles in perturbation-resistance played by two functional mechanisms, i.e., muscular-reflexive-patterns and CPG-phase-modulation strategies, as well as the afferent feedback pre-wired in human walking models. Qualitative evaluation was performed to compare the different functional mechanisms.

For the quantitative evaluation, we used two stability criteria. One is the *Energy Stability Margin* (MESSURI et al. 1985), which is used to evaluate static postures. However, human walking and balance recovery are apparently dynamic processes, and a static stability criterion may not correctly reflect the essence of these functions. Thus, we proposed "*Energy Difference*", calculated from the rotational energy of lower limbs, to evaluate the dynamic aspect of stability.

Besides, in order to study another strategy, we tried spastic hemiplegic gait's simulation, that is one of hemiplegic gait. It suggests that spastic hemiplegic gait's simulation can consist of pes equinus and a compensated walk, and our simulated reflexive mechanisms could also improve the perturbation resistance for the spastic walking model.

## 2. Materials and Methods

### 2.1. Muscular Reflexive responses

The muscle activity profiles of reflexive responses can be extracted from EMG data recorded from slip-perturbed walking in previous human gait experiments (Cathers et al., 2004; Yu et al., 2007).

The difference between muscular activities during normal walking and perturbed walking was compared to a threshold to determine the onset of reflex responses. The threshold was defined using the mean and standard deviation of the first 2.5 s of data from the subtracted activity profile, i.e., the point at which the amplitude goes beyond  $\text{mean} \pm 3 \text{ SD}$  was considered the onset time. Additionally, for EMG recordings, the data after 2.54 s would be scanned for the onset determination. The 0.04-s gap was set according to the shortest muscle latency possible for reflex responses (Nakamura et al., 1992).

The latency data was further processed to extract muscular reflexive responses. It is noted that effective latency could not be detected for all muscles and all subjects. Thus, only the muscles for which an effective latency could be detected for more than 5 of 10 trials and more than 7 of 10 subjects were selected as the ones that should be activated during reflexive responses (Table 1). The selected muscles and their averaged latencies were designated the muscular-reflexive-patterns.

Muscles Side	Gluteus Medius	Vastus Lateralis	Semi Tendinosus	Anterior Tibial	Gastroc Nemius
slip side	149(ms)	175 (ms)	178 (ms)	/	/
another side	143(ms)	/	88 (ms)	116 (ms)	176 (ms)

"/" indicates the side on which the muscles do not satisfy the conditions.

Table. 1. Latencies of the selected muscles.

In similar studies (Berger et al., 1984; Dietz et al., 1987), the split-belt treadmill was employed to study the corrective reactions to unpredictable one-sided deceleration and acceleration perturbations during walking. The EMG signals of two muscles, the tibialis anterior (TA) and gastrocnemius (GN), were recorded and analyzed, and our results showed the same temporal activation sequence on the contralateral side for both. That is, TA was activated first, followed by GN. TA was activated at a latency of 65 ms; however, our TA latency was 116 ms. This may have been due to differences in deceleration time; i.e., the

treadmill could realize deceleration within 60 ms, whereas the deceleration time of the split-belt walking machine was 100 ms.

## 2.2. Simulation models

Four simulation models were developed. One was named the *Normal Walker*, which receives a command from the central nervous system and consists of a CPG model, a musculoskeletal model, and a sensory feedback module. The second one was designated the *Normal Walker with Reflex*, having the same basic elements of the *Normal Walker*, but with an additional reflex mechanism modulating the torque output from the CPG model. The third one was designated the *Spastic Walker*, having the same basic elements of the *Normal Walker*, but having pes equinus by biasing its plantarflexor neuron and compensatory actions for balance maintenance. The last one was designated the *Spastic Walker with Reflex*, having the same basic elements of the *Spastic Walker*, but with a same additional reflex mechanism as above.

The followings are the details of the four simulation models.

*Normal Walker*: Fig.1 shows the composition of this simulation model. The CPG was constructed as a set of coupled neural oscillators, each of which is expressed by a set of simultaneous differential equations (Matsuoka, 1985). The simultaneous differential equations are shown in eq.1. Neurons innervating lower limb muscles were mutually coupled so that their oscillations could be entrained to each other; consequently, the skeletal system controlled by the nervous system could display coordinated motion. Fig.2 shows the coupling relations between neurons.

$$\begin{aligned} \tau_n \dot{u}_n &= -u_n + \sum_s w_{ns} f_{\max}(u_s)_n - \beta v_n + z_n + feed, \\ \tau'_n \dot{v}_n &= -v_n + f_{\max}(u_n), \\ f_{\max}(\xi) &= \max(\xi, 0), \end{aligned} \quad (1)$$

where  $u_n$  is the inner state of the  $n$ th neuron,  $f_{\max}$  is the output of the  $n$ th neuron,  $v_n$  is a variable representing the degree of the adaptation or self-inhibition effect of the  $n$ th neuron,  $z_n$  is an external input with a constant rate,  $w$  is the connecting weight between coupled neurons, and  $\tau$  and  $\tau'$  are time constants of the inner state and the adaptation effect, respectively. Neuron output  $f_{\max}(u_n)$  is treated as the torque generated by the modulated muscle. Torques acting on joints were calculated as the differences of antagonistic muscle pairs.

This neural expression has also been widely used in other walking simulations (Taga, 1994; Ogihara et al., 2001). The *feed* in eq.1 can be calculated in eq.2 (Matsuoka, 1985) as

$$\begin{aligned} feed &= A(-X) + B_R hFg_R(-X) + B_L hFg_L(-X) \\ &+ C_R hFg_R + C_L hFg_L + D(-X_d), \end{aligned} \quad (2)$$

where *feed* is a vector consisting of 14 elements corresponding to the feedback to 14 neurons (please refer to Fig. 2 for the neuron settings) and  $X$  is a vector variable expressing the state of the simulated links.  $(X_1, X_2)$ ,  $(X_3, X_4)$ ,  $(X_6, X_7)$ ,  $(X_9, X_{10})$ ,  $(X_{12}, X_{13})$ ,  $(X_{15}, X_{16})$  and  $(X_{18}, X_{19})$  express the positions of the center of gravity of the hip joint, left thigh, right thigh, left lower leg, right lower leg, torso and head, respectively.  $X_5$ ,  $X_8$ ,  $X_{11}$ ,  $X_{14}$  and  $X_{17}$  express the angle of

the left thigh, right thigh, left lower leg, right lower leg and torso, respectively. Correspondingly,  $X_{d5}$ ,  $X_{d8}$ ,  $X_{d11}$ ,  $X_{d14}$  and  $X_{d17}$  stand for the angular velocity of the left thigh, right thigh, left lower leg, right lower leg and torso, respectively.  $hF_{gR}$  and  $hF_{gL}$  are two-value functions, taking a value of 1 during the stance phase and 0 during the swing phase for the right and left sides, respectively.  $A$ ,  $B_R$ ,  $B_L$ ,  $C_R$ ,  $C_L$  and  $D$  are the coefficient matrices. Since *feed* contains pose and angle change information of the simulated links, as well as the reaction forces from the ground to the skeletal system, the interaction between the neuromusculoskeletal system and the external world could be realized. Our simulation model also employed this expression.

The weight and size of the body segments were set as follows. The head was set as a point, with a weight of 4 kgf. The torso, thigh, lower leg and foot were set as rectangles, whose width×height pairs are 0.7×0.05, 0.5×0.05, 0.6×0.05 and 0.25×0.3 m, respectively. Their weights were set as 32, 7, 4 and 1 kgf, respectively. The relative mass ratios of body segments are approximately in agreement with those of actual humans (Nakamura et al., 1992).

The model was developed using MATLAB version 7.0 software (The MathWorks, USA) and Working Model 2D version 7.0 software (MSC Software, USA). They were coupled by DDE (dynamic data exchange) protocol.

The utility of the simulation model is verified by comparing its joint trajectories during walking with those of a human subject.

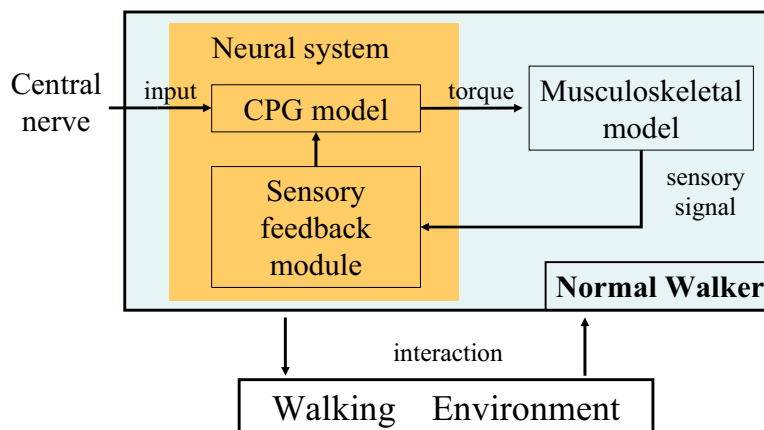

Fig. 1. the composition of *Normal Walker*

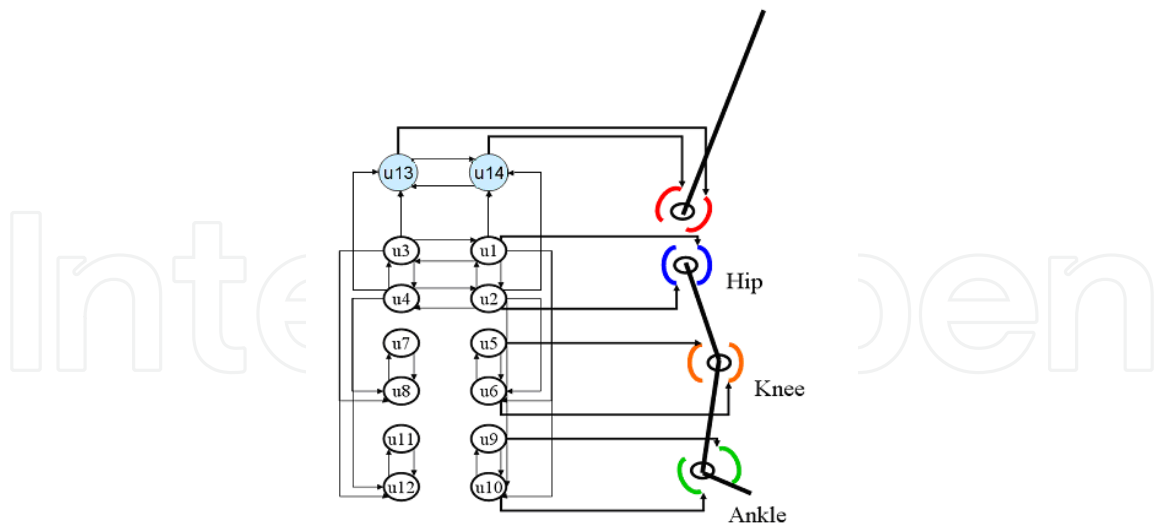

Fig. 2. The neuron-neuron and neuron-link connections

*Normal Walker with Reflex:* Fig.3 shows the composition of this simulation model. In order to realize the reflexive responses in the simulator, the following three points, that is, three aspects of the reflex function, should be determined:

- 1) Spatial aspect: the muscles that should be activated. In this study, this was decided by the muscular-reflexive-patterns described in subsection 2.1.
- 2) Temporal aspect: the onset timing, order of muscle activation, and interval of muscle activation. The triggering problem is addressed in a previous study on perturbation occurrence detection (Hagane et al., 2006) and will not be discussed in this paper. The order of muscle activation was again decided by the results of the measurement experiment. The interval of muscle activation was difficult to estimate from our human gait experiments, so the value is derived by an optimal search of computer simulation experiments. In this study, we used three different intervals (0.02 s, 0.05 s, and 0.09 s) because the human subject could modulate the strength of muscular reflexes suitably according to the strength of perturbation.
- 3) Relation to CPG output: the human walking rhythm is known to show phase-shift or “resetting” in response to external perturbation, and it is believed that such responses correct the perturbed motion and prevent the walker from falling (Yamasaki et al., 2003). Thus, in this study, after muscular reflexive activation, the CPG phase was set to be the same as that before the reflexive activation (CPG-phase-modulation). Fig.4 shows the outline of CPG-phase-modulation. The effective timing of CPG-phase-modulation (reset-time) was derived from a previous computer simulation experiment.

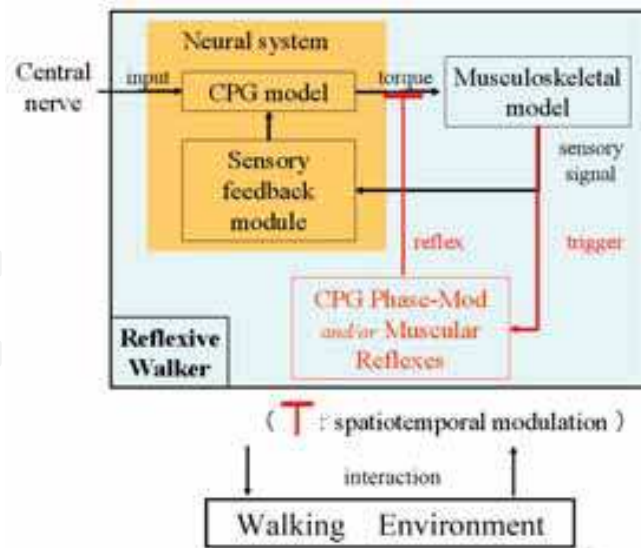

Fig. 3. The composition of *Normal Walker with Reflex*

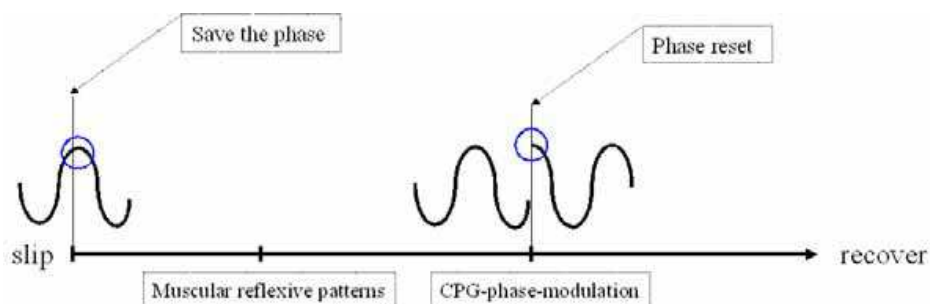

Fig. 4. CPG-phase-modulation

The slip perturbations to the simulated walkers were implemented by setting the friction coefficient to 0 for a period of time from the moment of heel strike. Different slip intervals would be used as parameters to adjust the levels of the perturbations.

If a walker was able to keep walking for 3 steps after perturbation, then its balance recovery was judged to be “successful”. Otherwise, balance recovery was judged as “failed”.

Phase portraits, whose horizontal axis give the angle and vertical axis gives angular velocity, were used to reveal qualitative data regarding the dynamics of the simulated walkers.

*Spastic Walker*: Biasing the output of the plantarflexor neuron ( $u_{10}$  or  $u_{12}$  in Fig. 2) causes pes equinus, and the model stumbles and falls. However it would keep stumbling away with compensatory actions by knee flexor and so on. So we modulated the output of the hip and knee flexors of the swing leg, so that the model could keep its balance. Appropriate parameters were decided by a trial-and-error process.

*Spastic Walker with Reflex*: This model has the same basic elements of the *Spastic Walker*, but also has the reflexive mechanisms explained in *Normal Walker with Reflex* section. Appropriate reflexive parameters were empirically determined. It is not so intuitive to apply the muscle activation profiles of healthy subjects to *Spastic Walker*. However, since the profiles should reflect the fundamental elements of human balance-recovery, also in order to make comparison under the similar condition, the same muscle activation profiles was applied.



### 2.3. Evaluation

Only the recovered/fell evaluation was unable to reflect the difference between the same “fell” or “recovered” cases. With regard to quantitative evaluation, we used two stability criteria.

*Energy Stability Margin*: used to evaluate static postures of a walking machine (MESSURI et al., 1985), and defined as “the potential energy gain by the change of the center of mass on the occurrence of perturbation” (Eq. 3).

$$S = M(h_{\max} - h_0) \quad (3)$$

Where  $M$  is the mass of a walking object,  $h_{\max}$  is the height that a COG is changed to on the occurrence of fall, and  $h_0$  is the current height of the COG.

*Energy Difference*: proposed for the dynamic evaluation of stability during walking, and defined as “the difference of the lower limb’s rotational energy in swing phase between perturbed and normal walking” (Eq. 4).

$$ED = \frac{1}{2} I \omega_{\text{perturbed}}^2 - \frac{1}{2} I \omega_{\text{normal}}^2 \quad (4)$$

where  $I$  is a moment of inertia and  $\omega$  is angular velocity of each lower limb at the time of normal and perturbed walking.

This evaluation method is unfit for *Spastic Walker* and *Spastic Walker with Reflex*, therefore is used only for *Normal Walker* and *Normal Walker with Reflex*.

## 3. Results and Discussion

### 3.1 Muscular reflexive patterns with phase modulation

Table 2 shows the balance recovery by CPG phase modulation and muscular reflexive patterns. Here, the “reset time” is a parameter of CPG phase modulation, that is, the timing at which CPG restarts from a phase memorized at the occurrence of a slip perturbation, counting from the time of the perturbation occurrence. A cross-mark (x) stands for a complete loss of its balance at the corresponding reset time and slip duration. A circle-mark (o) means that the walker ultimately recovered successfully from the corresponding perturbation, with each muscular reflexive pattern activation periods (a. 0.02 s, b. 0.05 s and c. 0.09 s).

As shown in Table 2, effective reset time that conduce balance recovery differs by slip duration, and becomes longer as slip duration increases. It is also observed that a longer muscular reflex (activation period 0.09 s) is effective for larger perturbations, and a shorter muscular reflex (activation period 0.02 s) is effective for smaller perturbations.

The first half of Fig.5 shows stable gait; however, on the occurrence of a slip perturbation at the moment of heel strike, the *Normal Walker* fell down, as shown in the latter half of the stick graph in Fig.5a.

Besides, Fig.5b shows one of the results of *Normal Walker with Reflex* successfully coping with a perturbation, in which the walker initially supported the weight with its rear leg to prevent the body from falling backwards, while simultaneously delaying the timing to move the rear leg forward for the next step, which is also observed in human gait experiments.

(a) Muscular reflexive activation period 0.02s

		reset time(s)																											
		0.1	0.12	0.14	0.16	0.18	0.2	0.22	0.24	0.26	0.28	0.3	0.32	0.34	0.36	0.38	0.4	0.42	0.44	0.46	0.48	0.5	0.52	0.54	0.56	0.58			
slip duration(s)	0.1	○	○	○	○	○	○	○	○	○	○	○	○	○	○	○	○	○	○	○	○	○	○	○	○	○	○		
	0.125	○	○	○	○	○	○	○	○	○	○	○	○	○	○	○	○	○	○	○	○	○	○	○	○	○	○		
	0.15	×	×	×	×	×	×	×	×	×	×	×	○	○	○	○	○	○	○	○	○	○	○	○	○	○	○		
	0.175	×	×	×	×	×	×	×	×	×	×	×	×	×	×	×	×	×	×	×	×	×	×	×	×	×	×		
	0.2	○	○	×	×	×	×	×	×	×	×	×	×	×	×	×	×	×	×	×	×	×	×	×	×	×	×		
	0.225	×	○	○	○	○	○	○	○	○	○	○	○	○	○	○	○	○	○	○	○	○	○	○	○	○	○		
	0.25	×	×	×	×	×	×	×	×	×	×	×	×	×	×	×	×	×	×	×	×	×	×	×	×	×	×		
	0.275	×	×	×	×	×	×	×	×	×	×	×	×	×	×	×	×	×	×	×	×	×	×	×	×	×	×		
	0.3	×	×	×	×	×	×	×	×	×	×	×	×	×	×	×	×	×	×	×	×	×	×	×	×	×	×		
	0.325	×	×	×	×	×	×	×	×	×	×	×	×	×	×	×	×	×	×	×	×	×	×	×	×	×	×		

(b) Muscular reflexive activation period 0.05s

		reset time(s)																											
		0.1	0.12	0.14	0.16	0.18	0.2	0.22	0.24	0.26	0.28	0.3	0.32	0.34	0.36	0.38	0.4	0.42	0.44	0.46	0.48	0.5	0.52	0.54	0.56	0.58			
slip duration(s)	0.1	×	×	×	×	×	×	×	×	×	×	×	×	×	×	×	×	×	×	×	×	×	×	×	×	×	×		
	0.125	×	×	×	×	×	×	×	×	×	×	×	○	○	○	○	○	○	○	○	○	○	○	○	○	○	○		
	0.15	×	×	×	×	×	×	×	×	×	×	○	○	○	○	○	○	○	○	○	○	○	○	○	○	○	○		
	0.175	×	×	×	×	×	×	×	×	×	×	○	○	○	○	○	○	○	○	○	○	○	○	○	○	○	○		
	0.2	×	×	○	○	○	○	○	○	○	○	○	○	○	○	○	○	○	○	○	○	○	○	○	○	○	○		
	0.225	×	×	×	×	×	×	×	×	×	×	×	×	×	×	×	×	×	×	×	○	○	○	○	○	○	○		
	0.25	○	○	○	○	○	○	○	○	×	×	○	○	○	○	○	○	○	○	○	○	○	○	○	○	○	○		
	0.275	×	×	×	×	×	×	×	×	×	×	×	×	×	○	○	○	○	○	○	○	○	○	○	○	○	○		
	0.3	×	○	○	×	×	×	×	×	×	×	×	×	×	×	×	×	×	×	×	×	×	×	×	×	×	×		
	0.325	×	×	×	×	×	×	×	×	×	×	×	×	×	×	×	×	×	×	×	×	×	×	×	×	×	×		

(c) Muscular reflexive activation period 0.09s

		reset time(s)																											
		0.1	0.12	0.14	0.16	0.18	0.2	0.22	0.24	0.26	0.28	0.3	0.32	0.34	0.36	0.38	0.4	0.42	0.44	0.46	0.48	0.5	0.52	0.54	0.56	0.58			
slip duration(s)	0.1	×	×	×	×	×	×	×	×	×	×	×	×	×	×	×	×	×	×	×	×	×	×	×	×	×	×		
	0.125	×	×	×	×	×	×	×	×	×	×	×	×	×	×	×	×	×	×	×	×	×	×	×	×	×	×		
	0.15	×	×	×	×	×	×	×	×	×	×	×	×	×	×	×	×	×	×	×	×	×	×	×	×	×	×		
	0.175	×	×	×	×	×	×	×	×	×	×	×	×	×	×	×	×	×	×	×	×	×	×	×	×	×	×		
	0.2	×	×	×	×	×	×	×	×	×	×	×	×	×	×	×	×	×	×	×	×	×	×	×	×	×	×		
	0.225	×	×	×	×	×	×	×	×	×	×	×	×	×	×	○	○	○	○	○	○	○	○	○	○	○	○		
	0.25	○	○	○	○	○	○	○	○	×	×	○	○	○	○	○	○	○	○	○	○	○	○	○	○	○	○		
	0.275	○	○	○	○	○	○	○	○	○	○	○	○	○	○	○	○	○	○	○	○	○	○	○	○	○	○		
	0.3	○	×	×	×	×	×	×	×	○	○	○	○	○	○	○	○	○	○	○	○	○	○	○	○	○	○		
	0.325	×	×	×	×	×	×	×	×	×	×	×	×	×	×	×	×	×	×	×	×	×	×	×	×	×	×		

Table 2. Balance recovery by CPG phase modulation and muscular reflexive patterns when slip perturbation duration changes



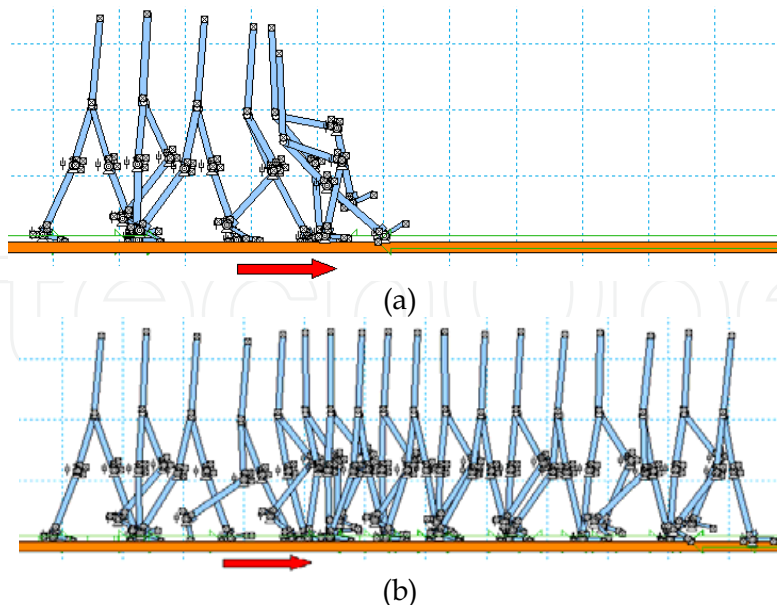

Fig. 5. Stick graphs of the *Normal Walker* and the *Normal Walker with Reflex* (arrows denote the slip period): (a) the *Normal Walker* fell down when a slip perturbation occurs; and (b) the *Normal Walker with Reflex* recovered from slip perturbation.

### 3.2. The roles of different regulation mechanisms

In order to examine the role of reflexive mechanisms, muscular-reflexive-patterns and CPG-phase-modulation, we evaluated the perturbed walk of each walker (*Normal Walker*, *Normal Walker with Phase-modulation*, *Normal Walker with muscular reflex*, and *Normal Walker with both reflexes* that is *Normal Walker with Reflex*) by the *Energy Stability Margin* and *Energy Difference* (see section 2.4). Five seconds of the *Energy Stability Margin* of each walker in the slip-perturbed condition (0.2-s slip) are plotted in Fig. 6. Here, slip perturbation occurs at 1 s in Fig. 6. In order to make a clear comparison, we selected an experimental condition (slip duration=0.25 s) that could lead to successful balance recovery for all 4 walkers. Note that, for the *Normal Walker*, this is the rare successful balance recovery case. Additionally, Fig. 7 shows the integration of the *Energy Stability Margin* of each walker after perturbation occurrence. Furthermore, five seconds of *Energy Difference* of each walker in the same slip perturbed condition is plotted in Fig. 8. Fig. 9 shows the integration of the *Energy Difference* of each walker after perturbation occurrence. Arrows in the figures denote points for further discussion. As shown in Figs. 6 and 8, the *Normal Walker with Reflex* has better balance recovery ability than the *Normal Walker*. It is also observed that both CPG-phase-modulation and muscular-reflexive-patterns could achieve more effective balance recovery than the *Normal Walker* (excepting the *Energy Stability Margin* value of the Phase-modulation-alone case, which will be discussed later), and the *Normal Walker with Reflex* (utilizing both mechanisms) could achieve most effective balance recovery (Figs. 7 and 9). This suggests that CPG-phase-modulation and muscular-reflexive-patterns display a cumulative effect for balance recovery.

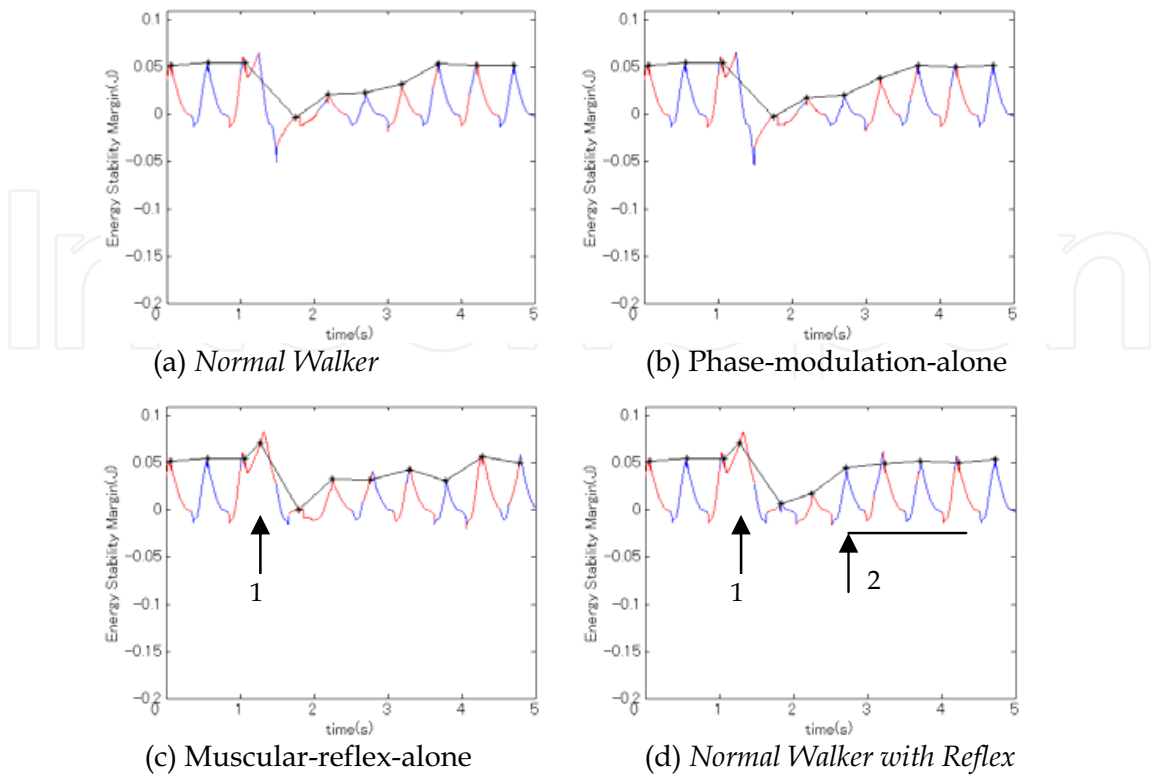

Fig. 6. Energy Stability Margin

Arrow 1 stands for the immediate improvement of balance after perturbation. Arrow 2 shows the beginning of recovered gait.

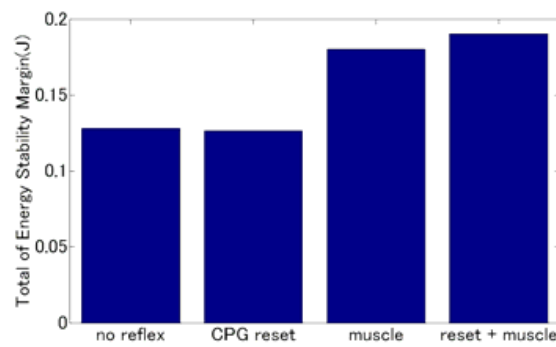

Fig. 7. Integration of Energy Stability Margin (from left, Normal Walker, Normal Walker with phase modulation, Normal Walker with muscular reflex, Normal Walker with Reflex)

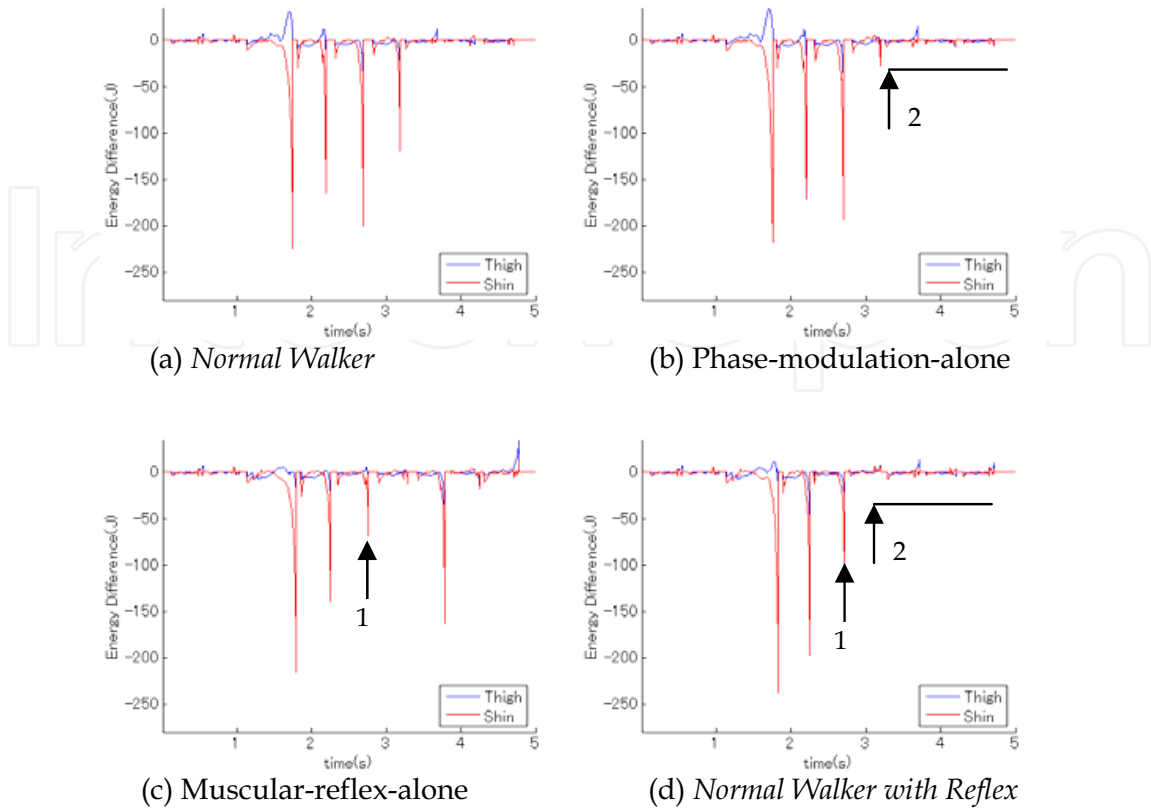

Fig. 8. Energy Difference

Arrow 1 indicates the immediate improvement of balance after perturbation, by a much smaller energy difference, compared with the 4<sup>th</sup> drop in the Normal Walker case. Arrow 2 denotes the beginning of the recovered gait, where the walker possesses the same rotational energy as that of normal walking.

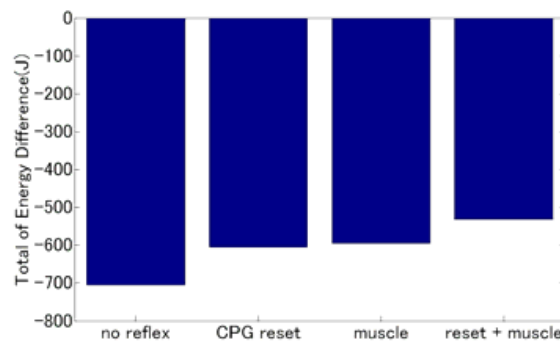

Fig. 9. Integration of Energy Difference (from left, Normal Walker, Normal Walker with Phase-modulation, Normal Walker with muscular reflex, Normal Walker with Reflex)

Fig. 10 (a) and (b) show the hip joint angle phase portraits of the muscular reflex alone case and the muscular reflex with phase modulation case, respectively. Note that the slip condition and activation term are same for both tests, and only the hip angle values of the perturbed side are plotted. The blue line and red lines represent the normal and perturbed walks, respectively. It was observed that the muscular reflex with phase modulation case

could return back to the normal walking attractor within 1.9 s, while muscular reflex alone could lead the walker back to the normal walking attractor within 2.9 s. This result suggests that CPG-phase-modulation is effective for modulating the relationship between internal CPG and the body mechanisms enabling a fast recovery to a stable walking cycle.

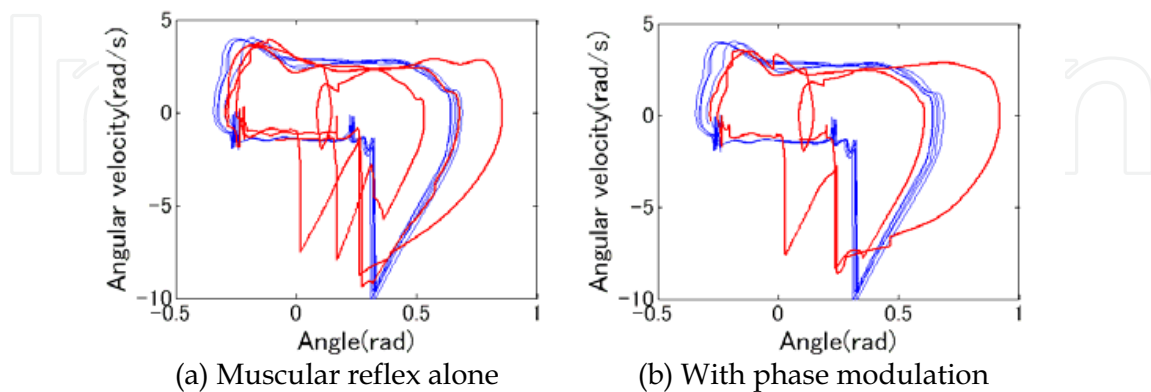

Fig. 10. Phase portraits of the hip joint angle (*Normal Walker*)

### 3.3. Spastic Gait

As the result of the experiments, *Spastic Walker* acquired a stable gait pattern. Fig.11 shows the gait of *Spastic Walker*, and Fig.12 (a) and (b) show the hip joint angle phase portraits and five seconds of Energy Stability Margin of this walker, respectively. As shown in Fig.11, *Spastic Walker* lifts its swing leg higher than *Normal Walker*, and avoids a stumbling. This result is very similar to the result of paralyzed people's gait experiment (Yu et al., 2002). Moreover, it is observed the walker has a peculiar stable limit cycle, which is different from that of *Normal Walker* (Fig.12 a). Also it is clear that the walker keeps its balance continually throughout five seconds. (Fig.12 b)

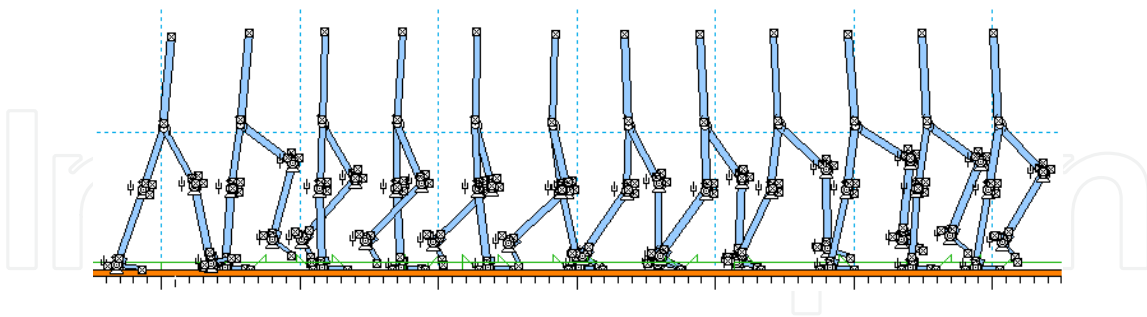

Fig. 11. Stick graph of the *Spastic Walker*

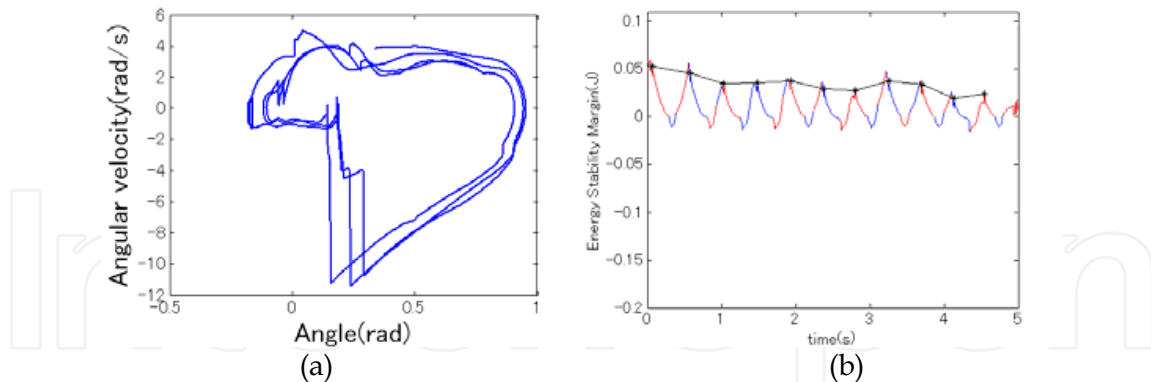

Fig. 12. (a) Phase portrait of the hip joint angle: and (b) Five seconds of the *Energy Stability Margin* of *Spastic Walker*

### 3.4. Recovery from slip perturbation during Spastic Gait

As anticipated, the *Spastic Walker* lost its balance and fell down on the occurrence of short-time slip perturbation (e.g. slip duration: 0.2s). However the *Spastic Walker with Reflex* was able to keep its balance for a certain period of time after the perturbation, even though not able to recover to its stable walking (Fig.13). Fig.14 shows the comparison between these two walkers. Note that the *Spastic Walker with Reflex* keeps standing position for a longer time than no-reflex case (Fig.14a; a period of 1.2s-2.0s), and has high balance stability compared with no-reflex case (Fig.14b; a period of 1.2s-1.6s).

Thus the acquired muscle activation profiles could reflect the fundamental elements of human balance-recovery, but it's not enough for a complete recovery in the case of the spastic walk. This denotes that, some additional mechanisms, other than the current reflexive mechanisms, should be explored for the balance recovery. This will be another issue for further investigation.

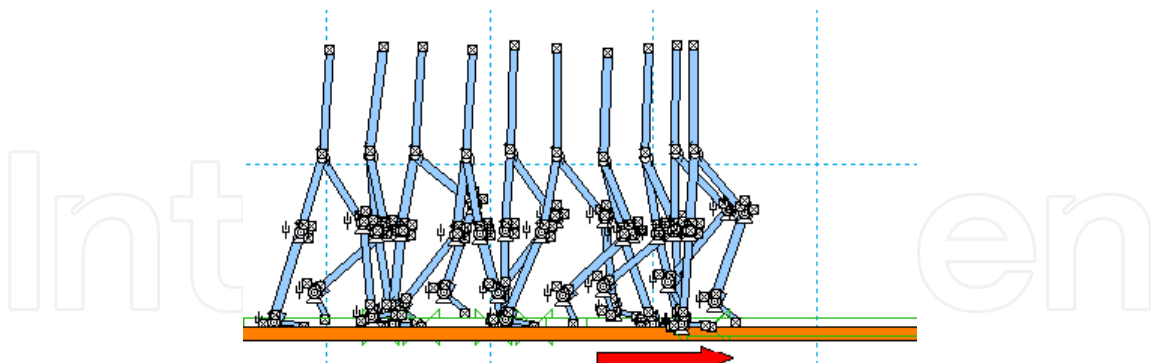

Fig. 13. Stick graph of the *Spastic Walker with Reflex* (the arrow denote the slip period): the *Spastic Walker with Reflex* kept its balance after slip perturbation.

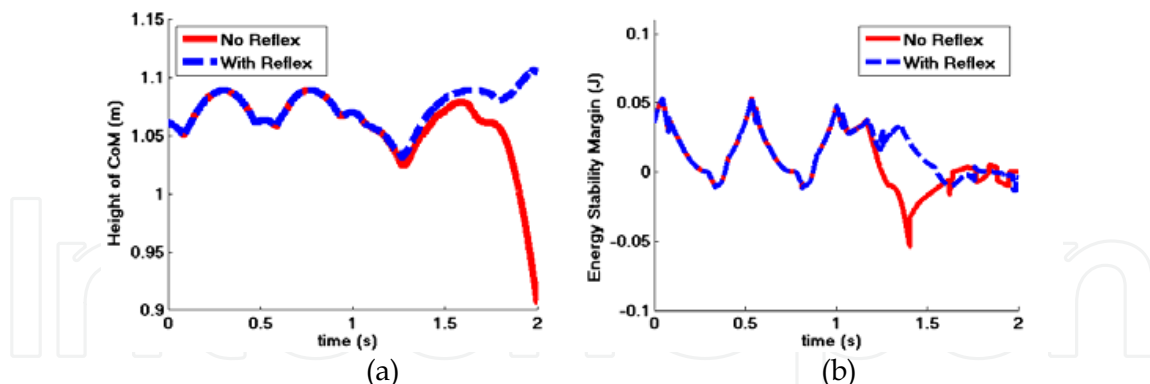

Fig. 14. The comparison between the *Spastic Walker* (red line) and the *Spastic Walker with Reflex* (blue dotted line). Note that a slip perturbation occurs from 1s to 1.2s: (a) Transition of the height of CoM; and (b) Transition of *Energy Stability Margin*

#### 4. Conclusion

In the present study, we developed four simulation models, and, through computer simulation, revealed that: 1) on the occurrence of a slip-perturbation, the rapid responding pathway could improve perturbation-resistance and maintain balance for walking; 2) using the simulation models, the roles of the muscular reflexive patterns, CPG phase modulation and afferent feedback were clarified; 3) a spastic gait can be modeled by pes equinus and appropriate compensatory muscle supports; and 4) reflexive strategies extracted from healthy subjects may contain fundamental elements of human balance recovery, thus it is available to work to some extent for spastic walkers' perturbation-resistance.

That is, feedback pathway, phase modulation, reflexive muscular patterns, and compensated gait play different but significant roles in balance recovery. Therefore, it is reasonable to conclude that our model has a redundancy mechanism for walking as the human. These results demonstrated the practical possibility of realizing artificial reflexes for paralyzed individuals.

#### 5. References

- Bajd T, Stefancic M, Zmatjacic Z, Kraij A, Savrin R, Benko H, Karcnik T, Obereza P (1997) Improvement in step clearance via calf muscle stimulation. *Medical & biological Engineering & Computing*, Vo. 35, 113-116
- Berger W, Dietz V, Quintern J (1984) Corrective Reactions to Stumbling in Man: Neuronal Co-ordination of Bilateral Leg Muscle Activity During Gait. *J. Physiol* 357:109-125
- Bisdorff R, Bronstein AM, Wolsley C, Gresty MA, Davies A, Young A (1999) EMG responses to free fall in elderly subjects and akinetic rigid patients. *J Neurol Neurosurg Psychiatry*, 66: 447-455
- Cathers I, O'Dwyer N, Neilson P (2004) Variation of magnitude and timing of wrist flexor stretch reflex across the full range of voluntary activation. *Exp. Brain Res.*, 157; 324-335
- Dietz V, Quintern J, Sillem M (1987) Stumbling Reactions in Man; Significance of Proprioceptive and Pre-programmed Mechanisms. *J. Physiol* 386:149-163



- Hagane Y, Yu W, Katane T, Sekine M, Tamura T, Saitou O (2006) Detecting Perturbation Occurrence during Walking. 11th ICPE, International Conference on Precision Engineering
- Kawamoto H., Kanbe S, Sankai Y (2003) Power Assist Method for HAL-3 Estimating Operator's Intension Based on Motion Information. Proc. of 12th IEEE Workshop on Robot and Human Interactive Communication (ROMAN 2003)
- Mathie MJ, Celler BG, Lovell NH, Coster ACF (2004) Classification of basic daily movements using a triaxial accelerometer. *Medical & biological Engineering & Computing*, Vol. 42, 679-687
- Mathie MJ, Coster ACF, Lovell NH, Celler BG (2003) Detection of daily physical activities using a triaxial accelerometer. *Medical & biological Engineering & Computing*, Vol. 41, 296-301
- Matsuoka K (1985) Sustained Oscillation Generated by Mutually Inhibiting Neurons with Adaptation. *Biol. Cybern.* 52, 367-376
- Messuri DA, Klein CA (1985) Automatic Body Regulation for Maintaining Stability of a Legged Vehicle During Rough-Terrain Locomotion. *IEEE JOURNAL OF ROBOTICS AND AUTOMATION*, Vol. RA-1, No. 3, September
- Nakamura R, Saito H (1992) *Basic Kinesiology*. 4th edn. ISHIYAKU, Tokyo
- Ogihara N, Yamazaki N (2001) Generation of human bipedal locomotion by a bio-mimetic neuromusculoskeletal model. *Biol. Cybern.* 84, 1-11
- Prochazka A, Yakovenko S (2001) Locomotor control: from spring-like reactions of muscles to neural prediction. In: *The Somatosensory System: Deciphering The Brain's Own Body Image*. ed. Nelson, R.J. Boca Raton, CRC Press, 141-181
- Quintern J (2000) Stimulation of flexor reflex afferents: a pathway to the spinal pattern generator for human locomotion? 6th Internet World Congress for Biomedical Sciences, Presentation #60
- Schomburg ED, Petersen N, Barajon I, Hultborn H (1998) Flexor reflex afferents reset the step cycle during fictive locomotion in the cat. *Exp. Brain Res.*, 122: 339-350
- Taga G (1994) Emergence of bipedal locomotion through entrainment among the neuromusculoskeletal system and the environment. *Physica D* 75, 190-208
- Tong YT, Granat MH (1998) Reliability of neural-network functional electrical stimulation gait-control system. *Medical & biological Engineering & Computing*, Vol. 37, 633-638
- Yamasaki T, Nomura T, Sato S (2003) Possible function roles of phase resetting during walking. *Biological Cybernetics*, 88, 468-496
- Yu W, Ikemoto Y (2007) An artificial reflex improves the perturbation-resistance of a human walking simulator. *Medical and Biological Engineering and Computing*, Special Issue of World Congress on Medical Physics and Biomedical Engineering 2006, Springer. DOI, 10.1007/s11517-007-0255-1, 45, pp. 1095-1104
- Yu W, Yamaguchi H, Yokoi H, Maruishi M, Mano Y, Kakazu Y (2002) EMG automatic switch for FES control for hemiplegics using artificial neural network. *Robotics and Autonomous Systems*, Vol. 40, pp. 213-224
- Zehr EP, Stein RB (1999) What functions do reflexes serve during human locomotion? Elsevier Science Ltd: *Progress in Neurobiology*, Vol. 58, pp. 185-205



## **Biomedical Engineering**

Edited by Carlos Alexandre Barros de Mello

ISBN 978-953-307-013-1

Hard cover, 658 pages

**Publisher** InTech

**Published online** 01, October, 2009

**Published in print edition** October, 2009

Biomedical Engineering can be seen as a mix of Medicine, Engineering and Science. In fact, this is a natural connection, as the most complicated engineering masterpiece is the human body. And it is exactly to help our “body machine” that Biomedical Engineering has its niche. This book brings the state-of-the-art of some of the most important current research related to Biomedical Engineering. I am very honored to be editing such a valuable book, which has contributions of a selected group of researchers describing the best of their work. Through its 36 chapters, the reader will have access to works related to ECG, image processing, sensors, artificial intelligence, and several other exciting fields.

### **How to reference**

In order to correctly reference this scholarly work, feel free to copy and paste the following:

Yu Ikemoto, Wenwei Yu and Jun Inoue (2009). A Simulation Study on Balance Maintenance Strategies during Walking, Biomedical Engineering, Carlos Alexandre Barros de Mello (Ed.), ISBN: 978-953-307-013-1, InTech, Available from: <http://www.intechopen.com/books/biomedical-engineering/a-simulation-study-on-balance-maintenance-strategies-during-walking>

**INTECH**  
open science | open minds

### **InTech Europe**

University Campus STeP Ri  
Slavka Krautzeka 83/A  
51000 Rijeka, Croatia  
Phone: +385 (51) 770 447  
Fax: +385 (51) 686 166  
[www.intechopen.com](http://www.intechopen.com)

### **InTech China**

Unit 405, Office Block, Hotel Equatorial Shanghai  
No.65, Yan An Road (West), Shanghai, 200040, China  
中国上海市延安西路65号上海国际贵都大饭店办公楼405单元  
Phone: +86-21-62489820  
Fax: +86-21-62489821

© 2009 The Author(s). Licensee IntechOpen. This chapter is distributed under the terms of the [Creative Commons Attribution-NonCommercial-ShareAlike-3.0 License](https://creativecommons.org/licenses/by-nc-sa/3.0/), which permits use, distribution and reproduction for non-commercial purposes, provided the original is properly cited and derivative works building on this content are distributed under the same license.

IntechOpen

IntechOpen