

We are IntechOpen, the world's leading publisher of Open Access books Built by scientists, for scientists

4,800

Open access books available

122,000

International authors and editors

135M

Downloads

Our authors are among the

154

Countries delivered to

TOP 1%

most cited scientists

12.2%

Contributors from top 500 universities



WEB OF SCIENCE™

Selection of our books indexed in the Book Citation Index
in Web of Science™ Core Collection (BKCI)

Interested in publishing with us?
Contact book.department@intechopen.com

Numbers displayed above are based on latest data collected.
For more information visit www.intechopen.com



Electronic and Mac Protocol Characterization of RFID Modules

Nasri Nejah, Kachouri Abdennaceur, Andrieux Laurent and Samet Mounir

¹LETI-ENIS, B.P.868-3018- SFAX

²LATTIS-IUT, BLAGNAC TOULOUSE -

¹Tunisia

²France

1. Introduction

Radio Frequency IDentification (RFID) is an advanced automatic identification technology, relying on storing and remotely retrieving data using devices called RFID tags or transponders. An RFID tag is a small object that can be attached to or incorporated into a product; animal or person (rami khouri, 2007). The application of RFID in industry warehouse, monitoring system and personal life brings researchers and engineers to focus on it. In this chapter, we address two important issues in an RFID system: Electronic and MAC protocol characterization to avoid reader-reader and reader-tag collisions in a dense RFID network.

In the first part, we present an operational description of RFID hardware components especially RFID antenna.

Current generation RFID systems address the multi-reader coordination problems, effectively where multiple readers are rarely used in the same physical layers (Sok-Won Lee, 2005). For thus, in the second part we present a survey of several collision problems that occurs when multiple readers are used within close proximity of each other. Furthermore, we evaluate the technique of medium access control to avoid collisions in multi-readers scenarios using Network Simulator (NS2).

Finally, we present a CSMA-based MAC protocol to avoid reader-reader and reader-tag collisions in a dense RFID network.

2. Recall

RFID systems consist of the following components (Simson Garfinkel et al., 2005) (Thomas Huault, 2006):

2.1 RFID tag

RFID tag consists of a microchip programmed with information about a product and a coupling element - an antenna. Most tags are only activated when they are within the interrogation zone of the interrogator. The size of the tag depends on the size of the antenna, which increases with range of tag and decreases with frequency.

Source: Radio Frequency Identification Fundamentals and Applications, Bringing Research to Practice, Book edited by: Cristina Turcu, ISBN 978-953-7619-73-2, pp. 278, February 2010, INTECH, Croatia, downloaded from SCIYO.COM

As showing in figure 1 the architecture of RFID tag is constituted by modulation / demodulation bloc, a local memory containing information about product stored in data base, and a micro-controller that represent the intelligent part of tag.

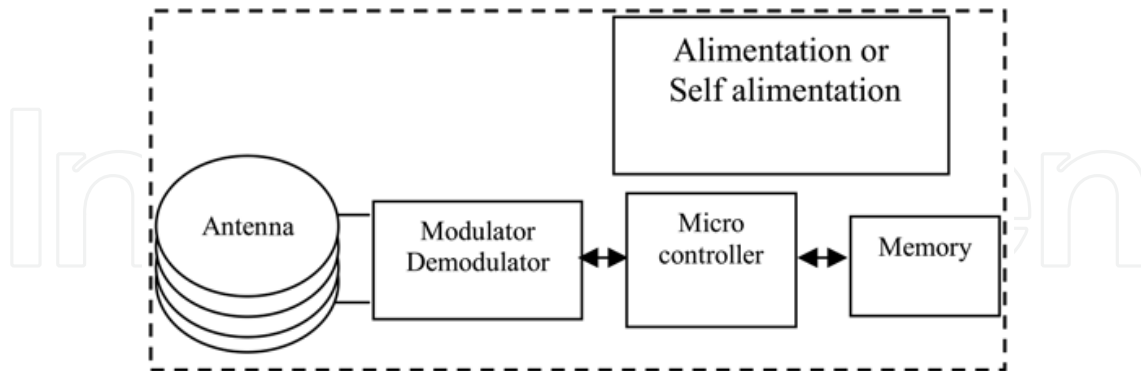

Fig. 1. Architecture of RFID tag

2.2 RFID interrogator

Depending on the application and technology used, some interrogators not only read, but also remotely write to, the tags. For the majority of low cost tags, the power to activate the tag microchip is supplied by the reader through the tag antenna when the tag is in the interrogation zone of the reader.

Generally the reader is constituted by (figure 2):

- An analog part regrouping:
 - A local oscillator accorded on the frequency of a transmitted signal.
 - A modulator/demodulator to transmit or to receive the numeric messages.
 - An amplifier adapted on the antenna of emission / reception.
- A numeric part regrouping:
 - A micro-controller for the management of communication protocols, collisions...
 - A communication interface.
 - A local memory.

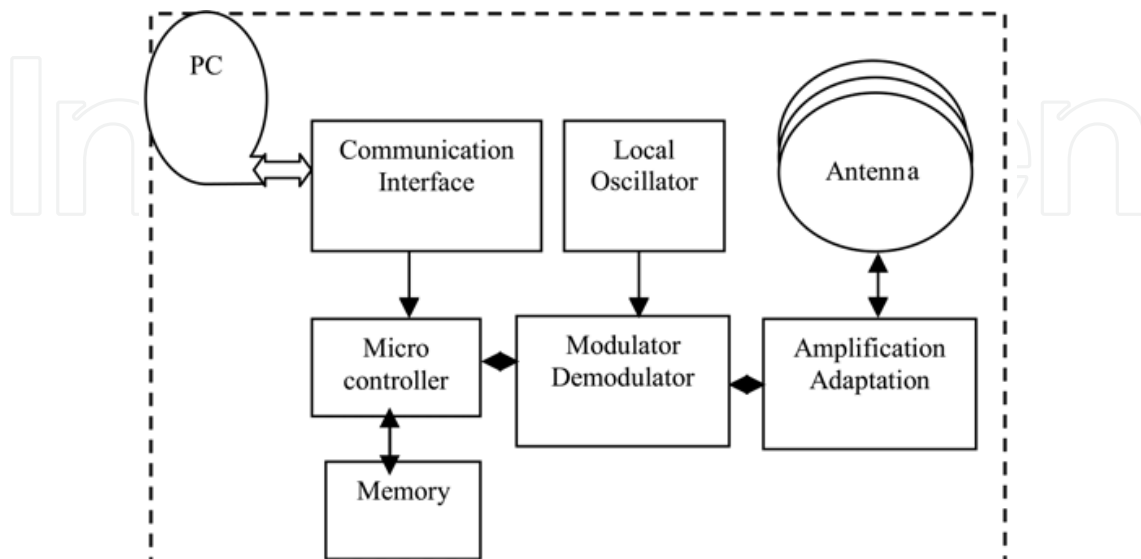

Fig. 2. Architecture of RFID integrator

2.3 Unit of collection and management of information

This unit is the interface needed between the interrogator and the existing company databases and information management software. It permit:

- Filtering and validation of raw data
- Fusion of data sent by different sensors
- System Management (monitoring, service levels, ...)
- Self-healing

The middleware RFID is constituted by informatics equipments and software of management, which convert multiple inputs in data of identification.

3. Different types of RFID tags

In RFID systems, the tags that hold the data are broken down into two different types (Cristina TURCU, 2009): Passive and Active. Passive tags do not have batteries and have indefinite life expectancies. Active Tags are powered by batteries and either have to be recharged, have their batteries replaced or be disposed of when the batteries fail.

RFID systems can use a variety of frequencies to communicate, but because radio waves work and act differently at different frequencies, a frequency for RFID system is often dependant on its application. So it is not a technology where 'one size fits all' applications.

Three primary frequency bands are being used for RFID (Thomas Huault, 2006):

- Low Frequency (125/134KHz) - used for access control, animal tracking and asset tracking.
- High-Frequency (13.56 MHz) - Used where medium data rate and read ranges up to about 1.5 meters are acceptable. This frequency also has the advantage of not being susceptible to interference from the presence of water or metals.
- Ultra High-Frequency (850 MHz to 950 MHz) - offer the longest read ranges of up to approximately 3 meters and high reading speeds.

In the same contexte There are two basic types of chips available on RFID tags: Read-Only and Read-Write: Read-only chips are programmed with unique information stored on them that can not be changed . in Read-Write chips, the user can add information to the tag or write over existing information when the tag is within range of the reader. Read-Write chips are more expensive that Read Only chips.

The table below highlights the characteristics these different tags (Gérard-André Dessenne, 2005):

Active or passive	Other Classifications
Passive (no battery) Smaller, Lighter Shorter range (<3m) Smaller data storage Lower cost	Data storage (Programming) Read Only Write once Read/write
Active (with battery) Larger, Heavier Longer range (up to 100m) Larger data storage Higher cost	Frequencies Low -135 kHz VHF -13.5 MHz UHF -860MHz Microwave -2.4 GHz

Table 1. RFID Tags Types

4. Physical survey and modeling of the RFID antenna

4.1 Physical principle

The physical principle of the RFID technology is based on the propagation of electromagnetic wave in the aerial environment. To illustrate this principle, we consider an oriented spindly circuit C , traveled by a permanent current of I intensity.

It creates in a M , point of the space a magnetic induction B (figure 3). According to the laws of Biot and Savart, if dl is an element of the circuit in P point, we can calculate the magnetic induction B in M (Patrick PLAINCHAULT, 2005).

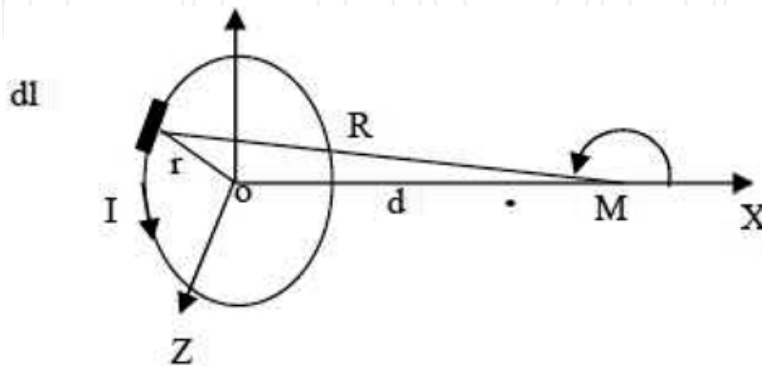

Fig. 3. Principle of magnetic fields

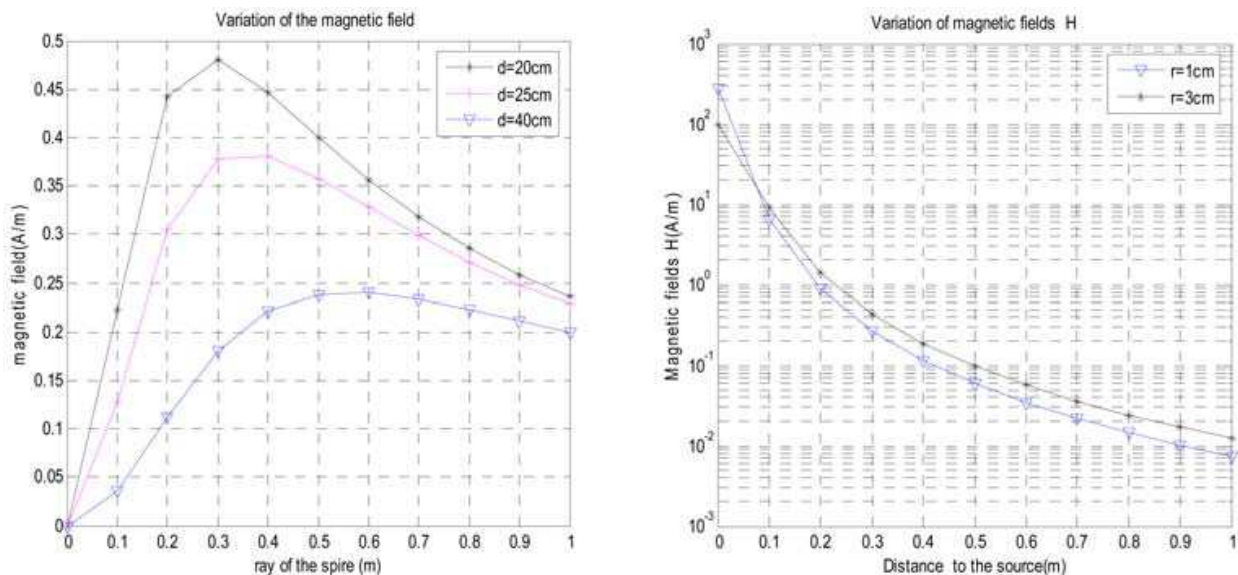

Fig. 4. Variation of the magnetic field vs distance to the source and the ray of spire

The magnetic field is expressed by:

$$\vec{B}(\text{Tesla}) = \frac{\mu_0}{4\pi} \oint \frac{\vec{I} \wedge \vec{U}}{R^2} dl \quad (1)$$

$$\vec{B} = \mu_0 \vec{H} \quad (2)$$

$$B = \frac{\mu_0 \cdot N \cdot I}{2} \cdot \frac{r^2}{(r^2 + d^2)^{3/2}} \quad (3)$$

N: the number of spire

I: current (A)

d: distance from source (meter)

r: ray (meter)

Under figure 4, we deduct that:

- For low range of communication the magnetic field in the middle of the antenna will be more intense for a low ray.
- To establish a communication for long distances it's necessary to use an antenna of a greater ray.
- The optimal ray (r) for which the magnetic field is maximal for stationary d: $r=d \sqrt{2}$

In order to improve the gotten results, in the next part we are going to present the equivalent electronic circuit of the antenna tag. Then, we present an approach for estimating and determination the Power consumption.

4.2 Electronic modeling of the antenna of a RFID tag

One of the major constraints is the attenuation of signals due the bad choice of antenna parameters. For thus, it is necessary to give an electronic model of the antenna that approaches to the reality. Then anticipate with accuracy the behavior of antenna by the use of simulation tools.

In this subsection, we discuss modifications done to the equivalent circuit of the RFID tag antenna.

Generally the equivalent electronic circuit of the tag antenna is composed of a pure inductance due to the constitution of a coil (L_{2s}), a purely ohmic resistance (R_{2s}), and a generator of tension in presence of a fields magnetic (Patrick PLAINCHAULT,2005)(Paret D.,2003):

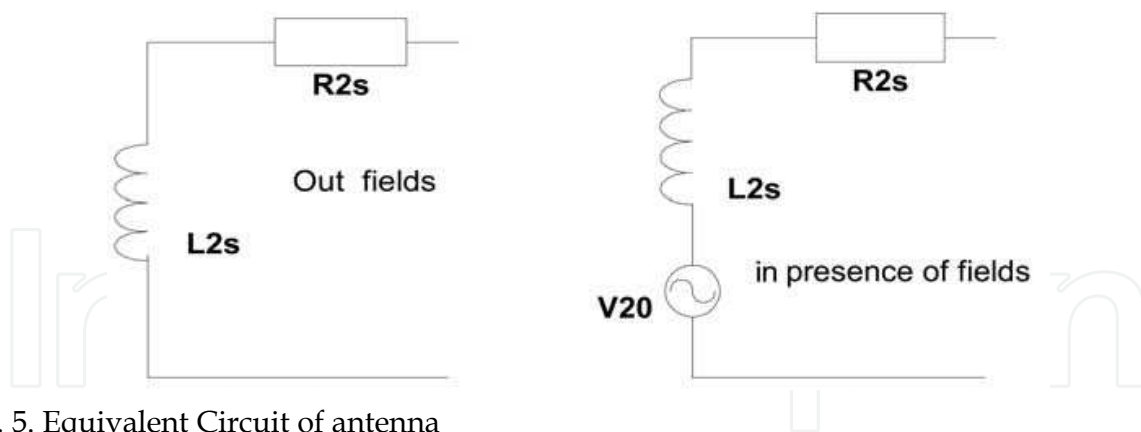

Fig. 5. Equivalent Circuit of antenna

The proper frequency of resonance of this circuit is:

$$L_{2s} \times R_{2s} \times \omega^2 = 1. \quad (4)$$

The quality coefficient is:

$$Q_{2s} = \frac{L_{2s} \times \omega}{R_{2s}} \quad (5)$$

The V_{20} (t) tension:

$$V_{20}(t) = -\frac{d\phi_2(t)}{dt} = -\frac{d}{dt} \int_{S_2} B \cdot dS_2 = -\mu \int_{S_2} H \cdot dS_2 \quad (6)$$

With:

$$\phi_2(t) = M \cdot I_1(t) \quad (7)$$

M: mutual inductance between the reader and the tag;

$I_1(t)$: current traveling the reader's antenna;

The value of the mutual M is:

$$M = \mu \frac{r^2}{2(r^2 + d^2)^{3/2}} \cdot N_1 \cdot N_2 \cdot S_2 \quad (8)$$

If the coils of the antenna are accorded to a capacity in parallel, the equivalent circuit of the antenna is showing in figure 6:

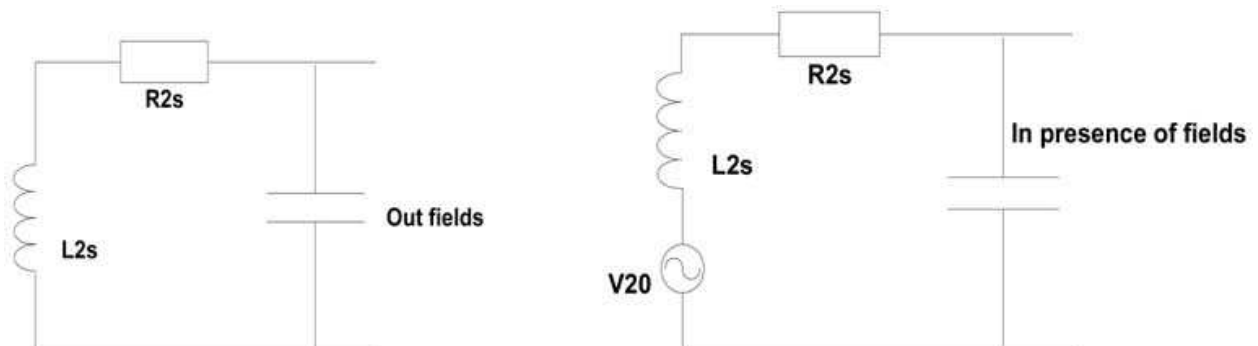

Fig. 6. Accorded antenna of RFID tags

This circuit is equivalent to an active dipole constituted by a generator of tension $V_{20}(t)$, and an internal impedance of Z_{ie} given by the following formula (Nejah NASRI et al., 2008):

$$Z_{ie} = \frac{(R_{2s} + j(L_{2s} \cdot \omega)) \cdot \frac{1}{jC\omega}}{R_{2s} + j(L_{2s} \cdot \omega) + \frac{1}{jC\omega}} = \frac{R_{2s} + j(L_{2s} \cdot \omega)}{(1 - L_{2s} \cdot \omega^2 \cdot C) + jR_{2s} \cdot C \cdot \omega} \quad (9)$$

If the tag is accorded on the frequency of resonance f_c :

$$L_{2s} \cdot C \cdot \omega_c^2 = 1 \quad (10)$$

As a result:

$$Z_{ie} = \frac{1 + j\left(\frac{L_{2s} \cdot \omega}{R_{2s}}\right) \cdot \omega_c}{jC \cdot \omega_c} \quad (11)$$

However:

$$Q_{2s} = \frac{L_{2s} \cdot \omega}{R_{2s}} \quad (12)$$

This value is always very big in relation to 1; it comes therefore:

$$z_{ie} = \frac{jQ_{2s}}{jC\omega_c} = Q_{2s}(L_{2s} \cdot \omega_c) \quad (13)$$

Finally the equivalent circuit of the complete assembling of a RFID tag "antenna accorded with integrated circuit is given by figure 7:

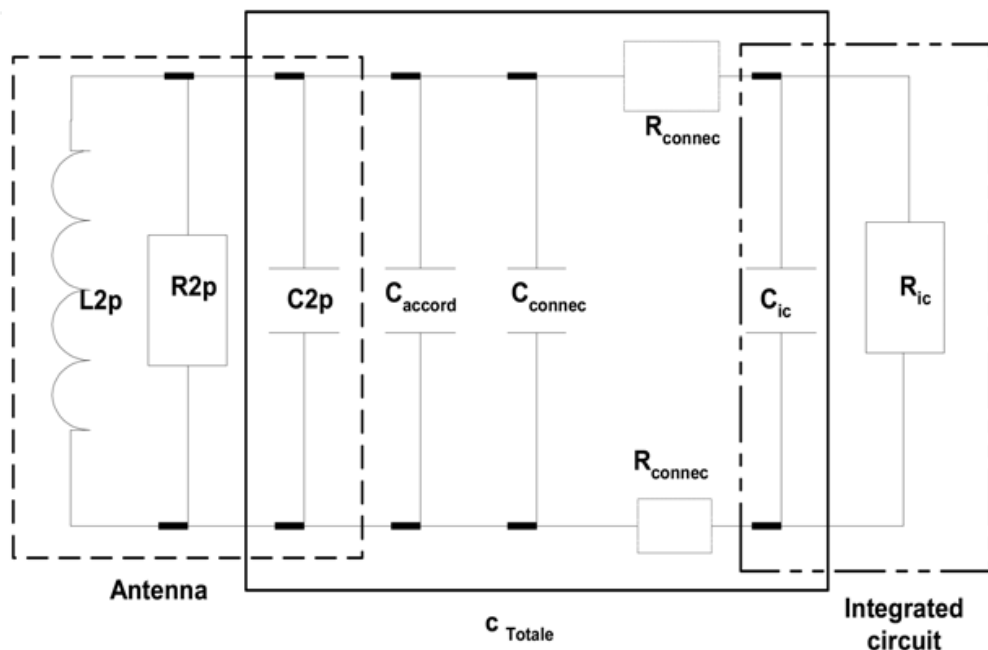

Fig. 7. Complete antenna of a RFID tag

We consider that $L_{2p} = L_{2s}$, $C_p = C_{accord} + C_{ic} + C_{connec} + C_{2p}$

With:

C_{2p} : Parallel capacity of the spool of the antenna;

C_{accord} : Okay capacity;

C_{connec} : Parallel capacities of connection;

C_{ic} : Capacity of entrance of the circuit integrated;

R_{ic} : Resistance of input of the circuit integrated;

The value of tension v_{ic} applied to the integrated circuit is given by the following formula:

$$v_{ic} = \frac{R_{ic} // C_p}{Z_{L_{2p}} + (R_{ic} // C_p)} v_{20} = \frac{1}{1 + (R_{2s} + jL_{2s}\omega)(\frac{1}{R_{ic}} + jC_p\omega)} v_{20} \quad (14)$$

With:

$$v_{20} = -j\omega \cdot M \cdot I_1 = -j\omega \cdot B_d \cdot N_2 \cdot s_2 \quad (15)$$

Therefore:

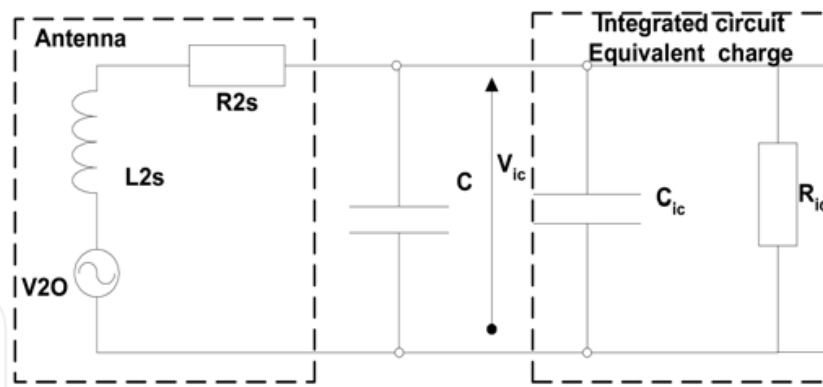
Fig. 8. Induced tension v_{ic} in the transponder

$$v_{ic} = \frac{-j\omega.M.I_1}{1 + (R_{2s} + jL_{2s}.\omega)\left(\frac{1}{R_{ic}} + jC_p.\omega\right)} = \frac{-j\omega.B_d.N_2.S_2}{1 + (R_{2s} + jL_{2s}.\omega)\left(\frac{1}{R_{ic}} + jC_p.\omega\right)} \quad (16)$$

$$v_{ic} = \frac{-j\omega.M.I_1}{\sqrt{\left(1 - L_{2s}S.C_p.\omega^2 + \frac{R_{2s}}{R_{ic}}\right)^2 + \left(\frac{L_{2s}S.\omega}{R_{ic}} + R_{2s}.C_p.\omega\right)^2}} = f(\omega) \quad (17)$$

This equation summarizes the reality of relations that exists mathematically between the various elements of equivalent circuit of antenna.

The coefficient quality is given by the following formula:

$$Q_{2s} = \frac{L_{2s}.\omega}{R_{2s}} = \frac{1}{R_{2s}.C.\omega} \quad (18)$$

Figure 9 shows the variation of tension induced in the transponder versus the inductance of the antenna and coefficient of coupling. Curves have been traced for the following values: $I_1 = 0.5$ A; $R_{ic} = 2$ kQ; $R_{2s} = 1$ Q; $L_1 = 1\mu$ H; $f=13,56$ MHz

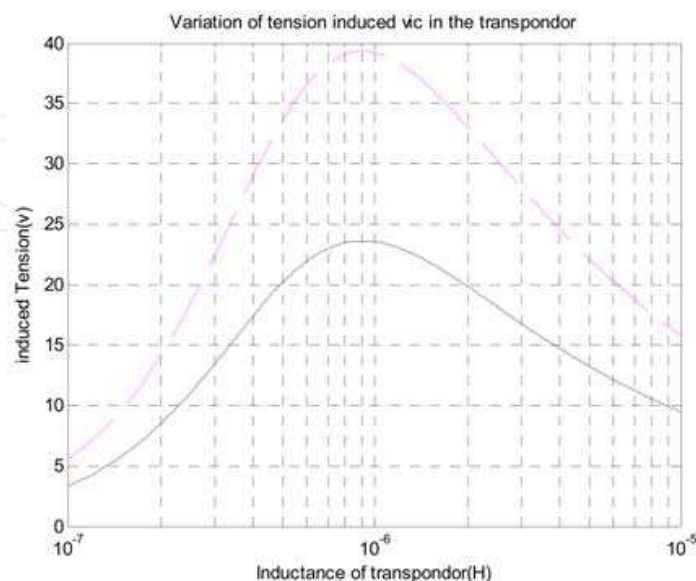
Fig. 9. Variation of tension induced v_{ic} in the transponder

According to this curve we notice that: the induced Tension in the transponder is maximal for a certain value of the inductance.

This type of simulation permits us to determine the optimal value of the inductance of the antenna.

5. Power consumption

For the design of RFID systems, the power consumption has to be taken into account. For thus, to minimize the losses of energy provided by the reader and to get important range of working, it's necessary that the impedance of the integrated circuit of the RFID tag (R_{ic}), be equal to the value of the impedance of the source providing the energy (Z_{ie}) (Nejah NASRI, 2008). The following figure presents the condition of impedance adaptation:

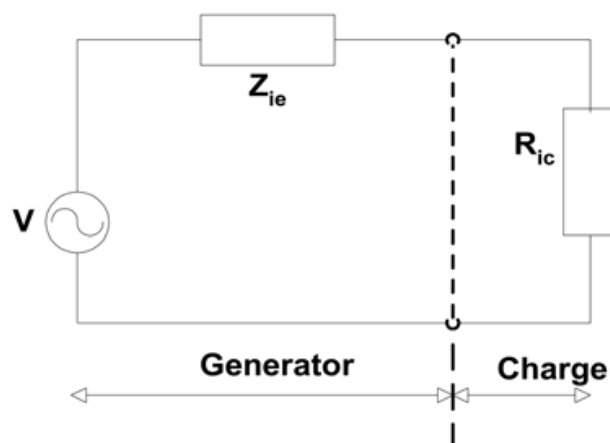

Fig. 10. Condition of power adaptation

As:

$$L_{2s} = L_{2p} \quad (19)$$

$$Z_{ie} = R_{ic} = (L_{2s} \cdot \omega) Q_{2s} \quad (20)$$

So:

$$L_{2s} = \frac{R_{ic}}{\omega \cdot Q_{2s}} \quad (21)$$

It is necessary to have a global capacity parallel C_p therefore, as:

$$L_{2p} \cdot C_p \cdot \omega = 1 \quad (22)$$

5.1 At the level of transponder

RFID tag (passive or semi passive) must provide the sufficient power to produce a signal of the return that the reader can detect. Therefore, the range transmission of a passive system depends on:

Pr: Power of the reader (typically 1 watt).

Gr: gain of the reader's antenna (typically 6 dBi).

Gt: gain of the tag's antenna (1 dBi).

Et: efficiency of the modulator (typically -20dB)

Pt: necessary power for the tag (typically 100 mW or -10 dBm).

RFID system well conceived will be limited by the power available to the tag. This power is given by the following formula:

$$P_t = P_r \cdot G_r \cdot G_t \cdot \left(\frac{\lambda}{4\pi d} \right)^2 \quad (23)$$

5.2 At the level of Reader

Considering the power radiated known as Pa. This radiated power is dissipated in the equivalent resistance of the antenna. The radiated power is expressed by (Nejah NASRI, 2008):

$$P_a = \frac{1}{2} \cdot R_{ant} \cdot I_a^2 \quad (24)$$

$$R_{ant} = \frac{320 \cdot \pi^4}{\lambda_p^4} \cdot (N_1 \cdot S_1)^2 \quad (25)$$

With

Rant: Equivalent radiance resistance.

I₁: The current crossing this equivalent resistance.

N₁: Number of spires of the reader's antenna.

S₁: The surface of the reader's antenna.

λ_p: the length of wave of the bearer

As a result:

$$P_a = \frac{320 \cdot \pi^4}{\lambda_p^4} \cdot \pi^2 \cdot N_1^2 \cdot I_a^4 \cdot I_a^2 \quad (26)$$

While taking account of the magnetic induction to the center of the antenna for $\alpha = \pi/2$.

$$B_0 = \frac{\mu_0 \cdot N \cdot I_a}{2} \cdot \frac{1}{r_1} \quad (27)$$

The power becomes:

$$L_{2p} \cdot C_p \cdot w = 1 \quad (28)$$

$$P_a = \frac{320 \cdot \pi^6 \cdot \mu_0^4}{\lambda_p^4} \cdot \frac{N_1^6}{(2 \cdot B_0)^4} \cdot I_a^6 \quad (29)$$

To the resonance, the dissipated power in the charges is:

$$P_1 = \frac{L_1 \cdot w_P}{Q_1} \cdot I_a^2 \quad (30)$$

To the resonance, the dissipated power in the charges is:

$$P_1 = \frac{L_1 \cdot \omega_p}{Q_1 \cdot N_1^2} \cdot \sqrt{\frac{P_a}{320 \cdot \pi^6} \cdot \left(2 \frac{B_0}{\mu_0}\right)^4 \frac{1}{\lambda_p^4}} \quad (31)$$

Or the current that must be provided by the reader's amplifier is:

$$I_1 = \frac{1}{N_1} \cdot \sqrt{\frac{P_a}{320 \cdot \pi^6} \cdot \left(2 \frac{B_0}{\mu_0}\right)^4 \frac{1}{\lambda_p^4}} \quad (32)$$

For a transponder operating in 13,56 MHz:

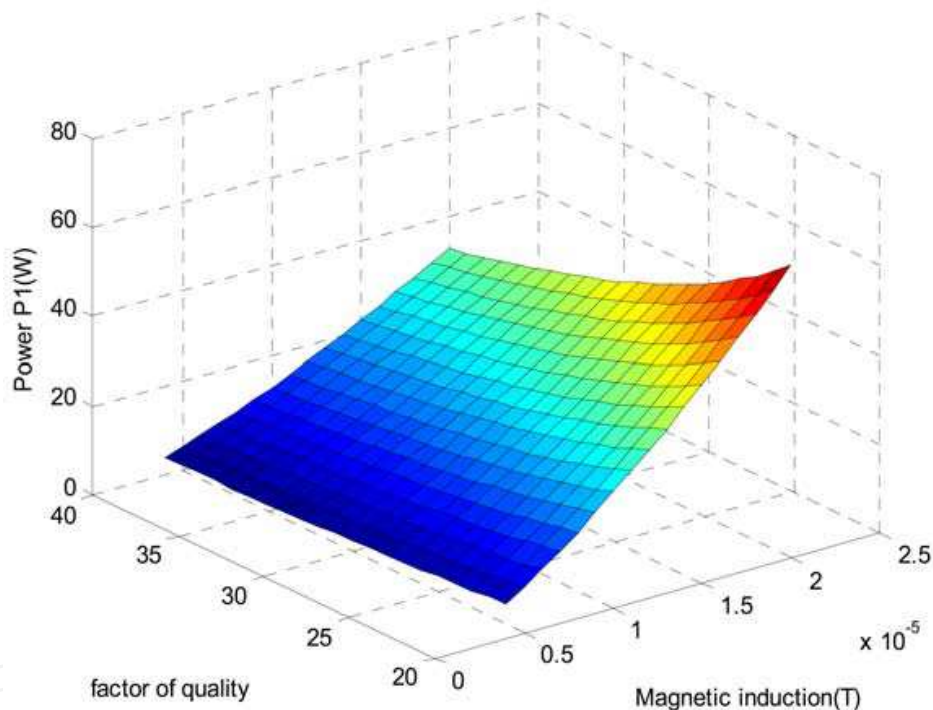

Fig. 11. Variation of the electric power in the reader's antenna according to the field to the center of the antenna

We notice that existed a minimal magnetic field B assuring the necessary tension to the working of the electronics of the transponder .in fact to get 0.4 A/ms we must arrange a field to the center of 0,5 T ,so a power of emission equal to 1 Watt .

6. Protocol survey of RFID network

6.1 Introduction

The protocols governing access to the physical layer and managing potential conflicts have a great importance in wireless networks, in which all users can transmit and receive at any time(Dan Tudor Vuza, 2009). These protocols are based on two mechanisms of allocation:

static and dynamic. A static allocation mechanism assigns a communication channel permanently, while dynamic mechanism is flexible to the nodes numbers.

6.2 Comparison between the techniques of sharing radio frequency medium

After a comparative study between different access techniques we have established a tree that describes the different methods of medium access(Christer Englund et al., 2004) (L. Zhong et al.,2001) (Jong-Hoon Youn et al., 2001)(figure II.14):

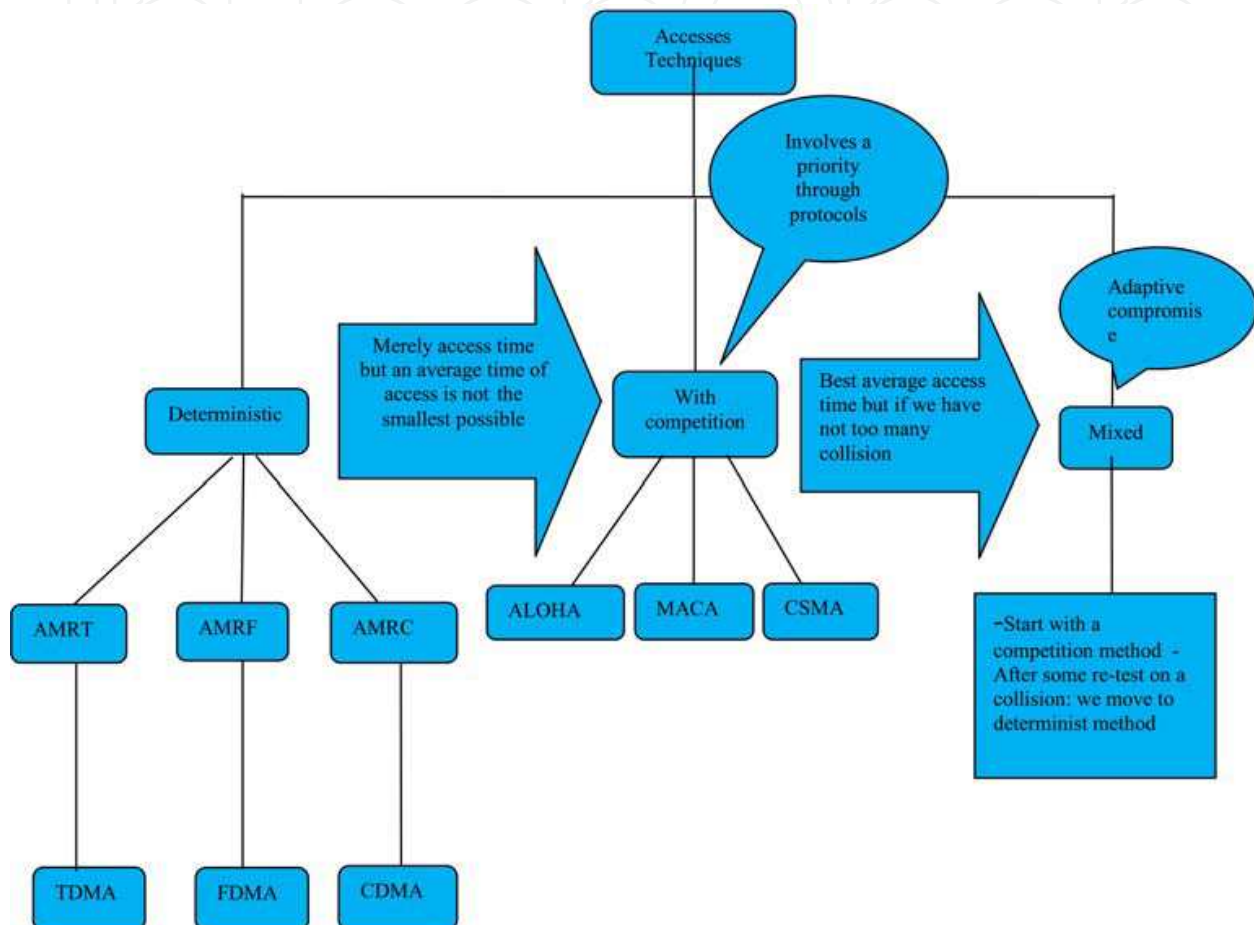

Fig. 12. Tree of accesses techniques

AMRT: Temporal Repartition Multiple Accesses

AMRF: Frequencies Repartition Multiple Accesses

AMRC: Code Repartition Multiple Accesses

TDMA: Time Division Multiple Access

FDMA: Time Division Multiple Access

CDMA: Time Division Multiple Access

MACA: Multiple Accesses with Collision Avoidance

CSMA: Carrier Sense Multiple Access

RFID is an innovative technology. Indeed, techniques for sharing the transmission medium used in other wireless communication systems are not functional in RFID technology. In summary we conclude that:

- Temporal access techniques require a synchronization time circuit between a reader and tag so a high cost of manufacture.

- Frequency access techniques do not require frequency synchronization between a reader and tag, but in against part we will have a permanent allocation of frequency band (transmission medium).
- Code division multiple accesses suffer from NEAR FAR problem where the labels are mobile.
- The dynamic access techniques are most suitable for RFID technologies. They are flexible on the variation of tags number and for different network topologies.

Overall, the static accesses techniques are not suitable for RFID technology. Dynamic techniques accesses are the most proponents for dense RFID networks. For thus in the following chapter we present a survey of the CSMA-MAC protocol based on the network simulator (NS2).

6.3 Collisions in RFID systems

Simultaneous transmissions in RFID systems has led collisions problem, as readers and tags operate on the same channel. Three types of collisions are possible (Shweta Jain et al., 2006)(EPCTM,2006):

1. Collision Tag-Tag

The collision of Tag-tag occurs when multiple Tag transmit signal in wireless medium at the same time. Due to the arrival of multiple signals at the same time, the reader can not detect any tag. This problem prevents the reader to detect tags in its interrogation zone.

2. Collision reader-tag

The reader-tag collision occurs when the signal interferes with the neighbor's response tag which was received by other readers.

3. Collision reader-reader

A reader-reader collision occurs when a tag receives a signal from multiple readers simultaneously. In this situation, the tag may not be able to satisfy all readers.

6.4 Solution to reduce collisions in RFID networks

In this work we use an access method based on CSMA to solve the problem of collision. Indeed most of the solutions using a classic technique provide access problems so:

- TDMA requires a synchronization circuit therefore high cost of manufacturing.
- FDMA requires a large number of frequencies hopping.
- CDMA suffer problem Near-Far.

We simulate a network that adopts the RFID services at the MAC layer by varying each time the integration of RTS / CTS on the level Configuration Protocol CSMA.

We notice from Fig.13:

- The number of packets successfully transmitted on the total number of packets generated decreases when the load offered by area increases.
- Between 0.5 and 10 packets per second per node the reports decreases rapidly and then stabilizes beyond 15 packets per second.
- When the offered traffic load is low, we have maximum contribution because there are fewer collisions between different nodes.

From fig.14:

- The curves show the average number of data packets successfully transmitted (payload) based on the total load of the network.

- The payload increases proportionally with the speed of traffic and stabilizes at a fixed value; this stability is the result of the problem of collisions.
- To present the interest of the mechanism CSMA / CA with RTS / CTS we performed a simulation with and without RTS / CTS, these two simulations have the same configurations. Indeed in low load the two mechanisms have the same performance. As against when traffic load increases the mechanism RTS / CTS becomes more efficient.

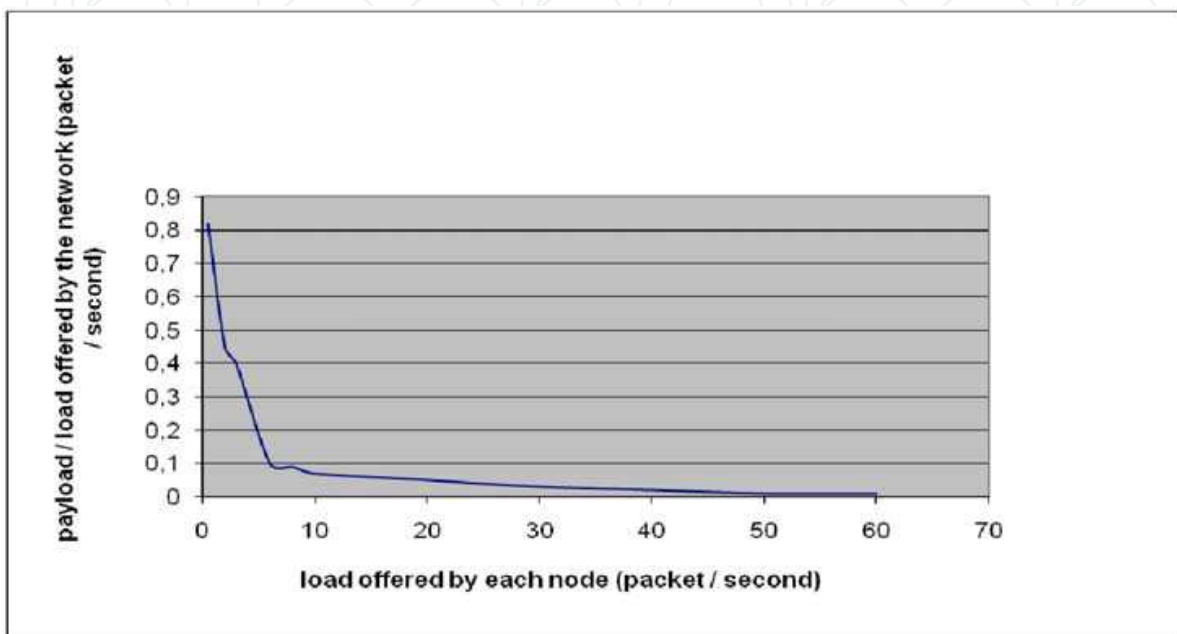

Fig. 13. Relationship between the load generated by the nodes in the coverage area and the payload

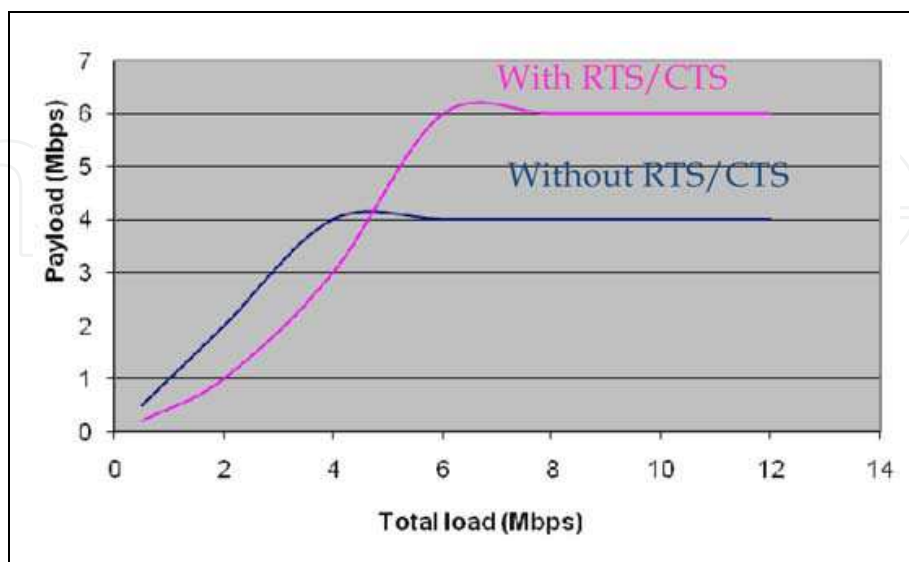

Fig. 14. Comparison of the payload with RTS / CTS and without RTS / CTS

7. Conclusion

In this chapter we detailed the RFID technology and we making the extraction of pattern from the electronic modules comprising the RFID system (base station and transponder). Finally we presented a comparison study on the MAC layer of the OSI model. Especially we have presented a tree of accesses method for wireless networks and we have modeled CSMA based o MAC protocol for RFID networks in NS2.

8. References

- rami khouri.(Mai 2007). these de doctorat de l'INP grenoble, *modélisation comportementale en vhdl-ams du lien RF pour la simulation et l'optimisation des systèmes RFID UHF et microondes*, page 31.
- Sok-Won Lee.(June 2005). Thesis, *A Multiple Access Algorithm for Passive RFID tags*, p 4. School of Electrical and Electronic Engineering College of Engineering Yonsei University.
- Simson Garfinkel; Henry Holtzman.(june 2005). *understanding RFID technology*, garfinkel.book.
- Thomas Huault.(2005-2006). *Systèmes RFID* , Master recherche optique et radio fréquence.
- Cristina TURCU. (February 2009).Development and Implementation of RFID Technology, In tech BOOK. www.ni.com.*Advanced RFID Measurements: Basic Theory to Protocol Conformance Test*.
- Gérard-André Dessenne. *Etat de la normalisation RFID au 15-10-2005*,par du Pôle Traçabilité.
- M. Patrick PLAINCHAULT. (février 2005). Thèse de doctorat de l'institut national polytechnique de toulouse, *sécurisation de la conduite par communication véhicule infrastructure a base de transpondeurs*.
- Paret D(2003). *Application en identification radiofréquence et cartes à puce sans contact*, Dunod, Paris.
- Nejah NASRI. (2008). *Radio Frequency IDentification (RFID)Working,design considerations and modelling of antenna*, 2008 5th International Multi-Conference on Systems, Signals and Devices.
- Dan Tudor Vuza (February 2009). *A Low Cost Anticollision Reader*, 1Institute of Mathematics of the Romanian Academy.www.intechweb.org.
- Christer Englund and Henrik Wallin(April 2004). *RFID in Wireless Sensor Network*, Communication Systems Group Department of Signals and Systems CHALMERS UNIVERSITY OF TECHNOLOGY GÅoteborg, Sweden.
- Jong-Hoon Youn and Bella Bose.(Oct 2001). *An energy conserving medium access control protocol for multihop packet radio networks*. In IEEE International Conference on Computer Communications and Networks, pages 470-475. ICCCN.
- L. Zhong, R. Shah, C. Guo, and J. Rabaey.(May 2001). *An ultra-low power and distributed access protocol for broadband wireless sensor networks*. In IEEE Broadband Wireless Summit, Las Vegas, NV.
- Shweta Jain , Samir R. Das.(September 29, 2006). *Collision Avoidance in a Dense RFID Network*, WiNTECH'06, Los Angeles, California, USA.

EPCTM. (2006). *Radio-Frequency Identification Protocols Class-1 Generation-2 RFID Protocol for Communications at 860 MHz – 960 MHz Version 1.10*, EPCglobal Inc.

IntechOpen

IntechOpen



Radio Frequency Identification Fundamentals and Applications Bringing Research to Practice

Edited by Cristina Turcu

ISBN 978-953-7619-73-2

Hard cover, 278 pages

Publisher InTech

Published online 01, February, 2010

Published in print edition February, 2010

The number of different applications for RFID systems is increasing each year and various research directions have been developed to improve the performance of these systems. With this book InTech continues a series of publications dedicated to the latest research results in the RFID field, supporting the further development of RFID. One of the best ways of documenting within the domain of RFID technology is to analyze and learn from those who have trodden the RFID path. This book is a very rich collection of articles written by researchers, teachers, engineers, and professionals with a strong background in the RFID area.

How to reference

In order to correctly reference this scholarly work, feel free to copy and paste the following:

Nasri Nejah, Kachouri Abdennaceur, Andrieux Laurent and Samet Mounir (2010). Electronic and Mac Protocol Characterization of RFID Modules, Radio Frequency Identification Fundamentals and Applications Bringing Research to Practice, Cristina Turcu (Ed.), ISBN: 978-953-7619-73-2, InTech, Available from: <http://www.intechopen.com/books/radio-frequency-identification-fundamentals-and-applications-bringing-research-to-practice/electronic-and-mac-protocol-characterization-of-rfid-modules>

INTECH
open science | open minds

InTech Europe

University Campus STeP Ri
Slavka Krautzeka 83/A
51000 Rijeka, Croatia
Phone: +385 (51) 770 447
Fax: +385 (51) 686 166
www.intechopen.com

InTech China

Unit 405, Office Block, Hotel Equatorial Shanghai
No.65, Yan An Road (West), Shanghai, 200040, China
中国上海市延安西路65号上海国际贵都大饭店办公楼405单元
Phone: +86-21-62489820
Fax: +86-21-62489821

© 2010 The Author(s). Licensee IntechOpen. This chapter is distributed under the terms of the [Creative Commons Attribution-NonCommercial-ShareAlike-3.0 License](#), which permits use, distribution and reproduction for non-commercial purposes, provided the original is properly cited and derivative works building on this content are distributed under the same license.

IntechOpen

IntechOpen