

# We are IntechOpen, the world's leading publisher of Open Access books Built by scientists, for scientists

4,800

Open access books available

122,000

International authors and editors

135M

Downloads

Our authors are among the

154

Countries delivered to

TOP 1%

most cited scientists

12.2%

Contributors from top 500 universities



WEB OF SCIENCE™

Selection of our books indexed in the Book Citation Index  
in Web of Science™ Core Collection (BKCI)

Interested in publishing with us?  
Contact [book.department@intechopen.com](mailto:book.department@intechopen.com)

Numbers displayed above are based on latest data collected.  
For more information visit [www.intechopen.com](http://www.intechopen.com)



# Design of a Tactile Sensor for Robot Hands

Giorgio Cannata<sup>1</sup> and Marco Maggiali<sup>2</sup>

<sup>1</sup>University of Genova

<sup>2</sup>Italian Institute of Technology  
Italy

## 1. Introduction

Grasping and manipulation of objects, as well as the capability interacting safely with the environment (possibly including also humans), is a fundamental task for a humanoid robot. In order to tackle these issues a great effort has been put for over two decades to develop robot hands or mechanisms emulating the grasping capabilities of a human hand (Salisbury & Mason 1985; Jacobsen et al. 1986; Melchiorri & Vassura 1992; Lotti et al. 2004; Butterfass et al. 2001; Carrozza et al. 2003; Kargov et al. 2005; Caffaz & Cannata 1998; Lane et al. 1997; Hashimoto 1995). However, grasping and manipulation control also rely the availability of suitable contact and force feedback.

In this chapter we first present a survey of recent advances in the area of skin-like tactile sensors for both robot hand and for robot bodies. In the second part we will discuss the design of an embedded and modular tactile/ force sensor to be installed on the phalanges of a robot hand. Each sensor consists of a distributed array of analog tactile elements and an integrated three-component force transducer with embedded analog and digital electronics. The tactile sensor consists of a matrix of electrodes etched on a flexible printed circuit board covered by pressure conductive rubber. The force sensor is instead an off-the-shelf integrated three components micro-joystick.

## 2. Tactile and force sensors for robots and robot hands

Tactile sensing in robotics has been widely investigated in the past 30 years (Webster 1988), and has received particular attention in recent years for the problems of grasping control with robot hands (Kawasaki 2002, Martin et al. 2004, Cannata 2005, Carrozza et al. 2006, Liu 2006), but also for sensing contacts over robot links (Asfour 2006, Hishiguro 2006) in order to enable safe interaction between humanoid robots and humans.

Research in this field has focused largely on transduction principles and transduction technology: as a matter of fact a wide range of transduction solutions have been proposed (Lee 1999). Most of the devices were either of the scalar single-point contact variety or were linear or rectangular arrays of sensing elements. The main transduction methods identified mostly belong to the following classes: resistive, capacitive, piezoelectric and pyroelectric, magnetic, optical, ultrasonic.

Despite the efforts made to prove the effectiveness of different type of transduction principles, various issues have strongly limited the development of embedded solutions for

Source: Sensors, Focus on Tactile, Force and Stress Sensors, Book edited by: Jose Gerardo Rocha and Senentxu Lanceros-Mendez, ISBN 978-953-7619-31-2, pp. 444, December 2008, I-Tech, Vienna, Austria

both robot hands and large area tactile sensors (*robot skin* in the following) and their actual application by the robotic scientific community. On one hand developing a tactile sensor is a *very hardware* problem involving several engineering issues and often also special process equipment. Furthermore, there are at the bottom various technological difficulties which represent the bottleneck limiting the transition from a single tactile element (or a small matrix prototype) to a large scale integrated solution (e.g. the *curse of wiring* issue).

This section is a short survey of various recent and interesting papers addressing the problem of designing sensorized robot hands as well as robot skin mostly at system level. The objective is to provide a state of the art of tactile sensors from a system level point of view, emphasizing the issues of integration of the transducers with the electronic and mechanical hardware. Also, we will focus on *standard* transduction techniques (piezoresistive, piezo-electric, capacitive and optical being the most common), since we assume that these principles are currently the best candidates for in-house custom development of embedded tactile sensing devices.

## 2.1 Tactile sensors for robot hands

For manipulation and grasping robots must be capable controlling the forces arising at the contact points. If the geometry of the gripper or robot hand is well known and the contacts area can be modeled as point wise it is possible to compute (or estimate) the contact location as well as the applied force using a six-axes force/ torque intrinsic tactile sensor as discussed in (Bicchi et al 1993). However, this minimalistic approach may fail as long as more complex interactions could arise (e.g. in the case of multiple contacts, or contacts with non rigid objects etc.). In this case the geometry of the contacts as well as pressure distributions must be measured directly using skin-like sensors.

The design of distributed tactile sensors for robotic applications has been widely discussed in recent years (Shimoyo 2004; Krishna & Rajanna 2002; Yamada et al. 2002; Engel et al. 2003). ). However, there has been an only limited number of papers discussing the integration and embedding of these devices on dextrous robotic hands. As a matter of fact, miniaturization and cabling harness still represent one of the most important limitations to the design of small sized embedded sensors.

The four-fingered hand DLR-II (Butterfass et al. 2001), Figure 1, is a significant example of robot gripper integrating on board a complete force/ torque sensor system. This hand has 22 degrees of freedom (DOFs) and is a complete self-contained system including motors, electronics and sensors. A sophisticated six-components force/ torque transducer is installed on each fingertip and connected with the electronic modules, hosted on the palm of the hand, by ten wires (8 for data and 2 for power supply), Figure 2. The DLR-II does not make use of tactile sensors and can detect contacts located only on its fingertips.

The GIFU hands II and III (Kawasaki et al., 2002; Mouri et al 2002), Figure 3, have a commercial six axis force/ torque sensor (produced by BL AUTOTECH) integrated on each fingertip. However, these hands also feature a distributed tactile sensor based on pressure sensitive piezo-resistive ink transducers, see Figure 3. The tactile sensor has 859 taxels. formed by various grids of electrodes; the palm, the thumb, and each of the other fingers have 313, 126, and 105 taxels respectively covering about 50% of the transducer's area. The sensor can withstand a maximum pressure load of about  $2.2 \times 10^{-3}$  N/ m<sup>2</sup>, with a resolution of 8 bits. The sampling cycle is 10 ms/ Frame. The sensor is about 0.2 mm thick and can cover both planar and cylindrical surfaces. The hand does not embed the sensor electronics and sensor cables from the transducers and sensors are all routed along the fingers and palm.



Fig. 1. DLR-II Hand (Butterfass et al. 2001).

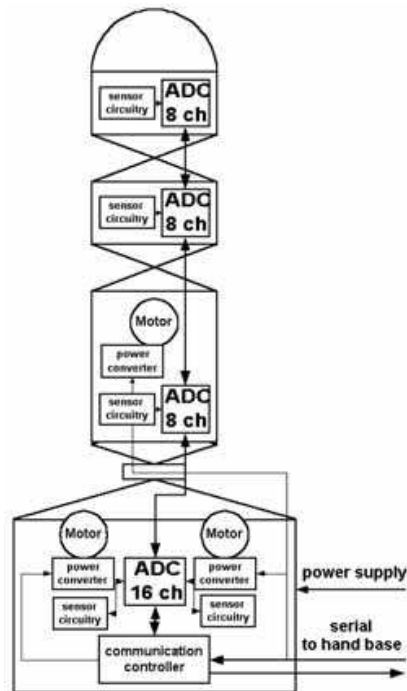

Fig. 2. Embedded electronics of the DLR-II finger (Butterfass et al. 2001).

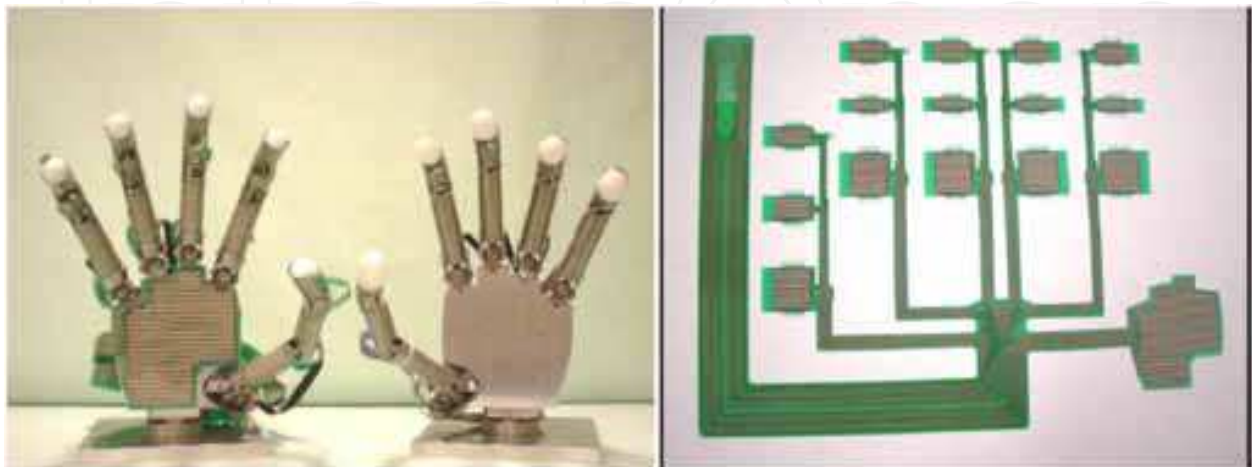

Fig. 3. Gifu hand III and skin-like tactile sensors (Kawasaki et al., 2002; Mouri et al 2002).

Another interesting example of integrated mechanical and sensing design is the robot hand CyberHand, a five fingered tendon driven under-actuated gripper, (Carrozza et al. 2006), Figure 4. Each finger has on its tip a custom three axis force transducer, while the phalanges are sensorized with custom flexible polyimide sensor formed by on-off taxels, with an activation force of about 1N. Also in this case, the design of the sensor does not feature embedded electronics on the finger. This kind of skin sensor can provide only geometrical contact information, therefore cable-tension sensors based on strain gauges have been integrated to estimate the force applied at the contact.

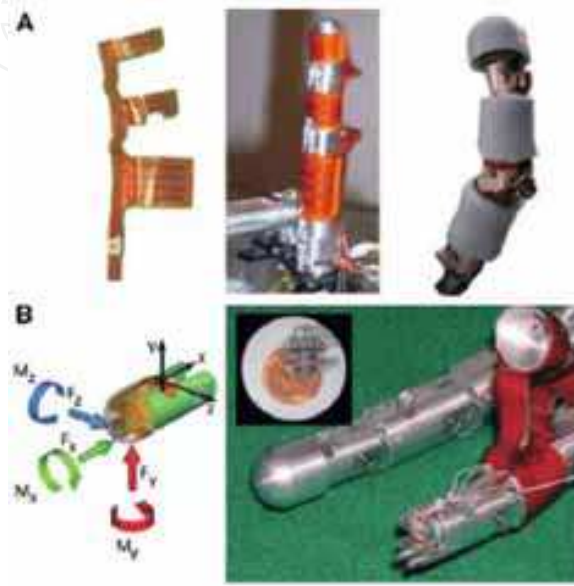

Fig. 4. Cyberhand tactile sensor.



Fig. 5. Placement of the pressure transducers in the Robonaut hand (Martin et al., 2004).

In the Robonaut hand (Martin et al., 2004), Figure 6, a different approach to skin-like tactile sensing has been proposed. Instead of integrating the transducers on the mechanical structure of the hand, a *sensorized glove* covering the hand and embedding force transducers and cabling has been developed. The proposed design is based on a coarse grain distribution of pressure sensitive resistive rubber transducers (produced by QTC Ltd. and



Interlink Inc.), Figure 7. In total the glove has 33 sensitive sites where contact forces are concentrated by means of plastic beads.

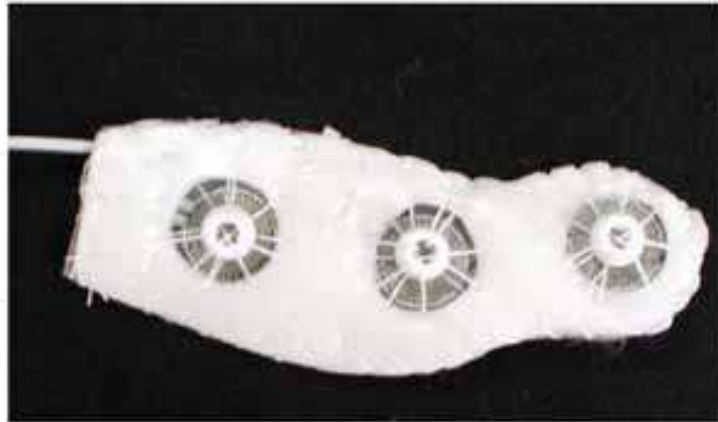

Fig. 6. Robonaut hand (Martin et al., 2004)

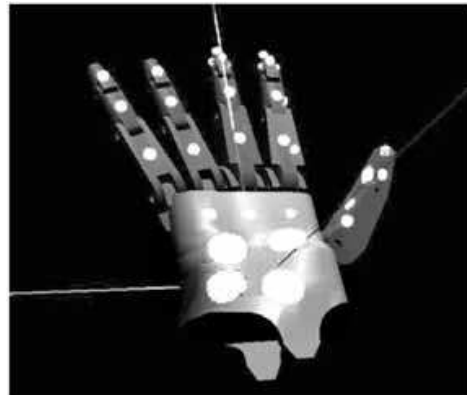

Fig. 7. Detail of the Robonaut skin (Martin et al., 2004).

The concept is simple and the adoption of *discrete* piezo-resistive resistive transducers suggests that this solution could be used for simple custom tactile sensors, also because interface electronics consists only of a voltage divider. There are however some drawbacks quoted by the authors. In fact, as the hand opens and closes the glove itself applies forces on the transducers; furthermore the glove interferes with the hand movements. Both these problems have been addressed in (Martin et al., 2004), but the authors considered them still open issues.

## 2.2 Large scale tactile sensors

From the previous section it emerged that a major issue for designing tactile sensors for grasping and manipulation is related to the need of tailor-made solutions. In fact, most of the solutions proposed are strongly dependent on the mechanical design and specialized for a particular platform. Other features like modularity and scalability could in fact improve the characteristics of these devices. The target is that of developing modular sensors, with embedded transducers and electronics possibly based on a common design. Networking of these devices would make possible the scalable (and incremental) development of large scale tactile sensors.

These ideas have been used for the design of various *large scale* skin-like sensors proposed in the literature. By large scale we intend tactile sensors which can cover large areas of a robot body conforming to its outer shape.

The investigation on large scale robot skin has originally received attention for particular applications, as space robotics (Lumelsky et al., 2001), But it significantly rose recently with the growth of the interest in humanoid robots. A humanoid robot is expected to interact in complex and largely unpredictable way with its surrounding environment, and it is expected to be capable of safe and purposive interaction with humans (A. Billard and R. Siegwart 2004). The class of humanoid robot based tasks requiring direct interaction capabilities is certainly much larger and critical than those addressed in the past, and complex operations involving concurrent walking, interaction with humans and body manipulation (Ohmura, 2007) are strongly based on active control based also on tactile feedback. In fact, these tasks need the monitoring of the contacts of the robot with the environment which may happen at unpredictable positions and in unpredictable ways.

One of the first examples of truly scalable robot skin systems for humanoid robots has been proposed by Ohmura and Kuniyoshi (Ohmura et al., 2006). They approached the problem at system level, and focused the issue of the wiring as the key problem for developing a technology which could be practically exploited. Their main contribution has been that of introducing a networked architecture featuring peripheral nodes (chips) scanning (locally) a limited number of taxels. All the electronics and the transducers are embedded on a tree-shaped flex/semi-flex PCB support, Figure 8. This solution allows a simple mechanical integration of the sensor over curved surfaces and has been experimentally tested with success (Ohmura 2007), Figure 9. This system design has however some limitations. The spatial resolution is quite low since the minimum distance between the taxels is about 2.7 cm. Furthermore, the sensor is based on IR optical transducers which have (at the present status of the technology) a quite large power consumption; this means that for a complete robot skin system (which might have thousands of taxels) the power supply requirements could become critical (e.g. for autonomous robots). An attempt to limit the current requirements has been that of sequencing the switching on of the LED and this clearly reduces the sampling rate capability of the sensor. Finally, other limitations of this design are related to the network solution adopted which does not seem to support fault tolerance mechanisms. This is important since for its own nature robot-skin could be subject to continuous or cyclic stress and impacts over long periods of time and its performance should possibly have graceful degradation. The fault tolerance problem was previously addressed by Um and Lumelsky (Um et al. 1999), who tackled the problem via component redundancy for a system featuring over 1000 sensing elements.

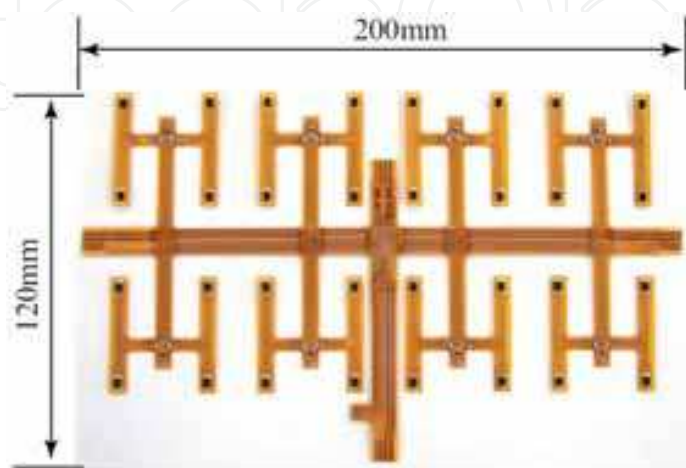

Fig. 8. Tactile sensor sheet (Ohmura 2007)

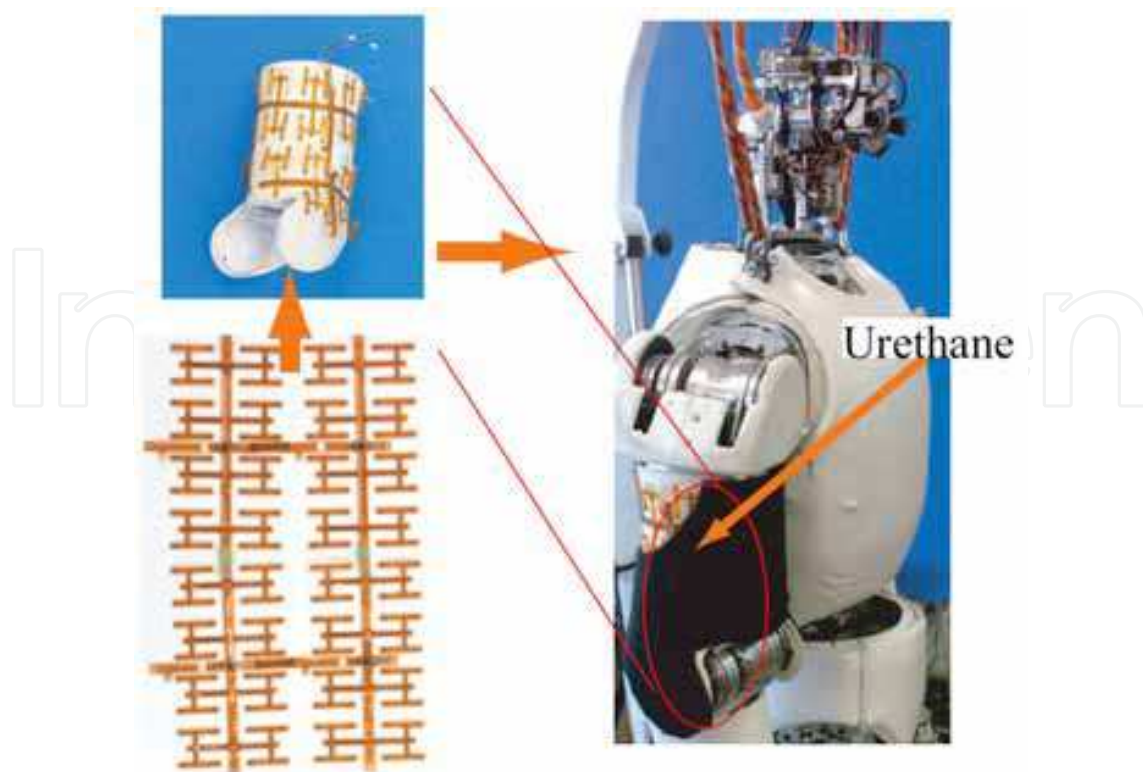

Fig. 9. Integration of the robot skin on the robot (Ohmura 2007).

A similar layout, but using piezo-resistive commercial pressure transducers has been recently proposed in (Mukai, 2008), Figure 10. The sensor is modular, and consists of 8·8 taxels with a spatial resolution of 1.8 mm which can withstand a pressure of about 12 N/cm<sup>2</sup>. It does not embed electronics, however custom hardware modules for data acquisition and networking allow a scalable configuration of the system. The RI-MAN humanoid robot (Mukai, 2008), is equipped with five tactile modules for a total of 340 taxels and implements a tactile based feedback control operating at 50 Hz.

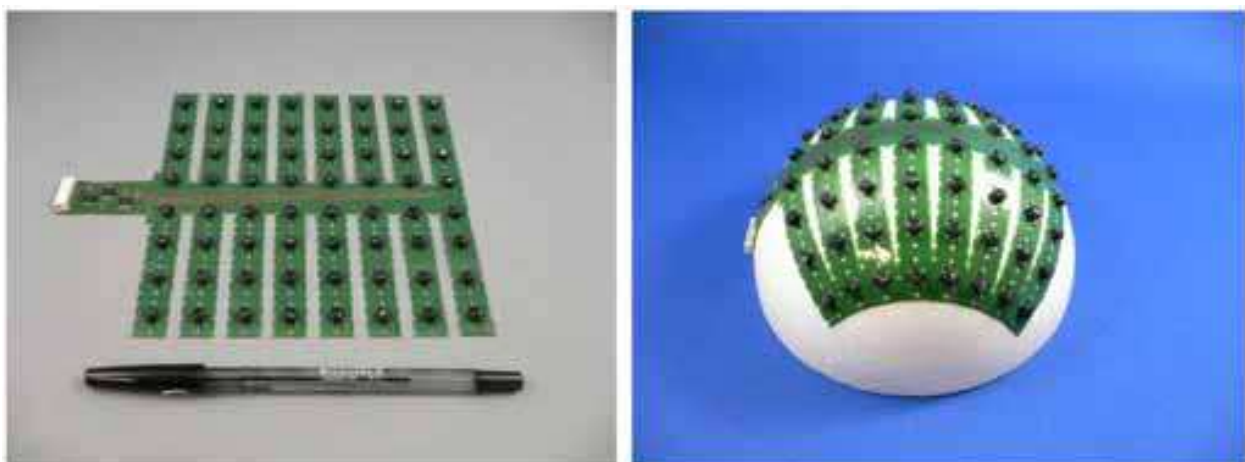

Fig. 10. Tactile sensors for the RI-MAN humanoid robot (Mukai, 2008).

In the robot ARMAR-III (Asfour et al., 2006), Figure 11, developed by Prof. Dillmann and his team, the idea of skin patches, based on piezo-resistive matrices of sensors, with embedded data processing electronics has been successfully implemented. Embedded electronics



provides local tactile data processing in order to limit the bandwidth requirements. The patches are custom designed and have flat or cylindrical shape in 3D for covering relevant parts of the robot arms, while smaller patches are used to sensorize the fingers.



Fig. 11. The Humanoid robot ARMAR-III (Asfour et al., 2006).

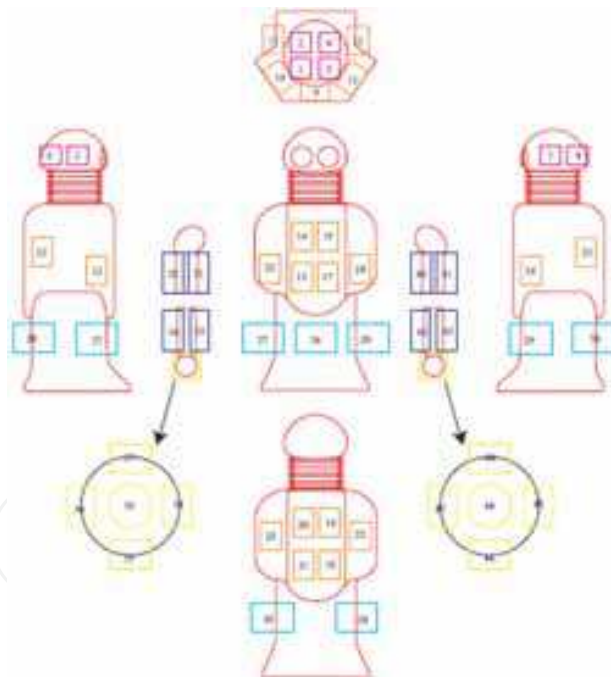

Fig. 12. Arrangement of tactile sensor in Robovie-IIS (Tajika et al. 2006).

Another example of artificial skin system for a humanoid robot has been proposed by Tajika et al. (Tajika et al. 2006) and implemented in the Robovie-IIS, Figure 13.

The tactile sensors have been designed with the aim of detecting stimuli coming from people trying to interact with the robot and it is based on PVDF based transducers. The skin has low spatial resolution (transducer area is of about 25 cm<sup>2</sup>), and it has the possibility of measuring only stimuli at frequencies higher than 5-10 Hz, Figure 12.



Fig. 13. The humanoid robot Robovie-IIS (Tajika et al. 2006). Robovie-IIS has been developed by ATR.

A similar solution has been adopted in the CB2 humanoid robot (Minato et al., 2007). The robot it has humanlike appearance similar to a child-size boy. It is about 130cm high and weights about 33kg. Tactile sensing is obtained by embedding small thin PVDF films beneath the skin. The system is not modular, i.e. the transducers are placed ad-hoc over the robot body. The output is proportional to the rate of change of bending (deformation rate). The information equivalent to a contact force is obtained by temporal integration of sensor output. The transducers are put between a layer of urethane foam covering the mechanical parts and the outer silicone skin. On the robot there are 197 sensors providing output at a frequency of 100 Hz, Figure 15.



Fig. 14. Tactile sensor layout of robot CB2 (Minato et al., 2007). CB2 has been developed by JST ERATO Asada Synergistic Intelligence Project

Finally, Kotaro (Mizuuchi et al, 2006), is a very complex musculo-skeletal humanoid robot where tactile sensing is obtained using flexible with *bandages* formed by two flexible printed circuit boards with a intermediate layer of pressure-sensitive conductive rubber forming 64 taxels. The sensor can match complex shape surfaces.

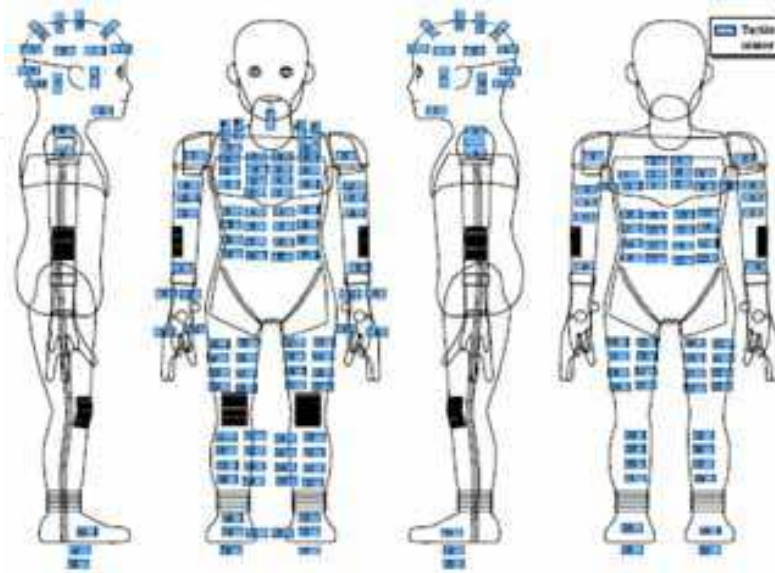

Fig. 15. Humanoid robot CB2 (Minato et al., 2007).

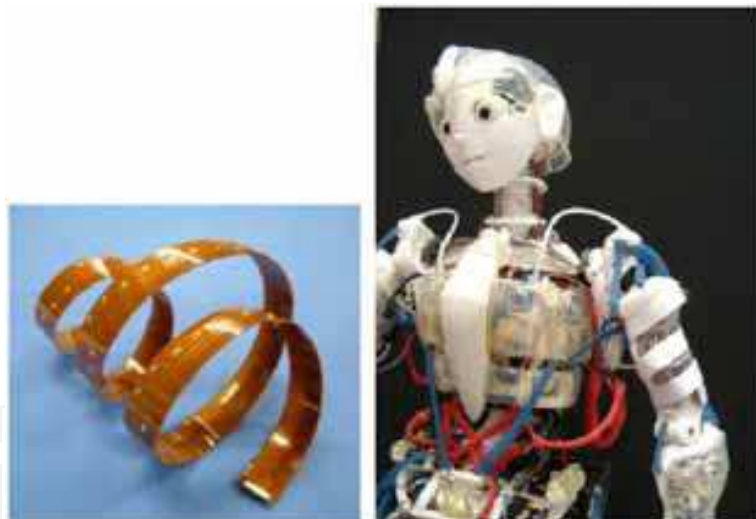

Fig. 16. Musculoskeletal humanoid Kotaro and the bandage tactile sensors (Mizuuchi et al, 2006).

### 3. Tactile/force sensor design<sup>1</sup>

In this section we describe the prototype of a modular tactile and force sensor for a robot hand. The system is modular and the same design has been used to develop all the sensor used in different parts of the hand. Each module is composed by : a three-axis commercial force sensor(CTS 109 from CTS Corporation), a flexible tactile array based on piezo-resistive

<sup>1</sup> This section is based on the work published in (Cannata & Maggiali, 2006).

transducer and a data acquisition and processing unit consisting of analog signal conditioning electronics, a microcontroller (MCU), and communication interface, (Cannata & Maggiali 2005), Figure 17.

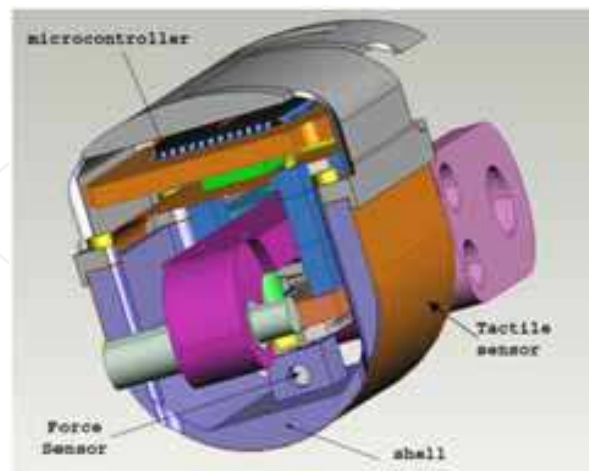

Fig. 17. CAD model of the whole phalange, with the force sensor, the tactile transducer and MCU board.

These modules are implemented on three different printed circuit boards (PCBs), as sketched in Figure 17. The first board supports the force sensor, rigidly connected with the phalange's *shell*, and its differential amplifiers. The tactile sensor module is a matrix of 64 taxels, supported by a double layer flexible PCB (flex-PCB), conformed to the finger cover. Finally, a third PCB hosts the MCU for local data processing and a CAN transceiver for communications. The whole tactile sensing system is scalable as several modules can be interconnected using a CAN bus link.

The current prototype has been designed to be integrated on each phalange of the robot MAC-HAND, Figure 18 .



Fig. 18. The MAC-HAND robot.

### 3.1 Force sensor

The force sensor used is a CTS Series 109 integrated micro joystick (CTS Corporation, see for detailed specifications). This component has good sensitivity and linearity, furthermore, its SMD packaging makes its embedding and integration with other electronics much simpler than using a strain-gauge based design.



Output Linearity	1.0%
X, Y Axis Output Characteristics	$0.85\mu V/V/g$
Z Axis Output Characteristics	$0.125\mu V/V/g$
Maximum Overload Force	40N
Dimensions	$10 \times 7.5 \times 5.5mm$

Table 1. Specifications of the force sensor (CTS Series 109).

### 3.2 Tactile sensor

The tactile transducer is a matrix of electrodes ( $8 \times 8$  taxels in the current implementation), covered by a layer of pressure sensitive conductive rubber (PCR Co. Ltd.). The electrodes are etched on a flex-PCB, in order to conform to a curved surface, Figure 19b. A thin elastic sheet covers the whole sensor and provides a mild pre-load useful to reduce noise. Pressure due to contacts changes the resistance among the electrodes, and can be measured with a resistive voltage divider. The scanning of the whole tactile matrix is performed using the scheme shown in Figure 20, where the columns are directly selected and driven by digital output ports of the embedded MCU, while rows are selected using a low noise and low onresistance analog multiplexer, followed by a low pass active filter. Ideally, the scanning of a resistive tactile matrix should follow the *zero potential method* (Hillis 1982); in order to obtain fully decoupled measurements. This method requires that during scanning the taxels belonging to column  $i$ , all the other columns are set to ground (Shimoyo et al 2004). This approach has a major drawback since the driving electronics is too complex to be integrated

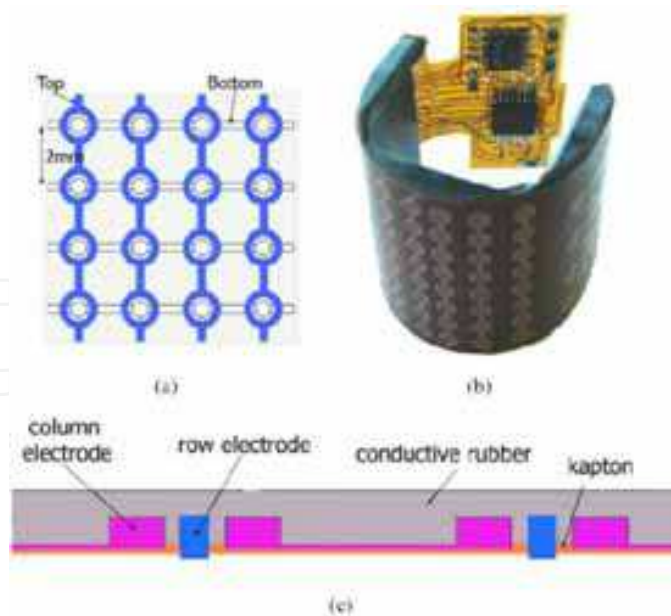

Fig. 19. The electrodes of the tactile sensor are etched on a double layer flex-PCB, and are connected in a matrix configuration (fig. a). The flex circuit conforms to the cylindrical phalange rigid cover (fig. b - resistive rubber not shown here). Fig. c: section view of the tactile sensor. Row electrodes are *encircled* by column electrodes.



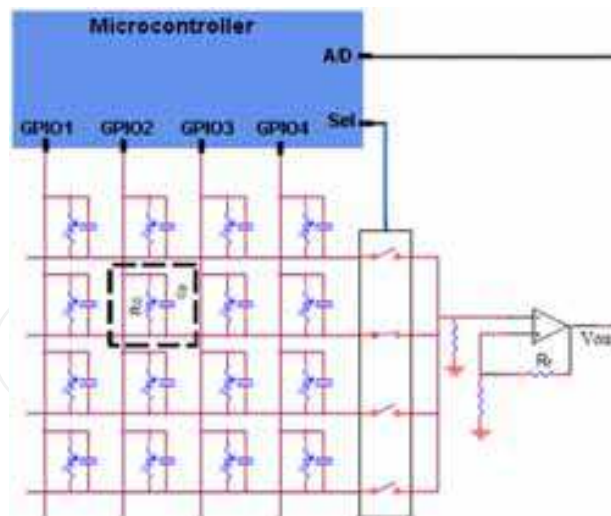

Fig. 20. Scanning Circuit Scheme

in a small volume. Therefore, in order to reduce the effects of cross-coupling among the taxels, two combined techniques have been adopted in our design. First of all, a careful definition of the geometry of the electrodes has been adopted, Figure 19a, with the goal of limiting the *parasitic* currents across the various taxels along one direction. Secondly, by exploiting the linearity of the resistive circuit characterizing the transducer, the crosscoupling is compensated performing a scanning of all the rows, keeping all the MCU driving outputs at low level. In this way, the effects of the parasitic injected currents in each column (due mainly to the characteristics of the MCU output ports) can be measured and subtracted by software from measurements obtained during the ordinary scan procedure. This method is in practice equivalent to measure data from a dummy column not providing any pressure measurements. This technique has a mild cost in term of scanning time, while the quality of the measurements is largely improved, as shown in Figure 21.

Signal conditioning is performed by using a first order active low pass filter placed on the sensor flex PCB and connected to the MCU.

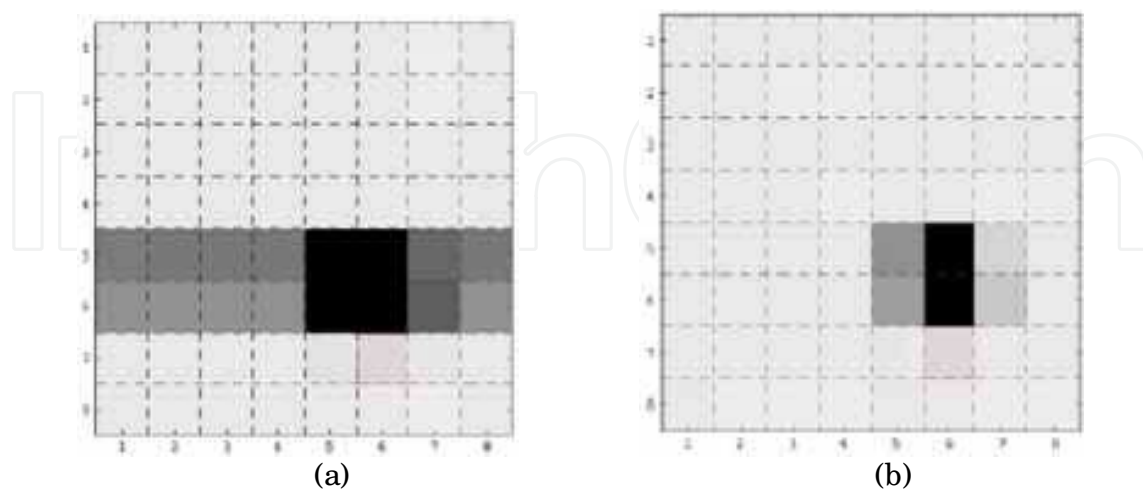

Fig. 21. The tactile image refers to a small cylindrical presser. Fig. a shows the measured pressure distribution using conventional matrix scan. Fig. b shows the tactile image obtained using the proposed compensation method, based on *dummy column method*, where the false pressure distribution has been removed.

#### 4. Local data processing

Tactile data are sampled by the on-board MCU, with a resolution of 8 bits. Each tactile image in the current prototype consists of 64 taxels requiring the transmission of 8 CAN messages (with full payload) for each module and then 64 messages for the whole hand MAC-HAND. The CAN 2.0A frame duration, operating at 1Mbit/sec, is nominally of 132  $\mu\text{sec}$ , therefore, the total minimum latency is of about 8.5 msec. This figure does not take into account possible bus access conflicts and therefore must be considered as an optimistic lower bound.

We proposed to reduce the amount of tactile data fed back to the controller using an approach inspired by the idea of *contact centroid* introduced in (Bicchi et al 1993). Let us assume that the contact between the sensor and an object, corresponds to a pressure distribution over a connected region. The distribution in general can be assumed to be a priori unknown and therefore could be modeled as a random one. Therefore, it is reasonable to associate the contact distribution (i.e. the tactile image), to statistic moments of first and second order. In particular, it is possible to define the *pressure centroid*  $x_c$  as follows:

$$\mathbf{x}_c = \frac{\sum_{i=1}^N \mathbf{x}_i p(\mathbf{x}_i)}{\sum_{i=1}^N p(\mathbf{x}_i)} \quad (1)$$

where  $\mathbf{x}_i$  is the position of each taxel in local surface coordinates,  $p(\mathbf{x}_i)$  is the corresponding measured pressure and  $N$  is the number of taxels of the sensor. The *shape* of the pressure distribution could be approximated as an ellipsoid, defined as follows:

$$E = \frac{\sum_{i=1}^N (\mathbf{x}_i - \mathbf{x}_c)(\mathbf{x}_i - \mathbf{x}_c)^T p(\mathbf{x}_i)}{\sum_{i=1}^N p(\mathbf{x}_i)} \quad (2)$$

where  $E$  is a positive semi-definite symmetric matrix.

*Remark 1:* The above quantities are valid for any sensor conforms to a regular surface.

Experimental tests, discussed in detail in the next section, have shown significant sensitivity of both  $\mathbf{x}_c$  and  $E$  to measurements noise, in particular for low values of pressure. In order to reduce the effects of noise with respect to the actual pressure values, formulas (1) and (2) have been modified as follows:

$$\mathbf{x}_c = \frac{\sum_{i=1}^N \mathbf{x}_i \bar{p}(\mathbf{x}_i)}{\sum_{i=1}^N \bar{p}(\mathbf{x}_i)} \quad (3)$$

$$E = \frac{\sum_{i=1}^N (\mathbf{x}_i - \mathbf{x}_c)(\mathbf{x}_i - \mathbf{x}_c)^T \bar{p}(\mathbf{x}_i)}{\sum_{i=1}^N \bar{p}(\mathbf{x}_i)} \quad (4)$$

where

$$\bar{p}(\mathbf{x}_i) = a p^n(\mathbf{x}_i) \quad i = 1 \dots N \quad (5)$$

with  $a$  and  $n$  suitable constants. The role of the non-linear transformation (5) is to increase the signal to noise ratio.

The above formulas are implemented locally on the embedded MCU. Assuming a data resolution of 8 bits using this method a single CAN message is sufficient to transmit the force measurement and contact centroid data. In fact 3 bytes are requested for force measurements, 2 for  $\mathbf{x}_c$  and 3 are sufficient for  $E$ . Of course, this condition would hold also for tactile sensors with a large number of taxels.

*Remark 2:* In the current implementation the tactile sensor covers an area of  $34 \times 20 \text{ mm}^2$ , then the pressure centroid can be computed with a spatial resolution approximately of less than  $0.15 \text{ mm}$ .

## 5. Experiments

The experiments presented in this section refer to a planar tactile matrix formed by  $8 \times 8$  taxels. The electronics used for data acquisition and processing is the same designed to be installed on the gripper MAC-HAND. The experiments have been performed using the test rig shown in fig. Figure 22. The characteristic response of each taxel has been obtained from experimental data using a least square cubic approximation, Figure 23. The experiment proposed consists of a pen pressed on the matrix. The tactile image as well as the computed pressure centroids and ellipsoids are shown in Figure 24. The time behavior of the sensor shows a mild creep of the stressed taxel, as well as the actual sensor noise, Figure 25. The computation of the centroids and the ellipsoids has an evident averaging effect, Figure 26 and Figure 27, with a better response using the non-linear algorithm (5).



Fig. 22. Test rig for sensor calibration and tests.

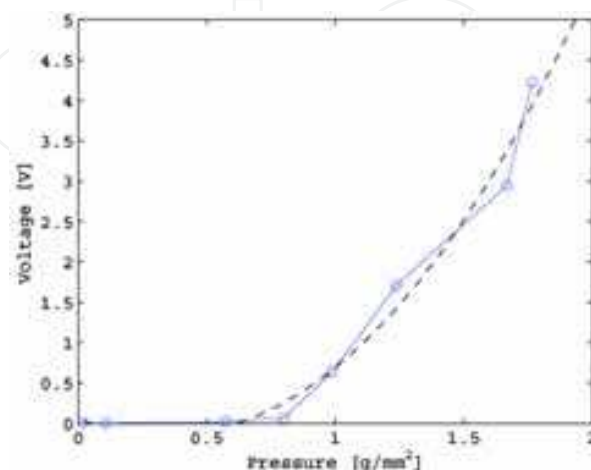

Fig. 23. Pressure to voltage ratio of a generic taxel. Dashed curve is the cubic that approximate the characteristics of the taxel

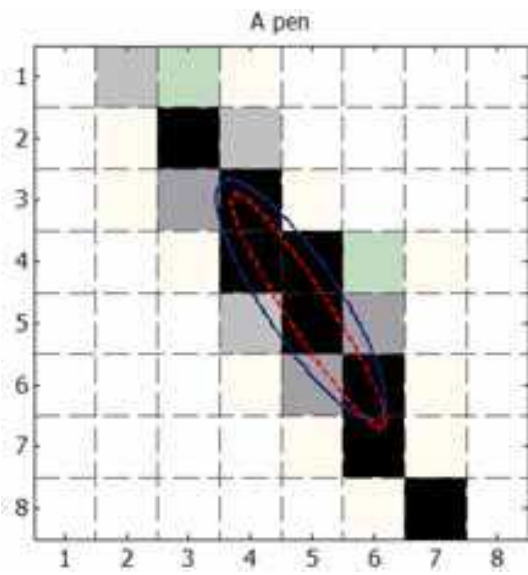

Fig. 24. Tactile image of a pressed pen.

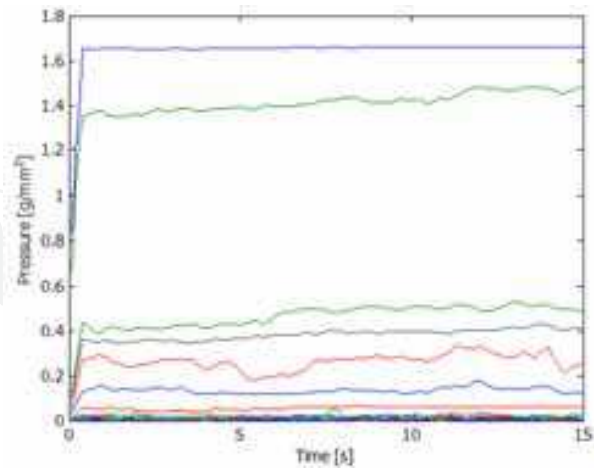
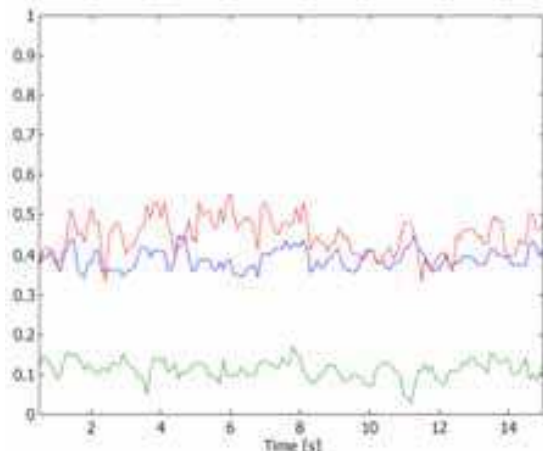
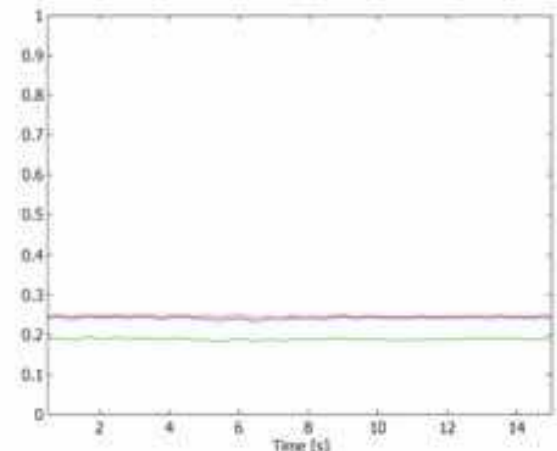

Fig. 25. Time behaviour of the taxels.



(a)



(b)

Fig. 26. Components of the matrix E as functions of time. Fig. a: without using transformation (5). Fig. b using transformation (5).

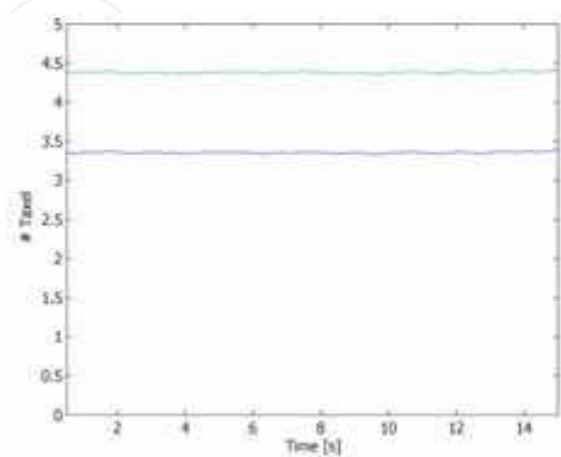
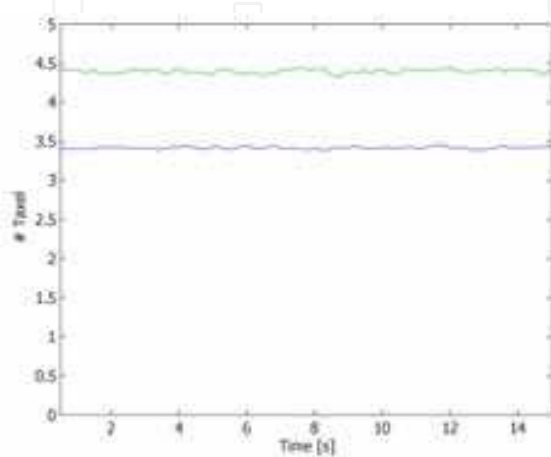

Fig. 27. Coordinates of the centroid as functions of time. Fig. a: without using transformation (5). Fig. b using transformation (5).

## 6. Conclusions

The use of skin like tactile sensors will play an important role for the development of humanoid robots performing complex interaction tasks possibly involving humans. In the first part of this chapter we have presented a survey of relevant recent achievements in the area of robot-skin technologies and tactile sensors for robot hand. In the second part an integrated tactile/ force sensor with embedded electronics has been presented. The sensor consists of a three components commercial force sensor and of a custom matrix tactile transducer based on pressure sensitive conductive rubber. The sensor is driven by a local embedded microcontroller which implements local algorithms for the processing of raw tactile data extracting relevant parameters related to the contact force distributions.

## 7. References

- Salisbury K., Mason M. T. (1985). *Robot Hands and the Mechanics of Manipulation*, M.I.T. Press. Cambridge, MA, ISBN-0-262-13205-2.
- Jacobsen. S. et al. (1986). Design of the Utah/ M.I.T. Dexterous Hand, *Proceedings of the IEEE International Conference on Robotics and Automation*, San Francisco CA. 1520-1532.
- Melchiorri, C., Vassura, G. (1992). Mechanical and Control Features of the University of Bologna Hand version 2, *IEEE Int. Conference of Intelligent Robots and Systems*, Raleigh (North Carolina), pp. 187-193.
- F.Lotti, P. Tiezzi, G. Vassura et al. (2004). UBH 3: can anthropomorphic hand with simplified endo-skeletal structure and soft continuous fingerpads, *IEEE International Conference on Robotics and Automation*, 26 April-1 May 2004 pp. 4736 - 4741.
- Butterfass, J., Grebenstein, M., Liu, H., Hirzinger, G. (2001). DLR-Hand II:Next Generation of a Dexterous Robot Hand, *Proc. IEEE Int. Conf. on Robotics and Automation*, Seoul, Korea.
- Carrozza, M. C., Vecchi, F., Roccella, S., Zecca, M., Sebastiani, F., Dario, P. (2003). The CyberHand: on the design of a cybernetic prosthetic hand intended to be interfaced to the peripheral nervous system, *IROS 2003 vol. 3*, Oct. 27-31, pp. 2642 - 2647.
- Kargov A., Pylatiuk C, Oberle R., Klosek H., Schulz S., Bretthauer G. (2005). Development of an Anthropomorphic Hand for a Mobile Assistive Robot, *ICORR 2005*, Chicago.
- Caffaz A., Cannata G. (1998). The Design and Development of the DIST-Hand Dexterous Gripper, *1998 IEEE ICRA*, Leuven, Belgium, pp. 2075-2080.
- Lane D., Cannata G. et al. (1997). AMADEUS: Advanced Manipulation for Deep Underwater Sampling, *Robotics and Automation Magazine*.
- Hashimoto H., Ogawa H., Umeda T., Obama M., Kyoichi Tatsuno (1995). An Unilateral Master-Slave Hand System with a Force-controlled Slave Hand, *IEEE International Conference of Robotics and Automation*.
- Shimojo, M. (2004). A Tactile Sensor sheet using pressure conductive rubber with electrical wires stitched method, *IEEE Sensor Journal*, vol. 4, no. 5.
- Krishna, G. M., Rajanna, K. (2002). Tactile sensor based on piezoelectric resonance, *Sensors*, Volume: 2, 1643- 1647 vol.2.
- Yamada, K., Goto, K., Nakajima, Y. , Koshida, N., and Shinoda, H. (2002). A Sensor Skin Using Wire-Free Tactile Sensing Elements Based on Optical Connection, *Sice*, Volume: 1, 131- 134, vol. 1.
- Engel J, Chen J, Chang L, Flachsbarth B. R., Selby, J C., Shannon, M. A. (2003). Development of Polyimide-based Flexible Tactile Sensing Skin, *Mat. Res. Soc. Symp. Proc.* vol. 736.



- Cannata, G., Maggiali, M. (2005). An Embedded Tactile and Force Sensor for Robotic Manipulation and Grasping, Proceeding of IEEE-RAS International Conference on Humanoid Robots, Humanoids 2005, Tsukuba (Japan), Dec. 2005.
- Hillis, W. D. (1982). A high-resolution imaging touch sensor, *International Journal Robot. Res.*, vol. 1, no. 2, pp. 33-44.
- Verssimo, P., Rufino J, Ming. L. (1997). How hard is hard real-time communication on fieldbuses?, Digest of Papers of the 27th IEEE International Symposium on Fault-Tolerant Computing Systems June 1997, Seattle, Washington, USA
- Liu, H., Meusel, P., Hirzinger G.A. (1995). A Tactile sensing System for the Three-Finger Robot Hand, International Symposium on DLR Measurement and Control in Robotics, pp. 91-96, 1995.
- Kawasaki H., Komatsu T., and Uchiyama K. (2002). Dexterous Anthropomorphic Robot Hand With Distributed Tactile Sensor: Gifu Hand II, *IEEE/ASME Transactions on Mechatronics*, VOL. 7, NO. 3, pp. 296-303, September 2002.
- Martin T. B., Ambrose R. O., M. A. Diftler et al. (2004). Tactile Gloves for Autonomous Grasping with the NASA/ DARPA Robonaut, Proc. 2004 IEEE Int. Conf. on Robotics and Automation, New Orleans (LA), April 2004, pp. 1713-1718.
- Mukai T., Onishi M., Odashima T., Hirano S., and Luo Z. (2008). Development of the Tactile Sensor System of a Human-Interactive Robot “RI-MAN”, *IEEE Transactions on Robotics*, VOL. 24, NO. 2, APRIL 2008, pp. 505-512.
- Tajika, T., Miyashita, T., Ishiguro, H. et al. (2006). Automatic Categorization of Haptic Interactions-What are the Typical Haptic Interactions Between a Human and a Robot?, Proceeding of IEEE-RAS International Conference on Humanoid Robots, Humanoids 2006, Genova, 4-6 December 2006.
- Bicchi. A, J.K. Salisbury and D.L. Brock, (1993). Contact Sensing from Force Measurements, *International Journal of Robotics Research*, v. 12, n. 3, pp. 249-262, June.
- T. Mouri, H. Kawasaki, K. Yoshikawa, J Takai and S. Ito (2002). Anthropomorphic robot hand: Gifu Hand III, ICCAS, 16-19, Muju Resort, Jeonbuk, Korea, October 2002.
- D. Urn, V. Lumelsky, (1999). Fault Tolerance via Analytic Redundancy for a Modularized Sensitive Skin, Proceedings of the 1999 IEEVRSJ International Conference on Intelligent Robots and Systems, pp.1191-1197 vol.2, Kyongju, South Korea.
- Lumelsky, V.J, Shur, M.S.; Wagner, S., (2001). Sensitive Skin, *Sensors Journal*, IEEE, Volume 1, Issue 1, June 2001 Page(s):41 – 51.
- A.Billard, R. Siegwart (2004). Robot learning from demonstration, *Journal of Robotics and Autonomous Systems*, vol. 47 (2004) 65–67.
- T. Minato, Y. Yoshikawa, T. Noda, S. Ikemoto, H. Ishiguro and M. Asada (2007). CB2: A Child Robot with Biomimetic Body for Cognitive Developmental Robotics, IEEEERAS 7th International Conference on Humanoid Robots, November 29-December 1, Pittsburg, Pennsylvania USA 2007.
- I. Mizuuchi, T. Yoshikai, Y. Sodeyama, Y. Nakanishi, A. Miyadera, T. Yamamoto, T. Niemel, M. Hayashi, J Urata, Y. Namiki, T. Nishino and M. Inaba, (2006). Development of Musculoskeletal Humanoid Kotaro, Proceedings of the 2006 IEEE International Conference on Robotics and Automation, Orlando, Florida - May 2006
- Cannata G., Maggiali M. (2006). Processing of Tactile/ Force Measurements for a Fully Embedded Sensor, International Conference on Multisensor Fusion and Integration for Intelligent Systems September 3-6, 2006, Heidelberg, Germany



### **Sensors: Focus on Tactile Force and Stress Sensors**

Edited by Jose Gerardo Rocha and Senentxu Lanceros-Mendez

ISBN 978-953-7619-31-2

Hard cover, 444 pages

**Publisher** InTech

**Published online** 01, December, 2008

**Published in print edition** December, 2008

This book describes some devices that are commonly identified as tactile or force sensors. This is achieved with different degrees of detail, in a unique and actual resource, through the description of different approaches to this type of sensors. Understanding the design and the working principles of the sensors described here requires a multidisciplinary background of electrical engineering, mechanical engineering, physics, biology, etc. An attempt has been made to place side by side the most pertinent information in order to reach a more productive reading not only for professionals dedicated to the design of tactile sensors, but also for all other sensor users, as for example, in the field of robotics. The latest technologies presented in this book are more focused on information readout and processing: as new materials, micro and sub-micro sensors are available, wireless transmission and processing of the sensorial information, as well as some innovative methodologies for obtaining and interpreting tactile information are also strongly evolving.

#### **How to reference**

In order to correctly reference this scholarly work, feel free to copy and paste the following:

Giorgio Cannata and Marco Maggiali (2008). Design of a Tactile Sensor for Robot Hands, Sensors: Focus on Tactile Force and Stress Sensors, Jose Gerardo Rocha and Senentxu Lanceros-Mendez (Ed.), ISBN: 978-953-7619-31-2, InTech, Available from: [http://www.intechopen.com/books/sensors-focus-on-tactile-force-and-stress-sensors/design\\_of\\_a\\_tactile\\_sensor\\_for\\_robot\\_hands](http://www.intechopen.com/books/sensors-focus-on-tactile-force-and-stress-sensors/design_of_a_tactile_sensor_for_robot_hands)

**INTECH**  
open science | open minds

#### **InTech Europe**

University Campus STeP Ri  
Slavka Krautzeka 83/A  
51000 Rijeka, Croatia  
Phone: +385 (51) 770 447  
Fax: +385 (51) 686 166  
[www.intechopen.com](http://www.intechopen.com)

#### **InTech China**

Unit 405, Office Block, Hotel Equatorial Shanghai  
No.65, Yan An Road (West), Shanghai, 200040, China  
中国上海市延安西路65号上海国际贵都大饭店办公楼405单元  
Phone: +86-21-62489820  
Fax: +86-21-62489821

© 2008 The Author(s). Licensee IntechOpen. This chapter is distributed under the terms of the [Creative Commons Attribution-NonCommercial-ShareAlike-3.0 License](#), which permits use, distribution and reproduction for non-commercial purposes, provided the original is properly cited and derivative works building on this content are distributed under the same license.

IntechOpen

IntechOpen