

We are IntechOpen, the world's leading publisher of Open Access books Built by scientists, for scientists

4,800

Open access books available

122,000

International authors and editors

135M

Downloads

Our authors are among the

154

Countries delivered to

TOP 1%

most cited scientists

12.2%

Contributors from top 500 universities



WEB OF SCIENCE™

Selection of our books indexed in the Book Citation Index
in Web of Science™ Core Collection (BKCI)

Interested in publishing with us?
Contact book.department@intechopen.com

Numbers displayed above are based on latest data collected.

For more information visit www.intechopen.com



Multi Sensor Data Fusion Architectures for Air Traffic Control Applications

Baud Olivier, Gomord Pierre, Honoré Nicolas,
Ostorero Loïc, Taupin Olivier and Tubery Philippe
THALES Air Systems
France

1. Introduction

Nowadays, the radar is no longer the sole technology which is able to ensure the surveillance of air traffic. The extensive deployment of satellite systems and air-to-ground data links leads to the emergence of complementary means and techniques on which a great deal of research and experiments have been carried out over the past ten years.

In such an environment, the sensor data processing, which is a key element in any Air Traffic Control (ATC) centre, has been continuously upgraded so as to follow the sensor technology evolution and in the meantime improves the quality in term of continuity, integrity and accuracy criteria.

This book chapter proposes a comprehensive description of the state of art and the roadmap for the future of the multi sensor data fusion architectures and techniques in use in ATC centres.

The first part of the chapter describes the background of ATC centres, while the second part of the chapter points out various data fusion techniques. Multi radar data processing architecture is analysed and a brief definition of internal core tracking algorithms is given as well as a comparative benchmark based on their respective advantages and drawbacks.

The third part of the chapter focuses on the most recent evolution that leads from a Multi Radar Tracking System to a Multi Sensor Tracking System.

The last part of the chapter deals with the sensor data processing that will be put in operation in the next ten years. The main challenge will be to provide the same level of services in both surface and air surveillance areas in order to offer:

- highly accurate air and surface situation awareness to air traffic controllers,
- situational awareness via Traffic Information System - Broadcast (TIS-B) services to pilots and vehicle drivers, and
- new air and surface safety, capacity and efficiency applications to airports and airlines.

2. Air traffic control

Air Traffic Control (ATC) is a service provided to regulate the airline traffic. Main functions of the ATC system are used by controllers to (i) avoid collisions between aircrafts, (ii) avoid collisions on manoeuvring areas between aircrafts and obstructions on the ground and (iii) expediting and maintaining the orderly flow of air traffic.

Source: Sensor and Data Fusion, Book edited by: Dr. ir. Nada Milisavljević,
ISBN 978-3-902613-52-3, pp. 490, February 2009, I-Tech, Vienna, Austria

An ATC system shall adapt itself to the control context, determined by the airspace to be controlled:

- en-route area: control of aircrafts located at a high and medium altitude,
- terminal / approach areas: terminal area is restricted to major airports while approach area is dedicated to align aircrafts at arrival or in departure in order to pave their way for the Flight Information Region (FIR),
- runways / ground areas: management of aircrafts on airports and on ground between runways and taxiways.

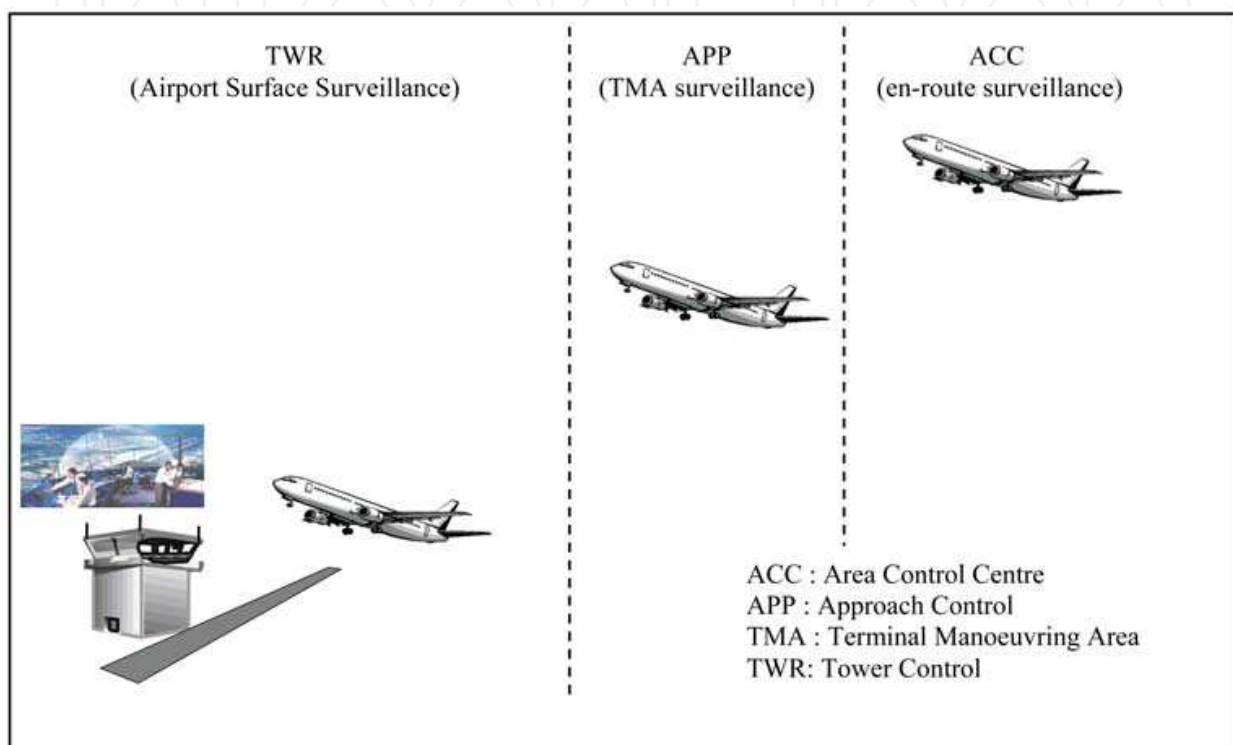

Fig. 1. Air Traffic Control principal areas of applications

In order to be efficient in all the above mentioned situations, the system shall be adaptable and shall be completed by several other sub-systems in order to face:

- differences in aircraft evolution: trajectory for en-route aircraft is more stable than trajectory of an aircraft in terminal area,
- great variety of separation norms: in en-route area for example, the required accuracy for the aircraft positioning is less important than in terminal area,
- failure importance: the loss of radar picture is more important in terminal area than in en-route area where aircrafts are less close to each another.

2.1 ATC system

Automatic air traffic management control systems implement main ATC functions which address related ATC services. ATC functions are adaptable to the following rules:

- operational control: real traffic control,
- test and evaluation: all sub-systems are tested and operationally validated (shadow procedures),
- training: training of air traffic controllers on simulated air traffic. All external actors are simulated (i.e. radars, foreign centres, etc.)

- archiving, replay and visualization for legal reasons (accidents, failures, etc.) but also to evaluate the tax amount imposed to the airlines.

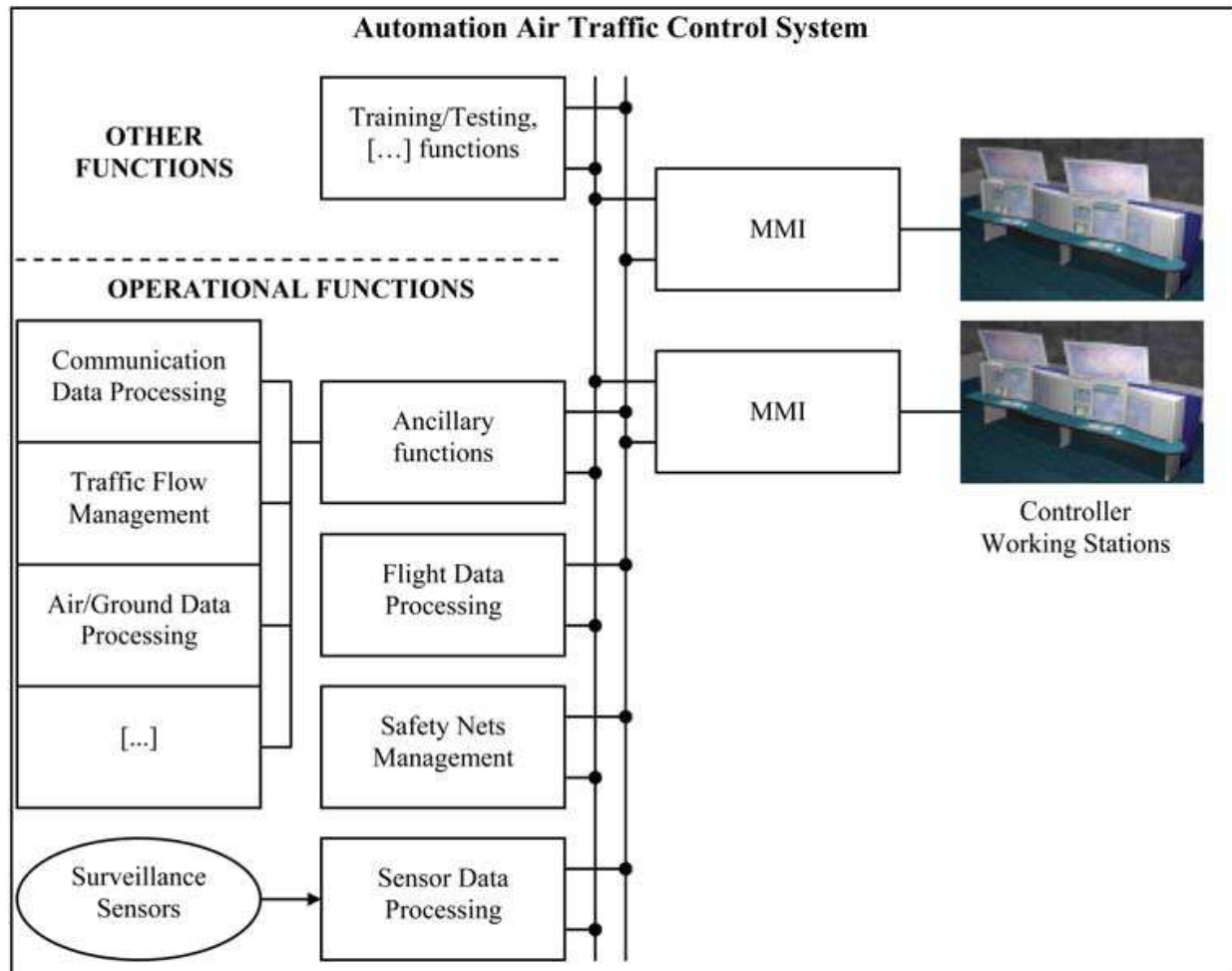

Fig. 2. Automation ATC System synoptic

2.2 ATC system services

2.2.1 Airspace surveillance service

Surveillance is a key function for airspace management and supports both strategic separation assurance of aircraft and strategic planning of traffic flows.

2.2.2 Ground surveillance service

Aircrafts movements on the ground are managed mainly by an A-SMGCS (Advanced Surface Movement Guidance and Control System), depending on the traffic density of an airport.

This system receives information coming from all available sensors (notably from primary surface radar, multilateration, ADS-B and mode S radar) and then processes them into its own fusion module before displaying these data on a specific visualization. This system is able to provide with proximity alerts function (control) and aircraft trajectories optimisation (movement guidance).

This system shall also detects vehicles which are located on runways and tarmacs areas: for this purpose they are equipped with specific beacons.

2.2.3 Sensor data processing systems

An ATC automation centre shall take into account data which are sent by numerous surveillance sensors. The rule of a tracking system is then to process and to unify all data, in order to provide a fused information to the visualisation and the safety nets systems.

2.2.4 Safety nets management and separation assurance

The surveillance function provides with current aircraft state information to the controller position and to the separation automation functions, i.e. the short term conflict alert (STCA) system for the detection of immediate path conflicts and the Minimum Safe Altitude Warning (MSAW) system for the detection of potential flight into terrain. These automation functions require enhanced surveillance in order to provide with accurate and reliable path predictions for medium term look ahead periods.

2.2.5 Visualization systems

A visualization system shows the air situation picture to the controller. The presentation of the information regarding an aircraft shall comply with restricted rules. The following elements are shown on the display:

- a symbol corresponding to the current position and the type of sensor detection,
- other symbols associated to the past-time positions,
- an optional speed vector oriented depending on the course and whose length is proportional to the ground speed,
- a customisable label showing aircraft information: Mode 3/A, Mode C, ground speed, Flight Plan information, etc.

2.2.6 Flight data processing services

The Flight Data Processing management service contains all the sub-systems in charge of the flight plan life management (including its modifications and its distribution to other sub-systems).

2.3 Surveillance sensors

Surveillance sensors are at the beginning of the chain: the aim of these systems is to detect the aircrafts and to send all the available information to the tracking systems.

Current surveillance systems use redundant primary and secondary radars. The progressive deployment of the GPS-based ADS systems shall gradually change the role of the ground based radars. The evolution to the next generation of surveillance system shall also take into account the interoperability and compatibility with current systems in use.

The figure 3 shows a mix of radar, ADS and Multilateration technologies which will be integrated and fused in ATC centres in order to provide with a high integrity and high accuracy surveillance based on multiple sensor inputs.

2.3.1 Primary Surveillance Radar (PSR)

Primary radars use the electromagnetic waves reflection principle. The system measures the time difference between the emission and the reception of the reflected wave on a target in order to determine its range. The target position is determined by measuring the antenna azimuth at the time of the detection.

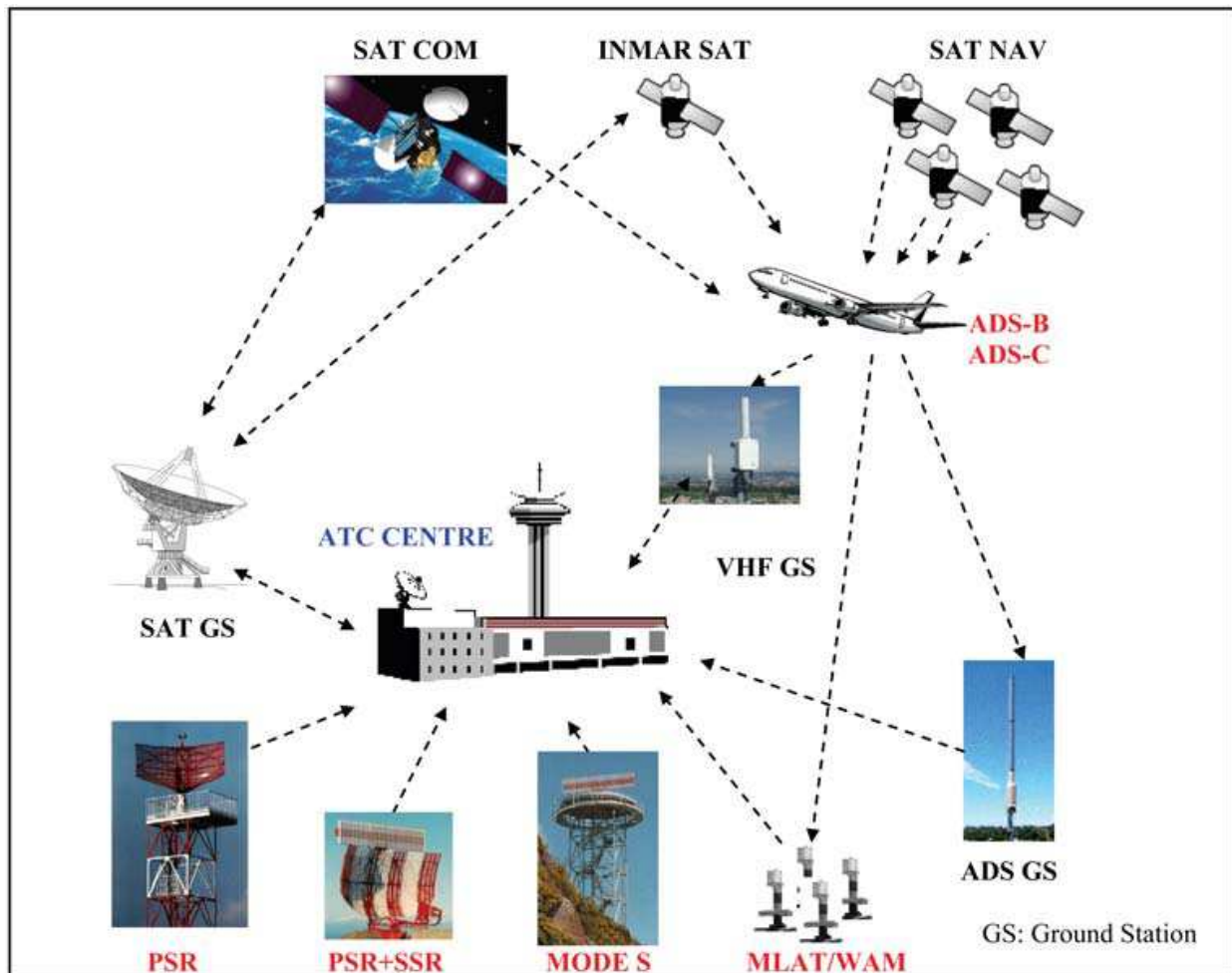

Fig. 3. Surveillance sensor environment

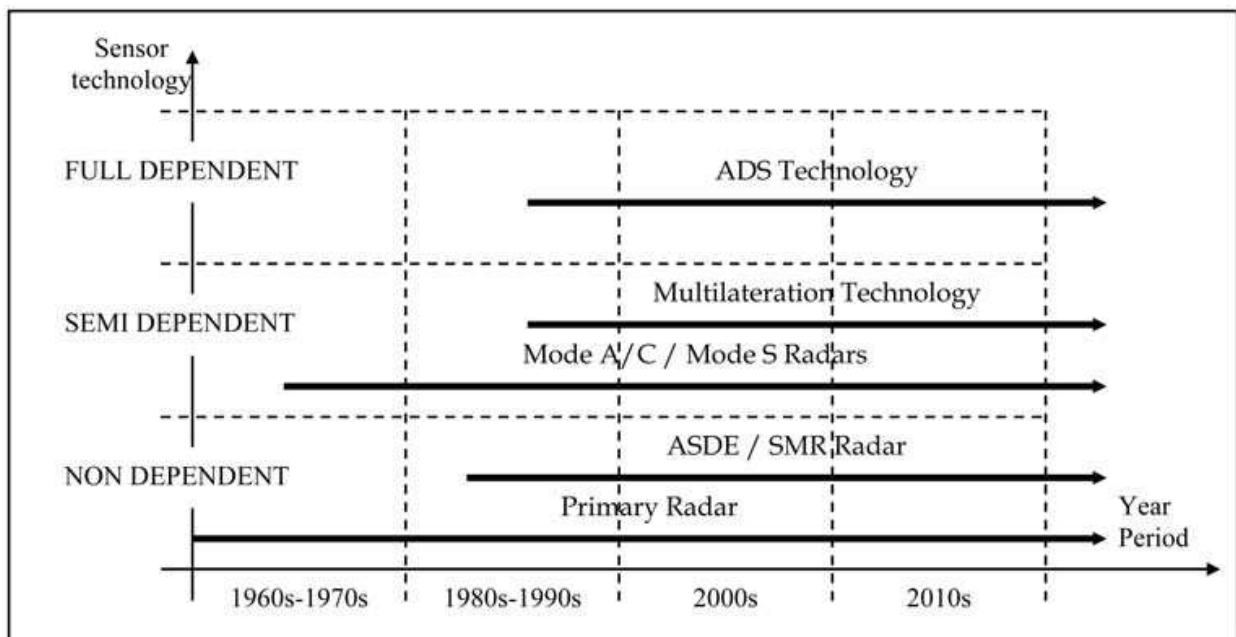

Fig. 4. Historical perspective of surveillance sensor technology

Reflections occur on the targets (i.e. aircrafts) but unfortunately also on fixed objects (buildings) or mobile objects (trucks). These kind of detections are considered as parasites and the “radar data processing” function is in charge of their suppression.

The primary surveillance technology applies also to Airport Surface Detection Equipment (ASDE) and Surface Movement Radar (SMR).

2.3.2 Secondary Surveillance Radar (SSR)

Secondary Surveillance Radar includes two elements: an interrogative ground station and a transponder on board of the aircraft. The transponder answers to the ground station interrogations giving its range and its azimuth.

The development of the SSR occurs with the use of Mode A/C and then Mode S for the civil aviation.

Mode A/C transponders give the identification (Mode A code) and the altitude (Mode C code). Consequently, the ground station knows the 3-dimension position and the identity of the targets.

Mode S is an improvement of the Mode A/C as it contains all its functions and allows a selective interrogation of the targets thanks to the use of an unique address coded on 24 bits as well as a bi-directional data link which allows the exchange of information between air and ground.

2.3.3 Multilateration sensors

A multilateration system is composed of several beacons which receive the signals which are emitted by the aircraft transponder. The purpose is still to be able to localize the aircraft. These signals are either unsolicited (squitters) or answers (SSR or Mode S) to the interrogations of a nearby radar. Localization is performed thanks to the Time Difference Of Arrival (TDOA) principle. For each beacons pair, hyperbolic surfaces whose difference in distance to these beacons is constant are determined. The aircraft position is at the intersection of these surfaces.

The accuracy of a multilateration system depends on the geometry of the system formed by the aircraft and the beacons as well as the precision of the measurement time of arrival.

Nowadays, multilateration is used mainly for ground movement's surveillance and for the airport approaches (MLAT). Its use for en-route surveillance is on the way of deployment (Wide Area Multilateration (WAM)).

2.3.4 Automatic Dependant Surveillance – Contract (ADS-C)

The aircraft uses its satellite-based or inertial systems to determined and send to the ATC centre its position and any other information as:

- aircraft position,
- expected road,
- ground/air speeds
- Meteo data (wind direction and speed, temperature, etc).

ADS-C information are transmitted through point-to-point communications via VHF or via satellite. Ground and on-board equipments managed the transmit conditions (periodical, on event, on emergency, ...)

ADS-C is used typically on desert or oceanic areas as radars cannot insure any surveillance on those areas.

2.3.5 Automatic Dependant Surveillance – Broadcast (ADS-B)

The aircraft uses its satellite-based or inertial systems to determine and send to the ATC centre its position and other sort of information. Aircraft position and speed are transmitted one time per second at least.

ADS-B messages (squitters) are sent, contrary to ADS-C messages which are transmitted via a point-to-point communication. By way of consequence, the ADS-B system is used both for ATC surveillance and on-board surveillance applications.

2.3.6 Respective advantages and drawbacks

Sensor type	Advantages	Drawbacks
Primary radar (Non-dependant surveillance sensor)	Non cooperative targets detection as no on-board equipment is required. Can be used for ground surveillance. High data integrity level.	Targets cannot be identified. Target altitude cannot be determined. High power emission is required which limits its range. High latency and low update rate.
Secondary radar (Semi-dependant surveillance sensor)	Identity and altitude determination as well as range and azimuth. Less sensitive to interferences than primary radar. Its range is more important than the primary radar as the interrogation and the answer have only one-way distance to cover. Mode S introduces the air-to-ground data link. Medium data integrity level.	Does not work for the ground surveillance due to the loss of accuracy introduced by the delay of the transponder processing. Mode A/C has a lot of issues related to the question/answer confusion. Mode S solves this problem by interrogating the targets in a selective manner. High latency and low update rate.

Table 1. Past and current technology sensor advantages and drawbacks

Sensor type	Advantages	Drawbacks
Multilateration (Semi-dependant surveillance sensor)	SSR technology can be used (does not need any evolution of on-board equipments). Suitable for ground surveillance: needs Mode S equipment as Mode A/C transponders are deactivated mainly on ground in order to limit radio pollution. Small latency. High update rate. Position accuracy.	Signals shall be received correctly by 4 beacons at least which raise the issue of beacons location, especially for en-route surveillance.

Sensor type	Advantages	Drawbacks
ADS-C (Full-dependant surveillance sensor)	Use of surveillance area with no radar coverage. Information "expected road" available. Air/ground data link available.	Depends only on the aircraft (equipped or not) and on the data correction that it sends. Time stamping errors. Very low update rate. GPS outages.
ADS-B (Full-dependant surveillance sensor)	Use for ATC and for on-board surveillance applications. High refresh rate (1s at least). Air/ground data link available. Small latency. High update rate. Position accuracy.	Depends on the aircraft only (equipped or not) and on the data correction which is sent. Not all the aircrafts are equipped at this time. Time stamping errors. GPS outages.

Table 2. New and emerging sensor technology advantages and drawbacks

2.3.7 Sensor data processing

As shown in figure 5 hereunder, a sensor data processing is composed generally of two redundant trackers. Radar (including Surface Movement Radar) and ADS-C data are received directly by the trackers while ADS-B and WAM sensor gateways help in reducing the data flow as well as checking integrity and consistency.

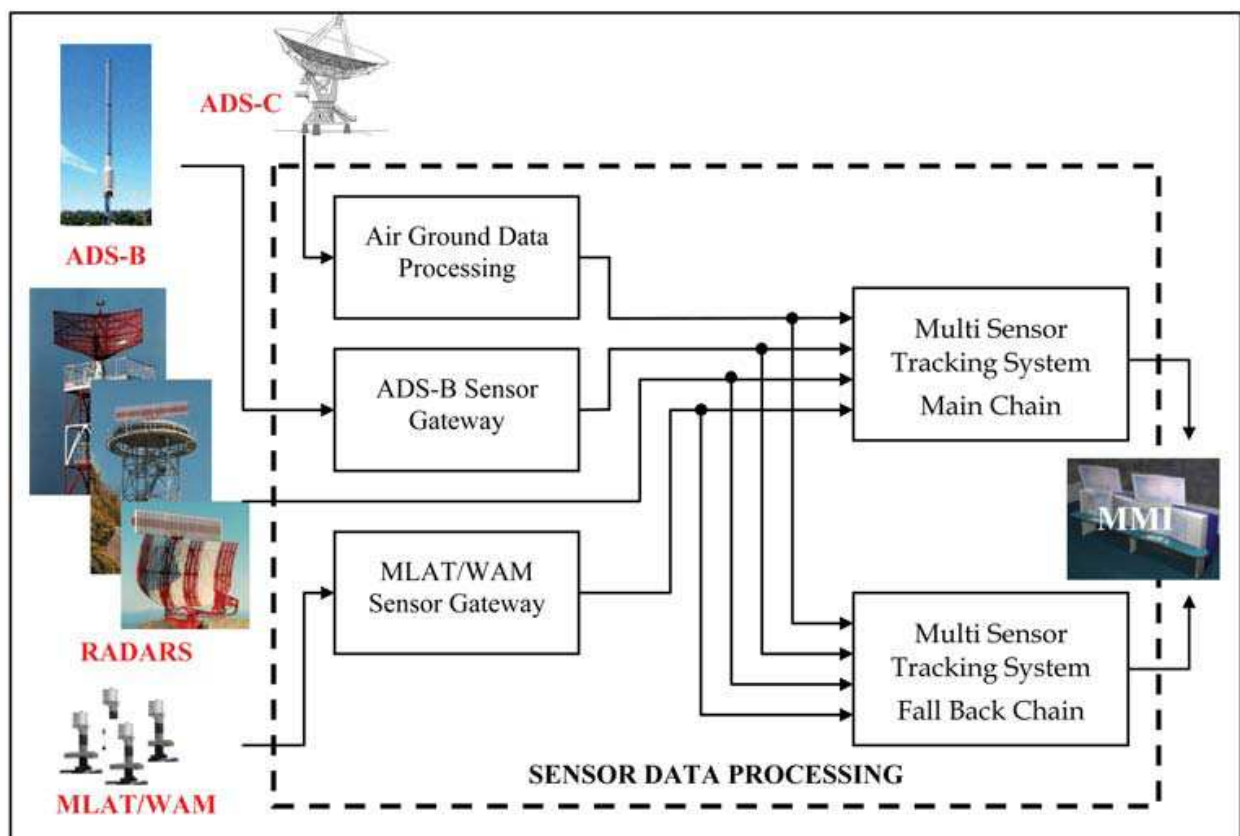

Fig. 5. Sensor Data Processing

As shown in figure 5 above, trackers are potentially redundant in order to prevent from sub-systems failure.

3. Sensor data processing architectures

3.1 Data fusion techniques

This paragraph presents the data fusion techniques for radar data processing.

3.1.1 Introduction

Several level of data fusion are available:

- plots (radar reports are directly used into the fusion module),
- tracks (radar reports are used to update local radar tracks which are used into the fusion module),
- mixture between tracks and plots,
- signals (research area).

Several techniques using various level of data fusion are analysed in this paragraph.

Multi radar tracking establishes one track per aircraft which is common to all radars. A great number of methods have been used in ATC centres. These methods can be divided into two main categories:

- selection techniques and
- average or weighted techniques.

An historical perspective of data fusion techniques which have been used in ATC centres is proposed on figure 6 below.

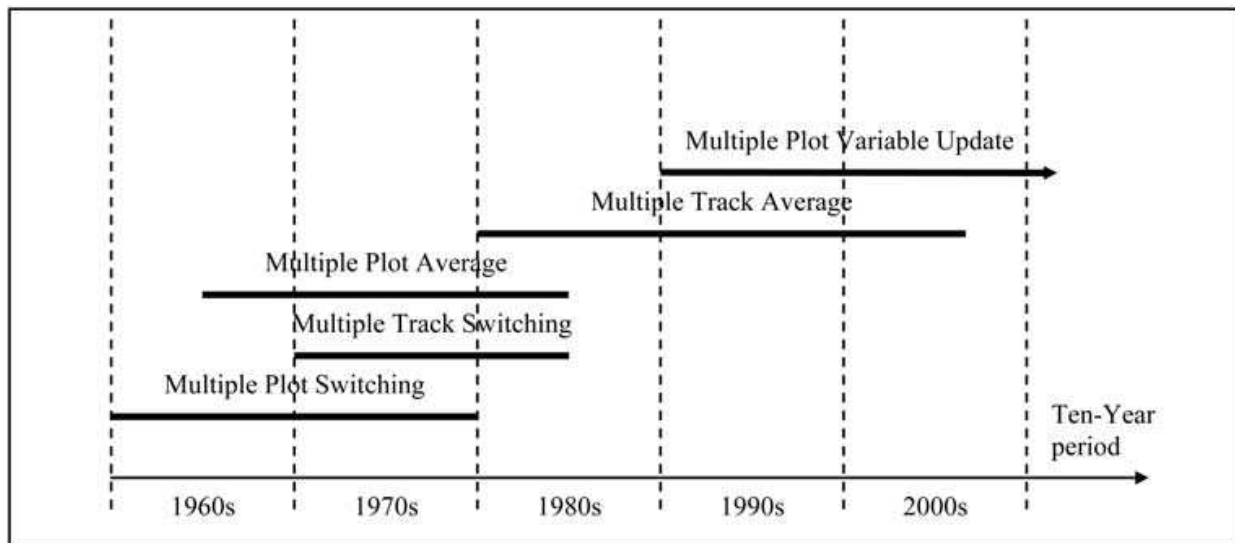

Fig. 6. Historical perspective of principle data fusion techniques

3.1.2 Selection techniques

The selection techniques are also known as “mosaic systems”. Airspace is divided into cells with a pre-determined preferred sensor for each of them. The system receives data from all sensors and choose the appropriate information of each cell in which aircraft is detected.

3.1.2.1 Multiple plot switching method

This method consists in a selection at the radar plots level. Then, at each processing cycle, only one plot is selected among several plots coming from various radars which detect the

aircraft. This plot is used to create or update a common track. Selection is realized according to geographic priority rules (mosaic system).

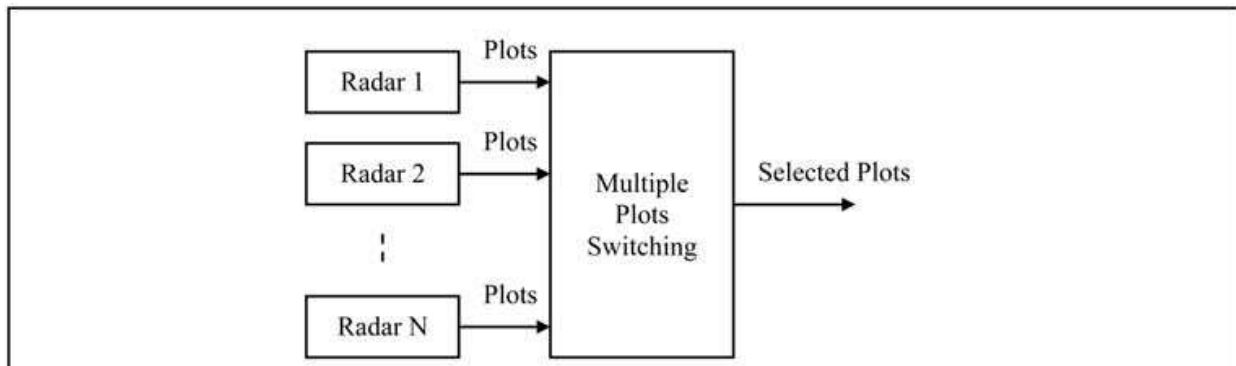

Fig. 7. Multiple plots switching method

3.1.2.2 Multiple track switching method

This method consists in a selection at the track level. Then, mono sensor independent tracks are updating for each radar, given several local tracks. Then, one of these local tracks is selected, depending on the relative position of the radars (mosaic) or their respective accuracy.

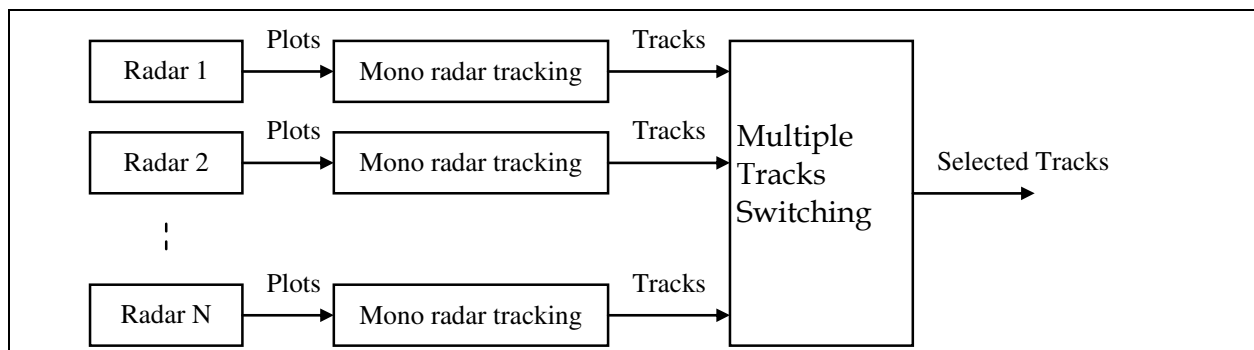

Fig. 8. Multiple tracks switching method

3.1.3 Average techniques

3.1.3.1 Multiple track average method

A mono radar track is independently elaborated for each aircraft per radar. When several local tracks are available, the common track is established by weighting (barycentre) of these local tracks (Chong et al., 2000) (Bar Shalom et al., 1988).

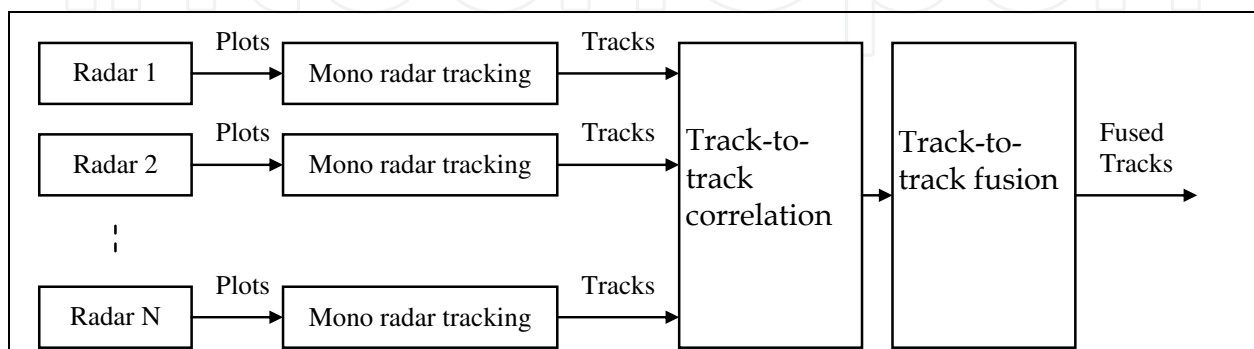

Fig. 9. Multiple tracks average method

3.1.3.2 Multiple plot average method

At each processing cycle, the common track established by weighting (barycentre) of the plots coming from various radars.

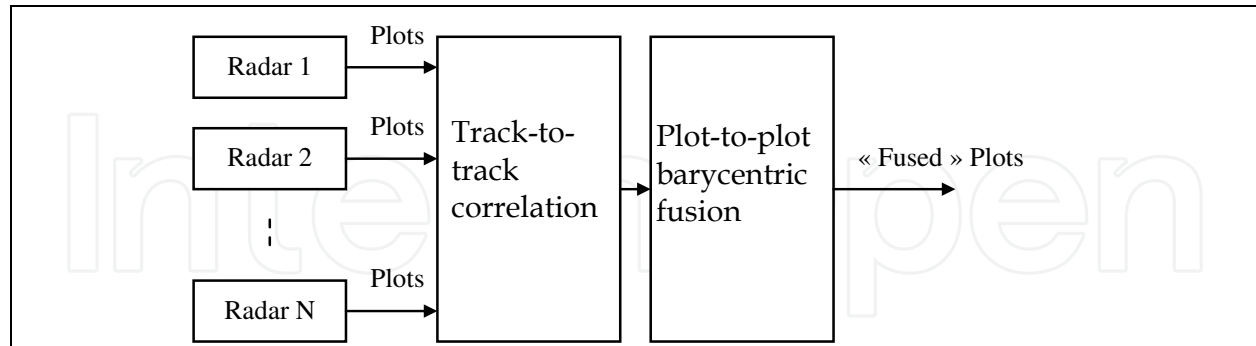

Fig. 10. Multiple plots average method

3.1.4 Variable update technique

The major disadvantage of the above-mentioned methods is that they do not use all the available information for one aircraft at one time. This leads to a sub-optimal tracking (Bar Shalom, 1989).

Moreover, the multi radar processing is depreciated in all the above-mentioned methods as the main tracking sub functions are performed in mono radar and a combination of local information is realized afterwards.

The Variable Update method consists in using all the plots coming from any radar to update a unique synthetic common track.

The track update is performed in the fly as soon as sensor reports are received. The reduction of the meantime update in multi-radar configuration improves the accuracy of the track parameters estimation.

In addition, sensors with different characteristics and qualities can be introduced in the same processing. Obviously, Variable Update based tracking constitutes a centralized processing.

Systems using this method are the most efficient. However, they implement a more complex algorithmic as they shall take into account the characteristics of the various sensors and an asynchronous processing of radar plots.

3.1.5 Comparison of the various data fusion techniques

Figure 11 below gives an idea of the tracking performance evolution depending on the data fusion techniques versus the CPU load. Indeed, the hardware performance has durably limited the deployment of newest data fusion techniques in ATC system. This is no longer the case with the introduction of the PC technology in early systems.

3.2 Radar data processing architecture

The radar data processing proposed in this paragraph is based on a Variable Update data fusion technique. The main chain tracker generally uses this technique while fallback tracker is based mainly on an older technology such as Multiple Track Average technique.

As entry data, the multi radar tracking function has several kind of plots at its disposal which can be primary, secondary or combined. Then, measurements from different radars are allocated so as to update radar tracks (Bar Shalom, 1992).

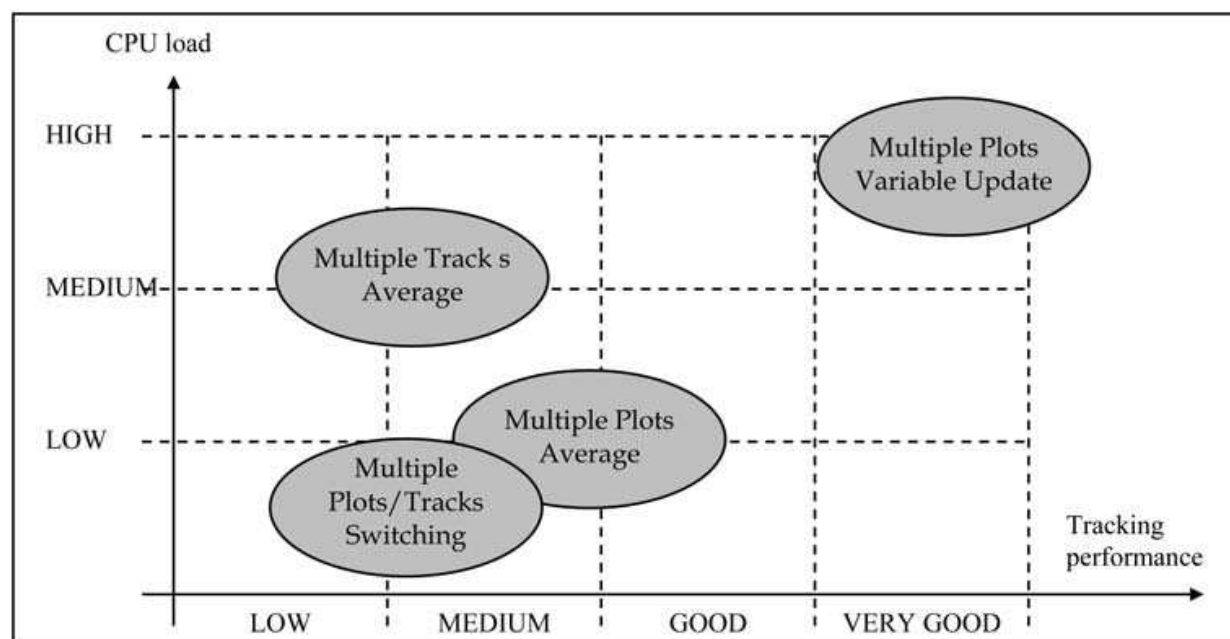

Fig. 11. Data fusion techniques comparison (CPU load versus tracking performance)

The table 3 below gives a quick comparison between Average and Variable Update techniques.

Average technique	Variable Update technique
No variable scanning rate adaptation	Variable scanning rate adaptation
Low CPU load	Medium up to high CPU load
Low track accuracy	Good track accuracy
Low track discrimination	Good tracks discrimination
Manoeuvre detection in long time	Manoeuvre detection in short time
Long initiation time delay (mono sensor)	Short initiation time delay (multi sensor)
Several sensor types integration vulnerability	Several sensor types integration robustness

Table 3. Comparison between Average and Variable Update techniques

A complete description of the Radar Data processing functions is available in (Baud et al., 2006).

The association function is based on NNPDA (Nearest Neighbour Probabilistic Data Association) method. Tracks are automatically initialised. The tracking filter which is used is an Interacting Multiple Model (IMM) in the System Cartesian frame. Manoeuvre components are managed through a Multiple Hypothesis Tracking (MHT) method. Bias registration is performed by using a dedicated Kalman filter. All tracks from the air situation picture are distributed periodically ("broadcast mode") at a specified update rate (set to 5s in most cases).

4. Sensor data processing architectures

Sensor data processing architectures proposed in this paragraph trace the evolutions from the Multi Radar Tracking System (described in paragraph 3 above) to the Multi Sensor Tracking System.

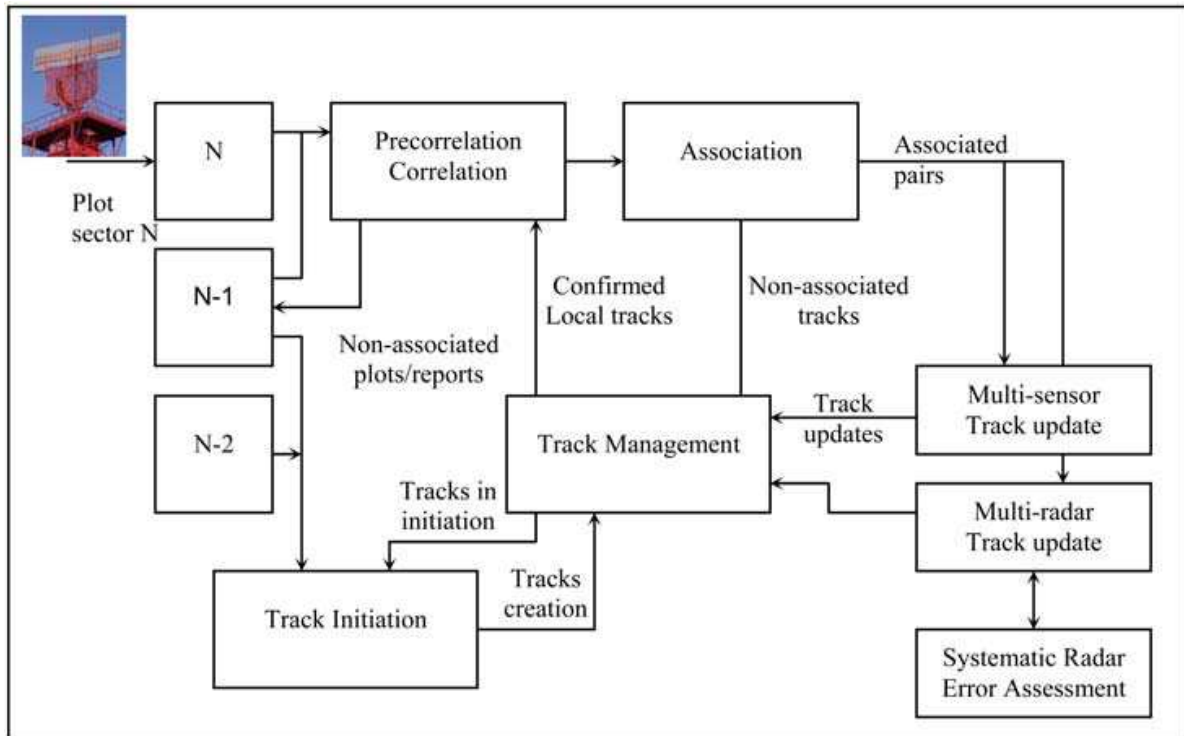

Fig. 12. Multi Radar Tracking System (MRTS) architecture

4.1 Mode S enhanced-tracking architecture

This architecture is fully described in paper (Baud et al., 2007). Figure 13 below shows how the Mode S data are introduced into a sensor data processing.

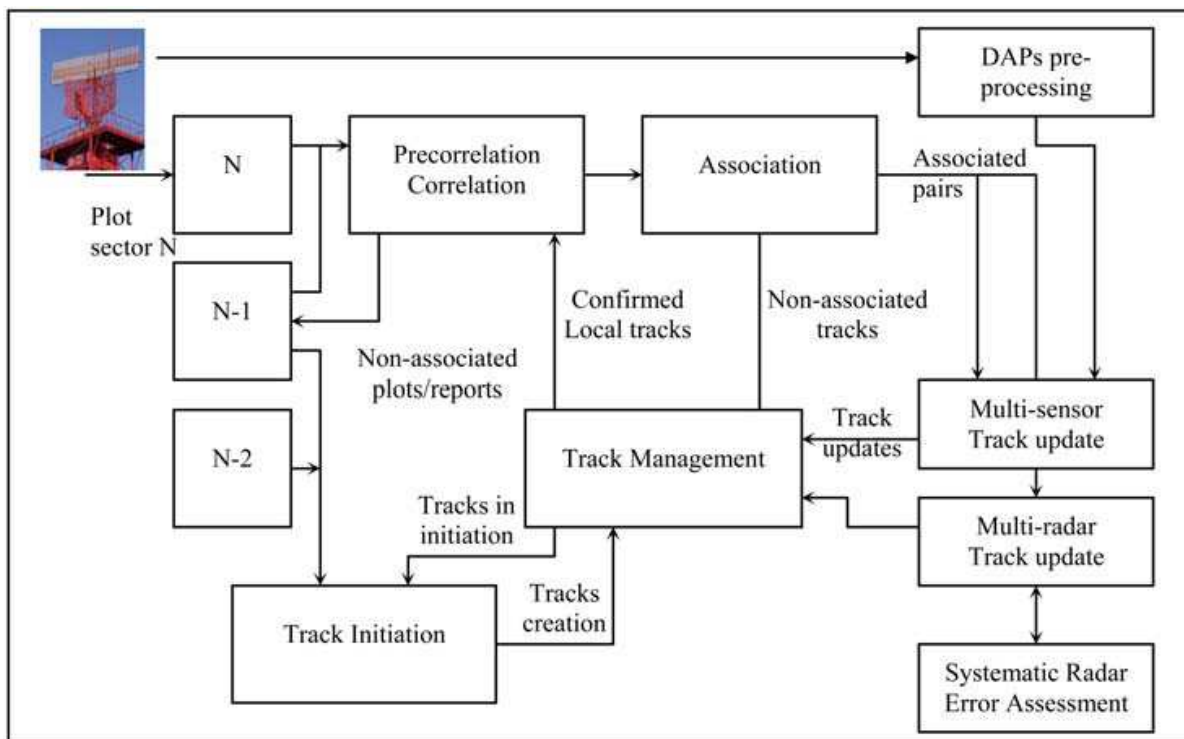

Fig. 13. Mode S enhanced-tracking architecture

Correlation and association processing take into account the 24-bit ICAO Address unique identifier to facilitate the association of a plot to any existing tracks. The Downlinked Aircraft Parameters (DAPs) are used after their own consistency checking to speed up the track initiation and to update the track state vector. The introduction of on-board parameters when updating the track improves the global tracking accuracy especially during manoeuvres (Bar Shalom, 1992).

The track distribution is enhanced so as to provide additional information to the air traffic controllers.

4.2 Radar / ADS data fusion architecture

This architecture is partially described in paper (Baud et al., 2006).

The radar / ADS-B data processing architecture takes advantage of the multiple report variable update technique. A semi-centralized and semi-distributed hybrid architecture is proposed: an internal ADS-B only air situation picture is elaborated as well as a complete Radar / ADS-B fused air situation.

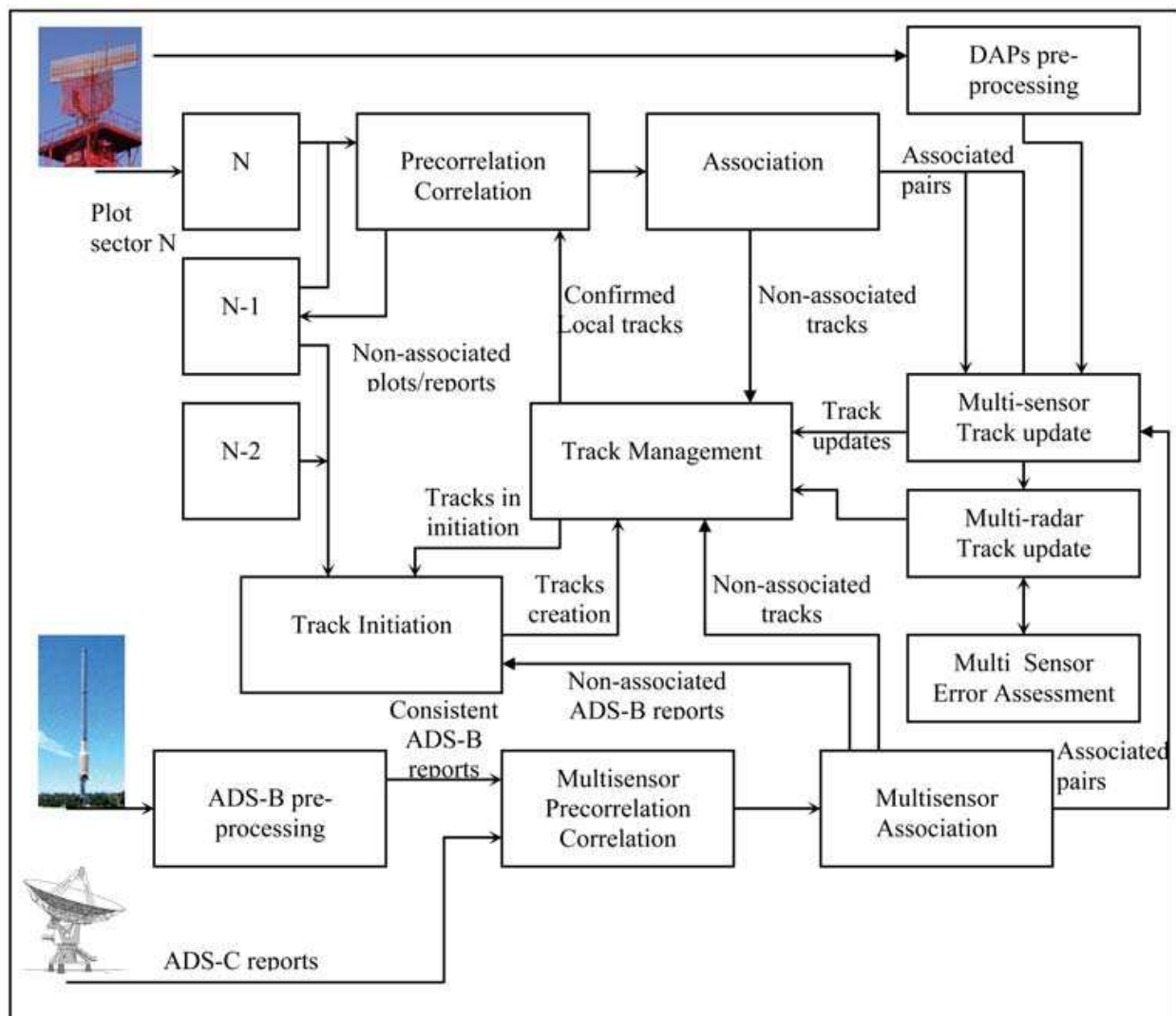

Fig. 14. Radar / ADS-B / ADS-C data fusion architecture

The ADS-B pre-processing sub-function (Besada et al., 2000) consists in the following processing:

- ADS-B report validation against ADS-B only air situation picture,
- ADS-B report validation against other surveillance sources.

This pre-processing is required in order to cope with GPS outages, time stamping issues and GPS/INS on-board switching.

Target models parameterization remains the same as for radar because the addressed targets are identical. Consistent ADS-B reports are used also to improve the radar bias registration. CPU loads issues can be encountered due to the very low data refresh rate (1Hz or more). This is the reason why an ADS-B sensor gateway (Figure 5 above) is used in high traffic density areas.

On the contrary, ADS-C data are directly used by multi sensor pre-correlation, correlation and association processing prior to the update of the multi sensor track state vector. Specific track management processing is performed so as to cope with the low refresh rate of such data. ADS-C data serves mainly in oceanic areas as a gap filler.

4.3 Radar / WAM data fusion architecture

Figure 15 below shows how the WAM data are introduced into a sensor data processing.

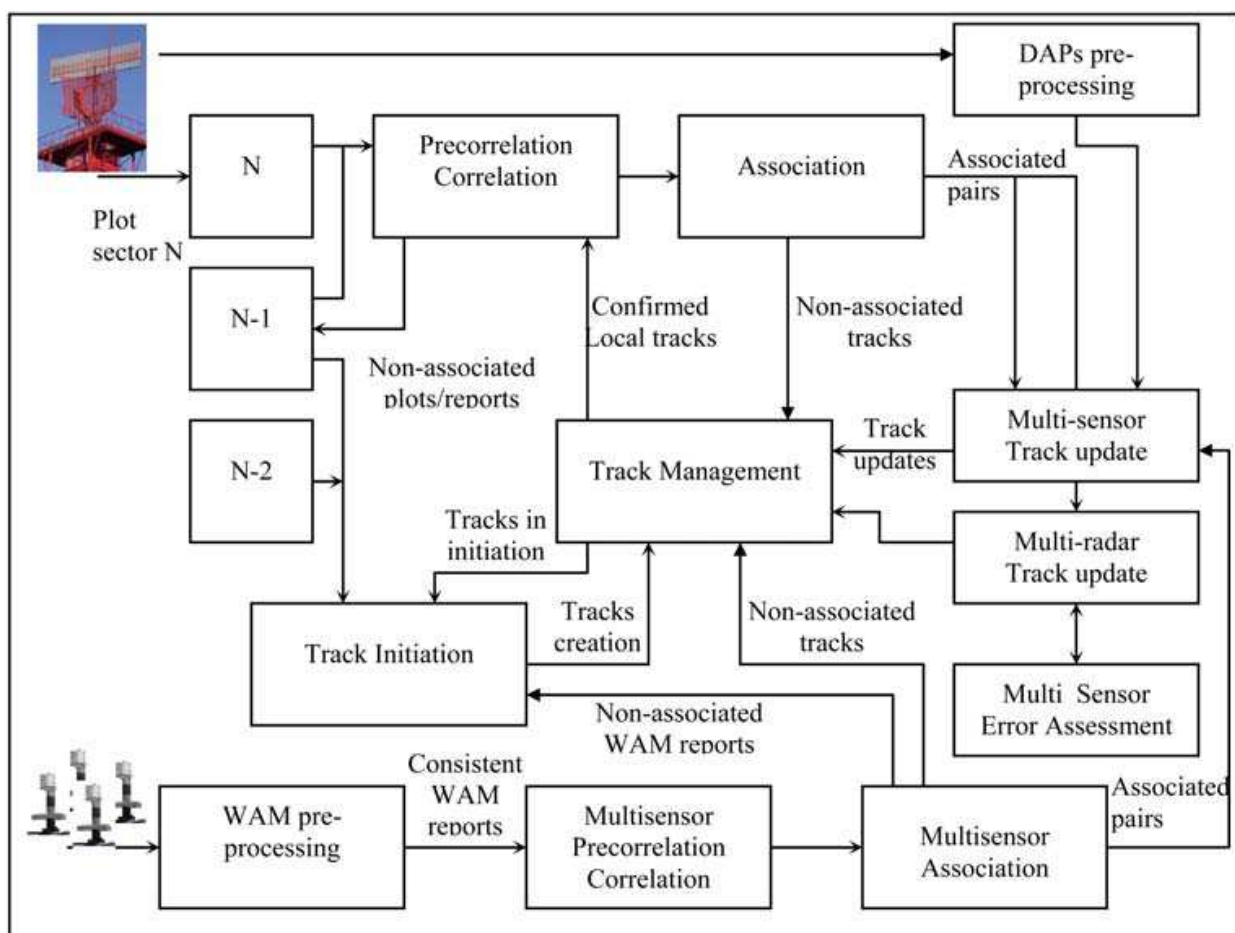

Fig. 15. Radar / WAM data fusion architecture

The radar / WAM data processing architecture takes advantage of the multiple report variable update technique. A semi-centralized and semi-distributed hybrid architecture is

proposed: an internal WAM only air situation picture is elaborated as well as complete Radar / WAM fused air situation picture (Daskalakis et al., 2005).

The WAM pre-processing sub-function consists in the following processing:

- WAM report validation against WAM only air situation picture,
- WAM report validation against other surveillance sources.

This pre-processing is required in order to cope with WAM receivers clock synchronization issues and to determine, given WAM report accuracy, the observability of the target, and then avoid sub-optimal or erratic track behaviour.

Target models parameterisation remains the same as for radar because the addressed targets are identical.

CPU loads issues can be encountered due to the very low data refresh rate (1Hz or more), reason for which a WAM sensor gateway (Figure 5 above) is used in high traffic density areas.

4.4 Architecture enhancements for A-SMGCS

The first step of A-SMGCS data application into a Multi Sensor Tracking System is briefly explained in this paragraph. The second step is part of the future gate-to-gate surveillance concepts addressed in paragraph 5.2 below.

A-SMGCS sensor is expected to send local tracks that are used to speed up the multi sensor track initiation, especially on Parallel Runway Monitoring (PRM) volumes.

A-SMGCS sensor data are processed as for the WAM data but without dedicated pre-processing.

5. Architectures for the future

The main enhancement in the surveillance environment, which influences the transition from the current conventional environment towards the future CNS/ATM system, is the introduction of new types of sensors (i.e. SSR Mode-S, ADS-B, ADS-C, ASDE, and Multilateration Systems) and the resulting capability to acquire on-board data through the various air-ground data links. The advanced features of the future CNS/ATM environment create the need for modifications both in the internal functionality and the interfaces with the functional entities of the environment (that is to say data sources and users).

First enhancements that concern the use of SSR Mode-S, ADS-B, ADS-C and WAM have been explained in the paragraph 4 above.

5.1 Traffic Information service – Broadcast (TIS-B)

TIS-B is a service that provides current aircraft surveillance information to airborne systems (and usually the pilot). This is a broadcast service from ground stations sending surveillance information from ground to air. As such, there is no TIS-B data transfer from aircraft to ground and there is no acknowledgement of the reception of TIS-B messages.

An Air Traffic Service Provider (ATSP) collects and correlates surveillance data from radar, multilateration systems and from ADS-B ground stations in order to provide a TIS-B service.

Then, individual surveillance systems data are fused in the sensor data processing, which is in charge of the transfer of fused tracks to the TIS-B system. This determines which TIS-

B targets are required to be broadcasted (by considering the available radar and ADS-B data). Finally the TIS-B ground station broadcasts these targets at regular intervals in order to be received by properly equipped aircraft where the information is presented then to the pilot.

The sensor data processing is in charge of the multi sensor data fusion as well as the validation of the incoming ADS-B reports against radar/multilateration surveillance data. The sensor data processing shall be enhanced so as to cope with the little latency which is allocated to the data fusion system (less than 1s) and the fact that it shall send tracks each time the track state vector is updated (“update mode” versus the above-mentioned “broadcast mode”).

5.2 Gate-to-gate concept

Typical airport surveillance systems consists in an Advanced – Surface Movement Control and Guidance System (A-SMCGS). These systems mainly use Surface Movement Radar (SMR) or Airport Surface Detection Equipment (ASDE) data, ADS-B and Airport Multilateration (MLAT) data inputs to build the airport tracking situation picture which is displayed to the controllers.

The purpose of the gate-to-gate concept from a surveillance prospective is to provide the controller with a synthetic information that covers aircraft movements for ground, approach and en-route areas. Then, this requires the inclusion of the airport surface surveillance sensors as an input of the sensor data processing system. Enhancements of tracker functionalities are the following:

- dedicated processing which deals with sensor reports anomalies (reflections, side-lobes, outliers and blunders),
- correlation/association improvements to cope with high density multi targets environment,
- target models which deals with new object dynamics,
- target classification and airport map interfacing which helps in the appropriate selection of the models.

Two solutions are proposed:

- distributed architecture with the use of the outputs of an A-SMGCS system (described in paragraph 4.4 above),
- centralized architecture with the fusion of data from all various airport data sources in the sensor data processing module (refer to figures 16 and 17 below).

Figure 17 below does not show the ADS, WAM processing even if they are still persist in the complete integrated architecture.

MLAT pre-processing complies with what is done in WAM pre-processing module.

In normal conditions, mobiles (both aircraft and ground vehicles) are constrained to move only within some restricted areas of the airport (runways, taxiways and roads), each one of which imposing particular motion patterns and kinematics bounds. The restrictions can be either of a physical nature (shape of ways, obstacles, etc.) or rule-based procedures (permitted manoeuvres, circulation direction, etc.).

Ground information is included in the two most important aspects of the estimation process: sensor data pre-processing (characterization of error covariance) and target dynamic modeling to improve the accuracy of final state vector estimations.

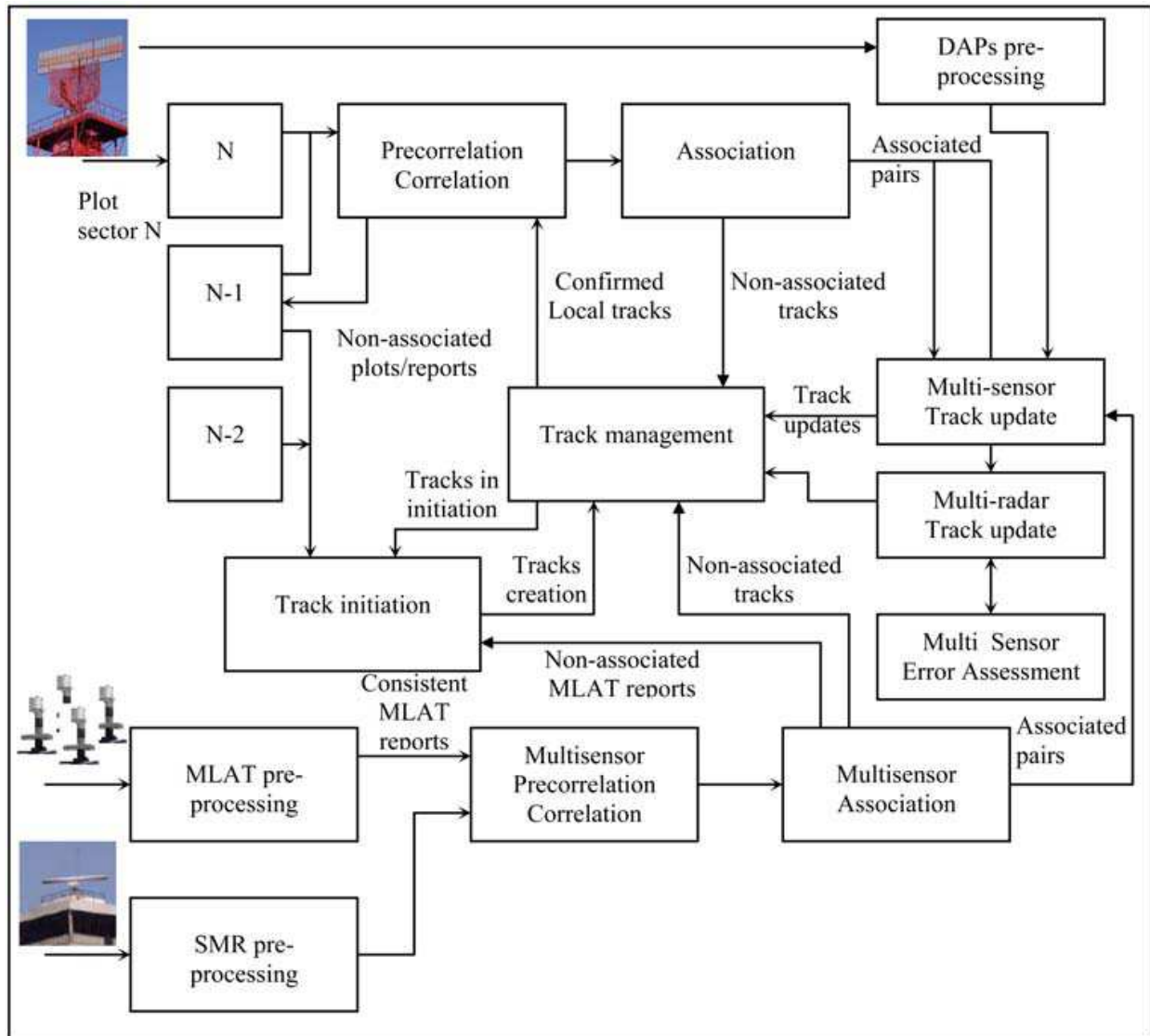

Fig. 16. Centralized air / ground data fusion architecture

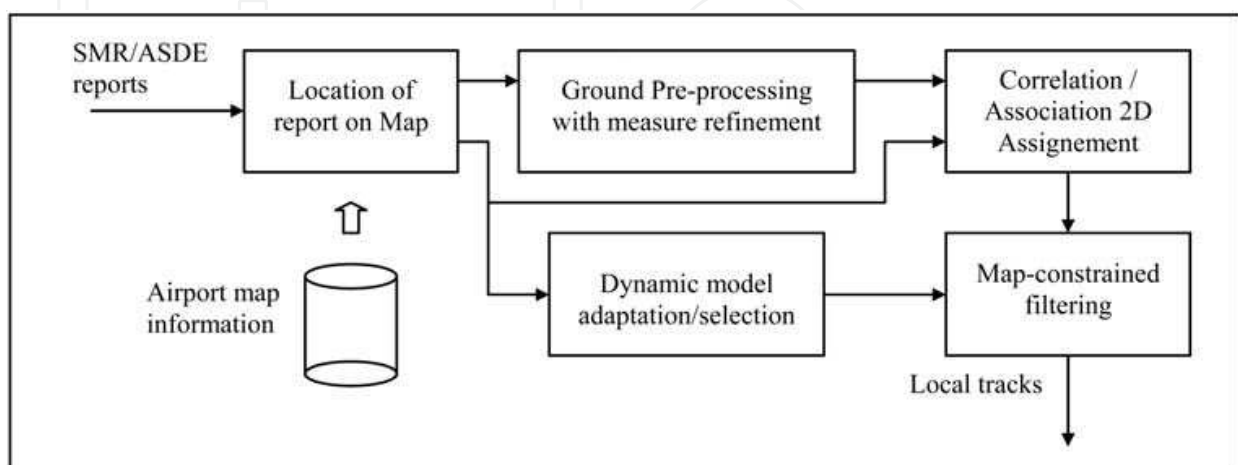

Fig. 17. SMR/ASDE pre-processing synoptic

Either distributed or centralized architectures can be chosen according to the kind of sensor to be integrated and to the tracking accuracy, continuity and integrity metrics to be verified.

7. Conclusion

Nowadays, the development of advanced ATM systems is realised by the implementation of advanced means of communication, navigation and surveillance for air traffic control (CNS/ATM).

The definition of a new set of surveillance standards has allowed the emergence of a post-radar infrastructure based on data-link technology. The integration of this new technology into gate-to-gate architectures has notably the following purposes:

- fluxing air traffic which is growing continuously,
- increasing safety related to aircraft operations,
- reducing global costs (fuel cost is increasing quickly and this seems to be a long-term tendency), and
- reducing radio-radiation and improving the ecological situation.

In this context, sensor data processing will continue to play its key role and its software as well as its hardware architecture is expected to evolve in the meantime. The performance requirements of such a sub-system (accuracy, latency, continuity and integrity) is expected to become more and more strict in the incoming years. This issue will be discussed in a future chapter.

8. References

- Bar Shalom, Y. (1989). *Multitarget-Multisensor Tracking: Advanced Applications*, Artech House, ISBN 978-0964831223, Norwood
- Bar Shalom, Y. (1992). *Multitarget-Multisensor Tracking: Applications and Advances*, Artech House, ISBN 978-0890065174, Norwood
- Bar Shalom, Y. & Fortmann, T. E. (1988). *Tracking and Data Association*, Academic Press, ISBN 978-0120797608, San Diego
- Baud, O.; Honoré, N. & Taupin, O. (2006). *Radar / ADS-B data fusion architecture for experimentation purpose*, ISIF'06, 9th International Conference on Information Fusion, pp. 1-6, July 2006.
- Baud, O.; Honoré, N. ; Rozé, Y. & Taupin, O. (2007). *Use of downlinked aircraft parameters in enhanced tracking architecture*, IEEE Aerospace Conference 2007, pp. 1-9, March 2007.
- Besada, J. A.; Garcia, J. ; De Miguel, G. ; Jimenez, J. F. ; Gavin, G. & Casar, J. R. (2000). *Data fusion algorithms based on radar and ADS measurements for ATC application*, IEEE International Radar Conference 2000, pp. 98-103, May 2000.
- Chong, C. Y.; Mori, S. ; Barker, W. H. & Chang K. C. (2000). *Architectures and algorithms for track association and fusion*, Aerospace and Electronic Systems Magazine, IEEE, Volume 15, Issue 1, pp. 5-13, January 2000.
- Daskalakis, A. & Martone, P. (2005). *Assessing Wide Area Multilateration and ADS-B as alternative surveillance technology*, AIAA 5th ATIO and 16th Lighter-Than-Air

Sys. Tech. and Balloon Systems Conference, Sep. 26-28, 2005, Arlington,
Virginia.

IntechOpen

IntechOpen



Sensor and Data Fusion

Edited by Nada Milisavljevic

ISBN 978-3-902613-52-3

Hard cover, 436 pages

Publisher I-Tech Education and Publishing

Published online 01, February, 2009

Published in print edition February, 2009

Data fusion is a research area that is growing rapidly due to the fact that it provides means for combining pieces of information coming from different sources/sensors, resulting in ameliorated overall system performance (improved decision making, increased detection capabilities, diminished number of false alarms, improved reliability in various situations at hand) with respect to separate sensors/sources. Different data fusion methods have been developed in order to optimize the overall system output in a variety of applications for which data fusion might be useful: security (humanitarian, military), medical diagnosis, environmental monitoring, remote sensing, robotics, etc.

How to reference

In order to correctly reference this scholarly work, feel free to copy and paste the following:

Baud Olivier, Gomord Pierre, Honoré Nicolas, Ostorero Loïc, Taupin Olivier and Tubery Philippe (2009). Multi Sensor Data Fusion Architectures for Air Traffic Control Applications, Sensor and Data Fusion, Nada Milisavljevic (Ed.), ISBN: 978-3-902613-52-3, InTech, Available from:
http://www.intechopen.com/books/sensor_and_data_fusion/multi_sensor_data_fusion_architectures_for_air_traffic_control_applications

INTECH
open science | open minds

InTech Europe

University Campus STeP Ri
Slavka Krautzeka 83/A
51000 Rijeka, Croatia
Phone: +385 (51) 770 447
Fax: +385 (51) 686 166
www.intechopen.com

InTech China

Unit 405, Office Block, Hotel Equatorial Shanghai
No.65, Yan An Road (West), Shanghai, 200040, China
中国上海市延安西路65号上海国际贵都大饭店办公楼405单元
Phone: +86-21-62489820
Fax: +86-21-62489821

© 2009 The Author(s). Licensee IntechOpen. This chapter is distributed under the terms of the [Creative Commons Attribution-NonCommercial-ShareAlike-3.0 License](https://creativecommons.org/licenses/by-nc-sa/3.0/), which permits use, distribution and reproduction for non-commercial purposes, provided the original is properly cited and derivative works building on this content are distributed under the same license.

IntechOpen

IntechOpen