

# We are IntechOpen, the world's leading publisher of Open Access books Built by scientists, for scientists

## 4,800

Open access books available

## 122,000

International authors and editors

## 135M

Downloads

Our authors are among the

## 154

Countries delivered to

## TOP 1%

most cited scientists

## 12.2%

Contributors from top 500 universities

**WEB OF SCIENCE™**Selection of our books indexed in the Book Citation Index  
in Web of Science™ Core Collection (BKCI)

Interested in publishing with us?  
Contact [book.department@intechopen.com](mailto:book.department@intechopen.com)

Numbers displayed above are based on latest data collected.

For more information visit [www.intechopen.com](http://www.intechopen.com)

# RFID System Integration Design with Existing Websites via EPCglobal-like Architecture for Expensive Material Handling

Shing Tenqchen<sup>1,2,3</sup>, Chui- Yu Chiu<sup>2</sup> and Saad Laraqui<sup>3</sup>

<sup>1</sup>Dept of Electrical Engineering, National Taiwan University,

<sup>2</sup>Dept of Industrial Engineering and Management, National Taipei University of Technology,

<sup>1</sup>ChungHwa Telecom Labs.,

<sup>3</sup>Dept of Management & Technology, University of Maryland University College,

<sup>1,2</sup>Taiwan

<sup>3</sup>USA

## 1. Introduction

Radio Frequency Identification System (RFID) Technologies have been widely applied to many fields for many years (Glover & Bhatt (2006)). In the past, due to the high prices of reader/ tag, and many complex existing material management softwares in operating unit, there are not many successful driving projects working on constructing an integrated service for expensive materials handling in this area. On the end of 2006, the design of middleware using RFID reader and tag to collect traffic information implemented on urban-bus for intelligent transportation system has been successfully deployed in Taipei city for a trail system (Tenqchen *et. al.* (2007)). However, the quick response for the material ID, the price is lower down to certain acceptable region in reader/ tag, and more successful stories in RFID related applications have motivated the birth of integrated service for expensive material handling. The driving force can be seen from Figure 1-1 to see the interior and exterior forces. Especially, the stock manager can easily investigate the total amount of important controlled equipments via the hit of website over different operating systems and existing material management systems.

In this following, we will handle the problems of the following:

- manual counting all stocks in warehouses;
- one can not allocate and transfer the wanted material in a short time; and
- it is hard to find the information of mapping the amounts of materials while the materials are in the installing/ disassembling equipments.

Thus, the objectives of the design of website are:

- Check stock materials easily by e-information (e-info);
- Provide the mapping for material and customer;
- Provide stocking e-info for operating organization; and
- Provide the history of expensive materials.

The system architecture for this kind of system is shown in Figure 1-2. The dotted red block is called the middleware to handle the read/ write of RFID tags and readers. The RFIDIS is the website for us to design such that one can monitor the status of expensive equipments

Source: Development and Implementation of RFID Technology, Book edited by: Cristina TURCU, ISBN 978-3-902613-54-7, pp. 554, February 2009, I-Tech, Vienna, Austria

on line. The Material Acquisition and Support Information System (MASIS) and Spare-Parts Administration System (SPAS) may be the existing material management software systems in the website.

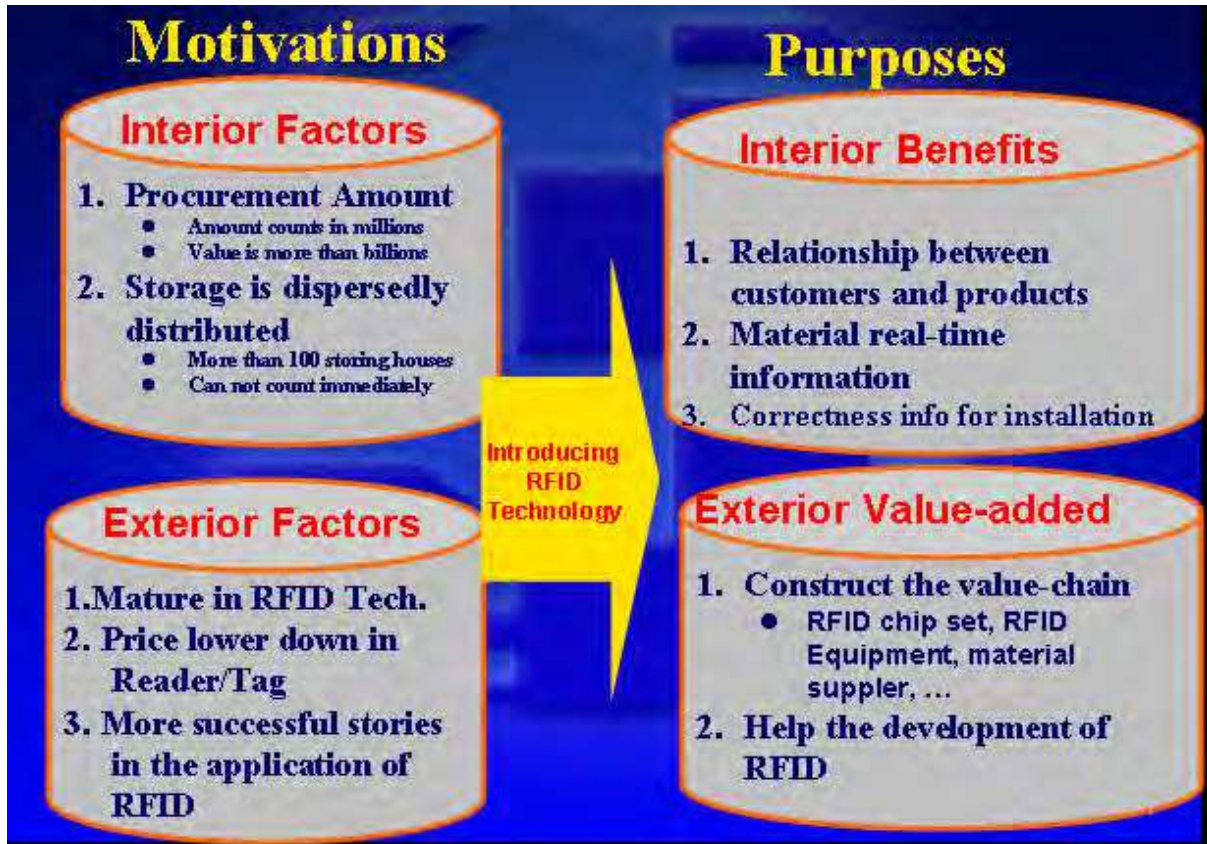

Fig. 1-1. Motivations and Purposes for RFID

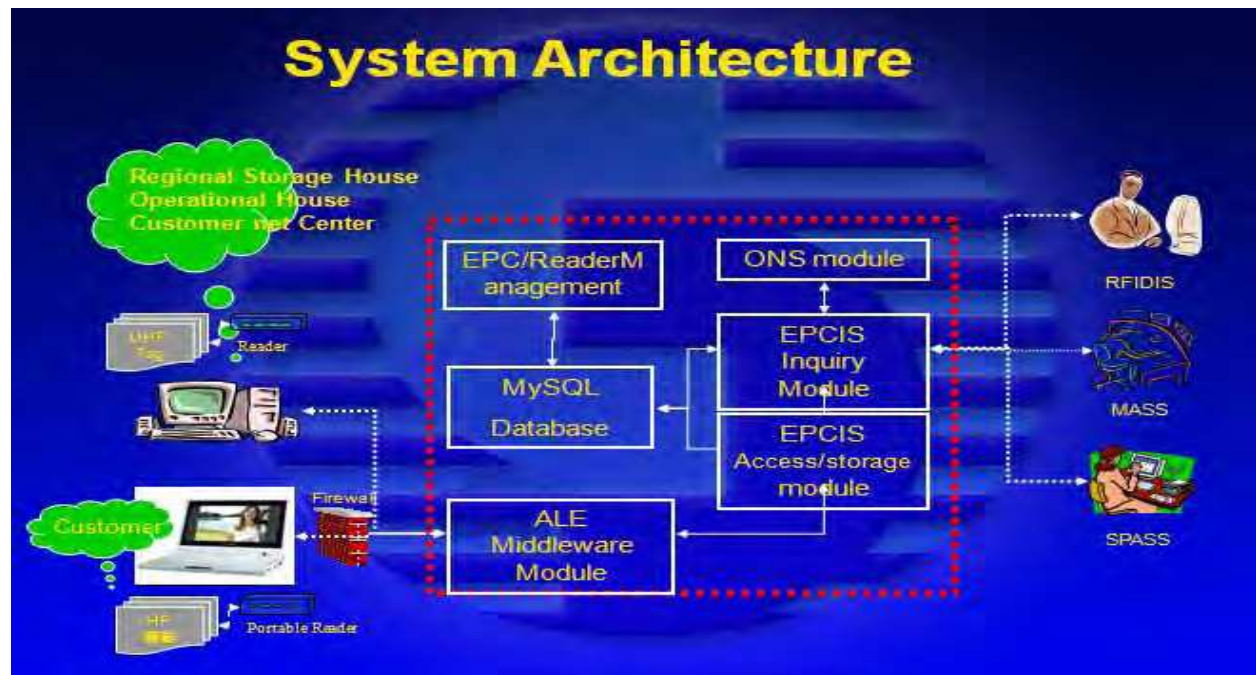

Fig. 1-2. System Architecture

The most elegant benefits of handling expensive materials using RFID technology can be described in four main folds as shown in Figure 1-3:

- Reducing the stock level;
- Increasing the efficiency of managements; and
- The historical display for material in item level or case level; and the realization of e-info for e-management.

In section 2, we describe the system requirements of the existing technology plan for RFID. This section of the rest will include some of the historical reviews in this area. What are the previous solutions that they ever did? What are the possible solutions in the future? What are the approaches of our methods and the logical architecture? The standardization of EPCglobal in this area will be included. In section 3, we will discuss the commercial RFID middleware. The RFID middleware platform, key elements of the EPCIS, a typical ONE query, and centralized deployment structure will be included in this section. The other structures please refer to Glover and Bhatt (2006). In section 4, we will focus the interface methodology of the system architecture of RFID with the existence systems like MASIS, SPAS and others. The sequence of logic operations is important to the message right from the enquiry of website on-line checking. In section 5, the system integration test is given to verify the logic sequences of our RFID system's results according to Table 4-1.



Fig. 1-3. Benefits

## 2. The system requirements

The ADSL Transceiver Unit Remote (ATUR), Symmetrical Transceiver Unit Remote (STUR), VDSL Transceiver Unit Remote (VTUR), Fiber to the Building (FTTB), Set-Top-Box (STB), and multi-functions telephones are served as examples for expensive materials as shown in Figure 2-1. The total volumes of expensive devices are generally larger than millions. They deserve our attentions to look at the material management problems. However, in most

cases, the stock houses always have an existing material handling software. Thus, the integration of existing software like MASIS and SPAS (at least, but not limited to) in existing environments is a MUST condition for entire program.

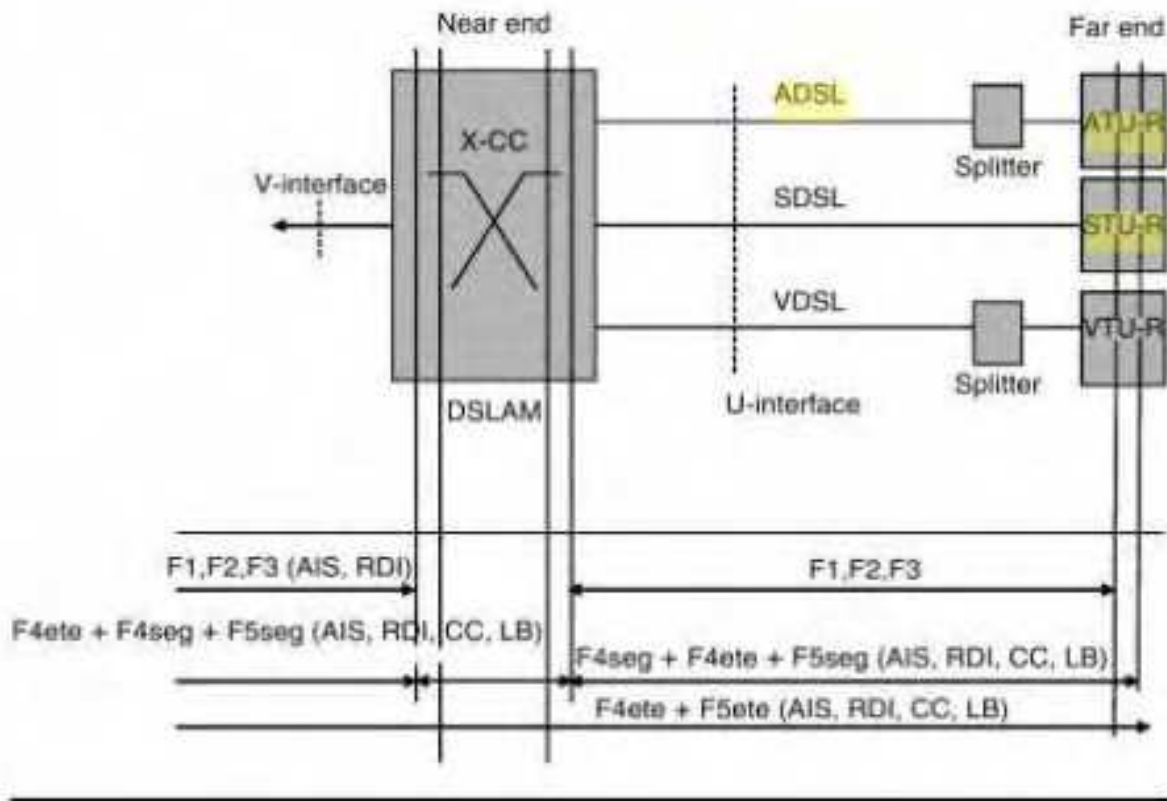

Fig. 2-1. General System architecture and Operators, administration, and maintenance (OAM) information flows. Source: Golden, Dedieu, and Jacobsen (2007), p. 448.

## 2.1 Primary typical system architecture

The primary typical system architecture of RFID components found in a retail store as shown in Figure 2-2 (modified from Finkenzeller & Waddington (2003)). In the bottom-left corner of the diagram, it is a set of RFID tags with antennas that represent the tagged merchandise. The readers may read tags hundreds or even thousands of times per minute, but most of these reads will not be interesting to our applications. The readers must be configured and managed to know how to work together to cover blind spots a reader should fail. The box marked RFID middleware represents one or more software modules that handle these responsibilities. The box marked edge applications represents any enterprise applications that have components running inside the store – for instance, Point of Sale (POS) system components. The box marked RFIS information service represents a mechanism to store RFID events and related data at the edge. This is because RFID information is stored at various points in the infrastructure: at the edges, within the data center, and with business partners.

RFID readers, also called *interrogators*, are used to recognize the presence of nearby RFID tags. An RFID reader transmits RF energy through one or more antennas. An antenna in a nearby tag picks up this energy, and the tag then converts it into electrical energy via

induction. This electrical energy is sufficient to power the semiconductor chip attached to the tag antenna, which stores the tag's identity. The tag then sends the identity back to the reader by raising and lowering the resistance of the antenna in one kind of Morse code. This is only one scenario, and different tags can work in slightly different ways, but this is typical of the way readers and tags interact.

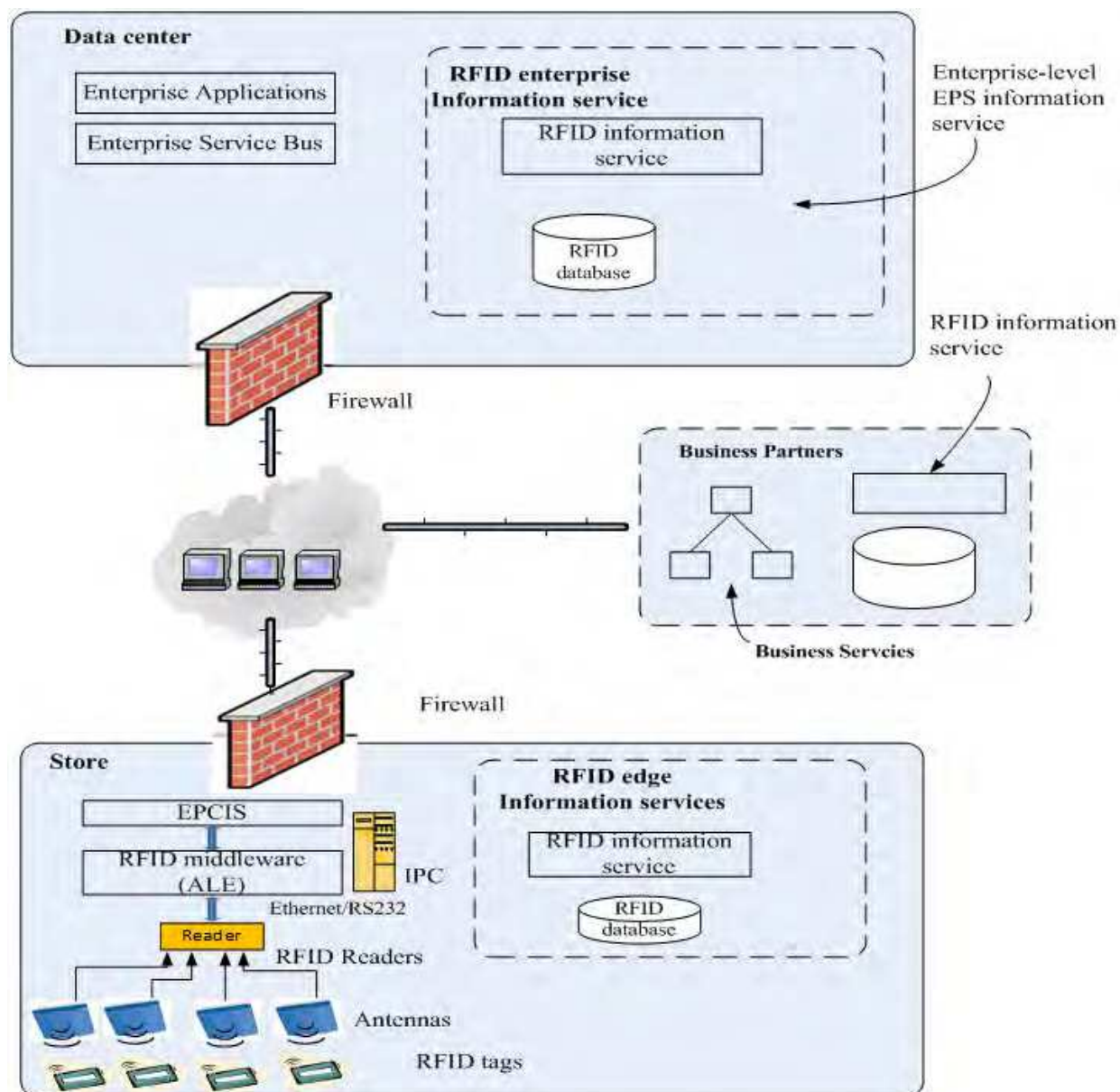

Fig. 2-2. RFID System Architecture

The implementation of RFID system architecture can be simulated as an RFID-based Management Platform as shown in Figure 2-3. It is only a trial system to verify the designed websites have a good communicational records with existing material management softwares like MASIS, SPAS, TOPS, and STARS, etc.

Many readers come in many shapes and sizes and can be found in stationary, as well as portable, handled varieties. Figure 2-4 shows how a reader fits between tags, antennas, materials and the components of a reader.

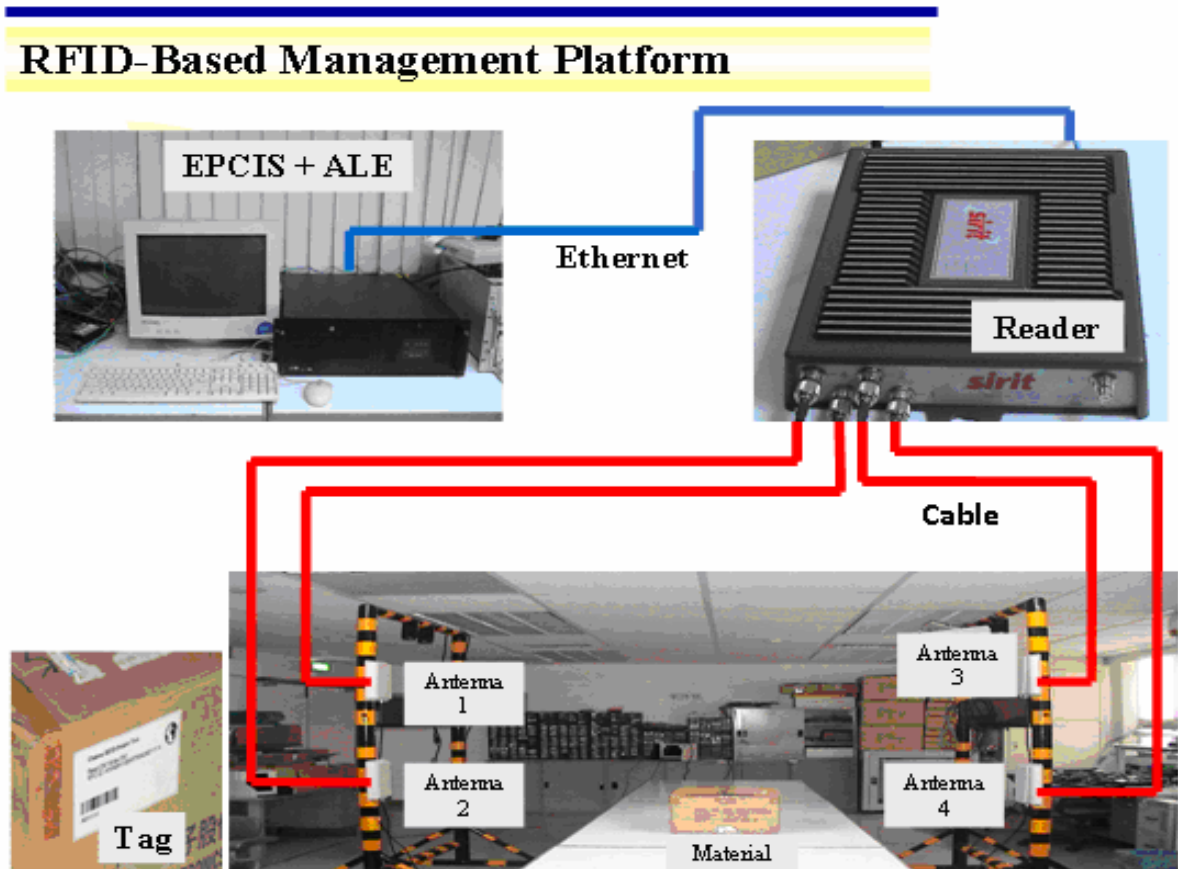

Fig. 2-3. the implementation of RFID-Based Management Platform

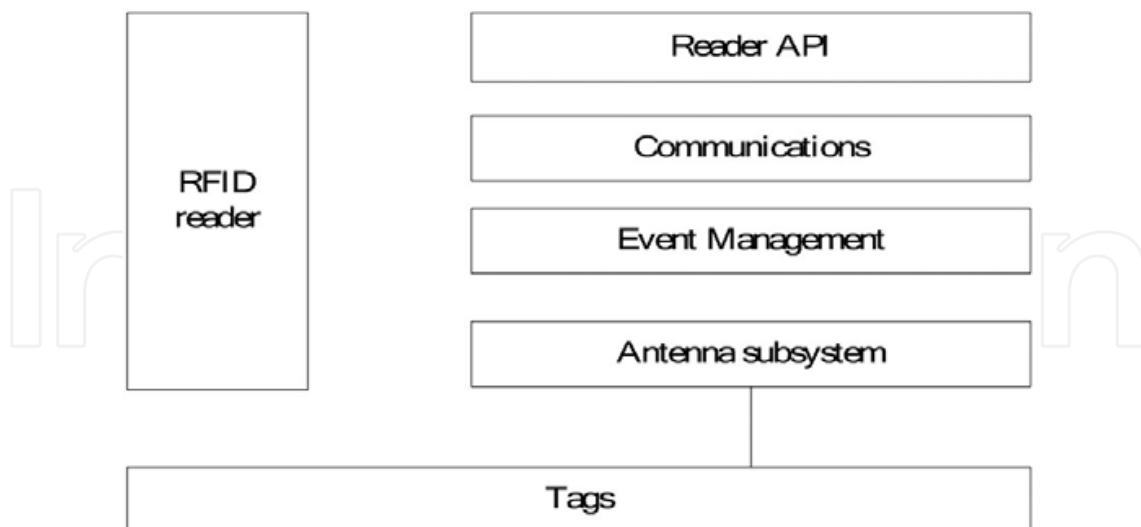

Fig. 2-4. Parts of a reader [Source: Glover and Bhatt (2006)]

#### 1. Reader API

Reader API is the application programming interface that allows programs to register for and capture RFID tag read events. It also provides capabilities to configure, monitor, and manage the reader.

## 2. Communications

Readers are edge devices, and like any other RFID devices; they are connected to the overall edge network. The communications component handles the networking functions.

## 3. Event management

When a reader sees a tag, we call this an *observation*. An observation that differs from previous observations is called an event. The analysis of observations is called event filtering. Event managements defines what kinds of observations are considered events and determines which events are interesting enough to merit being either put in a report or sent immediately to an external application on the network.

## 4. Antenna subsystem

The antenna subsystem consists of one or more antennas and the supporting interfaces and logic that enable RFID readers to interrogate tags.

## 5. RFID middleware

There are three primary motivations for using RFID middleware: providing connectivity with readers (via the reader adapter), processing raw RFID observations for consumption by applications (via the event manager), and providing an application-level interface to manage readers and capture filtered RFID events. The event-processing middleware is introduced between the readers and the applications. This approach is suitable for small-scale deployments using the capabilities provided by application integration products.

Several dozen types of RFID readers are available in the marketplace today, and each has its own proprietary interface. It would be impractical to expect application developers to learn different types of reader interfaces. Reader interfaces, as well as data access and device management capabilities, differ widely. One should try to use middleware that shields you from having to learn the idiosyncrasies of individual readers. The adapter layer encapsulates the proprietary reader interfaces so that they don't need to come in contact with the application developers.

We should filter out any such spurious observations to avoid sending a flood of inaccurate observations to the inventory control system. Filter 2-5 illustrates a procedure for filtering and smoothing system devised to address typical scenarios experienced in retail stores.

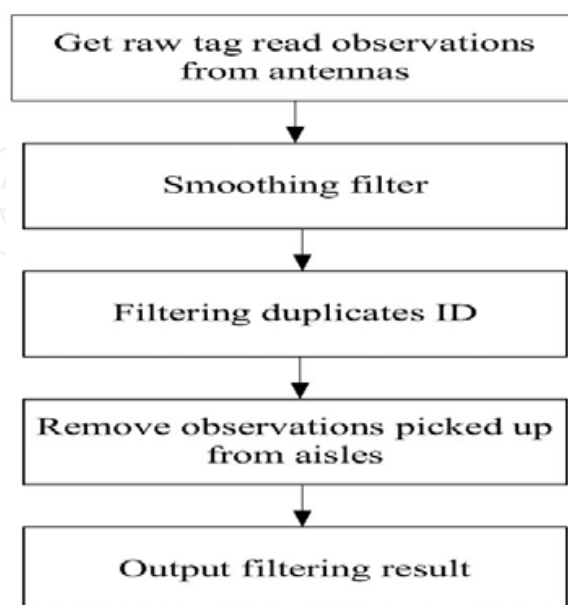

Fig. 2-5. Procedure of Filtering the Events



## 2.2 Logical architecture

A typical RFID-enabled distributor or retailer with several hundred or more stores will have hundreds, if not thousands, of readers. Each of these readers will be chirping away several times a second to read the RFID tags around them. As shown in Figure 2-6, the raw observations from RFID readers and sensors lack application-level context. More instance, an order management application would want to know when the in-store inventory for a particular item drops below its threshold. As you can imagine, an order management system wouldn't be the least bit interested in knowing whether RFID readers are employed in tracking the items in the stores, let alone how many readers there are per store and in what configuration. The process of making them more meaningful for enterprise applications is called *event filtering*. The data mechanism of Reader and Tag shown in Figure 2-6 contains the reader subsystem and event subsystem. The component that provides the event filtering functions is called the *event manager*.

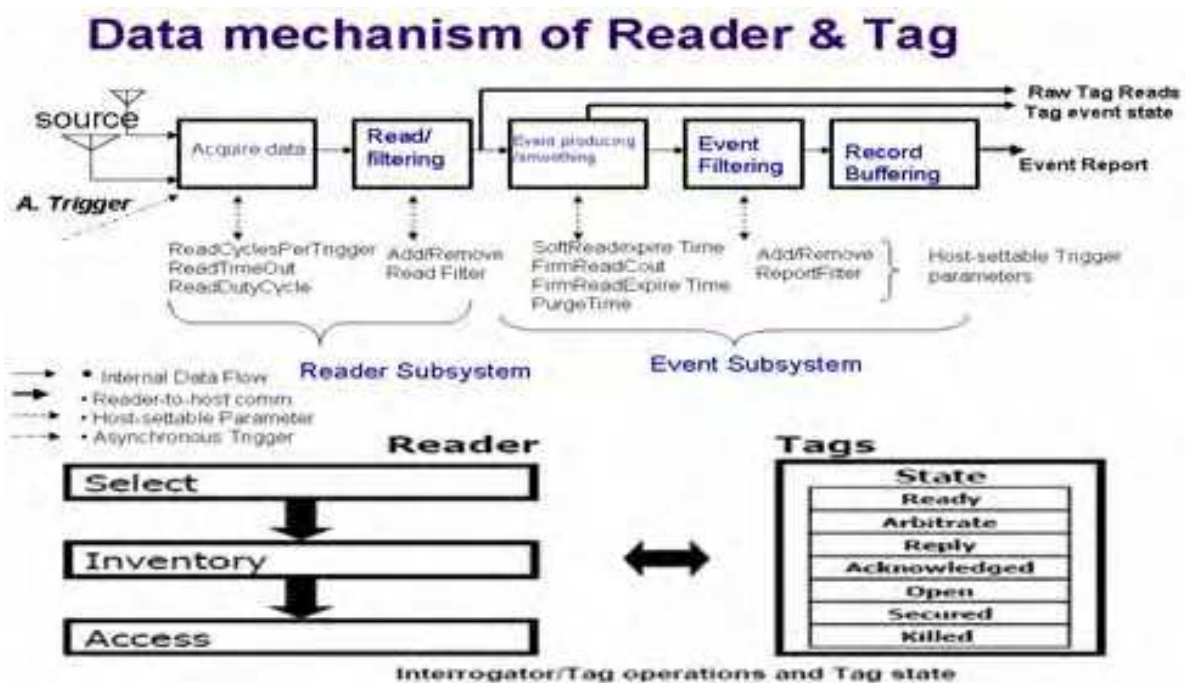

Fig. 2-6. The Data mechanism of reader and tag

Figure 2-7 is from the event volume to application relevance through different layers of an RFID system. Figure 2-8 shows a conceptual model of the RFID middleware. The RFID middleware receives raw observations from one or more data sources. A data source can be any sensor that collects data about the physical world, like an RFID reader or temperature sensor. After receiving observations from the readers, the event manager component of the middleware aggregates, transforms, or filters them to prepare them for consumption by applications. In addition to making the RFID observations more relevant to applications, the event manager helps reduce the sheer volume of data that the applications must process. The RFID middleware as shown in Figure 2-8 can support reader discovery, provisioning, monitoring, and management: provide data collection, translation, aggregation, and filtering. The grouping mechanisms are to support service-oriented interfaces using standards such as JSP, JEE, .NET, EJB, and web services; and offer remote provisioning, monitoring, and management capabilities.

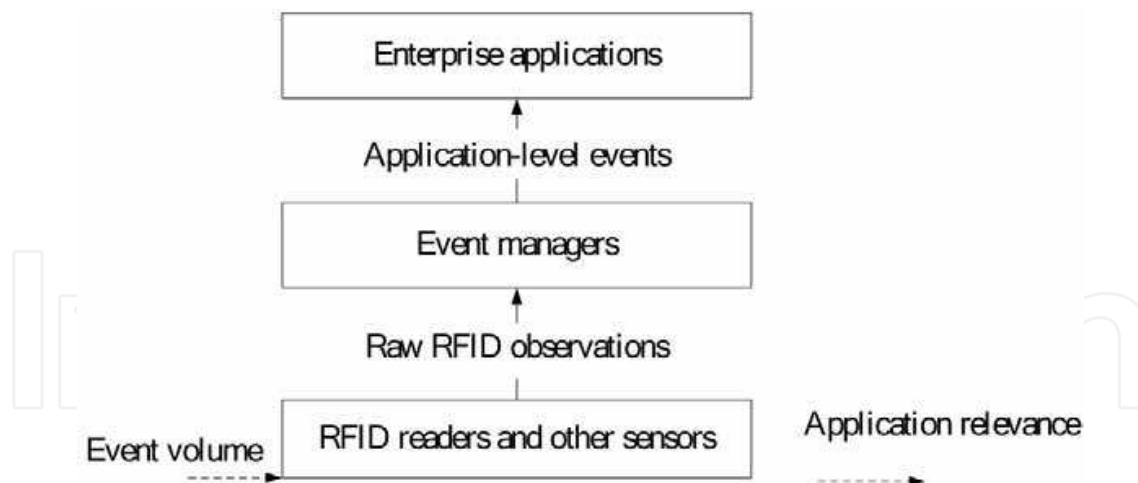

Fig. 2-7. Event volume and relevance through different layers of an RFID system

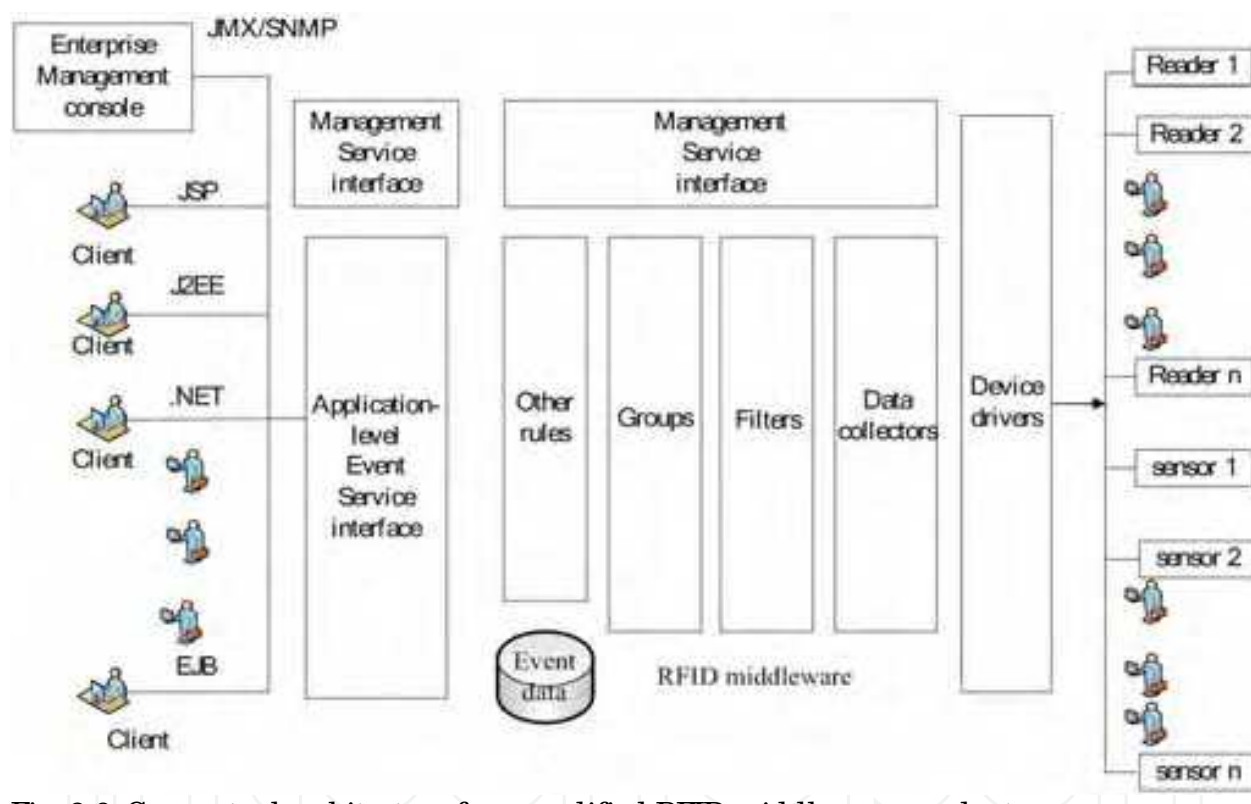

Fig. 2-8. Conceptual architecture for a modified RFID middleware product

### 3. Commercial RFID middleware

A report in ALE-speak is the output from an event cycle, which is returned as an ECRReport instance. A report specification, represented as ECRReportSpec, provides filtering, grouping and other data processing instructions. Figure 3-1 shows the primary data elements.

The EPCglobal’s Application Level Events (ALE) specification defines a reader-neutral interface for receiving events from RFID readers and filtering and grouping them. The remainder of this chapter provides an overview of the ALE 1.0 specification as published by EPCglobal. We’ll describe this specification in considerable detail so that you can familiar

yourself with its key concepts and API, but you should be aware that several vendors' implementations of the ALE specification are available in the market, each providing its own extensions and benefits.

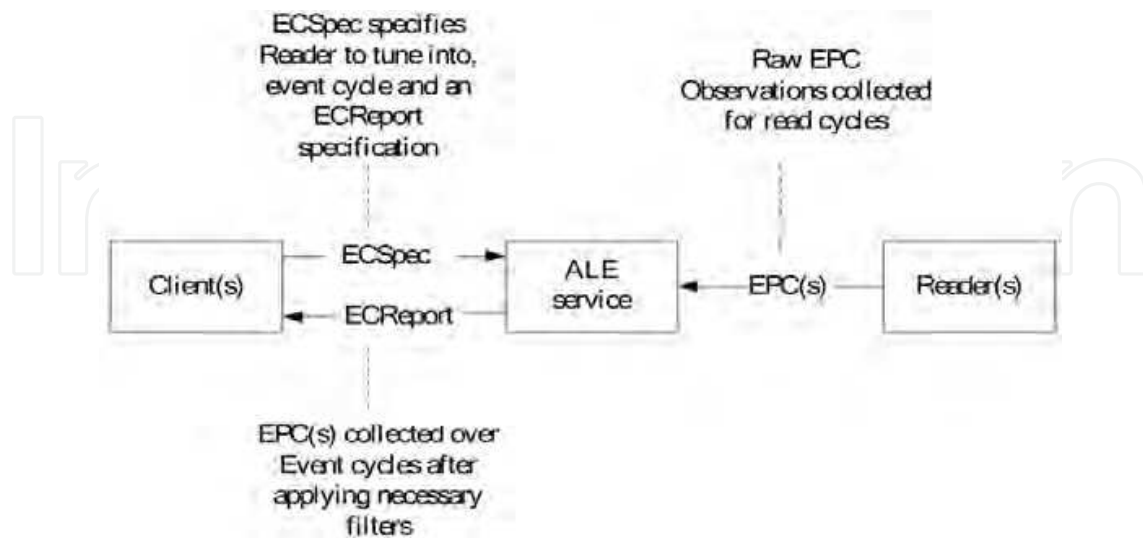

Fig. 3-1. Primary data elements [Source: Glover & Bhatt (2006)]

### 3.1 RFID middleware platform

The main components of the Edge Server offering include the filtering and collection engine (also known as the ALE Engine) and the device management agent. The RFID Tag aware edge server interfaces to a wide variety of popular readers and printers, as well as various sensor inputs that are used as triggers to the reader control. The edge server implements the EPCglobal ALE API and includes extensions for tag writing and other capabilities not yet covered by the standard. Figure 3-2 shows the RFID Tag Aware Middleware Platform.

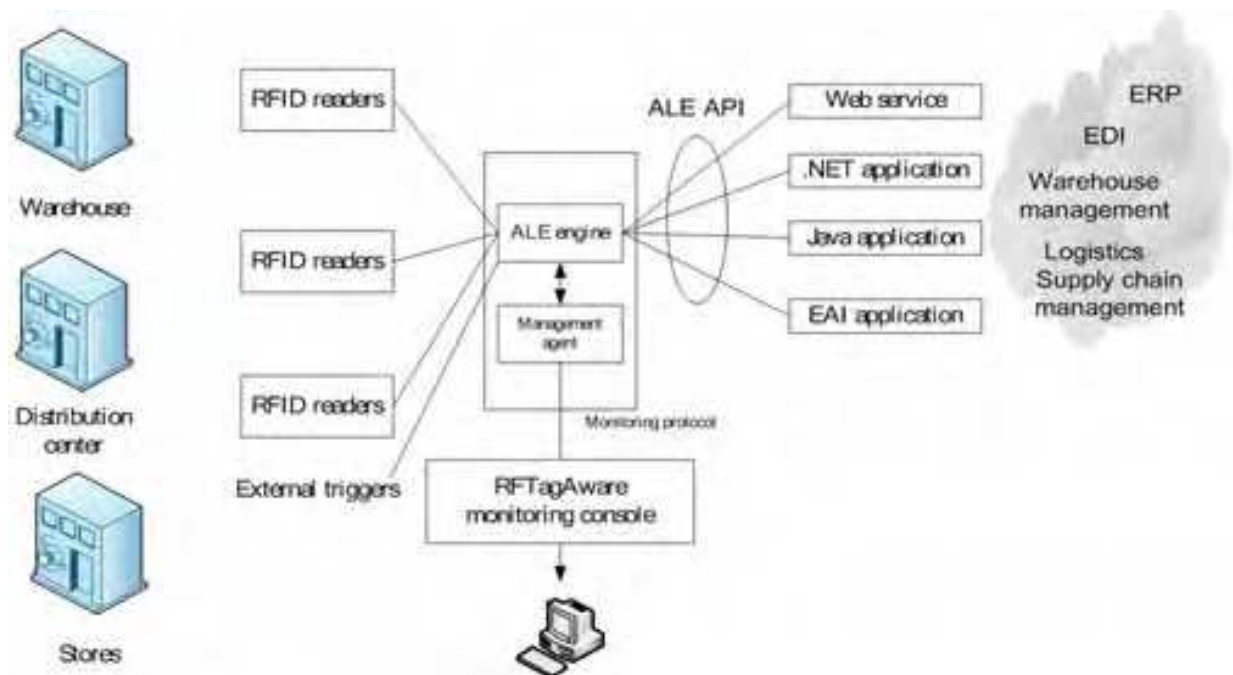

Fig. 3-2. RFID Tag Aware Middleware Platform [Source: Glover & Bhatt (2006)]

### 3.2 Key elements of the EPCIS

The EPCIS defines a standard interface for capturing and sharing EPC-related data. It should be noted that the EPCIS focuses only on the service interface and semantics of EPC-related data, such as location information that gets registered as products move through supply chain. Vendors are provided the flexibility to compete on implementations and add-on functionality. EPC observations are captured using the EPC Capture interface, and they are queried using the EPC Query interface. Additionally, the EPCIS provides a common model for location information and other important data. The EPCIS standards were envisioned for use with events within an organization, where they may be subscribed to or stored and queried, or between companies, where the same operations will be able to take place. The EPCglobal's reader protocol interface insulates the higher layers from knowing what RF protocols and reader makes and models are in use, the EPCIS insulates enterprise system from having to know the details of how individual steps in a business process are carried out. The EPCIS-level data differs from lower layers in the EPC Network Architecture as shown in Figure 3-3 because it incorporates semantic information about the business process in which EPC data is collected and provides historical observations.

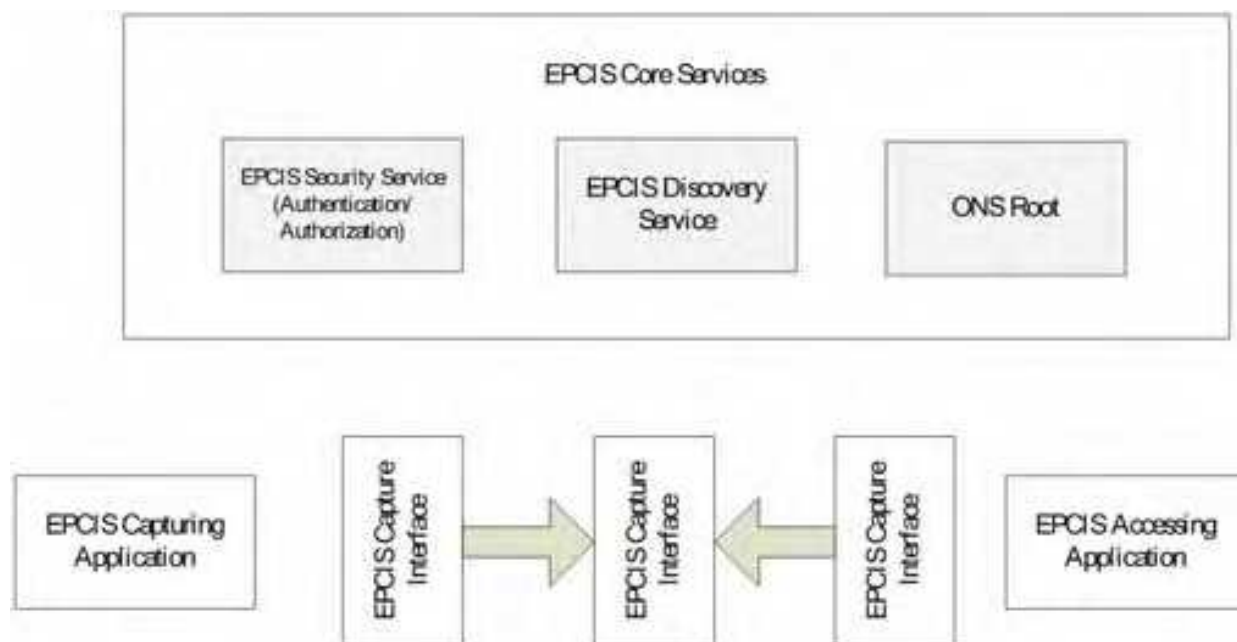

Fig. 3-3. Key Elements of the EPCIS [Source: Glover & Bhatt (2006)]

### 3.3 A typical ONS query

The integrated EPCglobal system architecture proposed by Amerio et al (2007) EPCglobal division has been published in RFID standard. There are five sections as shown in Figure 3-4 to deal with the EPCglobal architecture framework. The first deals with tag emit EPC data and emit detected data. The second is the reader captures events and filtering. The third is Savant server deals with data report, manages readers, and makes an advanced filtering. The fourth is EPCglobal subscriber server deals with cross-enterprise elements (EPC data exchange and EPC object exchange), and the last deal with intra-enterprise elements (EPC Infrastructure).

There is a static ONS that let EPC transfer to the wanted EPC data. Another is the dynamic ONS is to provide founded EPC flow control for tracking. The enterprise's trading needs the action of EPC Access Registry.

### 3.4 Centralized deployment

In the 1980s and 1990s, microcomputers exploded out of the data centers, onto desktops, and into server closets enabling end users in new ways and at the same time bringing new challenges to Information Technology (IT) operations staff. Over the pass few years, most organizations have worked steadily toward a return to more centralized management of computing devices by moving servers out of market shift server closets and into climate-controlled, secure data centers. The advantages of this configuration include more efficient physical access to systems by IT operations staff and increased reliability due to the protection data centers offer from power and temperature fluctuations, dust, and vibration. Improved physical security is an additional benefit of moving all of these servers to a central local within the restricted area. The centralized approach of edge deployment options is shown in Figure 3-6.

## EPCglobal System Architecture

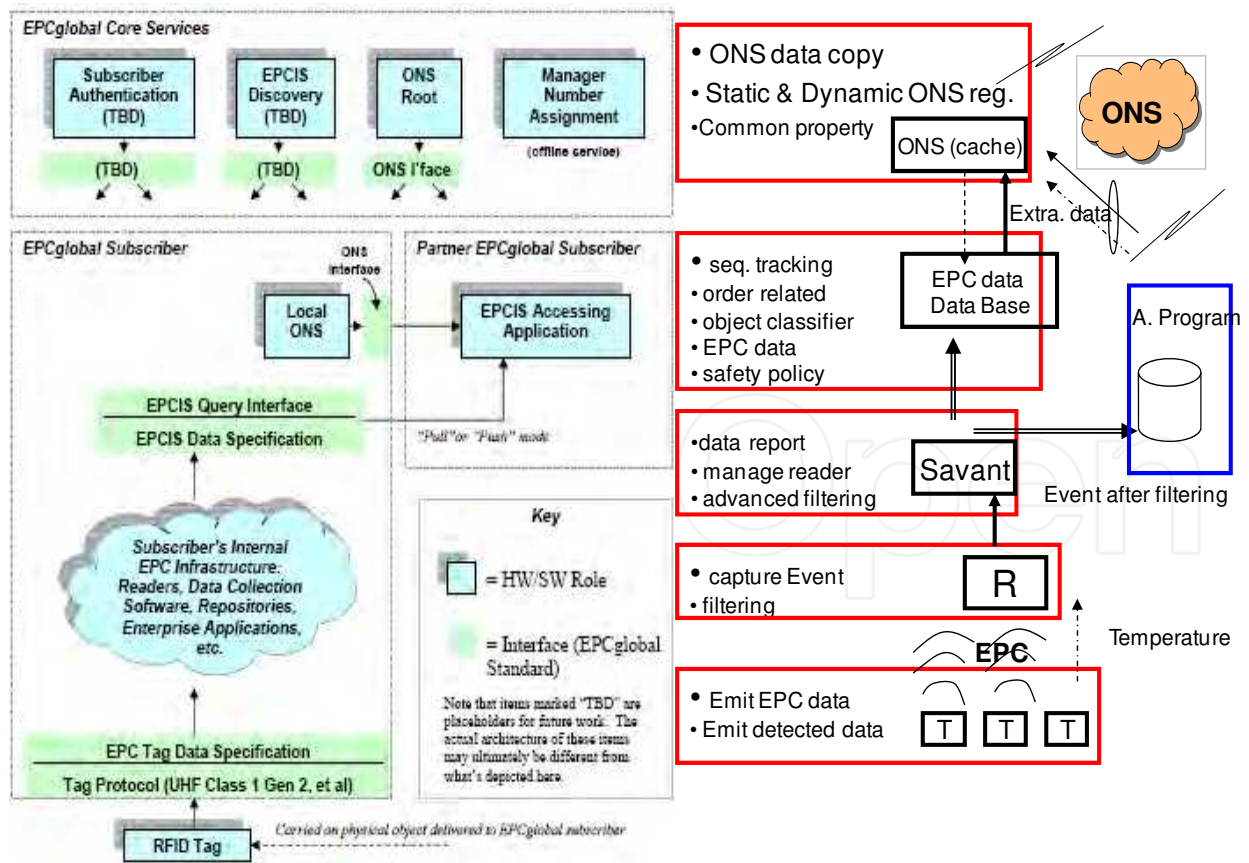

Fig. 3-4. A typical EPCglobal System Architecture

## EPC Network architecture between Enterprises

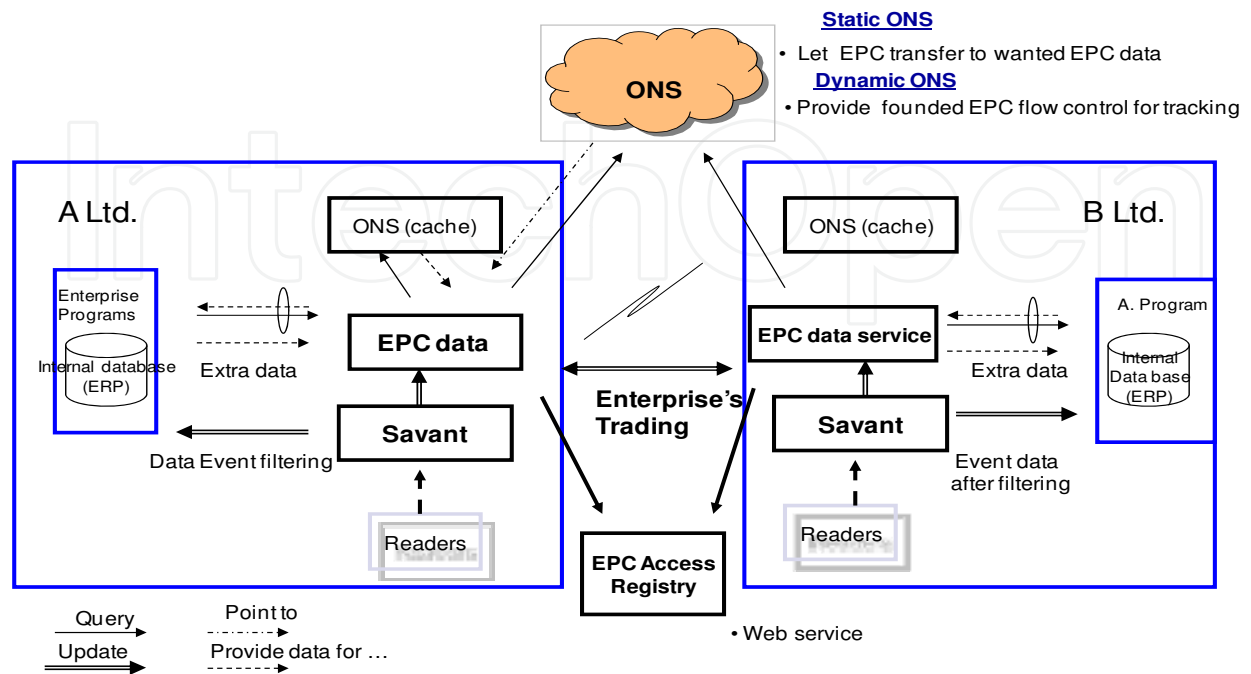

Fig. 3-5. The EPCglobal Network architecture between enterprises

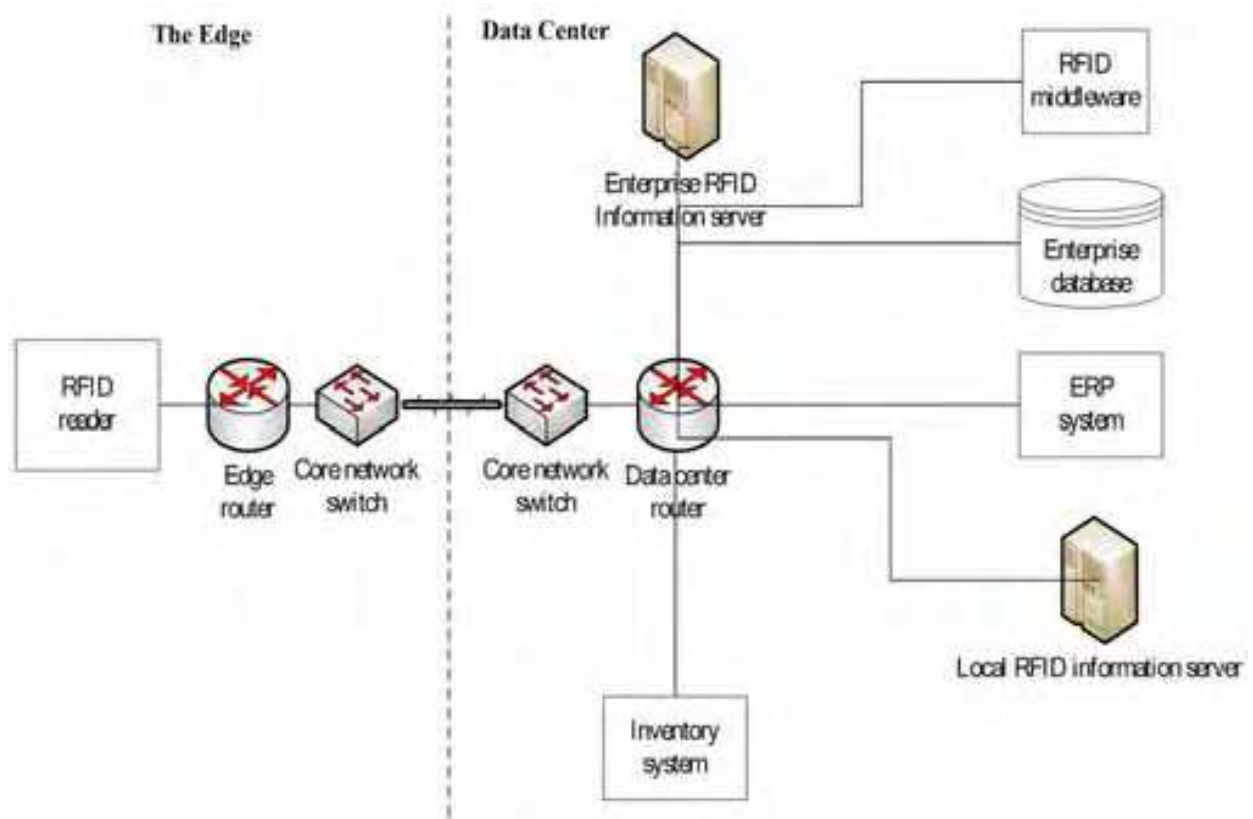

Fig. 3-6. The centralized approach

#### 4. Interface methodology of the system architecture of RFID with the existence of MASIS, SPAS and others

According to the protocol of RFID-aid material information system (RamMIS) and other material-related management system (MASIS, SAPS and others), the lifecycle of material management can be classified into three roles: applicant, material management person, and deploy person. The RFID materials has been classified with an extensive closer look on the relationship of existing material management systems as shown in Figure 4-1. In this section, there is focused on the first item called MASIS for an example of demonstration.

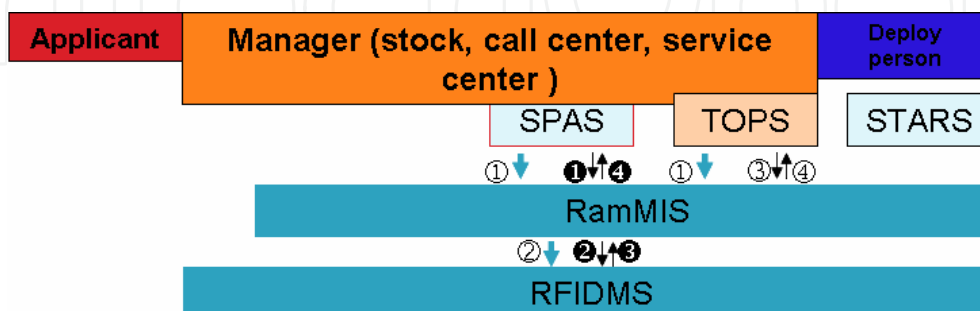

Fig. 4-1. RFID material Management Information System (RamMIS)

Mainly, the electronic Purchasing Information System (ePIS) is the top system for purchasing any possible items for one company. The systems are that Material Acquisition and Support Information System (MASIS), Spare-parts Administration System (SPAS), Top Service System (TOPS), and Survey of Testing And Repairing System (STARS),....

The RamMIS will be designed to be WEB-based with the tools of (Java Server Pages (JSP), Servlets, Java 2 Platform Enterprise Edition (J2EE), and Signed Applets). The J2EE applications will be used for material flow control with Enterprise JavaBeans (EJB). It is the server-side component architecture Java and provides the interface system's info and query response (XML over HTTP).

Thus, the RFID Monitoring System (RFIDMS) is suggested to provide an EPCglobal-like architecture framework, which provides the platform of frontend software/ hardware including tag, reader, and middleware with AP-based gateway and signed applets for other interface systems. At the backend, the softwares shall include ALE, EPCIS database, and EPCIS query interface. The J2EE applications can include receiving the raw data from the feedback of Middleware Servlets, the query of web services, and the alarm message of monitoring system. The EPCglobal-like architecture framework as shown in Figure 4-2 is mainly divided into two parts. The top one is the RamMIS itself. The second is the RFID monitoring system (RFIDMS). The signed-applets are designed for receiving/ applying at stock house, and for other information interface systems. It contains the parts of EPCIS access interface, access/ application interface (ALE) software, filtering/ collecting interface, filtering & collecting (RFID middleware), and reader protocols. The blue color representative represents the interface for EPCglobal standard and brown color represents the hardware/ software. Thus, there are a lot of design work can be done with different requirements for material handling.

The tag, reader, and middleware are the front-end hardware/ softwares. They need AP-based gateway PC and signed applets are used to provide the other interface systems to show their instant information. The ALE, EPCIS database, and EPCIS inquiry interface are the back-end softwares. J2EE applications mainly provide the following functions:

- To receive and process the Servlets of raw data from middleware software.
- To provide the inquiry response of web services from general purpose equipment.
- To provide the maintenance report for alarm message, etc.

The EPCglobal-like architecture framework is shown in Figure 4-2. This framework provides the needs of design items for each different faces on the website.

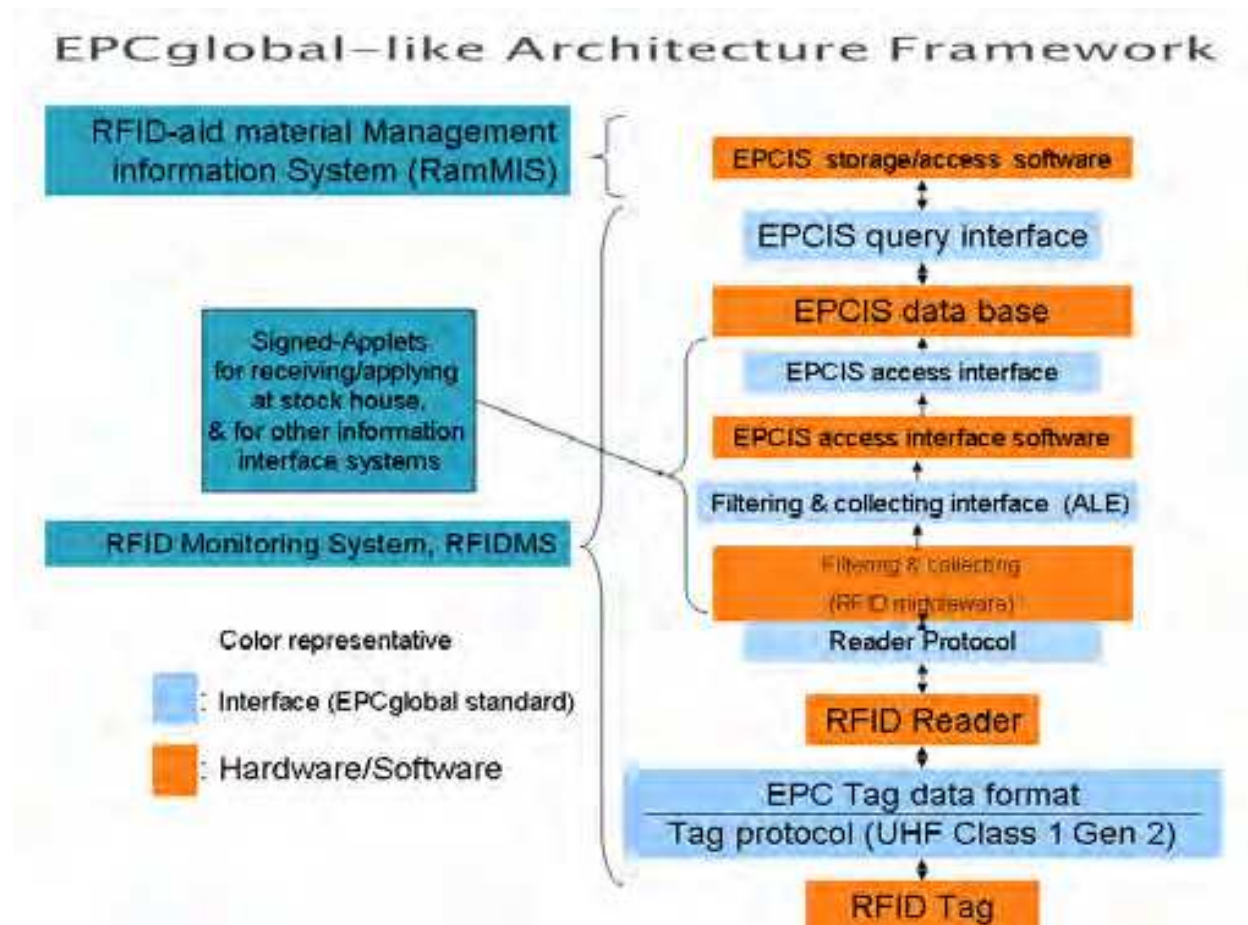

Fig. 4-2. EPCglobal-like Architecture Framework

The RFID-aid material management information system (RamMIS) is designed for RFID serving system. The signed-Applets for receiving/ applying at stock house and for other information serving systems could include the EPCIS access interface, filtering and collecting interface, and filtering and collecting (RFID middleware).

#### 4.1 Timing of message negotiating and usage methods

In the following, we will discuss the timing of message negotiating and then the usage methods.

Timing of Message negotiating

- a. The tag of RFID will have an access signal to the system before purchasing equipment (connecting with MASIS)
- b. confirm with income/ outcome material (connecting with MASIS)
- c. inform after outcome material (connecting with SPAS)
- d. acquisition on material after change (connecting with SPAS)
- e. synchronization with Assembly & removal batches (connecting with SPAS)



f. material status on-line query (connecting with SPAS, STARS, and TOPS ...)

g. Query for basic material information (connecting with STARS, TOPS ...).

RamMIS will connect with all the existing systems with http's packet by the content of XML. The detail is demonstrated as following section. The Functional Structure of RamMIS Website can be designed as Figure 4-3.

### The Functional Structure of RamMIS Website

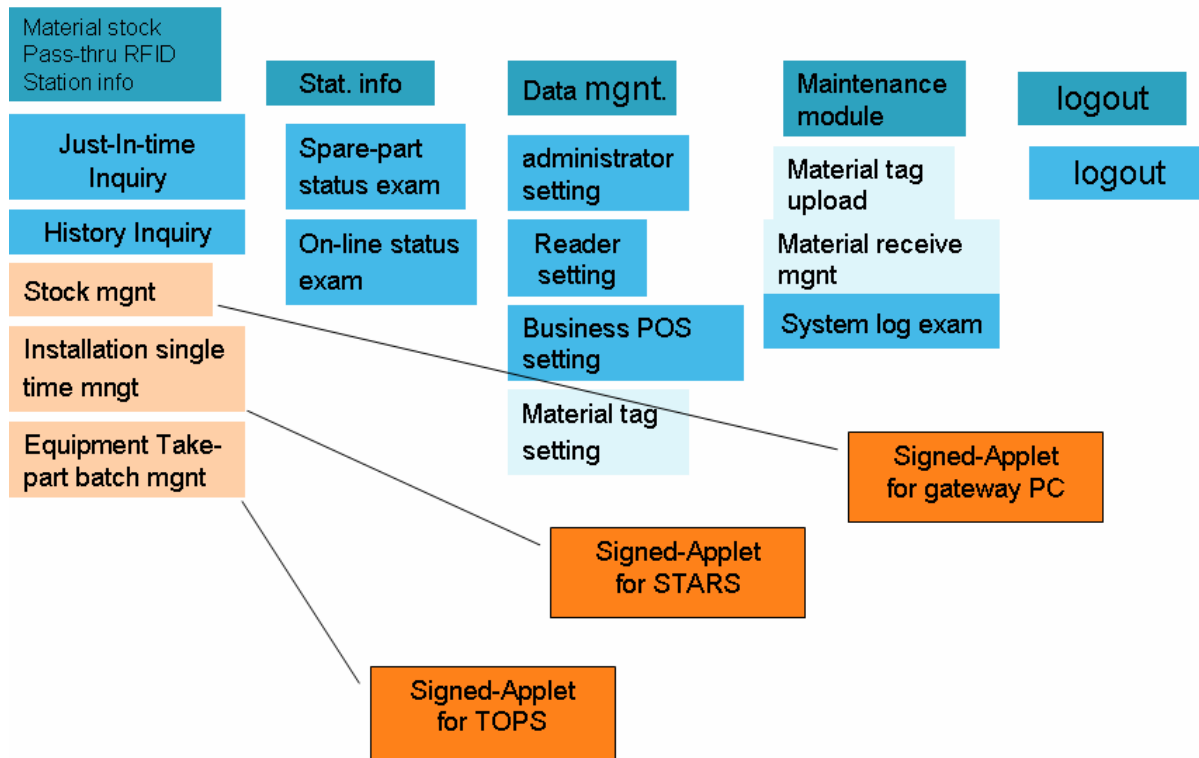

Fig. 4-3. The Functional Structure of RamMIS Website.

#### 4.2 Usage methods for message negotiating

##### A. [RBN\*, RBR\*] XML over HTTP POST

\*: Please refer to Table 4-1 for more detail explanations.

MASIS needs to inform the RFID platform when, what, and where to have RFID elements. RamMIS responds the processing result whether it successes or not. If it is wrong, RamMIS shall response the reasons.

##### B. [RCQ\*, RCR\*] xml over Http

RFID related gateway PC needs to wait for the lists of monitoring tag. RFID platform is immediately response the reader's results.

##### C. [RBN\*, RBR\*] XML over http

MASIS needs to inform RFID platform when, what, and where to have RFID elements. RamMIS responds the processing result whether it successes or not. RamMIS responds the processing result whether it successes or not. If it is wrong, RamMIS shall response the reasons.

##### D. [RCQ\*, RCR\*] XML over HTTP

RFID related gateway PC needs to wait for the lists of monitoring tags. RFID platform shall respond MASIS what the reading results of materials.

**E. [CBS\*, CBR\*, RSQ\*, RSR\*] XML over HTTP**

SPAS needs to ask the RFID platform to ask what kinds of materials, when will be here recently, and where the place will be? The batch response will follow the process of from the sequence of SPAS > RamMIS > SPAS.

**F. Signed applet, [RSQ\*, RSR\*, PIQ\*, PIR\*, PIP\*] XML over HTTP**

STARS may consider the platform of RFID and enquiry the basic materials by tag ID. SPAS will require informing the RFID platform of information by tag ID.

**G. Signed applet, [RSQ, RSR, PIQ, PIR, PIP] XML over HTTP**

TOPS or SPAS will response the batch information by RFID platform. TOPS will require executing the batch information. TOPS will require the basic information by tag ID from RFID platform. SPAS will require the basic information by tag ID from RFID platform. The relationship of websites for different management systems is shown in Figure 4-4.

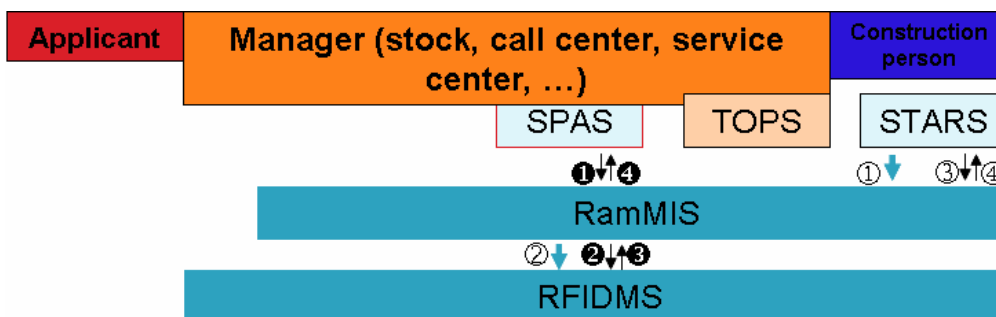

Fig. 4-4. The relationship of websites for different management systems

The material monitoring flow of RFID Monitoring System (RFIDMS) is shown in Figure 4-5.

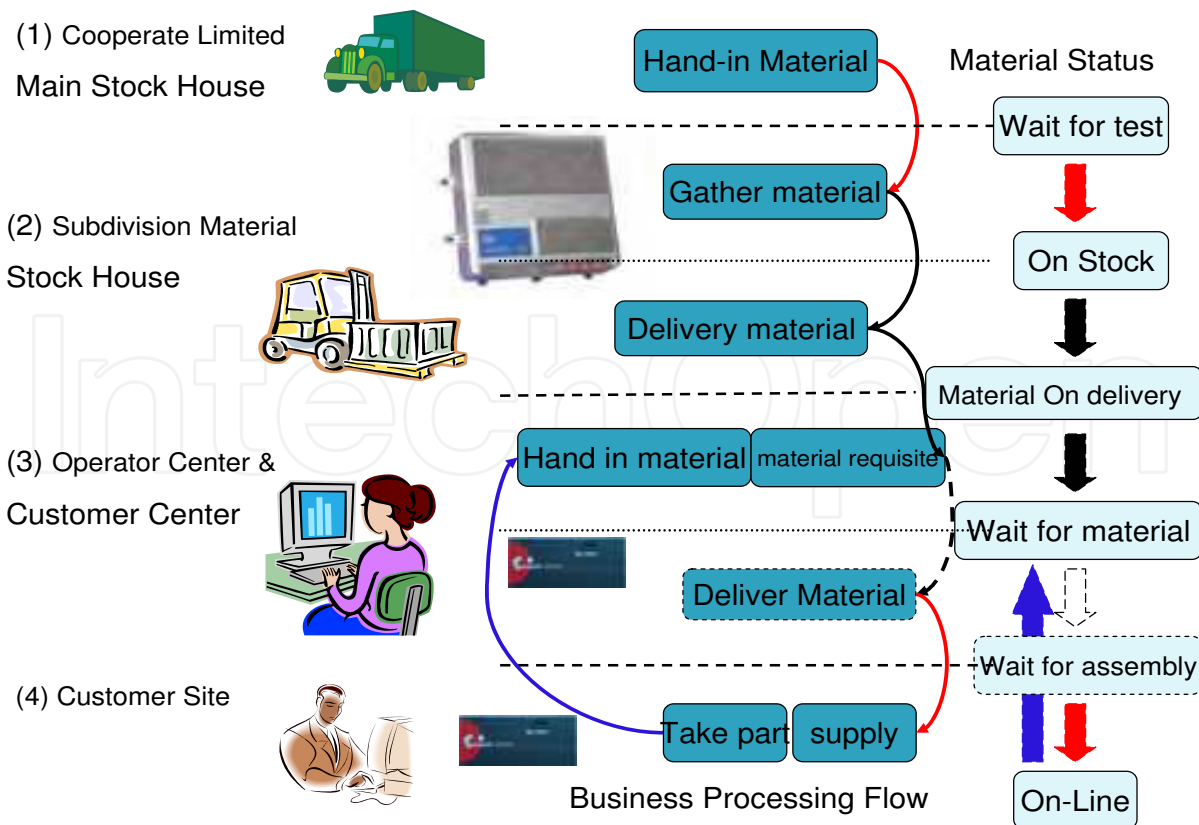

Fig. 4-5. RFID materials monitoring flow

The sequence is mainly followed from the main stock house, to subdivision house, operator center and customer center, and customer's site. The material status begins from wait for test, on stack, material on delivery, wait for material, and wait for assembly, etc. One can check the status from on-line website such that he/ she may understand how long he/ she needs to wait. The service center can make arrangement for the installation person to customers to install their equipments. Thus, it is a good service for both sides. The managers also can know how many items left for future installation. If he/ she wants to meet the requirements of installation, managers can easily plan the purchase orders according to the life cycles of equipments for the future.

The abbreviations of the mentioned symbols will be listed as the following table 4-1.

Seq.	Module	Abbr.	Message function
1	Inform before materials get in	<b><u>RBN</u></b>	MASIS delivers material input (/ apply material) message to RamMIS.
		<b><u>RBR</u></b>	RamMIS delivers back the processing results to MASIS.
2	Acknowledge before materials get in	<b><u>RCQ</u></b>	MASIS delivers materials get in (output) inquiry to RamMIS.
		<b><u>RCR</u></b>	RamMIS delivers back materials get-in message to MASIS.
3	Inform after materials leave	<b><u>OAN</u></b>	RamMIS delivers out the message of materials leaving SPAS.
		<b><u>OAR</u></b>	SPAS delivers back the processing result to RamMIS.
4	Inform material change	<b><u>ICN</u></b>	RamMIS delivers out the message of material exchange SPAS.
		<b><u>ICR</u></b>	SPAS delivers back the processing results to RamMIS.
5	Install, tease, & move (ITM) batch synchronously	<b><u>CBS</u></b>	SPAS delivers out the batch message of RamMIS
		<b><u>CBR</u></b>	RamMIS deliver back the processing results to SPAS.
6	Material instant condition enquiry	<b><u>RSQ</u></b>	Client system delivers out the instant condition enquiry message to RamMIS.
		<b><u>RSR</u></b>	RamMIS deliver back the processing results to Client system.
7	Material basic information enquiry	<b><u>PIQ</u></b>	Client system delivers the message of basic information to RamMIS.
		<b><u>PIR</u></b>	RamMIS delivers back the enquiry result to Client system
		<b><u>PIP</u></b>	RamMIS actively response basic material info to Client.

Table 4-1.

## 5. System integration test

### 5.1 Material gets in information

1. Applicant login the website of RamMIS and feeds in the file of RFID tag's information.
2. Before MASIS system gets in the materials, it needs to send **RBN** message to RamMIS system.
3. RamMIS system receives the notice, proceeds to relative records to monitor, and responds **RBR** message to MASIS system.



Fig. 5-1. RFID material hand-in notice

### 5.2 material get-in acknowledgement

1. Material manager needs to login RamMIS system first and execute the operation of RFID gateway reading.
2. Material manager needs to login MASIS system and make sure the reception is OK, then, MASIS needs to send **RCQ** message to RamMIS.
3. RamMIS system receives the message of acknowledgement and then transfer to the platform of RFIDMS.
4. The platform of RFIDMS receives the message back to RamMIS system, and then RamMIS transfers the **RCR** message to MASIS system.

It is shown as Figure 5-2.



Fig. 5-2. RFID material get-in acknowledgement

### 5.3 Notice before apply material

1. Before MASIS system applies for materials, it shall send **RBN** message to RamMIS.
2. When RamMIS system receives the notice, it needs to relative records to ne monitored, and respond to **RBR** message to MASIS.

It is shown as Figure 5-3.

### 5.4 Acknowledge when materials leave the stock house

1. Manager needs to login RamMIS system to execute RFID gateway reading procedure.
2. Manager again login MASIS system and make sure the acknowledgement is OK when materials leave the stock house.
3. RamMIS system receives the out source message and ask again to RFIDMS platform.
4. RFIDMS platform will send the message back to RamMIS system, then, RamMIS system replies **RCR** message to MASIS system.

It is shown as Figure 5-4.

### 5.5 Inform when material gets out

1. After RamMIS system the material gets out, it needs to send **OAN** message to SPAS system.
2. After SPAS system receives a notice, SPAS needs to precede the relative records and send **OQR** message back to RamMIS system.

It is shown as Figure 5-5.



Fig. 5-3. Notice before apply material



Fig. 5-4. Acknowledge when materials leave the stock house

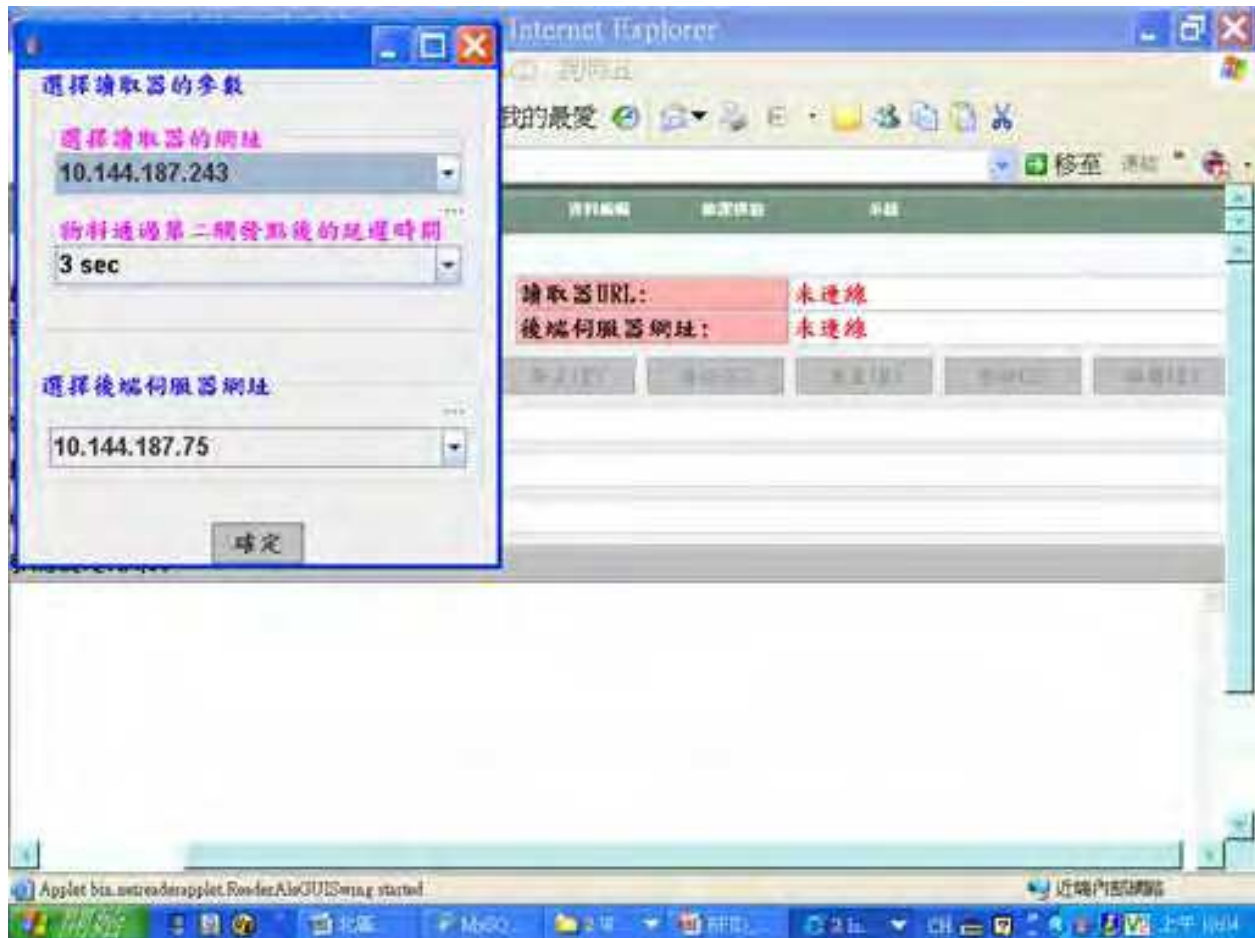

Fig. 5-5. Inform when material gets out

### 5.6 Information notice for material change

1. After materials get out, if the users login RamMIS system, the total numbers of RFID's tag will be changes. RamMIS system will send the message to **ICN** to SPAS system.
2. SPAS system receives the notice and execute the recording the relative work of managements, and send **ICR** message to RamMIS system.

It is shown in Figure 5-6.

## 6. Conclusion

In this chapter, we propose an example of handling expensive materials using RFID technological approach on an open platform environment and follow the standardization of EPCglobal Gen II. We discuss the integration case for the case of centralized deployment.

We also discuss the general cases in the future. We hope to have a good reference site for your design. The high unit price and big volume materials have an urgent request to have a clear request on input/output information needed by operating units, which is not dependent on a specific mobile network and is interoperable with other ad hoc material operating systems, like some existing softwares. One can design an interface based on integrated database for existing material management systems. It can develop and

implement a case level and item level management for expensive materials based on RFID platform on line.

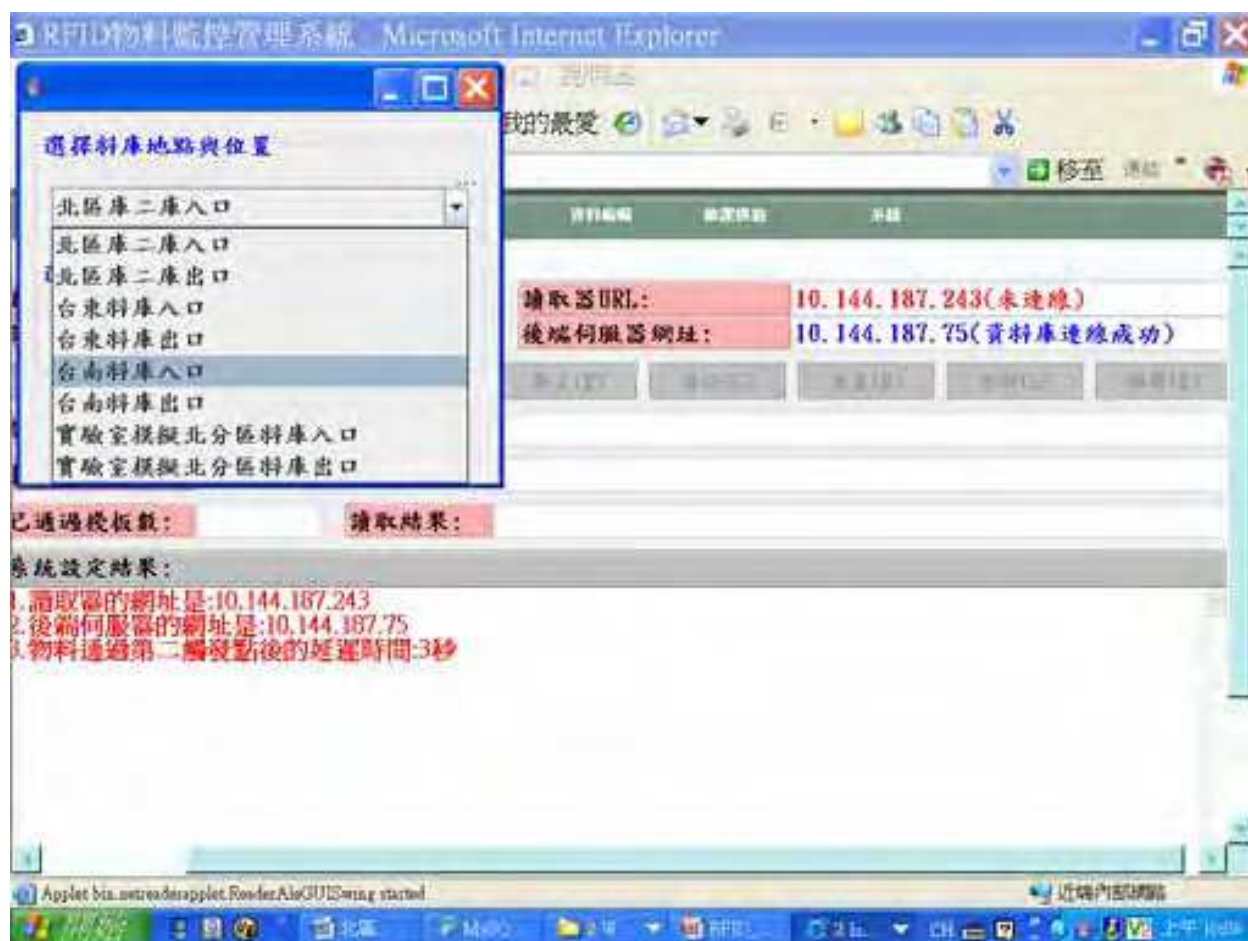

Fig. 5-6. Information notice for material change

## 7. References

- Amerio, F. etc. (2007). The EPCglobal Architecture Framework, p.27, [http://www.epcglobalinc.org/standards/architecture/architecture\\_1\\_2-framework-20070910.pdf](http://www.epcglobalinc.org/standards/architecture/architecture_1_2-framework-20070910.pdf).
- Finkenzeller, K. and Waddington (2003). R. RFID Handbook, *Jhn Wiley* p61-159.
- Golden, P. Dedieu, H., and Jacobsen, K.S. (2007/ 10). *Implementation and Applications of DSL Technology*. CRC Press, Auerbach Publication. P.448.
- Glover, B. and Bhatt, H. *RFID Essentials* (2006). O'Reilly, Media, Inc.
- Tenqchen, S., Y.-K. Huang, H.-H. Huang, F.-S. Chang, K.-Y. Chen, Y.-K. Tu, C.-H. Wang, Y.-C., Lee, C.-H. Lee, S.-L. Tung, P.-C. Chi, "Design of Middleware Using RFID Reader and Tag to Collect Traffic Information Implemented on Urban-bus for Intelligent Transportation System Application," *Proceedings of 14<sup>TH</sup> World Congress on ITS 2007, Oct.9-12*.
- Tenqchen, S. Y.-K. Huang, C.-H. Lee, W.-S. Feng, C.-K. Wang "Design of Middleware with EPC global by Using RFID Reader and Tag to Collect Traffic Information



Implemented on Urban-bus," *Proceeding of International Conference on Signal Processing and Communication Systems*, Australia, Gold Coast, 17-19 December 2007.

IntechOpen

IntechOpen



## **Development and Implementation of RFID Technology**

Edited by Cristina Turcu

ISBN 978-3-902613-54-7

Hard cover, 450 pages

**Publisher** I-Tech Education and Publishing

**Published online** 01, January, 2009

**Published in print edition** January, 2009

The book generously covers a wide range of aspects and issues related to RFID systems, namely the design of RFID antennas, RFID readers and the variety of tags (e.g. UHF tags for sensing applications, surface acoustic wave RFID tags, smart RFID tags), complex RFID systems, security and privacy issues in RFID applications, as well as the selection of encryption algorithms. The book offers new insights, solutions and ideas for the design of efficient RFID architectures and applications. While not pretending to be comprehensive, its wide coverage may be appropriate not only for RFID novices but also for experienced technical professionals and RFID aficionados.

### **How to reference**

In order to correctly reference this scholarly work, feel free to copy and paste the following:

Shing Tenqchen, Chui- Yu Chiu and Saad Laraqui (2009). RFID System Integration Design with Existing Websites via EPCglobal-like Architecture for Expensive Material Handling, Development and Implementation of RFID Technology, Cristina Turcu (Ed.), ISBN: 978-3-902613-54-7, InTech, Available from: [http://www.intechopen.com/books/development\\_and\\_implementation\\_of\\_rfid\\_technology/rfid\\_system\\_integration\\_design\\_with\\_existing\\_websites\\_via\\_epcglobal-like\\_architecture\\_for\\_expensive\\_](http://www.intechopen.com/books/development_and_implementation_of_rfid_technology/rfid_system_integration_design_with_existing_websites_via_epcglobal-like_architecture_for_expensive_)

**INTECH**  
open science | open minds

### **InTech Europe**

University Campus STeP Ri  
Slavka Krautzeka 83/A  
51000 Rijeka, Croatia  
Phone: +385 (51) 770 447  
Fax: +385 (51) 686 166  
[www.intechopen.com](http://www.intechopen.com)

### **InTech China**

Unit 405, Office Block, Hotel Equatorial Shanghai  
No.65, Yan An Road (West), Shanghai, 200040, China  
中国上海市延安西路65号上海国际贵都大饭店办公楼405单元  
Phone: +86-21-62489820  
Fax: +86-21-62489821

© 2009 The Author(s). Licensee IntechOpen. This chapter is distributed under the terms of the [Creative Commons Attribution-NonCommercial-ShareAlike-3.0 License](#), which permits use, distribution and reproduction for non-commercial purposes, provided the original is properly cited and derivative works building on this content are distributed under the same license.

IntechOpen

IntechOpen