

# We are IntechOpen, the world's leading publisher of Open Access books Built by scientists, for scientists

4,800

Open access books available

122,000

International authors and editors

135M

Downloads

Our authors are among the

154

Countries delivered to

TOP 1%

most cited scientists

12.2%

Contributors from top 500 universities



WEB OF SCIENCE™

Selection of our books indexed in the Book Citation Index  
in Web of Science™ Core Collection (BKCI)

Interested in publishing with us?  
Contact [book.department@intechopen.com](mailto:book.department@intechopen.com)

Numbers displayed above are based on latest data collected.  
For more information visit [www.intechopen.com](http://www.intechopen.com)



# Development of Adaptive Construction Structure by Variable Geometry Truss

Fumihiko Inoue

*Technical Research Institute, Obayashi Corporation  
Japan*

## 1. Introduction

Recent years have seen an increasing variety of attractive structures and building with movable functions worldwide (Ishii, 1995). Typical examples are bridges that open to allow ships to pass, revolving restaurants on tops of buildings, sliding roofs of baseball and soccer dome stadiums, and artistic monuments. When we focus on the moving behaviour of these structures, they simply move on rails or turn around a hinge, but do not change in structural shape. That is, their behaviours are not flexible, but monotonous according to a decided pattern. However, in the near future, it may become possible to devise structures with a lively motion, freedom as well as intelligence. In particular, they will respond to voice commands with instant and adaptive shape change harmonising with their environment.

One mechanism that enables more complicated movement is the Variable Geometry Truss, we call VGT in the chapter. The VGT is a very simple truss structure composed of extendable members, fixed members and hinges, as shown in Fig.1. By controlling the lengths of the extendable members, it is possible to create various truss shapes. The VGT was originally developed as a movable actuator for a spread-type universe construction in space, and it was equipped with a small motor to perform various tasks (Natori & Miura, 1994). Thus, it is considered to be a useful structural tool in various fields as a redundant intelligent structure.

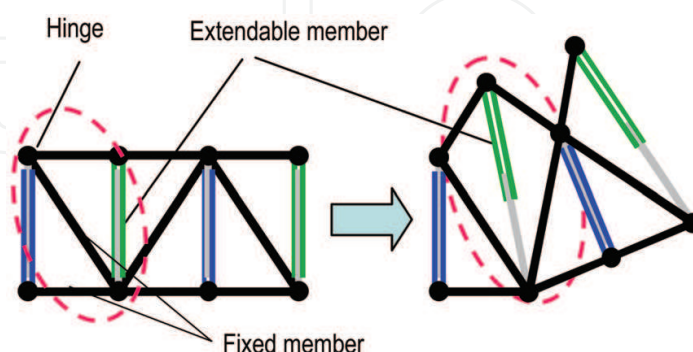

Fig. 1. Basic Mechanism of VGT and Its Shape Change

An example of the shape changes of a simple beam that combines two-dimensional VGTs is shown in Fig.2. When extendable members are extended simultaneously, the truss beam changes like a spring stretching from (a) to (b). When extendable members are extended

alternately, the truss beam changes to a circular shape (c). Moreover, when they are extended optionally and their lengths are controlled, the truss beam can be changed into any intended shape (d). Based on the shape change of such a basic beam, the feasibility of the shape change in an actual building is examined.

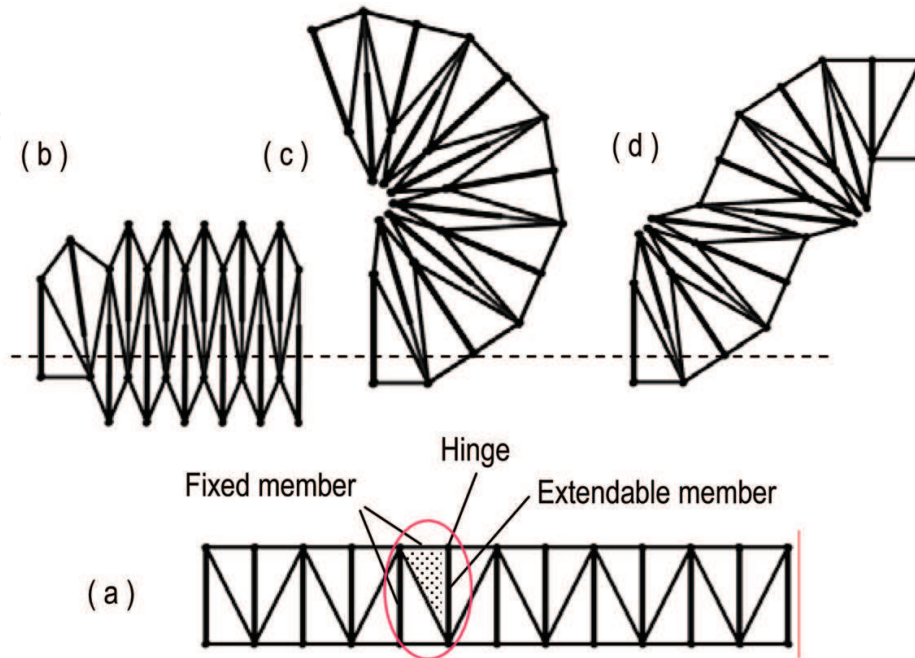

Fig. 2. Transformation of Beam Shape Using VGT

The purpose of this study was to apply VGT technology to ground construction structure and to examine the development of the element technique and its applicability to moveable structures and building by numerical and experimental analysis. In this chapter, the basic characteristics and analysis of VGT mechanism and two practical examples of adaptive construction structure using VGT are introduced. One example is a unique proposition of the elementary design of a semi-empirical dome with an adaptive roof (Inoue & Kurita, 2003), and the other is a new development of a cantilever-type movable monument exhibited at the 2005 International Expo in Aichi Japan (Inoue & Kurita, 2006). From these examples, the attraction and efficiency of VGT mechanism are verified in details.

## 2. Characteristics and analysis of VGT mechanism

### 2.1 Shape analysis of VGT mechanism

In the shape analysis of a VGT mechanism, direct kinematics and inverse kinematics analyses are generally used. For the former, the shape is solved by kinematics analysis, and for the latter; numerical analysis is needed because the shape creates a very highly redundant structure.

#### 2.1.1 Direct motion analysis

The structural units of the two-dimensional VGTs and the whole structure are shown in Fig 3. Each VGT unit is composed of two sets of fixed member and extensible actuators. Then, the whole of the structure can replace a robot manipulator combining two fixed members in series. The tip of the  $x, y$  co-ordinates of the structure combined with  $n$  ( $n > 2$ ) VGT sets is

given by equations (1) and (2) using each hinge angle  $\theta_j$ . The length of the extendable member is easily found in giving  $\theta_j$  and the shape of structure can be uniquely fixed

$$q_{x,n} = l_0 \cdot \sum_{k=0}^n \cos \left[ \sum_{j=0}^k \theta_j \right] \quad (1)$$

$$q_{y,n} = l_0 \cdot \sum_{k=0}^n \sin \left[ \sum_{j=0}^k \theta_j \right] \quad (2)$$

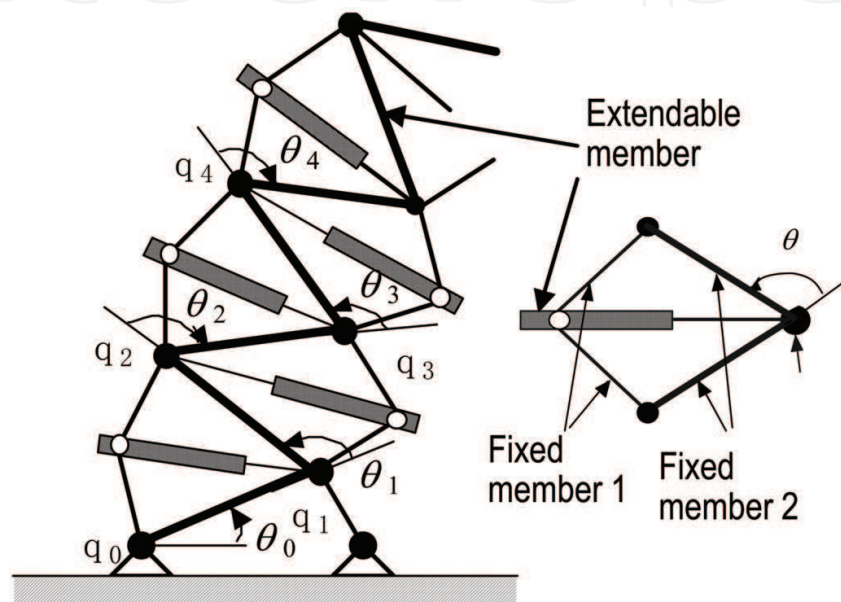

Fig. 3. Two- dimensional VGT Unit and Analysis Model

### 2.1.2 Inverse motion analysis

It is quite difficult to control the extensible length of each VGT to change it to the intended structural shape. In considering the temporal change of the whole of the structure, equation (3) is obtained.

$$\dot{q} = J(\theta) \cdot \dot{\theta} \quad (3)$$

Where,  $J$  indicates the Jacobean Matrix ( $2 \times n$ ). In this case, an inverse matrix isn't necessarily decided because  $J$  is not a regular system in  $n \neq 2$ . Here, it finds  $\theta$  by numerical simulation from  $q$  using the pseudoinverse matrix  $J^\#$  shown by equation (4)

$$J^\# = J^T (J \cdot J^T)^{-1} \quad (4)$$

### 2.2 Dynamic analysis of VGT mechanism

To actually design a structure using VGTs, a motion dynamic analysis must be carried out. This is the external force acting on the structure and the torque power for its shape change.

In the analysis, a model replacing the VGT with a multi-joint manipulator and with a onedimensional tree shape structure was proposed. Using Kane's method and Lagrange's method, the final dynamical equation is as showing the equation (5).

$$M\ddot{q} + h(q, \dot{q}) + c(q) = \tau \quad (5)$$

where  $M$  is the inertia matrix,  $h(q, \dot{q})$  is the vector of  $q$  centrifugal force and Coriolis force,  $c(q)$  is the vector of external force as gravity and  $\tau$  is the vector of driving torque. By solving the equation (5), the motion of the whole structure can be described.

### 2.3 Typical structures changes using VGT mechanism

Two basic structures changes of the cantilever type and arch type is introduced by numerical simulation.

#### 2.3.1 Cantilever structure

Cantilever structure is supported at a single position and a top of the structure is unrestrained from external force. The movement of the structure is thought to be that of a multi-joint robot arms. Fig.4 shows the shape changes of the cantilever structure solved by inverse kinematics. Specifying a top position moving as vector  $q$ , the length of each extensible member is found from equation (3) and the shape of the structure can be fixed at any time. It is easy to create several shapes.

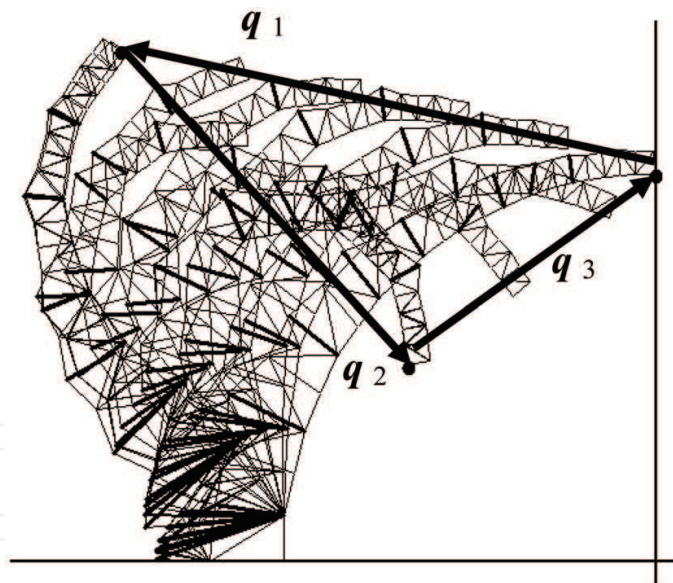

Fig. 4. Shape Change of Cantilever Structure Applying VGT Mechanism

#### 2.3.2 Arch structure

In the arch structure, the two edges of the structure are supported at each hinge. It is very difficult to determine the shape of the structure because these edges are absolutely suited at the hinge position. Fig. 5-(a) shows the shape variations of the arch structure like a big wave change with the lengths of upper side members fixed. In this case, by slightly changing the length of a lower side member near the edge, the lengths of the lower side members are

respectively analyzed by numerical simulation to correspond to the end of the structure in the hinge position. Similarly, Fig. 5-(b) shows volume changes with the extensible members sat on both lower and upper sides. A variable shape structure could be simulated numerically by inverse analysis, although both edges were fixed. In a simulation of volume change, as the lengths of the upper and lower chord members were changed, a flexible member was needed for external finishing (Inoue, 2007).

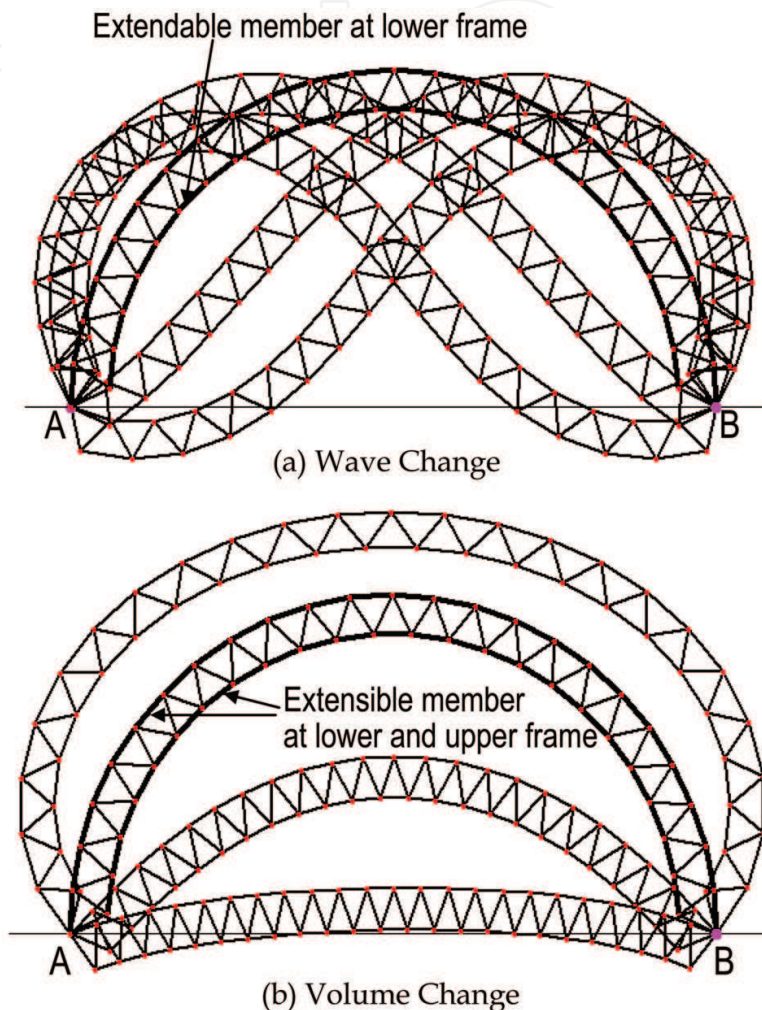

Fig. 5. Shape Change of Arch Structure Applying VGT Mechanism

#### 2.4 Proposition of practical examples using VGT mechanism

The VGT can be used for stress control of a structure in addition to shape control. Thus, it has a wide application. The following are some possible application examples:

1. Facility equipment and temporary structures with moving parts:  
Variable-shaped work gondolas for building walls and flexible roofs in music halls to suit stage contents.
2. Shape control of the structural dome described in paragraph 3 and the pavilion changing the roof shape according to inner environment conditions.
3. Artistic moveable monuments equipped with artificial intelligence harmonizing with the surrounding environment in paragraph 4.
4. Actuators that control the stress and vibration of structure.

### 3. Proposition of a Hemispherical dome with an adaptive roof

#### 3.1 Outline of adaptive roofs dome

To obtain basis data of the VGT structure for design and manufacture, we tried to apply to a adaptive roof dome. This was classified as a cantilever-type VGT. The roofs were opened in floral manner and each roof could change into an optional shape, what we call a “Flowering Dome” as shown in Fig.6. A scale model of an adaptive roof dome was made, and a design technique for the structure, finishing materials and motion control was tested. The doom was composed of a partial roof of 10 sectors. VGT actuators were set in series at the main truss of each partial roof. To describe the roof shape and driving range of the actuator, a motion simulation of the roof was carried out by the advanced method of 2.1 and the results were indicated by a computer graphic. The shape change of from opening to closing of the roofs of the Flowering Dome is shown in Fig. 6. From the simulation, various roof shapes could be created by controlling the extensible length of each VGT.

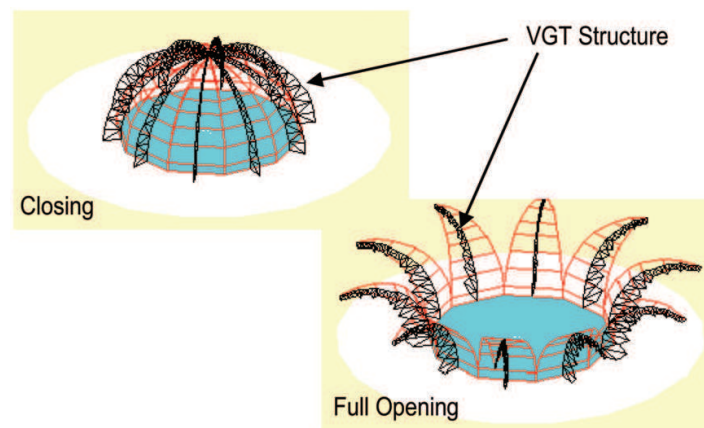

Fig. 6. Computer Simulations of Adaptive Roof Dome

#### 3.2 Outline of adaptive roofs dome

The roof structure was composed between the moving parts containing the VGT actuator and the fixed part of the finishing materials, and these two parts were arranged mutually. The pier type and the chord type were considered for the VGT type, as shown Fig.7. The former used the extensible member for the pier parts (Fig.7-(a)). The roof opened by increasing the length of the extensible member. The latter used the extensible member for the chord parts (Fig.7-(a)). The roof was closed by increasing the length of extensible member. The characteristics of each VGT type were examined by static analysis of several items.

##### 3.2.1 Axial force acted on the extensible member

When changing the roof to all the shapes under self-weight, the relation between the range of the axial force and the length of the extensible member is shown in Fig.8. A large tension force acted on the pier-type extensible member as the roof moved to full opening, whereas lower compression force acted on the chord-type member in the model roof. For full scale, we considered six times the model size for the Flowering Doom, and the range of compression force was much larger. Thus, the force should not act on the extensible member because of the need to avoid extensible member buckling. Therefore, the pier type VGT was more suitable for the dome roof.

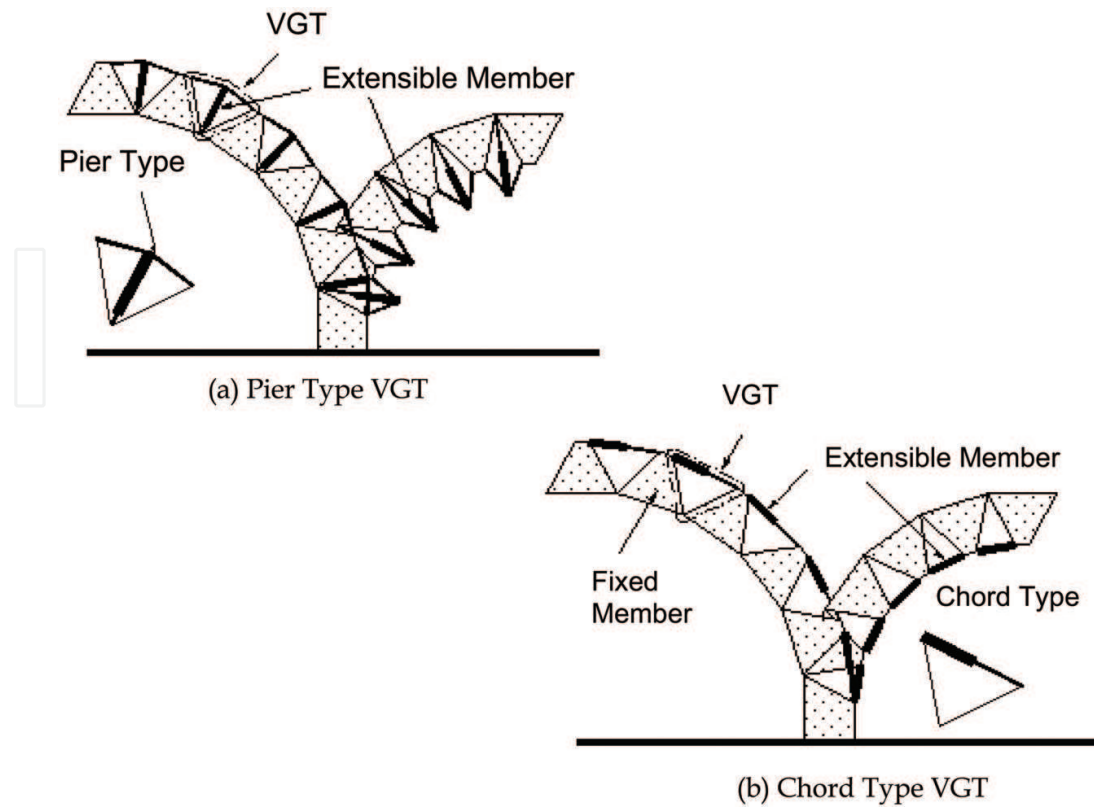

Fig. 7. Composition Type of VGT Arrangement

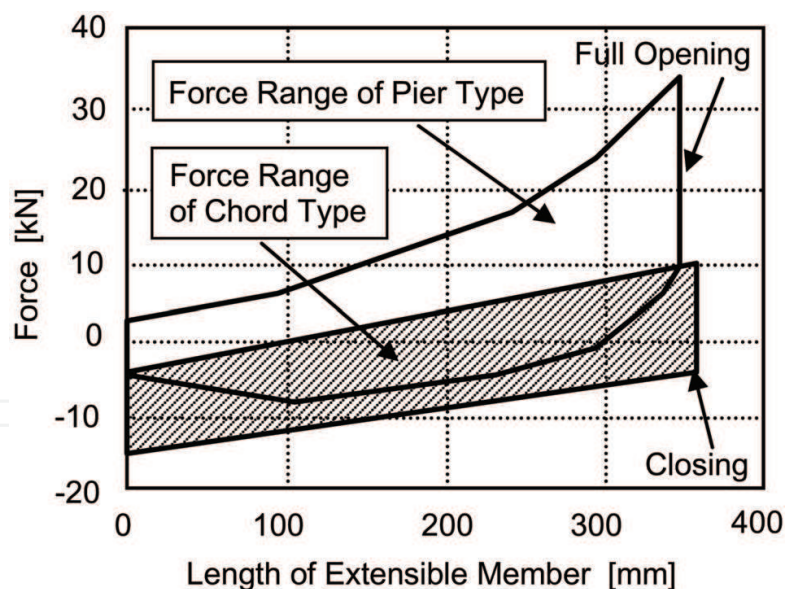

Fig. 8. Comparison of Axial Force Acted on Extensible Member

### 3.2.2 Stiffness of roof and precision of control length

When the roof was moved from closed to full open, the tip displacement stiffness was very important from the viewpoint of structural design. If the pier-type roof shape was similar to the chord-type roof shape, the pier-type stiffness increased with the roof opening and the chord-type stiffness was opposite. However, considering the characteristics of the hydraulic actuator, the pier-type stiffness was showed larger than the chord type at complete closure.



A few errors occurred in the control length of the extensible actuator. For the roof, accumulation error occurred in the position of the tip. The chord-type error was approximately constant regardless of shape change. However, the pier-type error was very small at complete closure. This detail was shown in a previous report (Kurita & Inoue, 2001). From these results, it was decided to use the pier-type VGT because it was superior in static characteristics at completed closure.

### 3.3 Dynamical characteristics acted on VGT roof

As the roof rotated around the VGT hinge, the force and rotation moment, i.e., centrifugal force and Coriolis force acted on the whole roof. In particular, by increasing the length rate, a large dynamic force was activated near the base and the lower extensible member of the roof. In this analysis, an exclusive dynamic software was applied under several conditions with a model of an extensible member as shown Fig.9. Fig.10 shows the force acting on the extensible member under a normal length rate of 5 mm/s. This force was equal to that of the static data, but the dynamic force was influenced near full opening. Fig.11 shows the force acting on the lower extensible member at several length rates. For length rates of 5 through 100 mm/s, the dynamic item wasn't considered. For length rates of more than 200 mm/s, a very heavy force was activated on the extensible member. At full scale, the dynamic force greatly increased. In this case, the extensible member as well as the material design was obliged to resume. Dynamic analysis is indispensable for solving these complicated movements of adaptive structures.

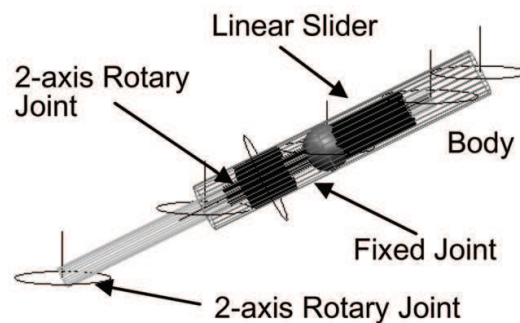

Fig. 9. A Model of an Extensible Member in Dynamic Software

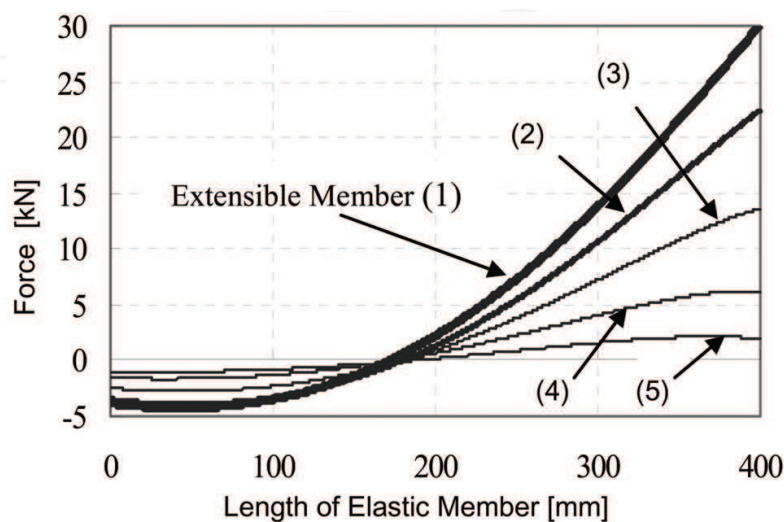

Fig. 10. Dynamical Force Acted on Extensible Member

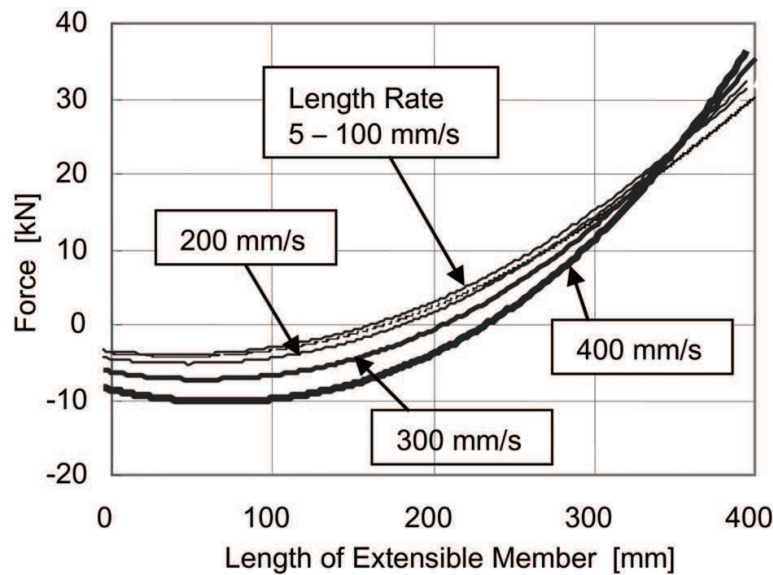

Fig. 11. Dynamical Force Acted on Extensible Member to Length Rate

### 3.4 Experimental evaluation by a reduced dome model

The composition of the partial roof for the Flowering Dome and the whole of the model roof are shown in Fig.12 and Fig.13 respectively. Five sets of pier-type VGT were arranged in series at the centre of each partial roof. A solid truss was installed on either side of the VGT and the roof surface was formed. The side truss was installed through the hinge outside the solid truss and each solid truss was joined continuously. The acrylic board, the finishing material, was fixed on the underside of the solid truss. When the roof was closed, the end of the roof on both sides overlapped and was waterproofed. The extensible member was comprised a hydraulic actuator, a trunnion-type special device equipped with a pump and an oil tank.

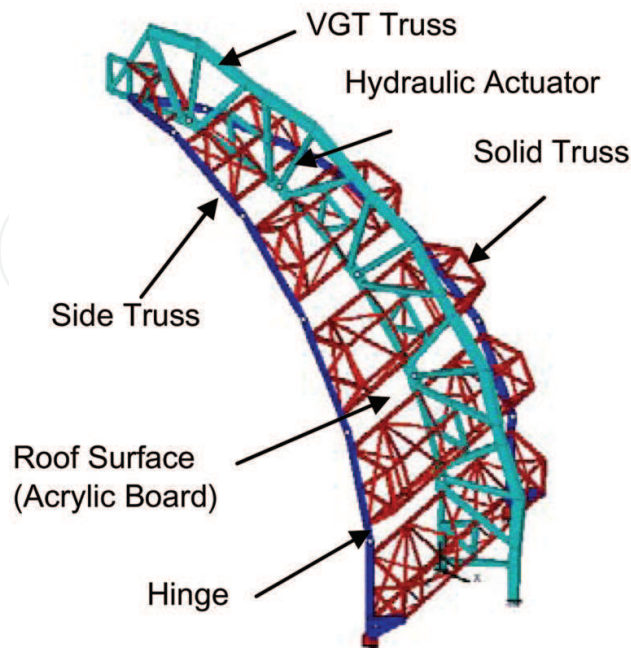

Fig. 12. Roof Structure Installed on VGT Mechanism

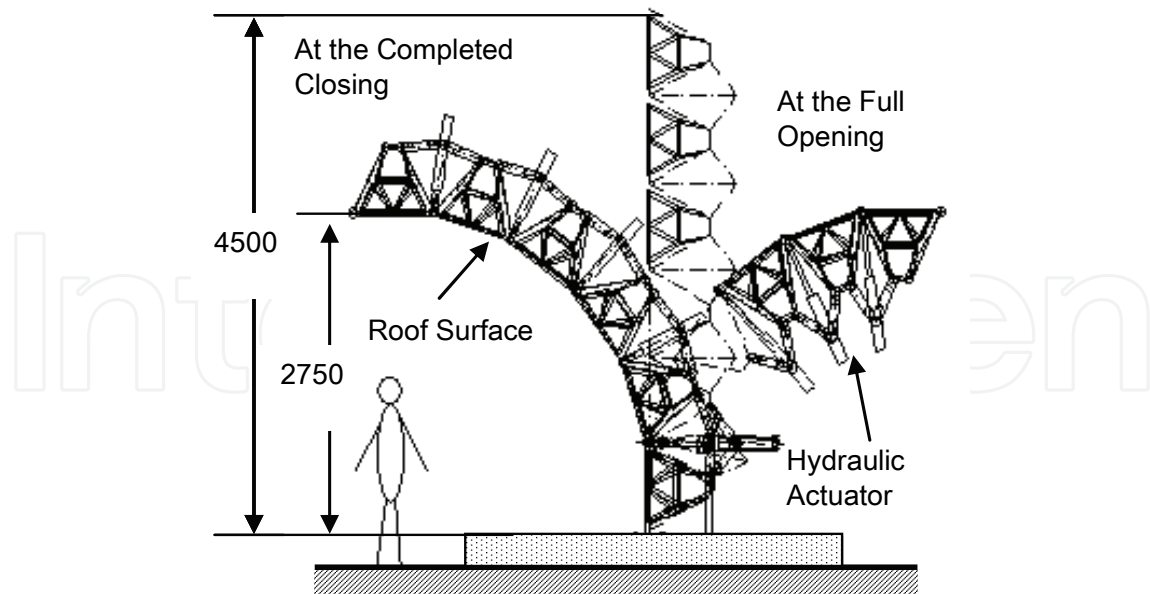
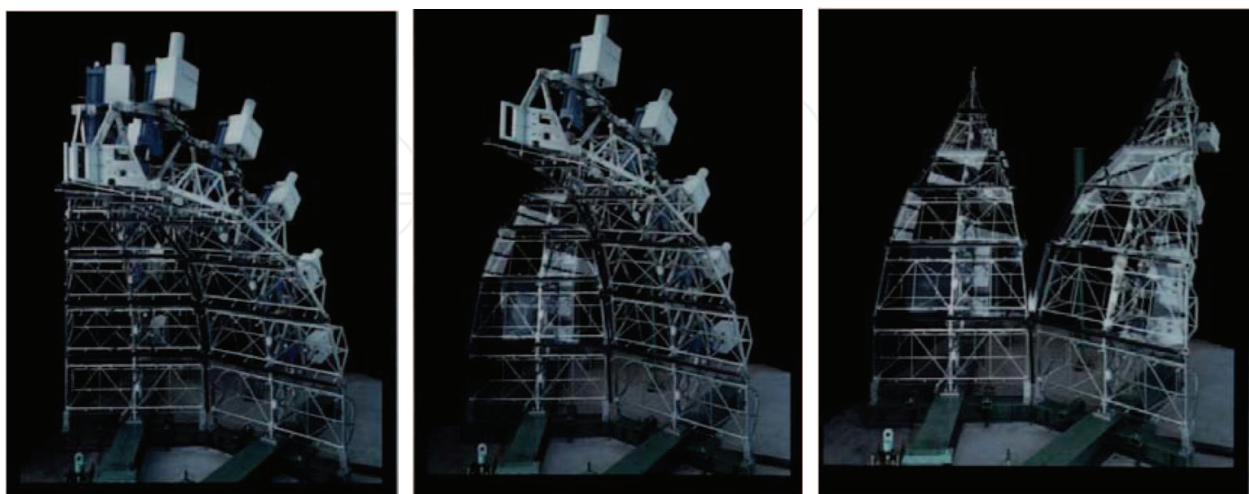

Fig. 13. Schematic Structure of a Reduced Model of Flowering Dome

The extensible length and the hydraulic pressure were measured by a stroke sensor and a pressure gage, and they were controlled by an integrated management system. The model was about 1 / 6 scale and two roof sheets divided into 10 sheets were manufactured.

Fig.14 shows the operating conditions of the moving model roof of a completed Flowering Dome. The length rate of the extensible member was set constant at 5 mm/s. The roof's movement was smooth and it took about 3 minutes to move the roof from fully closed to fully open. The variable structure roof could be set as required by controlling the length of the extensible member. Furthermore, the positioning precision of the tip of each roof was good at closing and it was precise enough to overlap each roof. The scale model verified that the actual adaptive roof dome was possible.



(a) Completed Closing

(b) One of Roof was Closing the Other was Opening

(3) Moving Roofs to Several and Shape

Fig. 14. Operation Condition of a Reduced Model of Flowering Dome

#### 4. Development of a movable monument applying VGT mechanism exhibited in Expo 2005

AS for the other practical example applying VGT mechanism, Development of a movable monument is mentioned in this paragraph.

##### 4.1 Outline of a movable monument

##### 4.1.1 Background and outline of the development

Expo 2005 in Aichi, Japan ended successfully about 3 year ago, with more than two million people attending from around the world. There were various exhibitions, entertainments, attractive buildings, new technology and events based on the theme of "Nature's wisdom". One remarkable technology displayed at the Expo was the application and performance of automated robots. For example, music-playing robots in a group, automatic cleaning robots, guard robots, etc. These scenes might be imagined a the future and such technologies continue to be developed.

In the Japanese zone of the Aichi prefecture pavilion near the center of the exhibition as showing in Fig.15, there was a large monument in the shape of a traditional Karakuri doll beckoning visitors inside. The exhibit here was called "Dancing Tower with Karakuri doll Performance", and was exhibited as a symbol of Aichi district's culture, harmonizing traditional technology with revolutionary new ones.



Fig. 15. Overall Map of Expo Site and Nagakute Aichi Prefecture Pavilion exhibited Movable Monument (From the Expo 2005 Pamphlet of Aichi Prefecture in Japan)

For the Nagakute Aichi prefecture pavilion, the Expo organizers requested a design for a monument comprising a symbol tower to attract visitors to the pavilion. We proposed a movable monument whose shape could be changed variably and irregularly. A large movable monument using VGT was selected as a very unique and attractive monument.

A picture of the Expo site and the Nagakute Aichi Prefecture pavilion where the movable monument was set up is shown in Fig.15, and the movable monument is outlined in Table 1. The pavilion was in a picturesque position in the Japanese zone at the center of the Expo site. It faced a Japanese garden and the Kaede pond. It was located in front of the west gate and beside a global loop, making visitor access easy. The pavilion consisted of a festival plaza, a large-scale theater and a stage, a large area of the Cyube exchange pavilion, and an administration building. The exhibit contained the movable monument was built on the roof of the house. The entire exhibit was composed of movable towers and an annexed device of a Karakuri doll. Each exhibit was united by an internal control signal, and various performances by both the monument and the Karakuri doll were planned

Construction Location	Nagakute Aichi Prefecture pavilion in Expo 2005
Main Use	Movable Monument
Structure Classification	Steel structure containing adaptive Actuator
Base Condition	Combination through steel base on the roof top
Maximum Height	Ground Height :26. 6 m , Monument Height; 18.6m
Construction Period	From 2004. 11.1 to 2005 3.20
Operation Period	From 2005. 3.25 to 2005 9.25

Table 1. Outline of Movable Monument

#### 4.1.2 Design of movable monument

Fig.16 shows schematic pictures of the entire movable monument and its base structure. The whole was composed of three movable iron towers of the same specification, and were spaced at 120-degree intervals around the circumference. Each tower comprised four truss members combined by VGT at joints. Each frame comprised a solid truss structure. The outside of the frame was equipped with a hinge, the inside combined slide actuator, and the shape of towers was changed in proportion to actuator length. Moreover, head illumination was provided at the point of the monument, and a artistic lightning rod was set up. A Karakuri device covered with a large lantern case was constructed at the center of the monument. The towers were seated on a base plate and were combined with long steelpaling that penetrated through the inside of the administration building to an anchor.

#### 4.1.3 Structure design

In the movable structure's design, it was necessary to ensure adequate security. Then, the evaluation of the structure's design and its performance was acquired from the designated organizations. For design, the earthquake force for a projection on the rooftop and the wind loading based on the regional average wind velocity were used. A section shape was selected to ensure security and the specification of the VGT actuator was decided. Moreover, the control system for the movable mechanism, the safety mechanism, the management and the operation system were examined and approved.

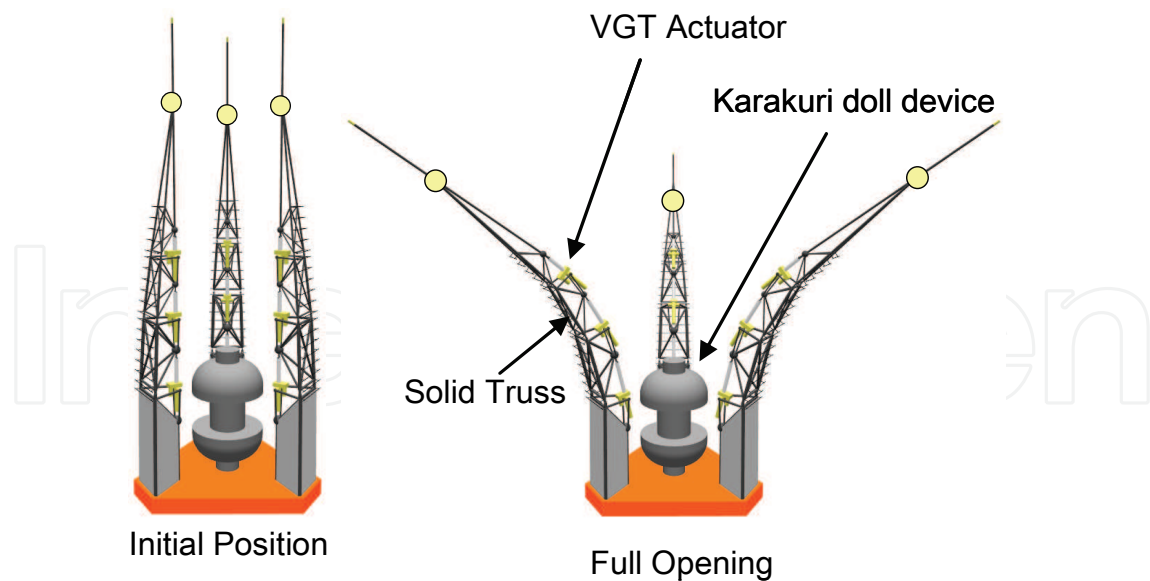

Fig. 16. Schematic Pictures of a Movable Monument and Base Structure

## 4.2 Composition of movable monument and control system

### 4.2.1 VGT actuator and monument structure

Fig.17 shows the arrangement of the VGT actuator and the movable range of the tower. Three different sized VGT actuators were set up in each tower and were controlled independently. There were two VGT mechanism arrangements: pier type and chord type. In this tower, the chord type arrangement was adopted because it had advantages of higher rigidity, higher accuracy and lower actuator load. The rotation angle of the VGT mechanism was from 2.5 degrees inside to 18 degrees outside. Thus, the total maximum rotation angle of a tower equipped with three VGT mechanisms was from 7.5 degrees inside to 54 degrees outside.

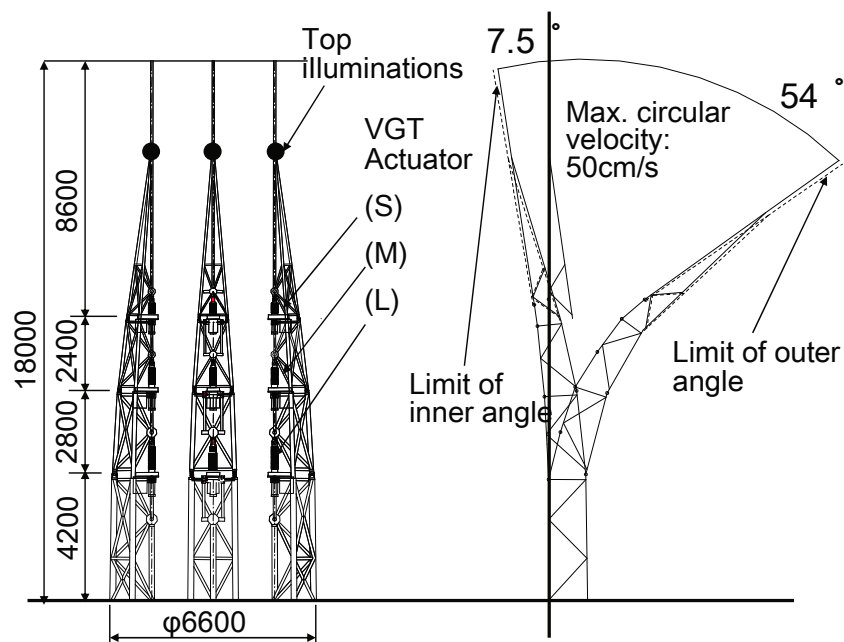

Fig. 17. Arrangement of VGT Actuator and the Movement Range of Tower

Fig.18 shows a picture of the inner structure of an extensible actuator used in a VGT Mechanism. The actuator was of the electronic type in which a screw rod was geared to a servomotor through a ball screw and a wheel gear. The top of the screw rod was linked with a truss node and the body of the actuator was carried by trunnion joints. The support bars on the node were moved in the outer stopper. Even if the screw rod broke, the tower's safety could be maintained by the support bars. In the servomotor, a magnetic brake and an encoder detect the rotating angle.

On the rod cover, both top and end limit sensors were installed. The motor was covered with waterproof covers. A cooling fan was maintained a suitable motor temperature. The electronic actuator had the advantage of high performance and energy conservation.

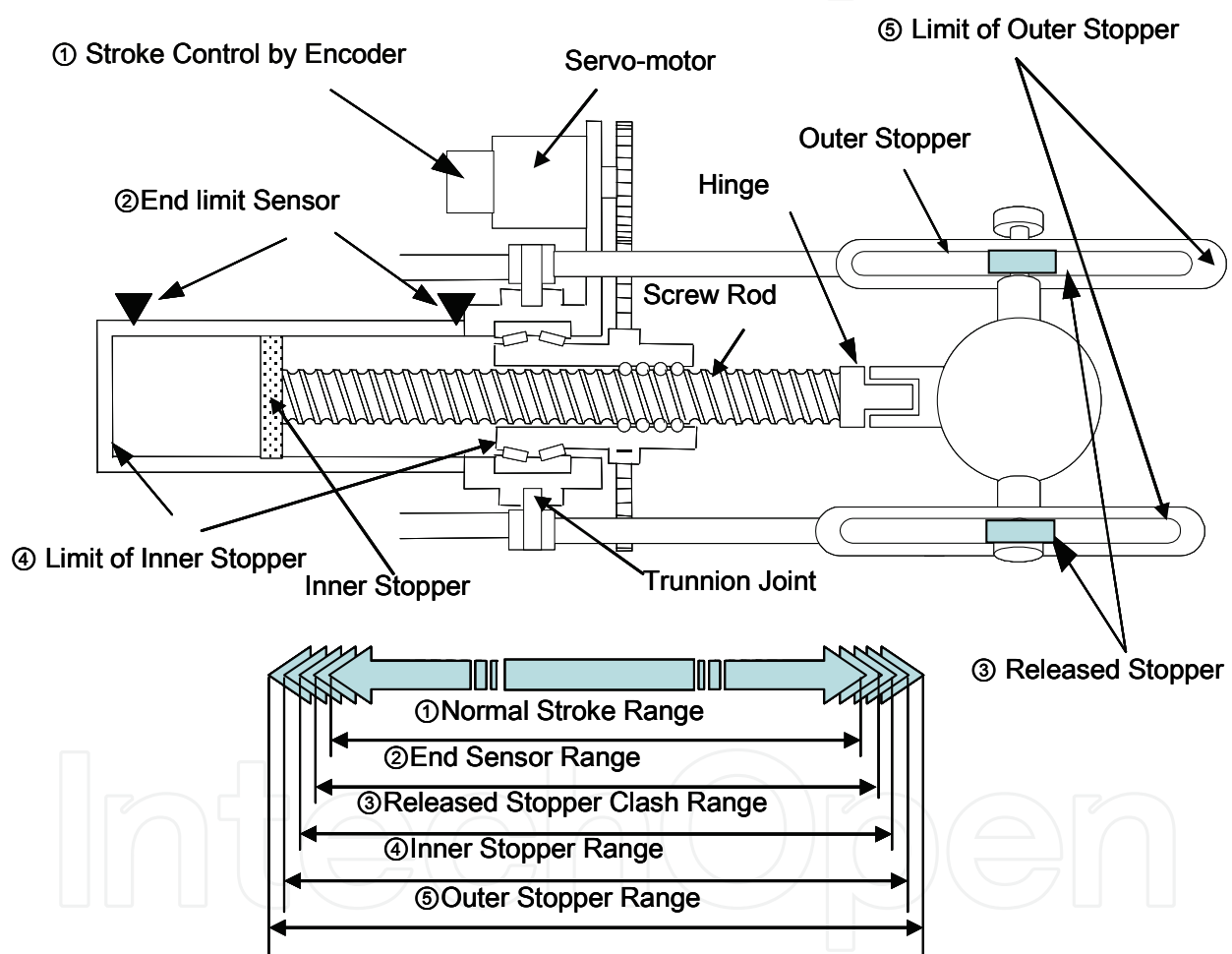

Fig. 18. Inner Structure of the Extensible Actuator of VGT and Safe Mechanisms

The relation between the load acting on the rod and the angle of each VGT mechanism are indicated in Fig.19 when the tower's movement analyzed by numerical simulation at the same angle. The load values were almost proportional to the angle, and the tension force range was wide and high. The rod's peak velocity was 20 mm/s, the tower tip rotation velocity became 500 mm/s or more when three VGT were operating at the same time. The tower movement could be expressed in an extremely dynamic and massive way in comparison with a conventional monument.

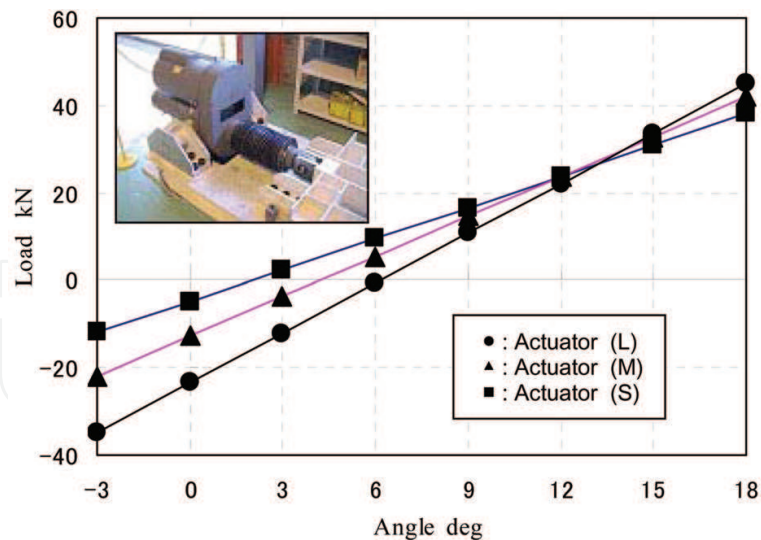

Fig. 19. Relation between Load Acting on Rod and Angle of each VGT Mechanism

#### 4.2.2 Safety mechanism and control system

The movable monument used at the Expo had to operate continuously, so a safe structure and control system had to be developed. The actuator rod stroke was detected by the servomotor encoder data and the actuator condition was continually monitored. Various accidents to the monuments were assumed, and the check points and safety mechanisms indicated were introduced. For an accident concerning rod stroke, a five-step safety mechanism was introduced.

Fig.20 shows a chart of the operation system and plural fail-safe system. Monument operation was automated, except the initial process, and the operator mainly observed the system's safety confirmation and maintenance control. The plural fail-safe system that maintained monument safety was developed to avoid accidents. Furthermore, an emergency device; an automatic stop and warning device for earthquakes, thunderstorms, strong winds and heavy rain; and a backup device for power failure were installed.

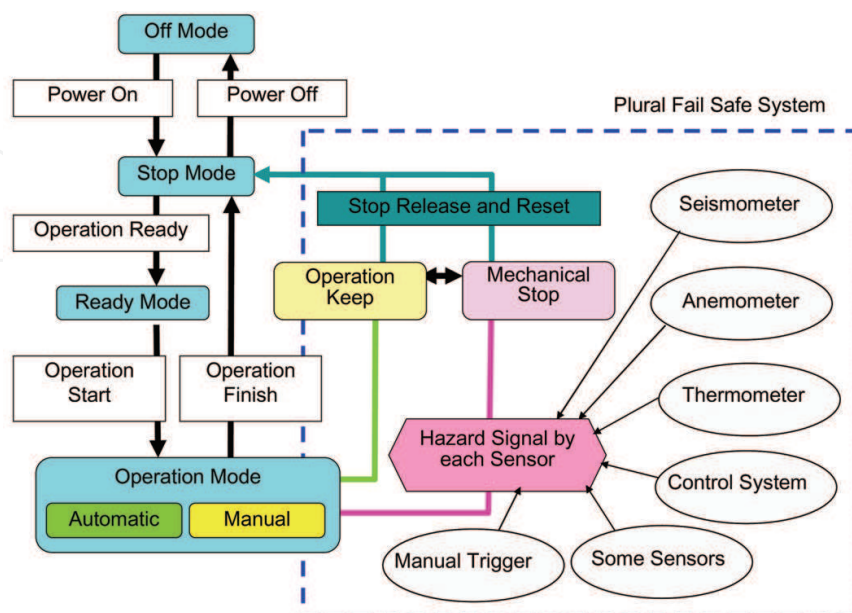

Fig. 20. Flowchart of Operation System and Monument Safety System



#### 4.3 Performance and operation conditions of movable monument

An overview of the movable monument at Expo is shown in Fig.21. This picture expresses the coordinated performance of the three towers of the monument when fully opened (Fig.21-(a)), and Karakuri doll dancing in the center (Fig.21-(b)). A lot of visitors gathered around the monument, and they enjoyed the performance of the two exhibitions. Further, the monument was illuminated at night and its fantastic movements could be observed in the dark (Fig.21-(c))



(a) Performance of the Three Towers of the Monument When Fully Opened



(b) Karakuri Doll Performance



(c)Lightening up the Monumnt

Fig. 21. Overview of the Movable Monument at EXPO

##### 4.3.1 Performance patterns and shape change

Fig.22 shows the monument's shape changes according to performance patterns. One loop of the total performance was composed of two patterns every 30 minutes, that is, only the monument was moved for the 25 minutes of the first part, and the Karakuri doll danced with the monument for the 5 minutes of the second part. This performance loop was continuously repeated

For the monument's performance, there were two program modes. In the normal mode, the velocity and the stopping time of the actuator rod were decided by measuring and indicated in Fig.22-(a). There was a little case in which the shape of three towers reappeared at the same time. In a special mode, the monument was moved at high speed to accompany analyzing the state of the natural data (wind velocity, temperature, time, day and so on). As a result, the entire monument was moved to produce very irregular shape changes, as a preinstall program. This mode, being outside the performance loop, started suddenly, so nobody was expecting it. By selecting such modes, it was possible to express very interesting movements and monument shapes that changed slowly but dynamically.

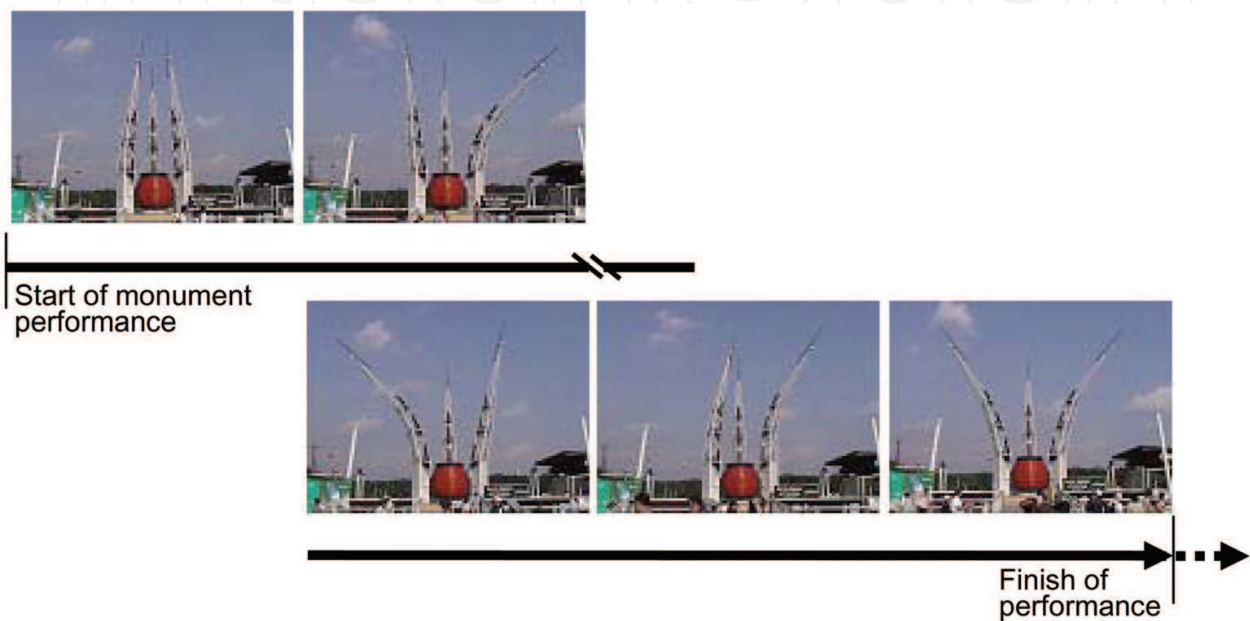

(a) Random Shape Performance of the Monument by Natural Data (25 min.)

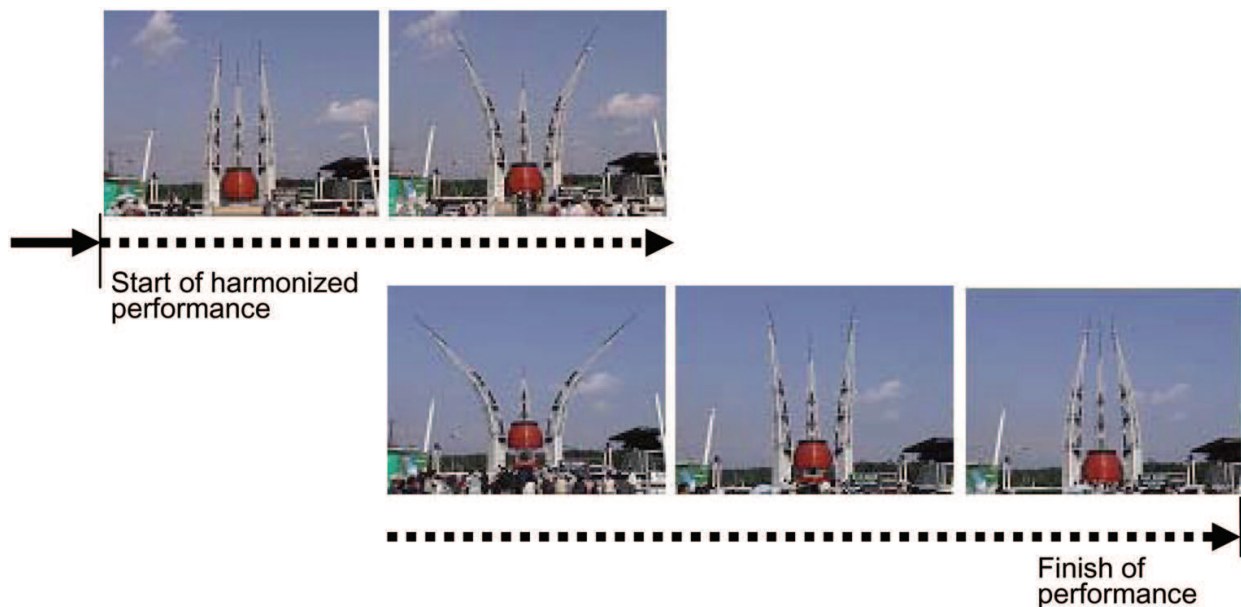

(b) Harmonized Performance of the Karakuri and the Monument (5 min.)

Fig. 22. Shape Changes of Monument According to Performance Patterns

On the other hand, in the coordinated performance with the Karakuri doll, the monument was opened and closed powerfully, synchronizing with the Karakuri doll's performance, as indicated in Fig.2-(b). In this case, the Karakuri doll performed a variable dance and somersaults with sound and illumination effect. A very traditional but innovative performance was thus created. In this performance, the Karakuri doll was the main player and the monument was a supporting player.

#### 4.3.2 Monument operation

During the Expo, the monument was operated continuously for about 13 hours a day. However, its operation was modified every day and at times when there were unexpected special events. Fig.23 shows the record of operation frequency each day and their accumulations. When the shape of the monument was changed to open and to close, the operation was counted as one.

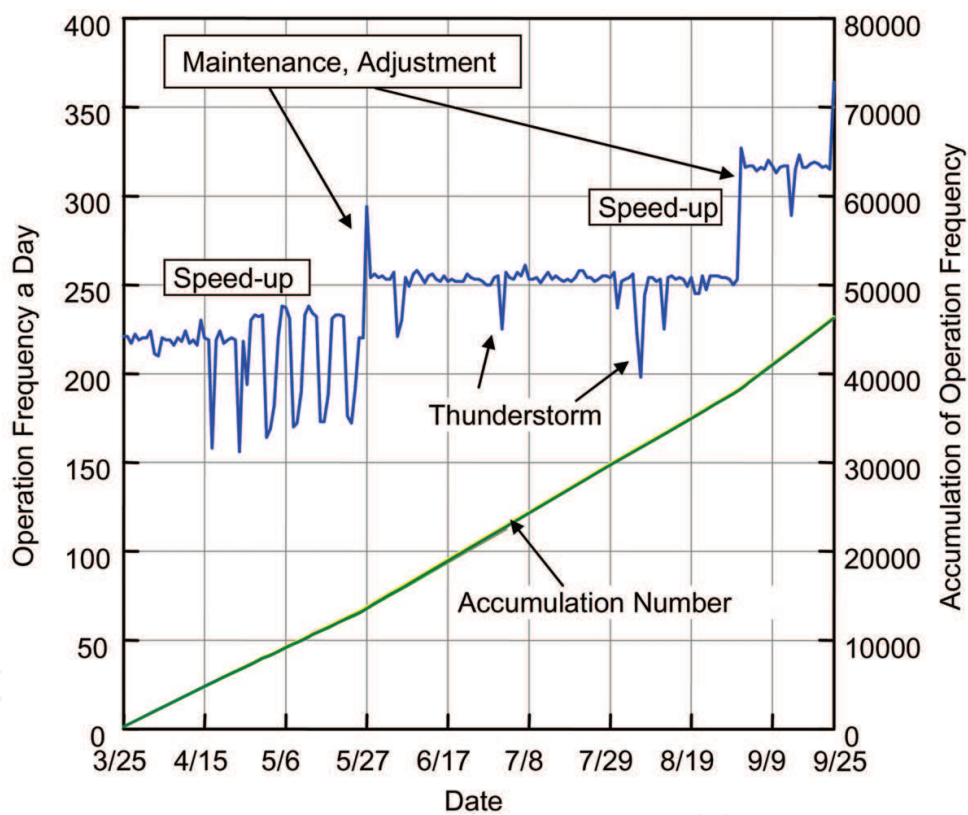

Fig. 23. Record of Monument's Operation Frequency during the Expo

At the beginning of the Expo, the average speed at which the monument moved was set at a low level, and the speed was changed depending on the day of the week. Two months after opening, the performance was switched to a random mode program. The operation frequency was observed to be almost constant. During the last month, the average speed approached the maximum level corresponding to the upsurge in attendance at the Expo site. During the Expo, the monument was operated continuously for 185 days, except during

maintenance or thunderstorms, and there were neither breakdowns nor accidents. By the end of the Expo, there had been 50,000 operations, thus confirming that the monument was operated within the range of the initial plan.

After the Expo ended, the monument and other devices were temporarily removed from the site. In response to demands for its reconstruction, it was reconstructed in the field of the company that manufactured the VGT actuator, and is now open to the public as a memorial tower to the Expo. It may continue operating forever.

## 5. Conclusion

As for one movable mechanism that enables to make a future adaptive structure, we focused the VGT, and examined the development of element technologies and its applicability to moveable structures. VGT was equipped with flexible and intelligent functions, and various shapes could be created freely by contriving its arrangement and control. The structure was considered to have a very wide application to construction structure. This paper has proposed an example of an adaptive structure applying the VGT. The efficiency and the characteristics of the VGT could be grasped under the several conditions by a scale model of a Flowering Dome and a movable monument exhibited in EXPO. Application of the movable monument was the first big project since the VGT technology had been developed in the construction field. In the development of the monument, we considered quality and security of construction. As a result, safe and excellent continuous performance was achieved, and the monument received high praise from promoters and many visitors. The VGT was shown to be a very useful technology for such movable structures whose shape can be changed variably. In the future, with progressing and spreading of VGT technology, we will propose various applications.

Finally, the author thanks all who supported the development and application of the VGT structure and a movable monument at Expo 2005.

## 6. References

- Ishii, K. (1995). Moving Architectures. *Journal of Architecture and Building Science*, Vol. 110, No. 3, pp. 3-44
- Natori, M.C., & Miura, K. (1994). Development of truss concept in Space Technology. *International Symposium on Membrane Structure and Space Frame*, pp. 45-56
- Kurita, K., Inoue, F., Natori, M. C. et al (2001). Development of Adaptive Roof Structure by Variable Geometry Truss. *Proceeding of 18th International Symposium on Automation and Robotics in Construction*, pp.63-68, Sep. 2001, Krakow, Poland
- Inoue, F., Kurita, K. et al. (2003). Application of Adaptive Structure And Control by Variable Geometry Truss. *Proceeding of The CIB 2003 International Conference on Smart and Sustainable Built Environment*, pp.59, Nov. 2003, Brisbane, Australia
- Inoue, F., Kurita, K. et al (2006). Development of Adaptive Structure by Variable Geometry Truss. *Proceeding of 23th International Symposium on Automation and Robotics in Construction*, pp.704-709, Oct. 2006, Tokyo, Japan

Inoue, F. (2007). A Study of Movable Arch Structure and its External Panel Mechanism by Variable Geometry Truss. *International Conference of Shell and Spatial Structures*, pp.704-709, Dec. 2007, Venice Italy

IntechOpen

IntechOpen



## **Robotics and Automation in Construction**

Edited by Carlos Balaguer and Mohamed Abderrahim

ISBN 978-953-7619-13-8

Hard cover, 404 pages

**Publisher** InTech

**Published online** 01, October, 2008

**Published in print edition** October, 2008

This book addresses several issues related to the introduction of automaton and robotics in the construction industry in a collection of 23 chapters. The chapters are grouped in 3 main sections according to the theme or the type of technology they treat. Section I is dedicated to describe and analyse the main research challenges of Robotics and Automation in Construction (RAC). The second section consists of 12 chapters and is dedicated to the technologies and new developments employed to automate processes in the construction industry. Among these we have examples of ICT technologies used for purposes such as construction visualisation systems, added value management systems, construction materials and elements tracking using multiple IDs devices. This section also deals with Sensorial Systems and software used in the construction to improve the performances of machines such as cranes, and in improving Human-Machine Interfaces (MMI). Authors adopted Mixed and Augmented Reality in the MMI to ease the construction operations. Section III is dedicated to describe case studies of RAC and comprises 8 chapters. Among the eight chapters the section presents a robotic excavator and a semi-automated façade cleaning system. The section also presents work dedicated to enhancing the force of the workers in construction through the use of Robotic-powered exoskeletons and body joint-adapted assistive units, which allow the handling of greater loads.

### **How to reference**

In order to correctly reference this scholarly work, feel free to copy and paste the following:

Fumihiko Inoue (2008). Development of Adaptive Construction Structure by Variable Geometry Truss, Robotics and Automation in Construction, Carlos Balaguer and Mohamed Abderrahim (Ed.), ISBN: 978-953-7619-13-8, InTech, Available from:

[http://www.intechopen.com/books/robotics\\_and\\_automation\\_in\\_construction/development\\_of\\_adaptive\\_construction\\_structure\\_by\\_variable\\_geometry\\_truss](http://www.intechopen.com/books/robotics_and_automation_in_construction/development_of_adaptive_construction_structure_by_variable_geometry_truss)

**INTECH**  
open science | open minds

### **InTech Europe**

University Campus STeP Ri  
Slavka Krautzeka 83/A  
51000 Rijeka, Croatia  
Phone: +385 (51) 770 447  
Fax: +385 (51) 686 166

### **InTech China**

Unit 405, Office Block, Hotel Equatorial Shanghai  
No.65, Yan An Road (West), Shanghai, 200040, China  
中国上海市延安西路65号上海国际贵都大饭店办公楼405单元  
Phone: +86-21-62489820  
Fax: +86-21-62489821

[www.intechopen.com](http://www.intechopen.com)

IntechOpen

IntechOpen

© 2008 The Author(s). Licensee IntechOpen. This chapter is distributed under the terms of the [Creative Commons Attribution-NonCommercial-ShareAlike-3.0 License](https://creativecommons.org/licenses/by-nc-sa/3.0/), which permits use, distribution and reproduction for non-commercial purposes, provided the original is properly cited and derivative works building on this content are distributed under the same license.

IntechOpen

IntechOpen