

We are IntechOpen, the world's leading publisher of Open Access books Built by scientists, for scientists

4,800

Open access books available

122,000

International authors and editors

135M

Downloads

Our authors are among the

154

Countries delivered to

TOP 1%

most cited scientists

12.2%

Contributors from top 500 universities



WEB OF SCIENCE™

Selection of our books indexed in the Book Citation Index
in Web of Science™ Core Collection (BKCI)

Interested in publishing with us?
Contact book.department@intechopen.com

Numbers displayed above are based on latest data collected.

For more information visit www.intechopen.com



Upper-Limb Robotic Rehabilitation Exoskeleton: Tremor Suppression

J.L. Pons, E. Rocon, A.F. Ruiz, J.C. Moreno
*Bioengineering Group, Instituto de Automática Industrial - CSIC
 Spain*

1. Introduction

The interest of the scientific community in medical Robotics and rehabilitation Robotics is growing every year. Rehabilitation Robotics aims to apply robotic technology (sensors, actuators, control) to the rehabilitation and assistance of disabled people. Only some years ago developers were able to implement viable robotic systems to assist a person with a functional limitation. Thus, devices have been developed to assist mobility and the motor functions of the arms and legs, among others.

Tremor is a movement disorder that has a great impact on the quality of life of people who suffer it, mainly to do specific tasks (Rocon et al., 2004). It can affect the head, face, jaw, voice or the upper and lower extremities. In particular, tremor that affects the upper limbs is of major interest, since it can be very disabling to lead an independent life. It is a symptom associated with some abnormal neurological condition or cerebral lesions and degenerative diseases, including Parkinson's disease, essential tremor, orthostatic tremor, cerebellar diseases, ethylic intoxication, among others.

As well as medication, rehabilitation programmes and surgical interventions, the application of biomechanical loading on tremor movement has been shown to be a technique that is able to suppress the effects of tremor on the human body (Rocon et al., 2004). Starting from this principle, the development of upper-limb non-invasive ambulatory robotic exoskeletons is presented as a promising solution for patients who cannot benefit from the use of medication to suppress the tremor. An orthosis is defined as a medical device applied externally to a limb of the human body to establish some kind of functional compensation. In this area robotic exoskeletons have emerged, in the form of orthoses, to provide motor assistance and functional compensation to disabled people.

An exoskeleton is an external structural mechanism whose joints match those of the human body. It adapts to a person so that physical contact between the operator and the exoskeleton enables a direct transfer of mechanical power and information signals. Similarly, it must provide an effective interface between the mechanical structure and the upper limb, bearing in mind the characteristics of the soft tissue of the muscular system, (Ruiz, 2005). Thus, one of the most important specific aspects of rehabilitation robotics is the intrinsic interaction between the human being and the robot. This interaction has two key points: 1) a cognitive interaction with which the human being is able to control the robot while the robot transmits feedback to the human being, 2) a biomechanical

Source: Rehabilitation Robotics, Book edited by Sashi S Kommu,
 ISBN 978-3-902613-04-2, pp.648, August 2007, Itech Education and Publishing, Vienna, Austria

interaction related to the application of controlled forces between the human being and robot.

In the event of reducing tremor, the orthosis must be able to apply viscous or inertial loads and opposing forces to the arm tremor movement, in some joints of the upper limb. As a portable device, exoskeletons must exhibit a number of aesthetic, cosmetic, and functional characteristics (Rocon et al., 2005a). The aesthetic and cosmetic characteristics are directly related to the size, weight and appearance of the robotic device. The functionality of the device is more related to matching the torque, speed and bandwidth required for the system and its robustness during the operation.

In the framework of the DRIFTS project the WOTAS (Wearable Orthosis for Tremor Assessment and Suppression) device was developed, which is a robotic exoskeleton that can apply dynamic internal forces, i.e., without any external reference, on the upper limb and it will be the platform used to evaluate control strategies for tremor suppression by applying biomechanical loads (Manto et al., 2003). In this chapter we will describe the general concept of WOTAS in detail, highlight its special characteristics and the design and selection of system components. Two new control strategies will also be described for tremor suppression. Finally, the results obtained in the exoskeleton clinical trials will be presented.

2. WOTAS

The aim of the WOTAS exoskeleton is to provide a platform to evaluate control strategies for cancelling the tremor with robotic exoskeletons. Furthermore, it constitutes an evaluation and diagnosis tool for patients suffering tremors under the effects of tremor suppression strategies or in non-intervention conditions.

2.1 Mechanical design

The intrinsically dynamic characteristics of tremor mean that the conventional orthotic systems on sale do not suppress tremor because, in these instances, the orthoses tend to lose alignment with the body instead of suppressing the tremor. This loss in alignment can be explained by the fact that when the orthosis tries to apply forces on the arm, the fixation supports tend to rotate over its axis (Rocon et al., 2005a). Accordingly, in the framework of the DRIFTS project the development of a robotic system with specific characteristics for the application of dynamic forces on the arm was posed. The fixation of the orthosis on the upper limb is fundamental because it enables forces to be applied and distributed along the different body limbs involved. Moreover, for the dynamic elements to develop their action, it is necessary to have a base, or rigid structure (the orthosis), which acts as a point for applying those external forces that cause the dynamic effect.

The WOTAS platform was designed for the elbow and wrist joints, so that different control strategies on the flexo-extension movements of the elbow and the wrist and the pronation-supination of the forearm can be applied, (Rocon et al., 2005a). Therefore, the exoskeleton must be adjustable or adaptable to align its joints with the revolute centres of the elbow and wrist joints.

The mechanical design of the joints related to the WOTAS elbow and wrist flexo-extensions are similar to the orthotic solutions found on the market and are based on the biomechanical behaviour of these joints. The elbow joint, like that of the knee, is probably

the joint in the human body which is more like the revolute joint (Kapandji, 1983). This joint has a variable rotation centre but it can be modelled via a simple rotation joint with a fixed rotation centre. The rotation axis of the elbow joint is located on the line between the two epicondyles. The wrist is a highly complex joint because it consists of a very large number of bones. Therefore, the flexion-extension movement of the wrist does not possess a specific rotation axis. However, the same as for the elbow joint, the flexo-extension movement of the wrist can be considered a pure rotational movement with its rotation axis aligned with the capital and lunar bones of the carpus for the modelling (Rocon et al., 2005a). The design of the system for controlling the pronation-supination movement of the forearm is more complicated. The pronation-supination movement of the forearm is a rotational movement of the forearm on its longitudinal axis which engages two joints that are mechanically connected: the upper radioulnar joint (which belongs to the elbow) and the lower radioulnar joint (which belongs to the wrist) (Kapandji, 1983). The WOTAS platform controls the pronation-supination movement with the rotation control of a bar parallel to the forearm. This bar is fixed very close to the olecranon. Thus the bar is fixed to the ulnar position at elbow level. The distal fixation of the bar is done on the radius head.

From the torque estimates and efforts that the exoskeleton structure must support (Rocon et al., 2005b), duralumin was selected as the material to construct the exoskeleton structure. This material was selected in order to build a lightweight structure with sufficient rigidity to support the efforts.

2.2 Application of forces on the arm

To determine the points of the upper limb where the dynamic forces would be applied, i.e., the points where the arm supports would be placed between the actuators and the arm, a number of biomechanical and physiological considerations of the upper limb have to be observed, such as (Rocon et al., 2005a): 1) the forces on the arm tissues must stay in acceptable limits 2) the arm restrictions in order to preserve normal activity, i.e., like applying compensatory forces on the arm without affecting the natural movement patterns of the upper arm, particularly for the elbow and wrist 3) the interaction of the robotic device with the arm, i.e., where the forces will be applied on the upper limb and how the load will be transmitted to the person for optimum comfort.

To respond to these issues a biomechanical study was done of the upper limb. The aim of this study was to determine the limits of comfort regarding pressure, so that there is an upper limit to the total force that can be applied safely to the upper limb, (Markensco & Yannas, 1979). This study analysed two key aspects: the person's perception of the pressure and the maximum pressure tolerance thresholds (Rocon et al., 2005a). The first aspect is important to select the appropriate strategy to apply to the load on the body.

For the development of the mechanical structure, different types of materials for the securing or support elements between the orthotic device and the arm were considered. The mechanical conditions of these elements is critical because they must ergonomically couple the upper limb, and also the rigidity of the material must be greater than the rigidity of the underlying tissues. To securely fix the structure it was decided to use supports made from thermoplastic. With this type of material, supports are obtained that adapt to the morphology of each user's arm, Figure 1. Each support has at least three contact points per segment and thus misalignments are avoided between the orthosis and limb (Rocon et al., 2006).



Fig. 1. Illustration of the WOTAS supports on a patient's arm. The supports are manufactured in thermoplastic to best adapt to the morphology of each user's arm.

2.3 Measurement systems

The device is also an evaluation and diagnosis tool for patients who suffer tremors, so it is equipped with kinematic sensors (angular position, speed and acceleration) and kinetics (interaction forces between the orthosis and upper limb). The analysis developed for the selection of sensors and actuators among the several candidate technologies is based on the Dominic method (Rocon et al., 2005a).

2.3.1 Kinematic measurement

Gyroscopes were selected as the technology for the kinematic measurement of the tremor (Rocon et al., 2005a). The main advantages of gyroscopes are that they measure rotational movements (human movements are rotational around the joints), they are not affected by gravity, frequency and amplitude information is precise in a long frequency range, up to DC (zero frequency), the angular position is obtained with an integration, the angular acceleration is obtained with a derivation, they have a high signal/noise relation and do not affect the natural movement of the limb.

An analysis was done of the gyroscopes available commercially and it was decided to use the gyroscope manufactured by Murata GYROSTAR ENC-03J. These gyroscopes are used for stabilising video camera images, so they are expected to be a good alternative for measuring tremor speed. An electronic device was also developed to process the gyroscope signal before it was integrated into the WOTAS system. The basic circuit consists of a bandpass filter with a short frequency between 0.3 Hz and 25 Hz. This is the range of frequencies where nearly all the tremor energy is concentrated, (Rocon et al., 2004).

2.3.2 Kinetic measurement

We selected the strain gauges as the sensor for extracting the kinetic characteristics from the tremor movement. The gauges are responsible for measuring the torque applied by the motors on the WOTAS structure, therefore, they are mounted on the structure so that they only measure the force perpendicular to the motor axis, thus their measurement is not affected by forces caused in undesired directions.

The strain gauges are connected to a Wheatstone Bridge circuit in a combination of four active gauges (full bridge). When a strain is applied to the gauges, there is a change in value of their resistances resulting in an unbalance of the Wheatstone Bridge. This produces an output signal related to the strain value.

2.4 Actuation system

When designing any orthoprosthetic device that works parallel to the human body to suppress the tremor it is of paramount importance to specify the actuators. Vital information for the selection of an actuation technology is the torque and the power required by the application. To obtain these values a study was done with several patients, (Rocon et al., 2005b). Bearing in mind the application requirements, a number of actuators were selected as possible candidate technologies to suppress the tremor, (Rocon et al., 2006). As in the case of the sensors, the Dominic method was used to select the technology to suppress the tremor. From the actuators studied, we selected some for subsequent analysis: Electroactive Polymers (EAPs), Electro- and magneto-rheological fluids (ERF-MRF), DC motors, Shape memory actuators (SMAs), pneumatic muscles and ultrasonic motors. The results of the evaluation process determined that ultrasonic and DC motors are the best solutions for activating the exoskeleton.

A number of experiments were done to evaluate the performance of the ultrasonic motors. The conclusion of our assessment process of the ultrasonic motors is that, although they offer a number of advantages for the rehabilitation robotic field like, for example, their reduced size and silent operation, they are not the right actuators for the exoskeleton proposed in this work due to their poor response to low speeds, which means that they cannot be applied to track slow movements like human movements, (Rocon et al., 2006).

Owing to the problems encountered with ultrasonic motors, a new WOTAS device was implemented using continuous current motors as an actuation element. Continuous current motors are one of the most well-known actuation technologies. We selected the Maxon Motor EC 45 Flat continuous current, which is a very light, small DC motor without brushes that adapts to orthotic applications. In order to match the speed and torque of the DC motor to the application requirements, a gearbox was necessary for the system. This was done via a harmonic drive. In particular, the drive selected for our application was the HDF-014-100-2A. The actuator system configured in this way can apply a maximum torque of 8 N.m. However, the maximum torque was limited electronically to 3 N.m to guarantee user safety. Figure 2 presents the WOTAS version developed from DC motors as actuator elements and coupled to the gearbox (harmonic drive). Similarly all the sensor elements are observed on the mechanical structure and the fixation of the orthosis to the patient's arm. The total weight of the system developed is approximately 850 g, (Rocon et al., 2006).

2.5 Control architecture

The WOTAS control architecture basically consists of 3 components: 1) the orthosis, with its structure, sensors and actuators 2) a control unit, responsible for executing the algorithms in real time to suppress the tremor and the acquisition card for the interface between the sensors, actuators and the controller 3) a remote computer, which in our case executes an application developed to do the interface between all the system and the doctor who is using it.

The WOTAS device operates in three different modes:

1. **Monitoring.** In this operation mode, WOTAS behaves like a system to measure and characterise the tremor qualitatively and quantitatively. Thus it offers no opposition to the patient's voluntary or tremor movement.
2. **Passive intervention.** In this mode, WOTAS behaves like a device that can mechanically damp the tremor movements, simulating the application of viscosity or inertia on the upper limb to dissipate vibrations caused by the tremor and improve the user's voluntary movement.

3. **Active intervention.** In this mode, WOTAS suppresses the tremor dynamically, and estimates the voluntary and tremor movement signals in real time and generates actuation signals proportional to tremor intensity.

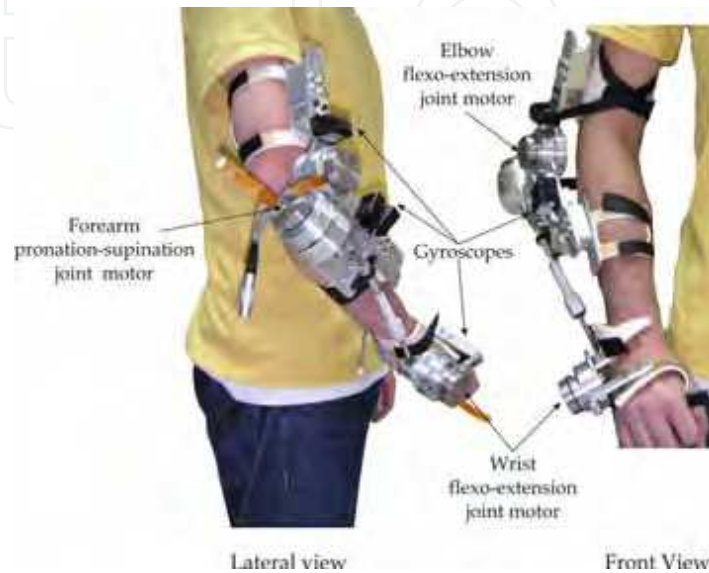

Fig. 2. Final version of WOTAS for the control of three human upper-limb movements: flexion-extension of the elbow, flexion-extension of the wrist and pronation-supination of the forearm.

2.5.1 Computer application

A computer tool was developed to manage the system. The application is installed in an external computer and provides communication with the device, data storage, signal acquisition, information analysis and display, and report generation. As a basic aspect, it evaluates the control algorithms developed in Matlab for tremor suppression to control their execution, monitor algorithm variables and adjust or tune algorithm parameters in real time. Moreover, it implements the specified measurement protocol and the clinical trials defined, and displays quantitative information of the functionality of the algorithms evaluated.

3. Control strategies

The application of biomechanical loading to reduce tremor can be done using portable devices (robotic exoskeletons) and fixed devices (devices mounted on platforms, for example, wheelchairs), (Rocon et al., 2004). The first approach is characterised by applying internal forces on specific joints of the human body, whereas the second is based on applying external forces globally to reduce tremor.

This control strategy can be implemented actively and passively. The passive concept uses a mechanical damper, (Kotovsky and Rosen, 1998), which generates a dissipation force on tremor movement. It is based on increasing the damping of the biomechanical oscillation system where the tremor is generated.

In active systems, (Rosen et al., 1995), actuators generate a movement of equal amplitude but in counter-phase from the estimate in real time of the tremor component of the

movement. Thus the system actively cancels and effectively subtracts the tremor from the total movement done by the exoskeleton user. Unlike in the passive approach, where tremor movement energy is dissipated, in active systems, energy is transferred (in counter-phase to tremor movement) to the systems.

After an exhaustive bibliographical review on tremor characteristics and control strategies for the application of forces on the human body, two control strategies were defined to suppress tremor using biomechanical loads, (Rocon et al., 2005a):

1. *Tremor reduction via impedance control.* A strategy is defined to control the impedance of the exoskeleton-upper-limb set. In this instance, the rigidity, damping and inertia parameters of the upper limb are modified to study the effects on tremor in this limb's joints.
2. *Implementation of a notch filter focusing on the frequency of tremor movement.* The use of noise reduction techniques is posed to suppress the pathological tremor actively.

3.1 Tremor reduction via impedance control

The impedance of a system is defined as the relation between the reaction force of the system to the external movement imposed on it and the movement, (Hogan, 1985). Generally, impedance involves three components: rigidity, damping and inertia. In the literature there is evidence that variation in the three components modifies the biomechanical characteristics of the tremor in the upper limb, (Adelstein, 1981).

In this work approach, the musculo-skeletal system (each joint of the upper limb that contributes to the tremor) is modelled as a second-order biomechanical system, (Adelstein, 1981). It is known that the frequency response of a second-order system presents the behaviour of a low-pass filter. The cut-off frequency of this filter is directly related to the biomechanical parameters of the second-order system. The approach proposed consists of selecting the right inertia and damping parameters, so that the cut-off frequency, f_c , of the musculo-skeleton system is immediately above the maximum frequency of voluntary movement, cancelling the tremor component of overall movement.

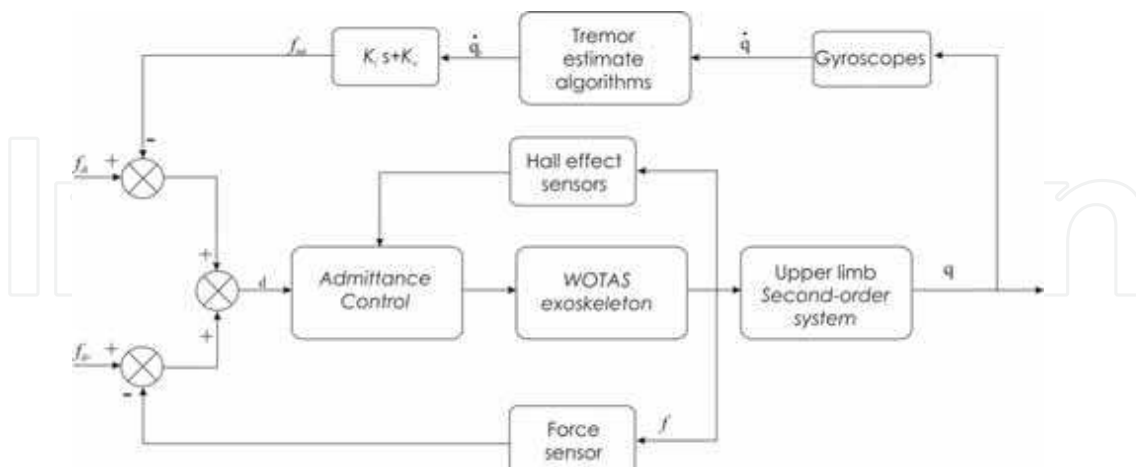

Fig. 3. Control strategy for modifying upper-limb impedance implemented in each joint of the WOTAS exoskeleton.

The control algorithm illustrated in Figure 3 is the one proposed for modifying the biomechanical parameters of the upper limb. As can be observed in the Figure, the force control applied by the exoskeleton on the arm is implemented using external control force loops around an internal speed loop. For each joint, a specific motor controller used in WOTAS undertakes a motor speed internal control loop. Around this internal loop, two external loops are closed: one for feedback and interaction force control between the exoskeleton and the limb (lower loop); the other loop applies forces to alter the biomechanical forces of the upper limb to suppress the tremor (upper loop). The force value, τ_d , which is introduced in the internal force loop is calculated via the sum of actions of the two external loops:

$$\tau_d = f_{dt} - f_{mt} + f_{dv} - \tau = f_{dt} - k_i q_t - k_v \dot{q}_t + f_{dv} - \tau \quad (1.1)$$

The upper part of the control loop proposed is the one responsible for modifying the apparent upper limb impedance. The feedback coefficients K_i and K_v define the apparent inertia and damping characteristics of each upper limb joint. The force (f_{mt}) applied on the arm is calculated from the coefficients and the filtered information of the movement of each upper limb joint (so that only the tremor information is re-fed). This force tends to disappear as the tremor is suppressed. Thus, the difference between the calculated force, f_{mt} , and the desired force, f_{dt} , will tend to zero because in our application, the value of f_{dt} was selected as zero.

The lower part of the control loop proposed is responsible for minimising the effects of the exoskeleton on voluntary movements. In this loop, the force sensors measure the interaction between the exoskeleton and the upper limb (τ). In ideal conditions, a patient who does not present tremors must not feel any resistance to the natural movement of his/her arm from the exoskeleton. As a result, the added impedance is adjusted by the lower loop to zero. Accordingly, the sign that defines the force, f_{dv} , applied on the voluntary movement of the user, is adjusted to zero

The control strategy proposed has an adaptive behaviour so that constantly (in real time) it updates the tremor amplitude estimate. Thus the system can respond to the changes produced by the control strategy on the tremor, (Rocon et al., 2003). Moreover, the control strategy proposed is based on an articular control approach because it is simpler and also makes it possible to implement individual control loops in each joint with a high dynamic range, (Tsagarakis & Caldwell, 2003). Furthermore, the fact that each exoskeleton joint tries to suppress the tremor generated in its corresponding anatomical joint is interesting because it guarantees reducing the tremor in each joint. Thus the problem of coupling the tremor between the upper-limb joints is successfully tackled, (Rocon et al., 2005a).

In studies done by the authors, the behaviour and contribution of each joint in the upper-limb tremor were evaluated, (Rocon et al., 2003). This work has shown that in most patients the tremor movement "displaces" along the kinematic chain of the arm when its effects are reduced (by applying biomechanical loads) on one of the arm joints. However, the study of tremor behaviour when its effects are cancelled in different joints of the arm has still not been properly studied, (Rocon et al., 2004). Thus the factors that affect the functioning and stability of the force controller vary more from joint to joint than from Cartesian direction to Cartesian direction. This aspect led to devising active and independent control strategies in each joint. Accordingly, if the cancellation of the tremor in one of the joints increases the tremor in the other joint, the algorithm responsible for controlling the adjacent joint will identify the increased tremor and try to reduce the tremor generated by coupling the upper-limb joints. The aim is thus that the active behaviour of tremor reduction in each joint reaches equilibrium, thereby decreasing the coupling effects of the upper-limb joints.

3.2 Exploitation of the repetitive characteristics of tremor movement

Tremor is usually described in the bibliography as a rhythmic and involuntary contraction characterised by oscillations at a central frequency, (Rocon et al., 2004). Tremor frequency varies according to patient pathology. For patients with essential tremor the frequency range is between 5 and 8 Hz, while for rest tremor the frequency is usually low, between 3 and 6 Hz.

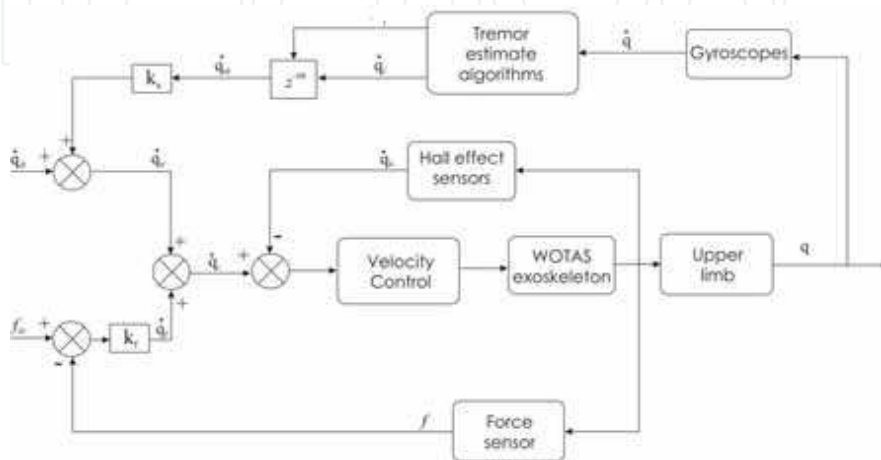

Fig. 4. Repetitive control strategy of speed implemented in the exoskeleton.

Moreover, the frequency varies among patients with a definite pathology, but it tends to be stable in the same patient. This characteristic is explored in this work by implementing a control strategy based on repetitive control (RC), (Inoue, 1998). To implement the active controller from the repetitive control to suppress the tremor, an articular control approach was used, i.e., each joint was controlled independently to minimise tremor-coupling problems in the different upper-limb joints. The control strategy designed and proposed for active control of the pathological tremor is illustrated in Figure 4. In the control strategy proposed the speed of each human upper-limb joint is controlled. The consign speed, q_c which is introduced in the speed control loop is calculated using the following control law:

$$\dot{q}_c = \dot{q}_f + \dot{q}_{tr} = k_f(f_{dv} - f) + (\dot{q}_{dt} + z^{-M_k} \cdot \dot{q}_t) \quad (1.2)$$

As in the passive approach, this strategy also consists of two loops. The upper loop is responsible for the action actively suppressing the tremor, while the lower loop is responsible for reducing the effects of biomechanical loading on natural movement. In the upper loop an estimate is done of the speed of tremor movement, q_t . The amplitude of the speed of tremor movement suffers a time lag of M seconds. The value of this time lag is defined by the frequency of tremor movement, ω_t . Thus, the amplitude of tremor movement, added to a speed consign, q_{dt} , is re-fed to the internal speed controller of the WOTAS exoskeleton. Thus, the WOTAS actuators will describe a speed profile with equal amplitude but in counter-phase to tremor movement, actively cancelling and effectively subtracting the tremor from the user's total movement. Accordingly, in our system the speed consign, q_{dt} , is adjusted to zero. The value of the constant, k_a , defines the amplitude of the movement that will be re-fed to the speed controller.

The lower loop is in charge of reducing the application of loads on voluntary movement. Accordingly, an admittance control is implemented, i.e., the sensors measure the force of

interaction between the exoskeleton and the upper limb, f , which multiplied by the force control loop gain, k_f , defines the speed consign, q_f , which is re-fed to the WOTAS motor internal speed controller. As already mentioned, in ideal conditions, a patient who does not present tremors must not feel any resistance to the natural movement of his/her arm from the robotic device. Accordingly, as in the passive control case proposed above, the consign defining the force applied on the user's voluntary movement, f_{do} , is adjusted to zero.

As explained in the preceding paragraph, unlike the passive approach, in which tremor movement energy is dissipated, in the active approach energy is transferred (in counter-phase to tremor movement) to the system. The active tremor suppression approach had never been implemented in any system for suppressing tremor. The system proposed is innovative and the evaluation of its effectiveness on suppressing pathological tremor and the effect on users will be presented in the next section of this chapter.

3.3 Tremor estimate

The two control strategies presented in the previous sections require identifying and tracking voluntary movement and tremor movement in real time. The major challenge of this type of treatment, irrespective of the approach used, is the distinction between what is tremor movement and what is voluntary movement before the control strategy applies any type of biomechanical loading on the arm. This process requires estimating both movements in real time.

In the literature, the algorithm most used for estimating tremor movement is the Weighted-frequency Fourier linear combiner (WFLC) developed by Riviere, (Riviere & Thakor, 1998), in his doctoral thesis for filtering the tremor signal caused by physiological tremor in the context of microsurgery. This algorithm models tremor movement as a sinusoidal movement. Its recurrent implementation updates the model parameters at each iteration, which transforms it into a simple algorithm, easy to implement and with low computational cost. These characteristics are very interesting for our application and we have therefore adopted it as our first alternative. The WFLC can be described by equation 1.3, where $w_k = [w_{1k} \dots w_{2Mk}]^T$ is the adaptive vector of the Fourier coefficients, s_k is the input signal, M is the number of harmonics of the model signal, μ is an adjustment parameter of the coefficients to be estimated.

$$\varepsilon_k = s_k - \sum_{r=1}^M [w_{rk} \sin(r\omega_0 k) + w_{r+Mk} \cos(r\omega_0 k)] \quad (1.3)$$

In its recurrent implementation, the WFLC is capable of estimating the amplitude and frequency of the tremor in real time, (Riviere & Thakor, 1998).

$$w_{0k+1} = w_{0k} + 2\mu_0 \varepsilon_k \sum_{r=1}^M r (w_{rk} x_{M+r k} - w_{M+r k} x_{rk}) \quad (1.4)$$

Where

$$x_{rk} = \begin{cases} \sin\left(r \sum_{t=1}^k w_{0t}\right), & 1 \leq r \leq M \\ \cos\left((r - M) \sum_{t=1}^k w_{0t}\right), & M + 1 \leq r \leq 2M \end{cases} \quad (1.5)$$

The WFLC algorithm was evaluated in signals measured in patients suffering tremor, (Rocon et al., 2005c). In the trials done, the algorithm was able to estimate the tremor movement of all the patients with accuracy always lower than 2 degrees. The main disadvantage of the WFLC is the need for a preliminary filtering stage to eliminate the voluntary component of the movement. This filtering stage introduces an undesired time lag for our system when estimating tremor movement.

The ideal solution is to define a method that can estimate human voluntary and tremor movements in real time. The tremor literature (Elble et al., 1990), (Mann et al., 1989), (Riviere & Thakor, 1998), indicates that voluntary movements and tremor movements are considerably different. Voluntary movements are slower while tremor movements are brusquer. This indicates that adaptive algorithms to estimate and track movement would be useful when separating the two movements with an appropriate design. The underlying idea is to design the filters so that they only estimate the less dynamic component of the input signal, which in our case we consider to be voluntary movement, thereby filtering out the tremor movement. Thus, to estimate voluntary movement and tremor movement, the development of a two-stage algorithm is proposed to estimate voluntary movement and tremor movement with a minimum time lag, see Figure 5.

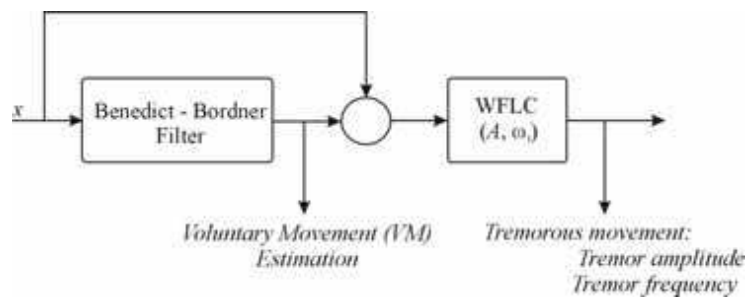

Fig. 5. Two-stage tremor modelling: first, the low frequency content voluntary motion is estimated, secondly, the voluntary motion estimation is subtracted from the original motion, eventually, tremor frequency and amplitude are determined.

First, a set of algorithms was considered to estimate voluntary movement: two point-extrapolator, critically damped g-h estimator, Benedict-Bordner g-h estimator, and Kalman filter. These algorithms implement both estimation and filtering equations. The combination of these actions allows the algorithm to filter out the tremor movement from the overall movement while reducing the phase lag introduced, (Bar-Shalom & Li, 1998). The equation parameters were adjusted to track the movements with lower dynamics (voluntary movement) since tremors present a behaviour characterised by quick movements, (Rocon et al., 2006). The algorithms evaluated were two-degree-of-freedom estimators, i.e., they assume a constant speed movement model. This assumption is reasonable since the sample period is very small compared with the movement speeds (Brookner, 1998), i.e., the sample period adopted was 1 ms and the voluntary movement estimated occurs in a bandwidth lower than 2 Hz. The performance of these algorithms was compared based on their accuracy when voluntary movements of tremor time series from patients were estimated. The result of this analysis indicated that the Benedict-Bordner filter presents the best results with the lowest computational load, (Rocon et al., 2006). This estimation algorithm is a g-h filter with the following tracking update equations:

$$\dot{x}_{k,k}^* = \dot{x}_{k,k-1}^* + h_k \left(\frac{y_k - x_{k,k-1}^*}{T} \right) \quad (1.6)$$

$$x_{k,k}^* = x_{k,k-1}^* + g_k (y_k - x_{k,k-1}^*) \quad (1.7)$$

and g-h prediction equations, (Brookner, 1998).

$$\dot{x}_{k+1,k}^* = \dot{x}_{k,k}^* \quad (1.8)$$

$$x_{k+1,k}^* = x_{k,k}^* + T \dot{x}_{k+1,k}^* \quad (1.9)$$

The tracking update equations or estimation equations (equations 1.6 and 1.7) provide the joint angular speed and position. The estimated position is based on the use of current measurement as well as past prediction. The estimated state contains all the information that we need from the previous measurements. The predicted position is an estimation of x_{k+1} based on past states and prediction, equations 1.8 and 1.9, and takes into account current measurement using updated states. The Benedict-Bordner estimator is designed to minimise the transient error. Therefore, it responds faster to changes in movement speed and is slightly under damped, (Bar-Shalom & Li, 1998). The relation between filter parameters is defined by equation 1.10:

$$h = \frac{g^2}{2-q} \quad (1.10)$$

In the second filter stage, the voluntary movement estimated in the first stage is subtracted from the input signal, so it is assumed that the remaining signal is tremor. In this stage the WFLC is used to estimate the amplitude and frequency of tremor movement in real time.

The capacity of the algorithm to estimate the tremor movement parameters was also evaluated in over 40 patients. This study proved that the estimate of tremor movement has a maximum convergence time of 2 seconds and that, after this convergence time, the mean error to estimate tremor movement is always lower than 1 degree. Figure 6 illustrates the functioning of the algorithm with a patient suffering essential tremor when drawing a spiral.

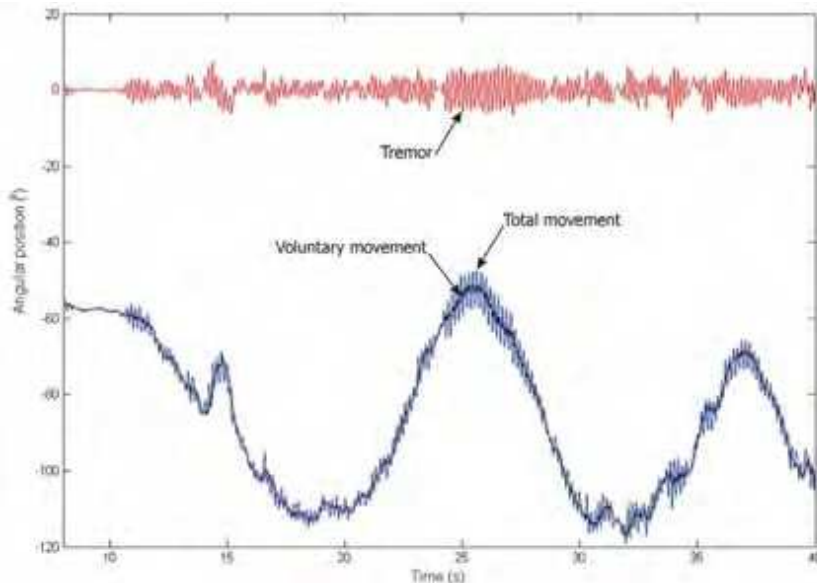

Fig. 6. Illustration of the functioning of the algorithm proposed to estimate voluntary movement and tremor movement with a minimum time lag. The total movement corresponds to the elbow joint of a patient with essential tremor when drawing a spiral. The algorithm consists of two stages, in the first the voluntary movement is estimated using the Benedict-Bordner filter and, in the second stage, the tremor movement is estimated using the WFLC.

4. Measurement protocol

In order to evaluate the capacity of the exoskeleton to suppress the upper-limb pathological tremor, a number of experiments were done. To achieve this aim a protocol was defined for the experiments. These experiments aim 1) to evaluate the hardware platform that was developed 2) to validate the control strategies developed for mechanical pathological tremor suppression 3) to determine the differences between active and passive approaches (control) 4) to determine the best combination of parameters for each approach 5) to evaluate the functionality of the different alternative actuators 6) to estimate the possible impact and acceptance of a future orthotic model to suppress tremor.

The trials were done in two different countries. In the first evaluation stage pre-clinical trials were done at the Department of Neurology at Hôpital Erasme in Brussels, Belgium. The second clinical trial stage was done at the Department of Neurology at the Hospital General in Valencia, Spain. The experiment protocol was approved by the ethical committees at each hospital where the trials were done.

The functioning of the WOTAS exoskeleton was evaluated in 10 patients with tremor-related diseases. The pathology of each patient was first diagnosed by a neurologist at the hospital using the quantification functional scale by Faher et al., (Fahn et al., 1998). There were a total of 7 male patients and 3 female patients. All the patients signed an experiment protocol consent form. They also authorised the data obtained in the experiments to be used for scientific purposes.

During the experiments the only person who knew how the exoskeleton worked was the operator, i.e., the patient, physiotherapist and the doctor did not know whether the orthosis was applying some active or passive strategy to suppress the tremor or whether it was working in free or monitoring mode. This was the approach adopted to reduce the placebo effect obtained in the experiments (Belda et al., 2004).

4.1 Evaluation tasks

In the framework of the project and using a medical base, a set of tasks was selected for patients to do in the evaluation trials. The tasks selected were 1) keeping the arms outstretched 2) taking the finger to the nose 3) keeping the upper limb in a resting position 4) drawing a spiral.

All the tasks done by the patients are clinical and functional trials that neurologists use to diagnose tremor-related diseases. These trials provide relevant amplitude and frequency information that can be used to classify the pathological tremor. Three different measurements for each task and WOTAS functioning mode had to be done to guarantee the repeatability of the data. Similarly, for each of the tasks the time taken to do the task, the time between measurements and a specific file code to be stored on the disk were defined. The total number of repetitions of the tasks was selected so that the total time of the measurement session did not exceed 1 hour to avoid patient fatigue and tiredness during the trials. During the experiments, the different WOTAS functioning modes and tasks were generated randomly. This approach reduced the learning effects and their effect on the analysis of the data obtained, (Rocon et al., 2005a).

4.2 Data analysis

The data used for the analysis come from the gyroscopes placed on each of the joints activated by the WOTAS exoskeleton. The output value of the gyroscopes was sampled at a

frequency of 2 KHz. To analyse the values, the data acquired were filtered using a Kernel smoother algorithm and a Gaussian window with 51 width points. The figure of merit selected, R , to evaluate the functioning of the WOTAS exoskeleton is the relation between the spectral power of patient movement with WOTAS operating in monitoring mode, P_{mm} , and the spectral power of patient movement with WOTAS operating in tremor suppression mode P_{ms} , passively and actively, equation 1.10. The bandwidth analysed was between 3 and 8 Hz due to the fact that most pathological tremors occur in this frequency range, (Rocon et al., 2004). Furthermore, voluntary movements related to tasks developed in these experiments occur at frequencies below 2 Hz, (Rocon et al., 2004).

$$R = \frac{P_{ms}}{P_{mm}} \cdot 100 \quad (1.11)$$

Thus, the signal used as a reference is the signal acquired with WOTAS operating in the monitoring mode and the effectiveness of the strategy to suppress the tremor refers to this value. Accordingly, we achieve that both time series (monitoring and suppression) are acquired while the user is wearing the exoskeleton, thereby ensuring that tremor reduction is only due to the action of the tremor suppression strategies and not the mere use of the exoskeleton, (Belda et al., 2004).

5. Experimental results and discussion

Figure 7 illustrates the results obtained from analysing the data generated during the measurement sessions. The abscise axis of the Figure represents the R value in the different experiments with WOTAS operating in the tremor suppression modes actively and passively. The ordinate axis coordinates are related to the patient tremor power obtained when WOTAS operates in the monitoring mode.

In Figure 7 we can check that the robotic exoskeleton has a minimum tremor suppression limit, i.e., if the spectral density of tremor movement is below a lower limit, around $0.15 \text{ rad}^2/\text{s}^3$, the WOTAS exoskeleton is ineffective in suppressing the tremor. This spectral energy density corresponds to a tremor with moderate amplitude which is not visually detectable. The existence of a lower WOTAS functioning limit was expected because for tremor amplitudes, the relative movement between the user's skin and the exoskeleton structure acts as a dead zone. Moreover, the system backlash prevents it from acting on tremors with such small amplitudes. The authors believe that this is due to the system backlash and the relative movement between the user's soft tissues and the exoskeleton structure, (Rocon et al., 2005b).

In accordance with the results obtained, it can be said that the mean range of tremor reduction in the active functioning mode is between 3.4% and 95.2%, with a mean reduction value in tremor movement energy of 81.2%. The results obtained also indicate that when the exoskeleton is functioning in passive mode, the mean range of tremor reduction obtained by the WOTAS exoskeleton is between 12% and 92% and the mean reduction value was 70%. The maximum values of tremor reduction were 92.3% and 97.1% for the passive and active strategies, respectively. When we consider the effect of the exoskeleton on the tremor, irrespective of the strategy applied, we attain a mean reduction of 78.6% in tremor movement energy. Figure 8 illustrates the reduction in tremor energy for a patient with essential tremor. In both instances, actively and passively, the reduction in tremor amplitude is visible. This reduction can also be seen in the frequency domain (graphs on the right of the Figure) which illustrates the power spectral density, calculated by the FFT of

the tremor signal, of the same signal. It is important to highlight that the movement frequency has not changed, i.e., the energy associated with tremor movement was significantly reduced but the frequency of the tremor stayed the same. This result is in accordance with the theoretical forecasts, (Adelstein, 1981), since on adding viscosity to the human upper-limb second-order biomechanical model, we alter movement amplitude and do not change its frequency.

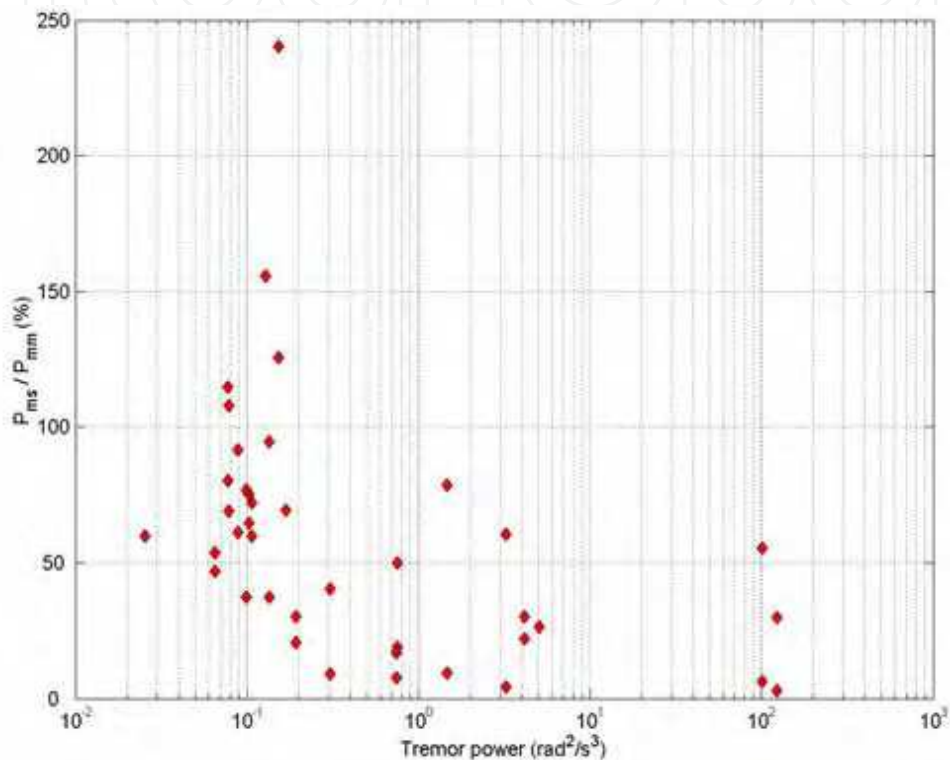

Fig. 7. Relation between the spectral power of patient tremor movement with WOTAS operating in *monitoring* mode, P_{mmr} , and the spectral power of patient tremor movement with WOTAS operating in the tremor suppression modes P_{ms} . This relation quantifies the reduction in tremor amplitude with the application of control strategies.

The reduction values attained are very high but the authors believe that not all this reduction is the result of limb tremor reduction. This is due to the fact that the transmission of exoskeleton movement to the limb is not a rigid transmission, i.e., although the tremor in the exoskeleton is reduced 97% (as is shown in the results) the limb tremor is not reduced in this proportion due to the arm movements in relation to the exoskeleton supports. Analysis of the videos recorded during the measurement sessions show that exoskeleton movement was indeed reduced with the application of control strategies, but there was, however, a residual tremor in the limb.

Another interesting point highlighted by three of the ten patients evaluated is that the visual feedback of tremor reduction produces positive effects on the task undertaken. These patients said that it was easier to do the tasks when the exoskeleton was active. In their

opinion, the fact that they could see that the tremor was reduced made them tremble less. This indicates that the tremor reduction caused by the robotic exoskeleton stems from two reasons 1) the effect of the control strategies and the application of forces on tremor movement 2) the visual feedback (biofeedback) of tremor reduction due to the action of the control strategies.

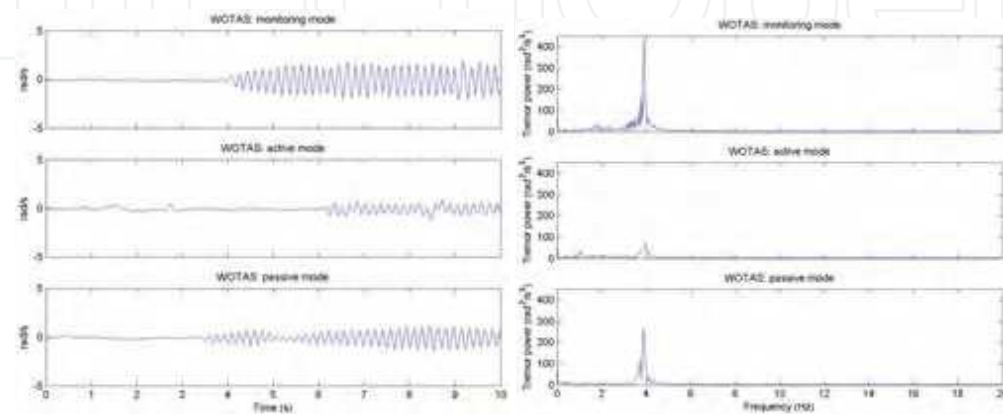

Fig. 8. Time series (left) and power spectral density (right) of the tremor movement of the wrist joint of a patient with essential tremor when taking the finger to the end of the nose using different tremor suppression strategies.

The effect of the visual feedback of tremor reduction on the generation mechanisms was detected in these experiments and will be the subject of future research by the authors. It is important to highlight that this was not detected by the users, which indicates that a study is required to determine the patients who benefit from this feedback.

6. Conclusions

Tremor is the most common movement disorder and is an important source of functional disability, affecting many daily tasks. For cases where treatment is not successful, the path to take is technological aids in the form of mechanisms attached to the arm (robotic exoskeletons).

This article has evaluated the different aspects of the WOTAS robotic exoskeleton. The WOTAS was evaluated with patients in real situations and a number of clinical tasks were defined, which were selected when the evaluation was done with the systems. Ten patients took part in the clinical experimentation stage of the system. The patients wore the device while it operated in three possible operation modes: monitoring, passive suppression and active suppression. Clinical effectiveness (from the variables obtained) and user acceptance were the base for selecting the best combination of algorithm parameters. Flaccidity and white tissue characteristics of the muscular system were the main disadvantages to providing the compensatory force on the arm, at the moment when the algorithms intervened to suppress tremor. However, reductions of approximately 80% in tremor power were obtained in patients suffering severe tremor. From the results and tremor reduction obtained in the system evaluation trials, the importance of these exoskeleton devices was demonstrated.

Thus at the Instituto de Automática Industrial, where this work was done, the aim is to begin developing an exoskeleton device like WOTAS but for a more general application, not only for cancelling tremor but also for generating and applying forces of different kinds on the upper limb to evaluate other types of pathologies and neuro-motor studies.

Robotic devices, like the one presented in this chapter, represent assistance technology to reduce dependency and allow patients to do daily tasks autonomously.

7. References

- Adelstein, B.D. (1981). Peripheral mechanical loading and the mechanism of abnormal intention tremor. PhD thesis. MIT.
- Belda-Lois, J.M., Vivas, M.J., Castillo, A., Peydro, F., Garrido, J.D., Sanchez-Lacuesta, J., Barberá, R., Poveda, R. & Prat, J. (2004). Functional assessment of tremor in the upper-limb. In: International Journal of Rehabilitation Research: Proceedings of the 8th Congress of European Federation for Research in Rehabilitation. Ljubljana, Slovenia.
- Bar-Shalom, Y. & Li, X.R. (1998) Estimation and Tracking: Principles, Techniques, and Software. Artech House Publishers.
- Brookner, E. (1998) Tracking and Kalman Filtering Made Easy. John Wiley & Sons, Inc.
- Elble, R., Sinha, R. & Higgins, C. (1990) Quantification of tremor with a digitalizing tablet. *Journal of Neuroscience Methods*, 33:193-198.
- Fahn, S., Tolosa, E. & Marin, C. (1998) Clinical rating scale for tremor. In E. Tolosa J. Jankovic, editor, *Parkinson's disease and movement disorders*. Urban & Schwarzenberg, Baltimore.
- Hogan, N. (1985). Impedance control: An approach to manipulation: Part I - theory. *Journal of Dynamics System, Measurement and Control* 107, 1-7.
- Inoue, T. (1990). Practical repetitive control system design. In: Proceedings of 29th IEEE Conference on Decision and Control. Vol. 3. IEEE. pp. 1673-1678.
- Kapandji, I. (1983). The physiology of the joints: Upper limb. Churchill Livingstone, vol. 1.
- Kotovskiy, J. & Rosen, M.J. (1998). A wearable tremor-suppression orthosis. *J. Of Rehabilitation Research and Development*.
- Mann, K.A., Werner, F.W. & Palmer, A.K. (1989) Frequency spectrum analysis of wrist motion for activities of daily living. *Journal of Orthopedic Research*, 7(2):304-306.
- Manto, M., Topping, M., Soede, M., Sanchez-Lacuesta, J., Harwin, W., Pons, J.L., Williams, J., Skararup, S. & Normie, L. (2003). Dynamically responsive intervention for tremor suppression. *IEEE Engineering in Medicine and Biology* 22(3), 120-132.
- Markensco, X. & Yannas IV (1979). On the stress-strain relation for skin. *Journal of Biomechanics* 12(2), 127-129.
- Pons, J.L., Rocon, E., Ceres, R., Reynaerts, D., Saro, B., Levin, S. & Van Moorlegghem, W. (2004). The manus dextrous robotics upper limb prosthesis: mechanical and control aspects. *Autonomous Robots* 16, 143-163.
- Riviere, C.N. & Thakor, N.V. (1998). Modeling and canceling tremor in human-machine interfaces. *IEEE Engineering in Medicine and Biology* pp. 29-36.
- Rocon, E., Bueno, L., Ceres, R., Calderón, L. & Pons, J.L. (2003). Theoretical control discussion on tremor suppression via biomechanical loading. In *Asistive Technology - Shaping the future*, pages 827-831.

- Rocon, E., Belda-Lois, J.M., Sanchez-Lacuesta, J.J. & Pons, J.L. (2004). Pathological tremor management: modelling, compensatory technology and evaluation. *Journal of Technology & Disability* 16, 3-18.
- Rocon, E., Ruiz, A.F, Pons, J.L., Belda-Lois, J.M. & Sánchez-Lacuesta, J.J. (2005a). Rehabilitation robotics: a wearable exo-skeleton for tremor assessment and suppression. In: *International Conference on Robotics and Automation 2005 - ICRA05*. pp. 241-246.
- Rocon, E., Belda-Lois, J.M., Sánchez-Lacuesta, J.J., Ruiz, A.F. & Pons, J.L. (2005b). Estimation of biomechanical characteristics of tremorous movements based on gyroscopes. In: *Asistive Technology - from Virtuality to Reality. AAATE05*. Lille, France.
- Rosen, M.J., Arnold, A.S., Baiges, I.J., Aisen, M.L. & Eglowstein, S.R. (1995). Design of a controlled-energy-dissipation orthosis (cedo) for functional suppression of intention tremors. *J. Of Rehabilitation Research and Development* 32(1), 1-16.
- Ruiz, A.F. (2005). *Robótica aplicada a la rehabilitación y asistencia de discapacitados. Trabajo de Investigación del Curso de Ingeniería de la rehabilitación al servicio de la discapacidad.*
- Tsagarakis, N.G. & Caldwell, D.G (2003). Development and control of a soft-actuated exoskeleton for use in physiotherapy and training. *Autonomous Robots*, 15:21-33.



Rehabilitation Robotics

Edited by Sashi S Kommu

ISBN 978-3-902613-04-2

Hard cover, 648 pages

Publisher I-Tech Education and Publishing

Published online 01, August, 2007

Published in print edition August, 2007

The coupling of several areas of the medical field with recent advances in robotic systems has seen a paradigm shift in our approach to selected sectors of medical care, especially over the last decade. Rehabilitation medicine is one such area. The development of advanced robotic systems has ushered with it an exponential number of trials and experiments aimed at optimising restoration of quality of life to those who are physically debilitated. Despite these developments, there remains a paucity in the presentation of these advances in the form of a comprehensive tool. This book was written to present the most recent advances in rehabilitation robotics known to date from the perspective of some of the leading experts in the field and presents an interesting array of developments put into 33 comprehensive chapters. The chapters are presented in a way that the reader will get a seamless impression of the current concepts of optimal modes of both experimental and applicable roles of robotic devices.

How to reference

In order to correctly reference this scholarly work, feel free to copy and paste the following:

J.L. Pons, E. Rocon, A.F. Ruiz and J.C. Moreno (2007). Upper-Limb Robotic Rehabilitation Exoskeleton: Tremor Suppression, Rehabilitation Robotics, Sashi S Kommu (Ed.), ISBN: 978-3-902613-04-2, InTech, Available from: http://www.intechopen.com/books/rehabilitation_robotics/upper-limb_robotic_rehabilitation_exoskeleton__tremor_suppression

INTECH
open science | open minds

InTech Europe

University Campus STeP Ri
Slavka Krautzeka 83/A
51000 Rijeka, Croatia
Phone: +385 (51) 770 447
Fax: +385 (51) 686 166
www.intechopen.com

InTech China

Unit 405, Office Block, Hotel Equatorial Shanghai
No.65, Yan An Road (West), Shanghai, 200040, China
中国上海市延安西路65号上海国际贵都大饭店办公楼405单元
Phone: +86-21-62489820
Fax: +86-21-62489821

© 2007 The Author(s). Licensee IntechOpen. This chapter is distributed under the terms of the [Creative Commons Attribution-NonCommercial-ShareAlike-3.0 License](https://creativecommons.org/licenses/by-nc-sa/3.0/), which permits use, distribution and reproduction for non-commercial purposes, provided the original is properly cited and derivative works building on this content are distributed under the same license.

IntechOpen

IntechOpen