

See discussions, stats, and author profiles for this publication at: <https://www.researchgate.net/publication/3878120>

Design of intelligent braking system

Conference Paper · February 2000

DOI: 10.1109/TENCON.2000.888804 · Source: IEEE Xplore

CITATIONS

3

READS

2,565

2 authors:



Naim Sidek

International Islamic University Malaysia

73 PUBLICATIONS 239 CITATIONS

[SEE PROFILE](#)



Momoh Salami

International Islamic University Malaysia

140 PUBLICATIONS 933 CITATIONS

[SEE PROFILE](#)

Some of the authors of this publication are also working on these related projects:



Two-Wheeled Wheelchair for Disabled [View project](#)



Decision Making in Cognitive Radio: Automatic Threshold Estimation [View project](#)

DESIGN OF INTELLIGENT BRAKING SYSTEM

S. N. Sidek and M.J.E. Salami
Kulliyah Of Engineering, IIUM,
Jalan Gombak, 53100 Kuala Lumpur.
E-mail: snaim@iiu.edu.my

Abstract: It is anticipated that a variety of cars with diversified features that include anti-lock braking system (ABS), traction control system (TCS), antiskid steering, collision warning system (CWS) will be more commercially produced to satisfy the consumer needs in the near future. This is parallel to the trend of current technology of manufacturing smart cars and the desires of people who always want to have comfortable and safe ride in their vehicles. Moreover this type of vehicles can fit much better into the intelligent highway that Malaysian government is planning to have in the near future. Consequently, there is a need to modify the current conventional braking system so as to make it work automatically. This paper considers the use of intelligent controller to achieve the above objective. To ensure high speed of system response, the DSP controller TMS320C24x with embedded fuzzy algorithm is used in the implementation of this new device. Results of simulation studies using the MATLAB have demonstrated the feasibility of this new system under investigation.

Key words

Intelligent braking system, smart cars, neuro-fuzzy controller, DSP processor.

1. Introduction

Research works in the area of smart cars production and development of intelligent highway system have increased recently. For example the research group, under the comprehensive plan called Intelligent Vehicle Highway System (IVHS) [1], has reported the development of a braking system that is automated along the guidance of the cars. The use of control laws helps them in implementing this system.

A feasible study in the use of DSP-based fuzzy controller for the implementation of intelligent braking system is investigated in this paper. The controller is an ideal choice to deal with this system since it is complex in nature with a lot of uncertainties. Furthermore the controller can infuse nicely into the smart cars since a lot of decisions need to be taken while driving the car. The fuzzy controller uses the combination of fuzzy concept and neural network. In this paper, data from the experts have been collected before the IF-THEN reasoning set of rules is programmed in the controller. Using heuristic trial and error, the rule is tuned to confirm the data from the expert experience. To further increase its robustness the rules are presented in neural network form so that it can compromise the changing parameter of the system when it is online-trained. The simulation of the system in the block diagram shown in Fig. 1 has been done using MATLAB via its special fuzzy logic toolbox and the result obtained is compared to the one that

uses the conventional control law. This paper is divided into three main parts. The first part will detail the structure of the system. The next part will explain the uniqueness and the differences between conventional controller and fuzzy controller. Finally, the last part will show some of the simulation results.

2. Braking System Structure

Fig. 1 depicts the system block diagram, which consists of sensors, actuator and fuzzy controller. The system inputs are derived from the cars' velocities, where the speedometer will measure the velocity of the car under control and laser sensor will be used to measure the front car velocity. This information will be used to calculate the distance between two cars and also their corresponding safe distance. The inputs for the fuzzy controller are the error difference between the current distance and the saved one and the rate of change of the error difference. The fuzzy controller processes the inputs from the sensors and issues an appropriate command in order to actuate the braking system via auxiliary hydraulic module implanted before the braking system.

2.1 Sensor

Sensors are vital and play important roles in this application, hence they need to be wisely distinguished and selected. Their task in this system is to measure the distance between two cars and their speed. In the realm of distance or range sensor, there are several types of sensors with distinctive features and characteristics. Each of them has their own strengths and weaknesses and is being used in different domains. For example in brake application, ultrasonic sensor is not very good since it is sensitive to drafts and high frequency ambient noise that come from the radiator. The same also applies to infrared sensor and in addition, its effectiveness is reduced at high ambient temperature. As discussed in [4], the diffuse reflective photoelectric sensor is suitably used in the collision avoidance system since it can be integrated in brake system; the modulated infrared light source provides immunity to ambient light.

Another practical choice is microwave sensor, which has been widely used in the police radar. It can detect objects in the great distance depending on the target size, microwave power available, the position of the target in the aerial beam and the antenna capability [8]. From mass production point of view, they are not that cost effective. In this paper the use of laser radar to measure distance and relative velocity of the two cars is considered. As far as cost and accuracy are concerned, laser radar seems to be the best sensor for this application. Its sensing range is typically 150+ meter and it is not very expensive. It has a comparatively small

size of approximately 50mm X 100mm and the response time is fast [5]. In addition its directionality is high and can be of order 1 degree. Table 1 shows the relation between the distance and the width covered by the laser radar. From this table, it is observed that the laser sensor is good in longitudinal study of the system as the width covered is usually within that of a lane. It is also interesting to know that some companies such as Leica, Fiat, Mazda, Mitsubishi etc have reported the use of this technology on their test and some of the commercialized products.

To date, there are four existing techniques for measuring distance using this type of sensor [5,6]. The first method uses pulse timing. The other three methods are phase comparison, Doppler methods and interferometry. The pulse timing technique is used in this work since it is widely used and it can be integrated easily into the system controller. The idea behind the technique stems from its name, which involves measurement of time of flight (TOF). TOF is the time for the laser pulse to be transmitted from the laser diode to the reflective surface of the object and return back to the photo detector. The schematic of the laser radar using this technique is shown in Fig. 2. The middle block of this figure works as a dirt-detecting part. The lights from the LED will supply the photo diode the necessary information about the condition of contamination on the front surface of the laser radar unit so that the necessary intensity of the laser pulse can be driven accordingly. A novel method to measure the distance and the relative velocity using the pulse timing technique in laser radar technology has been suggested and experimented in [7]. This method results in better accuracy as compared to the previous method that uses a counter. In the counter method, manufacturers always use 50Mhz counter and adopt simultaneous counting up-down edge in order to improve resolution up to 100MHz. Since distance is calculated from

$$\text{distance} = \frac{\Delta t \times c}{2} \dots\dots\dots (1)$$

where Δt is time delay and c is the speed of light, it follows that a resolution 1.5m is attainable with this method. A new method that has been introduced in [7] is called integration method; see Fig. 3. In this method, instead of counting the distance directly, the signal from the flip-flop circuit is directed through a low pass filter to form the integrated voltage. The voltage is proportional to the time delay and this can be used to measure the distance. To perform the calculation in the microprocessor, the ADC is used to convert the analog signal into a digital form. In this case the resolution of this new method depends on the resolution of the ADC. For example a commercial 12-bit ADC will have a resolution of 0.25nsec, which is equivalence to 3.7 centimeter if the maximum range Δt of 1 μ sec is assumed. From the leading and following vehicle velocities, V_A and V_B respectively, the formula of safe distance is as follows:

$$d_{\text{saved}} = (t_m \times V_A) + \frac{V_A^2}{2\alpha} - \frac{V_B^2}{2\beta} \dots\dots\dots (2)$$

where α , β are vehicle's decelerations, t_m is free running time and last two terms in the formula represent the front and the rear vehicle braking distances.

V_A is measured from the speedometer in the car under control while V_B is calculated from

$$V_B = V_A + V_{B/A} \dots\dots\dots (3)$$

where $V_{B/A}$ is the relative velocity of V_B with respect to V_A . In fact $V_{B/A}$ can be estimated from the rate of change of rear vehicle distance during a short time interval. That is,

$$V_{B/A} = (d_1 - d_2) / \Delta t \dots\dots\dots (4)$$

where d_1 = distance measured one step before

d_2 = distance measured at present time

Δt = measurement time interval

The uncertainty measurement for the relative velocity comes from [7]

$$\Delta V_{B/A} = \frac{\sqrt{2}}{\Delta t} \Delta d \dots\dots\dots (5)$$

where Δd is the uncertainty of the measured distance. Assuming that Δd as 1.5 meter (corresponding to the smallest resolution for the counter method) and Δt equals to 0.2sec, then $\Delta V_{B/A}$ will be 10.6m/s (38km/hr). On the other hand, using the integration method the uncertainty will be reduced to 0.265m/s (1km/hr). Thus using the integration method for calculating the pulse return time improves the accuracy in the laser radar system.

2.2 Auxiliary Hydraulic Module

A set of module must be integrated into the conventional brake system in order to implement a computer controlled braking system. The performance of the Auxiliary Hydraulic Module (AHM), shown in Fig. 4, has been thoroughly studied and implemented in [9]. Results of analysis show that the actuator is not a very fast brake actuation as compared to the one using solenoid to control the valves. However this technique has a nice feature for providing driver override with minimal change in the conventional brake design. In fact, it fits the objective of systematically introducing this system slowly so that public can readily accept it. Basically the function of AHM is to provide controlled input force to a vacuum booster in the brake system through actuator and brake pedal. It will take the input from microcontroller, which has been programmed using fuzzy algorithm in the Pulse Width Modulation (PWM) form. The signal is used to generate pressure in the actuator by controlling the opening and the closing of the valves. PWM is a square wave signal of fixed frequency but with varying duty cycles. The varying duty cycles can indeed be utilized to determine the brake line pressure. If a constant amount of fluid is pumped through the valves, which is always opened by hydraulic pump, no pressure in the actuator will be developed. But if the valves are closed completely and suddenly, the sudden rise of pressure can be observed. As a matter of fact, switching the valves at high frequency as 100 Hz and maintaining the duty cycles as 50% of the period can develop an average amount of pressure. Thus, varying the duty cycles of the PWM can control the pressure in the actuator piston. If the duty cycle is 100% of the period (maximum duty cycle), then the valve is always opened and thus no pressure is developed. The mapping of duty cycles to brake-line pressure has also been investigated in [9] and interested readers can refer to this for more details.

2.3 Controller

The choice of the controller depends on the behavior of the system under study. Here, the braking system exhibits nonlinearity where factors such as friction between road and tires and any mechanical delay will definitely affect its performance. To develop a mathematical model that will take all such factors into consideration will definitely pose a lot of difficulties. Hence the choice of fuzzy controller for this system is suitable. Another reason that leads to the decision of using fuzzy controller is the superiority of this technology that enables it to transform linguistic terms into numerical values so that experiences from the experts can be utilized. The detail of this controller will be discussed in this paper

3. Conventional controlling technique

The analysis of braking system has been thoroughly investigated and reported in [2, 3]. Their simulation studies is based on [10,11],

$$m\ddot{x} = F - mg \sin(\phi) - \left[\frac{\rho AC_d}{2} (\dot{x} + V_{wind})^2 \operatorname{sgn}(\dot{x} + V_{wind}) - d_m \right]$$

which is the car model where ϕ is angle between the road surface and horizontal plane, ρ is mass of air, A is cross sectional area of vehicle, C_d is vehicle drag coefficient, V_{wind} is velocity of wind gust and d_m is mechanical drag. Several linear control laws for longitudinal control of vehicle have been proposed in their papers. From Newton's second law of motion, the dynamic equation of braking torque, T_b to vehicle speed, v and position, x is given by

$$\begin{aligned} \dot{x} &= v \\ \dot{v} &= \frac{1}{m} (-c_1 T_b - f_o - c_2 v - c_3 v^2) \end{aligned} \quad \dots \dots \dots (6)$$

so that $c_1 T_b$ is the braking force, f_o is static friction force, $c_2 v$ is rolling friction force and $c_3 v^2$ is air resistance force. One of the main control objectives is to make $V_A \approx V_B$. Another control objective is to keep the desired inter-vehicle spacing s_d , measured from the rear of lead vehicle to the front of the following vehicle, constant. In this paper s_d is chosen to be safe distance as in (2). Linearizing (7) gives [2],

$$\begin{aligned} \dot{v} &= u \\ \dot{u} &= k_5 v_r + k_6 \delta \end{aligned} \quad \dots \dots \dots (7)$$

where v_r is relative velocity between the two vehicles and $\delta = x_r - hv_B - s_0$. k_5 and k_6 are design parameter constants. It is therefore very cumbersome to determine all these parameters, as wrong choice will affect the performance of the whole system.

4. Neuro-Fuzzy Controller

Fuzzy control starts to gain recognition after witnessing a wide range of commercial products being marketed around the globe. The ability to mimic human control mechanism by transforming human linguistic set of rules, which governed certain set of control system into numerical form, gives advantage to this substantial tool to deal with the

system that has a lot of uncertainty and high complexity. It is an alternative to conventional control method in working with quantitative aspect of human reasoning and decision-making process. The design of this controller depends on two factors, namely the availability of human experts and technique to acquire knowledge as well as to transform them into rules and membership function. In this paper, the design of the controller is initiated by collecting data from the experts on how the brake system is controlled. The data are then processed to form a set of rules. The use of fuzzy controller to control the same system has been reported in [13] however the inference engine used is slightly different. In this paper, the fuzzy inference engine has two inputs and an output. The inputs are the error (difference between actual inter-vehicle spacing and their respective safe distance) and the rate of change of the error. The output is in the form of force that is to be exerted on the brake pedal while the vehicle is on motion. A set of governing rules has the following form:

- IF error is ZERO AND $d(\text{error})/dt$ is NEGATIVE LARGE THEN force is R1
- IF error is ZERO AND $d(\text{error})/dt$ is ZERO THEN force is R3
- IF error is ZERO AND $d(\text{error})/dt$ is POSITIVE LARGE THEN force is R5
-

For each of the two inputs, the set of the membership functions is as in Fig. 5:

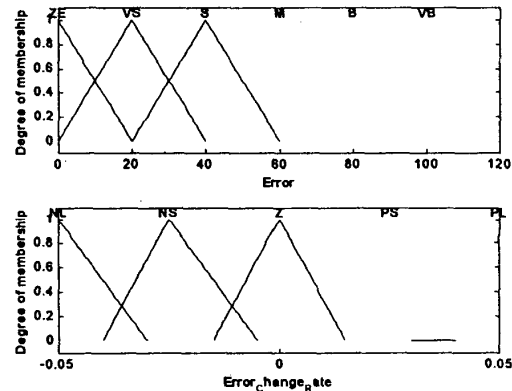

Figure 5

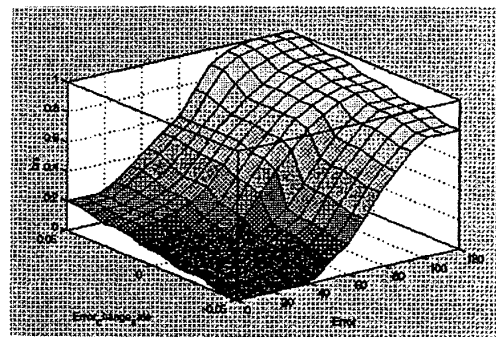

Figure 6

The antecedent part of the rules, R_n is the first order polynomial (i.e. $pnx + qnx + rn$). Here pn , qn and rn are the constants and, x and y are current inputs. Since the error has six membership functions and $d(\text{error})/dt$ has five, the total number of rules turn out to be thirty.

Fig. 6 shows the output control surface of the braking system with the algebraic product as the t-norm operator, the maximum as the t-conorm operator and the weighted average (8) as defuzzification method,

$$z = \frac{\sum w_i z_i}{\sum z_i} \dots\dots\dots (8)$$

where w_i is the i th firing strength and z_i is the i th antecedent polynomial.

The Matlab with Simulink software is used to run the dynamic simulation of the system. The availability of Fuzzy Logic Toolbox just increases the efficiency of this simulation. While running the program the fine-tuning process of the membership function is done simultaneously until a satisfied result is obtained. The next stage is to implement the rules in the neural network form. This is vital to the controller in order to have an ability to adapt and train itself while in the operating mode. Several algorithms have been developed and used so that the neural network can do the above-mentioned task [14, 15]. These can be mainly classified into derivative-based and derivative-free-based algorithms. The derivative based method is used in this paper because of its fast response. The back propagation and gradient descent are among the choice of the algorithms.

5. Simulation Studies

The system model is developed via Simulink block diagram. Fig. 7 and 8 show that the results fulfill the research target, which is to avoid collision by referencing to the safe distance. For each set of the figures below, the different initial inter-vehicle spacing has been set. The velocity of car B is set as a step function to represent the worst case as the car stops suddenly.

Inter-vehicle spacing: 20 meter

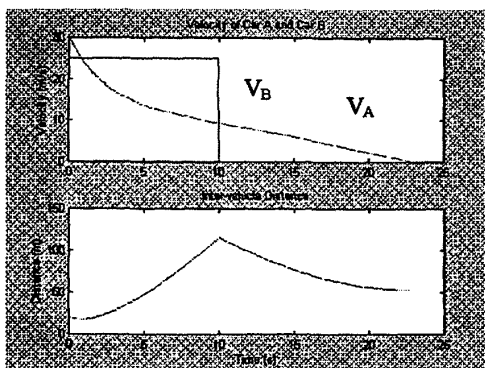

Figure 7

Inter-vehicle spacing: 90 meter

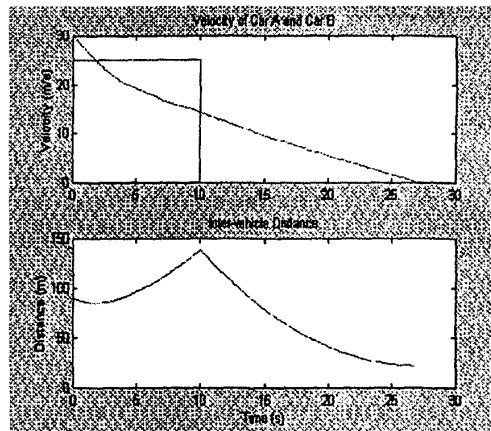

Figure 8

In accordance with *Jabatan Pengangkutan Jalan (JPJ)*, [16] the minimum distance between two cars can be determined by the "three-second distance concept" which implies that the initialization of 30m/s will give a 90meter safe distance. Considering the critical situation in which the inter-vehicle distance is 20 meter, it is found that the car still manages to stop before collision shown in Fig 7.

This initial study has also demonstrated the feasibility of using DSP-based neuro-fuzzy controller for the braking system. The hardware implementation of this system is currently under investigation.

6. Conclusion

In this paper, a review of controlling the braking system has been carried out. The technique of using laser sensor for effective measurement of inter-vehicle distance via integration procedure rather than the use of counter is suggested for optimal performance of the braking system. The results of the simulation studies have shown the effectiveness of neuro-fuzzy control to achieve a near-human behavior in controlling the braking system. This approach also compared favorably to the conventional approach, which is laborious to tune. Furthermore, simulation results have demonstrated the practicability of developing a DSP based neuro-fuzzy controller for implementing an intelligent braking system with fast response characteristic. It is expected that when this new system is completely developed it would be more efficient, robust and cost effective.

References

1. Collier W. J. and Weiland, R.J. "Smart Cars Smart Highways", IEEE Spectrum, April 1994.
2. Ploannou P. and Xu Z., "Throttle and Brake Control Systems for Automatic Vehicle Following", Path Research Report UCB-ITS-PRR-94-10.
3. Raza H., Xu Z. and Ioannou P., "Experimental Evaluation of Cooperative Driving System", Report 97-7-01, July 1997.

4. Solomon S, "Sensors Handbook", McGraw-Hill, New York, 1999.

5. Granet F. and Picado R., "Longitudinal Collision Avoidance", [http://www.path.berkeley.edu/~leap/AVCSS/Long Coll Avoid/#PRINCIPAL](http://www.path.berkeley.edu/~leap/AVCSS/Long%20Coll%20Avoid/#PRINCIPAL), 27 February 2000

6. Unnamed Author, "Range Finding Devices", <http://www.geocities.com/SiliconValley/Circuit/7815/ali/device.htm>, 19 February 2000

7. Jhang K. W., Hyun I.G. and Song K.I. et al, "A Novel Method for Distance and Relative Velocity Measurement in Rear-End Collision Warning System", Society of Automotive Engineer, Inc 1996.

8. Beckwith T. G., "Mechanical Measurement", Addison Wesley, 1990

9. Raza H., Xu Z. and Ioannou P., "Modelling and Control Design for a Computer-Controlled Brake System", IEEE

Trans. On Control System Technology, Vol. 5, No. 5, May 1997.

10. Sheikholeslam S. and Desoer C. A., "Longitudinal Control of a Platoon of Vehicle 1: Linear Model", PATH Research Report UCB-ITS-PRR-89-3

11. Sheikholeslam S. and Desoer C. A., "Longitudinal Control of a Platoon of Vehicle 2: First and Second Order Derivatives of Distance Deviations", PATH Research Report UCB-ITS-PRR-89-6.

12. Jang J.-S.R., Sun C.-T. and Mizutani E., "Neuro-Fuzzy and Soft Computing", Prentice Hall 1997.

13. Kosko B., "Fuzzy Engineering", Prentice Hall 1997

14. Wang L.W., "Adaptive Fuzzy Systems and Control: Design and Stability Analysis", Prentice Hall 1994.

15. T. L. Chin and George Lee C. S., "A Neuro-Fuzzy Synergism to Intelligent Systems", Prentice Hall 1996.

16. Personal reference

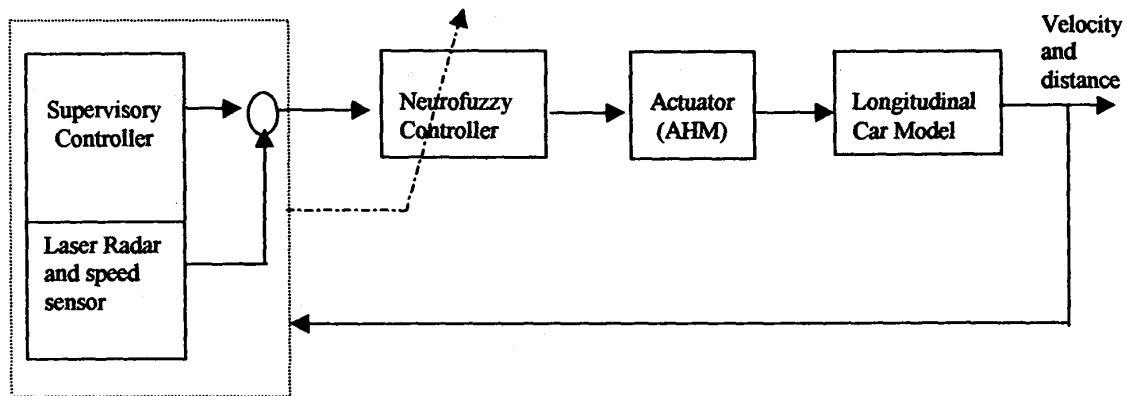

Figure 1: System block diagram

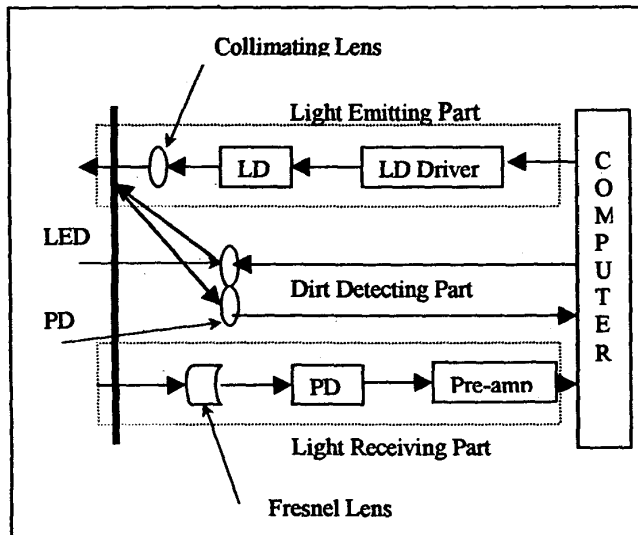

Figure 2: Laser radar construction

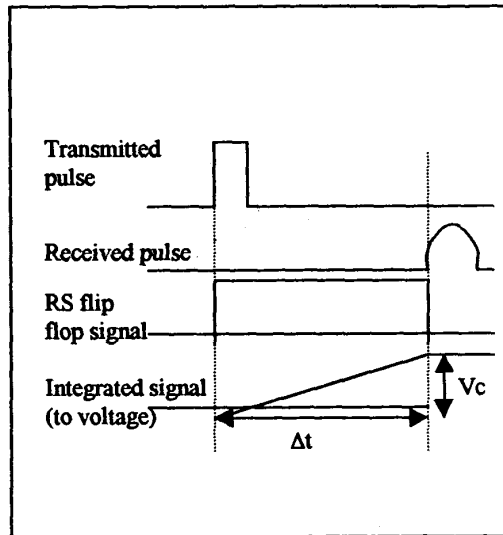

Figure 3: Distance measurement using integration method

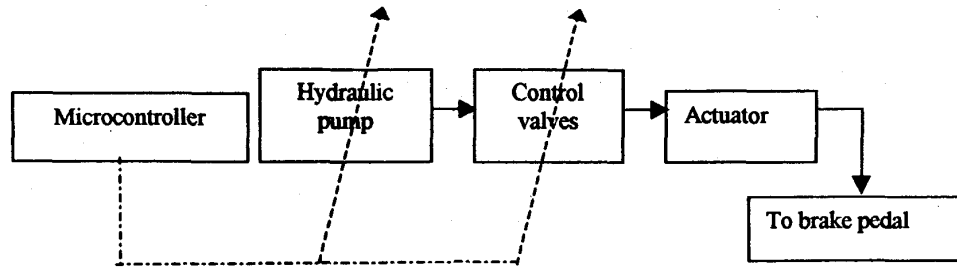

Figure 4: Auxiliary hydraulic module

Distance /meter	Width /meter
1	0.03491
5	0.17455
10	0.3491
20	0.6982
50	1.7455
100	3.491
150	5.2365

Table 1: Relation between distance and width