

Thermal comfort and runoff water quality performance on green roofs in tropical conditions

Mst. Nilufa Sultana, Shatirah Akib & Muhammad Aqeel Ashraf

To cite this article: Mst. Nilufa Sultana, Shatirah Akib & Muhammad Aqeel Ashraf (2017) Thermal comfort and runoff water quality performance on green roofs in tropical conditions, *Geology, Ecology, and Landscapes*, 1:1, 47-55

To link to this article: <http://dx.doi.org/10.1080/24749508.2017.1301058>



© 2017 The Author(s). Published by Informa UK Limited, trading as Taylor & Francis Group



Published online: 24 Mar 2017.



Submit your article to this journal [↗](#)



Article views: 31



View related articles [↗](#)



View Crossmark data [↗](#)

Thermal comfort and runoff water quality performance on green roofs in tropical conditions

Mst. Nilufa Sultana^a, Shatirah Akib^a and Muhammad Aqeel Ashraf^b

^aFaculty of Engineering, University of Malaya, Kuala Lumpur, Malaysia; ^bInternational Water, Air & Soil Conservation Society, Kuala Lumpur, Malaysia

ABSTRACT

This study is on monitoring program for urban Stormwater Management Manual for Malaysia (MSMA) and Eco-Hydrological in Kuala Lumpur, Malaysia. The rainwater was harvested and evaluated on the basis of three major parameters; Electric Conductivity, Dissolved Oxygen, pH, and indoor temperature. These parameters has been analyzed and compared with the National Water Quality Standards and Water Quality Index provided by the Department of Environment of Malaysia. This paper also analyzed the effect of using vegetated roofs on the pH value of rainwater using the adaptive neuro-fuzzy methodology, which simulates the rainwater quality parameter with adaptive neuro-fuzzy inference system (ANFIS). The performance of proposed system is consolidated by simulation results. The study revealed that the ANFIS model can be used to determine rainwater quality parameter with high reliability. For that reason, it can be connected for reasonable purposes. Meanwhile, the influence of green roof in reducing indoor temperature is very important.

ARTICLE HISTORY

Received 24 August 2016
Accepted 10 December 2016

KEYWORDS

Runoff; thermal comfort;
water quality; fuzzy interface
system

Introduction

Water is the most vital natural resource for existence of lives and plants on the Earth. There is no other natural resources that have such an overpowering influence on human lives and plants. The freshwater is only about 2.7% of the total water available on the Earth, people already used the half of the world's accessible freshwater and about three-quarters is going to be consumed by 2025. If this current consumption rate continues, at least 3.5 billion will live in water-stressed river basin within just next 20 years (Sultana, Akib, Aqeel Ashraf, & Roseli Zainal Abidin, 2015). The fact is that this available freshwater of the planet is enough for the total population, but this amount of freshwater is not uniformly distributed all over the world. The water consumption per capita of the USA is 269 L/day and the people of South Africa consume only 6 L/day. Whereas, the daily average demand of water is 49 L/person which includes drinking, cooking, washing, and bathing. Above information easily proved that a large amount of world's poorest population living in lack of enough freshwater (Pacific Institute, Oakland, California). As soon as the water becomes scarce, it creates international regional conflict (Getter, Rowe, & Andresen, 2007).

Now, this world badly needs to resolve the freshwater crisis. Among various applied methods, desalination or removing salt from sea water is the most known procedure to access freshwater, but desalination technologies

are highly expensive and energy oriented. Other processes includes multistage flash distillation, capacitative deionization is very expensive and relies on energy. Thus, the concentration shifted to rainwater once again consecutively with green roof system. There are four forms of freshwater available in the Earth, such as: rainfall, atmosphere moisture, surface water, and ground water. The Earth's most elevated source of freshwater is rain, and rainwater harvesting has a vital role to play in water resources and watershed management. Rainwater harvesting has an established historical past as a philosophy as well as a technology for water management and supply (Smet & Moriarty, 2001). This system has been used in almost every part of the world by all societies. Due to rapid increase in population, rapid urbanization, and global change, water demand is increasing day by day and causes water shortages. Rainwater harvesting has been identified as a useful technology for mitigating the effects of drought, as well as an adaption response for the impact of saltwater encroachment related to global weather change and rises in the sea level on the coastal groundwater resources of small island sates (McConney, Nurse, & James, 2009). An analysis in Dhaka city of Bangladesh, established that utilization of harvested rainwater can save 11% of public water supply per year and the volume of collected rainwater can serve about 1.5 month in a year without the traditional water supply (Rahman et al., 2014).

CONTACT Muhammad Aqeel Ashraf  ashraf@inwascon.org.my

© 2017 The Author(s). Published by Informa UK Limited, trading as Taylor & Francis Group.

This is an Open Access article distributed under the terms of the Creative Commons Attribution License (<http://creativecommons.org/licenses/by/4.0/>), which permits unrestricted use, distribution, and reproduction in any medium, provided the original work is properly cited.

Harvesting rainwater is a sustainable solution to the demand for potable water in urban developments, because it provides the cleanest water (Gonçalves et al., 2003; Lye, 2009). Roofs are the first choice for the rainwater harvesting as their runoff is often considered as less polluted water (Förster, 1999). The quality of harvested rainwater basically depends on the types of roofing materials, the climatic conditions of the local area, and the levels of atmospheric pollutions (Chang, McBroom, & Scott Beasley, 2004; Lee, Yang, Han, & Choi, 2010), though Lee and Jones (1982) have shown that roofing materials have no significant role on the quality of harvested water. Rainwater harvesting is a system of collection and storage of rainwater for non-potable uses such as fire suppression, cooling towers, gardening plants, general household cleaning, landscape irrigation, building cleaning, pond filling, toilet flushing, and vehicle washing. A rainwater harvesting system must go through a filtering process or first flush diversion apparatus to ensure the cleanliness of rainwater.

A green roof or “living roof” is a roof that is partially or completely covered with vegetation and a growing medium, planted over a water proof membrane. Also, it can include additional layers, such as a root barrier, a drainage system, and an irrigation system (Castleton, Stovin, Beck, & Davison, 2010). In other way, a green roof is a vegetated rooftop, which consists of different layers covered with plants over an existing roof structure. The growing medium of plants (soil) is placed on a water proofing membrane so that water cannot percolate through the medium and damage the roof structures. Green roofs allow traditional vegetation without disrupting urban infrastructures in any way. It is more useful when compared to alternatives, for it takes up negligible space (Sheng, Mari, Ariffin, & Hussein, 2011). There are

two main types of green roofs: intensive and extensive. Intensive green roof types are frequently alluded to as rooftop greenery enclosures. Mentens, Raes, and Hermly (2003) have mentioned another type of green roof named natural green roof that has unconstrained root and consists of different types of moss and lichen. It takes 10–20 days to grow up and it is difficult to maintain.

In Malaysia, rainfall is very intense in a short duration and it is very challenging to manage this storm water. So, it is very essential to make better use of rainwater for the expanding cities like Malaysia. In HTC, there are five typical components placed in HTC including rainwater harvesting system and green roof, porous pavement, gray water reuse system, bioretention system, and constructed wetland. All components are linked together to discover as an integrated sustainable stormwater management system. The present study incorporated the opportunities for stormwater harvesting through green roofs and reuse, quality analysis of the harvested rainwater from green roofs, make comparison with National Water Quality Standards (NWQS) and Water Quality Index (WQI) in Malaysia, and the runoff quality performance of green roofs.

Site description

The monitoring program for MSMA-SME Ecohydrological project is performing at Humid Tropic Centre (HTC), Jalan Ledang, Taman Duta, 50480-Kuala Lumpur, Wilayah Persekutuan, near the Department of Irrigation and Drainage, situated on the west coast of the Peninsular Malaysia. The geographical coordinates of Kuala Lumpur are 3° 10' 0" North and 101° 42' 0" East. Figure 1 shows the geographical position of the study site.

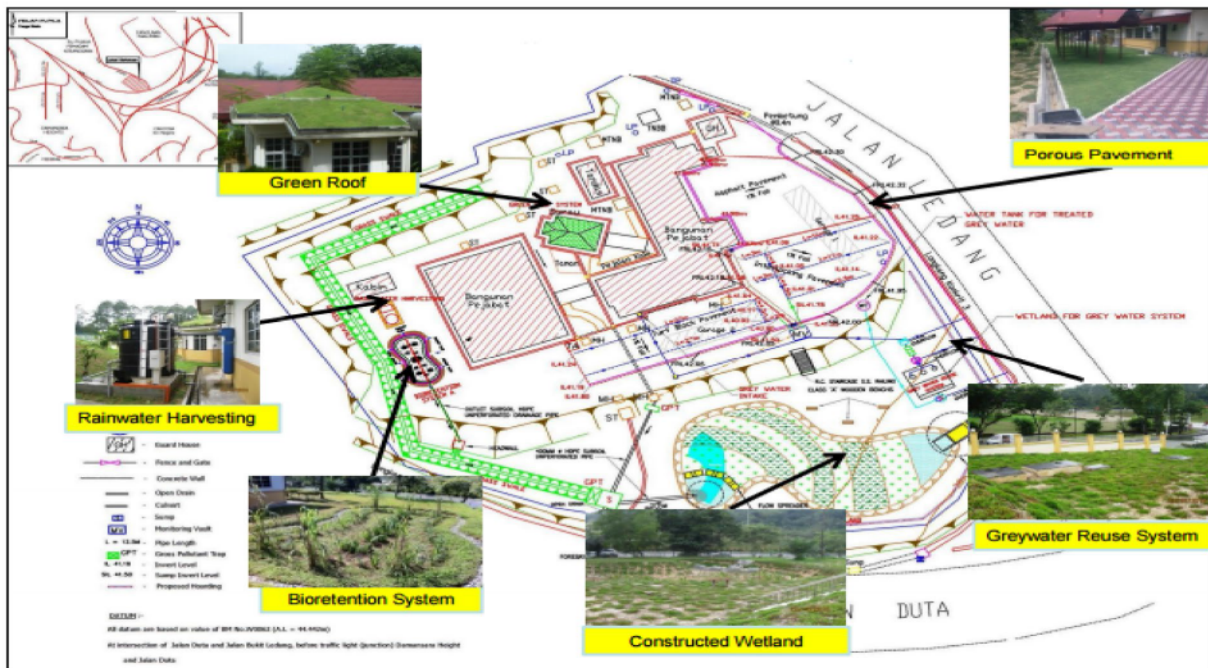

Figure 1. Layout plan of the study area at HTCKL.

Material and methods

At the HTC, Kuala Lumpur, the rainwater harvesting system has been constructed by two part includes “collection of rainwater” and “treatment of harvested rainwater”. Collection system has two “collection tanks” and one “equalization tank” and the first flush separator. The treatment method consists of a series of treatment systems which includes filtration, reverse osmosis (RO) system, and RO storage tank. The quality of harvested rainwater will then be analyzed and compared with National Drinking Water Quality Standards of Malaysia.

Indoor temperature of the green roof building in HTC is monitored and comparison of mean temperature recorded before and after installation of green roof is investigated in order to figure out the fluctuation of temperature between the phases. The MSMA study was organized in two phases, namely phase 1 and phase 2. The part of this study was performed at phase 2. Figure 2 shows the layout plan of the study area including other four components with rainwater harvesting system and green roof system. This study will highlight the water quality performance analysis of green roof harvesting rainwater and compare with the NWQS and WQI to meet as a potable use of rainwater.

Green roof design criteria and installation

As green roof technology is not commonly practiced in Malaysia, so HTC placed a small-scale project to promote people to esthetically accept this technology. Table 1 shows the summary of design criteria of green roofs in different phases, where this specific study was performed in phase 2, which starts from March 2012 and still going on. The shaded area represents this study section.

There is an additional layer of geo-textiles inserted in phase 2 between drainage and waterproofing membrane. The cross section of green roof was constructed in six layers, above which planted.

Sample and data collection

To monitor water quality, samples were taken:

- continuous sensors; and
- collection of discrete samples – this is usually undertaken by automatic samplers during rain events, but occasional grab samples also be collected for base flow, as well as during rain events to verify samples collected by automatic samplers.

Temperature measurement

A thermometer was attached to the inner wall of the green roof building to monitor the thermal performance of green roof. Temperature recorded at every 15 min and compared with the maximum mean temperature recorded prior and after the installation of green roof. In HTC, temperature data were recorded since December 2009, when it was a tiled roof building. The existing tiled roof building was replaced by the vegetated green roof since May 2010.

Water quality analysis

The Department of Environment (DOE) has been provided the water quality standards, NWQS and WQI, which is the most commonly, practiced water quality standards in Malaysia. According to NWQS, there are six classes of water quality (I, IIA, IIB, III, IV, and V) and

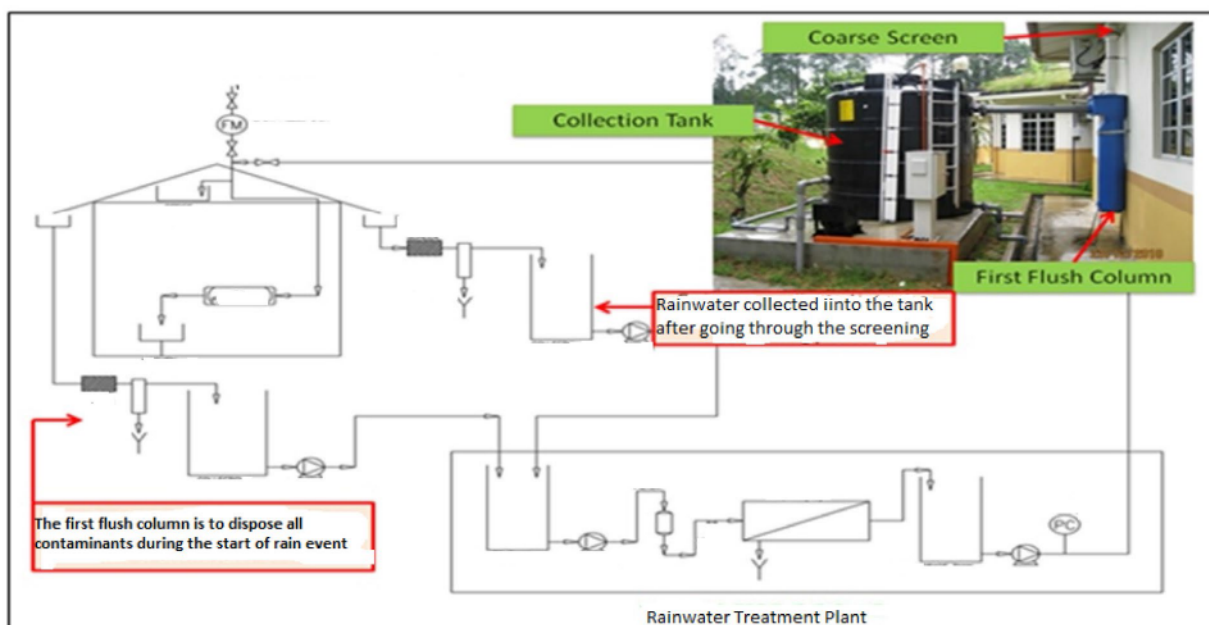

Figure 2. Rainwater harvesting system at Humid Tropic Centre (MSMA report).

Table 1. Summary of design criteria of green roof in different phases.

| Design criteria | Phase 1: Approach 1 (October 2010–February 2011) | Phase 1: Approach 2 (March 2011–February 2012) | Phase 2: (February 2012 to present) |
|-------------------------|--|--|--|
| Vegetation | (i) <i>Plylathus</i> (flowering) (ii) <i>Luphea</i> (non-flowering) | <i>Axonopus Compressus</i> (Carpet grass) | <i>Zoysia Japonica</i> (Japan grass) |
| Planting method | Vegetation is planted in a sewed geo-textile bag | Vegetation is planted above layer of geo-textile | Vegetation is planted above layer of geo-textile |
| Growth media | Engineered soil (depth of 100 mm) | Engineered soil (depth of 100 mm) | Engineered soil with correct composition of mixture of mineral soil and organic soil (around 20% of organic content) |
| Filter fabric | Geo-textile TS20 | Geo-textile TS20 | Geo-textile TS500 |
| Drainage layer | 50 mm thick of HDPE drainage cell | 50 mm thick of HDPE drainage cell | 50-mm thick HDPE drainage cell |
| Water proofing membrane | 4 mm thick of HDPE water proofing membrane | 4 mm thick of HDPE water proofing membrane | 4-mm thick HDPE water proofing membrane |
| Irrigation system | Drip irrigation | Drip irrigation | Sprinkler irrigation |

this classification is based on a descending order of its best quality to the worst quality.

Methods of ANFIS model analysis

Adaptive neuro-fuzzy application

This study analyzed an influence of the pH value on rain-water quality parameter. Nonlinear process analyzing for pH could be very challenging and lengthy procedure, as it is very uncertain. So, the most preferable technique is soft computing system. This effort is done to estimate the effects of the pH value on rainwater quality parameter by soft computing technology like adaptive neuro-fuzzy inference system (ANFIS). As the input parameter, pH value is tracked.

To originate the stipulated input/output pairs, an arrangement of fuzzy “IF-THEN” rules applied with a suitable enrollment function. The fuzzy “IF-THEN” rule creates on the basis of the ANFIS. In this study, the first-arrange Sugeno fuzzy model was utilized as a part of the ANFIS framework that is practically proportional to the system. A typical guideline set with a fuzzy “IF-THEN” administer can be communicated as,

$$\text{if } x \text{ is } A \text{ then } f_1 = p_1x + t \tag{1}$$

There are three inputs $x, y,$ and z as shown in Figure 3 of the ANFIS architecture. The same layer nodes carrying

the same functions. The yield of the i th node in layer 1 is signified as $O_{1,i}$.

The layer 1 comprises input variables Membership Functions (MFs) and supplies the variable values to the following layer. Each node i is an versatile node with a node function,

$$O_{1,i} = \mu(x, y, z)_i \quad \text{for } i = 1, 2 \tag{2}$$

where $x, y =$ input variable to the i th node; $\mu(x, y, z)_i =$ Membership Functions for the node i .

The MFs can be described by bell-shaped function,

$$f(x;a, b, c) = \frac{1}{1 + \left(\frac{x-c}{a}\right)^{2b}} \tag{3}$$

where $\{a, b, c\}$ representing one set of three parameters.

The second layer (enrollment layer) receives and duplicates approaching signs from the first layer and sends the item out. Every hub yield speaks to the terminating quality of a tenant or weight, that is,

$$o_{2,i} = w_i = \mu(x)_i \cdot \mu(x)_{i+1}, \quad i = 1, 2 \tag{4}$$

The third layer (i.e., the rule layer) is non-versatile where each hub i computes the standard’s proportion terminating quality the entirety of all rules terminating qualities like

$$O_{3,i} = w_i^* = \frac{w_i}{w_1 + w_2}, \quad i = 1, 2 \tag{5}$$

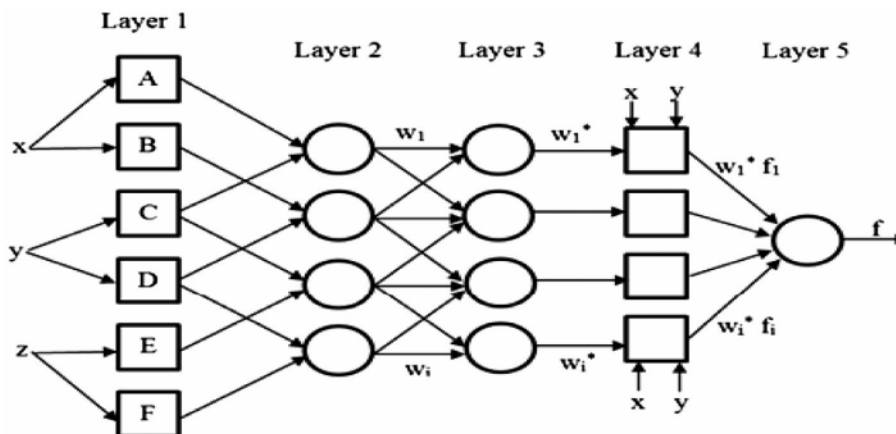

Figure 3. ANFIS structure with two inputs, one output and two rules.

The outputs of this layer are called standardized terminating strengths or standardized weights.

The fourth layer is known the de-fuzzification layer which provides yield qualities coming out because of the derivation of principles, where each node i is a versatile node with node function,

$$O_{4,i} = w_i^* \cdot f_i = w_i^*(p_i x + q_i y + r_i) \tag{6}$$

where $\{p_i, q_i, r_i\}$ are consequent parameters.

All the inputs come from the fourth layer are compiled at the fifth layer and converted the fuzzy classification results into a crisp output. The fifth layer node creates the final output and it is not adaptive but computes the overall output of all incoming signals.

$$O_{5,i} = \sum_i w_i^* \cdot f_i = \frac{\sum_i w_i \cdot f_i}{\sum_i w_i} \tag{7}$$

Appraisalment of model performances

To analyze the execution of the ANFIS model and estimation values, the accompanying measurement makers were chosen:

- (1) Root-mean-square error (RMSE)

$$RMSE = \sqrt{\frac{\sum_{i=1}^n (O_i - P_i)^2}{n}} \tag{8}$$

- (2) Co-efficient of determination (R^2)

$$R^2 = \frac{\left[\sum_{i=1}^n (O_i - \bar{O}_i) \cdot (P_i - \bar{P}_i) \right]^2}{\sum_{i=1}^n (O_i - \bar{O}_i)^2 \cdot \sum_{i=1}^n (P_i - \bar{P}_i)^2} \tag{9}$$

where O_i = ANFIS value, P_i = measurement values, and n = the sum of test data.

Results and discussion

Each sample analyzed and compared with NWQS and Dissolved Oxygen (DO) & pH analyzed with WQI also. Only summarized data are presented in Table 2. Some of the randomly selected values of each sampling date were taken for analysis. As observed in Table 2, the values for electric conductivity, pH, and temperature are within Class I and only the value of DO found Class III for both NWQS and WQI. So, this water required extensive treatment for potable uses and can be used for livestock drinking and fishery uses.

Table 2. Comparison of water quality with NWQS and WQI for sample collected on January 2013.

| Parameter | Outlet (average value) | NWQS | WQI |
|-----------------------|------------------------|-----------|-----------|
| Conductivity | 103.3 (µS/cm) | Class I | - |
| Dissolved Oxygen (DO) | 3.7 (mg/l) | Class III | Class III |
| pH | 7.5 | Class I | Class I |
| Temperature | 26.4 °C | Class IIA | - |

Table 3. Comparison of water quality with NWQS and WQI for sample collected on January 2014.

| Parameter | Outlet (average value) | NWQS | WQI |
|-----------------------|------------------------|-----------|----------|
| Conductivity | 100.3 (µS/cm) | Class I | - |
| Dissolved Oxygen (DO) | 5.2 (mg/l) | Class IIA | Class II |
| pH | 6.4 | Class IIA | Class II |
| Temperature | 26.8 | Class I | - |

Table 4. Measurable parameters for data-sets.

| Variable | Statistical parameters | | | |
|-----------------------------|------------------------|-----------|---------|--------------------|
| | Min | Max | Mean | Standard deviation |
| pH value | 4.767 | 8.918 | 7.155 | .893 |
| Rainwater quality parameter | Class III | Class IIB | Class I | 0 |

Table 3 shows a good quality of water, to use in conventional water supply system; some conventional treatment is required but sensitive for aquatic species.

As observed in Tables 2 and 3, the maximum outlet samples from green roofs are found within class I and class II of NWQS and WQI except DO. The samples were collected from 1 January 2013 to 5 April 2014. Most of time, the concentration of DO concentrations was found in a very poor level of Class III, while twice found of class IV at dated sample of February and April 2013. Table 3 presents the better quality of water among all collected samples, found all parameters including DO within Class I and Class II for the samples collected on January, February, and March 2014. In April 2014, Table 4 presents unsatisfactory in terms of pH value of Class III.

Critical analysis of pH value

The statistical average range of pH of rainwater in Malaysia is 4.51–5.6, which shows that there is no serious acid rain problem in Malaysia (Seong and Sapari). Figure 4 represents the variation of pH value for the outflow collected in the collection tank during different specific storm events. The average pH is around 8.0 on 25 June 2013, which represent alkalinity of runoff water.

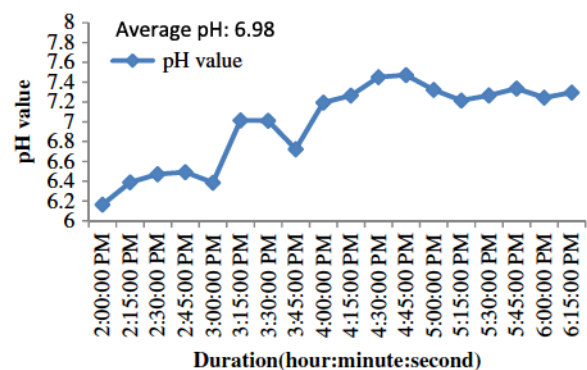

Figure 4. Variation in pH value during a storm event on 7 March 2014.

These diagrams portray a comparable pattern that the pH estimation of the water gathered in the accumulation tank has been increasing as the runoff from the green rooftop system conveyed into the accumulation tank during the specific storm event. These perceptions may draw out a critical message that the green rooftop system in HTC has been acting as a buffer zone to build the alkalinity of the overflow which it created. Figured out in Germany that the pH value for runoff delivered from substrates of green roof was up to 7.5 as the middle pH for precipitation was only 6.2 and for overflow created from conventional roof pH of 4.6 was recorded. Teemusk and Mander (2007) estimated and compared runoff from a green roof and a modified bituminous roof in Estonia that the pH in the green rooftops runoff ascended by a few units compared with the rainwater, i.e., from 5.2–5.6 to 7.2–8.3. In case of moderate runoff, the pH value of outflow water reached to the same high level. They highlighted the cause of increasing pH is the carbonate content of the substrate layer of green roofs. In Toronto, (Van Seters, Rocha, Smith, & MacMillan, 2009) found that the pH value of the runoff samples from an extensive type green roof is lower than any other conventional roofs. He found the average value of pH is 8.1, which is very near to the analyzed average pH value at HTC, Kuala Lumpur.

The average pH is founded 6.983 dated on 7 March 2014 which also represents the alkalinity of runoff water. Thus, they inferred that the green roof substrates were the contributor for the ascent of pH in the runoff. Since substrates for the considered green roofs consisted prepared planting soil which may contain extent of essential constituents, so it is coherent that the overflow created from the system is toward basic.

Figure 5 shows the relationship between the pH variation and the variation flow rate during a specific rainfall

event. As the time going on after the rain started, the value of pH is directly proportional to the runoff flow rate. When the flow rate reached to the peak discharge level, the pH value also reached to the peak nearly at the same time.

Application of adaptive neuro-fuzzy methodology on the pH value of green roof harvested rainwater

Input variables

The statistical parameters of pH value and rainwater quality parameter given by NWQS for data-sets are estimated and given in Tables 4.

ANFIS model analysis

Toward the starting, the ANFIS system was prepared with measured information by above introduced trail strategy. Three nine-formed enrollment functions were utilized to fuzzify the ANFIS input. When the training process was complete, the ANFIS networks were tested to determine the rainwater quality parameter. The experimental data of NWQS rainwater quality parameter and anticipated qualities utilizing ANFIS model are shown in Figure 6. As can be seen in Figure 6, R^2 correlation coefficient is very high. Therefore, ANFIS has good correlation with the training data. The proposed ANFIS model can also play essential role in the agricultural production, irrigation management, and water resources allocation (Figure 7).

The execution of ANFIS model that assessed rainwater quality parameter was evaluated according to statistical criteria such as RMSE and coefficient of determination R^2 . This confirms the RMSE statistics evaluated in Table 5. It should be concluded that the proposed

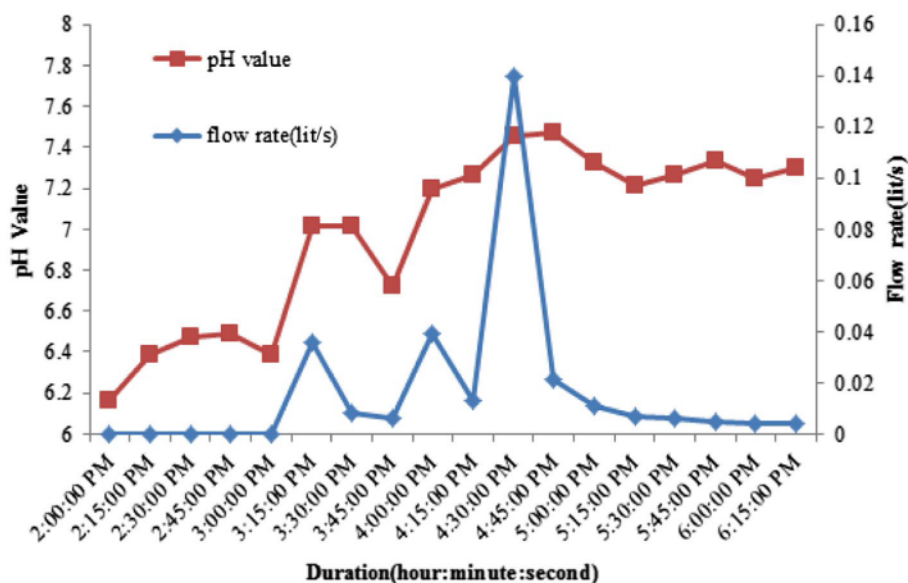

Figure 5. Relationship in between pH value and outflow rate during a rainfall event on 7 March 2014.

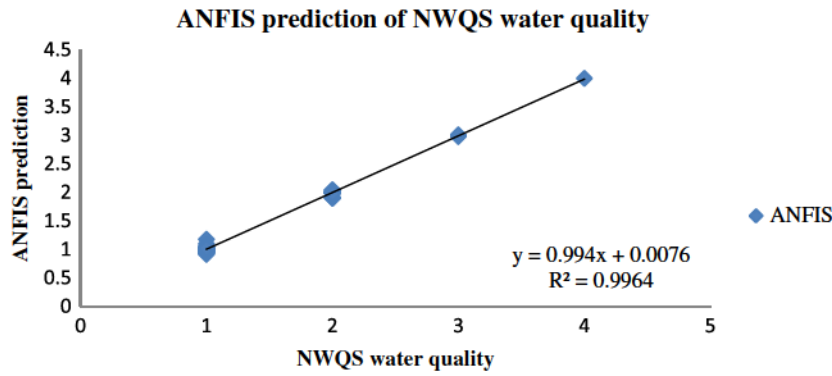

Figure 6. Scatter plots of predicted values of rainwater quality parameters using ANFIS model.

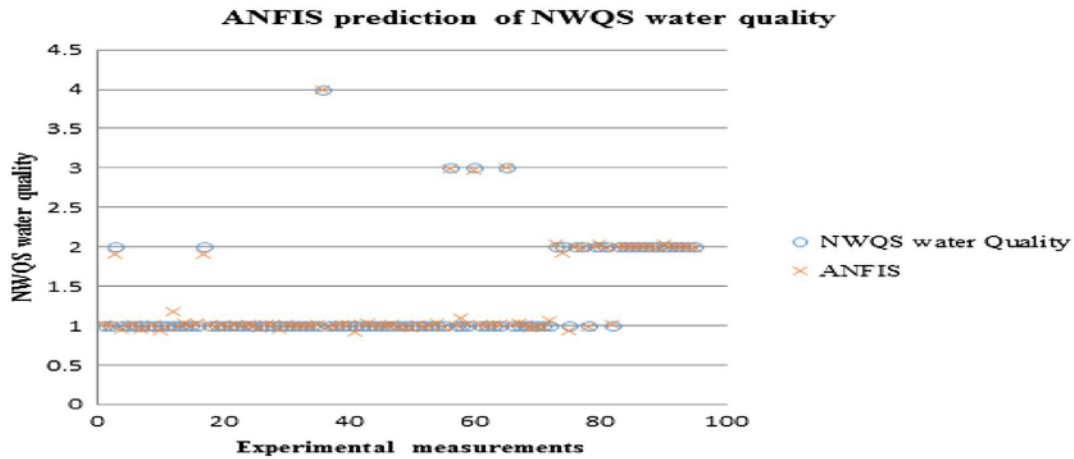

Figure 7. ANFIS forecasting of wind rainwater quality parameter.

Table 5. Performance insights of the ANFIS model in wind turbine rotational velocity estimation.

| | RMSE | R ² |
|-----------------------------------|---------|----------------|
| Wind speed 4.63 m/s; without PAGV | .035237 | .9964 |

ANFIS model can be used for forecasting rainwater quality parameter with high reliability.

Sedimentation tank and filter bed design

To improve the quality of harvested rainwater from green roofs, initial sedimentation of collected rainwater followed by a filtration procedure is described below. The average flow rate of rainwater through the green roof system was found .015352 L/s, which is the average value of flow rate for the total flow during the study period.

- Sedimentation tank design:**
 Sometimes, the rainfall intensity in Malaysia is very high.
 Let us consider,
 The maximum flow rate $Q = 2 \text{ m}^3/\text{day}$
 The detention time = 3 h
 So, the volume of tank = .25 m^3
 Let, the depth of tank = .2 m
 Length $L = 2 W$ (Width)

Surface area $A = \frac{.25}{.2} = 1.25 \text{ m}^2$
 Length $L = 2.2 \text{ m}$ and Width = 1.1 m.

- Filtration tank design:**
 Total filtered water, $Q = 2 \text{ m}^3/\text{day} = .0833 \text{ m}^3/\text{h}$
 In general, rapid sand filters use sand with an effective size of .2-.45 mm.
 Maximum uniformity co-efficient,
 $UC = \frac{D_{60}}{D_{10}} = 2.25$
 Let, the rate of filtration, $V = .1 \text{ m}/\text{h}$ and total head loss, $\Delta H = 1 \text{ m}$.
 However, the area of filter, $A = \frac{Q}{V} = .83 \text{ m}^2$
 Length = 1.8 m and Width $B = .9 \text{ m}$
 However, the depth of sand
 $h_s = 2.25 \times .45 = 1.01 \approx 1 \text{ m}$
 The depth of gravel $h_g = 2.25 \times .20 = .45 \text{ m}$

Indoor temperature analysis

Investigation for most extreme temperature recorded in January and February has been done and the analyzed result is shown in Table 6. It is seen that there is a decrease in mean temperature in both months of January and February recorded after establishment of green roof. Table 6 shows that the green roof in HTC has a significant role in reducing indoor temperature and in

Table 6. Comparison of mean indoor temperature recorded before (2010) and after installation of green roof.

| | Mean temperature (°C) | Mean temperature (°C) | Year | Reduction (°C) |
|----------|-----------------------|-----------------------|------|----------------|
| | Before (2010) | After | | |
| January | 30.3 | 26.87 | 2014 | 3.43 |
| | | 26.452 | 2013 | 3.848 |
| | | 28.70 | 2012 | 1.6 |
| February | 32.2 | 26.634 | 2014 | 5.566 |
| | | 26.50 | 2013 | 5.7 |
| | | 30.70 | 2012 | 1.5 |

reducing the Urban Heat island (UHI) Effect. After the installation of green roof system, temperature reduced significantly in 2012, 2013, and 2014. This reducing of UHI is occurring through the evapotranspiration of the green roof. Heat won't be completely consumed by the green roof building since it is consumed by the vegetation to do photosynthesis, consequently diminishing the measure of heat picked up by the building and this may prompt cooler indoor temperature.

In Taiwan, reported that a green roof can reduce the ambient air temperature by 1.2, .5, and .3 °C during summer, spring, and winter, respectively. Green roof yields more huge thermal changes when atmospheric temperatures increases.

In another study on central zone of Taiwan, (Liang & Huang, 2011) observed a huge difference in surface temperature of 31.9 °C in between bare roof surface and green roof surface. Figure 8 represents the variation in maximum temperature recorded from January to April in between 2013 and 2014.

Figure 9 represents the difference in mean temperature in between 2013 and 2014. It is obviously noticeable that the mean temperature of the year 2014 is higher than that of 2014. This is because of the age of green roof. Initially, green roof was retrofitted at 2010. The green roof reduced maximum temperature at 2013, which is already presented in Table 6. In 2012 and 2013, it was the growing stage of green plants and in 2014. Plants became aged and less effective to perform as a heat absorbent. The performance of green roof runoff quality from this study under the tropical climate has similarity with other studies all over the world in hot or

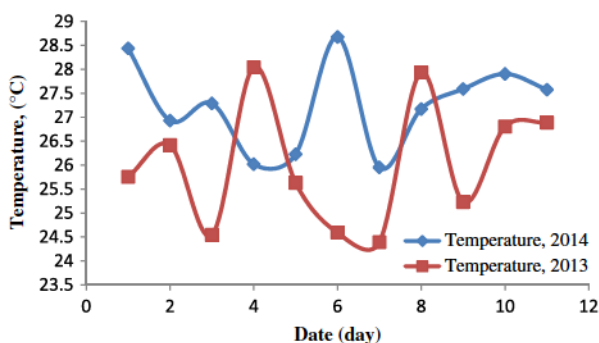

Figure 8. Variation in temperature for month of January to April in between 2013 and 2014.

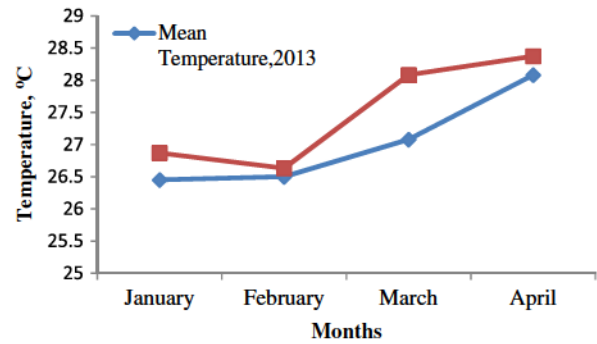

Figure 9. Variation in Mean temperature in between 2013 and 2014 in the month of January to April.

cold climate. With respect to the pH value of rainwater, the green roof substrate layer helps in improving the acidity of rainwater and reached to the standards given by the DOE in Malaysia. The DO concentrations can be consider as a medium quality as it was initially found an average of 3.25 mg/l during 2013 and increased up to an average 5.065 mg/l during 2014. Moreover, DO concentrations have been reached to the level of Class I (greater than 7 mg/l) according to both NWQS and WQI while it was tested in the laboratory of HTC. The value of electric conductivity has always the positive effects same as other studies. In two different studies on planted roofs in Singapore like under the tropical climate, (Hien, Yok, & Yu, 2007; Wong, Chen, Ong, & Sia, 2003) conducted that the surface temperature decreased by 18 and 30 °C with respect to the air temperature at the study site. The heat absorption was reduced by around 60% by the extensive type of planted roofs (Hien et al., 2007).

Conclusions

The study was set out to explore the green roof performance on the basis of the quality parameters of harvested rainwater in a tropical climatic condition. At HTC, pH value always found of Class I according to NWQS and WQI. The average pH of 7.99 and 6.98 was found during a storm event of 2013 and 2014, respectively, which is proved that the collected rainwater from green roof is basic and good in quality for potable use. A sedimentation tank having volume of 2.2 m × 1.1 m × .2 m has been recommended for settling of collected rainwater. Moreover, a filtration tank having 1-m sand media depth and .45 m of gravel media depth recommended to improve the water quality. The exactness of versatile neuro-fuzzy strategy in estimation of rainwater quality parameter was investigated in this study. The study demonstrated that modeling of rainwater quality parameter is conceivable through the utilization of the ANFIS method. At HTC, after installation of green roof system, it has been reduce mean temperature prior to before installation. Maximum reduction was found in the year of 2013 and the mean temperature of the year of 2014 was found higher than that of 2013. Overall, it is safe to

conclude that the harvested rainwater from green roof has a good quality to use as water supply. Additionally, reverse osmosis system should be installed if the collected rainwater stored for drinking water purpose.

Disclosure statement

No potential conflict of interest was reported by the authors.

References

- Castleton, H., Stovin, V., Beck, S., & Davison, J. (2010). Green roofs; building energy savings and the potential for retrofit. *Energy and Buildings*, 42, 1582–1591.
- Chang, M., McBroom, M. W., & Scott Beasley, R. (2004). Roofing as a source of nonpoint water pollution. *Journal of Environmental Management*, 73, 307–315.
- Förster, J. (1999). Variability of roof runoff quality. *Water Science and Technology*, 39, 137–144.
- Hien, W. N., Yok, T. P., & Yu, C. (2007). Study of thermal performance of extensive rooftop greenery systems in the tropical climate. *Building and Environment*, 42, 25–54.
- Getter, K. L., Rowe, D. B., & Andresen, J. A. (2007). Quantifying the effect of slope on extensive green roof stormwater retention. *Ecological Engineering*, 31, 225–231.
- Gonçalves, F., Andrade, M., Forti, M., Astolfo, R., Ramos, M., Massambani, O., & Melfi, A. (2003). Preliminary estimation of the rainfall chemical composition evaluated through the scavenging modeling for north-eastern Amazonian region (Amapa State, Brazil). *Environmental Pollution*, 121, 63–73.
- Lee, G., & Jones, R. (1982). *Quality of the St Thomas, US Virgin Islands household cistern water supplies*. Paper presented at the Proceedings of an International Conference on Rainwater Cistern Systems, University of Hawaii at Manoa, Honolulu, USA.
- Lee, J. Y., Yang, J.-S., Han, M., & Choi, J. (2010). Comparison of the microbiological and chemical characterization of harvested rainwater and reservoir water as alternative water resources. *Science of the Total Environment*, 408, 896–905.
- Liang, H.-H., & Huang, K.-T. (2011). Study on rooftop outdoor thermal environment and slab insulation performance of grass planted roof. *International Journal of Physical Sciences*, 6, 65–73.
- Lye, D. J. (2009). Rooftop runoff as a source of contamination: A review. *Science of the Total Environment*, 407, 5429–5434.
- McConney, P., Nurse, L., & James, P. (2009). *Impacts of climate change on small-scale fisheries in the eastern Caribbean: A final report to IUCN*. Centre for Resource Management and Environmental Studies (CERMES) University of the West Indies, Faculty of Pure and Applied Sciences, Cave Hill Campus, Barbados.
- Mentens, J., Raes, D., & Hermy, M. (2003). Effect of orientation on the water balance of greenroofs. *Greening Rooftops for Sustainable Communities*, 1, 363–371.
- Rahman, S., Khan, M., Akib, S., Din, N. B. C., Biswas, S., & Shirazi, S. (2014). Sustainability of rainwater harvesting system in terms of water quality. *The Scientific World Journal*, 2014, 1–11.
- Sheng, L. X., Mari, T. S., Ariffin, A. R. M., & Hussein, H. (2011). Integrated sustainable roof design. *Procedia Engineering*, 21, 846–852.
- Smet, J., & Moriarty, P. (2001). *DGIS policy support paper: Rooftop rainwater harvesting*. IRC. Delft: The Netherlands.
- Sultana, N., Akib, S., Aqeel Ashraf, M., & Roseli Zainal Abidin, M. (2015). Quality assessment of harvested rainwater from green roofs under tropical climate. *Desalination and Water Treatment*, 57, 75–82.
- Teemusk, A., & Mander, Ü. (2007). Rainwater runoff quantity and quality performance from a greenroof: The effects of short-term events. *Ecological Engineering*, 30, 271–277.
- Van Seters, T., Rocha, L., Smith, D., & MacMillan, G. (2009). Evaluation of green roofs for runoff retention, runoff quality, and leachability. *Water Quality Research Journal of Canada*, 44, 33–47.
- Wong, N. H., Chen, Y., Ong, C. L., & Sia, A. (2003). Investigation of thermal benefits of rooftop garden in the tropical environment. *Building and Environment*, 38, 261–270.