



www.itcon.org - Journal of Information Technology in Construction - ISSN 1874-4753

IMPROVING PERFORMANCE AND THE RELIABILITY OF OFF-SITE PRE-CAST CONCRETE PRODUCTION OPERATIONS USING SIMULATION OPTIMISATION

PUBLISHED: July 2010 at <http://www.itcon.org/2010/25>

EDITOR: Kirti Ruikar

Ammar Frederick Al-Bazi, Ph.D. Student

*Centre for Construction Innovation Research (CCIR), School of Science and Technology (SST),
University of Teesside, Middlesbrough, TS1 3BA, UK,
a.f.albazi@tees.ac.uk and <http://tees.academia.edu/AmmarAlBazi>*

Nashwan Dawood, Professor

*Centre for Construction Innovation Research (CCIR), School of Science and Technology (SST),
University of Teesside, Middlesbrough, TS1 3BA, UK,
n.n.dawood@tees.ac.uk and <http://tees.academia.edu/NashwanDawood>*

Dr John T Dean

*Centre for Construction Innovation Research (CCIR), School of Science and Technology (SST),
University of Teesside, Middlesbrough, TS1 3BA, UK,
j.dean@tees.ac.uk*

SUMMARY: *The increased use of precast components in building and heavy civil engineering projects has led to the introduction of innovative management and scheduling systems to meet the demand for increased reliability, efficiency and cost reduction. The aim of this study is to develop an innovative crew allocation system that can efficiently allocate crews of workers to labour-intensive repetitive processes. The objective is to improve off-site pre-cast production operations using Multi-Layered Genetic Algorithms. The Multi-Layered concept emerged in response to the modelling requirements of different sets of labour inputs. As part of the techniques used in developing the Crew Allocation "SIM_Crew" System, a process mapping methodology is used to model the processes of precast concrete operations and to provide the framework and input required for simulation. Process simulation is then used to model and imitate all production processes, and Genetic Algorithms are embedded within the simulation model to provide a rapid and intelligent search. A Multi-Layered chromosome is used to store different sets of inputs such as crews working on different shifts and process priorities. A 'Class Interval' selection strategy is developed to improve the chance of selecting the most promising chromosomes for further investigation. Multi-Layered Dynamic crossover and mutation operators are developed to increase the randomness of the searching mechanism for solutions in the solution space. The results illustrate that adopting different combinations of crews of workers has a substantial impact on the labour allocation cost and this should lead to increased efficiency and lower production cost. In addition, the results of the simulation show that minimum throughput time, minimum process-waiting time and optimal resource utilisation profiles can be achieved when compared to a real-life case study.*

KEYWORDS: *Construction Supply Chain, Multi-Layered Genetic Algorithms, Simulation Modelling, Crew Allocation System, Precast Industry.*

REFERENCE: *Al-Bazi A F, Dawood N, Dean J T (2010) Improving performance and the reliability of off-site pre-cast concrete production operations using simulation optimisation, Journal of Information Technology in Construction (ITcon), Vol. 15, pg. 335-356, <http://www.itcon.org/2010/25>*

COPYRIGHT: © 2010 The authors. This is an open access article distributed under the terms of the Creative Commons Attribution 3.0 unported (<http://creativecommons.org/licenses/by/3.0/>), which permits unrestricted use, distribution, and reproduction in any medium, provided the original work is properly cited.



1. INTRODUCTION

The off-site precast industry is one of the main components of the construction supply chain. It is a network of multiple activities and its performance is dependent on comprehensive information flows between clients, architects/engineers, general contractors, subcontractors, suppliers and consultants, as well as the physical flow of materials, services and products. The off-site precast industry is one of the largest and most important activities in the construction process. It has existed for over 150 years and has dramatically contributed to cost reduction in the construction site labour force, which in turn reduces construction site costs, construction time and therefore improves construction performance (Chen et al 2009).

As a component of the construction supply chain, the precast concrete industry contributes to improving the supply chain and there is a high demand for the skilled and semi-skilled workforce it requires (Goodier and 2006). A system to support the efficient allocation of this labour force will therefore support improvements in the overall construction supply chain.

Precast concrete components are used in a wide range of buildings and heavy civil engineering projects and have been singled out as a means to improve the productivity of the construction industry (Chuan and Pheng 2001). Any delay in delivering precast concrete components to a construction site will delay the construction processes and increase costs.

Precast components are usually manufactured using different processes in a job-shop environment. Each process involves a number of workers (a crew) in order to carry out the jobs required by that process. These workers are highly skilled so any inefficient use of them may lead to an increase in labour costs.

In this system, process simulation and artificial intelligent technologies are integrated to produce a sophisticated hybrid crew allocation system. This hybrid system was developed after reviewing related literature and identifying gaps in current knowledge.

An appropriate and intelligent decision support system for labour allocation is a necessity in labour intensive industries such as the precast industry, which requires a high number of expensive skilled workers, and inefficient labour allocation has the potential to increase production costs. A Simulation-based Genetic Algorithm model seems to be a highly visible and economically significant tool to solve such a problem. It is hypothesised in this research that the use of the Genetic Algorithms (GAs) and simulation can assist production planners to identify the best crew allocation plans in order to minimise cost, optimise worker utilisation, enabling minimum process time and minimum waiting time to be achieved. As a result, this study presents an innovative crew allocation system dubbed 'SIM_Crew', which has been developed to support the efficient allocation of crews of workers to labour-driven processes in the precast concrete industry.

A sleeper precast manufacturing system is considered as a case study to test the tools of Multi-Layered GAs. A proper allocation system will thus ensure minimum throughput time, minimise allocation cost and process-waiting time and potentially achieve optimal resource utilisation. A sleeper is a rectangle-precast component for use as a base for railway tracks. Sleeper components are generally laid transverse to the rails, on which rails are supported and fixed, to transfer the loads from rails to the ballast and sub grade below, and to hold the rails at the correct gauge.

Following this first introductory section, the remainder of this paper is organised into a further seven sections. In the next section, the research problem is addressed. Section three presents the background to crew allocation techniques. In section four, the architecture of the crew allocation system is introduced as well as the system module development. The process map methodology, simulation and optimisation modelling are explained in section five. Section six demonstrates a case study followed by experimental work, results analysis, interpretation and a comparison study are demonstrated. In section seven, the benefits of the proposed crew allocation system in the precast industry are illustrated. Finally, section eight presents the conclusions and a discussion of future work.

2. PROBLEM STATEMENT

Any delay in delivering precast components to construction sites can cause a disturbance in the overall construction supply chain (Pheng and Chuan 2000). In the precast manufacturing system, a system of crew allocation is required to decide when and where each 'crew member' should be, allocated according to the skills and qualification required for completing a given process. Each crew has a collection of workers: each worker,

depending on his/her skills is able to accomplish the required job at a different level of productivity or process time. The skills required to carry out a process must be possessed by the members of the crew who are allocated to conduct that process. The crew allocation issue can be the main reason for delays in the supply of precast components to the construction industry.

A crew allocation problem appears when the formation of any crew involves shared workers working on simultaneous similar/different processes. This type of labour sharing can cause process-waiting time, labourer idle times, low resource utilisation, a disturbed workflow and subsequently high allocation costs. Since a parallel or sequential similar/different processes structure of a manufacturing system is pre-specified, the involvement of shared workers can be required in one or more processes. This type of problem becomes more important when there is a significant allocation cost. This is caused by shared workers being allocated to more than one process and being required at different times, dictated by the sequence requirements of similar labour-intensive operations. In order to optimise resource utilisation and minimise labour allocation cost, an optimal crew allocation plan is required in any labour-intensive facility. An appropriate crew allocation plan, which has to be selected from other plans, satisfies minimum allocation cost. Each production process has a minimum requirement for skilled workers and the availability of such a resource can ensure the processing of jobs within production processes. The labour requirement for each process can be satisfied by a number of crew alternatives available to each process. Each process has a predetermined pool of crews that can possibly perform the operations in each of the parallel processes. These crew alternatives have different formations with a certain process time in which a different number of charge-hand workers and operators are involved in each formation. The sharing of available labourers in different crews may cause delays. Parallel-Repetitive Similar Processing is a realistic example of a resource sharing case. All production processes in such a layout have a similar sequence and similar parallel repetitive processes, in order to produce the same or different products in a short cycle time, to process the same materials. This type of production layout can be seen in a job-shop environment existing in the precast concrete industry; see fig. 1 for a diagram of the crew allocation problem.

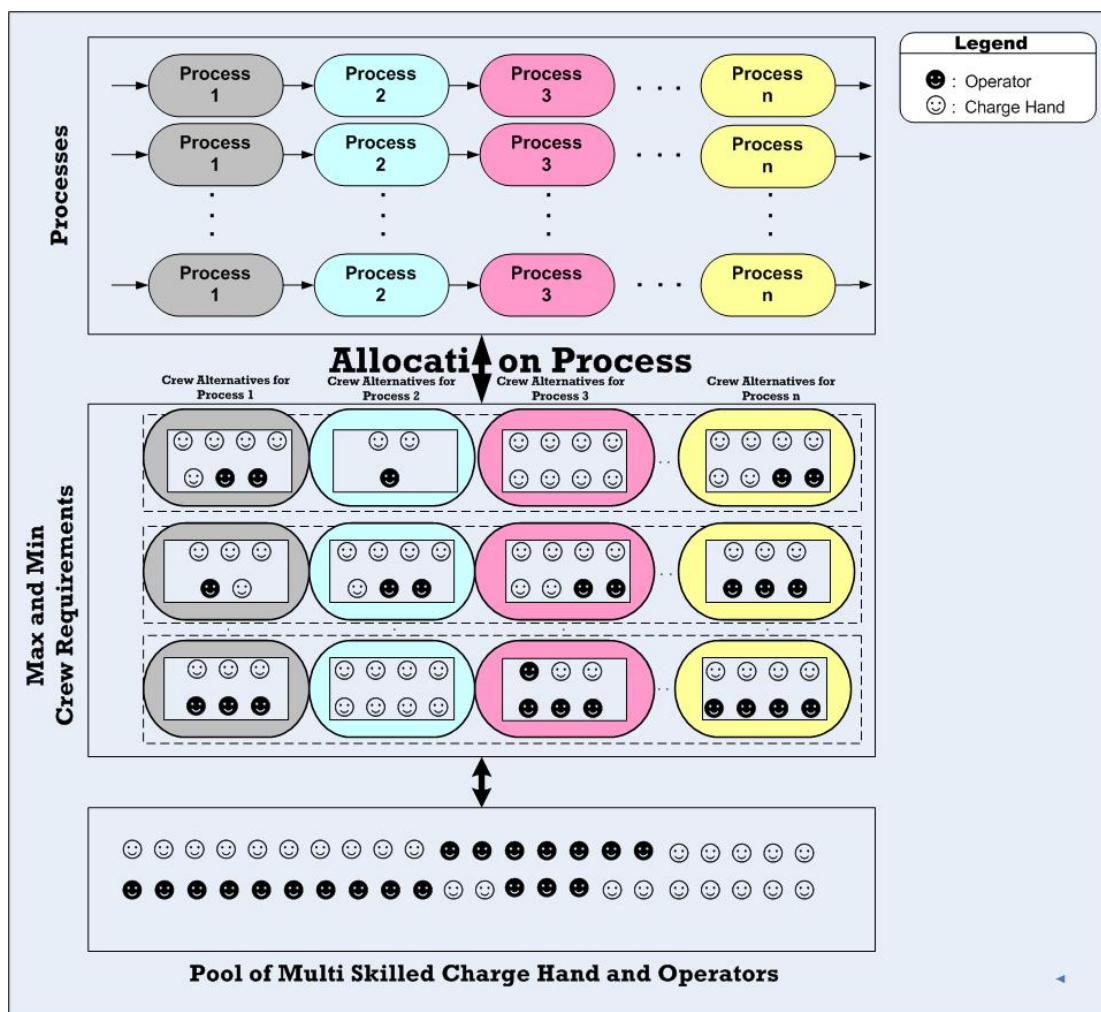

FIG. 1: Schematic diagram for the crew allocation problem in the repetitive similar processes

In figure 1, the allocation process for a particular process starts with identifying the minimum requirement for labourers (different skilled workers). A number of crew alternatives are available for the process that can satisfy the minimum labour requirement and can provide more than the required output, in terms of providing different types of and larger numbers of skilled workers. After selecting the crew of workers, the crew formation (crew members) is recalled from a pool of workers. Delays occur when the worker being deployed is required for more than one process, in which the status of the utilised worker in the pool is addressed as 'an engaged' worker. The 'idle' status of the worker can be obtained after releasing him/her from the assigned job, back into the pool and hence the worker can be allocated to other processes.

In order to identify the optimal crew allocation plan in labour-driven processes with minimum allocation cost, a superior search mechanism is required to investigate possible allocation plans and identify the most promising solution. During the investigation process, an objective function is needed to decide the best outcome of allocation plans.

3. CREW ALLOCATION APPROACHES IN PRECAST INDUSTRY

Crew allocation using simulation modelling and optimisation technology has been applied in the construction and precast industries. This research is closely aligned with scheduling resources to repetitive activities (see Senouci and Naji 2006, Selinger 1980, Hyari and El-Rayes 2006, and Srisuwanrat and Ioannou 2007). This section discusses the type of operations (parallel/series) and repeatability of operations involved which are adopted to classify the results of the literature review. In addition, developing crew allocation systems for both repetitive and non-repetitive operation layouts are discussed.

In repetitive operations, crews are often required to repeat the same work in various locations. Many available crew allocation systems for repetitive operations are addressed in the work of Nassar (2005), who presents a model that uses spreadsheet GA implementation to optimally assign resources to repetitive activities in construction projects. In addition, Ipsilandis (2006) presents a linear programming parametric model formulation for supporting the decisions of construction managers, where the multi-objective nature of decision making in repetitive construction projects is explored. In this work, a project consisting of six repetitive units each having six discrete activities repeated in each unit is considered. Lu et al (2008) present a computer system called 'simplified simulation-based scheduling (S3) to solve the problem of skilled labourer scheduling in a multi-site, using the Particle Swarm Optimiser (PSO) as a stochastic search strategy on a population of individuals, each representing a possible solution to the problem. Dawood et al (2007) developed a generic simulation model depicting the operational processes of a precast concrete production system, the results of which showed that utilising fewer skilled workers resulted in a longer lead-time and a lower production cost. In addition, utilising a greater number of skilled workers resulted in a shorter lead time and a greater production cost. The results illustrate that the number of allocated workers has an impact on both lead-time and production costs: a reduction in the number of workers will increase the lead-time and decrease the production costs and an increase in workers will have the opposite effect.

In a contrast, in non-repetitive processes or activities crews are often required to carry out different work at various locations and there are many available scheduling methods for these construction projects. The work of Li et al (1998) present a methodology for optimising labour and equipment assignment for excavation and earthwork tasks using a Genetic Algorithm in which a number of modifications of basic genetic algorithms were developed to improve the capacity of the proposed algorithms. Marzouk and Moselhi (2004) provide a multi-objective optimisation tool to optimise earthmoving operations using computer simulation and genetic algorithms. In this case, the optimisation is aimed at minimising time and cost in earthmoving operations. Moselhi and Alshibani (2007) propose a new methodology utilising combined GAs and spatial technologies for the optimisation of crew formations for earthmoving operations. The model produced by this work is useful for planning, tracking and control. Watkins et al (2007) use agent-based modelling methods simulating space congestion on a construction site to explore the impact of individual interactions on productivity and labour flow. Zhang and Li (2004) developed an optimisation methodology that integrates discrete-event simulation with an heuristic algorithm to optimise dynamic resource allocation for construction scheduling. Senouci and Adeli (2001) present an optimisation formulation for a 'project scheduling' problem, with the objective of minimising the total construction cost.

Marzouk et al (2007) present a special purpose simulation model to capture the uncertainty associated with bridge construction. Results show that increasing the number of labour crews shortens the fabrication duration. The literature discussed above presented methodologies and tools for solving crew allocation problems in both

repetitive and non-repetitive construction operations. Most of the studies focus on minimising costs, rather than considering the effects of resource utilisation on system performance. Some studies demonstrate the simulation of repetitive processes but do not account for detailed crew formation in each process. However, the previous research did not consider developing optimisation modules for a crew allocation in which only ‘what-if’ scenarios are adopted in the development of simulation models. In addition, available performance keys such as cost and utilisation are not calculated and therefore the effects on the system performance are not illustrated.

In conclusion, previously developed crew allocation systems for the construction and precast industries are incapable of determining the utilisation of each individual worker, as they have only been able to produce the average utilisation of a crew rather than considering the different skills of workers available in each crew. A few studies demonstrate the simulation of repetitive processes, but detailed crew formation and its utilisation in each process, have not been taken into account. The system proposed in this research considers worker utilisation and process-waiting time factors to be influential factors that affect labour allocation cost. However, multi-layer formation was considered in previous studies, which focused on the decomposition of problems into a number of sub-problems: each sub-problem being stored in a layer; the purpose of such decomposition being to facilitate the solution of complex problems. In this study, the multi-layer concept is different to previous or parallel efforts, since it uses a multi-layered chromosome storing different sets of input variables.

In addition, there is a requirement for advanced systems that can address the utilisation of workers and its relationship to process-waiting time to identify the combined impact on allocation cost. The approach in this research has been designed to be flexible in terms of its applicability in solving crew allocation problems, and is applicable to any highly repetitive process production system.

Repetitive processes occur in a number of manufacturing system layouts, such as work centre production systems, parallel-repetitive production systems, parallel-shared resource production systems and U-shaped production line system layouts, all of which can be addressed using this approach. These types of layouts can be seen in a number of job-shop precast production systems used in producing flat kerbs, bridge beams, concrete sleepers, manholes and other architectural and decorative concrete products. The next section describes the research problem in more detail.

4. ARCHITECTURE OF CREW ALLOCATION SYSTEM

The *SIM_Crew* architecture (fig. 2) comprises a central simulation model integrated with databases and optimisation (GAs) modules in order to generate and evaluate possible allocation plans.

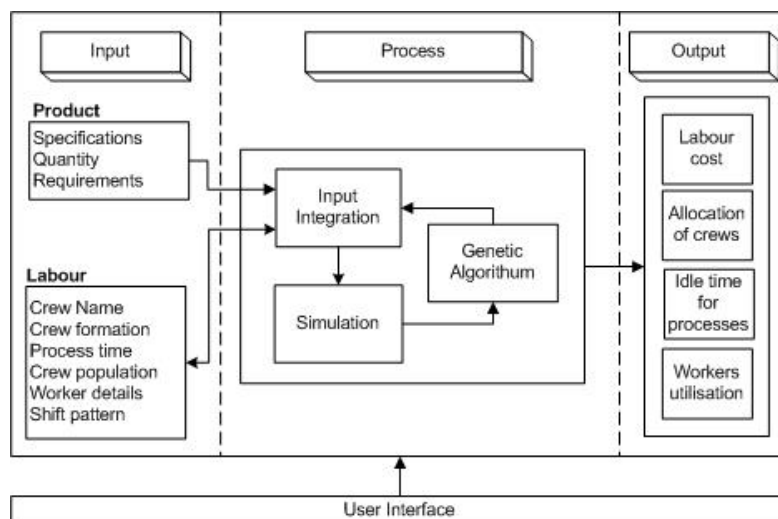

FIG. 2: ‘SIM_Crew’ Architecture

The model consists of a user-interface designed to include process information, optimisation parameter settings and other solution options. Production and labour information are the data inputs of the model. These inputs are stored in databases (product specifications in an Excel database and labour information in an Access database). The input is provided to the simulation model through input integration, consisting of a number of integration

technologies including ActiveX Data Objects (ADO) and Data Access Objects (DAO).

The information from the Access database does not directly constitute the input, since the input to the simulation model is obtained from databases using queries to form the required labour information set. Each input set is then processed to determine its performance, which is then, sent back to the optimisation engine in order to derive ever more promising solutions.

The role of the optimisation engine is to provide simulation with high quality inputs of feasible allocation plans for evaluation. Besides database integration, the integration of simulation and genetic algorithms is achieved through an input integration process, which consists of special computer codes. In the input integration process, an initial feasible solution is generated using population of crew indices.

GAs generate allocation plans consisting of crew sets to be allocated to a number of processes, the formation of each crew being defined and retrieved from the Access database before evaluation takes place. Subsequently, the proposed allocation plan is evaluated using the simulation engine.

The optimisation process is an iterative procedure of progressive improvement, in which each possible allocation plan generated by the GA is evaluated by the simulation engine. During one allocation iteration, the simulation programme executes allocation plans and the GA evaluates the performance of the resulting allocation plans, and based on this, adjusts the decision variables and selects the most promising ones. Following each iteration of the process, the result in terms of time, utilisation and cost are stored in a database for further analysis.

5. PROCESS MAPPING, SIMULATION AND OPTIMISATION MODELLING

5.1. Process Mapping Methodology

Several techniques were used in order to collect the data required for the development of the 'SIM_Crew' tool including site visits and structured interviews. Data collection and validation took place over seven days and a number of on-visits were made to a precast concrete company: four visits during the day and two during at the night. A generic process map for the business process of the precast manufacturing system was developed by conducting seven onsite visits for four precast concrete manufacturing companies. During these visits, fourteen structured interviews with sixteen personnel were conducted to collect the required information. The required information involved: flow and logic of the manufacturing processes, order requirements, crew formation data, worker skills and other cost detail. One onsite visit was conducted in order to validate the collected data and other system inputs.

The IDEF0 modelling approach was used to capture the logic of the processes because it enabled the development of rich process descriptions and it facilitated the modelling of complex systems (Jeong et al 2009). IDEF0 has graphic and text combined elements that are presented in an organised and systematic way, in order to obtain an understanding of the system, analysis support, and construction of the logic for potential changes, requirements specification and visualisation of the integration among the activities (Montevecchi et al 2008). See fig. 4 for the generic process map.

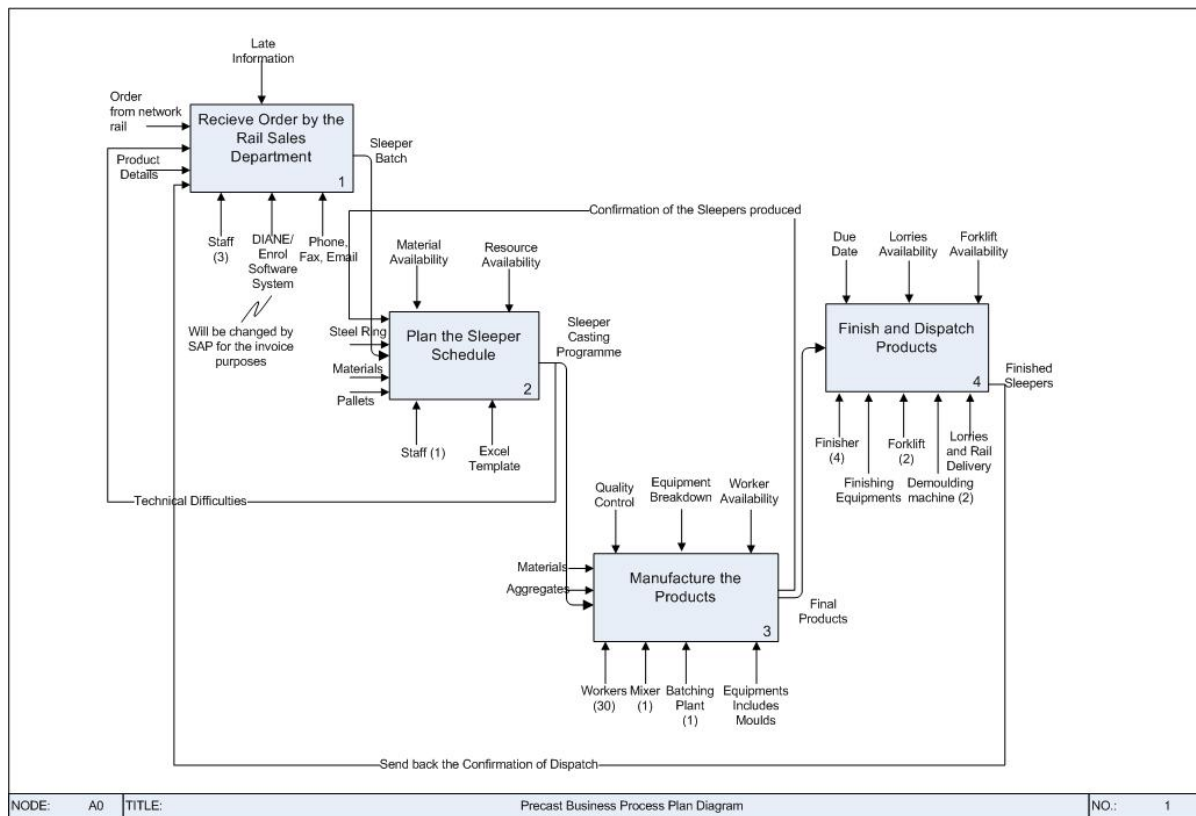

FIG. 3: Generic high-level business process mapping diagram for the precast concrete industry

The process flow in fig. 3 was comprised of four major business processes: order receiving, planning and scheduling of product manufacture, manufacturing the products and finally finishing and dispatching the products. Each process involved a set of activities and a series of these activities formed the detailed business system of the company. The **first process** plan addressed order receiving, (in which the sales department receives orders), which involved specifying the required product details and providing the sleeper batch size (quantity of sleepers to be produced). The **second process** covered the planning and scheduling of the production plan using Excel. Confirmation was given to the sales department indicating any technical difficulties, and Bill of Material (BOM) checks were undertaken to ensure sufficient quantities of materials were available for manufacturing to take place. The **third process**, the manufacturing, forms the focus of the research presented here. The production supervisors received the production plan and they were responsible for carrying out the production operations according to the specified production plan. There are a number of factors that affect the progress of the manufacturing system including worker availability, machine breakdown and mould availability. Feedback to the scheduling department was given for confirmation purposes. In the **fourth process**, finishing activities were undertaken to finalise the sleepers before dispatch: forklifts were used to move finished sleepers from the shop floor to the open stockyard area with lorries and trains being used to transport the product to its final destination. Dispatch confirmation was sent back to update the sales department on the status of the order.

5.2. Simulation Model Development

The ability to simulate processes on a computer, incorporating the uncertainties that are inherent in all real systems, provides a major advantage for analysis, in situations that are too complex to model mathematically (Glover et al 1999). As one of the common methodologies used to simulate real life systems, Discrete Event Simulation (DES) was used to simulate the production processes of the manufacturing system being investigated. because it was considered to be a powerful and feasible methodology for modelling many real systems as they progress through time. The primary objective of the developed simulation model is to analyse 'what-if' scenarios, and therefore evaluate the allocation of each crew set of workers to the production processes in any manufacturing system. All inputs, processes and outputs of the simulation model are explained in the following sections.

5.2.1 Modelling of the Production Processes

Flowcharts were developed to provide detailed descriptions of the production processes to break down the logic of each into individual activities. The simulation modelling of one production line consisting of eight production processes was investigated in detail to clarify the simulation logic. The first module is 'SEIZE', which is used to seize all orders to be processed on a 'First Come First Served' (FCFS) basis when a mould is available. A series of production processes are carried out to prepare order for dispatch (see fig. 4 that depicts production process operations).

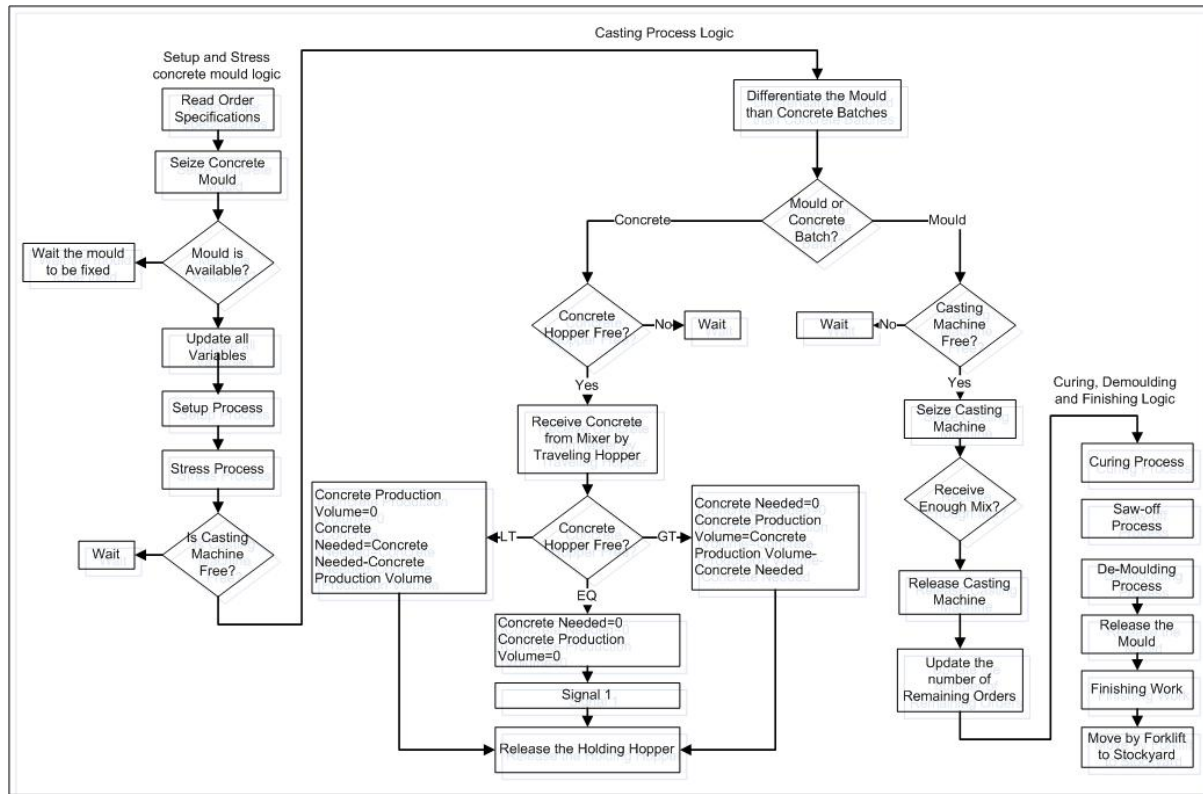

FIG. 4: Logical flow diagram of the production process operations

The production flow starts with the mould set-up as the first process. The inputs of this process are grease, pandrols (clips to fasten the rail with the sleeper) and other related materials. In the second process, a varying number of strands depending on the type of sleeper are placed inside the mould to reinforce the sleepers. After this, the casting process is the third applied process to fill the moulds with the required amount of concrete. In the fourth process, a steam blanket system is used to cure the cast sleepers. Demoulding follows the curing process is the fifth process, which involves cutting off the strands and which is followed by mechanical demoulding (removing them from the mould) of the sleepers. The finishing of the sleepers is the final process, which involves placing plastic rubber clips on each sleeper.

The inputs, process, and outputs required by the allocation system are introduced and discussed as follows:

- Inputs

The specifications of the orders to be produced in each production line in each section are identified. Each specification involves the type of the product, the quantity needed, the amount of materials required for each order and fixed resource status (available or not). All production information is stored on an Excel spreadsheet integrated with ARENA using Data Access Object 'DAO'. All other labour information is stored in an Access database. The skills needed by each crew for each process are determined by identifying the crew formation. All labour information is stored in an Access database (see fig. 5).

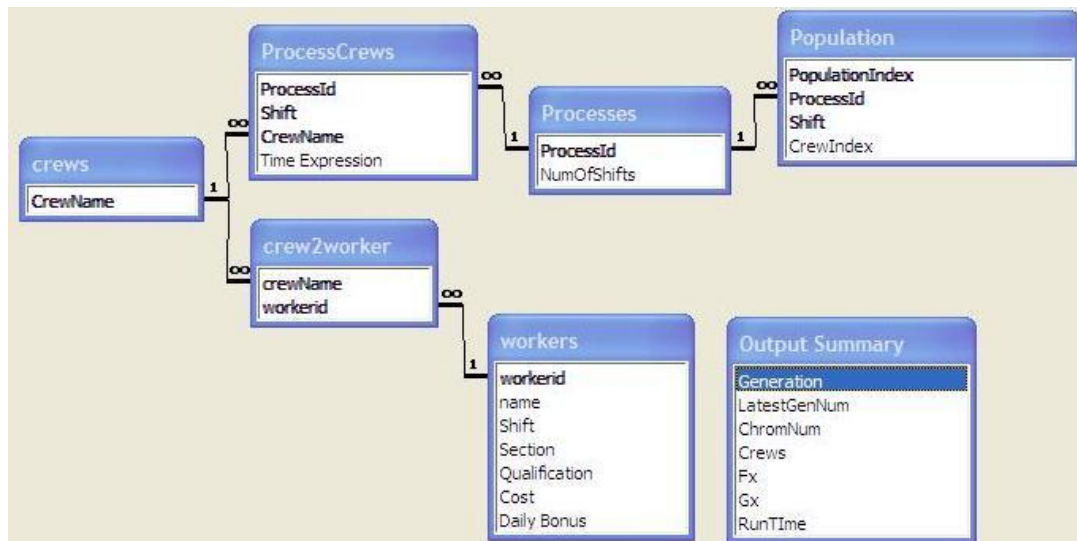

FIG. 5: Relational database for SIM_Crew system

Fig. 5 shows a relational database model developed to store and retrieve information regarding crews, workers, crew-processing time, and other worker related information including skills and costs. Visual Basic for Application (VBA) subroutines were developed to process data exchange between ARENA and Access database files.

- Process

In order to generate outputs, inputs should be progressed through a mathematical expression or any other engine in order to produce outputs. In this study, the simulation model was selected as the engine that processed the inputs to provide outputs, which could then be used to evaluate each set of allocated crews of workers across the processes. The integration of process simulation and Genetic Algorithms is introduced in the section 6.3 such that production and labour inputs could be processed to obtain promising allocation outputs.

- Outputs

The outputs of the simulations being stored in Excel files for further analysis and presentation. Some of the results are stored in the Access database, generation by generation, to check for chromosome duplication. A large number of text files were created to validate the operation of the optimisation engine operators.

The performance metrics for labour allocation are the measures used by the precast industry:

- Total resource allocation cost (the overall cost of allocating resources in the precast manufacturing system)
- Crew member utilisation (the proportion of value-added crew member-hours of the total value invested in labour) and
- Process-waiting time (hours spent by a process waiting for resource/resources).

5.2.2 Assumptions of the Simulation Model

The following assumptions were made when constructing the simulation model, in order to simplify model development:

1. Each crew member is intensively involved in carrying out the production process and all members work together to finalise the process.

2. The whole responsibility of carrying out a process is handed to the next shift crew of workers. This occurs when the remaining time of the current working shift is insufficient to carry out the production process.
3. To begin a production process, all crew members must be available to carry out that process and must be released at once when the process is completed.
4. The model is developed based on a two-shift system as a maximum; the first production section has two shifts while the second one has only one.
5. Only direct cost is considered.
6. Deterministic production and demand rates are considered in this study.

5.3. Development of the Multi-Layered Genetic Algorithms Model

A GA is defined as a computational model simulating the process of genetic selection and natural elimination in biological evolution (Kumar et al 2009). The benefit of using GAs within simulation models is that they can identify near-optimal solutions. The combination of simulation and optimisation can be defined as the process of finding the best set of input variables without evaluating each possibility (Molnár 2004). It is difficult to find satisfactory solutions for real-life allocation problems, which usually require a substantial amount of computations using traditional GA. In previous work, multi-layer GA models were developed either in terms of multi-level GA in which each level is a separate traditional GA (Kelareva and Negnevitsky 2001), or by dividing a traditional GA model into several layers, each layer representing a part of the initial problem (Negnevitsky and Kelareva 2008). Both studies above used a traditional chromosome (vector) in the problem formulation.

The proposed multi-layered GA model used in this study is different from earlier work in this area, since it provides more flexibility to deal with multi-attributed inputs and the ability to solve crew allocation problems in a parallel-repetitive processes layout. The proposed chromosome structure alongside with developing GA operators and adoption of the 'non-repeatability' condition were necessary to differentiate the developed model from other models. These modifications enabled the proposed GA model to have a more organised input processing capability than other traditional models (see fig. 6 for the developed GA algorithm). In the traditional models, genes are encoded by a vector representation called a chromosome.

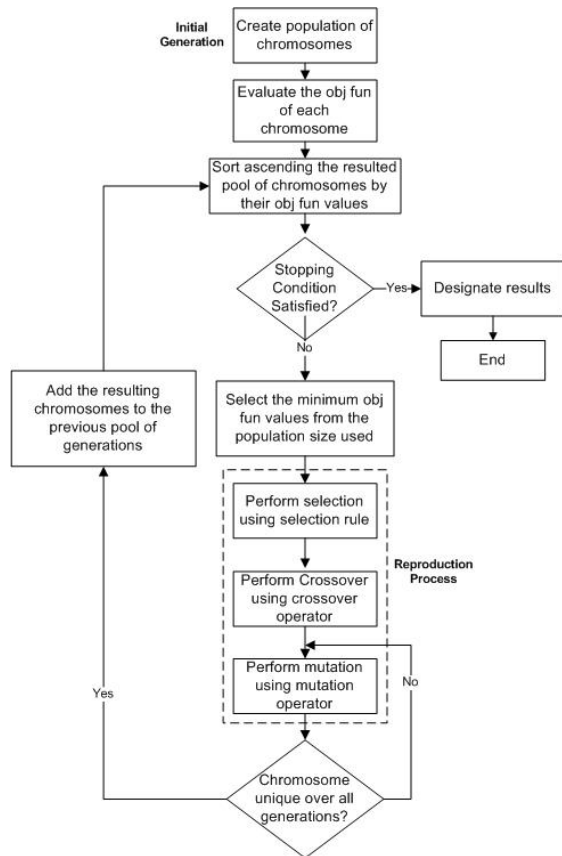

FIG. 6: Modified GAs Flowchart

In the modified GA model, (see fig. 6) an initial population of chromosomes (each chromosome consisting of a set of crews assigned to processes) is randomly generated, using a Monte Carlo sampling technique. Monte Carlo simulation relies on repeated random sampling and statistical analysis to compute the result (Raychaudhuri 2008). This method works on the principle that if enough random guesses are completed, the right answer will be identified. Monte Carlo Simulation is useful for modeling phenomena with significant uncertainty in inputs, such as the calculation of risk in business and modelling of environmental aspects.

The most promising chromosomes remain at the top of the list, for easier access and further selection. For this purpose, the SQL query was set to sort in ascending order according to the minimum cost chromosomes of population size. Each pair of chromosomes was selected using a selection rule to prepare them for further crossover and for mutation purposes. A ‘non-repeatability’ condition was imposed to avoid any repetition which might occur by producing two similar chromosomes. A ‘stopping criterion’ was used to stop the algorithm when no considerable cost improvement was achieved after a number of consecutive generations. After each generation, the population was added to the population of previous generations to produce an augmented population pool. A sorting process was then applied to the augmented population, and the selection of the most promising chromosomes continued during the solution evolution process.

The output of optimisation represents a possible ‘set of crews’ that can be allocated to carry out processes representing the problem variables (number of variables = number of sets of crews available to be allocated to each production process). The decision variables were then placed in a row vector (string) called a chromosome.

Chromosome is defined as a representation of a given solution by a vector of attributes. This chromosome consists of genes, which will also be called variables or attributes. (Pardalos and Du 1998)

A chromosome structure was designed to suit this type of problem (see fig. 7).

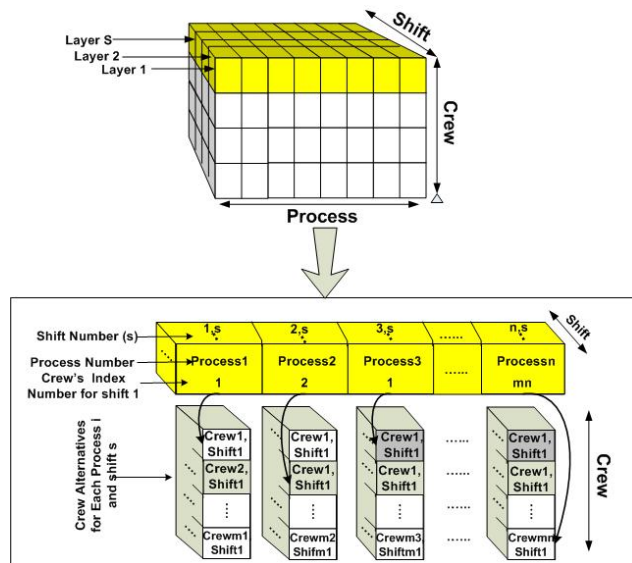

FIG. 7: Shows chromosome representation for crew allocation problem

As illustrated in fig. 7, each integer number of each gene identifies the crew index number of the set of crew alternatives associated with that gene, i.e. this number gives the index of a crew that could be used in the solution. Each gene has different possible alternatives for the crews to be used in the solution. A chromosome was encoded in a decimal way, which the chromosome length representing the maximum number of processes involved in any labour-driven production unit. The decision variables are the number of sets of crews available for allocation to each process. To evaluate each chromosome, a single objective function was identified and adopted to minimise labour costs. Restrictions can be determined which limit production amounts, alternative crews and operational hours (shifts).

The objective function was applied to evaluate the total resource allocation cost. The equation used to calculate such objective function was:

$$f(x_i) = \sum_{i=1}^n BRC_i + IRC_i + RCPU_i \quad (1)$$

where:

n : number of labour-driven processes

BRC_i : incurred cost per hour when using a labourer for set of solution i .

IRC_i : incurred cost per hour when labourer is idle for set of solution i

$RCPU_i$: incurred cost per use of fixed or physical resource (machine) for set of solution i ,

a senior skilled bonus can be considered in such cost.

Where: BRC is the Busy Resource Cost, IRC is the Idle Resource Cost and RCPU is the Resource Cost Per Usage. These costs were identified and collected from shop floor records. As an initial starting point, a population of random solutions (chromosomes) was generated. Population size and other GA operator parameters are influential factors that affect the solution and simulation time (Boyabatli 2007). As stated previously, Monte Carlo can be used to select the crew alternative for each gene (i.e. process) with an integer random number being generated for the random selection of the available crew alternatives for each process. The range of random numbers for each gene can be determined using the following constraint:

$$MinCA_{i,s} \leq R_{i,s} \leq MaxCA_{i,s}$$

where:

$R_{i,s}$ is an integer random number for each chromosome i on shift s

$MinCA_{i,s}$ is the minimum number of crew alternatives in gene i on shift s

$MaxCA_{i,s}$ is the maximum number of crew alternatives in gene i on shift s

In the present model, the user is given the flexibility to input the population size. Once the population is

generated, the objective function of each chromosome in this population is evaluated by processing the chromosome into the simulation model, assigning the crew numbers associated with the chromosome to the simulated processes, running the simulation model and obtaining the output costs of labour associated with that chromosome. GA operators were developed to suit this type of allocation problem. *Class Interval selection*, *probabilistic Dynamic Crossover*, and *Mutation Strategies* are, explained in detail as follows:

5.3.1. The Class Interval Selection Strategy (CISS)

In the ‘Class Interval’ selection strategy, the promising chromosomes with the least costs are assigned a higher chance of selection. This strategy, was developed to provide the promising chromosomes with a greater chance of selection through the ‘Class-Interval’ concept used to group non-tabulated data in descriptive statistics (Healey 2009).

The top of the minimum costs chromosome was assigned a higher weight than others, by calculating the fitness function of each chromosome according to equation 2:

$$Gx_i = Max - f(x_i) \quad (2)$$

Where:

Gx_i : Fitness function of chromosome i
 $f(x_i)$: sorted objective function for top promising chromosomes
 Max : the largest cost value in the best promising chromosomes

The repetition of any generated chromosome is prevented by a condition imposed to violate such repetition, hence all generated chromosomes are unique over the evolution process. As a substantial requirement to construct the class interval of the chromosome, a relative fitness function RGx_i is calculated using equation 3:

$$RGx_i = \frac{Gx_i}{\sum_{i=1}^m Gx_i}, \quad i=1, \dots, m \quad (3)$$

where:

m : is the population size
 RGx_i : relative fitness function of chromosome i

Cummulative relative fitness function is then calculated, as it is useful to determine the desired class width using equation 4:

$$CRGx_i = CRGx_{i-1} + RGx_i, \quad i > 1 \quad (4)$$

where:

$CRGx_1 = Gx_1$
 RGx_i : relative fitness function of chromosome i
 $CRGx_i$: cumulative Relative fitness function of chromosome i

The possible interval of occurrence for each chromosome is determined in terms of class intervals. The interval associated with each chromosome represents the chance range of that chromosome to be selected by any generated (0-1) random variate. In the proposed selection strategy, pairs were selected after sorting resulting costs obtained using equation 1 in an ascending order as the promising pairs. Fitness function was then calculated using equation 2 and the calculated fitness function was sorted in descending order for a better selection to be applied at a later stage. In order to identify the selection range of each chromosome, a relative fitness function was calculated using equation 3 as a requirement for constructing the chromosome class interval. Cummulative relative frequency was then calculated using equation 4 as an upper boundary of the selection of the chromosome. The lower boundary can be identified to represent the possible range of each chromosome. This strategy was useful for chromosome selection, especially whilst writing VBA codes (Al-Bazi et al 2009b). The rationale of modifying this concept was to improve the chance of selecting the promising chromosomes, the chromosomes with the minimum cost or a higher fitness function being given a wider range of interval so

random variants will be most likely to lie in that range.

5.3.2. Probabilistic Dynamic Crossover (PDC) Strategy

The crossover operation in a conventional GA is based on the exchange of genes between two fixed length chromosomes when coding is applied. To crossover genes in the chromosome, (0-1) variate should be generated for each gene at each layer.

This type of exploration investigates all active genes (occupied genes by a scheduled crew) for increasing randomness. If the gene is vacant for any reason, then the generated random number will be discarded to select the next gene. A random number is then generated to exchange genes after satisfying a specific condition. In this strategy, random numbers are generated and attached to each gene at each layer. The probability of crossing over a gene is then generated to enable vertical gene alteration. The generated probability crosses over the gene rather than enabling the crossover of a chromosome. In this type of crossover, (0-1) random numbers of size n were generated to be associated with each gene. A vertical crossover takes place to exchange or alternate n gene(s) of the first chromosome with the opposite gene of the second selected chromosome after satisfying the condition below:

If the probability of crossing over a gene is equal or less than the random number associated with that gene, then the crossing over of that gene is possible. PDC was developed to achieve the best random exchange of genes between each pair of chromosomes (see fig. 8).

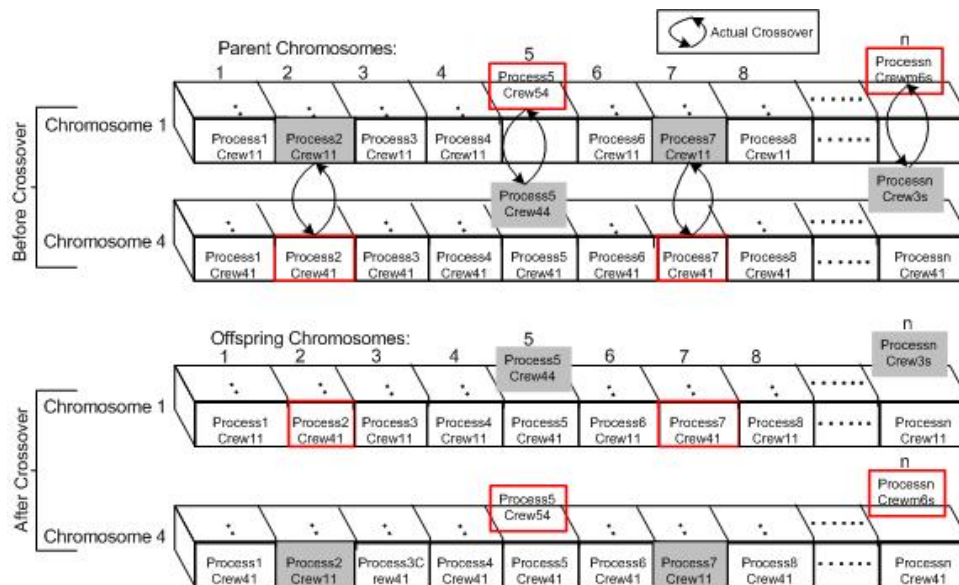

FIG. 8: Multi-Layered Crossover Strategy

The probability of crossing over a gene can influence whether or not that gene can be exchanged with the chromosome of the opposite gene. For example, the four random numbers satisfy the exchange condition at genes 2, layer1, 5, layer3, 7, layer1 and n , layer 6. The chosen places or genes will be exchanged vertically for each selected pair of chromosomes (Al-Bazi et al 2009a).

This type of crossover strategy can provide an equal chance for all genes to be exchanged with the genes of the opposite chromosome. In this strategy, any repeated chromosomes are discarded, as the mutation operator exchanges genes until a unique chromosome is found.

5.3.3. Probabilistic Dynamic Mutation (PDM) Strategy

To avoid local maxima by randomising the search process and avoiding chromosome duplication, a modified mutation process was developed to exchange the gene within a chromosome with its available set of alternatives (Al-Bazi et al 2009a). In this strategy, (0-1) random variants are generated to be associated with each gene at each layer and random variants for vacant genes are discarded. Monte Carlo (MC) sampling is then applied to exchange the current gene stochastically with another alternative, (see fig. 9).

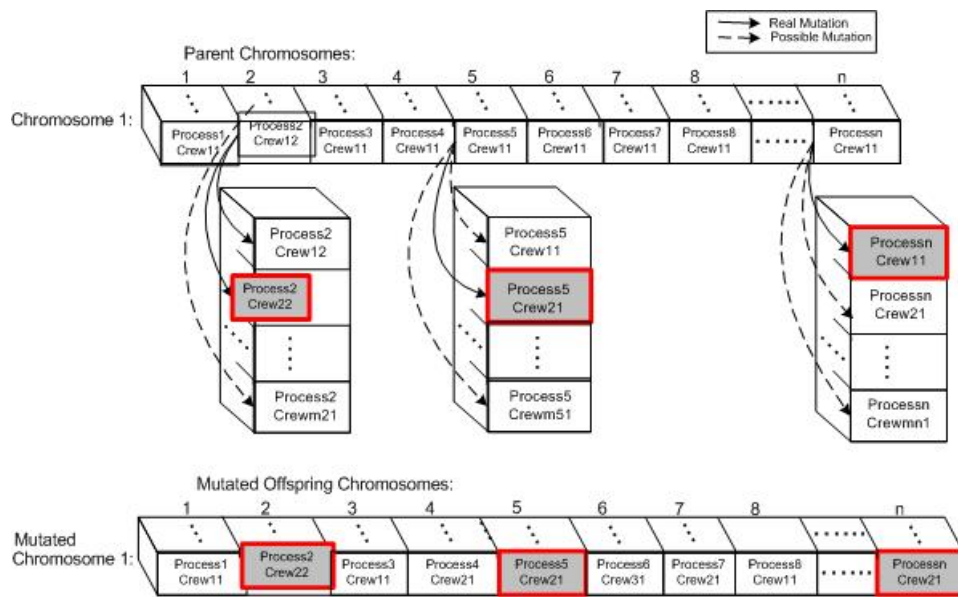

FIG. 9: Multi-Layered Mutation Strategy

In this type of mutation, each offspring (an individual chromosome) is selected at random and various genes are mutated vertically with its set of crew alternatives at each layer. The forms of crossover operators and mutation operators also depend on the way the problem is coded (Leu et al 2000).

6. BENEFITS OF THE PROPOSED CREW ALLOCATION SYSTEM IN THE PRECAST INDUSTRY

The main benefits of the 'SIM_Crew' crew allocation system are that it:

- improves the performance of the production processes – labour intensive process and subsequently the reliability of the precast manufacturing system;
- ensures that the right crew is available at the right time and in the right place;
- reduces the cycle time and overheads of crew planning;
- prevents schedules from conflicting with different kinds of constraints and ensures that schedules comply with the law and regulations pertaining to the processes being studied;
- optimises the utilisation of labourers and minimises both process-waiting time and labour allocation cost;
- quantifies the impact of adopting different crew allocation plans on the precast concrete product manufacturing system investigated and
- identifies and analyses improvement opportunities.

7. THE CASE STUDY

In order to analyse the ability of the system, a real life case study was undertaken for one of the largest sleeper precast concrete manufacturers in the UK. In the sleeper manufacturing system, a wide range of different shared resources, including workers, equipment and materials are utilised.

A 'sleeper concrete manufacturing system' is divided into two main production sections: each production section has two labour-driven production lines. Sharing resources at each production section were utilised. Eight production processes, including the curing process, are applied on each production line.

Two types of multi-skilled workers were used to carry out jobs in the sleeper manufacturing system: charge

hands (multi-skilled workers in charge of operators) and operators (multi-skilled workers). The categories of workers were identified by the production planner according to their accumulated experience records, with each multi-skilled worker having enough skills to carry out a number of possible activities. This number depended on the accumulated skills of the worker and his/her ability to work on more than one process.

In production section 1, eleven operators and two charge hands carried out jobs during the day shift, while ten operators and two charge hands carried out the jobs left over from the day shift during the night shift. In production section 2, thirteen operators and four charge hands were used in one shift.

In any of the production lines, a 'reusable mould' is the main resource. This consisted of a gang of moulds that can be used to produce either the same or different types of sleeper. The floor shop layout was made up of three zones: the *materials zone*, the *concrete mix zone* and the *production zone*. In the material zone, all steel wire rolls, plastic spacers, pandrols and other finishing accessories were stored near the production facility so that they were available when required. A number of mechanical resources were located in this area after use (fig. 10). Due to issues of confidentiality, details concerning crew, formation data and worker skills are not discussed in this paper.

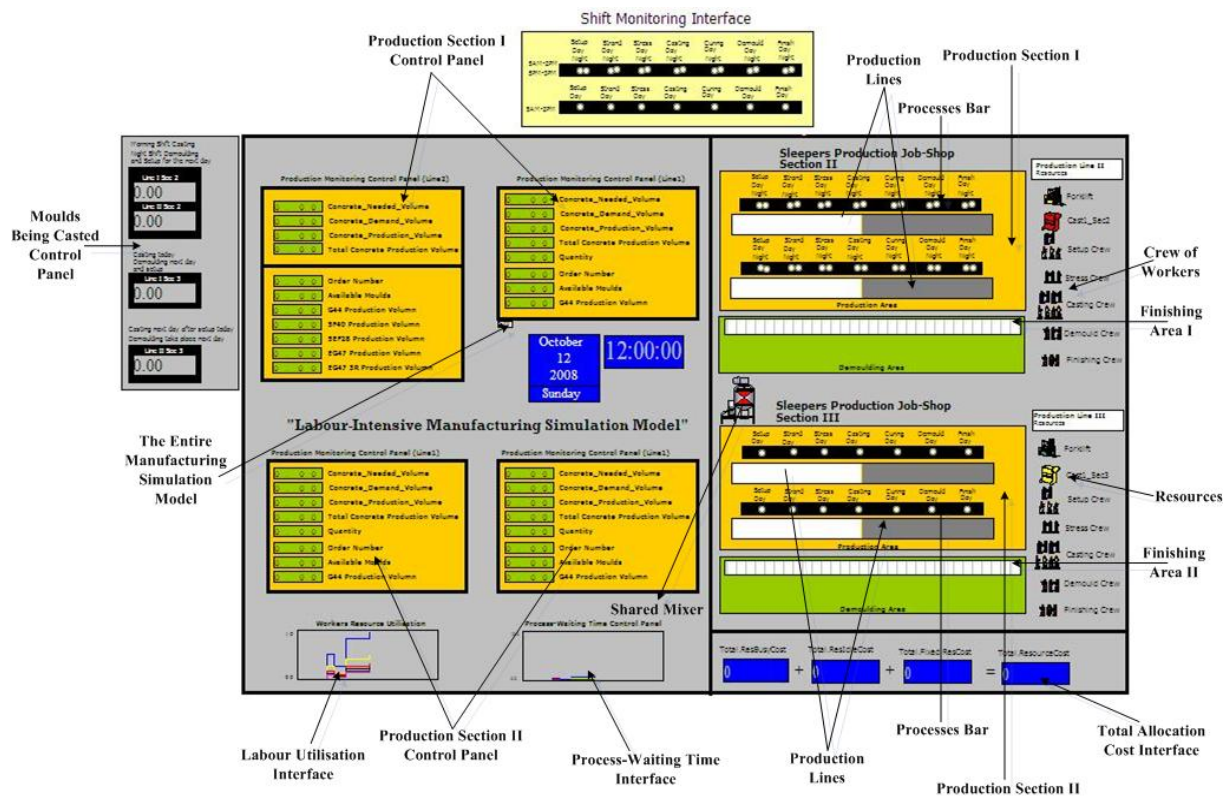

FIG. 10: 'SIM_Crew' allocation system screen shot

ARENA Rockwell software was adopted to simulate the production processes (see fig. 10) in which four moulds distributed in two production sections were used; the progress of seven production processes in two shifts was identified through process bar indicators designed for each mould. A collection of crews was placed in a pool ready to be assigned to production processes. A monitoring panel was designed to show the production details and the changing concrete demand at each mould during the production process. Resource utilisation and process-waiting time visual panels were developed for graphical display purposes. In addition, the components of the total allocation cost within the total cost were enabled and displayed during the progress of the allocation process.

7.1. Experimental Design

The experimental design consists of developing a number of allocation plans to be evaluated through simulation. The GA engine suggests a possible set of crews for processes; each set of crews can be considered as an allocation plan. The best suggestion for allocation plans can be obtained by identifying the best parameters of the allocation system.

In this study, the number of processes was 28 and there were 66 resources (workers and physical machines).

Two working shifts are adopted (day and night shifts for the first production section and one shift for the second production section). In order to improve the searching process for promising solutions, optimisation parameters were set after a number of experiments, as several sets of different probabilities were tested without significant effects. These have the following best settings at a population size equal to 20, gene crossing-over probability is, found to be 0.70 and gene mutation probability is 0.90. Mutation probability plays a significant role in avoiding chromosome repetition and adds more randomness to the searching process.

The stopping condition is satisfied when there is no reduction in the resulting cost for five generations (100 chromosomes). Key performance indicators were designed to test the performance of the allocation system. The GA operators were well tuned to explore all of the solution space randomly.

7.2. Analysis and Interpretation

To identify the benefits of the proposed approach, it is necessary to compare the new assignment scenario with the current assignment used in the real world (see fig 11).

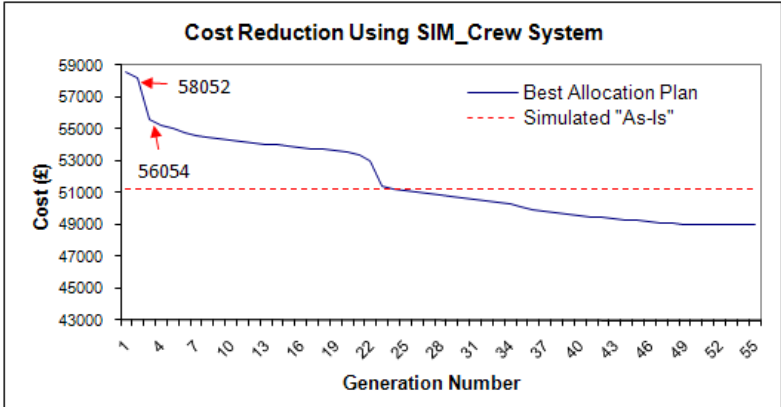

FIG. 11: Cost reduction using SIM_Crew system

Fig. 11 illustrates that two significant cost drops take place after the 1st and 21st generations. The GA dynamic probabilistic operators identified the more promising solution areas with each successive generation. Allocation cost tended to have no further improvement after 50 generations. In the best scenario, the achieved allocation cost was £49,000, which is a return of 3.265% (about £1600 per ten working days). This percentage (3.265%) was calculated by the formula:

$$\frac{\text{cost before improvement} - \text{cost after improvement}}{\text{cost before improvement}}$$

The reduction in cost resulted in reducing the throughput time, with 12 hours saved by adopting the best scenario (see fig. 12), which illustrates that the allocation cost in this case was significantly related to the throughput time.

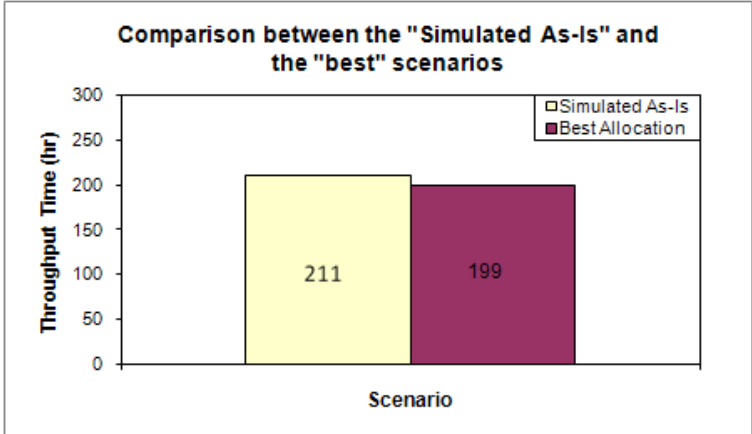

FIG. 12: Throughput time reduction using 'SIM_Crew' system

Other factors that affect allocation cost, such as process-waiting time and labour utilisation also require investigation. However, it was essential to reduce labour overlaps for an improved workflow to be achieved. Therefore, the relationships between workers, process-waiting time and allocation cost were investigated in detail via two scenarios (see figs. 13 and 14 for the skilled and non-skilled worker utilisation profile).

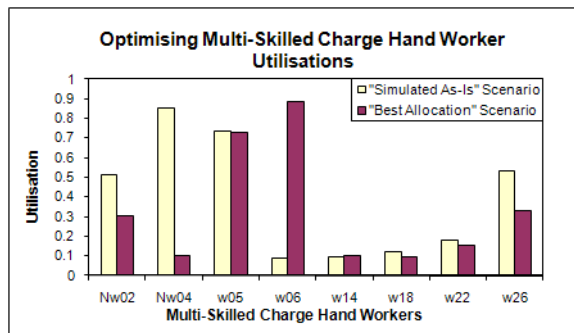

FIG. 13: Comparison of skilled worker utilisation

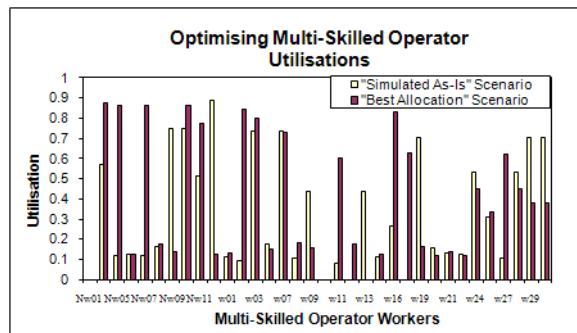

FIG. 14: Comparison of semi-skilled worker utilisation

In fig. 13, Nw02, w05 represent night workers 02 and day worker 05 respectively. Less skilled charge hand workers were required during the night shift, and the highly skilled worker number 5 is a critical worker who cannot be replaced (his/her utilisation cannot be reduced). The demand for multi-skilled worker number 6 was high because he was, assigned to a number of processes, to provide the required assistance with all production processes during the shift. The remaining skilled workers required a 10%-20% level of supervision and guidance to support semi-skilled workers. The process of balancing the utilisation of skilled and semi-skilled workers was essential to guarantee an improved workflow and therefore a minimum allocation cost. The summaries of skilled and semi-skilled workers in more than one shift are illustrated in figs. 15 and 16.

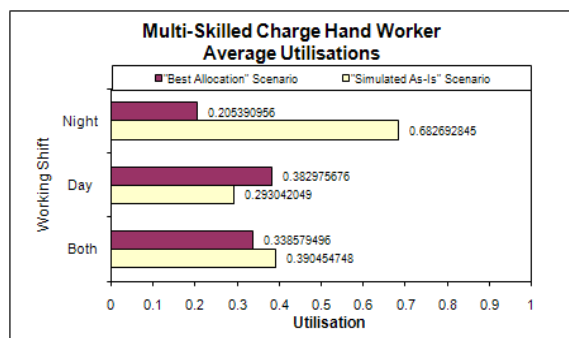

FIG. 15: Balance of skilled worker utilisation

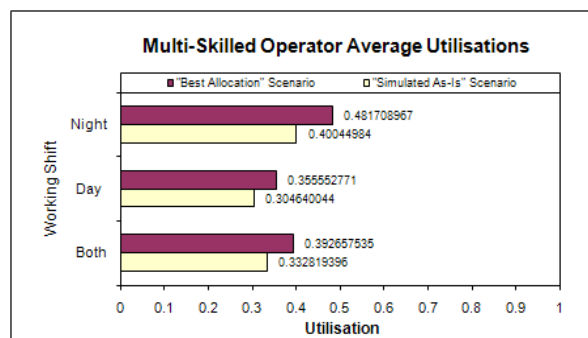

FIG. 16: Balance of semi-skilled worker utilisation

The average utilisation rates for workers with different skills are presented to give an overall picture of the required number of workers with each skill in both shifts. Fewer highly skilled workers were required during the night shift than during the day (see figs 15 and 16). Process-waiting time also had a significant impact on ICR, cost and subsequently the total allocation cost. Therefore, it was analysed and optimised to improve workflow. The process-waiting times achieved by running current and optimal assignment plans are given in figs 17 and 18.

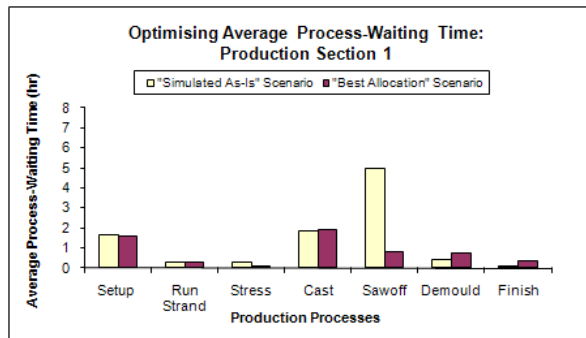

FIG. 17: Comparison of process-waiting time(section 1)

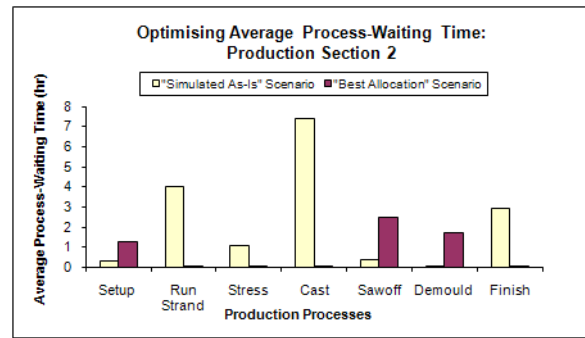

FIG. 18: Comparison of process-waiting time (section 2)

Fig. 17 illustrates the best-case scenario producing a noticeable reduction in the saw off process waiting, but the waiting time yielded in the setup and casting processes was not reduced because these were both critical processes. Fig. 18 illustrates how a significant reduction may be achieved in a further four production processes (run strand, stress, cast and finish) by adopting the best assignment scenario. However, these reductions resulted in increasing the average waiting time of some other processes such as setup, saw-off and de-moulding.

The results of the case study indicate that the ‘SIM-Crew’ tool can be used to reduce allocation cost and process-waiting time by optimising labour utilisation in a number of parallel repetitive processes. A predicted 3.265% reduction in allocation cost was achieved by the proposed plan. The findings were discussed with management to assess the tools applicability of the tool in the real world. However, a manager in charge of planning work stated that: ‘It is hard for us to use such advanced systems since lots of academic background and modelling skills need to be understood before using it’. Therefore, it may be advantageous to run short training courses and /or prepare manuals concerning system functionality and application.

The impact of applying the allocation system was justified in terms of saving additional allocation cost and reducing the total production time by one working shift per week. This reduction was achieved by optimising the utilisation of multi-skilled workers in the precast industry. This improvement was achieved by modelling the utilisation of multi-skilled operators, which has led to improvements in pre-existing practice.

The developed system was important to show how to best utilise multi-skilled workers with regards to costs and allocation costs. The model developed could be adapted to fit different allocation problems such as modelling the daily allocation of crews, which still needs further investigation for better planning. In this case, a different crew can be assigned daily in response to worker availability.

7.3. Comparison between GA, Monte-Carlo and Simulated Annealing

To evaluate and validate model performance in terms of solution optimality and efficiency, its output was compared to output from the Monte Carlo sampling and simulated annealing approaches.

The Monte-Carlo experiment generated a set of solutions using a random number generator. This generator selects a crew from each alternative pool associated with a process. After forming an allocation plan in which a crew is proposed for each process, the simulation engine evaluates the generated allocation plan and the results are stored in a database. One allocation plan is generated per iteration to be evaluated by the simulation engine. The Simulated Annealing model starts with a temperature equal to 70 (coefficient used to control the genes exchange), a decrement of 0.01 and 20 iterations at each temperature, in order to explore, more promising solutions in the solution space. Subsequently, a gradual temperature reduction took place in which less randomness in the search process was achieved as the cooling process started. This type of exploration was achieved using the proposed *probabilistic dynamic mutation* operator. Fig. 19 shows the allocation costs yielded through generations/iterations by using Simulated Annealing, Monte-Carlo Sampling techniques and the proposed GA system.

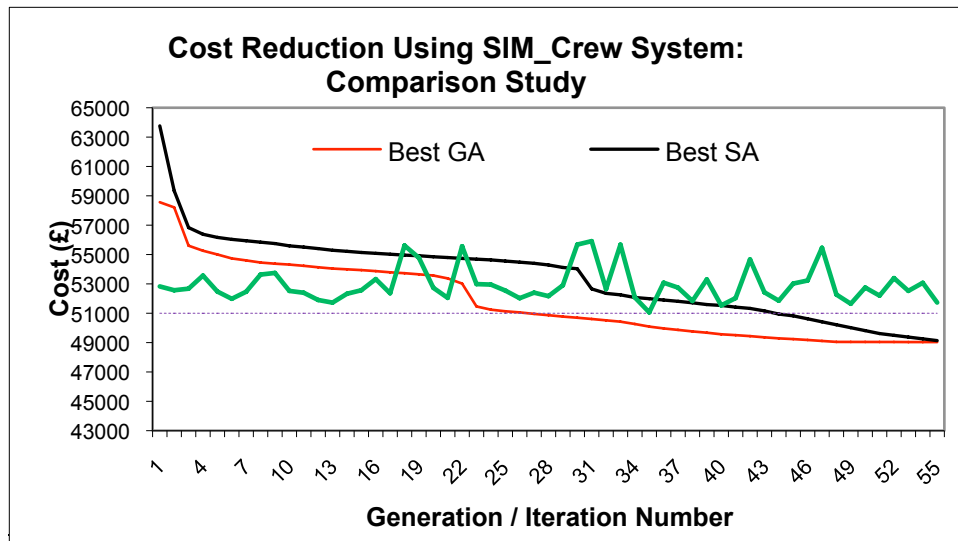

FIG. 19: Cost comparison study of GA with SA, Monte-Carlo and as-Is scenario

It can be seen that cost is highly dependent on time, the direct cost being a function of time. If the resources are utilised efficiently, the throughput time will be reduced as less idle time is achieved, the cost eventually being reduced as a response to such behaviour. It was interpreted that the behaviour of the throughput time was similar to the cost reduction curve behaviour.

During the validation process, the developed Monte-Carlo model showed a number of allocation costs that were close to the minimum allocation cost. Monte Carlo performed a better cost reduction than the GA and SA for twenty generations. The best GA of each generation showed a significant and rapidly improving trend towards the minimum allocation cost. The best SA of 20 iterations under different temperatures indicated a parallel convergence with the GA, but with a slight difference in cost reduction and late cost drop in comparison with GA. Both GA and SA were considered as evolving solutions for the identification of the best allocation plan, while the Monte-Carlo model utilised the 'Trial-Error' concept to identify randomly the minimum allocation cost. This comparative study has shown the superiority of the proposed GA model.

8. CONCLUSIONS AND FUTURE WORK

The methods of integrating simulation with GAs were presented and the application of these methods in the development of a crew allocation system was discussed. A case study illustrated that the crew allocation system presented offers a solution to the allocation of a suitable crew of workers to the process associated with manufacturing systems in the precast concrete industry.

The developed process maps were used successfully to capture the hierarchy structure of the sleeper precast concrete manufacturing system. These diagrams were useful in providing the required logic of each process and the overall process relationships required in simulation. The simulation model was successful in that it fully imitated the precast manufacturing system, which was used to test and identify system performance of each crew allocation plan. The concept of using a GA in solving this type of problem and the construction of the innovative chromosome to accommodate multi-attribute inputs assisted in solving complex problems of the nature investigated. The proposed operators contributed significantly to the search for promising solutions within a very large solution space, while the selection mechanism of chromosomes played a vital role in selecting promising chromosomes, and gave a greater chance for strong chromosomes to be selected again.

An improved workflow was achieved by reducing the process-waiting time of a number of production processes by using the proposed allocation system, which led to a guaranteed improvement in workflow to enable concrete sleeper products to be delivered to the construction site on time. Delivering product components on time contributes significantly to achieving improved performance and reliability in the construction supply chain.

As a further development of this research different levels of priority (High, Medium, and Low) can be included in a chromosome layer, especially if they have a significant influence on overall system performance. Environmental impact can also be taken into consideration whilst allocating resources.

Heuristic rules can be used to model such allocation models: other AI tools can be used in the modelling of a crew allocation system, depending on which facilities the tool can provide to solve such problems. Fuzzy crew processing time might be considered in a further study. A fuzzy model could be developed to be coupled with the simulation model or a mathematical model depending on the suitability of modelling. Multi-objective optimisation is still worthy of consideration in solving this type of allocation problem. Different costs can be considered as multi-objectives in order to minimise each. Other random circumstances may be considered such as worker absence, delay or normal leave, which require an immediate response to substitute the absent worker with an alternative.

9. REFERENCES

- Al-Bazi, A., Dawood, N. and Khan, Z. (2009a). "Development of hybrid simulation and genetic algorithms system for solving complex crew allocation problems". *Proceedings of the CIB W078 - Managing IT in Construction*, October, 2009, Istanbul, Turkey.
- Al-Bazi, A., Dawood, N. and Dean, J. (2009b). "Development of 3D-simulation based genetic algorithms to solve combinatorial crew allocation problems". *Proceedings of the 9th International Conference on Construction Applications of Virtual Reality*. November 5-6 (2009), pp. 207-216.
- Boyabatli, O. (2007) Parameter selection in genetic algorithms. *Journal of Systemics, Cybernetics and information (JSCI)*, 2 (4), pp. 78-83.
- Chen, Y., Okudan G.E. and Riley D.R. (2010) Sustainable performance criteria for construction method selection in concrete buildings. *Automation in Construction*, 19 (2), pp. 235-244
- Chuan, C.J. and Pheng, L.S. (2001) A study of the readiness of precasters for just-in-time construction. *Work study*, 50 (4), pp. 131-140.
- Dawood, N., Ahmed, R. and Dean, J. (2007) Modelling of precast concrete production operations and innovations: a simulation approach. *Manubuild Conference*, Rotterdam, 25-26 April.
- Glover, F. , Kelly, J. P. and Laguna, M. (1999) New advanced for wedding optimization and simulation. In *Proceedings of the 2005 Winter Simulation Conference*, P. A. Farrington, H. B. Nembhard, D. T. Sturrock, and G. W. Evans, (Eds.), pp. 255-260.
- Goodier, C.I. (2006). Skills and Training in the UK Precast Concrete Manufacturing Sector, report for BPCF and ProSkills, Loughborough University. *Construction Information Quarterly*, Vol 10, pp. 121-137, available at: <http://hdl.handle.net/2134/5463>
- Healey, J.F. (2009) *Statistics a tool for social research*. Wadsworth Cengage Learning, 8th edition, USA.
- Hyari K. and El-Rayes K. (2006) Optimal planning and scheduling for repetitive construction projects. *Journal of Management in Engineering*, 22 (1), pp. 11-19.
- Ipsilandis, P.G. (2006). Multiobjective optimisation in linear repetitive project scheduling. *Operational Research. An International Journal*. 6 (3), pp.255-269.
- Jeong K.-Y., Lei Wu L. and Hong J.-D. (2009) IDEF method-based simulation model design and development. *Journal of Industrial Engineering and Management*. 2 (2), pp. 337-359.
- Kelareva, G.V. and Negnevitsky, M. (2001) Multi-layer genetic algorithm for maintenance schedule optimisation, *Proceedings of the Australasian Universities Power Engineering Conference (AUPEC-2001) - Millennium Power Vision*, 23-26 September, 2001, Perth, Australia, pp. 379-384.
- Kumar, A. J. S., Arunadevi, J. and Mohan, V. (2009) Intelligent transport route planning using genetic algorithms in path computation algorithms. *European Journal of Scientific Research*. 25 (3), pp. 463-468
- Leu S.-S., Yang C.-H., Huang J.-C. (2000) Resource leveling in construction by genetic algorithm-based optimization and its decision support system application. *Automation in Construction*, 10 (1), November 2000, pp. 27-41.
- Li, H., Love, P. and Ogunlana, S. (1998) Genetic algorithm compared to nonlinear optimisation for labour and equipment assignment. *Building Research and Information*, 26 (6), pp. 322-329
- Lu, M., Lam, Hoi-Ching, Tang S.L. (2008) Skilled laborer management in handling concurrent building projects at multiple sites: the bar benders job scheduling problem. *First International Conference on Construction In Developing Countries (ICCIDC-I)*, August 4-5, Karachi, Pakistan.

- Marzouk , M. and Moselhi, O. (2004) Multiobjective optimization of earthmoving operations. *Journal of Construction Engineering and Management*, 130 (1), pp. 105-113
- Marzouk, M. Hisham Zein El-Dein and Moheeb El-Said. (2007) Application of computer simulation to construction of incremental launching bridges. *Journal of Civil Engineering and Management*, 13 (1), pp. 27-36.
- Molnár, B. (2004) Planning of order picking processes using simulation and a genetic algorithm in multi-criteria scheduling optimisation. *Proceedings 16th European Simulation Symposium*.
- Montevecchi J.A.B., Costa R. F. D.-S., Leal F., De Pinho A.F., Marins F.A.S., Marins F.F., De Jesus J.T. (2008) Combined use of modelling techniques for the development of the conceptual model in simulation projects. *Proceedings of the 2008 Winter Simulation Conference* S. J. Mason, R. R. Hill, L. Mönch, O. Rose, T. Jefferson, J. W. Fowler eds., pp. 987-995.
- Moselhi, O. and Alshibani, A. (2007) Crew optimisation in planning and control of earthmoving operations using spatial technologies. *Journal of Information Technology in Construction (ITcon)*, Volume 12, pp. 121-137.
- Nassar, K. (2005) Evolutionary optimisation of resource allocation in repetitive construction schedules. *Journal of Information Technology in Construction (ITcon)*, Volume 10, pp. 265-273.
- Negnevitsky, M and Kelareva, G. (2008) Development of a Multi-Layer Genetic Algorithm for maintenance scheduling in power systems, *Proceedings of IEEE Power Engineering Society (PES) and Distribution Conference and Exposition*, 21-24 April (2008), Chicago, USA, pp. 1-5.
- Pardalos P.M. and Du D. (1998) Network Design: Connectivity and Facilities Location (Series in Discrete Mathematics and Theoretical Computer Science). *DIMACS Series in Discrete Mathematics and Theoretical Computer Science*. Volume 40, American Mathematical society
- Pheng, L.S. and Chuan, C.J. (2000) Just –in-time management in precast concrete construction: a survey of the readiness of main contractors in Singapore. *Journal of Integrated Manufacturing Systems*, 12 (6), pp. 416-429.
- Raychaudhuri, S. (2008) Introduction to Monte Carlo Simulation. *Proceedings of the (2008) Winter Simulation Conference*. S. J. Mason, R. R. Hill, L. Mönch, O. Rose, T. Jefferson, J. W. Fowler eds.
- Selinger S. (1980) Construction planning for linear projects. *Journal of the Construction Division*, 106 (2), June (1980), pp. 195-205
- Senouci, A.B. and Adeli, H. (2001) Resource scheduling using neural dynamics model of Adeli and Park. *Journal of Construction Engineering and Management*, ASCE, 127 (1), pp. 28-34.
- Senouci A.B. and Naji K.K. (2006) A computerised system for scheduling and cost optimization of nonserial linear projects. *Surveying and Built Environment*, July (2000), 17 (2), pp. 49-62.
- Srisuwanrat C. and Ioannou P.G. (2007) Optimal scheduling of probabilistic repetitive projects using completed unit and genetic algorithms. *Proceedings of the 2007 Winter Simulation Conference*, S. G. Henderson, B. Biller, M.-H. Hsieh, J. Shortle, J. D. Tew, and R. R. Barton, eds., pp. 2151-2158.
- Watkins, M. Mukherjee, A., Onder, N. and Mattila K. G. (2007) Understanding labour productivity as an emergent property of individual and crew interactions on a construction site. *Processing IGLC-15*, July, Michigan, USA
- Zhang H. , Li H. (2004) Simulation-based optimisation for dynamic resource allocation. *Journal of Automation in Construction*, Volume 13, pp. 409-420