

# High-Thrust in-Space Liquid Propulsion Stage: Storable Propellants

*Etienne Dumont, Alexander Kopp, Carina Ludwig, Nicole Garbers*

*DLR, Space Launcher Systems Analysis (SART), Bremen, Germany  
Etienne.Dumont@dlr.de*

## Abstract

In the frame of a project funded by ESA, a consortium led by Avio in cooperation with Snecma, Cira, and DLR is performing the preliminary design of a High-Thrust in-Space Liquid Propulsion Stage for two different types of manned missions beyond Earth orbit. For these missions, one or two 100 ton stages are to be used to propel a manned vehicle. Three different propellant combinations; LO<sub>x</sub>/LH<sub>2</sub>, LO<sub>x</sub>/CH<sub>4</sub> and MON-3/MMH are being compared.

The preliminary design of the storable variant (MON-3/MMH) has been performed by DLR. The Aestus II engine with a large nozzle expansion ratio has been chosen as baseline. A first iteration has demonstrated, that it indeed provides the best performance for the storable propellant combination, when considering all engines available today or which may be available in a short- to medium term. The RD-861 K engine has been proposed as alternative to reduce the development duration of the high-thrust stage. Structure analyses and optimisations have converged towards a common bulkhead architecture with a Whipple shield, similar to the one used on the ATV, to protect the main propellant tanks against perforations caused by meteoroids and space debris. The propulsion system has been built around six Aestus II engines equipped with TVC and placed on a circular engine thrust frame. The RCS, the thermal system, and the power system have also been included in the preliminary design, and they have been sized for the most demanding mission. The performance of the high-thrust stage, resulting from the preliminary design, has been assessed for both missions taken into consideration.

## Nomenclature

Isp	specific impulse	s
m <sub>dot</sub>	propellant mass flow rate	kg/s
ΔV	velocity increment	m/s

## Subscripts, Abbreviations

ATV	Automated Transfer Vehicle
CDF	Concurrent Design Facility
ECSS	European Cooperation on Space Standardization
Elec assy	electronic assembly
EPS	Etage à propergols stockables (Ariane 5's storable propellant stage)
GNC	Guidance Navigation and Control
HTS	High-Thrust Stage
IF	Interface
ISS	International Space Station
LEO	Low Earth Orbit
LEOP	Launch and Early Orbit Phase
LH <sub>2</sub>	Liquid Hydrogen
LO <sub>x</sub>	Liquid Oxygen
MLI	Multi-Layer Insulation
MMH	Monomethylhydrazine
MON-3	Mixed Oxides of Nitrogen (97% N <sub>2</sub> O <sub>4</sub> + 3% NO)
PMD	Propellant Management Device
RCS	Reaction Control System
RCT	Reaction Control Thrusters
SHLLV	Super Heavy Lift Launch Vehicle
TVC	Thrust Vector Control
UDMH	Unsymmetrical Dimethylhydrazine
vac	vacuum
VENUS	Vega New Upper Stage

## 1. Introduction

Following the precursor NEMS (Near Earth Exploration Minimum System) assessment, conducted by ESA in its Concurrent Design Facility (CDF) in 2011 [5], a study on "high thrust in space advanced liquid propulsion stages" (ITT AO/1-7037/11/NL/NA) has been funded. ESA has created this study in order to assess in more detail the advantages and drawbacks of different propellant

combinations for transfer stages applied to manned missions beyond the Earth orbit. Since late 2012, a consortium led by Avio in cooperation with Snecma, Cira and DLR has been performing the study. Each of the partners is responsible for a different propellant combination; Snecma for LO<sub>x</sub>/LH<sub>2</sub>, Cira for LO<sub>x</sub>/CH<sub>4</sub>, and DLR for MON/MMH. The goal, defined by ESA, is to perform a design maximizing the velocity increment for a maximum stage mass of 100 tons. Some requirements have been formulated by ESA such as the ability to perform two different types of missions. In the first mission (mission A), two of these stages are injected separately on a 400 km circular orbit with 28° inclination by a new SHLLV (Super Heavy Lift Launch Vehicle). After an automatic docking, they are joined by a manned assembly consisting of a crew module and an additional storable propulsion stage (see Figure 1). In the second mission (mission B) a single transfer stage is used and joined by a larger manned assembly. The mission timelines and orbital manoeuvres to be performed have been set by AVIO based on ESA requirements. Propellant-independent subsystems such as avionics or telecommunication equipment have been defined as well by the prime contractor, in order to enable a meaningful comparison between the three vehicle designs based on different propellant combinations.

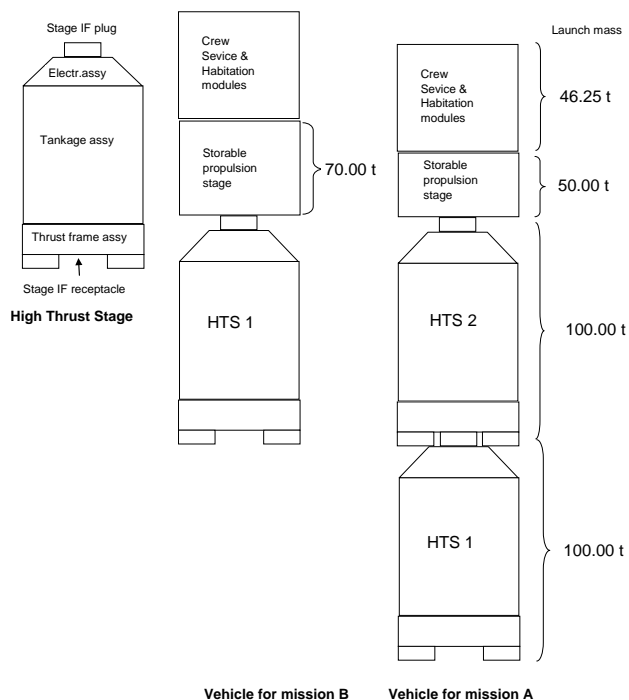

Figure 1: High-thrust stage architecture and vehicle architecture for missions A and B (source AVIO)

The project is built around five main phases, of which the first two have now been completed. In the first phase an exhaustive list and analysis of worldwide high thrust based systems, mainly rocket stages, has been generated.

Based on its results, a preliminary design of the vehicle has been generated in the second phase. The third phase will consist of detailed preliminary design, for which the main subsystems will be the object of specific numerical analyses. The fourth and fifth phases will analyse in more detail the performance and reliability of the vehicle, as well as the programmatic aspects. This project is expected to be completed at the end of 2014.

The current status of the preliminary design of the version based on MON/MMH is summarised in this paper. It considers the following subsystems: engine, TVC, feed system, structure, GNC/RCS, thermal system, meteoroid and debris shielding, power system and accommodation. Propellant mass budgets have also been assessed. In addition, a preliminary estimation of the safety and costs has been performed, but is not presented here.

## 2. Scope

The particularity of this project compared to “traditional”, “in-space” propulsion is that thrust levels in the range of several hundreds of kilo-newtons up to one mega-newton are reached by the combination of several engines. This is required to propel a combination of 100 ton stages and their payload from a parking low Earth orbit (LEO) beyond Earth orbit. These stages should be designed to reach low gravity wells such as near-Earth asteroids, and also for transfer towards deeper wells such as the Moon and Mars. Of particular interest is the influence of the propulsion system on the whole system, as LO<sub>x</sub>/LH<sub>2</sub>, LO<sub>x</sub>-CH<sub>4</sub>, and MON-MMH have very different characteristics in terms of performance, storability, and density. An overview of the results of the second phase of this study for the different propulsion systems (LO<sub>x</sub>-LH<sub>2</sub>, LO<sub>x</sub>-CH<sub>4</sub> and MON-MMH) can be found in [6].

## 3. General architecture and missions

A modular architecture, independent of the propellant combination, has been proposed by AVIO for the high-thrust transfer stage. It consists of three main assemblies which should be produced to a large extent independently, before being put together. As seen in Figure 1, the first assembly from the bottom is the thrust-frame assembly which includes mainly the engines, engine equipment and the thrust-frame structure. The second assembly is the tankage assembly. It is mainly made out of the equipped tanks. The last and third assembly is the electronic assembly, where the avionic and other electronic subsystems are accommodated. Each high-thrust stage has interfaces on both the top and the bottom side. On the bottom side, the interface is part of the thrust-frame assembly. Its purpose is to connect the high-thrust stage with the SHLLV during launch. The bottom side also

features an interface to enable the docking of another high-thrust stage, as planned in the mission A. It has not yet been decided if the same interface can be used for the connection between the high-thrust stage and the SHLLV, and the connection between two high-thrust stages, or if two different interfaces will be preferred. Another interface is placed on the upper end of the high-thrust stage and is part of the electronic assembly. It provides a connection to the manned assembly or to another high-thrust stage in the case of a mission with several high-thrust stages.

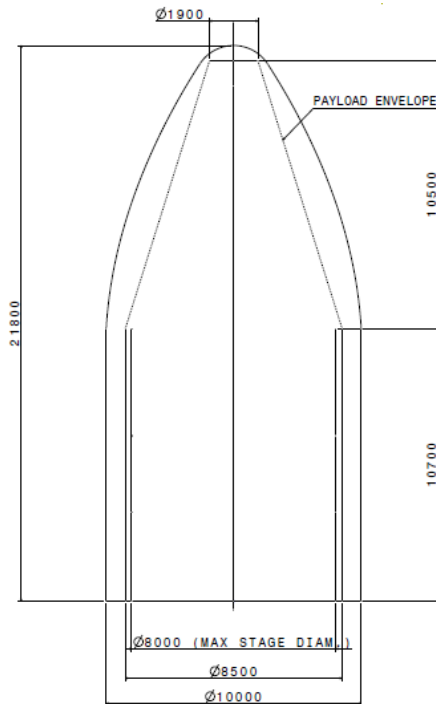

Figure 2: SHLLV fairing envelope applicable to the high-thrust stage

The high-thrust stage is to be designed to fulfil two different missions. In mission A, two high-thrust stages are launched one after the other into a parking orbit 400 km above sea level with an inclination of 28°. After performing a docking manoeuvre, the stack consisting of the two stages is joined by a manned assembly. The latter consists of a 50 ton storable-propulsion stage and a 46.25 ton crew service and habitation module (see Figure 1). Once this third element is docked with the two high-thrust stages, the lower high-thrust stage is ignited for the transfer boost. The second high-thrust stage is ignited once the first one is empty and jettisoned. Note that during the phase in the parking orbit, the lower stage is responsible for the attitude control and docking manoeuvre with the manned assembly. The same high-thrust stage should also be able to perform the mission B, which makes use of a single high-thrust stage. In this mission, the high-thrust stage is launched first by the SHLLV into a parking orbit (400 km circular, 28°). It is joined later by a manned assembly consisting of a 70 ton storable propulsion stage

and a 46.25 ton crew service and habitation module (see Figure 1).

The limitations imposed on the high-thrust stage are twofold: the mass and the geometry. Specifically, the SHLLV is defined as able to launch a maximum of 100 tons to the parking orbit (400 km circular, 28°) and its fairing (see Figure 2) allows for the accommodation of a stage which, in its larger part should not exceed 8 m in diameter, and in its longer dimension should not exceed 21.2 m.

#### 4. Propulsion

In the preliminary design, the number of engines has been set to six for each of the three propellant combinations. Analyses are on-going to determine the reliability reduction linked to the use of a lower number of engines. Two different options have been considered. In the first option, an engine, built completely by ESA member states, has been selected. The second option is based on an engine without restriction on its origin; the goal being to allow international cooperation and to decrease the development time for the vehicle.

##### 4.1. Engine from the ESA member states

Currently, the largest engine running on storable propellant produced in the ESA member states is the Aestus engine, used on the upper stage of Ariane ES, which launches, for example, the Automated Transfer Vehicle (ATV) to the ISS. It is a pressure-fed engine and it delivers a thrust of 29.6 kN at a vacuum Isp of 324 s. This engine is well-adapted if the propellant mass is limited. In the case of Ariane 5's EPS stage, the propellant mass is about 10 tons. For higher propellant masses, due to the fact that the propellant tanks have to be maintained at a high pressure, the tank mass penalty becomes relatively important. Larger, very successful storable-propellant turbo-pump-fed engines were produced for Ariane 4, namely the Viking family; however they have not been either in production or in use in Europe since 2003, the last launch of Ariane 4.

However, work was conducted for the development of an evolution of the Aestus engine, namely the so-called Aestus II engine (Figure 3). This engine, also known as RS-72 and developed as a prototype by EADS Astrium and Pratt and Whitney, is based on a thrust chamber derived from the one used for the Aestus engine and an evolution of the XLR-132 turbopump. It has a thrust of about 55 kN and a vacuum Isp between 336 s and 340 s depending on the nozzle expansion ratio. Different nozzles have been considered for this engine with expansion ratios between 280 and about 450, in the frame of the VENUS (Vega New Upper Stage) study [8] and [9].

The aim of the design was to develop a high-performance engine, which, as a consequence, has no significant throttleability. The development programme stopped after successfully performing tests up to 60 s at full thrust at NASA White Sands Facility with MMH/NTO and MMH/MON-3. The design lifetime of this engine was planned to be 2500 s and with several re-ignitions. According to the HEUS study, in which a new upper stage was designed for the Space Shuttle [2], the Aestus II engine could be qualified in only 28 months, providing the availability of the thrust chamber and turbo-pump. In the case of an engine produced in the ESA-member states, a new turbopump would also have to be designed, which would increase the development time.



Figure 3: Aestus II (RS72) (source Astrium)

#### 4.2. Engine produced outside the ESA member states

An alternative option to reduce the development time would be to use an existing engine or an engine, the development of which is completed [7]. Considering all of the engines available worldwide apart from the ESA member states, the RD-861 K engine developed by Yuzhnoye SDO for the Cyclone 4 launch vehicle appears to be the most suitable in terms of thrust level and performance. It provides a thrust of about 77.6 kN and an Isp of 330 s in vacuum [7]. Using a larger nozzle, DLR has estimated that a vacuum Isp of about 337 s could be reached.

#### 4.3. Engine characteristics

The main characteristics of the Aestus II engine and of the RD-861 K engine are summarised in Table 1. The performance of the high-thrust stage has been determined for each of the four engine options presented in Table 1. The Aestus II engine with the large nozzle (expansion ratio 447.5) has been selected as baseline due to the resulting higher stage performance.

Note that in addition to the specific impulse, another characteristic has a big influence on the choice of the engine: the transient propellant mass required for the engine ignition and shut-down. Furthermore, a requirement set for the preliminary design is to consider ten engine

ignitions for each engine during the whole mission. The corresponding transient propellant mass cannot be neglected, as it amounts several tons of propellant.

Table 1: Aestus II and RD-861 K main characteristics (source: Astrium, Yuzhnoye [7] and DLR computations)

Propellant	Aestus II		RD-861 K	
	MMH/MON-3	UDMH/MON-3	normal	long
Nozzle	short	long	normal	long
Pcc [bar]	60		88.8	
Thrust [kN]	55	55.6	77.6	79.3
Isp vac [s]	336.4	339.6	330	337.2
Expansion ratio [-]	280	447.5	≈ 155	450
m_dot [kg/s]	16.7		24	
Mass [kg]	139	149	207	≈ 235

#### 4.4. Engine thrust vector control and accommodation

Several options have been considered for the thrust vectoring such as:

- Gimbaling with TVC,
- Fixed nozzle with vector-able gas generator exhaust nozzle,
- Fixed main engine nozzle with vector-able or throttle-able smaller engine, and
- Asymmetric thrust through throttling or ON/OFF modulations.

A trade-off performed for the Aestus II engine has led to the selection of gimbaling with TVC, which is currently the most classical solution in Western Europe. A maximum gimbaling angle of  $\pm 5^\circ$  has been selected. Considering additional margin and the space needed to dock two high-thrust stages, the engines have been placed on circular engine thrust frame with a diameter of 6 m.

## 5. Preliminary structural design and optimisation

The structure has been designed to resist strength and stability failure while maintaining a low structural mass. In addition, the Eigen-frequencies have to remain above the predefined minimum values: 7.5 Hz for the lowest bending Eigen-frequency and 27 Hz for the lowest longitudinal Eigen-frequency. Computations have been performed with DLR in-house tools: LSAP (Launcher Structural Analysis Program) for the static structural analysis, design and optimisation; and BSAX (Beam Stiffness and Aero matriX) for the determination of the Eigen-frequencies.

Based on preliminary analyses, it has been determined that the tanks should be designed to store about 90 tons of propellant. A variation of the tank diameter between 3.5 m and 5 m has been performed to determine for which value the structural mass is the lowest. Some dimensions are, however, fixed. Specifically, the diameter of the upper interface is 1 m, while the length of the electronic

assembly is 4 m. The length of the engine thrust frame has been set to 1.5 m which is sufficient to accommodate the RCS tanks and other engine equipment. The baseline design utilises an Aluminium-Lithium (2195T8R78) alloy. Aluminium-Lithium has been selected in favour of classical Aluminium due to its superior specific stiffness ( $E/\rho$ ) and specific strength ( $\sigma/\rho$ ). Due to possible reactions between the tank walls and MON-3, a liner is necessary. This will be analysed in more details during the following phases.

Configurations using monocoque, honeycomb, and stringer/frame-stiffened structures have been compared. The position of the MMH and MON tanks has been varied. Common bulkhead architectures only have been considered. In total over 20 configurations have been analysed and sized for the six identified loads cases. These load cases occur during the launch and during the mission themselves. Both mission A and B have been considered.

Analyses have shown that in all cases the stringer- and frame-stiffened structures are heavier than the monocoque variants. Using honeycomb for the engine thrust frame and the electronic assembly could help to reduce the structural mass. However, in this case, the Eigen-frequencies are lower than the requirements. The lowest structural mass has been obtained for a tank structure with 4 m in diameter and the MMH tank placed above the MON-3 tank, with pressure of 5 bar and 6.6 bar respectively. A sketch of the geometry can be seen in Figure 4. The main dimensions of the stage are summarised in Table 2. The total mass of the bare structure has been estimated to be about 2.8 tons.

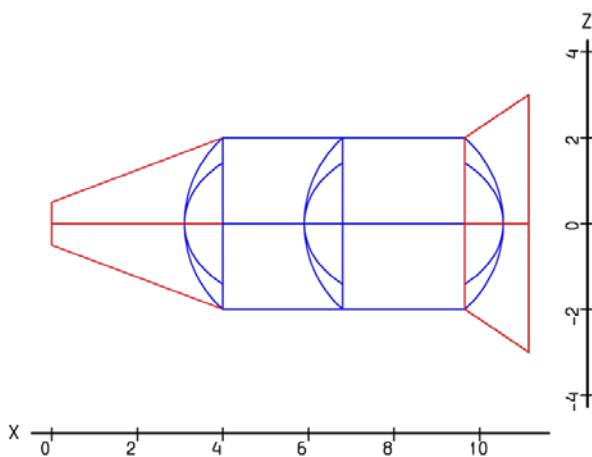

Figure 4: Sketch of the optimal high-thrust stage geometry

Table 2: Main dimensions of the optimal high-thrust stage geometry

Length elec assy [m]	Length upper tank [m]	Length lower tank [m]	Length thrust-frame [m]	Total length [m]
4.0	2.8	2.85	1.5	11.15

As seen in Figure 5, a conical structure has been placed in the centre of the engine thrust frame assembly. Its role is to allow the connection of two high-thrust stages as planned for the mission A. This is the only possible solution due to the geometry of the high-thrust stage. Concerning the connection between the stage and the launcher during the launch phase, different concepts are currently being studied. One possibility is to reuse the same interface for stage/launcher connection as for stage/stage connection. The second option considers an additional ring attached to the aft skirt via truss structures as seen in Figure 6. The final choice of the structural interface will be performed in the following phases.

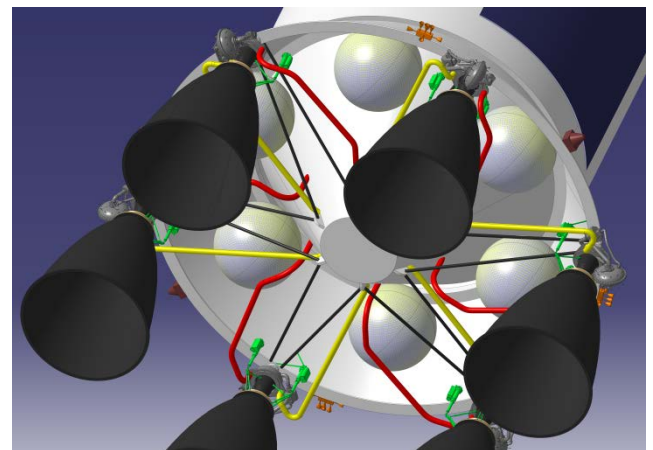

Figure 5: View of the thrust frame assembly and central docking interface

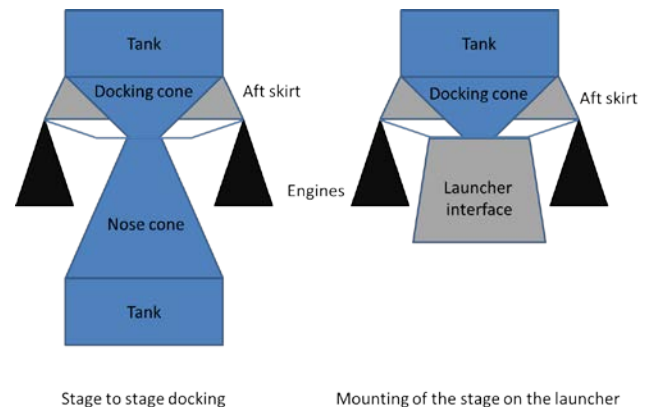

Figure 6: Sketches of structural interface concepts

## 6. Subsystems

### 6.1. Main tanks and pressurisation system

A common bulkhead architecture has been selected for the main propellant tanks. This is the mass-optimal solution and it does not lead to particular problems during coasting phases as MON-3 and MMH can be stored at similar temperature. As explained in section 5, it has been decided

for mass reason to place the  $\sim 35 \text{ m}^3$  MMH on top of the  $\sim 47 \text{ m}^3$  MON-3 tank (see Figure 7). Slightly more than 90 tons of propellant with a mixture ratio of 2.09 can be stored in the tanks. In order to save mass and avoid the necessitation of a propellant management device (PMD), a propellant settling manoeuvre is performed with the RCT prior to each main engine ignition.

During the entire mission the MMH and MON-3 tanks are kept at 5 bar and 6.6 bar, respectively. A helium vessel is required to store the 100 kg of helium needed for the pressurisation of the main propellant tanks. The diameter of the helium vessel is about 1.8 m and the MEOP is 400 bar. It is placed in the electronic assembly (see Figure 7).

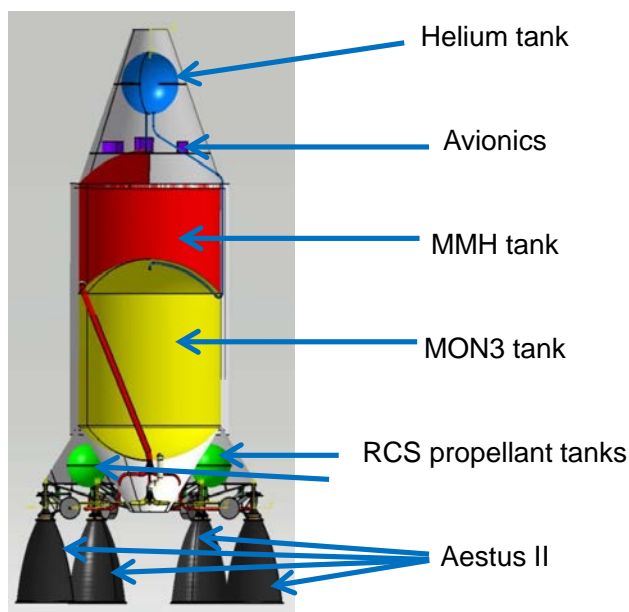

Figure 7: Cross section of the HTS (CAD model)

### 6.2. GNC and RCS

The preliminary design of the GNC/RCS should allow 3-axis stabilisation for the high-thrust stage delivery and the LEOP. The following orientations have been defined:

- Inertial pointing with stage side to the Sun for the flight of an individual stage or of the assembly of two high-thrust stages during parking and coasting phases,
- Gravity gradient oriented for the vehicle fully integrated, and
- Aligned with the orbit velocity vector for the rendezvous and docking manoeuvres.

The main requirement for the sizing of the RCT is the ability to perform a  $180^\circ$  reorientation in-plane manoeuvre in 800 s. A blow-down system based on four clusters of seven 22 N bi-propellant thrusters has been selected. Additionally, four other clusters of two 22 N bi-propellant thrusters are accommodated on the stages in order to perform all the required manoeuvres including the settling

of the propellant in the main tanks prior to main engine ignition. The selected thrusters produced by Astrium utilise MMH and NTO at a mixture ratio of 1.65 [3]. Due to the fact that the propellant inlet pressure required by the thrusters to deliver their maximal performance is much higher than the pressure available in the main tanks, the RCT are fed by separate tanks, located in the engine thrust frame assembly (see Figure 7 and Figure 8).

The dimensioning case for the RCS of the high-thrust stage is the first stage of the mission A, which has to remain in the parking orbit for a relatively long period of time. The most pessimistic case defined by AVIO has been considered and a margin applied.

Three types of manoeuvres have to be performed by the RCS: the compensation of the gravity torque, the compensation of the aerodynamic torque, and in-orbit manoeuvres such a stage reorientation or altitude changes. The compensation of the gravity torque is particularly propellant intensive, especially when the two stages of the mission A are docked and are inertially stabilised with the solar panels oriented towards the Sun. This phase can last over 24 days according to the preliminary mission timeline. The amount of propellant required for the compensation of the aerodynamic torque is much lower. The determination of the aerodynamic torque has been performed in the free molecular flow condition at an altitude of 400 km with the help of the DLR internal program Satdrag 2.01. For the third type of manoeuvre; the in-orbit manoeuvres, a trade-off has shown that due to the higher specific impulse of the main engines and despite the relatively high transient propellant mass required for each ignition, the use of two symmetrically-opposed main engines is preferred over the use of the RCT for altitude changes. In total, three altitude changes manoeuvres are required for the first stage of the mission A. Re-orientation manoeuvres are performed with the RCT.

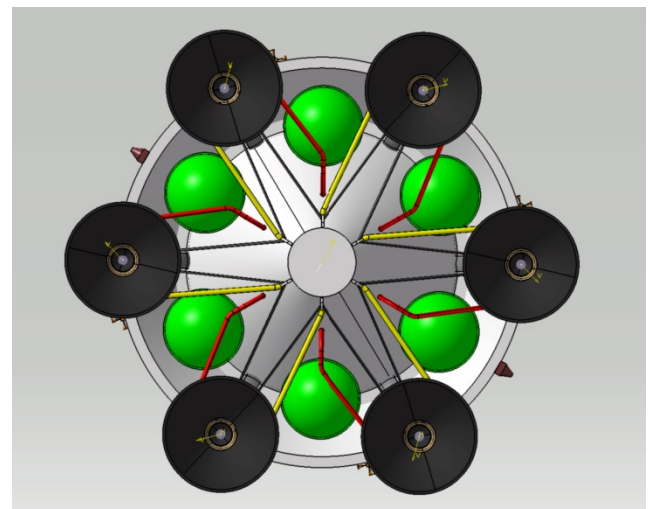

Figure 8: RCS tanks (in green) placed in the engine thrust frame assembly

In the case of the first stage of the mission A which is the dimensioning one, about 2.7 tons of propellant is needed from the main tanks for the altitude change manoeuvres. For the other manoeuvres and the attitude control, slightly more than 4 tons of MMH/NTO is required. The RCS propellant is stored in six identical spherical tanks (see Figure 7 and Figure 8). Each tanks as a radius of 56 cm. Three tanks are filled with MMH and three are filled with MON-3. All tanks are used in blow-down mode.

### 6.3. Thermal

A preliminary thermal analysis has been performed to verify if the different components of the stage and the propellant remain within their respective operational temperature ranges. In particular, it is important to avoid propellant freezing. This is achieved with the help of heaters with a maximal thermal power of 2500 W. In addition, MLI is used to cover the high-thrust stage and absorb temperature variations. The total mass of the thermal subsystem has been estimated to be about 165 kg.

### 6.4. Power

A preliminary power design has been performed to guarantee that the high-thrust stage is able to supply its equipment with energy until the completion of the vehicle assembly. Afterwards power generation and control capabilities are passed under the control of the manned section of the vehicle. The power source is a set of body-mounted solar panels installed on a sector of the cylindrical surface of the stage (see Figure 9). This solar panel is maintained oriented towards the Sun when the stages are on parking orbit and before the completion of the vehicle.



Figure 9: Side view of the high-thrust stage (body mounted solar panel in blue)

In addition to the 1500 W, which is required for the different subsystems independently of the selected

propellant, up to 2500 W has to be delivered to heat up the propellants, in particular the MON-3 which freezes at  $-15^{\circ}\text{C}$ . To power components such as the valves and TVC which have a time limited power demand, rechargeable lithium-batteries are used. The power generation is undertaken by the body-mounted solar panels which can deliver up to 4000 W when the high-thrust stage is optimally oriented. This has been deemed sufficient even when Earth shadow time is considered.

### 6.5. Avionic

The telecommunication system and on-board computer have been considered as nearly invariant with respect to the propulsion system. Consequently, the mass budget has been considered to be independent of the propellant combination (LOX/LH<sub>2</sub>, LOX/CH<sub>4</sub> or MON/MMH) and has been set by AVIO.

### 6.6. Shielding

The risk assessment due to meteoroids and debris penetration utilised for the sizing of the shielding is based on ECSS methods [4]. The determination of the mass and velocity distribution for all sources of impact (debris, meteoroids and meteoroid streams according to the Jennikens –Mc Bride model) have been determined with the help of the ESA program Master-2009. Particles with a mass situated between 0.01 g and 20 kg have been considered (see Figure 10 and Figure 11). The most sensitive parts of the high-thrust stage are the propellant tanks. A perforation of one of the tanks would lead to a major failure as the propellant would, in the best scenario, escape through the hole and the pressure would decrease. In the worst case, both tanks would be perforated and propellant would enter into contact, leading to an uncontrolled ignition. To avoid such a problem, a Whipple shield is required to project the cylindrical part of the tanks. The lower and upper domes are already protected by the upper and lower cones. Engine feed-lines are protected by the lower skirt.

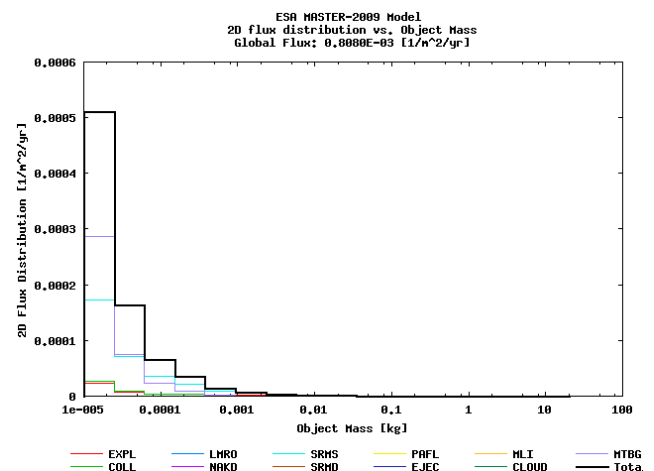

Figure 10: Space debris mass distribution at 400 km altitude (epoch May 1st, 2009)

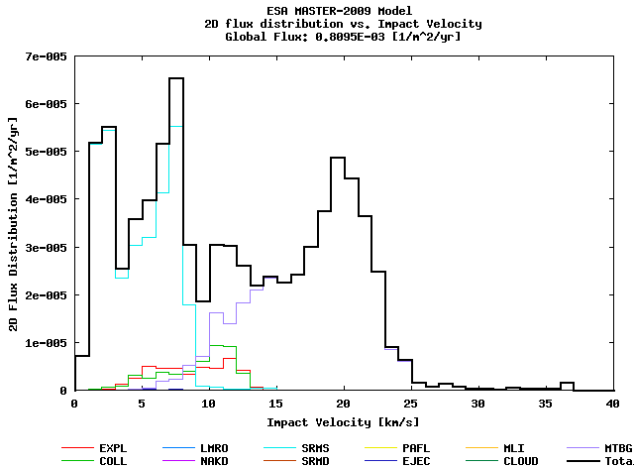

Figure 11: Space debris velocity distribution at 400 km altitude (epoch May 1st, 2009)

Shielding similar to that of the ATV has been selected as a baseline [1]. The selected Whipple shield consists of a bumper made out of aluminium alloy (Al 5083) with a thickness of 1.2 mm situated 120 mm away from the tank wall. It is covered by a  $\beta$ -cloth reinforced MLI. Between the bumper and the tank wall intermediate layers are placed 24 mm away from the tank wall. These intermediate layers consist of two layers of ceramic fabric Nextel 312 AF-10 and three layers of Kevlar KM2 SEAL364 wrapped with Single Aluminized Kapton. Taking into account the relatively-thick tank walls, such a shielding is sufficient to fulfil the requirement in term of perforation risk. The total mass of the shield for a high-thrust stage has been estimated around to be 350 kg.

## 7. Performance

Based on the preliminary design described in the previous sections, the performances of the stages have been determined. In the case of the first stage of the mission A, which is the dimensioning stage for the RCS and the shielding, about 86 tons of propellant are tanked up in the main tanks to reach the limit gross lift-off mass of 100 tons. The stage of the mission B and the second stage of the mission A, however, stay for a shorter time in the parking orbit and their RCS propellant requirement is thus strongly reduced. This is especially the case for the second stage of the mission A which has only very few in-orbit manoeuvres to perform. Consequently, it has been proposed to reduce the loaded RCS propellant mass and the number of RCS tanks. In the case of the stage for the mission B, it has been estimated that two of the six RCS tanks can be discarded. For the second stage of mission A, just two RCS tanks would be sufficient. As the main tanks have been sized to contain up to 90 tons of propellant, the loaded propellant mass of the main propellant tanks is adapted to reach, in each case, a high-thrust stage gross lift off mass of exactly 100 tons. For the determination of the

achievable  $\Delta V$ , 5% margins have been taken into account. The results at the end of the phase 2 preliminary design for the concept based on the Aestus II engine with an expansion ratio of 447.5, are summarised in Table 3. It has been estimated that the total  $\Delta V$  provided by the two high-thrust stages of the mission A is about 3 km/s, of which more than one third comes from the first stage. Due to the higher mass of the manned assembly in the mission B with respect to the mission A, and the additional manoeuvres performed by the high-thrust stage in the mission B with respect to the second stage of the mission A, the total  $\Delta V$  provided by the HTS is slightly less than 1.7 km/s.

Table 3: Calculated  $\Delta V$  provided by each stage based on phase 2 preliminary design with Aestus II engines (expansion ratio 447.5)

	Mission A 1 <sup>st</sup> HTS	Mission A 2 <sup>nd</sup> HTS	Mission B HTS
Propellant mass for altitude increase [tons]	2.8	0	0
Propellant mass for transfer [tons]	83.3	89.9	87.5
$\Delta V$ [km/s]	1.1	1.9	1.7

## 8. Conclusion

The preliminary design of the high-thrust stage with the storable propellant combination has been successfully completed. Two high-performance engines, corresponding to different requirements in term of origin and qualification time have been selected: the Aestus II and the RD-861 K engines. The architecture and the structure of the high-thrust stage have been sized and optimised. For the main tanks, a monocoque, common-bulkhead architecture has been selected. A preliminary sizing of the pressurisation system, the RCS, the thermal system, the power system and the impact shield has been performed. At the end of the preliminary design, it appears that the storable propellant version of the high-thrust stage is competitive with the LOx/LH2 and LOX/CH4 variant. For the mission A, a  $\Delta V$  of 3 km/s can be expected. For the mission B, the maximum  $\Delta V$  provided by a high-thrust stage is estimated to around 1.7 km/s. Further analyses and work will be performed in the following months to refine the design. Numerical methods will be used in particular for the structure and thermal design. Additionally, cross-checks will be performed to guarantee that the three stages designed for the three propellant combinations are perfectly comparable.

## 9. Acknowledgements

This work has been performed within the “high thrust in space advanced liquid propulsion stages” project (ITT



AO/1-7037/11/NL/NA), coordinated by AVIO, and funded by ESA.

The authors acknowledge the support by Mr. Jan Demming, Mr. Maxime Mongheal, Ms. Vanessa Clark and Mr. Johann Mokstadt.

## 10. References

- [1] Destefanis, R.; Lambert, M.; Schäfer, F.; Drolshagen, G.; Francesconi, D.: Debris Shielding Development for the ATV Integrated Cargo Carrier, 18-20 April 2005, *Fourth European Conference on Space Debris*, Darmstadt, Germany, ESA SP-587.
- [2] Dressler, G.; Matuszak, L.; Stephenson, D.: Study of a High Energy Upper Stage for Future Shuttle Missions, 20-23 July 2003, *39<sup>th</sup> AIAA Joint Propulsion Conference and Exhibit*, Huntsville, USA, AIAA-2003-5128.
- [3] Gotzig, U.; Dargies, E.: Development Status of Astrium New 22 N bipropellant thruster family, 20-23 July 2003, *39th AIAA Joint Propulsion Conference and Exhibit*, Huntsville, USA, AIAA 2003-477.
- [4] N.N. ECSS: European Cooperation for Space Standardization. Space Engineering, Space Environment, 15 November 2008, ECSS-E-ST-10-04C.
- [5] N.N. ESA: CDF Study Report NEMS – Near Earth Exploration Minimum System Assessment, May 2011, CDF-114(A)
- [6] Schonenborg, R. ; Galvez, A.; Carnelli, I.; Hufenbach, B.; Balduccini, M.; Tontini, R.; Dumont, E.; Lassoudiere, F.; Berend, N.; Salvatore, V.; Onofri, M.; Trollier, T.: High Thrust in Space Advanced Liquid Propulsion Stages: Avio Consortium, 19<sup>th</sup> – 22<sup>nd</sup> May 2014, *Space Propulsion 2014*, Cologne, Germany, ID 2969023.
- [7] Shnykin, V.; Shul’ga, V.; Strel’chenko, E.; Kovalenko, V.; Kovalenko, A.; Konokh, V.; Ivchenko, L.; Nikishchenko, I.; Kalinichenko, I.; Khromiuk D.: RD861K Liquid Rocket Engine Characteristics and development state, 2012, *Space Propulsion 2012*, Bordeaux, France.
- [8] Sippel, M., Dumont, E; Dietlein, I.: Investigations of Future Expendable Launcher Options, 2011, *62<sup>nd</sup> International Astronautical Congress*, Cape Town, South Africa, IAC-11-D2.4.8.
- [9] Wisse, M., Obermaier, G., Dumont, E.; Ruuwe T.: VENUS – Conceptual design for Vega New Upper Stage, 2011, *62<sup>nd</sup> International Astronautical Congress*, Cape Town, South Africa, IAC-11-D2.3.4.

Further updated information concerning the SART space transportation concepts is available at:

<http://www.dlr.de/SART>