



University of HUDDERSFIELD

University of Huddersfield Repository

Crua, C., Stetsyuk, V., de Sercey, G. and Turner, J.

Droplet and liquid size measurements in the near-nozzle region

Original Citation

Crua, C., Stetsyuk, V., de Sercey, G. and Turner, J. (2015) Droplet and liquid size measurements in the near-nozzle region. In: ECN4 Workshop, 5-6 Sept 2015, Kyoto University, Kyoto Japan.

This version is available at <http://eprints.hud.ac.uk/27246/>

The University Repository is a digital collection of the research output of the University, available on Open Access. Copyright and Moral Rights for the items on this site are retained by the individual author and/or other copyright owners. Users may access full items free of charge; copies of full text items generally can be reproduced, displayed or performed and given to third parties in any format or medium for personal research or study, educational or not-for-profit purposes without prior permission or charge, provided:

- The authors, title and full bibliographic details is credited in any copy;
- A hyperlink and/or URL is included for the original metadata page; and
- The content is not changed in any way.

For more information, including our policy and submission procedure, please contact the Repository Team at: E.mailbox@hud.ac.uk.

<http://eprints.hud.ac.uk/>

Topic 2: Droplet and liquid size measurements in the near-nozzle region

**Cyril Crua*, V. Stetsyuk, G. de Sercey – University of Brighton
S. Som, C. Powell, A. Kastengren – Argonne National Laboratory**



- ❖ Droplet size measurements by long-distance microscopy
 - University of Brighton: Cyril Crua, Viacheslav Stetsyuk, Guillaume de Sercey

- ❖ Droplet size measurements by Ultra-Small Angle X-ray Scattering
 - Argonne National Laboratory: Chris Powell, Alan Kastengren

- ❖ Atomization and mixing at elevated conditions
 - University of Brighton: Cyril Crua
 - Sandia National Laboratories: Julien Manin, Lyle Pickett



1. Objectives
2. Measurement techniques
3. Spray A measurements
4. Comparison with Spray B
5. Effect of gas pressure and temperature
6. Experimental conclusions and future directions

USAXS setup based on Powell et al. (2013) *ILASS Americas*

- ❖ Use USAXS to probe average droplet size
- ❖ Measure number of x-rays scattered as a function of angle
- ❖ Slope of curve depends on the shape of the scatterers (rod, plate, sphere)
- ❖ Absolute magnitude of the scattering depends on the surface area of the scatterers
- ❖ Measured density using radiography
- ❖ Can determine Sauter Mean Diameter (diameter of a sphere with the same volume/surface area ratio)
- ❖ Measurements are pathlength integrated, space-resolved, and time-averaged over the steady-state period of injection
- ❖ Beam size: 100×500 μm

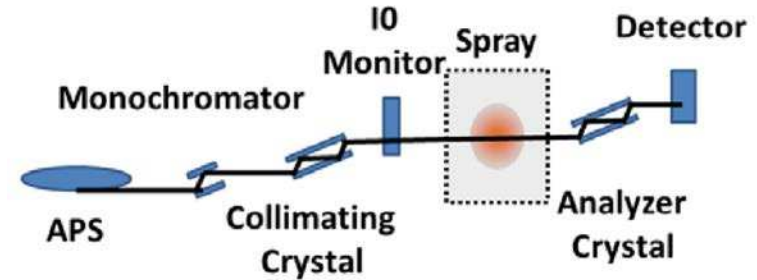

Calculated SAXS signal from spheres and rods

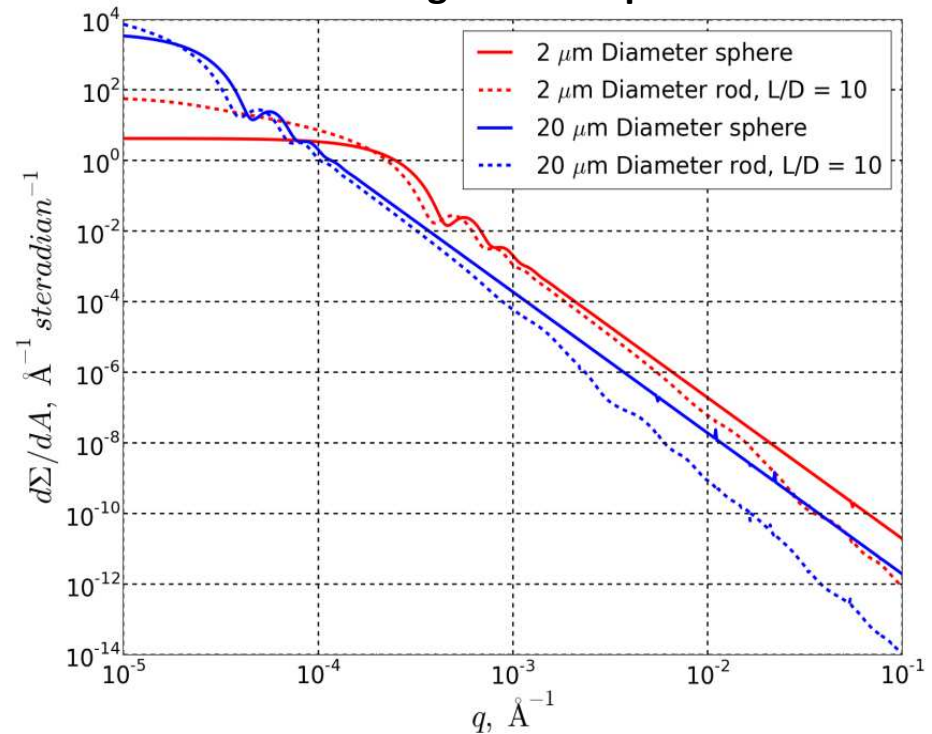

Shadowgraphy setup based on Crua et al. (2015) *Fuel* 157 [doi.org/4F3](https://doi.org/10.1016/j.fuel.2015.07.043)

- ❖ Record shadowgraphs of the sprays
- ❖ We measure droplet size and (when possible!) velocity by image processing
- ❖ Camera: dual-frame 29 megapixel (ROI = 4400×6600 pixels)
- ❖ Scale factor: 0.56 $\mu\text{m}/\text{pixel}$ (ROI = 2.46×3.70 mm)
- ❖ Resolution: 2 μm at 10% contrast (at optimum conditions)
- ❖ Space and time-resolved measurements

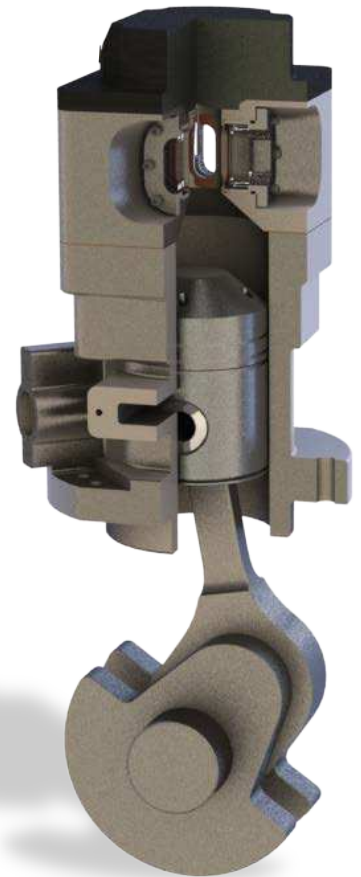
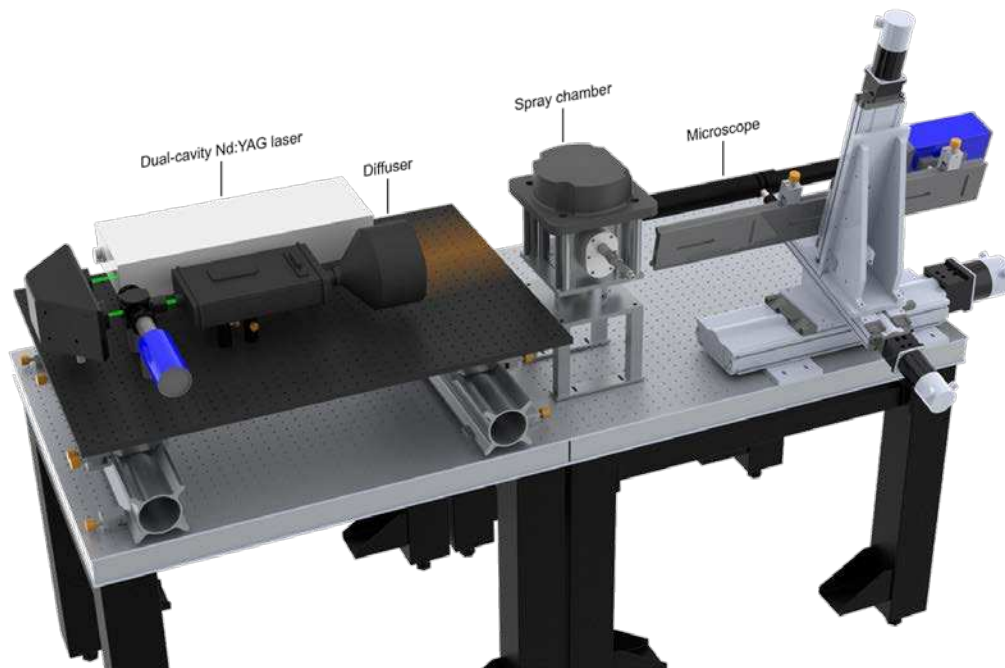



1. Objectives
2. Measurement techniques
- 3. Spray A measurements**
4. Comparison with Spray B
5. Effect of gas pressure and temperature
6. Experimental conclusions and future directions



Parametric variations for USAXS

❖ Injector Spray A #210679

❖ Some deviations from the standard 'Spray A' conditions

Exp. Priority	5	1	4	2	7	3	6
	Oxygen	Temperature [K]	Density [kg/m ³]	Inj. Pressure [bar]	Fuel	Inj. Duration [ms]	Nozzle
Spray A standard	0%	900	22.8	1500	n-dodecane	1.5	0.090 mm, axial hole
2	21%	800	15.2	1000	n-heptane	4	3-hole, 145 angle, Spray B
3	13%	1000	7.6	500	77% n-dodecane, 23% m-xylene	0.5/0.5 dwell/0.5	0.2 mm Spray C
4	19%	1200	45.6	2000	50% n-dodecane, 50% iso-octane	0.3/0.5 dwell/1.2	-
5	17%	700	30.4	-	-	-	-
6	11%	950	-	-	-	-	-
7	-	850	-	-	-	-	-
8	-	1100	-	-	-	-	-
	-	300	-	-	-	5	-

Fuel temperature at nozzle	338K (65°C) instead of 363 K (90°C)
Common rail	GM Part number 97303659
Common rail volume/length	22 cm ³ /28 cm
Distance from injector inlet to common rail	24 cm
Tubing inside and outside diameters	Inside: 2.4 mm. Outside: 6-6.4 mm.
Fuel pressure measurement	7 cm from injector inlet / 24 cm from nozzle

Legend

Completed
Not met



Ultra-small angle x-ray scattering measurements

- ❖ Accuracy of the measurements is +/- 20% at each measurement location
- ❖ The measurements for this particular injector (Spray A) provide much smaller droplets than previous USAXS measurements (~ 4 μm): Cavitation?

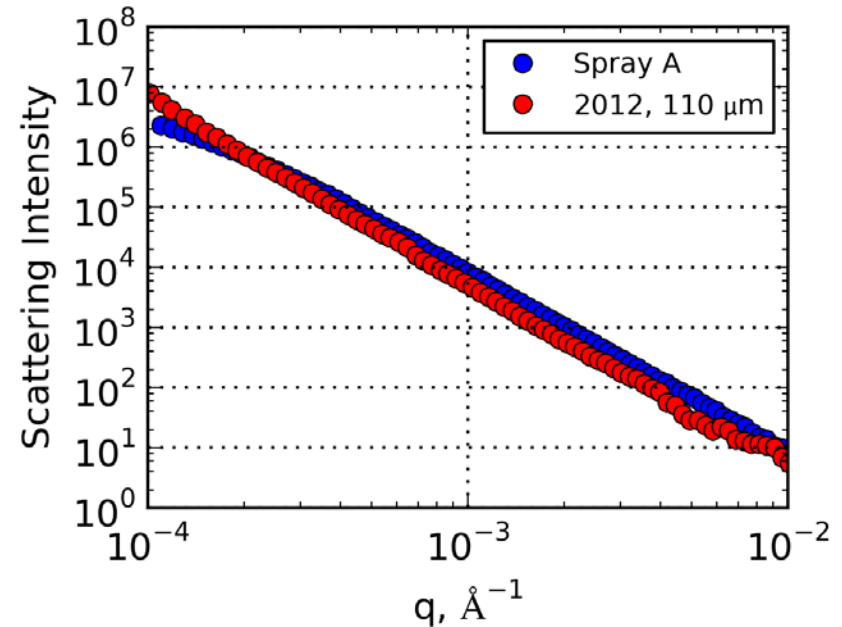
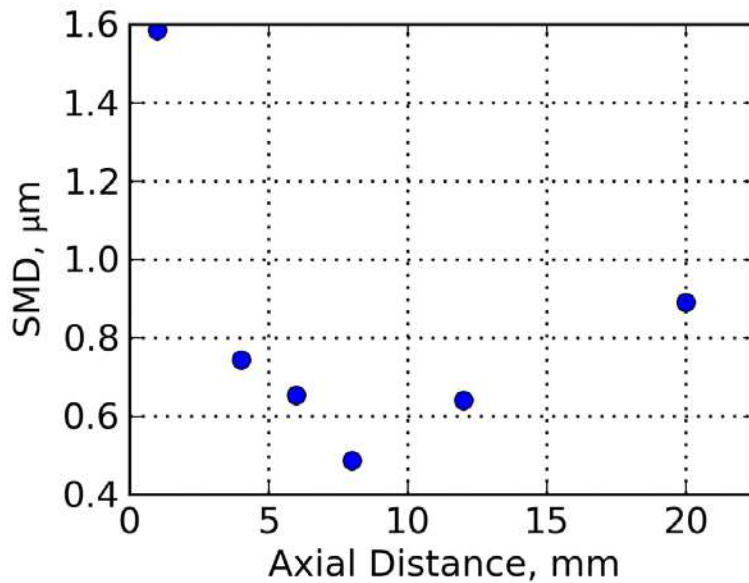

- ❖ Injector Spray A #201.02 (Malbec et al. 2013 papers.sae.org/2013-24-0037)
- ❖ Some deviations from the standard 'Spray A' conditions

Exp. Priority	5	1	4	2	7	3	6
	Oxygen	Temperature [K]	Density [kg/m ³]	Inj. Pressure [bar]	Fuel	Inj. Duration [ms]	Nozzle
Spray A standard	0%, 15%	900	22.8	1500	n-dodecane	1.5	0.090 mm, axial hole
2	21%	800	15.2	1000	n-heptane	4	3-hole, 145 angle, Spray B
3	13%	1000	7.6	500	77% n-dodecane, 23% m-xylene	0.5/0.5 dwell/0.5	0.2 mm Spray C
4	19%	1200	45.6	2000	50% n-dodecane, 50% iso-octane	0.3/0.5 dwell/1.2	-
5	17%	700	30.4	-	-	-	-
6	11%	950	-	-	-	-	-
7	-	850	-	-	-	-	-
8	-	1100	-	-	-	-	-
9	-	750	-	-	-	-	-

Fuel temperature at nozzle	403 K (130°C) instead of 363 K (90°C)
Common rail	GM Part number 97303659
Common rail volume/length	22 cm ³ /28 cm
Distance from injector inlet to common rail	24 cm
Tubing inside and outside diameters	Inside: 2.4 mm. Outside: 6-6.4 mm.
Fuel pressure measurement	7 cm from injector inlet / 24 cm from nozzle

Legend

Completed
In progress
Not met

- ❖ Droplets are visible in the optically-thin region of spray periphery, but challenging to measure:
 - Surrounded by density gradients, vaporised fuel, and shock/pressure waves
- ❖ Advanced image processing algorithms identifies many of the small liquid structures, without producing significant false positives in blurred parts of the image (lower left figure)

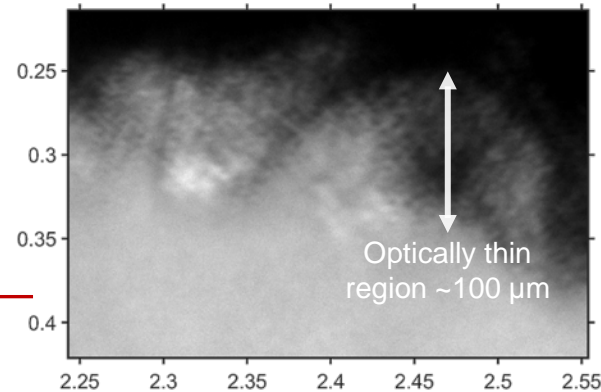
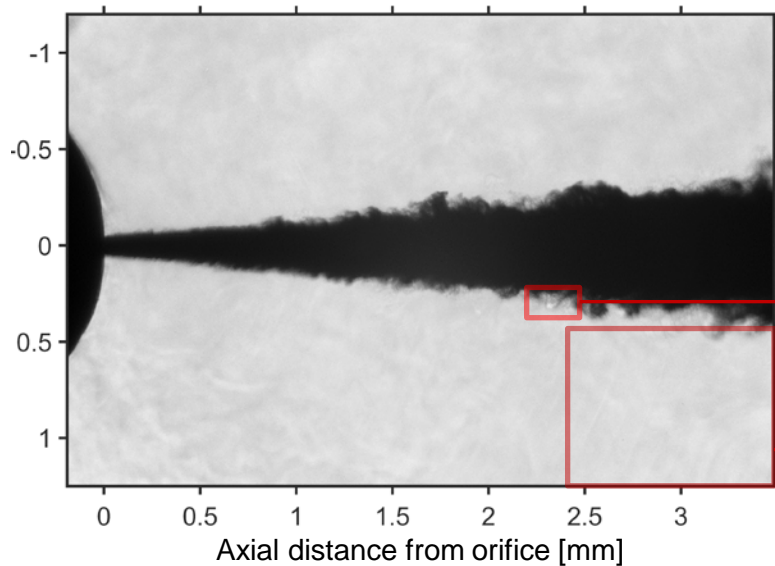

Optically-thin region is narrow, and generally limited to the high-shear and entrainment regions.

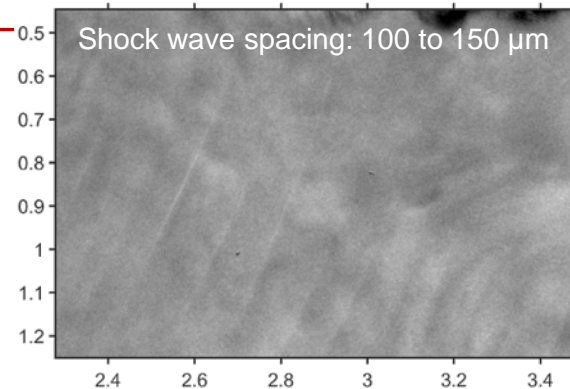
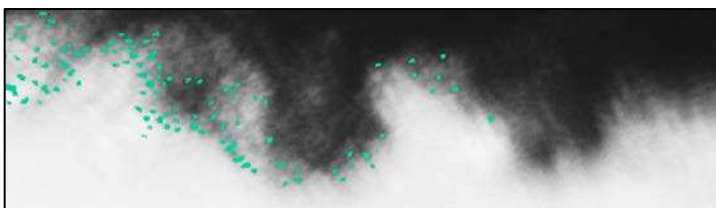

Pressure waves are often visible along the spray periphery.

How do they affect droplet formation, mixing and optical resolution?



Droplet size distributions

- ❖ Droplet sizes appear normally distributed, and somewhat independent of radial position.
- ❖ SMD reduces with axial distance.
- Is the optically-thin region dominated by droplets that can be entrained by small-scale eddies in the shear layer?
- If so, then we should expect larger droplets in the the centreline than in the shear layers.

**Statistics for $x = 1, 2, 4, 6 \pm 0.25$ mm
($y = \pm 1.2$ mm; $z = \pm 0.01$ mm)**

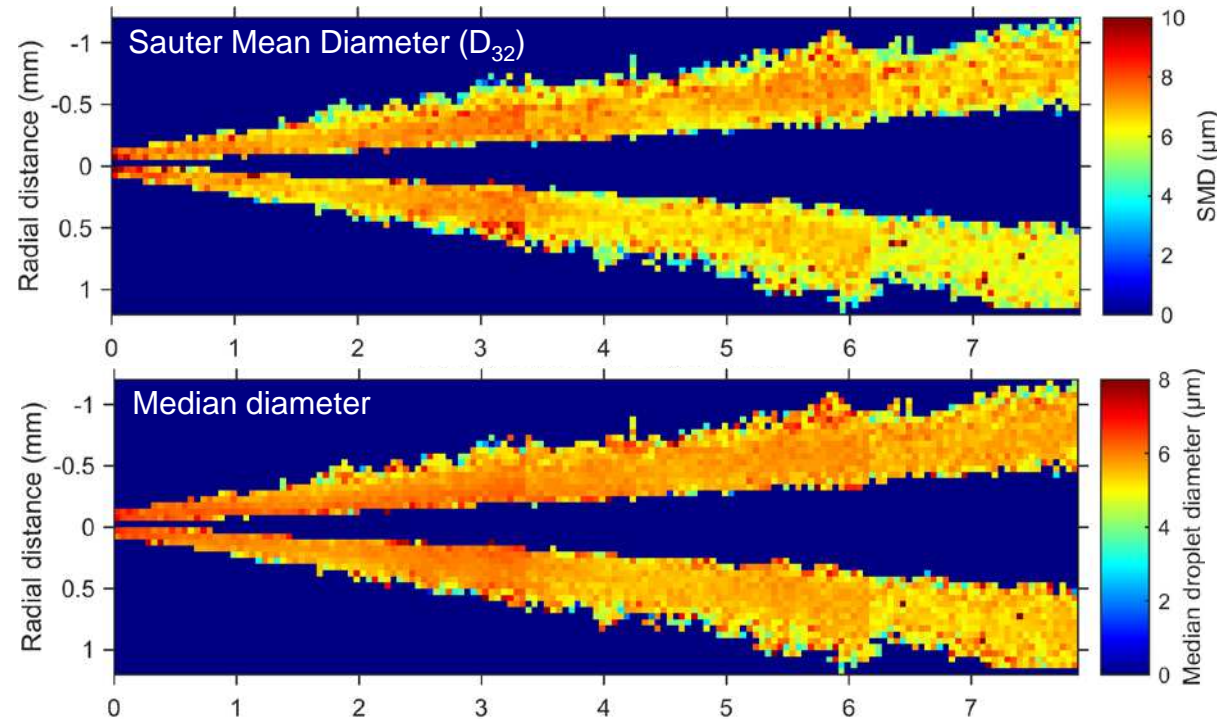
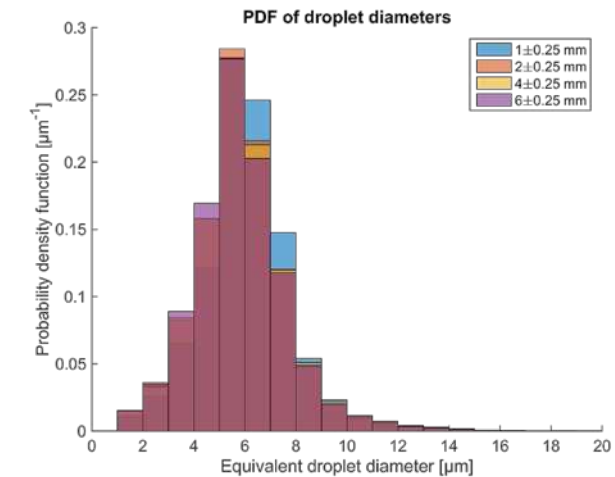
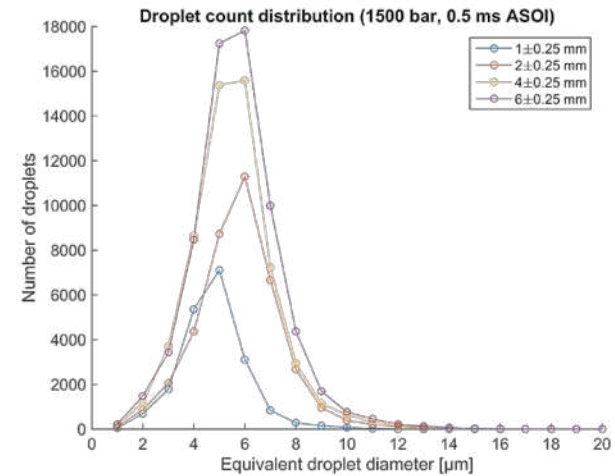

- ❖ LDM and USAXS give different SMD results at 1, 4 and 6 mm
- ❖ This may be real, or partially due to differences between the techniques:
 - ❖ USAXS is pathlength-integrated and time-averaged; LDM is space and time-resolved.
 - ❖ LDM cannot measure droplets smaller than 2-3 μm , so the SMD is biased towards large droplets. The size of droplets may also be overestimated due to low contrast and motion blurring.
- ❖ These results represent our best efforts, and **they may change** as calibration and analysis methods improve. We believe these LDM measurements are an **upper limit** for the SMD.

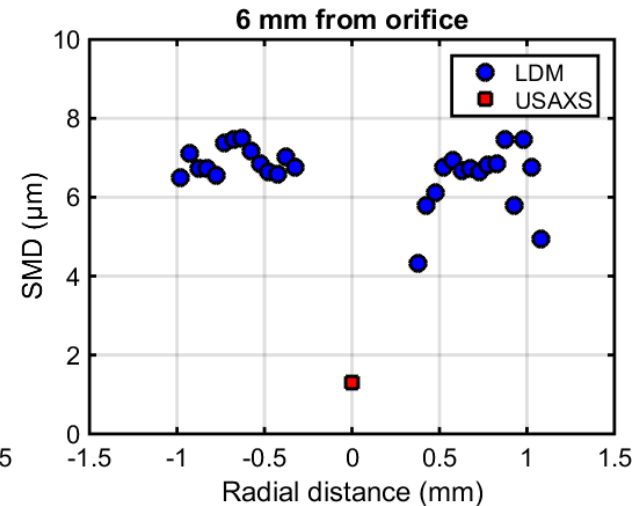
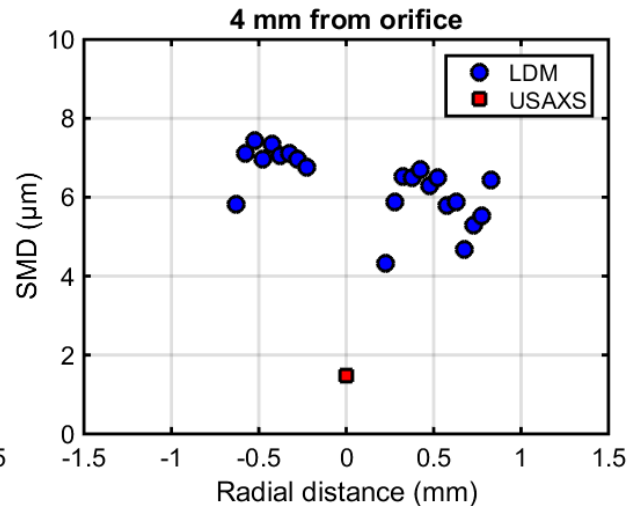
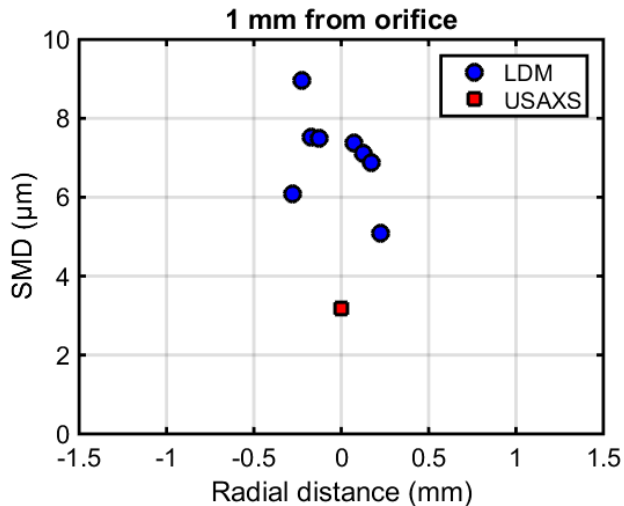

- ❖ During 'steady state' (0.5ms after SOI) Spray B appears broadly similar to Spray A
- ❖ Droplets are visible in the optically-thin region of spray periphery
 - Also surrounded by density gradients, vaporised fuel, and shock/pressure waves
- ❖ Droplet size distributions to be processed soon but, qualitatively, the shear layer structures **appear similar to Spray A**

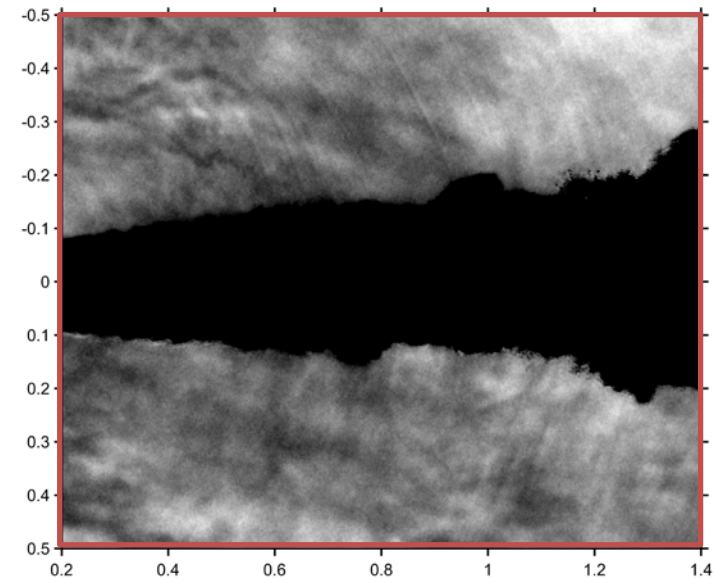
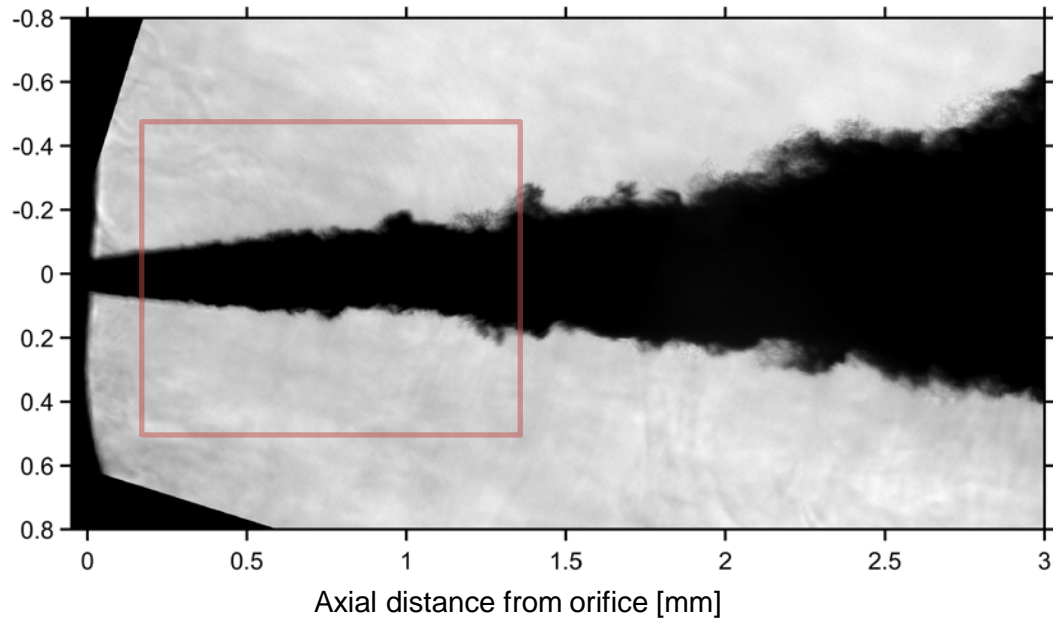



1. Objectives
2. Measurement techniques
3. Spray A measurements
4. Comparison with Spray B
- 5. Effect of gas pressure and temperature**
6. Experimental conclusions and future directions



Atomization and classical evaporation

- ❖ Droplets can be seen in the shear layer and at the end of injection
- ❖ Droplets deform/oscillate, ligaments converge into spheres
- ❖ Droplets diameters progressively reduce, with vapour trails

n-hexadecane into **900 K**, 79 bar, 30.4 kg/m³

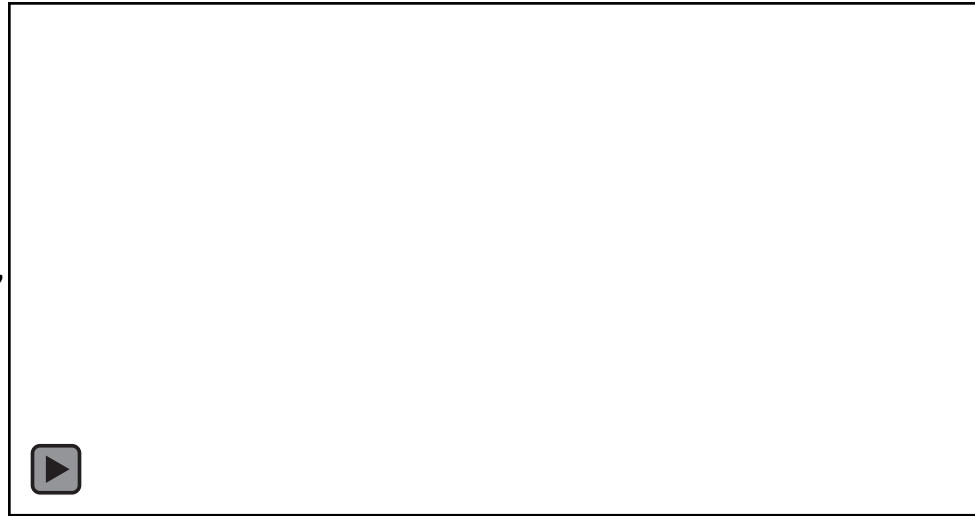

Atomization and miscible mixing

- ❖ Cannot resolve droplets in shear layers
- ❖ Breakup is observed with droplets visible at the end of injection
- ❖ Droplets deform/oscillate, ligaments converge into spheres
- ❖ Droplets suddenly spread out and vaporize

n-hexadecane into **1200 K**, 107 bar, 30.4 kg/m³

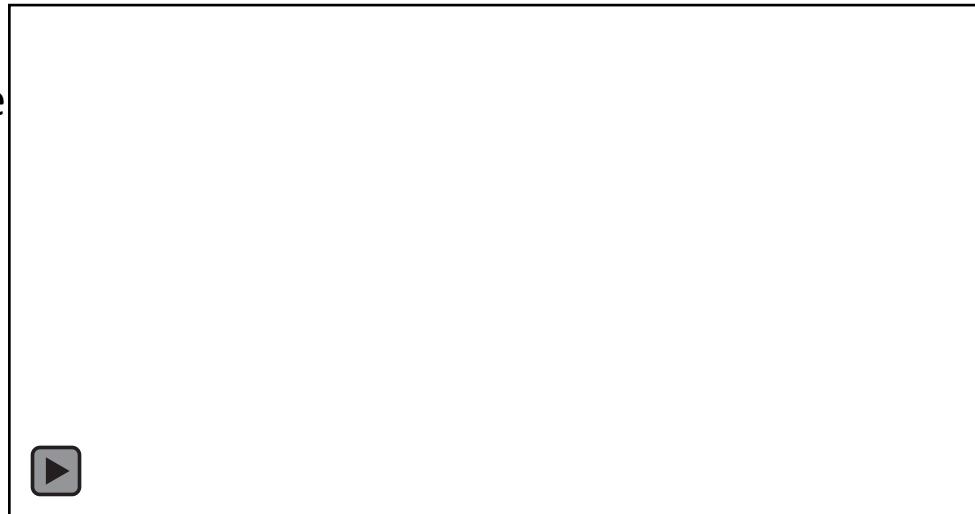

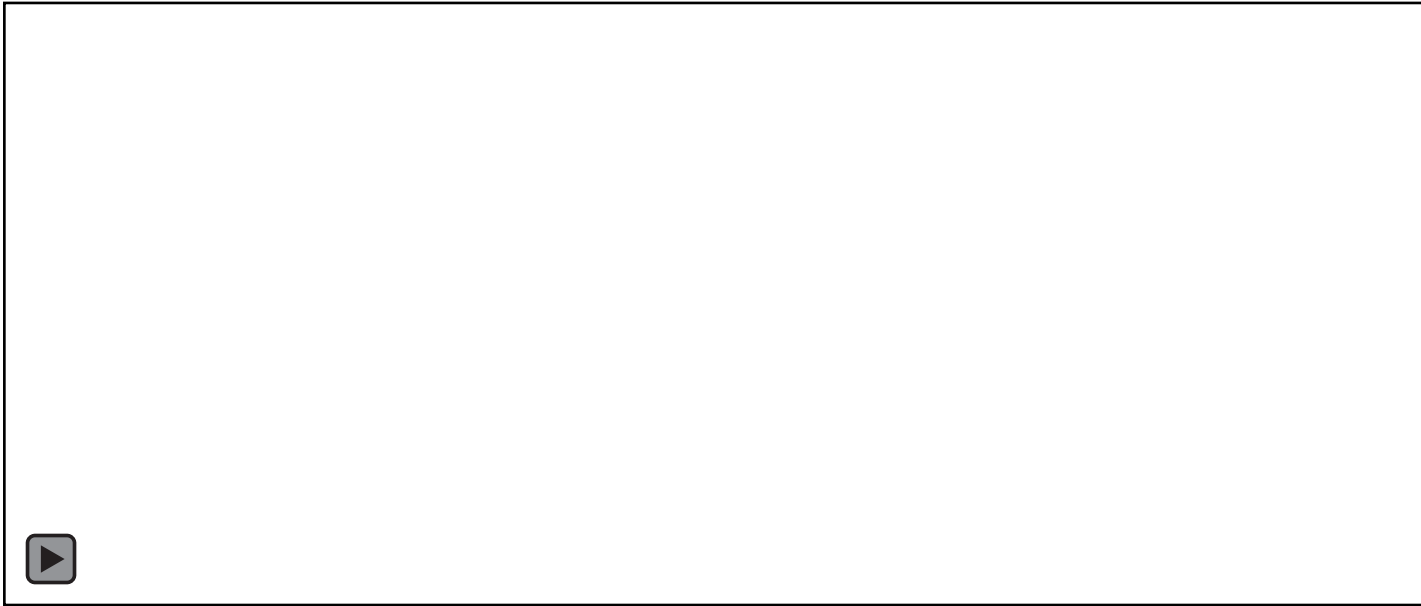

700 K Surface tension & classical evaporation

- Droplet remains spherical, with sharp interface
- Progressive mass transfer from liquid to gas

1000 K Surface tension & deformation-accelerated evaporation?

- Rapid transition from spheroid into stretched fluid
- Disintegration process is initiated at the *wake side* of the droplet

1200 K Surface tension initially followed by evaporation and miscible mixing

- Fluid stretches without a clearly elastic behaviour
- Mixing of two fluids with different densities

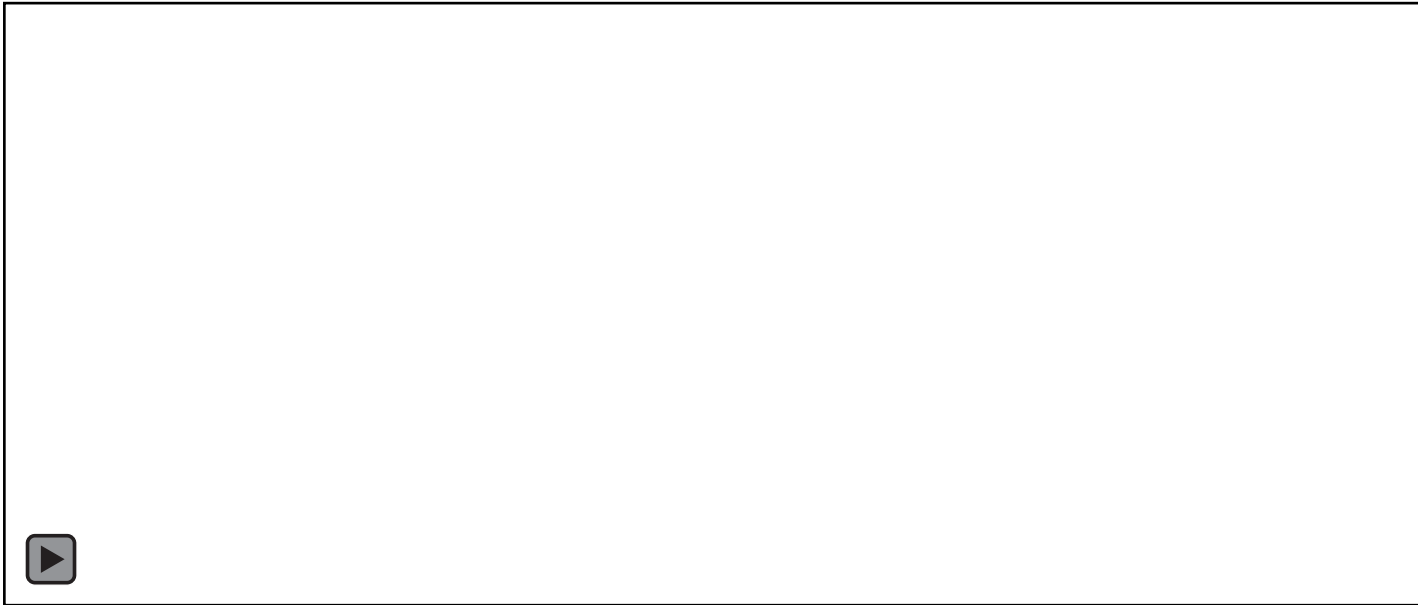

***n*-heptane** **No significant sign of surface tension**

- Transition to miscible fluid within 500 μm of the nozzle exit

***n*-dodecane** **Surface tension initially followed by evaporation and miscible mixing**

- Significant droplet oscillations and deformations
- Mixes with surrounding gas through a single-phase two-fluid mixing process

***n*-hexadecane** **Evaporation followed by miscible mixing**

- Significant droplet oscillations and deformations
- Disintegration also at the *wake side*
- But into *three* separate chunks of fluid

- ❖ Manin et al. (2014) Fuel
 - surface tension criteria
 - transition between atomization and diffusion-controlled mixing

- ❖ New results for *n*-heptane, *n*-dodecane, *n*-hexadecane
 - more reliable data → improved confidence
 - **some surface tension at all conditions for *n*-dodecane and *n*-hexadecane**
 - **some surface tension for most conditions for *n*-heptane**
 - transition from classical evaporation to miscible mixing

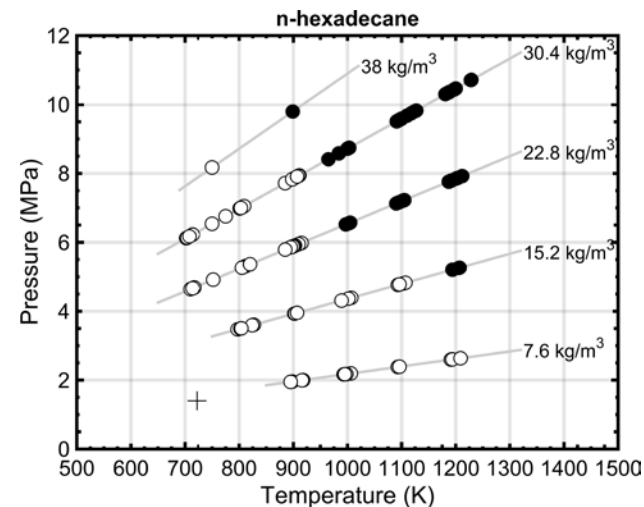
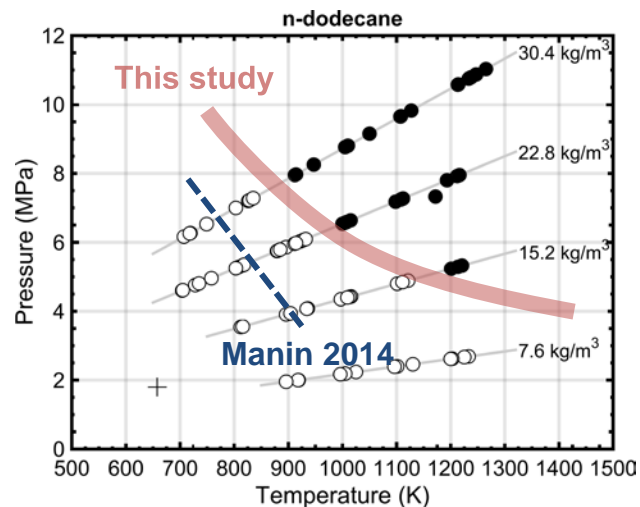
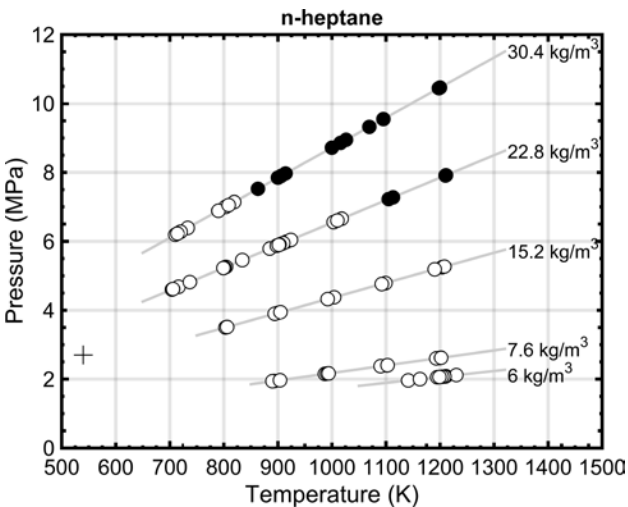



New findings

- ❖ Atomisation and surface tension
 - Evidence of surface tension for all diesel engine-relevant conditions
 - Under certain conditions surface tension appeared negligible and liquid breakup inexistent
- ❖ Droplet size distributions
 - Measured in near-nozzle, optically-thin and optically-dense, regions
 - LDM droplet sizes appear normally distributed, and independent of radial position
- ❖ Secondary breakup has not been directly observed (limitation of our instruments?)

Near future

- ❖ These results represent our best efforts, and **they may change** as calibration and analysis methods improve
- ❖ We believe these LDM measurements are an **upper limit** for the 'true' SMD of Spray A
- ❖ We may need to move away from mean droplet size parameters, unless our instruments can resolve *all* droplet sizes:
 - PDF and droplet count distributions would allow selective, and more detailed, comparisons between experiments and simulations

Towards a better understanding of atomization for both Spray A and Spray B

❖ Droplet size distributions

1. Time evolution of droplet size distributions (including start & end of injection)?
2. Need space-resolved data and simulations, especially radial distributions
3. Need quantification of droplet shapes to better estimate their surface area

❖ Shear layer dynamics

1. Does local turbulence affect radial droplet size distributions through spatial ‘filtering’?
2. Need measurements and simulations for vortex size and velocity profiles

❖ Boundary conditions

1. How do fuel properties influence size and shape distributions?
2. How does fuel temperature influence size and shape distributions?

❖ Physics of atomization

1. How do internal flow differences between Spray A and B affect breakup?
2. Is atomization a single stage breakup process? (or do we need better diagnostics)?