



University of HUDDERSFIELD

University of Huddersfield Repository

Fitzpatrick, Frank

Digital sculpting for historical representation: Neville tomb case study

Original Citation

Fitzpatrick, Frank (2013) Digital sculpting for historical representation: Neville tomb case study. Masters thesis, University of Huddersfield.

This version is available at <http://eprints.hud.ac.uk/23389/>

The University Repository is a digital collection of the research output of the University, available on Open Access. Copyright and Moral Rights for the items on this site are retained by the individual author and/or other copyright owners. Users may access full items free of charge; copies of full text items generally can be reproduced, displayed or performed and given to third parties in any format or medium for personal research or study, educational or not-for-profit purposes without prior permission or charge, provided:

- The authors, title and full bibliographic details is credited in any copy;
- A hyperlink and/or URL is included for the original metadata page; and
- The content is not changed in any way.

For more information, including our policy and submission procedure, please contact the Repository Team at: E.mailbox@hud.ac.uk.

<http://eprints.hud.ac.uk/>

Digital Sculpting for Historical Representation:
Neville Tomb Case Study

Frank Fitzpatrick

UNIVERSITY OF HUDDERSFIELD

School of Art, Design and Architecture

Supervisors: Dr Ertu Unver and Cate Benincassa-Sharman

Thesis submitted in partial fulfilment for the Degree of Master by Research April 2013

Acknowledgements

I am grateful to the following individuals who have made a contribution to the development and completion of this Masters by Research Thesis and associated project:

I would like to sincerely thank my supervisors: Dr Ertu Unver for his unfailing support and advice and Cate Benincassa-Sharman for her thoughtful suggestions and encouragement throughout.

I would like to include my thanks to Durham Cathedral and St. Boniface Church, Bunbury Cheshire and also to Professor John Woodwark for his kind assistance.

My gratitude also extends to my department colleagues Barry Armstrong and Anne Fox-Kelly and my acknowledgements would not be complete without heartfelt thanks to my wife Sharon and my children Sean and Sarah for their patience, understanding and for allowing me the time and space to complete this submission.

Abstract

Despite digital 3D polygon modelling applications providing a common and powerful tool-set for archaeological, architectural and historical visualisation over recent years, digital deformation sculpting tools are little used at present within the area of historical visualisation. More commonly applied within the video games and TV/motion picture industries, the intention of this research is to combine such tools and methodologies with existing scanned data and historical knowledge to remediate and re-imagine lost sculptural form. The aim would be to support both academic and public understanding of such missing artefacts. In addition, the research may promote alternative methods of prototyping within traditional stone carving industries and further provide an opportunity to critically evaluate approaches to deliberately mediated sculptural surrogates and their location within historical representation.

The intended research will focus on an examination and partial re-construction of the Neville tomb at Durham Cathedral. An example of cultural vandalism, the tomb has been damaged at key moments throughout several hundred years of social and religious upheaval. It will provide the researcher with an opportunity to re-create and interpret some of the lost sculptural forms carved upon it. In addition, it affords the opportunity to further explore the use of polychrome on medieval stone carving.

Table of Contents

1. Introduction	1
1.1. Research Objectives	2
1.2. Research Methodology	3
2. Literature Review	5
2.1. Historical Overview	5
2.2. Visualisation	6
2.3. Early Digital 3D Visualisation	7
2.4. Critical Views	9
2.5. The Wider Critical Debate	10
2.6. The Heritage Industries	15
3. Application of Technology to the Field	20
3.1. 3D Surface Data Acquisition	20
3.2. Digital 3D Modelling	24
3.3. Polychrome	26
3.4. Digital Sculpting	27
3.5. Rapid Prototyping/3D Printing	31
4. Experimental Study	34
4.1. Project Intentions	34
4.2. Hard Surface and Organic Modelling	35
4.3. Background and Context	35
4.4. Data Capture	37
4.5. Base Modelling	39
4.6. Typifaction	43
4.7. Application of Polychrome	44
4.8. Application of Photogrammetry to the Project	45
4.9. Further Project Research	48
4.10. Editing the and combining the Photogrammetry Data	50
4.11. Modelling and Sculpting the Effigy	52
4.12. Sculpting in Mudbox	55
4.13. 3D Printing	58
4.14. 3D Printing of the Sculpt	62
4.15. PTEX Texturing	62
4.16. Please see further rendered images on the attached DVD	65
5. Findings and outcomes	65
6. Conclusions	67

7. References	72
8. Bibliography	74
8.1. Books/eBooks	74
8.2. Catalogue	74
8.3. Conference Papers/Proceedings	74
8.4. Journal Articles.....	75
8.5. Magazine/Newspaper Article.....	77
8.6. Reports/Hearings/Standards.....	77
8.7. Thesis	77
8.8. Web Pages.....	78
9. Appendix	78

List of Illustrations

Figure 1: The location of the research.....	3
Figure 2: A 19th century watercolour representation of part of the Parthenon.....	5
Figure 3: Plan and section displays of field data.....	7
Figure 4: Digitally restored images of the Bath Complex: John Woodwark	8
Figure 5: The Laocoön and his Sons.....	12
Figure 6: Demonstrating attempts at reconstruction of the Laocoön	12
Figure 7: (Duchenne: Discourses of Aesthetics, Sexuality, and Power in Nineteenth-Century Medical Photography, Hayes P. M.).....	13
Figure 8: Digital Sculpture Project. Laocoön	14
Figure 9: Scott Eaton: Prometheus (detail)	15
Figure 10: A photograph taken on my visit in August 2012 shows the reconstructed Governors' Palace.....	16
Figure 11: The Demolition of Matthew Whaley School, Williamsburg, Virginia, to make way for the reconstructed Governor's Palace, early 1930s.....	16
Figure 12: Procedural model of Rome Reborn: The Circus Maximus from the Southeast	17
Figure 13: Douglass Theatre model from Virtual Williamsburg, 2007: The Colonial Williamsburg Foundation.	18
Figure 14: Point Data from Photogrammetric study of Stonehenge. Surveying Stonehenge by Photogrammetry	21
Figure 15: Digital Michelangelo Project, Laser Scan.....	21
Figure 16: Laser scan showing sequence of shadows cast on stone 4.....	22
Figure 17: Example of Photo Scene Editor in Autodesk's 123D Catch: Autodesk Discussion Groups	23
Figure 18: CATIA (Computer Aided Three-Dimensional Interactive Application) and was developed by the French aircraft manufacturer, Avions Marcel Dassault, in 1977	24
Figure 19: Computer reconstruction and a view of Kalabsha as it appears today.....	25
Figure 20: Reconstructed hieroglyphics lit by (a) modern lighting and (b) a sesame oil lamp.	25
Figure 21: Head of an Amazon, from a life-size statue discovered near the Nonius Balbus Basilica at Herculaneum,	26
Figure 22: "Alexander" Sarcophagus, detail of colour reconstruction: a Persian and a Macedonian fighting.	27
Figure 23: Scott Patton _Concept Design ZBrush Sculpts for Motion Picture Avatar 2001.....	28
Figure 24: Character creation for Ubisoft's FarCry 3 using ZBrush.....	29
Figure 25: Scott Eaton, Digital Sculpture	Figure 26: Meats Meier, Digital Illustration
29	
Figure 27: Examples of jewellery and product design using Digital Sculpture.....	30
Figure 28: Kenneth Snelson 'C60'	Figure 29: George W. Hart 'Spikey Guy'
30	
Figure 30: Dan Collins Twister. Original scan data and Finished CNC foam with polyurethane coating.....	31
Figure 31: RP Manufacturing: Sand bound together to create a marble-like material	32
Figure 32: Artificial knees manufactured the specific contours of bones	32

Figure 33: 3D printing of clusters of stem cells towards creating artificial organs ...	32
Figure 34: University of Hull: Rapid Prototyping for the Partially Sighted	33
Figure 35: The tomb of Sir John Neville	36
Figure 36: The Tomb of Sir Ralph Neville: Staindrop Church. Raby, Co Durham.	36
Figure 37: The Minolta 3D Scanner used to scan the surface topology of the tomb of Sir John Neville	38
Figure 38: Photoshop overlays to clarify positions of the scanned data.....	38
Figure 39: Geomagic scanned data checked against Image	39
Figure 40: Import of stitched Geomagic data as .obj file to 3D Studio Max.....	39
Figure 41: Using the Step Build process in 3D Studio Max 2012	40
Figure 42: 2different approaches next to the original scanned data.....	40
Figure 43: Establishing symmetrical carved content	41
Figure 44: Demonstrates the completed carved element using the symmetry modifier in 3D Studio Max 2012	41
Figure 45: Checking build against scanned base and the completed section	42
Figure 46: Section with Symmetry Modifier applied and with Flattened UV set for export to Mudbox.....	42
Figure 47: Sections extended out with top and bottom sections added. Corner pieces created from adapted existing geometry.	43
Figure 48: Examples of typifaction in contemporary effigies Left to Right: Edward Prince of Wales, Canterbury. Alexander de Mowbray, Saint Michael, Kirklington and John Beauchamp, Worcester Cathedral.....	44
Figure 49: Tomb viewed from the Nave with evidence of polychrome	44
Figure 50: Tomb viewed from the South Aisle of the Nave with evidence of polychrome	45
Figure 51: The Chantry of Bishop Hatfield. Durham Cathedral	45
Figure 52: The Tomb of Bishop Branscombe. The Lady Chapel, Exeter Cathedral Error! Bookmark not defined.	
Figure 53 : Laser scan data of Sir John Neville effigy.....	46
Figure 54: Sir Ralph Neville and Margaret Stafford and Phillipa Beauchamp and Sir Roger de Bois and Lady Margaret de Bois.....	47
Figure 55: Sir Hugh Calveley.....	47
Figure 56: The Photogrammetry survey of the tomb of Sir Hugh Calveley	48
Figure 57: Tournament Helmet. Leeds Armouries	48
Figure 58: Sir Hugh Calveley Helm Detail	48
Figure 59: Great helm, English, mid-fourteenth century. Royal Armouries.....	49
Figure 60: Oakshott sword classification.....	49
Figure 61: Display from arms and armour of The Hundred Years War	50
Figure 62: Photogrammetry capture with surrounding hearse.....	50
Figure 63: Initial results showing some success with point registering with Automatic Tie Point Extraction in 123D Catch	51
Figure 64: Scanned data combined and loaded into 3D Studio Max 2012	52
Figure 65: The initial retopology in 3D Studio Max 2012 from the combined Photogrammetry data.	53
Figure 66: With some of the problems highlighted in red.....	53
Figure 67: Mudbox Level 0 9896 Faces and Level 3 475008Faces	54
Figure 68: Retopologised corrected mesh.....	54
Figure 69: Showing the basic asymmetrical elements added.....	55

Figure 70: The file exported to Mudbox.....	55
Figure 71: Sculpt with some of the tertiary forms added	55
Figure 72: Some of the 14 Custom Stencils made to aid sculpting.....	56
Figure 73: Stencil application on the model.....	56
Figure 74: Sculpted Helm	57
Figure 75: 3D Max model of sword.	57
Figure 76: Sword added to scene..	57
Figure 77: Tail added from 3DMax as a support to added to scene..	58
Figure 78: The imported mesh as a ZTool.....	59
Figure 79: The level of decimation to the right at 10%. Polymesh display shows mesh triangulation.....	59
Figure 80: Below shows the level of decimation achieved using ZBrush Decimation Master plug-in.	60
Figure 81: Below shows the imported figure placed on Tomb base in 3D Max.....	60
Figure 82: Final Clay render	61
Figure 83: Clay Render Detail	61
Figure 84 Preparation and printing of the sculpted model.....	62
Figure 85: Shows the final print after removal of the support material.....	62
Figure 86: Further custom stencils created for Shield on Tomb Base.....	63
Figure 87: Detail of Custom Material, Texture, Diffuse and Specular paint layers in Mudbox.....	64
Figure 88: Sample polychrome applied to the tomb base and effigy.....	64

Abbreviations

ABS	Acrylonitrile Butadiene Styrene
CAD	Computer Aided Design
CATIA	Computer Aided Three-Dimensional Interactive Application
CGI	Computer Generated Imagery/Illustration
CNC	Computer Numerical Control
CPU	Central Processing Unit
FBX	FilmBoX
GPU	Graphics Processing Unit
NURBS	Non-Uniform Rational B-Spline
OBJ	OBJECT File Export System
PTEX	Per TEXel Painting
RAM	Random Access Memory
RP	Rapid Prototyping
STL	STereo Lithography
TIFF	Tagged Image File Format
TLS	Terrestrial Laser Scanning
UI	User Interface
UV(W)	Texture Space Co-ordinates

1. Introduction

This research is intended to be placed within the wider context of the representation and remediation of archaeological objects, buildings and historic art, as well as the creation of virtual heritage items and the communication and public awareness of such cultural artefacts. Such communication has in the past been delivered through drawing, painting and photography. However, in more recent years the development and use of 3D modelling tools have helped greatly with the representation of historic and archaeological artefacts and a great deal of research in analysing their uses and effectiveness in this area has already been undertaken.

For the most part, such 3D modelling applications have tended to be sophisticated polygon and NURBS modelling tools such as Autodesk 3D Studio Max, Autodesk Maya or their equivalent. Such software provides the designer/visualiser with a powerful creative toolset that allows for modelling, lighting and rendering, even animation and visual effects.

Increasingly however, driven by the need of the Video Games and CGI industries to create ever more faithful representations of form and surface, a new set of modelling tools has become available allowing for even greater acuity of form and surface. Such software can provide an almost intuitive and, despite its digital nature, a form of tactile user experience, giving the impression of digital clay rather than the more rigid approach usually associated with polygon modelling tools. Perhaps two of the best known such applications are the Autodesk Mudbox and Pixologic ZBrush digital sculpting software packages.

The word sculpting does have a distinct etymology within the history of art practices – traditionally the art of making three-dimensional representative or abstract forms through, for example, carving, moulding, forming, casting, cutting, fixing or stacking materials; today the word is used broadly in contemporary art practice to encompass installation, land art, body art, performance art, text-based work, photography and video, as well as the three-dimensional art object. For the purposes of this research I differentiate the use of the word from these art practices to be understood as a process of creative 3D digital modelling for design. I would note here that within the context of this research and within the location of digital design, the term digital sculpting (or 3D Sculpting) as a descriptor of this practice has a consistent precedent and is a generally accepted nomenclature both within the creative digital industries and the software development community. The term sculpting is also applied in this instance to differentiate the processes used from the practice of polygon modelling. Its use reflects users' engagement in the manipulation of a form of digital clay. The design of the user interface of such software acts as a metaphor for the non-digital tactile application of clay like material.

For the purposes of this project I have chosen Autodesk Mudbox as my preferred sculpting tool, although much of what I have undertaken can be replicated across other similar software. This decision is based purely upon greater access to the software via the Autodesk's free educational license scheme. Thus the software is more likely (though not exclusively) to be accessible for those working within historical research. This, together with its greater integration with my preferred choice of 3D Studio Max 2012, plus its simpler and more intuitive interface design, means it may provide a more likely platform for those already familiar with the industry standard polygon modelling applications mentioned above.

The research seeks to use such software tools in conjunction with 3D Laser and Photometric scanning techniques to capture surface data that may provide accurate base topology from which to develop outcomes. In this case the tomb of Sir John Neville, 3rd Baron Raby, located in Durham Cathedral, County Durham. UK.

The Neville Tomb provides an opportunity to apply these software tools and techniques in the partial remediation of its lost sculptural form. I intend to examine sculpting software more usually associated with the Games and CGI industries. Such approaches may assist those engaged within the field of archaeological illustration and provide some new opportunities for the presentation of visual information for public understanding and consumption. It is not the intention of this researcher to provide an outcome that would faithfully represent a fully accurate representation of the original sculptural form (such could only be obtained by a considerable body of research and historical information that is beyond the scope of this research project). However, the research intends to present a possible workflow that might offer some new approaches to those with experience of working within this field.

1.1. Research Objectives

- To assess current digital sculptural approaches and methodologies and locate existing gaps within current archaeological and historical visualisation
- To explore how such methods and processes may be utilised in combination with 3D scanning, 2D Photometric and Photosynth recording, Digital Painting and Rendering, and Rapid Prototyping technologies.
- To establish appropriate workflows and methodologies through the interpretation of a lost/damaged historic sculptural form
- To assess the role of digital sculpting within the on-going dialogue that surrounds historic visualisation, communication, consumption and its ethics and responsibilities.

1.2. Research Methodology

This practice-led research, through the implementation of a selection of digital tools and processes allows for the partial remediation and digital reconstruction of Sir John Neville's tomb. It will involve a multi-disciplinary approach through the integration of acquired data, historical reference and artistic interpretation.

The location of the research sits within the confluence of a range of disciplines that play a part in informing the research outcomes. (Figure 1)

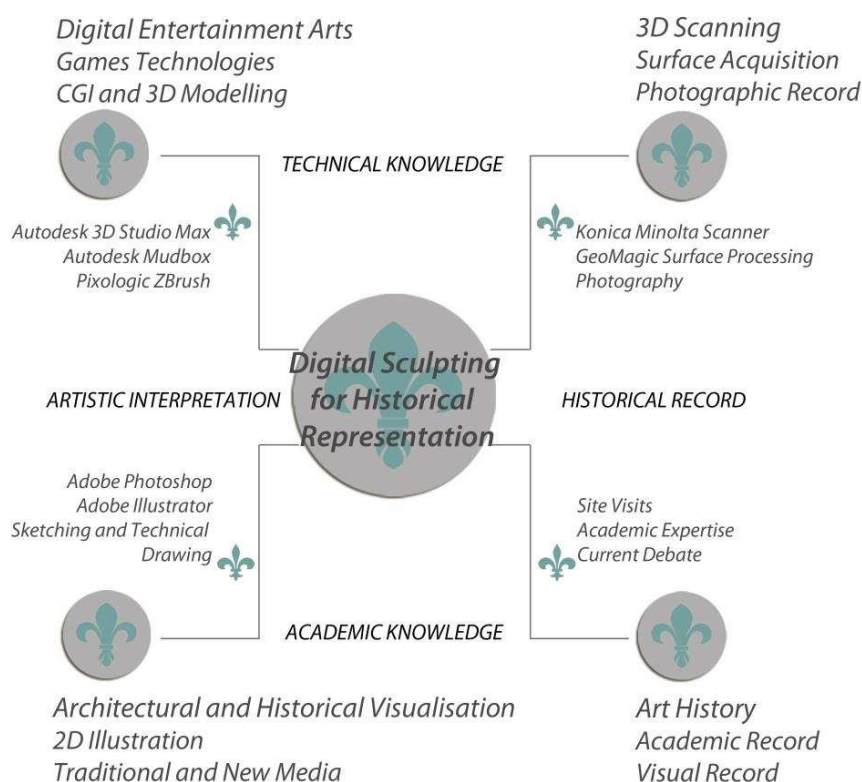

Figure 1: The location of the research

Its aim is to investigate digital process(es) that may provide alternative approaches to the visualisation of historic artefacts. And in doing so, provide opportunities for the integration of tools and technologies little used at present within this field.

My experience within digital design, both as industry practitioner and educator, did not automatically place me as a three dimensional sculptor or modeller. Nor do I have experience as an historian or historical visualiser. My background as a Graphic Designer/illustrator in industry and my subsequent move into teaching did not provide opportunities for working with either 3D modelling or sculpting software. My interest in the application of such tools to heritage reconstruction came about with a welcome change to my curriculum teaching and an initial need to apply my digital design and illustration skill set towards the application of 3D modelling. I began to consider these new processes and tools

I more recently engaged with, might be used towards an audience beyond my immediate student cohort. Therefore, within the timeframe of this research period, there has been a rewarding investigation into many such applications that were unknown to me at the start of the process, combined with a greater understanding and appreciation of the traditional craftsmanship of the medieval stonemason/carver.

Further to these new tools a variety of information has been gathered from diverse sources including: scanned data, historical reading into the related period, technical books, journals and websites, conference papers, exhibitions, site visits, on line tutorials and research papers.

The interpretive nature of the subject, the context and critical debate that surrounds it and the fluidity of the technology mean that this can only be a snapshot of the current understanding and approaches within this field. The following review of the literature surrounding these debates outlines these issues in further detail.

2. Literature Review

2.1. Historical Overview

In his 2009 Coalition for Networked Information address, Bernard Frischer, the Director of the World Heritage Laboratory at the University of Virginia, describes how in the West the compulsion through the visual medium to record and interpret our past stems from an enlightened and humanistic philosophy developed from the European Renaissance. The artistic study of the classical period and the popularity of the European Tour fostered a curiosity regarding the classical world. Artists travelled to those known ancient sites to interpret what they witnessed through painting, (Fig 2) sketching and envois studies. Casts were made, where possible, of classical sculpture and artefacts for those who could not travel to such locations; these were then transported back for academics to study and fellow artists to record from. This in time became the foundation of the artistic tradition of the French Academy, one that developed into the Ecole Nationale Supérieure des Beaux-Arts in Paris. Many aspects of this approach dominated the teaching of the artistic disciplines in the West for the next several hundred years. (Frischer, 2009)

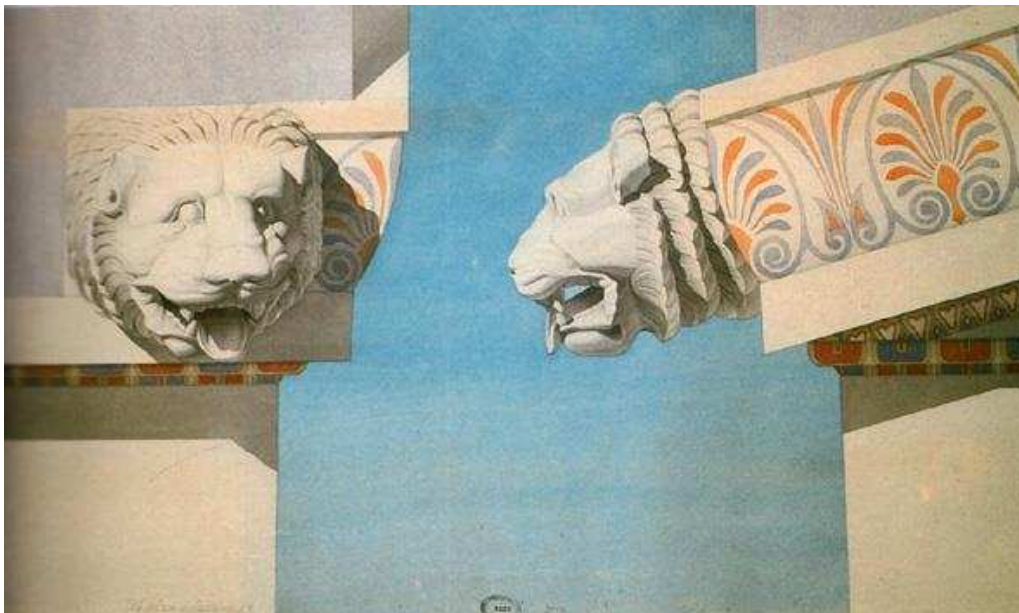

Figure 2: A 19th century watercolour representation of part of the Parthenon.

From this need to record the cultural history of mankind there was created, what Frischer labels a 'humanistic code' (Frischer, 2008)... that attempted the cataloguing, understanding, safe-keeping and communication of the human record. Prior to the development of digital technologies, drawings such as plans, sections, elevations and axonometric illustrations were used to describe monuments, buildings and artefacts, though such recordings suffered in their limitations of representing the three dimensional. Further, the production of tactile models was rare; as they were expensive and usually difficult to transport. So it may be

argued that, within this regard at least, the development of computers and digital technologies has gone some way to enhancing our ability to visually disseminate the communication of the historic past.

2.2. Visualisation

The power of the re-enforcement of human cognition via visualisation is well recorded. Faced with such rich visual images it was becoming apparent that the context in which visualisations are produced and the location of their audience, should demonstrate appropriate methodologies tailored to the requirements of the intended viewers. With clearly demarcated boundaries and within agreed approaches and standards, computer graphics provide a seamless fusion between the massive processing power of the visual system and the power of the digital computer... 'computer graphics, because it bonds mind and machine in a unique partnership, creates an entirely new way of thinking' (Friedhoff R, 1989)

According to information scientist Colin Ware, a visualisation can promote understanding in the following five ways:

- It may facilitate the cognition of large amounts of data
- It can promote the perception of unanticipated emergent properties
- It sometimes highlights problems in data quality
- It makes clear the relationship of large-and small-scale features
- It helps us to formulate hypotheses

(Ware, 2008)

There are examples where the act of visualisation has a profound effect upon the understanding of complex events or systems. In his *The Visual Display of Quantitative Information*, Edward R. Tufte gives two classic examples:

The periodic table helped visualise the gaps in our knowledge, but also helped identify the nature of those elements that were yet to be discovered; and where they would be located within the hierarchy of elements. Another was John Snow's solution of the cause of an outbreak of cholera in London in 1854. By displaying all the cases on a map marked with streets and public water pumps, Snow was able to establish that the disease had spread through water contamination at a specific pump. (Tufte, 2001)

In either case above, the evident power of visualisation is apparent. Both represent a traditional 2D approach and '...for data access, exploration and retrieval it may generally suffice, however more complex analyses concerning spatial and temporal features require 3D tools...' (Agugiaro, 2011)

2.3. Early Digital 3D Visualisation

Although the use of the computer for the study of history and archaeology had been in place since the late 1960's and early 1970's its use had been within the areas of database design and management and quantitative analysis. Early discussions around the application of 3D modelling and its value within archaeology and historical illustration didn't begin until the inaugural meeting of the Computer Applications and Quantitative Methods in Archaeology (CAA) conference in 1973. Here J.D. Wilcock's presented what he considered four main uses of the computer in the field. They included: Data Banks and Information Retrieval; Statistical Analyses; Recording of Fieldwork and the Production of Diagrams. (Wilcock, 1973)

He further included a fifth general category in which computer reconstruction was mentioned.



Figure 3: Plan and section displays of field data

However, for the next decade most computer applications in the field were statistical and produced on a university mainframe, visualisation was largely 2D CAD schematics and diagrams. (Frischer, 2008) Such were used to collate and display the layers of data before they were destroyed in the process of excavation. (Fig 3) But the development of the Personal Computer and Workstation in the early 1980's provided a corresponding development in specialist software tools to allow for a greater degree of visual fidelity, along with a capacity to perform the solid modelling of objects in 3D space.

An early example of this form of visualisation can be seen in the BBC's flagship history programme, Chronicle. For an episode entitled 'Water of Bath' broadcast in 1984 there was produced a 3D recreation of the temple below the Pump Room, helping illustrate to a lay audience the original look of the Bath Temple Precinct. The reaction to this advance in digital graphics was that the City of Bath proceeded to commission further 3D reconstructions of

the Roman Civic Baths to inform the over one million tourists visiting the city annually at that time. (Lavender, 1990)

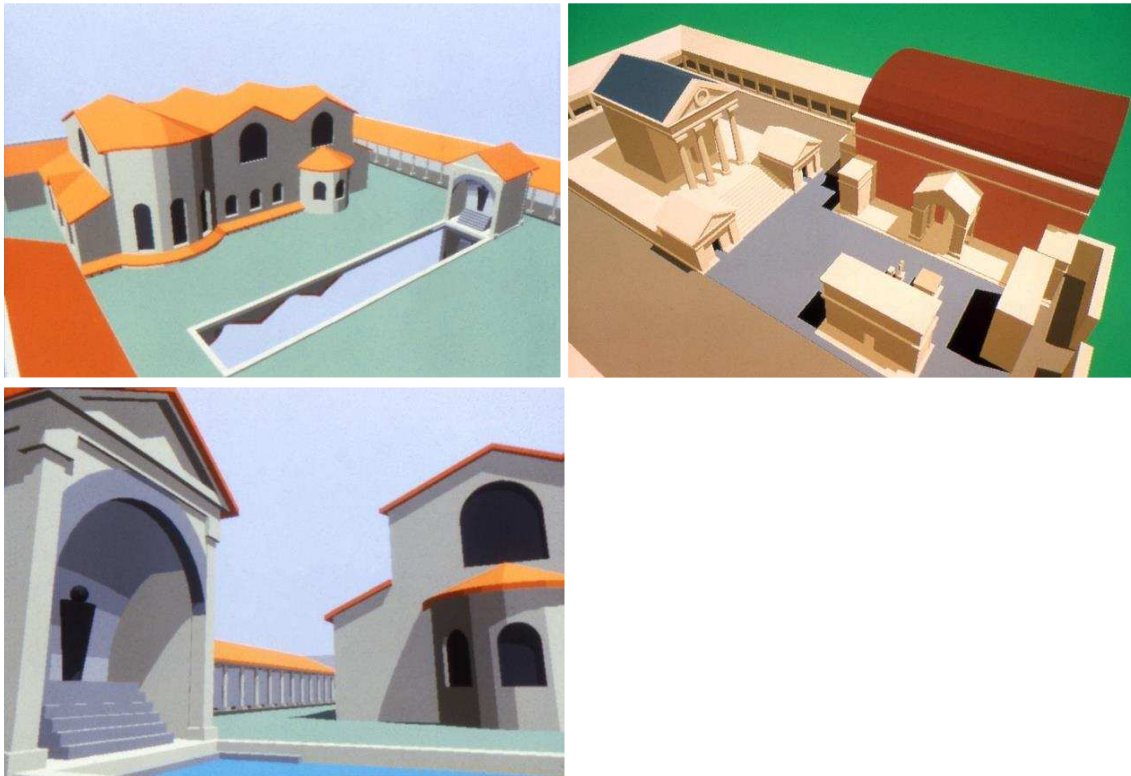

Figure 4: Digitally restored images of the Bath Complex: John Woodwark

Completed by a team led by John Woodwark at Bath University, the Bath recreation utilised early solid modelling applications as well as DoDo (Daughter of Dora), an early ray tracing set-theoretic programme and even digital painting to incorporate figures into the final rendered scene. (Fig 4)

As part of my research I was able to obtain from John Woodwark the original photographic slides taken from the monitor screen at the time of creation. It came as some surprise to me that no digital record of this groundbreaking work are yet available, and with John's permission I scanned and cleaned a number of slides. He stated to me that the images show... 'a more complete model of the Bath baths complex that was done as a follow-up using a later program, which ran on a DEC VAX 32-bit computer, with a whole 1Mbyte, which seemed like a stupendous amount of memory at the time. This program would handle bigger models, from which it created a somewhat persistent spatially segmented version of the CSG -- i.e. a lot of little models, each valid only in its own cuboid domain. These small models could be processed relatively fast, and the whole structure could be traversed by rays, allowing us to produce shadows and so on.' (J Woodwark)

This early example offers both the genesis of the seductive power of digital 3D visualisation as well as some of the limitations inherent in attempts at such re-creation. Throughout the later 1980's and beyond, television documentary, heritage industries and publishing used

such imagery to communicate ideas of the past to a public becoming ever more interested and visually discerning of this new medium, particularly through a broader engagement with increasingly sophisticated video games, television and film products.

2.4. Critical Views

It is understandable that given the relative fidelity of this new technology in its early stages of development, in some quarters an uncritical embracing of its capacity should have ensued. Indeed, there were many perceived benefits when just general visualisation was required. Public access to information could be maintained whilst sites were closed for research and conservation, or when sites became too unsafe for the public to visit. When ramps and lifts were not possible, it could provide an alternative experience for the elderly and those with mobility issues. Interactive study could take place via CDROM and latterly the internet and as technology and processes developed, interactive narratives could be explored allowing for the re-creation of a '...set of events happening during a certain period of time and providing aesthetic, dramaturgical and emotional elements, objects and attitudes'(Marichal., ICVS '01) The further embracing of this new medium was revealed in statements such as how it 'enriched the perception of the material under study' (Reilly, 1989)

Nevertheless, it has also been argued that for much of the recent history of the development of 3D visualisation, attention has been focused on endeavouring to create increasingly more realistic representation. This focus, driven by ever more powerful digital modelling tools and hardware developed for the needs of the entertainment industry, led to criticism that projects often served as '...vehicles for demonstrating advanced graphics techniques with any archaeological considerations playing a less important role'. (Ryan, 1996) Claims were also made that '...digital tools in the humanities were used more to improve our efficiency in doing the same old things in a different way, not to transform our methods and our disciplines'. Frischer B,

Further, in the long history of the visualisation of historic artefacts, there have been more than several examples where the use of artistic licence, has allowed for misrepresentation and confusion as to the veracity the object presented, an important examples of which is introduced in a later section of this thesis. The Bath reconstruction above is an example where, although a carefully considered project, with input from known recorded data, there was some degree of artistic licence in the absence of concrete information. In this case, the height of some of the temple buildings had to be guessed at. As a very early example, this 'guesstimate' highlights the beginnings of a debate that would run concurrently with advances in the ability to produce ever more realistic imagery.

As the 1980's gave way to the 1990's, with these advances, objections began to be raised that such visualisations were in danger of becoming; '...virtual constructs taking on a life of their own, potentially misrepresenting the history and content of a site to future generations'. (Levy, 2001) By 1998 in his generally positive review of computer visualisation, Julian Richards included reference to issues he stated with Paul Miller, that 3D visualisations '...raise the problems of portraying the past as a knowable reality.' (Richards, 1998). In addition, he noted the problems of the omission of archaeological complexity from illustrations and the need to explore mechanisms for indicating uncertainty within the outcomes. Or as Daniel O'Donnell asked, 'How does one distinguish among levels of reconstructive certainty in an immersive environment?' and 'Distinguish the hypothetical from the documented in a 3D representation?' (Donnell, 2012) The debate highlighted a need to allow for an understanding of where clearly acknowledged known data can be seen and where reasoned approximation may begin;

In acknowledging some of these debates, Associate Director of the CVRLab Diane Favro recorded an increased division in universities in the United States. That of a divide between the History and Archaeological departments' who became suspicious regarding visualization, and those Museum Studies and Cultural Management programmes who were more willing to '... embrace such visualizations as part of their didactic mission to educate lay audiences.' (Favro, 2006) Nevertheless, those departments sceptical of such imagery have used and benefitted from the application of many new digital tools; tools that allowed for the detailed and systematic storing of, extant and recordable data; for example, material analysis, range scans, GIS or surface/subsurface topologies.

Though embraced within the heritage industries, critics argued that the seductive richness of digital visualisation could often overwhelm what actually remains of an artefact. It could distract and subsume real knowledge with a powerful combination of hyper-reality, animation, sensory stimuli and interaction, what Favro described as '...veracity, aestheticization, and false viewing.' (Favro, 2006)

2.5. The Wider Critical Debate

As discussed earlier, this scale and pace of change has informed an almost continued appreciation of and interaction with such technologies, forming and reforming an ever new dialogue with such visual worlds. The continued development of such technology has advanced opportunities to consider such worlds with greater fidelity and in a more immersive way. Exploiting three and four dimensional digital tools has helped extend and expand our experiences and interaction with entertainment and knowledge based industries to an unprecedented extent.

In extending this knowledge, such rapid development has also played a part in our ability to record, illustrate and interpret the past. Although the focus of this research is largely concerned with the generation of assets for public consumption and not the conservation and digital archiving of archaeology, the project does bring into focus some of the debates surrounding how, when and indeed if, such remediation and reconstruction should take place.

Within the context of heritage artefacts, some of this discussion surrounds the veracity of such reconstruction and, what Taylor and Unver describe as constituting 'worthy content'. (Unver, 2009) For there can be many interpretations of the scientific data, that may include issues of context as well as historical record, but all may be leading to differing reconstructions. In her thesis *A Necessary Duty, a Hideous Fault: Digital Technology and the Ethics of Archaeological Conservation*, Anne Hathaway-Smith states:

'...the replacement of an object with a replica reduces the cultural relevance of the artefact and substantially changes it....particularly since these images are often "over-restored", and the lay-public has no easy means of distinguishing the accurate parts of the reconstruction from those which are inaccurate or have been manipulated. (Hathaway-Smith, 2010)

Such questions are not new and follow the expansion of public interest in history and heritage in the West in the last 40 years. Issues now discussed within the realm of digital remediation follow some of the debates held regarding the veracity of the visual image within film and television documentary. Ethical issues surrounding truth telling have led to a conclusion that by virtue of the process of any mediation, it becomes impossible to construct a truthful reality without a narrative becoming fictional in places. The limitations of visual representation; particularly in the case of history, argue many academics, among them Ian Jarvie and R.J. Raack, debate either the pre-eminence of text or the primacy of image in describing the truth. (Rosenstone, 1986) In his book *Introduction to Documentary*, Bill Nichols defined six modes of documentary and stated that documentary film, is one of the "discourses of sobriety" that include science, economics, politics, and history-discourses that claim to describe the "real," to tell the truth. The ethical issues surrounding truth telling has led to a conclusion that by virtue of the process of any mediation, it becomes impossible to construct a truthful reality without a narrative becoming fictional in places. (Nichols, 2001)

This tension is one that has occupied the minds of some of the great thinkers since the Greeks. It found resonance with Renaissance artists and critics when re-discovering some of the great sculpture from antiquity and found perhaps the best example surrounding that of The Laocoön Group (Fig 5). Its provenance, its sculpture and its repair have been a central focus for such discussion for over 550 years. The Laocoön offers a powerful example of the development of the conservation of art, art criticism and aesthetics, the impact on

representation and the ever-renewing practices of interpretation and inter-subjectivity; as well as notions of reception, meaning, significance and simulacrum.



Figure 5: The Laocoön and his Sons

Therefore, within the remediation of the Tomb of Sir John Neville therein lies a similar debate, one that asks fundamental questions as to the place of any heritage reconstruction in the dissemination of historical facts and truths. The Laocoön's multiple restorations demonstrated the tensions between the artists desire to apply their own interpretations upon the group, against the careful gathering of the evidence as to the intentions of the original sculptors. (Fig 6)

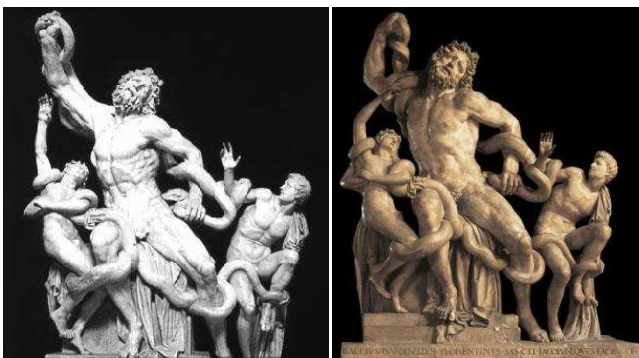

Figure 6: Demonstrating attempts at reconstruction of the Laocoön

The group acted as an example of changing aesthetics in the appreciation of sculptural form. It provided fierce critical debate regarding the representation of pain and the nature of aesthetics. Artists and critics including Lessing, Winckelmann and Goethe speculated upon its origins, referring to early texts by Pliny to establish its provenance. The poet William Blake believed the sculpture to be a poor copy of a lost Israelite original (McCarthy, 2007) and it's has even been suggested by Lynn Catterson, a Columbia art historian, that the sculpture was a forgery created by Michelangelo. (Catterson, 2005)

It provided for speculation regarding the application of polychrome upon marble and formed the focus of debates on humanistic philosophies that occupied the minds of some of the greatest western critics and philosophers.

In addition, it was the discussion around the representation of the depiction of pain in the face of the Laocoön that introduced an early scientific response to the study of ancient art and artefacts, through the work of Guillaume Benjamin Duchenne and his study of muscle stimulation via the application of electrical current. (Fig 7). Duchenne points out that his experiment has not only scientific but aesthetic worth because he “corrects” the mistake of the furrows on the forehead of Laocoön which are too long for this particular emotional state. (Parent, 2005)

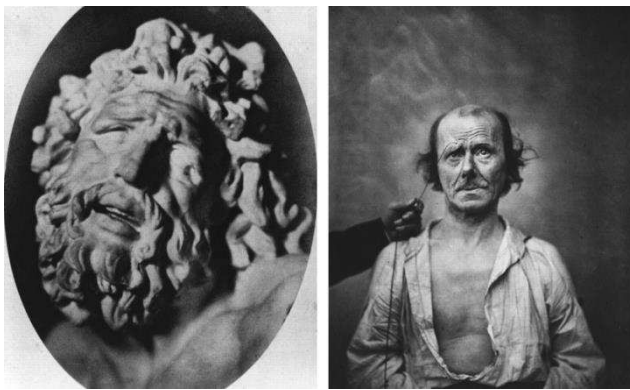

Figure 7: (Duchenne: Discourses of Aesthetics, Sexuality, and Power in Nineteenth-Century Medical Photography, Hayes P. M.)

Since the start of the 20th century debates began the shift from the artist to the spectator and therefore the: ‘Subjectivist precondition for the aesthetic conception of art emerges.’ (Wallenstein, 2010) Through the influence of Darwin and the subsequent development of psychoanalysis and Marxist theory, our relationship to long established notions of God and self were challenged. The subsequent move towards a Wiggsteinian linguistic approach to philosophical thought began the paradigm shift in the primacy of linguistic analysis. More recently localised narratives or *petits récits* (Lyotard, 1979) have been deemed liberating and democratising. This multifaceted approach to the deconstruction of culture has occupied post-structural and post-modern thinkers and formed critiques of disciplines such as history, and therefore art history. Moves towards a multitextual view of cultural artefacts began to be applied to the consumer society of the late 20th century. Jean Baudrillard’s work on the dissemination of information through mass communication and his system of objects and symbols began an assessment of consumption and how objects become signs. This has led to a scathing critique upon ethnology in particular and science in general. In the case of the Laocoön one could argue that Baudrillard’s position would be that all of the several acts of remediation over the years are acts of artificiality; a ‘supplementary subterfuge’; the very last

act in 1960 being the one that takes us the furthest away from the truth? The advent then of digital tools that offer virtual remediation and visualisation to the highest fidelity, are in no way different in their inability to offer 'truth', than the application of the real arm back on to the real sculpture in its real position.

However, there are some that would argue against this critique and 'reclaim' the Laocoön from the clutches of the post-modern. Richard Brilliant's *My Laocoön: Alternative Claims in the Interpretation of Artwork* tries to draw the argument back to what he refers as:

'my sense of the persistence of a singular, material entity, the sculpture, in the face of diverging conceptual entities'. (Brilliant, 2000) These are a series of mental entities of interpretation that follow the response to the sculpture at key points in history.

Once again there is a concern regarding the textual and the image and Brilliant acknowledges that 'readings of the texts and artworks of the past are necessarily implicated in the reader/viewer's present concerns and, at the same time, have the potential to change the reader/viewer.'

In returning to the digital context, the Laocoön is still the focus of research. Bernard Fischer's Digital Sculpture Project has produced a digital reproduction of the sculpture (Fig 8)



Figure 8: Digital Sculpture Project. Laocoön

It is perhaps worth noting that the Laocoön's continued impact upon digital world, not only do we have an example of a digital reconstruction, but the finer points of its representation of human suffering can be seen - intentionally or not - in its influence of the Digital Sculptor Scott Eaton: Digital Sculpture Prometheus (Fig 9) mentioned earlier.



Figure 9: Scott Eaton: Prometheus (detail)

2.6. The Heritage Industries

Many of the larger debates regarding post-modern approaches in recent years have filtered down to notions of heritage and history and the subsequent development of what Robert Hewison in 1987 disparagingly called, *The Heritage Industries*. (Hewison, 1987) In his critique he argued that deindustrialisation, globalisation and the impact of migration and immigration played a significant part in this burgeoning interest in heritage. A deep-seated sense of rootlessness and fear of the future encouraged the post-industrial affluent west to turn to the certainties of the past.

Increasingly critics have argued that as we live in an ever more disposable world, there is an ephemeral nature to much of what passes through our lives. Modern throwaway culture, technology and materialism along with issues around globalisation, the ubiquitous ease of mass communication and a lack of trust within our present institutions, has combined with a dwindling lack of religious faith or sense of community, even of national identity. This, it is argued, has driven the need for many to seek some of those missing elements in engaging with the heritage experience?

Such profound sense of loss was also commented upon by the academic Patrick Wright. In his book *On Living in an Old Country* (Wright, 1985) published some two years earlier than *The Heritage Industry*, Wright voiced concern with the increasing 'museumification' of the UK, and the ways in which heritage might act as a distraction from engaging with the issues of the present

In August 2012 I was able to visit Colonial Williamsburg (Fig10) and experienced at first hand some of the issues that surround a large scale re-creation of the past and experience some of the issues that Wright articulated.

At the time I was unaware of the extent of reconstruction that had taken place in the development of the site. As I later found out, during its construction approximately 730 buildings were removed at Williamsburg; 81 were renovated and 413 were rebuilt on the original sites after a decision was made to 'restore back' the town at a point in history no later than 1790. (Fig 10 and 11) 'Restoring back' involves the re-creation of a place as someone thinks it was, or would like it to have been, eliminating all else that was not there at the time, exactly the content of which real history and art are made.



Figure 10: A photograph taken on my visit in August 2012 shows the reconstructed Governors' Palace.

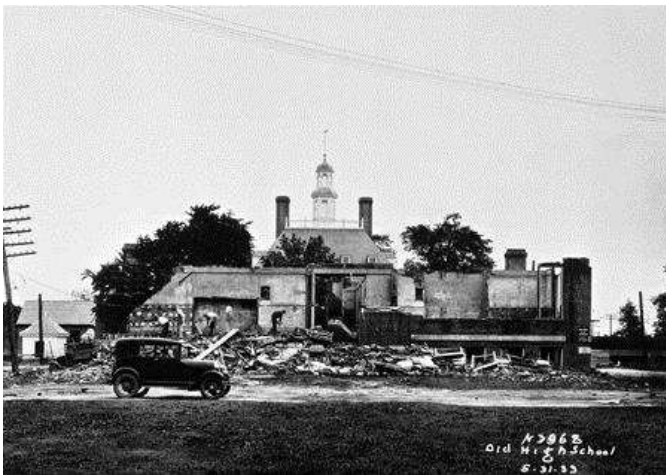

Figure 11: The Demolition of Matthew Whaley School, Williamsburg, Virginia, to make way for the reconstructed Governor's Palace, early 1930s

Ada Louise Huxtable in her critique entitled; *The Unreal America: Architecture and Illusion*, has pointed out, 'within a conscientious range of those deliberately and artfully set limitations, a careful construct was created: a place where one could learn a little romanticized history, confuse the real and unreal, and have--then and now--a very nice time.' (Huxtable, 1993)

With its artful recreation, its elimination of what might be considered the historically inappropriate, for its tasteful cleaning up of the streets, its staged events and its incorporation of commercial shops and restaurants, Colonial Williamsburg has been sometimes criticised as an example of the Museumification or Disneyfication of heritage.

It might be interesting to reflect on the digital alternative to Colonial Williamsburg, that of the Virtual Virginia Project. Run as part of the University of Virginia's Digital Sculpture Project mentioned earlier, and another project of Frischer's work at the Institute for Advanced Technology in the Humanities (IATH). Being developed here are effective procedures that are applied to virtually reconstructing the past and have resulted in major projects such as Rome Reborn (Fig 12), begun in 1997 alongside the more recent Virtual Williamsburg.



Figure 12: Procedural model of Rome Reborn: The Circus Maximus from the Southeast

The Williamsburg project offers an interesting example of where a virtual immersive engagement might provide a more informative experience than that of the actual site. Further, it is representative of an approach rooted in traditional notions of Humanism, those that Bernard Frischer himself refers to the 'digital humanities' and their place within modern approaches to the cataloguing of the human record. The Virtual Virginia Project interactive models will be linked to data sets—research reports, images, manuscripts, archaeological and architectural catalogue records related to each site. Although like its 'real' counterpart, the goal of the project is to model the entire town as it appeared in 1776 it will at also model other key points in the town's history. (Fig 13)



Figure 13: Douglass Theatre model from Virtual Williamsburg, 2007: The Colonial Williamsburg Foundation.

Here perhaps is an example of the application of metadata allowing for a multifaceted and layered approach that enhances and informs the visual experience. It may offer a flexible and easily updatable knowledge base that can provide contrasting interpretations to the experience and may be a part of a strong counter argument to the ‘false’ history polemic of Hewison and Wright. One that was offered by academics such as John Urry and Raphael Samuel, rejecting the notions of conservatism and arguing that the heritage industries can offer a kind of democratisation of the past.

Although the context of their argument was in regard to the National Trust view of ‘Country House’ Englishness, Urry and Samuel countered that increased points of access to such sites coupled with an interest in ‘below stairs’ life has encouraged people to look down rather than just up in reconstituting their roots. Samuel was quick to emphasise heritage not only as a potentially democratic phenomenon, but also to see in the social practices surrounding heritage the possibility for promoting social change. (Harrison, 2013)

There is therefore a complex set of interconnected argument and counter-argument that runs throughout the development of visualisation generally, as well as the more specific application of digital tools and their use in reconstruction. These exist alongside the wider debates regarding the development of the heritage industries. Virtual reconstruction, with its ability to encompass and communicate a range of arguments, positions and nuances, should provide a medium of communication that allows for such diverse positions.

Within the context of my research it would be appropriate to re-state that its location is rooted firmly within the locus of digital humanities perhaps best expressed earlier by Bernard Frischer. In acknowledging the wider debates around Virtual Reconstruction my research is to examine a workflow that may prove beneficial to those engaged in the process of historic

remediation and, in its outcome it is acknowledged that it would fall foul of some of the arguments outlined above. However, with appropriate input from those specialists engaged in the many fields that could encompass such a project, it may yet form the basis for a contribution to wider public understanding of medieval tomb effigies.

3. Application of Technology to the Field

Early 3D computer visualisation examples, such as the Bath Temple Complex, demonstrated this new technology but were more likely to be produced in partnership with universities, where expensive computing facilities and engineering expertise was available. The introduction of the desktop computer launched in 1981, and the subsequent software developments in CAD applications, including for instance the launch of Autodesk in 1982, meant greater access to the tools required and resulted in a wider application across the digital humanities.

In combination with digital scanning technologies, the development of new workflows and standards were created, resulting in tools and applications being integrated to provide a workshop approach to projects. As more powerful software became available, interoperability between them was increased and the result was a spectrum of possible outcomes from data recording, via scanning technologies of extant artefacts, to the production of not just static visualisation, but animation, light simulations, immersive engagement and tactile outcomes via rapid prototyping. Where visualisation was required, the application of scanned data became, when available, a starting point from which to extend the re-creation of the artefact.

3.1. 3D Surface Data Acquisition

Rapid developments in the connectivity between three-dimensional (3D) software and hardware allows for quicker, easier applications of 3D scanning technologies and other virtual technologies have made possible the acquisition, and the reconstruction of complex surfaces in many disciplines such as reverse engineering (RE), prototyping, 3D printing, manufacturing, medical sciences, terrain mapping and cultural heritage.

Over the years scanning technologies have included contact scanners based on mechanical sensors and non-contact digitizers based on optical technology. These had been developed from the 1960's and Optical technology was generally preferred right up to the 1980's and early 1990's as it gave a greater flexibility in the digitization of surfaces and provided for higher resolution and accuracy.

Based mainly on stereovision, it used 2D images taken from cameras at different view angles to reconstruct the surface of the object. (Clowes, 1997) An example of its application can be seen in the Photogrammetry survey conducted at Stonehenge in the mid 1990's (Fig 14). Such data was later applied to the digital constructions such as Unver and Taylor's Virtual Stonehenge; an interdisciplinary art and design project involving music technologists, sculptors and game designers. (Unver and Taylor 2012)



Figure 14: Point Data from Photogrammetric study of Stonehenge. Surveying Stonehenge by Photogrammetry

Although still immensely useful, the accuracy of the reconstructed surface was relatively poor in comparison with the newer Terrestrial Laser Scanning (TLS) technology. Developed from applications in the field of Airborne Laser Terrain Scanning, it allowed for the measurement of several thousand points per second allowing data sets to be collected far in excess of that, which could be obtained by traditional surveying or photogrammetric techniques (P. Riley and P. Crowe, 2006).

An early example of large scale laser scanning in the field was undertaken by the Digital Michelangelo Project. Staff and students from Stanford University and the University of Washington spent the 1998-99 academic year in Italy scanning the sculptures and architecture of Michelangelo (Fig 15). As early as 1996 a group at the National Research Council of Canada was regularly scanning museum and heritage artefacts. However, nobody had digitized a large statue with enough precision to serve as a primary resource for scientific work, and nobody had tried to digitize a large and coherent collection of statuary. (Prof. Brian Curless, 2009)

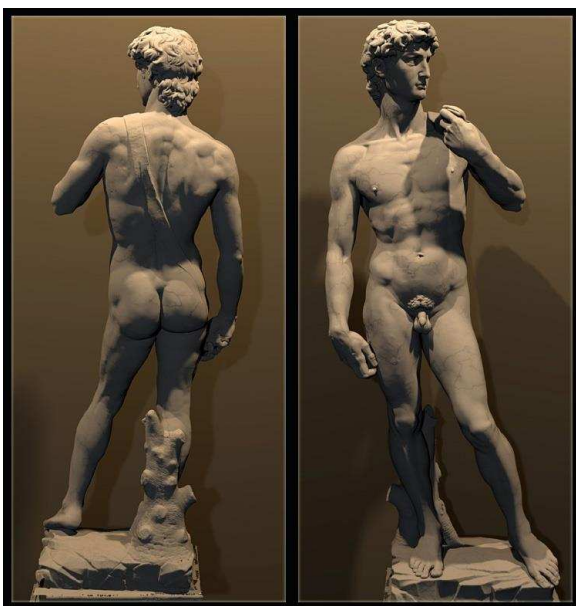

Figure 15: Digital Michelangelo Project, Laser Scan

Although successful, the project outcomes raised issues at the time around the size and therefore the storage and manipulation of such large datasets. It also highlighted problems of secure archiving and storage, as well as indexing, searching, distribution, viewing and of piracy protection.

As recently as 2012 English Heritage returned to Stonehenge to complete another scanning survey of the site. (Abbot, 2012) The results highlight the advances made both in the greater data acquired and the ability to manipulate such data on more powerful hardware platforms. Mesh density was achieved in some scans of 0.5mm and a full scan of every stone at 1mm. (Fig16) Manipulation in real time with the application of different lighting. 'Surface areas were visualised, identified and distinguished' including tooling, fine and coarse surface finishes and prehistoric rock art.

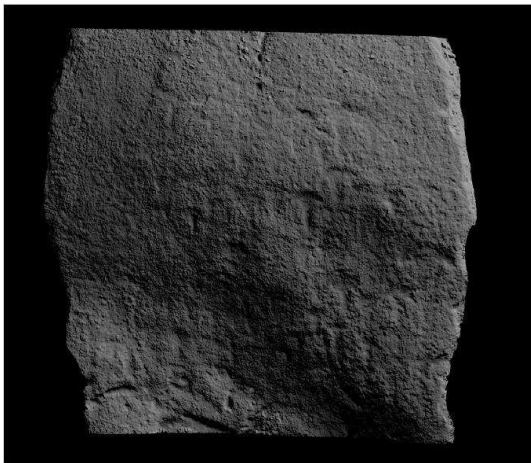

Figure 16: Laser scan showing sequence of shadows cast on stone 4

The method of capture mentioned above, that of Photogrammetry, is as old as photography itself, and has re-emerged as an exciting method of capturing surface data without the use of the more expensive, and in some cases cumbersome laser-based technologies.

A rather confusing definition of photogrammetry was given by Toni Schenk in Introduction to Photogrammetry. Here Schenk states, 'There is no universally accepted definition of Photogrammetry. In its widest sense the definition given below captures the most important notion.

'Photogrammetry is the science of obtaining reliable information about the properties of surfaces and objects without physical contact with the objects, and of measuring and interpreting this information.' (Schenk, 2005)

This broad statement could then apply to the acquisition via laser scanning previously described. Although Schenk does go on to add; 'The input is characterized by obtaining reliable information through processes of recording patterns of electromagnetic radiant energy, predominantly in the form of photographic images' (Schenk, 2005)

For the purposes here of differentiation I would include the words 'from photographic images' into the definition, as my research will use both laser and photogrammetric approaches to data acquisition.

Much of the early work in Photogrammetry was done as part of terrain mapping and was further extended by the introduction of stereophotogrammetry in surveying and other mapping methods. With later developments in computing, block adjustment programmes allowed for greater accuracy and speed in plotting data. More recently still, and of particular interest to this research, has been the development of remote Photogrammetry cloud processing using applications such as 123D Catch.

During the summer of 2010, Autodesk released a still ongoing project called Project Photofly. Later to become 123D Catch, it was freely downloadable from the AutodeskLab web site until August 2011. Project Photofly based on computer-vision and photogrammetric principles, exploited the power of cloud computing, as a web service able to convert collections of photographs into 3D models.

123D Catch is a web service technology and the user installs the “Photo Scene Editor” to upload images, and to modify manually the photo-scene returned by the system. Although photographs can be shot with a variety of cameras and various focal lengths, the recommendation is to use the same camera and the same zoom ratio for the entire scene dataset. The system computes the photo-scene and sends a sparse point cloud back to the user. The server stitches the camera positions, and photographs together using a series of computer vision algorithms called the "Camera Factory". Additional features can be applied locally after the download, and the final model can be eventually exported. (Fig 17)

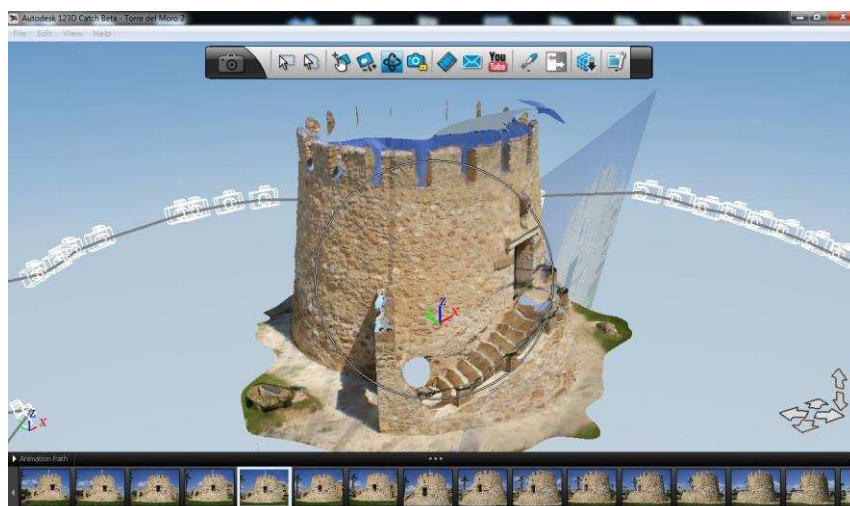

Figure 17: Example of Photo Scene Editor in Autodesk's 123D Catch: Autodesk Discussion Groups

3.2. Digital 3D Modelling

With advancements in processing power via Graphics Cards (GPU) and chipset (CPU) development; and with greater (RAM) memory and storage capacity, the ability to manipulate data in the form of a polygon mesh has increased greatly. A significant impetus in the development of these technologies is driven by the need within the science, engineering and digital entertainment industries and continued advances can be highlighted, in the context of this research, by the visual fidelity that had been achieved in recent years over the early examples described in the section 2.1.3 Early Digital 3D Visualisation.

Early 3D CAD systems were often developed for use within the automotive and aerospace industries. Figure 18 demonstrates a CATIA model developed by Chrysler in 1983. It can be seen from this early example the outcomes are akin to technical 2D drawings. Contrast then a much later example of use of CATIA to the right of this image and one can appreciate of the nature of this increased level of fidelity in comparison.

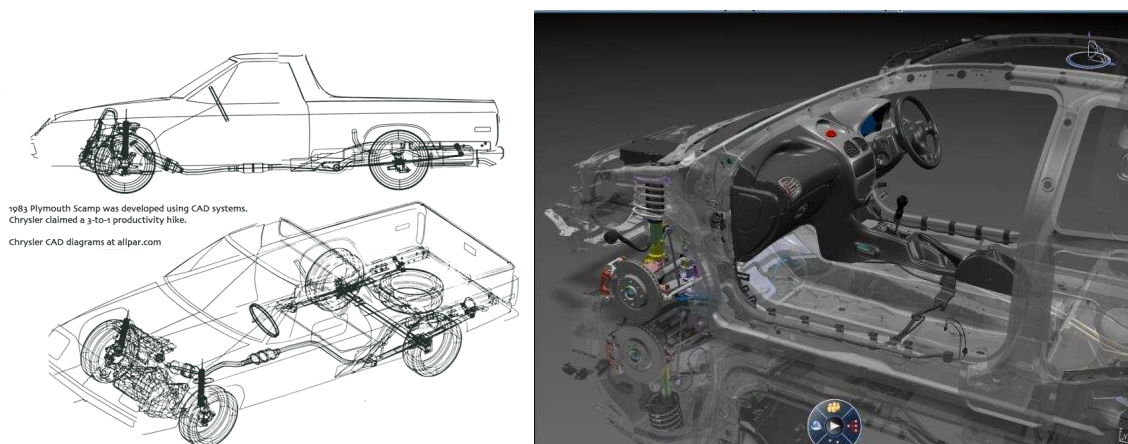

Figure 18: CATIA (Computer Aided Three-Dimensional Interactive Application) and was developed by the French aircraft manufacturer, Avions Marcel Dassault, in 1977

From these powerful and expensive tools, the development of 3D software has expanded to more affordable and less specialist general modelling platforms. These applications have over a period of time become a multipurpose toolset that can include not only modelling but animation, texturing and rendering functions all under one interface. 3D Studio Max, Maya, Softimage, Blender and many others, including some that are distributed for free, have made 3d modelling affordable and accessible to ever more users.

Amongst the most successful modelling applications, and those much used within the field are Autodesk's 3D Studio Max and Maya.



Figure 19: Computer reconstruction and a view of Kalabsha as it appears today.

In the image above (Fig 19) we can see an example of the use of Autodesk Maya in the visualisation of ancient buildings. The application of texture rich detail in conjunction with accurate lighting provided for an almost photographic recreation of the temple. Indeed, part of this project was a close examination of how realistic period lighting effected the ambiance and atmosphere and therefore the experience of the contemporary individual within the confines if the temple rooms.(Fig 20)



Figure 20: Reconstructed hieroglyphics lit by (a) modern lighting and (b) a sesame oil lamp.

For the purpose of this research, Autodesk 3D Studio Max will be the preferred polymodelling application. Content will be initially developed here before being exported to a digital sculpting package for further refinement.

3.3. Polychrome

Below (Fig 21) we can see that the application of polychrome is often only faintly observed or missing entirely from artefacts. Yet the surface treatment of classical and medieval sculpture with colour has been recognised to be integral to the whole effect of the sculpture and it has been argued by Vinzenz Brinkmann that this application had been acknowledged as far back as the Victorian period. (Vinzenz Brinkmann, 2008)

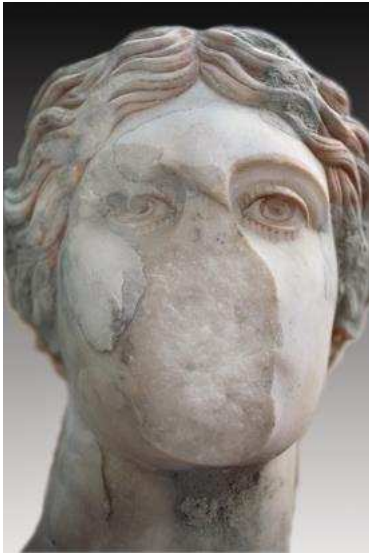

Figure 21: Head of an Amazon, from a life-size statue discovered near the Nonius Balbus Basilica at Herculaneum,

Work such as Lawrence Alma-Tadema's painting, *Pheidias and the Frieze of the Parthenon* (1868-69) or John Gibson's life-size statue *Tinted Venus* (1851-56) with its very subtle application of colour acknowledged its existence, but did little to impact upon the prevailing pure white aesthetic of the day. It is interesting to note that such an aesthetic did not extend beyond this belief in the whiteness of sculpture; the Victorians being noted for surrounding themselves with an extravagant and opulent application of colour in much of their domestic and public life.

The catalogue to the exhibition 'Gods in Colour: Painted Sculpture in Classical Antiquity' cited the critic and philosopher Johann Joachim Winckelmann who observed that "The moderns ...are, from stupid custom, reconciled to the white statue. The flesh is white, the hair is white, the eyes are white, and the drapery white; this monotonous cold object of art is out of harmony with everything which surrounds it. (Ebbinghaus, 2007 - 2008)

Vinzenz Brinkmann goes on to cite David Batchelor's claims in his book *Chromophobia*, that 'In the turmoil of the twentieth century – and certainly also on account of severe traumatisation through genocides and excessive military violence in the midst of a "humane" world –, the culture-upholding citizen turned his back on ornament and colour.' (Batchelor 2000)

Batchelor argues contentiously that the 'chromophobic impulse - a fear of corruption or contamination through colour - lurks within much Western cultural and intellectual thought. ... Colour is purged, either by making it the property of some "foreign body" - the oriental, the feminine, the infantile, the vulgar, or the pathological - or by relegating it to the realm of the superficial, the supplementary, the inessential, or the cosmetic'.. (Batchelor 200)

Whatever the reason, there is no doubt that still to this day, the white aesthetic is considered the norm. For many non-specialist observers it comes as a visual shock when, through application of paint to reconstructed 3D models, we can see the extent and vibrancy of the colour on some of the most iconic sculpture from antiquity. (Fig 22)



Figure 22: "Alexander" Sarcophagus, detail of colour reconstruction: a Persian and a Macedonian fighting.

Where none now exist, digital reconstruction could add to the, '.... completion of marble sculpture with features in bronze, lead, stucco or wooden accessories: weapons, armour, sceptres, hair, beards and jewellery and these materials were added to a wide range of sculpture from all periods. (Bradley, 2009)

3.4. Digital Sculpting

In more recent years the addition of digital deformation software to the poly-modelling applications mentioned above, has allowed for much greater resolutions to be achieved. This high resolution has allowed for far greater detail to be realised and the experience of using it captures something of the qualities and elasticity of clay, Software such as Mudbox, ZBrush, 3D coat, Sculptris and Silo have the ability '...to deform a mathematically-defined solid in a fashion that loosely simulates the physical moulding of an inelastic substance...

Virtual sculpting combines this emulation of clay sculpting with interactive feedback.' (Gain, 2000) This approach is one that allows for a more natural, tactile 'feel' for the user experience, and one that may draw on a user's familiarity with traditional sculpting.

Two of the most widely exploited packages, both used as part of this research, are Pixologic ZBrush and Autodesk Mudbox. ZBrush is perhaps the most popular of the two, having been developed by Ofer Alon and Jack Rimokh at Pixologic and presented in SIGGRAPH in 1999. Mudbox, co-developed by Dave Cardwell at Skymatter, a breakaway company of the WETA Workshop, was first used as part of WETA's CGI work on the remake of Peter Jackson's motion picture King Kong in 2005.

The demo version of ZBrush 1.55 was released in 2002 and preceded the launch of Mudbox by around 4 years. It therefore had a significant advantage in development and release times over its main rival. This largely reflects its more ubiquitous use within CG pipelines and its greater usage and consequent support base and forum activity over its main commercial rival. However, Autodesk's considerable presence as the biggest provider of industry standard modelling and animation software, has allowed for the introduction of free educational only licences that can establish early adoption by potential future professionals. The design of Mudbox has been developed with a far more streamlined user interface (UI). There are some who point to the tendency for ZBrush to become a 'one stop' application; with subsequent problems around complex UI and drift into 'bloatware' or a 'behemoth' package. Mudbox, with its more limited functions has, alongside its pipeline integration to existing Autodesk products, become more widely used within industry in recent years. Both applications have their strengths and weaknesses, but for this research I have chosen Mudbox for its integration both with existing software and its use in my current pedagogy.

The examples below will give an appreciation of the range of outcomes that can be developed using such software. Still predominantly used within film and games, Figs 23 and 24 give an indication of their professional application. The seductive and tactile nature of the process involved has encouraged a wide uptake within the realm of amateur sculptors and



Figure 23: Scott Patton _Concept Design ZBrush Sculptures for Motion Picture Avatar 2001



Figure 24: Character creation for Ubisoft's FarCry 3 using ZBrush

'fan artists'. With its less structured and demanding workflow, it can be deemed an easy entry into high level modelling, with mixed results. Without the underpinning art, design and visual awareness skills no amount of technical knowhow will enable the user to develop outcomes such as Fig 25 and Fig 26.

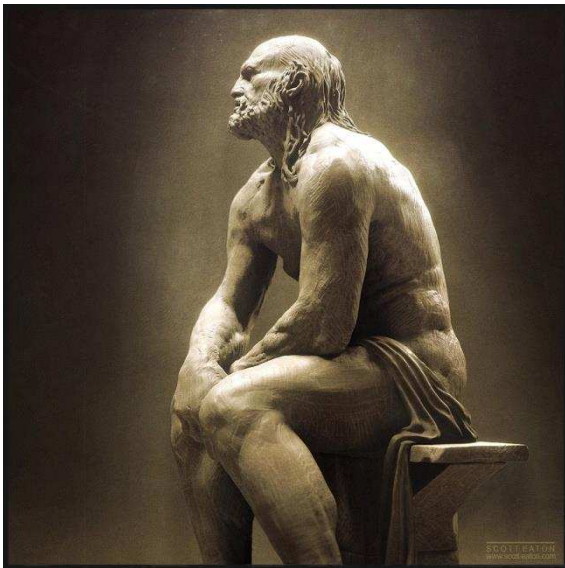

Figure 25: Scott Eaton, Digital Sculpture



Figure 26: Meats Meier, Digital Illustration

Increasingly, these tactile and intuitive properties are also attracting an increasingly wider group of artists and designers in such areas as jewellery and product design. As can be seen in Fig 27, they are embracing this medium in conjunction with digital scanning and rapid prototyping technologies.



Figure 27: Examples of jewellery and product design using Digital Sculpture

Alongside commercial designers, fine artists and sculptors are also engaging with these processes, although beyond the use of particular software packages, they still remain under the umbrella of 'Digital Sculpture'. Artists such as George W Hart and Kenneth Snelson with interests and backgrounds in mathematics and the sciences have exploited digital tools to generate constructive geometric forms based upon mathematical formula. Fig 28 and Fig 29.

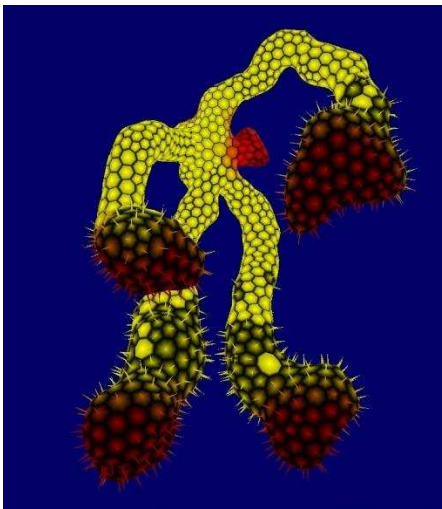

Figure 28: Kenneth Snelson 'C60'

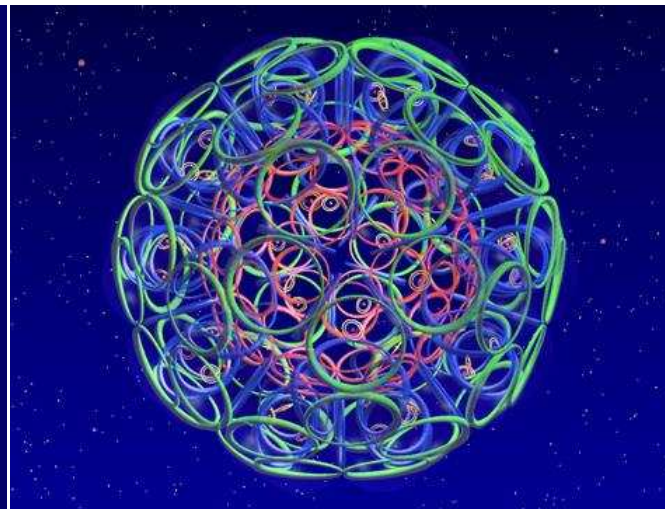

Figure 29: George W. Hart 'Spikey Guy'

Initially generated and displayed within the virtual space of the computer, what William Ganis describes as 'computer monitor's proscenium arch', (Ganis, 2005) their work has broken free from the confines of the screen and can now be reproduced as tactile models in the real world thanks to advances in 3D Printing technologies and Computer driven CNC Milling machines.(Fig 30)



Figure 30: Dan Collins Twister. Original scan data and Finished CNC foam with polyurethane coating

3.5. Rapid Prototyping/3D Printing

As can be seen above, digital sculptors are beginning to exploit technologies previously located within the realms of science and engineering. Rapid Prototyping (RP), Computer Numeric Controlled (CNC) milling and other machines are now standard equipment in engineering and industrial design laboratories. These allow for objects that were previously locked into the virtual realm to become physical objects, both small scale prototypes, and increasingly in some cases full scale finished products, what is now being termed rapid manufacturing.

Ganis further states that 'This ontological shift is profound, since these objects of resin, polyester, or other materials are crossovers from another plane of existence—they are paradoxes of a virtuality that, up until this point, has been a one-way looking glass.' (Ganis, 2005)

The impact of these technologies has been developing apace in recent years and its impact is being felt across many diverse disciplines. Beyond the tactile production of artefacts such technology is being used to manufacture buildings using sand as a base material. Fig 31.



Figure 31: RP Manufacturing: Sand bound together to create a marble-like material

Areas such as reconstruction from medical imaging data (Fig 32) and micron-scale RP (Fig 33) are being explored.



Figure 32: Artificial knees manufactured the specific contours of bones

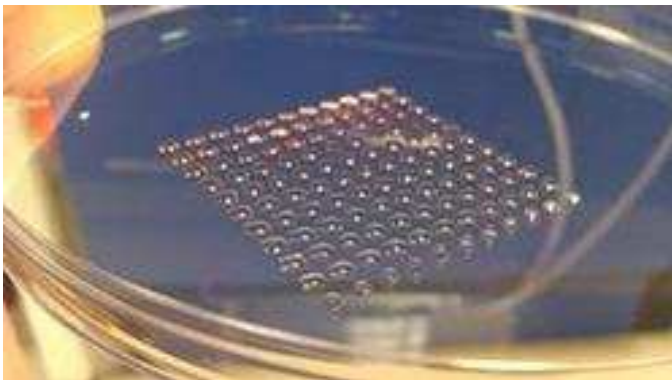

Figure 33: 3D printing of clusters of stem cells towards creating artificial organs

Examples of digital material sculpting can also be reductive also. Increasingly Digital CNC milling machines are able to create ever finer sculpted works, sometimes on a massive scale. (34)



Figure 34: Example of Digital Sculpture produced via CNC Milling, Entry Plaza, New Jersey Emergency Operation Center

One interesting application has been the use of RP in heritage to allow for the visually impaired to experience something of the architectural or sculptural surface of a building. Laser scanning technology was used to capture the data of the Gatehouse at Thornton Abbey. This data was then manipulated and fed into a rapid prototype machine to create an actual physical model of the artefact. The plastic model is a detailed replica which is held in the hand and enables users to experience the abbey through touch. (Fig 35)



Figure 35: University of Hull: Rapid Prototyping for the Partially Sighted

As part of this research project, an intention was made to allow for the production of a sample 3D printed outcome. An opportunity to explore this would provide an alternative workflow outcome and could provide a similar example as above.

4. Experimental Study

4.1. Project Intentions

The intention of this project is to examine workflows involving 3D sculpting tools in the illustration of heritage artefacts. As mentioned in earlier chapters there has been widespread use of 3D poly modelling software over recent years and the re-creation and illustration of historic artefacts. However, the more recent development of high resolution sculpting software affords the chance to create digital outcomes with a degree of surface fidelity not previously obtainable from the more widely used poly-modelling packages.

Position of Research in Relation to some Common Practice in 3D Digital Heritage Illustration

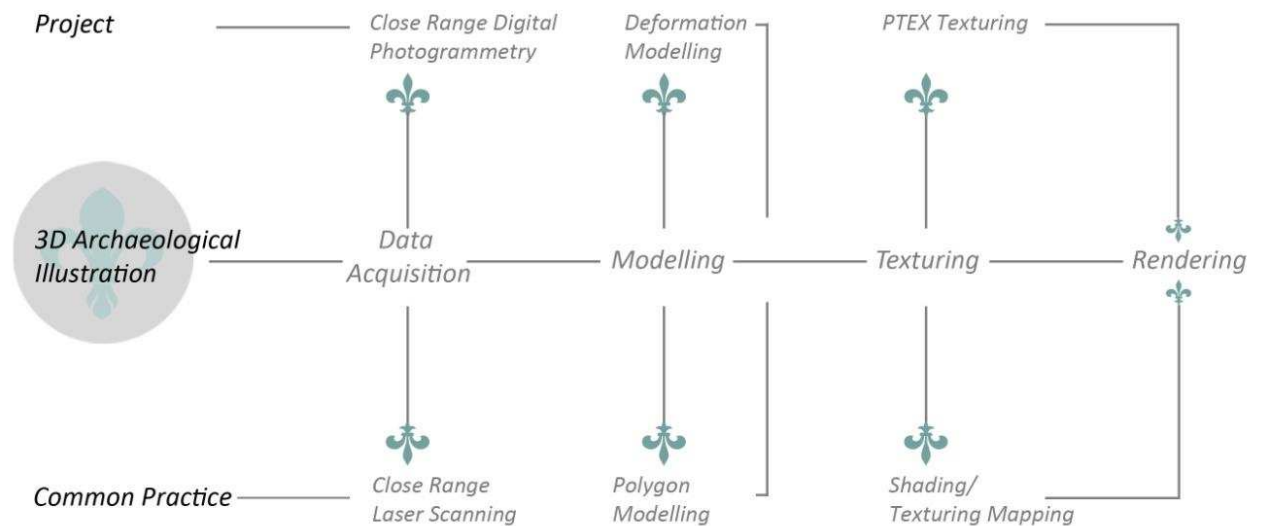

Digital models can be broken down into three types:

- Polygonal models are made up of a collection of points, edges and polygons.
- NURBS surfaces consist of a network of curves with smooth surfaces between them.
- Subdivision (SubD) surfaces are similar to polygonal models because they are made up of points, edges and polygons but also share some of the benefits of NURBS surfaces, placing them into their own category.

Further, digital modellers are often categorised as hard-surface or organic modellers and can sometimes entirely specialise in one or the other types of outcome.

4.2. Hard Surface and Organic Modelling

This distinction can make it easier for studios looking for right digital modeller for their specific modelling needs. A 3D mesh can be grouped or classified as either a hard surface or organic. Yet, what defines an object as either can be difficult.

In his book [Digital] Modeling, William Vaughan uses the following distinction:

'Characters, creatures, plant life, and more naturalistic environments are organic models, and architectural environments, vehicles, and mechanical products are hard surface. This is very loose as a definition, and as I've tried to emphasize, the lines between the two are indeed very blurred.' (Vaughan, 2012)

This project intends to reflect something of this definition in its approach. For the most part the 'hard surface' qualities of the tomb base will predominantly be modelled in the poly-modelling application 3D Studio Max. Whereas the effigy will be sculpted in the deformation modelling package Mudbox, in keeping with the nature of the organic human form and loosely reflecting something of the qualities of sculpting upon a single object.

Software employing digital sculpting tools includes; Mudbox, ZBrush, Blender, Silo, 3D-Coat and Modo, a number of these have been successfully used by the film industry. Their ability to use millions of polygons utilising a brush-based system that allows for the creation of, highly detailed meshes that were not possible until recently. Although these high-poly meshes are used in their own right, they are also applied as source material to enhance low-poly models used in real-time games with the use of normal maps. This mapping option uses pixels containing the high-res mesh data to fake the lighting of raised and recessed areas on a surface, which allow for low-resolution game models to display the details of a high-poly sculpt.

Although focused upon the high resolution sculpting, this project outcome offers the possibility through further research to exploit such approaches and to offer wider options for visualisation utilising game engine technology.

4.3. Background and Context

The project began with the selection of a suitable artefact that would allow for such research. In an unrelated visit to Durham Cathedral I was able to view the tomb of Sir John Neville, (Fig 35) located in the cathedral's south aisle.



Figure 36: The tomb of Sir John Neville

The Nevilles were long established as one of the great northern families alongside their rivals the Percies. They became the focal point of efforts to stabilise the North against long standing disputes with the Scots. Much of their influence in later generations was the result of the political successes of Sir John's son Ralph Neville, first earl of Westmorland, and his rise to prominence in this period was the direct result of his Lancastrian associations cultivated by his father. (Arvanigian, 2000) A man with a history of the greatest political influence, John Neville served as steward of the household under Edward III, and sat on the king's privy council from 1371-6. Although he was expelled from the court of Edward III by the 'Good Parliament' in 1376 along with Richard Latimer, he maintained a powerful and influential protector in Edward's son the founder of the House of Lancaster, John of Gaunt. The symbol of this allegiance can be commonly seen on many alabaster tombs of this period through the inclusion of the Lancastrian 'Collar of Esses' livery collar, usually depicted on a chain around the shoulders of the effigy. It can be seen here (Fig 37) displayed on the tomb of John's son Sir Ralph Neville, at his tomb in Staindrop Church, C. Durham.



Figure 37: The Tomb of Sir Ralph Neville: Staindrop Church. Raby, Co Durham.

It would appear that this 'Esses' collar would not have been common around the time of the carving of Sir John's tomb, although the earliest depiction is 1371, (Knowles) and there

seems to be little evidence from the remains that it played a part in the design, becoming more common during the following century.

What struck me at the time was the degree of damage inflicted upon the tomb, and upon discussion with Cathedral guides there seems to be conflicting opinion as to how the tomb became so badly vandalised. One theory was by Scots prisoners of war in the 1600's when the cathedral was used as a prison, another during the many violent periods of social and religious upheaval in Durham's history such as the period of the Reformation. Whichever, its remaining large alabaster figures and tomb base with its associated surrounding alabaster mourners, have been severely damaged over time and resulted in my decision to use the remains of the effigy to engage with a variety of digital tools in its partial remediation.

Typical of the age of its construction, to the medieval observer this carved representation with its use of typification, heraldic iconography and polychromatic paint and gilt, provided not only a focus of devotion and memory, but of an ideal of the notion of chivalry and of political power and affiliation. In selecting the tomb of Sir John Neville, an opportunity arose to investigate digital processes within the realm of sculptural remediation. Whilst the base of the tomb was largely intact despite some quite heavy damage, little remains of the sculpted effigies of Sir John and his wife, and so the initial decision was based upon the challenge of partially re-creating the lost sculptural form.

This was to be achieved through the use of a combination of scanned data visual research and a degree of artistic licence. The intention is not to declare a historically 'true' image, but to examine processes and techniques that may or may not contribute to such endeavour.

An initial visit was undertaken and permission was sought to enable a scanned survey to be undertaken on the tomb.

4.4. Data Capture

In mid September 2011 a series of scans were taken of the surface with the School's portable 3D Laser Scanner. (Fig 38) The Minolta scanner captures the object surface from a single point. On activation of the scanner, the laser moves across the target object. The laser touches the object and the light is reflected back to the scanner, which captures the surface data of the shape, and records the measurement of an object at a distance between 4 mm or 3 metres. The measurements are translated into an impact location, and are then displayed by the software as cloud point data, or cloud data which initially form the 3D shape of the recorded object in the 3D software. There was a certain amount of restriction given the location of the Tomb; however enough data was captured to enable a decent attempt at some test retopology.

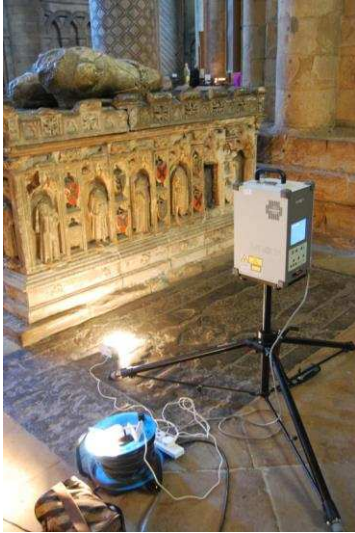

Figure 38: The Minolta 3D Scanner used to scan the surface topology of the tomb of Sir John Neville

Geomagic Studio transforms 3D scan data into usable 3D polygonal, surface and CAD data, with parametric integration for MCAD products using automated and tools for 3D creation and imaging. The resulting scan data was patchy, but there was enough to be able to use to reconstruct the largely repetitive elements that surround the tomb. Once the data transferred to a computer there was a need to check it for its relative position over a composited Photoshop file. Colour overlays were produced to help make sense of where data was located upon the surface. (Fig 39 and 40)



Figure 39: Photoshop overlays to clarify positions of the scanned data

In Geomagic, the data was assembled and holes were filled where appropriate. Initially the data was imported to 3D Coat; however a preference for the retopology tools in 3D Studio Max 2012 enabled a more speedy approach to testing then re-building the base (Fig 41). Initially, taking some of the basic carved forms, an examination of the step build method was undertaken and then exporting to Mudbox was attempted.



Figure 40: Geomagic scanned data checked against Image

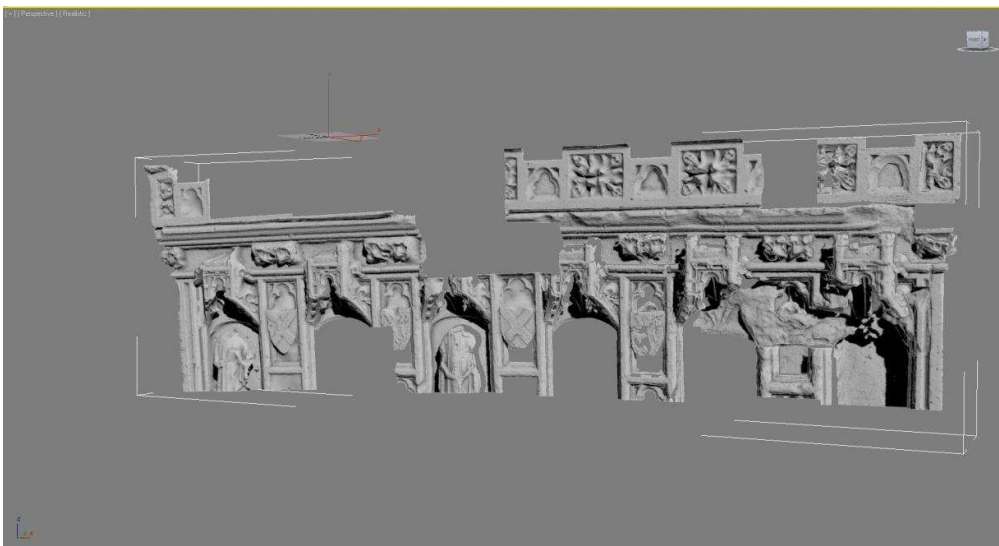

Figure 41: Import of stitched Geomagic data as .obj file to 3D Studio Max

4.5. Base Modelling

The different nature both of the base of the tomb and the effigy and the different approach to capturing the surface data provided for testing approaches to the modelling of the surface. A step build approach was initially undertaken in attempting to develop a clean mesh. Fig 42 highlights how time-consuming the process could become if continued. Maintaining control of the topology and keeping a clean quaded mesh would need a different approach.

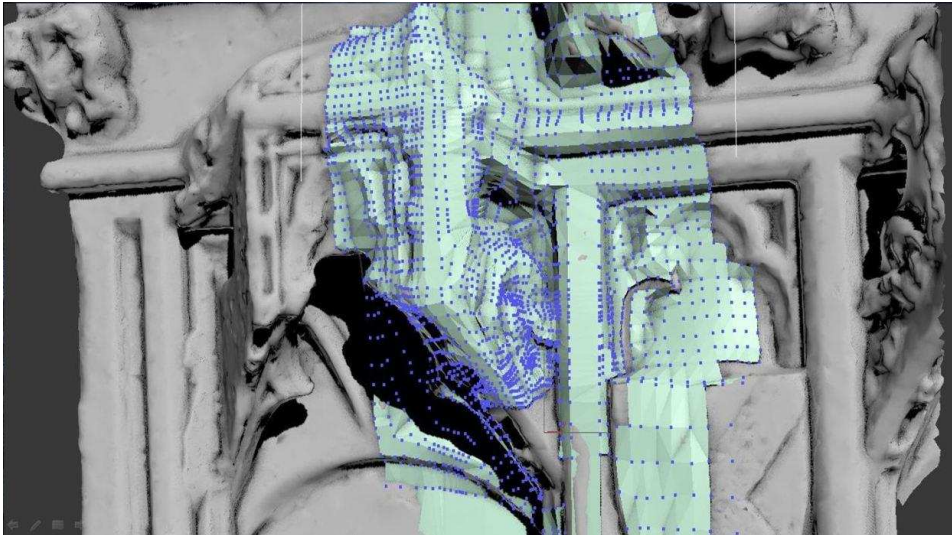

Figure 42: Using the Step Build process in 3D Studio Max 2012

Fig 43 demonstrates the base mesh and a mesh using the conform/re-topology method as well as a mesh built using a more traditional approach using the scanned data as reference only.

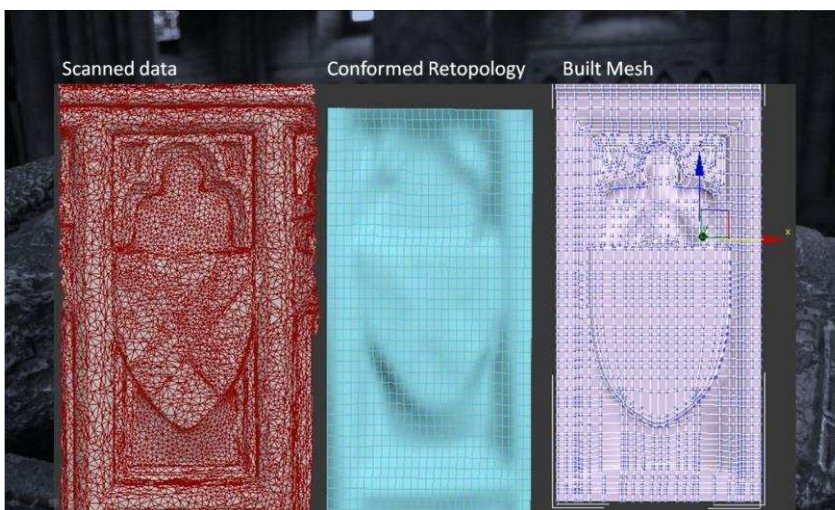

Figure 43: 2 different approaches next to the original scanned data.

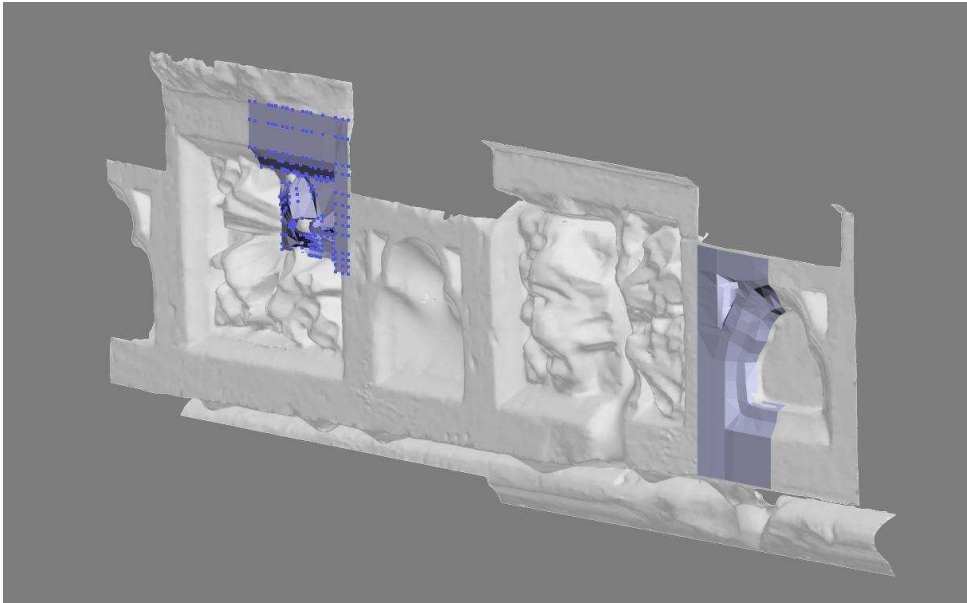

Figure 44: Establishing symmetrical carved content

Some of the less complicated sculptural form could be tackled with relative ease through this method. In Fig 44 we see how carved symmetrical pattern can be topologised over the surface. The application of symmetry modifiers and the mirror function can quickly create a simple quaded mesh for import into Mudbox for further sculpting as in Fig 45.

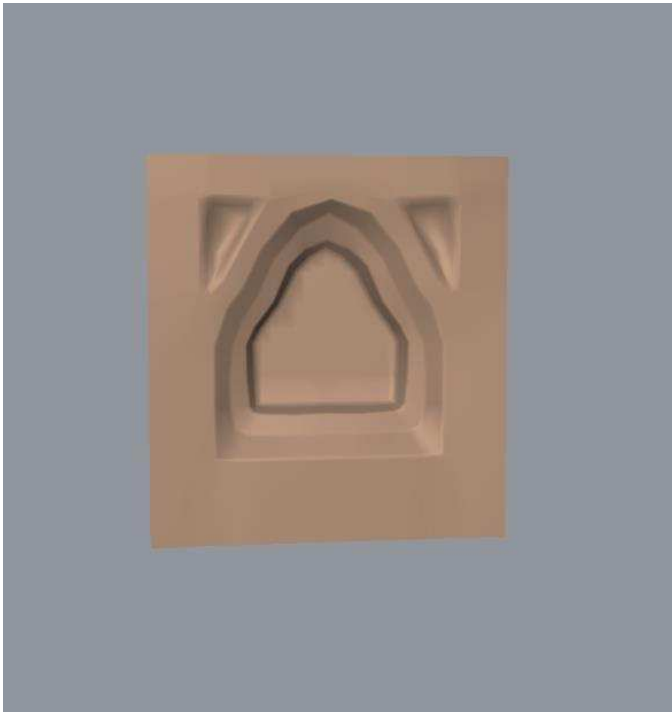

Figure 45: Demonstrates the completed carved element using the symmetry modifier in 3D Studio Max 2012

Once the smaller decorative elements were created I returned to looking at methods for the recreation of the main elements of the base. In order to establish an efficient approach I considered where again those repeating surface topologies existed and began to model the major section that would form part of the base. The method chosen was to build a structured base mesh that could be carefully referenced over the scanned data (Fig 46). There was no part of the tomb from the scan that afforded enough clean and undamaged topology to create an accurate enough conformed mesh.

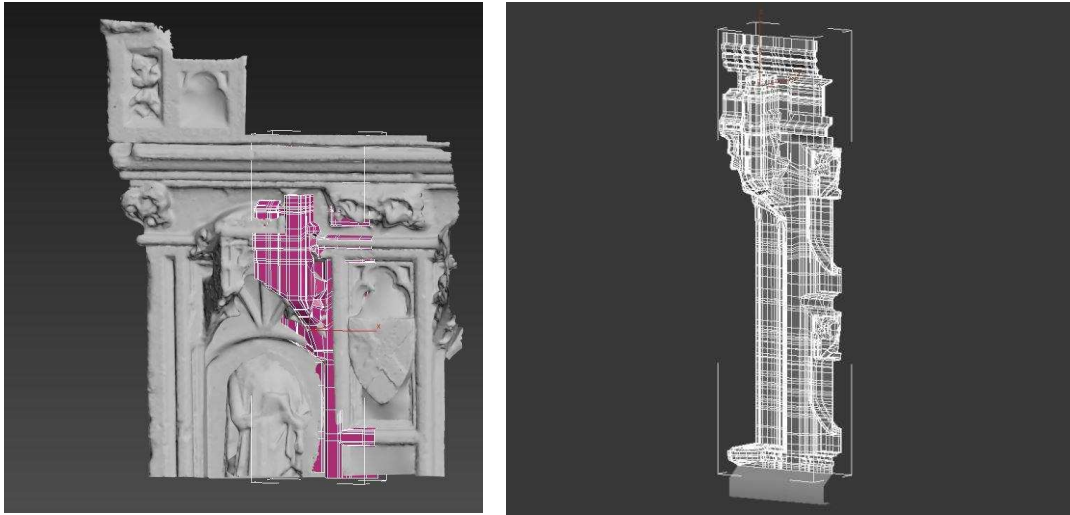

Figure 46: Checking build against scanned base and the completed section

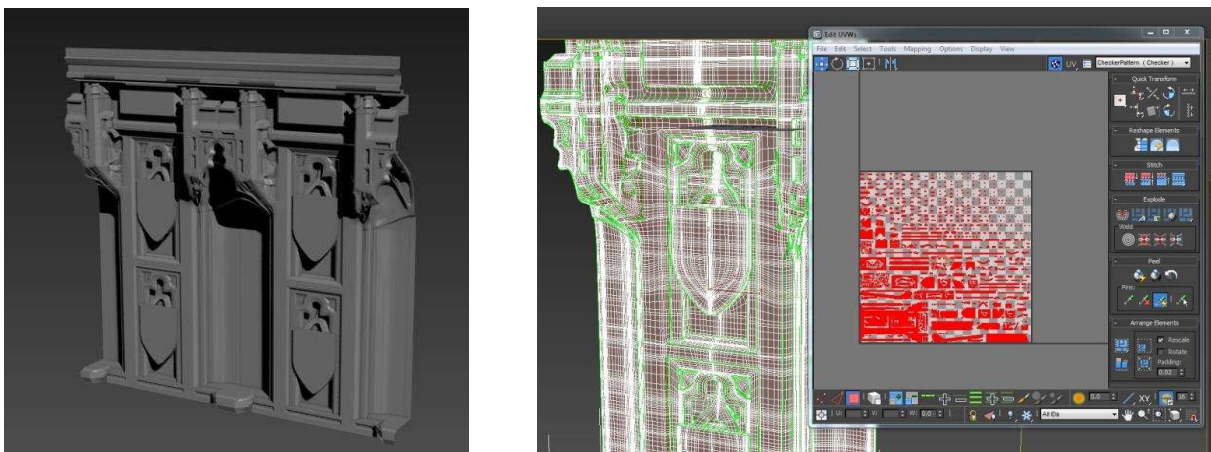

Figure 47: Section with Symmetry Modifier applied and with Flattened UV set for export to Mudbox

Further elements to the base of the tomb were made, including the addition of the stepped section and the lower base of the tomb and the castellated top of the tomb created earlier. Using instances of these sections the base was extended and copies were made for the construction of the corner pieces. (Figs 47 and 48)

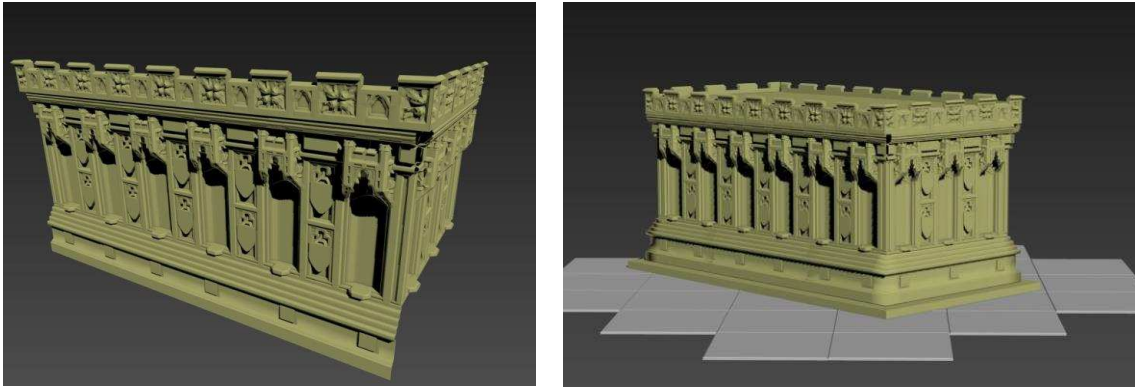

Figure 48: Sections extended out with top and bottom sections added. Corner pieces created from adapted existing geometry.

4.6. Typifaction

At this point, with no evidence as to the likeness of Sir John Neville, further research was undertaken to locate evidence that might provide some clues as to this. Paul Binsky's, *Medieval Death, Ritual and Representation*, helped provide some of the answers to this problem. In particular, he highlighted issues around typifaction at this time and a further investigation lead to a realisation that the great majority of the tomb effigies of the period represented a standardised ideal rather than an actual likeness. (Binsky, 1996)

In addition, Charles T. Little and Wendy A. Stein stated that 'few sculpted heads of the Middle Ages were portraits in the modern sense. The reasons for representing the human face were far more various than recording the physical likeness of an individual. During the High Middle Ages, portraiture did not rely on likeness so much as attributes, coats of arms, inscriptions, and other identifying signs. Thus individual selfhood was subsumed in broader forms of corporate identities.' (Little) (Fig 49)

Nigel Saul in his book *English Church Monuments in the Middle Ages : History and Representation*, briefly touches upon 'the problem of realism', but concludes that in its original form the English effigy was 'a portrait of an idealized figure in the prime of life', and that 'most monuments afford little evidence of individuality' (Saul, 2009)

The images below show just some of this typifaction, with figures showing a male face in repose, eyes open with moustache usually falling outside of a sculpted chainmail avontail.



Figure 49: Examples of typification in contemporary effigies Left to Right: Edward Prince of Wales, Canterbury. Alexander de Mowbray, Saint Michael, Kirklington and John Beauchamp, Worcester Cathedral

Further to the examples of typification it was becoming apparent that there was clearly a need to examine aspects of the application of polychrome clearly evident in some of the examples above.

4.7. Application of Polychrome

With regards to the Neville tomb there is clearly evidence of colour. I have struggled to find if this has been added or retouched at points in history or if was part of the design of the tomb at the point of its construction. What is clear is that more polychrome is apparent on the side of the tomb facing the Nave of the Cathedral than that on the South Aisle. (Fig 50 and 51)



Figure 50: Tomb viewed from the Nave with evidence of polychrome

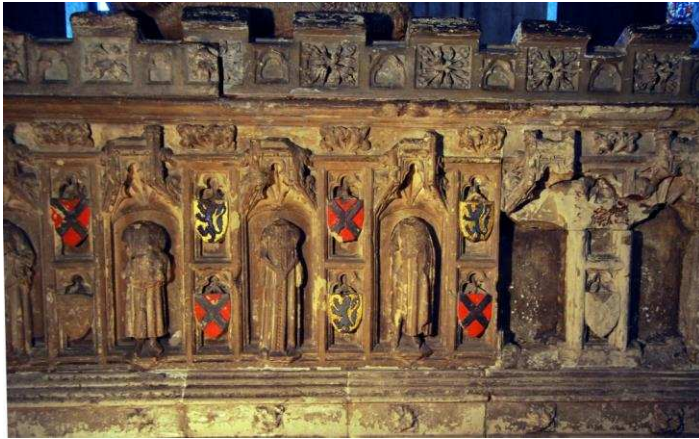

Figure 51: Tomb viewed from the South Aisle of the Nave with evidence of polychrome

Within the cathedral there are examples of polychrome that give a greater indication of the level of application that might have been present earlier in its history. The tomb of Bishop Hatfield, a contemporary of Sir John, lies in the North Choir and has much of its original polychrome in evidence. (Fig 52)



Figure 52: The Chantry of Bishop Hatfield. Durham Cathedral

At Exeter cathedral can be seen extensive restoration work of the polychrome completed on two of the Cathedral's tomb matching tomb canopies, that of Archbishops Stafford and Branscombe. Strong similarities in the use of colour, with vivid blues and reds and the extensive application of gilt goes some way to give some indication of the impact and application of Polychrome at this time.

4.8. Application of Photogrammetry to the Project

The original laser scan of the alabaster figure of Sir John (Fig 53) provided insufficient data on a number of levels. Whilst the scan is of high detail, the difficulty of the location in

capturing satisfactory data, alongside the obvious damage to the effigy prompted the search for alternative approaches.

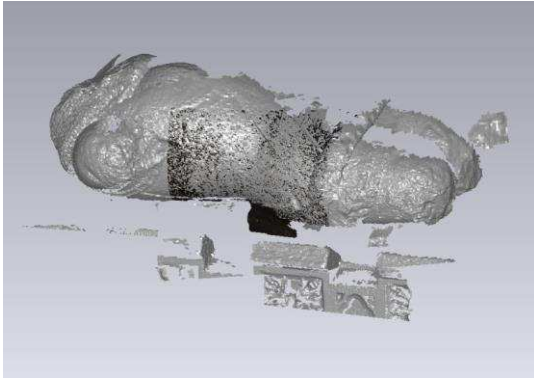

Figure 53 : Laser scan data of Sir John Neville effigy

The absence of much of the sculptural form of the effigies upon the tomb meant a search was undertaken to locate a contemporary alabaster effigy to Sir John. In locating this, there arrived an opportunity to test the use of the Autodesk 123D Catch photogrammetric software now being released in beta form.

An alternative approach to laser scanning, photographs can be taken with a digital camera and aligned together, the camera positions are then calculated and a point cloud is produced. There are some advantages to using a Photogrammetry method, it requires little user expertise, there's no need for expensive 3D scanning equipment. It can produce relatively accurate 3D digital models based only on photographs taken with a standard camera.

Investigation into the recording of medieval church monuments led me to the work of Charles Alfred Stothard (July 5, 1786 – May 27, 1821), an antiquarian draughtsman whose body of work catalogued a great many of these sculpted effigies. In 1807 he was admitted as a student of the Royal Academy, and in 1811 he exhibited there a picture of the death of Richard II at Pontefract, in which the costumes were depicted with strict historical accuracy. In the same year he published the first number of the 'Monumental Effigies of Great Britain,' a work designed to portray the changes in English costume from the twelfth century to the reign of Henry VIII. The work was issued in twelve parts, of which the first ten were prepared by Stothard himself; the last two, undertaken by other artists, were issued after his death. Some examples of Stothard's attention to detail and his reference to remaining polychromatic evidence on several tomb sculptures can be seen below including a study of Sir Ralph Neville, Sir John's son. (Fig 54)



Figure 54: Sir Ralph Neville and Margaret Stafford and Phillipa Beauchamp and Sir Roger de Bois and Lady Margaret de Bois

One of the Stothard drawing (Fig 55) brought my attention to a tomb located in St Boniface Church in the village of Bunbury, Cheshire. The Tomb of Sir Hugh Calveley c.1315 – 1394 is considered one of the best surviving examples of alabaster tomb carving in the north of England.

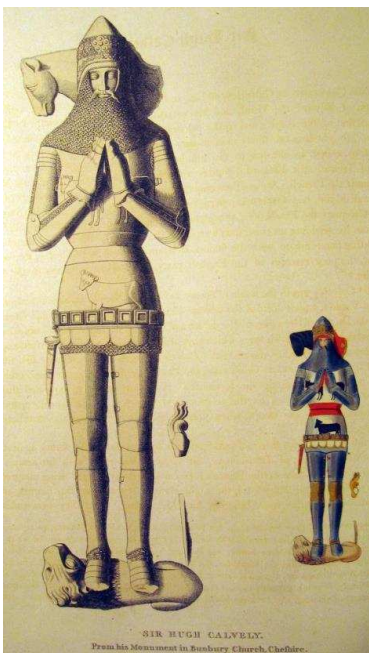

Figure 55: Sir Hugh Calveley

Permission was sought to arrange a visit to the church and photograph the Tomb. The intention was to use resulting 3D model developed from over 180 digital photographs to allow for the building of a base mesh in 3D Max that would conform to something like the effigy on the Neville Tomb. (Fig 56)



Figure 56: The Photogrammetry survey of the tomb of Sir Hugh Calveley

4.9. Further Project Research

Further examples of research were the addition of the sword and the helmet. The sculpting of the helmet was based upon both the remains of the Calveley helmet (Fig 57) and the additional research undertaken from a visit to The Royal Armouries at Leeds (Fig 58 and 59).



Figure 57: Tournament Helmet. Leeds Armouries



Figure 58: Sir Hugh Calveley Helm Detail



Figure 59: Great helm, English, mid-fourteenth century. Royal Armouries

The sword was more problematic as there are few examples of carved alabaster swords in existence, being elements that are easily damaged or detached. One source of reference was the Oakshott system of classification developed by Ewert Oakshott, his work on sword typology is perhaps the most complete system for the medieval sword. The Sub Type XIIIa (Fig 60) was gave some indication of style alongside further examples at Leeds.

Sub-Type XIIIa	
<i>Profile:</i> broad, flat and evenly tapering	<i>Grip:</i> hand-and-half to two-hand length, 6" to 10"
<i>Cross-section:</i> lenticular	<i>Average Weight:</i>
<i>Average Blade Length:</i> 35"	<i>Primary purpose:</i> cutting
<i>Fuller:</i> 2/3's of the length of the blade	<i>Period:</i> Great Sword or War Sword, in use during much of the High Medieval period, 13th and 14th c
<i>Point:</i> acute	

Figure 60: Oakshott sword classification

Again, some surprisingly few examples from this period are on display at Leeds armouries. (Fig 61)



Figure 61: Display from arms and armour of The Hundred Years War

4.10. Editing the and combining the Photogrammetry Data

Around 180 photographs were taken in total and the images were uploaded via 123D's desktop software to be rendered together. Initial results were disappointing, but after careful selection I began to see some results. I found the best solution to missing data was to split the process into head, torso and legs and combine the data in 3D Max.



Figure 62: Photogrammetry capture with surrounding hearse



Figure 63: Initial results showing some success with point registering with Automatic Tie Point Extraction in 123D Catch

Fewer images were used here, just from the top half of the effigy, producing a better outcome. In Fig 62 the surrounding 'hearse' is visible, this was removed at a later stage. (Fig 63) This did result in some occlusion of the image. Once the scans were cleaned up and combined, it was discovered there was sufficient data to make some initial attempts within 3D Max to use the Conform tool and experiment with creating a base mesh.(Fig 64)

The choice of this method was one based upon the particular nature of the carved alabaster. Whilst we cannot fully replicate the subtractive nature and natural consistency of alabaster sculpting, it was hoped that the attempt at creating a single topological surface that conformed to the underlying shape; this might help reduce the tendency to follow traditional poly-modelling approaches and produce a base mesh that was too segmented and 'clean'..





Figure 64: Scanned data combined and loaded into 3D Studio Max 2012

4.11. Modelling and Sculpting the Effigy

After capturing the data from the tomb of Sir Hugh Calveley and importing into 3D Studio Max texture details were removed and initial attempts at using the conform method were applied. In Fig 65 the lower figure is the captured surface data with textures removed; the figure above is the conformed mesh. However, whilst there can be a rapid production of a quaded mesh produced using this workflow, it became apparent that some serious problems are encountered when a more complex topology is used.

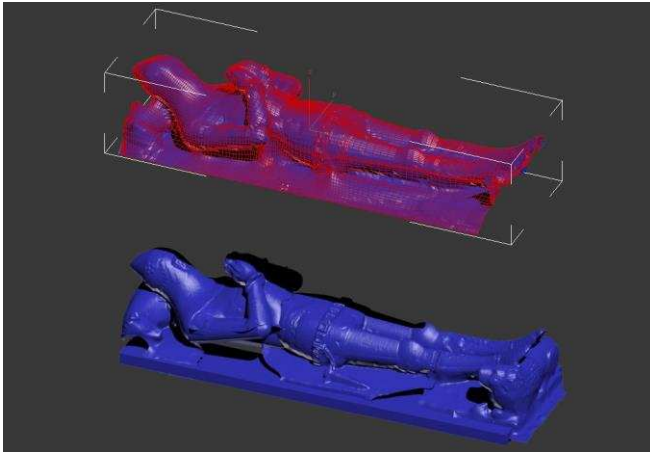

Figure 65: The initial retopology in 3D Studio Max 2012 from the combined Photogrammetry data.

If the conformed mesh is to be successfully imported and sculpted upon then this method cannot produce a satisfactory base mesh for import; the image (Fig 66) below highlights (in red) some of the issues encountered.

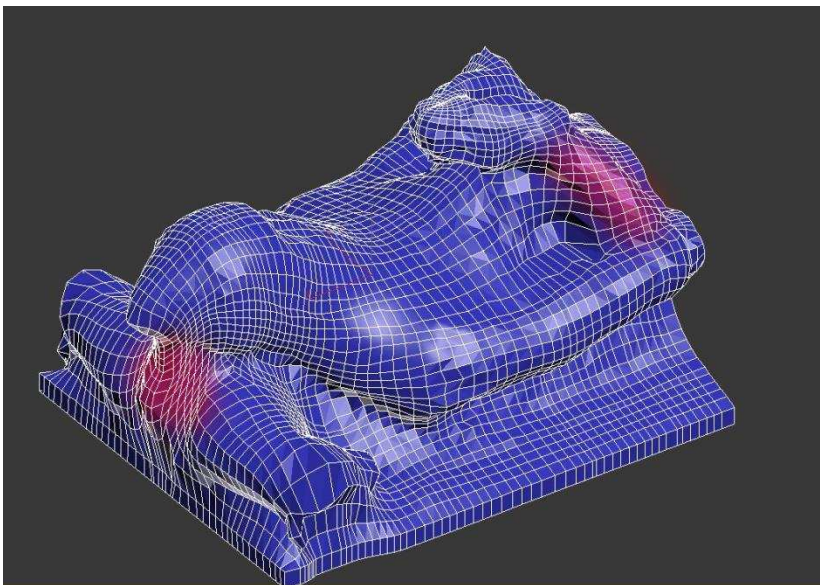

Figure 66: With some of the problems highlighted in red

The highlighted areas demonstrate how the complex topology produces distortions in the mesh that would become problematic for sculpting. It can see how the topology on the arm does not flow in the direction of the arm and behind the head the topology should flow around the basinet rather than fall away to the helmet. The dense level of the mesh and this uneven topology can be seen more clearly when an .fbx file is imported into Mudbox where higher subdivision levels illustrate the problems. Fig 67

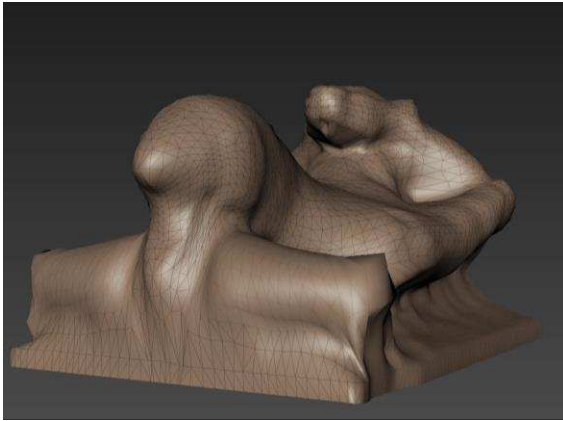
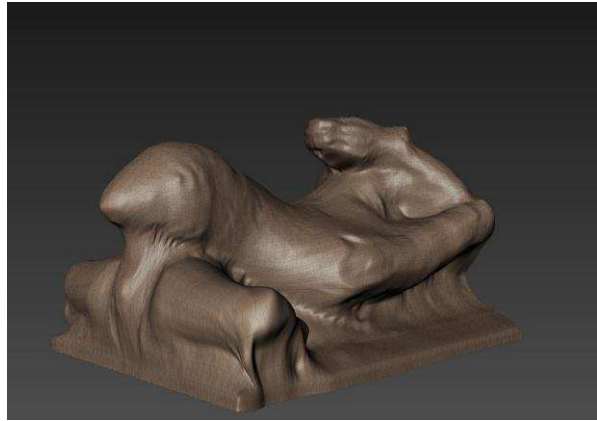

Figure 67: Mudbox Level 0 9896 Faces



and Level 3 475008Faces

An altogether unsatisfactory outcome and one that requires so much remedial correction as it was impractical to work with. A decision was made to retopologise the parts of the conformed mesh that were problematic and to reduce the initial level of topology. Fig 68

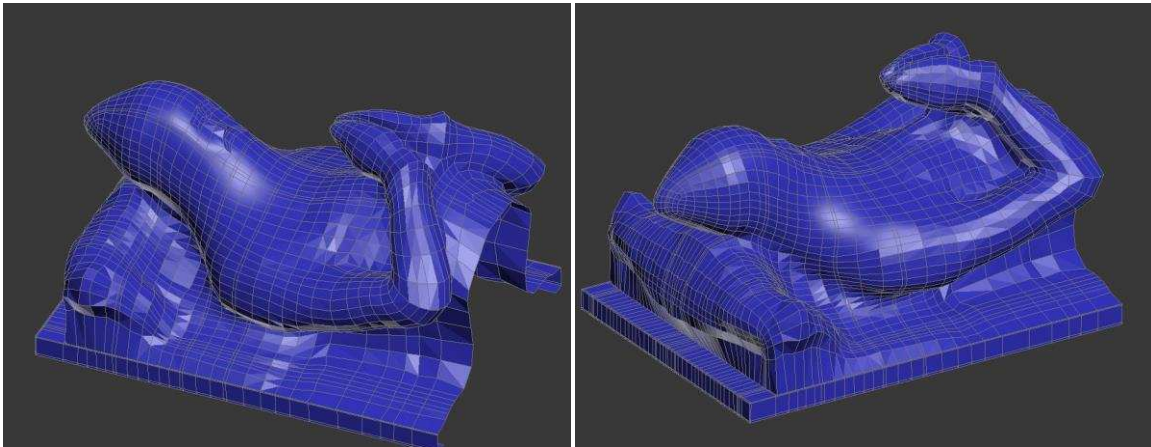

Figure 68: Retopologised corrected mesh

At this stage limitations in hardware were having a significant impact on performance with this mesh. The relative differences in how the two major sculpting applications (Mudbox and ZBrush) use hardware within the computer were highlighting how effectively the mesh could be sculpted. It was therefore necessary to obtain a machine capable of dealing with high level of polygons in this project was required, and once set-up I began again to work at developing the base model for sculpting. The retopologised and conformed lower section of the figure was added and asymmetrical elements such as the helmet and the lion constructed (Fig 69)

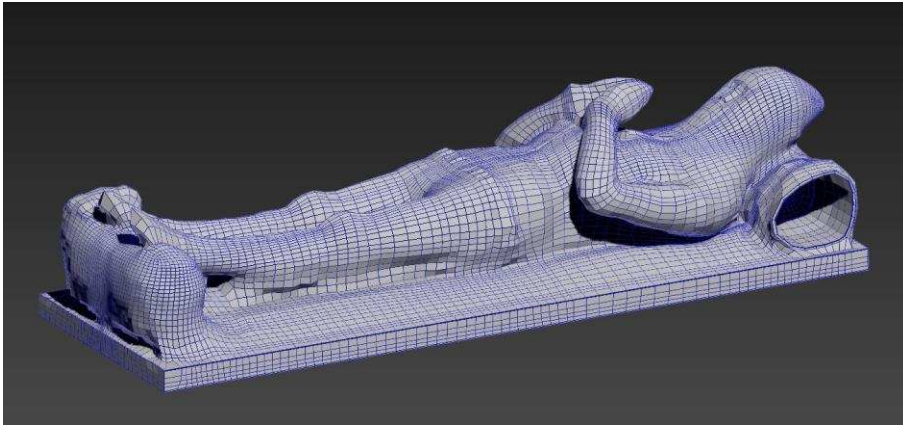

Figure 69: Showing the basic asymmetrical elements added

4.12. Sculpting in Mudbox

The base was then imported into Mudbox for sculpting initial major forms. (Fig 70)

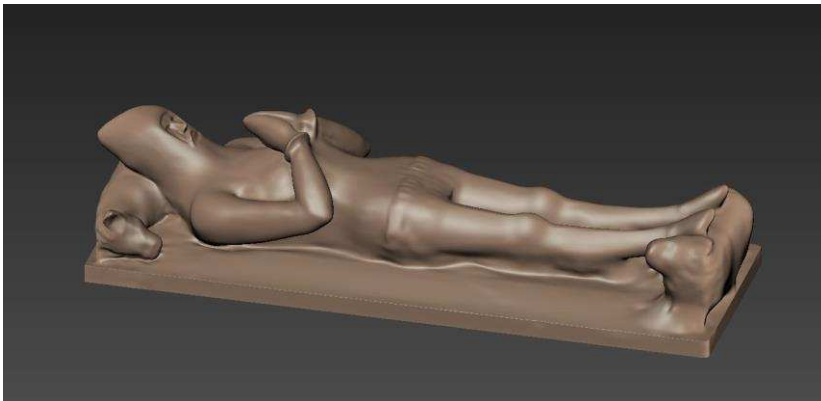

Figure 70: The file exported to Mudbox

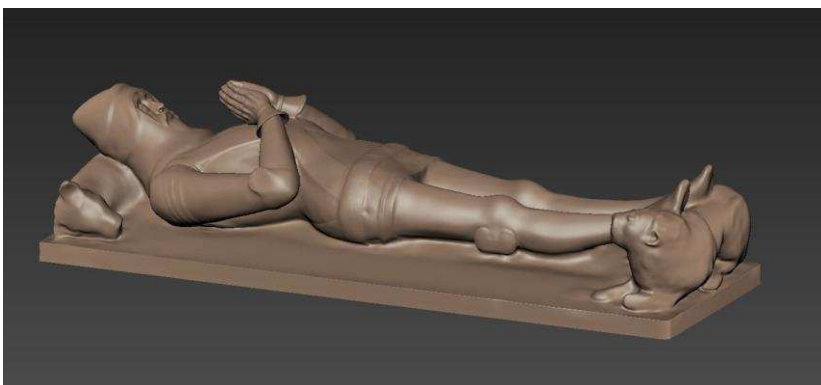

Figure 71: Sculpt with some of the tertiary forms added

Once some of the tertiary forms had been added to the sculpt (Fig 71) it was then necessary to proceed onto some of the detail sculpting. At most stages up to this point the mesh had been subdivided to a maximum of approximately 3 million polygons. In order to apply the greater detail the model was subdivided to a level of 14 million polygons. This not only allowed for direct sculpting of detail but the application of custom stencils developed in Adobe Photoshop and Illustrator and imported as TIFF files into Mudbox.

These stencils included: Chainmail, Belt detail, detail for the carved lion and decorative edging for armour basinet and helmet. (Fig 72)

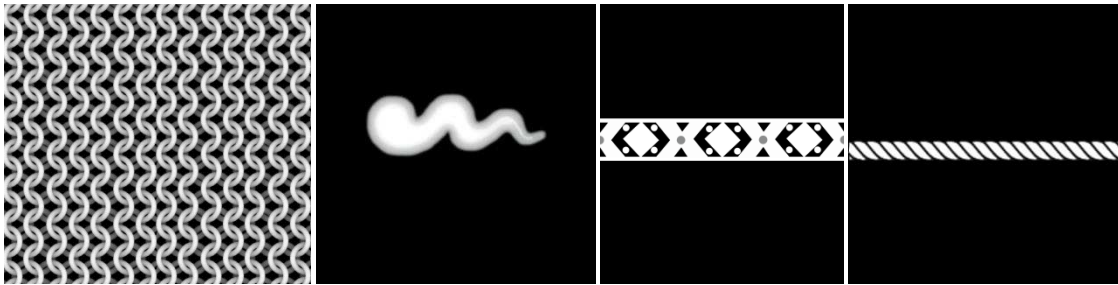

Figure 72: Some of the 14 Custom Stencils made to aid sculpting



Figure 73: Stencil application on the model.

Although, where no direct information was available, 'placeholder' graphic elements have been added. These are easily removed should the input of correct data be forthcoming. Examples of this include the stencil created for the armour trim seen above. (Fig 73) Here a simple saltire motif was created in keeping with some of the carving on the tomb. It is not the place of this researcher to submit that this could be in any way appropriate and would need the input of an expert in armour from this period to input into the design.

The helmet was sculpted from the base topology imported.. (Fig74) However the sword was modelled separately in 3D Studio Max 2013 (Fig 75) and imported as an .FBX file and added to the scene in Mudbox. (Fig 76)



Figure 74: Sculpted Helm

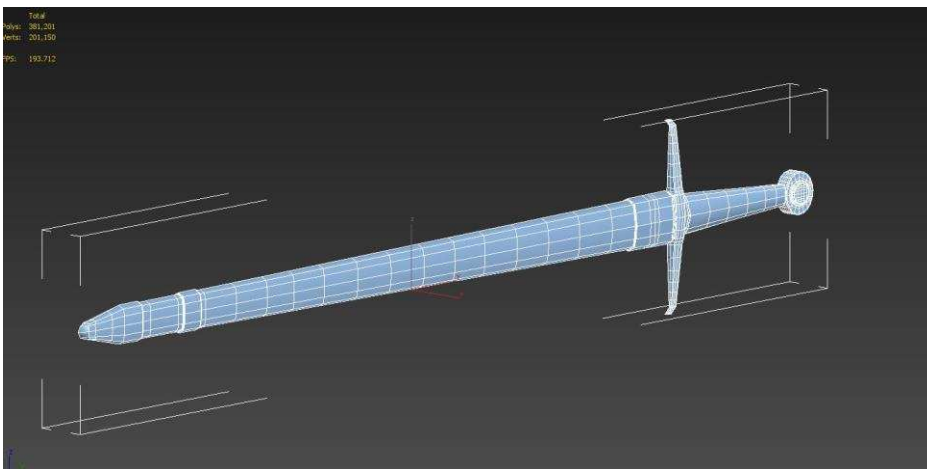

Figure 75: 3D Max model of sword.

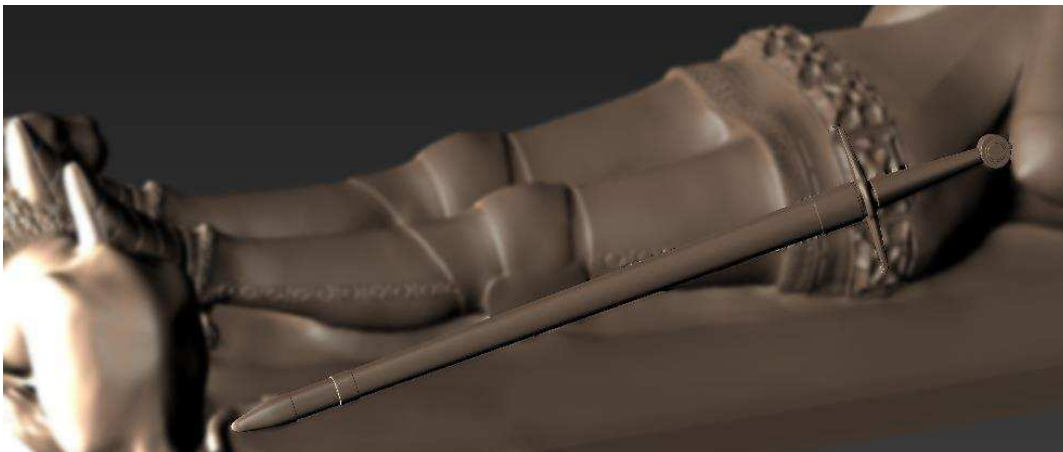

Figure 76: Sword added to scene..

Additional elements were added such as the tail of the lion. This was often used as extra sculpted support to the sword. (Fig 77)

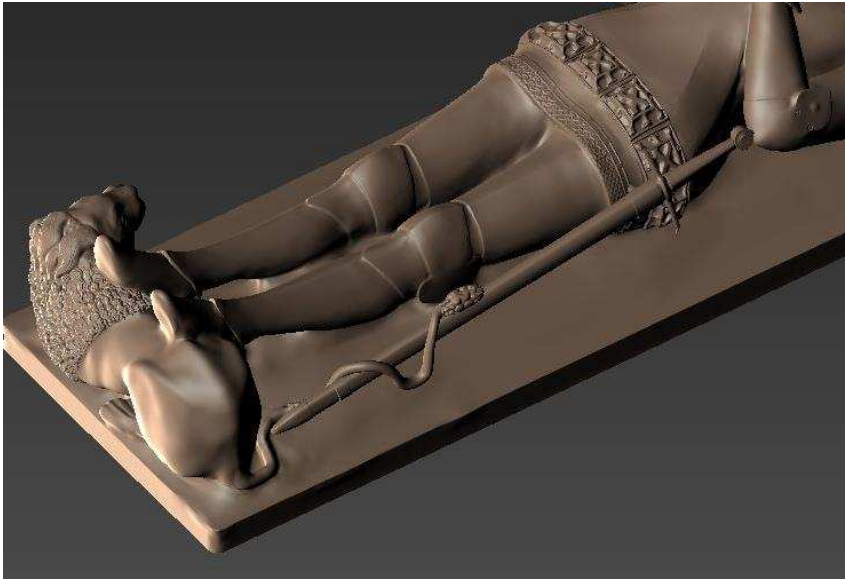

Figure 77: Tail added from 3DMax as a support to added to scene..

4.13. 3D Printing

3D uses the method of additive manufacturing, the process of joining materials to make physical objects from 3D model data. The physical model is created by building up multiple layers on top of each other, one layer at a time. Currently, use of 3D printing is allowing designers and engineers to test ideas before committing them to manufacture. As part of my research I wished to explore this technology, as there are I believe applications to heritage visualisation. This could be from the production to small prototypes to be used as tactile objects, for those with visual impairment as mentioned earlier, to heritage merchandise for sale or the production of full scale replicas. Printed outcomes could also provide tactile outcomes to promote further discussion and research.

The intention to 3D print the part of the model allowed for the opportunity to exploit some of the tools within Pixologic's rival sculpting application ZBrush 4R4. At 14 million polygons the subdivided mesh would provide issues around import and manipulation into 3D Studio Max for export as an .STL file. However, ZBrush can manipulate such subdivision levels and has a number of plug-ins that will allow for mesh decimation and the output of an .stl file.

Therefore the model was exported from Mudbox as an .obj file and imported into Mudbox as a ZTool. (Fig 78) Once imported and opened the mesh was reduced by using Decimation Master. (Fig 79) The process significantly reduces the size of the mesh without compromising detail. It does however prevent any further sculpting.



Figure 78: The imported mesh as a ZTool



Figure 79: The level of decimation to the right at 10%. Polymesh display shows mesh triangulation.

Once the mesh was reduced the file was prepared for export as an .stl file using the ZBrush 3D Print Exporter (Fig 80) and then checked that it could be imported into 3DStudio Max. (Fig 81)

Figure 80: Below shows the level of decimation achieved using ZBrush Decimation Master plug-in.

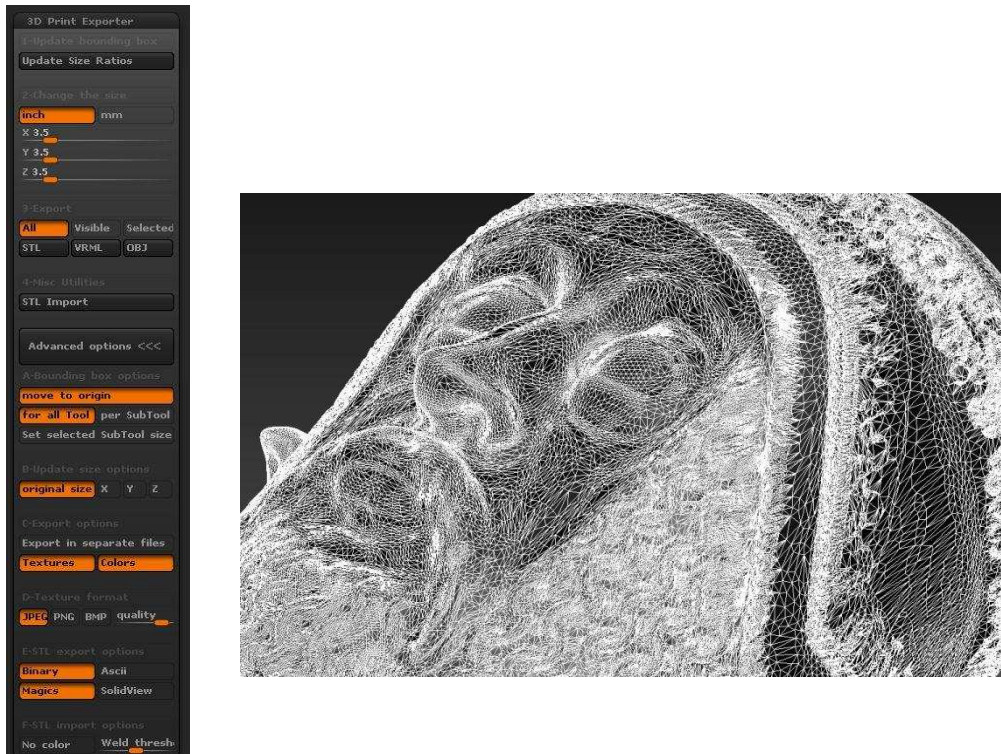

Figure 81: Below shows the imported figure placed on Tomb base in 3D Max

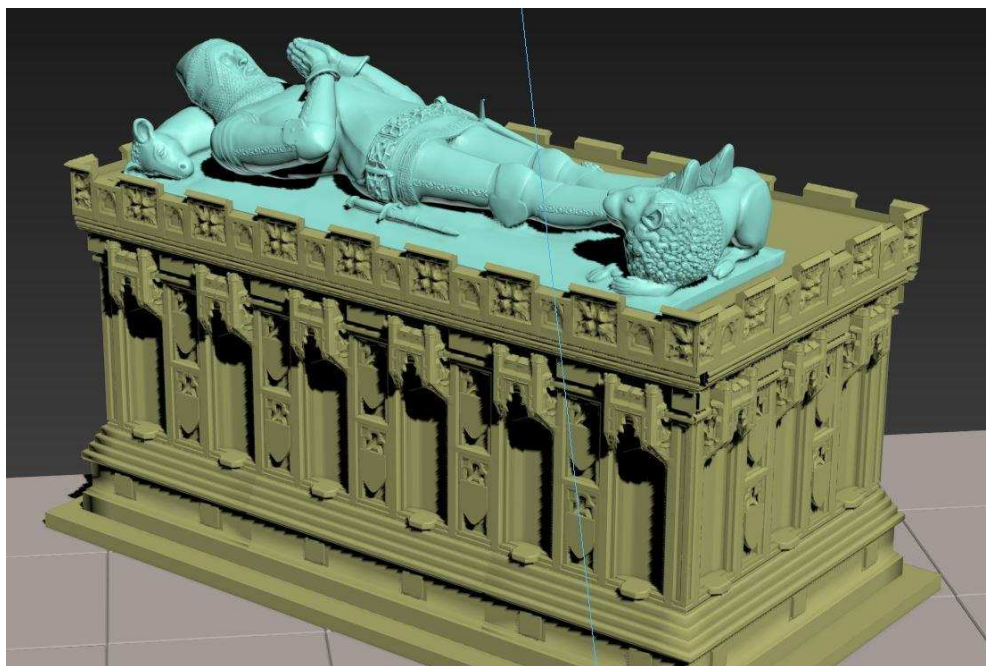



Figure 82: Final Clay render



Figure 83: Clay Render Detail

4.14. 3D Printing Outcome

After mesh was decimation the file was prepared for printing via a Dimensions Elite 3D Printer. The .stl file was brought into Dimension's CatalystEX Software and then sent to be printed. Below is shown the print head and the ABS plastic (white) and the support material (brown) in the building process. (Fig 84)

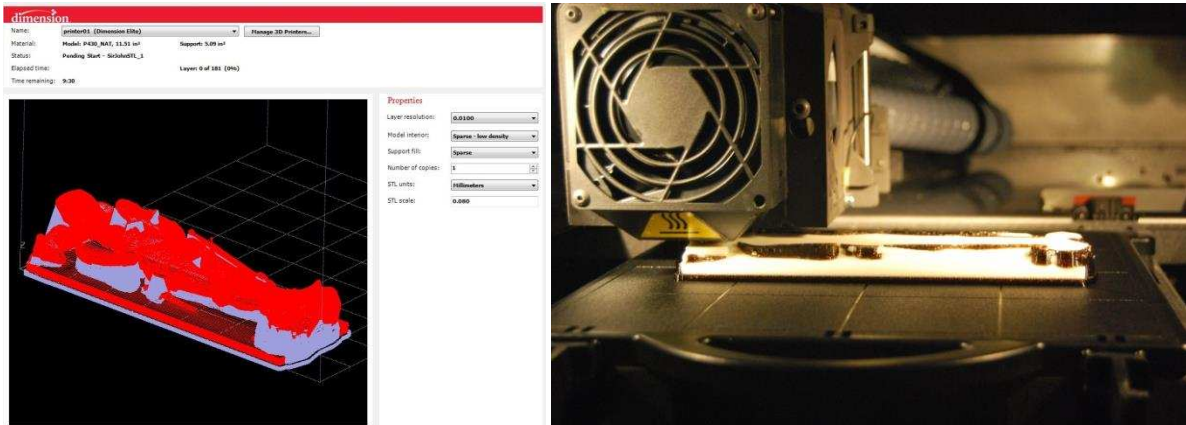

Figure 84 Preparation and printing of the sculpted model.

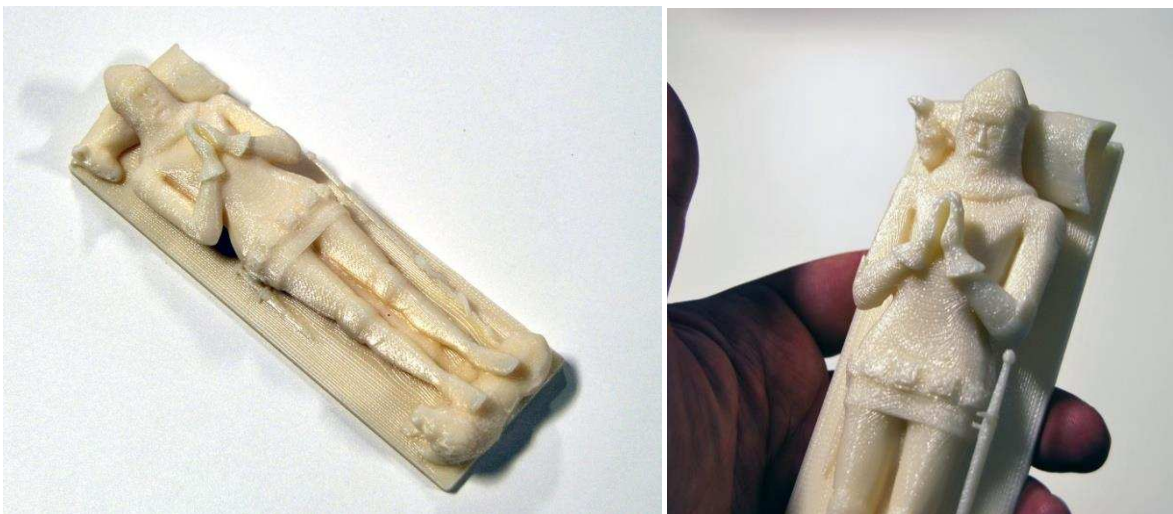

Figure 85: Shows the final print after removal of the support material.

4.15. PTEX Texturing

PTEX is a relatively new texturing system developed by Walt Disney Animation Studio for production quality rendering. Traditionally, a texture, or UV, maps is created to store texture placement. UV mapping adds two extra coordinates to the points in the object; those on the U (horizontal) and V (vertical) axes, running horizontally and vertically through the flat plane of the texture map, on which the texture can be painted. UV coordinates are a 2D representation of 3D

space. They set up a relationship between a two-dimensional image and the three-dimensional surface the image will be applied to. PTEX stores a separate texture per face of the subdivision control mesh, each of which can be independently sized, and any surface can be mapped with a single PTEX file containing all of the per-face textures regardless of mesh complexity, the file also contains mesh adjacency data that is used to filter across faces.

The residual polychrome on the tomb base gave enough data to begin to examine how the tomb may have looked when first applied. Part of the modelled tomb section was imported into Mudbox for the final sculpting of the decorative elements, such as scroll work and leaf carving. Once imported the mesh was subdivided and prepared for PTEX texturing.

Based on Photographs taken on my visits to Durham, I applied colour based on samples taken from images that were imported into Photoshop. The RGB colour information was then recreated in Mudbox and applied to the sculpted model. Two further custom stencils were also created for the lion 'rampant' and saltire carving on the shields. (Fig 86) Diffuse and Specular texture layers were created for the 'gold' effect. Colour application and the decorative sculpt on a textured stone base was added. (Figs. 87 and 88)

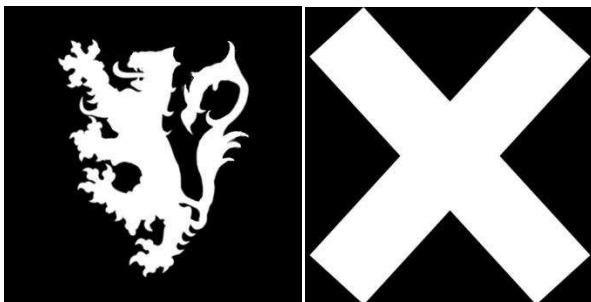

Figure 86: Further custom stencils created for Shield on Tomb Base

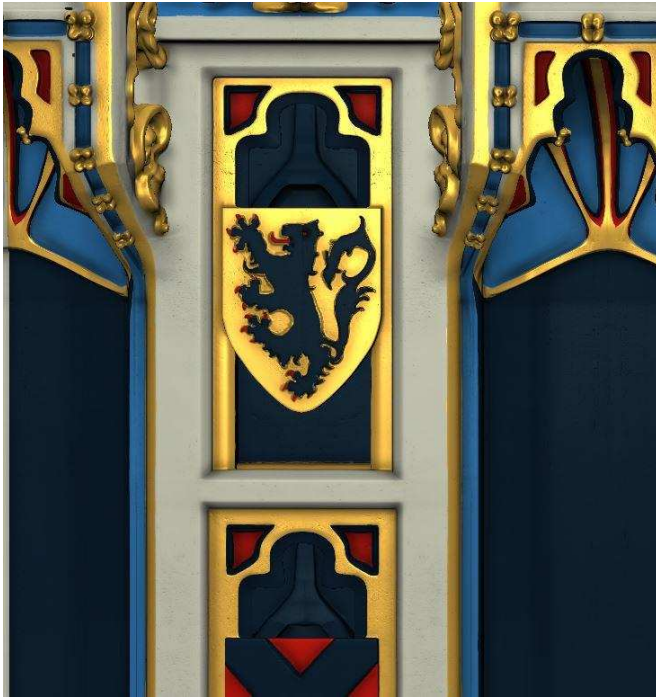
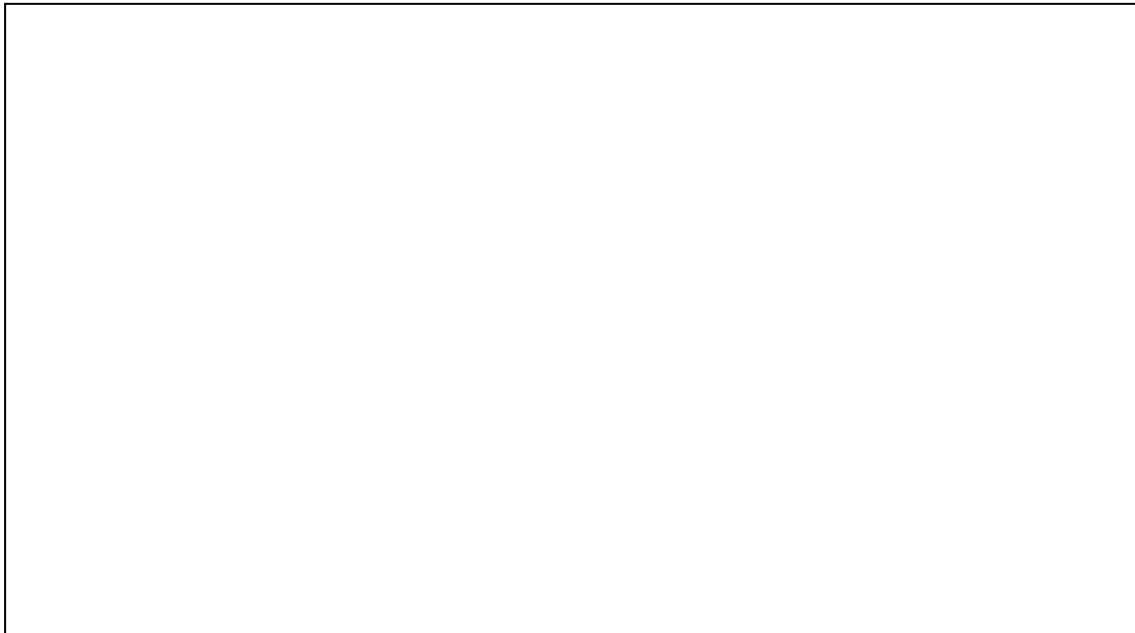

Figure 87: Detail of Custom Material, Texture, Diffuse and Specular paint layers in Mudbox



Figure 88: Sample polychrome applied to the tomb and effigy

4.16. Please see further rendered images on the attached DVD



5. Findings and outcomes

Over the course of this research I was made aware of how the debates surrounding heritage reconstruction have changed and polarised opinion over the years. Critical engagement with heritage images and the repercussions of their use have resulted in a more reflective consideration of the issues of historical legitimacy and the effects of their distribution for public consumption.

My research began as an examination in the use of particular toolsets to remediate lost sculptural form, but has subsequently allowed for a greater understanding of the problems of reconstructing uncertainty and an appreciation that representation cannot be considered a neutral act. Such investigation allowed for an understanding of the dangers and responsibilities inherent in heritage reconstruction. Further, it helped in locating such work within the context of what has now being referred to as the Digital Humanities.

The research project is practice based and the outcome is a digitally sculpted artefact that acts as a conduit to the application of the specialist knowledge of others. As such, this craft practice lies within the disciplines of artefact illustration, a form of technical illustration. Such a role is one of re-creative practice rather than creative practice, and where there in this instance any artistic contribution made by the researcher, it would only be where there is an absence of evidence from other expert sources and therefore, it could be argued, the less of this the better.

In the course of engaging with new digital practices, this research allowed for an examination of a number of software applications and approaches. Towards the very latter stages that this project was undertaken; more recent developments in the associated software have resulted in some of the processes outlined here becoming a legacy workflow. However, the fact that they are now being integrated into digital sculpting software such as Autodesk Mudbox 2014, demonstrates the perceived need by developers that an integrated workflow involving efficient handling and manipulation of scanned data, mesh reduction, automatic and user defined re-topology options and powerful sculpting tools mirror this projects intentions and are a natural addition to the application.



The Research Project	Autodesk Mudbox 2014 (Launched 26/03/13)
<ul style="list-style-type: none"> ❖ 3D Scanned data imported into Geomagic Studio for manipulation ❖ Import Scanned data into 3D Studio Max for Retopology ❖ Mesh reduction in 3D Studio Max or ZBrush 	<ul style="list-style-type: none"> ❖ 3D Scanned data can now be imported and manipulated within Mudbox ❖ Scanned data can now be retopologised within Mudbox ❖ Mesh reduction can now take place in Mudbox

6. Conclusions

In the section below there is summation of the conclusions to this project, recommendations from its outcomes and indication of intended further study:



Outcomes	Recommendations
<p>❖ Scanning <i>3D Laser scanning</i> provided high quality data from which to capture surface detail. The nature of the tomb base meant repetitive elements could be used to make a full construction where damage was so extensive as to prevent accurate surface capture. Enough information was provided to enable stitching and filling holes in Geomagic Studio and then export to 3D Studio Max</p> <p><i>Digital Photogrammetry capture</i> of the tomb at Bunbury Church provided a surprisingly good outcome. Over 180 images were used and although I was unable to stitch the entire sequence together, enough information was combined via 123D Catch to link the top, middle and lower sections of the effigy together once imported into 3D Studio Max. In comparing the two methods it is still evident that if high detailed scans are needed, 3D laser scanning offers a much higher resolution and the direct production of a point cloud over the Photogrammetry method. For both scanning methods a degree of time-consuming post-capture processing was required.</p> <p>❖ Modelling 3D Studio Max offered the opportunity to import laser scanned data to assess if a number of methods could be used to develop a base mesh for the tomb and the effigy.</p> <p><i>Modelling the Tomb Base:</i> Initial attempts at using the Re-Topology</p>	<p>❖ <i>3D Laser scanning:</i> Greater experience with the scanner and more than one visit would have been necessary for the capture of such large surface detail. The position of the tomb in relation to other objects prevented a fully extensive scan survey. A smaller hand-held laser device might have been more useful to access those areas adjacent to the Cathedral columns to scan the tomb and to enable better access to the tomb effigy.</p> <p><i>Digital Photogrammetry capture:</i> As stated above, it is felt that some of the gaps in the data were a simple result of inexperience in using such methods. Data checking in-situ was not possible due to the lack of Wi-Fi at the location, but where, possible offers a way to ensure data is being capture to a satisfactory standard.</p> <p><i>Further study:</i> A series of Photogrammetry scans on a variety of artefacts can establish direct comparisons with similar laser scans of the objects to establish increasingly efficient methods</p> <p>❖ <i>3D Modelling</i> The reconstruction method for the base became a more normal workflow, involving Max's sub-object poly-modelling tools. The complexity of the objects topology prevented use of the Freeform tools.</p> <p>Obviously, there would be no need for</p>

tools in 3D Studio Max bore mixed results. Initial re-topology of the more simple decorative carved elements using the Freeform modelling tools within Max's Graphite Modelling section . Initially a *Step-Build* method was used. The mesh was constructed vertex by vertex over the base following its contours. Whilst useful for a simple structure it became far more difficult to maintain clean topology and edge looping, resulting in poor construction.

An attempt was made using the Conform method and again the nature of the topology in this particular object prevented accurate and 'clean' topology.

A compromise approach was used and the base was created using more traditional methods and the modelled base was then applied against the scanned data to check for accuracy.

Initial Modelling of the effigy:

Where the conforming process was more successful was its application to the scanned photogrammetry data of the effigy. Here the nature of the topology of the figure allowed for the a conformed mesh that followed closely the underlying data. Some correction was made where undercutting took place but such reconstruction was then re-conformed back onto the mesh.

❖ **Sculpting**

The conforming of the single mesh to sculpt upon was a deliberate attempt to try and attain a more natural approach and finish to the final piece. The temptations to use a cleanly developed poly-modelled base mesh would have resulted in a less naturalistic outcome and this approach reflected a little more the nature of traditional sculpting and the finish of reductive carved stone.

This aim was achieved, but the consequences of initially working upon a large mesh with relatively high initial

this approach if only the recording of the surface was required as the scanned data would be sufficient. However, if further modelling and/or sculpting were needed, this can offer a solution to aid such workflows.

Further study: Where surface topology is less complex, there is a methodology here that allows for conforming the mesh that could be exploited in the production of speedy and relatively accurate outcomes. However, the nature of rapidly developing software has meant that this workflow may not now be applicable. During the very latter stages of this project Mudbox 2014 was released and now contains advanced retopology tools and a computerised as well as user guided retopology solution. New mesh reduction and clean-up functions have also been added and therefore examination of these tools should take place as they may provide a better solution than the workflow described here.

❖ *Sculpting:*

Initial sculpting is time-consuming; this process would not be appropriate where a recording and non-remediation of an artefact is required. However, there are a number of areas where its use may be beneficial.

The highly detailed mesh surface can provide actual tactile outcomes either reproduced as scale models via 3D printing technologies or fully realised stone carving via CNC milling machines. Map extraction can result in low polygon outcomes suitable for dissemination on the web, therefore the process offers a

sub-division resulted in reaching a very high polygon count after relatively few division levels. Without a workstation capable of handling millions of polygons, this approach can be limiting.

The choice of Autodesk Mudbox for the research project was made due to its integration with other applications and my own teaching interests. However, it's simple user interface and increased ability to provide a single platform from mesh import and retopology tools through to final render could provide a powerful and intuitive introduction to the disciplines of digital sculpting for those without a background in digital modelling.

❖ **Texturing**

Although a UVW layout was created, it was decided that PTEX painting would be used. A relatively new process, it offers an opportunity to texture without the sometimes tedious process of creating a human readable uvw map and additionally doesn't suffer from stretching or UV shell seams. A successful test application of the textures was made and the use of the Diffuse layers in conjunction with the Specular produced a satisfactory impression of the gilded elements of the polychrome.

full range of outcomes.

Typifaction allowed for a generic approach to some of the basic aspects of the model. This could provide for a series of base templates that could act as the starting point in examining differences between contemporary sculpted effigies, where simple changes could be efficiently made by the application of different stencils or a selection of pre-modelled vector displacement maps.

Where high polygon counts are a problem, careful splitting of the base topology along appropriate seams would be advised.

Further study: Further exploration of where damaged sculptural artefacts can be matched to a clearer historical record should provide opportunities to highlight the value of this workflow and the application of digital sculpting tools. Investigation into how contemporary stone carvers working in the heritage industries could utilise such approaches should be undertaken.

❖ *Texturing:*

Mudbox and other sculpting software allow for the production of painted render scenes including turntables, lighting set-ups and import of HDRI images. Offering an all in one, albeit less powerful or sophisticated package that may eliminate some of the more technical aspects of modelling, such as UVW mapping and external render set-ups.

Further study:

External rendering options are still being developed for PTEX texturing and an examination of renderers with native support such as V-Ray and Renderman should be examined. Some questions are now being asked if PTEX has a future. The technology has not been integrated into many of the latest upgrades of the major software packages one would have expected since its introduction and

❖ **Printing**

Printing of the effigy was relatively straightforward process as the mesh was contiguous from the start. In order to allow for printing the mesh was exported into ZBrush, as at the time Mudbox had no way to apply mesh reduction. Once reduced the mesh was still at 1.4 million polygons but could now be imported into 3D Studio Max and exported as an .stl file to the printer. The Dimensions Elite 3D Printer based at University Campus Oldham was used to print the model in ABS plastic.

may remain in use mainly in the film and animation industries.

❖ **Printing:**

There was insufficient time in the project to prepare the mesh to print the tomb base. Establishing at an early stage that a printed outcome is required ensures workflows will make the outcome suitable for printing without time-consuming mesh preparation at a later stage.

Further study:

Further investigation would involve preparation for CNC milling and examination of different material outcomes that could be used to prototype for commercial retail purposes.

At present the research outcomes here do not intend to stake a claim to a veridical likeness and where no data exists there has to be an acceptance of the unknowable. It would be of interest to see, where at the moment only 'place-holder' sculpted elements are applied, a more probative investigation with cross-disciplinary engagement could develop wider reconstructive narratives.

The seductive and compelling nature of the digital images that can now be produced sometimes give the impression that there is precise knowledge about the appearance of an artefact or a site where none may exist. There has therefore been a number of attempts to agree a common international set of codes and standards that would allow for the differentiation of the remediated outcomes against the extant data; one of the most recent being the London Charter for the Computer-Based Visualization of Cultural Heritage. In extending this project, there are I believe opportunities to begin to use such charters to explore how sculpted digital content can be visualised distinctly from other captured data. This would inevitably include the involvement of relevant expertise from a number of disciplines to ensure respect for authenticity.

Indeed it is the nature of these new digital sculpting tools that they provide, through sculpting layers, stencils, displacement maps and texture layers etc. a flexible and interpretive non-

concretised skin, offering an almost tactile real-time deformation that could play a part in helping formulate such reconstructive decisions within a shorter space of time. Work that now becomes a process for critical debate, the registering of conflicting interpretations and the expansion of research, rather than just simply a highly finished outcome.

7. References

- Abbot, M. (2012). Stonehenge Laserscan_Archaeological Analysis Report 6457 *Research Report Series* (Vol. Research Report Series). UK: English Heritage.
- Agugiario, F. R., G Girardib, J von Schwerinc, H Richards-Rissettod, R De Amicis. (2011). A Web-Based Interactive Tool for Multi-Resolution Models of a Maya Archaeological Site. *International Archives of the Photogrammetry, Remote Sensing and Spatial Information Sciences, Volume XXXVIII*.
- Arvanigian, M. E. (2000). *The Nevilles and the Political Establishment in North East England 1377-1413*. (PHD), University of Durham, Durham.
- Binsky, P. (1996). *Medieval Death, Ritual and Representation* Cornell University Press
- Bradley, M. (2009). The Importance of Colour on Ancient Marble Sculpture. *Art History*, 32(3), 427.
- Brilliant, R. (2000). *My Laocoön Alternative Claims in the Interpretation*. USA: California Press.
- Catterson, L. (2005). An Ancient Masterpiece or a Master's Forgery?, *New York Times*.
- Clowes, P. G. B. a. M. (1997). Surveying Stonehenge by 3d Photogrammetry. *English Heritage: Photogrammetric Record*, 15(89).
- Donnell, D. O. (2012). Is there a text in this edition: On the Implications of Multiple Media and Immersive Technology for the Future of the Scholarly Edition. Retrieved September 25, 2012, from <http://visionarycross.org>
- Ebbinghaus, S. (2007 - 2008). Gods in Color Gallery Guide. In A. M. S. Museum (Ed.), *Harvard University Art Museums Gallery Series Number 57*. USA.
- Favro, D. (2006). In the Eyes of the Beholder: Virtual Reality Re-creations and Academia in Imaging Ancient Rome. *Journal of Roman Archaeology*(61), 321-334.
- Friedhoff R, B. W. (1989). *Visualization, the Second Computer Revolution*: Abrams.
- Frischer, B. (2009). Beyond Illustration: New Dimensions of 3D Modeling of Cultural Heritage Sites and Monuments. Retrieved January 2012, 2012, from <http://vimeo.com/8345677>
- Frischer, B. (2008). *Beyond Illustration: 2D and 3D Digital Technologies as Tools for Discovery in Archaeology* B. F. & A. Dakouri-Hild (Eds.), *British Archaeological Reports International Series*
- Gain, J. E. (2000). *Enhancing Spatial Deformation for Virtual Sculpting*. (PhD), University of Cambridge.
- Ganis, W. (2005). *Complexities and Contradictions in Digital Sculpture*. Paper presented at the International Symposium of Interactive Media Design (ISIMD), Istanbul.
- Harrison, R. (2013). *Heritage: Critical Approaches*. Oxford: Routledge.
- Hathaway -Smith, M. (2010). *A Necessary Duty, A Hideous Fault: Digital Technology and the Ethics of Archaeological Conservation*. (Master of Arts), Texas A&M University, Texas.
- Hewison, R. (1987). *The Heritage Industries: Britain in a Climate of Decline*. London: Methuen.
- Huxtable, A. L. (1993). *The Unreal America: Architecture and Illusion* USA: New Press
- Knowles, R. Medieval Livery Collars. Retrieved May 2012, 2012, from http://www.richard111.com/medieval_livery_collars.htm
- Lavender, D. A. (1990). Solid Modeling of Roman Bath. *Communication in Archaeology: A Global View of the Impact of Information Technology*.
- Levy, R. M. (2001). Temple Site at Phimai: Modeling for the Scholar and the Tourist *Proceedings of Seventh International Conference on Virtual Systems and Multimedia IEEE Computer Society*(7), 147 - 158
- Little, C. T. Set in Stone: The Face in Medieval Sculpture. In N. Y. THE METROPOLITAN MUSEUM OF ART (Ed.). New York YALE UNIVERSITY PRESS.
- Lyotard, J. F. (1979). *The Postmodern Condition*. United States: University of Minnesota.
- Marichal., N. a. (ICVS '01). *Interactive Immersive Transfiction*. Paper presented at the Proceedings of the International Conference on Virtual Storytelling.

- McCarthy, E. (2007). *William Blake's Laocoon The Genealogy of a Form*. (PhD), University of Kansas, USA.
- Nichols, B. (2001). *Introduction to Documentary* (1 ed.): Bloomington: Indiana University Press.
- Parent, A. (2005). Duchenne De Boulogne: A Pioneer in Neurology and Medical Photography. *THE CANADIAN JOURNAL OF NEUROLOGICAL SCIENCES*, 32(3).
- Prof. Brian Curless, J. C., John Gerth, Steve Marschner, Marc Levoy, Lisa Pacelle, Domi Pitarro, Kari Pulli. (2009). The Digital Michelangelo Project. Retrieved July 2012, 2012, from <https://graphics.stanford.edu/projects/mich/>
- Reilly, P. (1989). Data Visualization in Archaeology. *IBM Systems Journal*(28).
- Richards, J. D. (1998). Recent Trends in Computer Applications in Archaeology. *Journal of Archaeological Research*, 6(4), 331-382.
- Rosenstone, R. A. (1986). History in Images History in Words. *Humanities Working Paper*(121).
- Ryan, N. S. (1996). Computer-based visualisation of the past: Technical 'realism' and historical credibility. *Imaging the Past, Occasional Paper 114*.
- Saul, N. (2009). *English Church Monuments in the Middle Ages: history and representation*. UK: Oxford University Press.
- Schenk, T. (2005). Introduction to Photogrammetry (D. o. C. a. E. E. a. G. Science, Trans.): The Ohio State University.
- Tufte, E. R. (2001). *The Visual Display of Quantitative Information* USA: Graphics Press
- Unver, A. T. E. (2009). *An art and design perspective: The development of a 3D interactive Saltaire UNESCO world Heritage site*. Paper presented at the The 10th International Symposium on Virtual Reality, Archaeology and Cultural Heritage (VAST).
- Vaughan, W. (2012). *[Digital] Modeling*. USA: New Riders
- Vinzenz Brinkmann, O. P., Max Hollein. (2008). Circumlitio: The Polychromy of Antique and Mediaeval Sculpture. In P. o. t. J. D. P. Colloquium (Ed.).
- Wallenstein, S.-O. (2010). Space, time, and the arts: rewriting the Laocoon. *Journal of Aesthetics & Culture*, 2.
- Ware, C. (2008). *Visual Thinking: For Design* USA: Morgan Kaufmann
- Wilcock, J. D. (1973). *Science and Archaeology* Paper presented at the Computer Applications and Quantitative Methods in Archaeology (CAA), Birmingham UK.
- Wright, P. (1985). *On Living in an Old Country: The National Past in Contemporary Britain*. Oxford: Oxford University Press.

8. Bibliography

8.1. Books/eBooks

- Batchelor, D. (2000) *Chromophobia* USA. Reaktion Books
- Binsky, P. (1996). *Medieval Death, Ritual and Representation* Cornell University Press
- Brilliant, R. (2000). *My Laocoön Alternative Claims in the Interpretation*. USA: California Press.
- Friedhoff R, B. W. (1989). *Visualization, the Second Computer Revolution*: Abrams.
- Harrison, R. (2013). *Heritage: Critical Approaches*. Oxford: Routledge.
- Hewison, R. (1987). *The Heritage Industries: Britain in a Climate of Decline*. London: Methuen.
- Huxtable, A. L. (1993). *The Unreal America: Architecture and Illusion* USA: New Press
- Levy, R. M. (2002). *Computer Visualization and Architectural Reconstruction: An Image of Reality*. Canada: University of Calgary.
- Lyotard, J. F. (1979). *The Postmodern Condition*. United States: University of Minnesota.
- Nichols, B. (2001). *Introduction to Documentary* (1 ed.): Bloomington: Indiana University Press.
- Saul, N. (2009). *English Church Monuments in the Middle Ages: history and representation*. UK: Oxford University Press.
- Tufte, E. R. (2001). *The Visual Display of Quantitative Information* USA: Graphics Press
- Ware, C. (2008). *Visual Thinking: For Design* USA: Morgan Kaufmann
- Wright, P. (1985). *On Living in an Old Country: The National Past in Contemporary Britain*. Oxford: Oxford University Press.
- Bernard Frischer, A. D.-H. E. (2008). *Beyond Illustration: 2D and 3D Digital Technologies as Tools for Discovery in Archaeology* B. F. & A. Dakouri-Hild (Eds.), *British Archaeological Reports International Series*

8.2. Catalogue

- Little, C. T. *Set in Stone: The Face in Medieval Sculpture*. In N. Y. THE METROPOLITAN MUSEUM OF ART (Ed.). New York YALE UNIVERSITY PRESS.
- Vinzenz Brinkmann, O. P., Max Hollein. (2008). *Circumlitio: The Polychromy of Antique and Mediaeval Sculpture*. In P. o. t. J. D. P. Colloquium (Ed.).
- Wixom, W. D. (1989). *Medieval Sculpture at the Cloisters*. In T. M. M. o. Art (Ed.), *New Series* (Vol. 46): The Metropolitan Museum of Art.

8.3. Conference Papers/Proceedings

- El-Hakim, S., MacDonald, G., Lapointe, J.-F., Gonzo, L., Jemtrud, M. (2006). *On the Digital Reconstruction and Interactive Presentation of Heritage Sites Through Time*. Paper presented at the 7th International Symposium on Virtual Reality, Archaeology and Intelligent Cultural Heritage (VAST), Nicosia.
- Ganis, W. (2005). *Complexities and Contradictions in Digital Sculpture*. Paper presented at the International Symposium of Interactive Media Design (ISIMD), Istanbul.
- Jan Böhm, N. H., Susanne Becker. (2007). *FAÇADE MODELLING FOR HISTORICAL ARCHITECTURE*. Paper presented at the International CIPA Symposium, Athens Greece.
- Jessi Stumpfely, C. T., Tim Hawkins, Philippe Martinez², Brian Emerson, & Marc Brownlow, A. J., Nathan Yun, and Paul Debevec. (2003). *Digital Reunification of the Parthenon and its Sculptures*. Paper presented at the 4th International Symposium on Virtual Reality, Archaeology and Intelligent Cultural Heritage, Brighton UK.
- Marichal., N. a. (ICVS '01). *Interactive Immersive Transfiction*. Paper presented at the Proceedings of the International Conference on Virtual Storytelling.

- Smith, P. A. S. F. A. T. H. B. E. I. B. (2004). *Seeing into the Past: Creating a 3D Modeling Pipeline for Archaeological Visualization*. Paper presented at the Proceedings of the 2nd International Symposium on 3D Data Processing, Visualization, and Transmission, Thessaloniki, Greece.
- Unver, A. T. E. (2009). *An art and design perspective: The development of a 3D interactive Saltaire UNESCO world Heritage site*. Paper presented at the The 10th International Symposium on Virtual Reality, Archaeology and Cultural Heritage (VAST).
- Veronica Sundstedt, A. C., Philippe Martinez. (2004). *High Fidelity Reconstruction of the Ancient Egyptian Temple of Kalabsha*. Paper presented at the AFRIGRAPH '04 Proceedings of the 3rd international conference on Computer graphics, virtual reality, visualisation and interaction in Africa Stellenbosch, South Africa.
- Wilcock, J. D. (1973). *Science and Archaeology* Paper presented at the Computer Applications and Quantitative Methods in Archaeology (CAA), Birmingham UK.

8.4. Journal Articles

- A. Foni, G. P., N. Magnenat-Thalmann. (2004). <A Virtual Heritage Case Study_ A Modern Approach to the Revival of Ancient Historical or Archeological Sites.pdf>. *MIRALab: University of Geneva*.
- Agugiaro, F. R., G Girardib, J von Schwerinc, H Richards-Rissettod, R De Amicis. (2011). A Web-Based Interactive Tool for Multi-Resolution Models of a Maya Archaeological Site. *International Archives of the Photogrammetry, Remote Sensing and Spatial Information Sciences, Volume XXXVIII*.
- Alexander, J. S. (2007). The Introduction and Use of Masons' Marks in Romanesque Buildings in England. *Medieval Archaeology*, 51(1), 63-81. doi: 10.1179/174581707x224660
- Bak, D. (2003). Rapid prototyping or rapid production? 3D printing processes move industry towards the latter. *Assembly Automation*, 23(4), 340-345. doi: 10.1108/01445150310501190
- Bakker, G., Meulenber, F., & Rode, J. d. (2003). Truth and credibility as a double ambition: reconstruction of the built past, experiences and dilemmas. *The Journal of Visualization and Computer Animation*, 14(3), 159-167. doi: 10.1002/vis.314
- Bakker, G., Meulenber, F., & Rode, J. d. (2003). Truth and credibility as a double ambition: reconstruction of the built past, experiences and dilemmas. *The Journal of Visualization and Computer Animation*, 14(3), 159-167. doi: 10.1002/vis.314
- Barbosa, Á. (2009). Virtual Restauration of a XVIII Century Sculpture *Virtual Restoration Journal of the Arts (CITAR)*, 1.
- Bawaya, M. (2006). Digital Digs. *Nature*, 440.
- Boehler, W. H., G. Marbs, A. Potential of Non Contact Laser Scanners for Cultural Heritage Recording. *CIPA Working Group VI*.
- Bonora, V. (2003). 3D metric modelling for knowledge and documentation of Architectural Structures (Royal Palace of Turin) *The International Archives of the Photogrammetry, XXXIV*.
- Bradley, M. (2009). The Importance of Colour on Ancient Marble Sculpture. *Art History*, 32(3), 427.
- Bruno, F., Bruno, S., De Sensi, G., Luchi, M.-L., Mancuso, S., & Muzzupappa, M. (2010). From 3D reconstruction to virtual reality: A complete methodology for digital archaeological exhibition. *Journal of Cultural Heritage*, 11(1), 42-49. doi: 10.1016/j.culher.2009.02.006
- Burden, D., & Slater, S. (2008). Serious games. *Itnow*, 50(5), 6-7. doi: 10.1093/itnow/bwn089
- Campbell, R. J., & Flynn, P. J. (2001). A Survey Of Free-Form Object Representation and Recognition Techniques. *Computer Vision and Image Understanding*, 81(2), 166-210. doi: 10.1006/cviu.2000.0889
- Ch'ng, E. (2009). Experiential archaeology: Is virtual time travel possible? *Journal of Cultural Heritage*, 10(4), 458-470. doi: 10.1016/j.culher.2009.02.001
- Cignoni, P., & Scopigno, R. (2008). Sampled 3D models for CH applications. *Journal on Computing and Cultural Heritage*, 1(1), 1-23. doi: 10.1145/1367080.1367082
- Clowes, P. G. B. a. M. (1997). Surveying Stonehenge by 3d Photogrammetry. *English Heritage: Photogrammetric Record*, 15(89).
- Coltrain, J. (2009). <Reimaging Past Worlds.pdf>. (Volume 1 Number 2).
- Dressler, R. (2008). Gender as Spectacle and Construct: The Gyvernay Effigies at St. Mary's Church, Limington. *Different Visions: A Journal of New Perspectives on Medieval Art*(1).
- F, R. 3D Virtual Reconstruction and Visualisation of Complex Architecture. *NRC Publications Archive (NPArc)*.

- Favro, D. (2006). In the Eyes of the Beholder: Virtual Reality Re-creations and Academia in Imaging Ancient Rome. *Journal of Roman Archaeology*(61), 321-334.
- Geller, T. (2010). Rebuilding for eternity. *Communications of the ACM*, 53(1), 19. doi: 10.1145/1629175.1629185
- Gibbons, G. (2010). Visualisation in Archaeology: Connecting Research and Practice. *Virtual Archaeology Review*, 1(2).
- Gibson, I. (2006). Rapid prototyping: from product development to medicine and beyond. *Virtual and Physical Prototyping*, 1(1), 31-42. doi: 10.1080/17452750500271298
- Gill, A. A. (2009). Digitizing the Past: Charting New Courses in the Modeling of Virtual Landscapes. *Visual Resources*, 25(4), 313-332. doi: 10.1080/01973760903331809
- Giralt, G. F. (2010). Realism and Realistic Representation in the Digital Age. *journal of film and video*, 62(3).
- Goulding, C. (1998). The Commodification of the Past, Post Modern Pastiche and the search for Authentic Experiences. *European Journal of Marketing*, 34(7).
- Graves, C. P. (2008). From an Archaeology of Iconoclasm to an Anthropology of the Body: Images, Punishment, and Personhood in England, 1500–1660. *Current Anthropology*, 49(1), 35-60. doi: 10.1086/523674
- Haegler, S., Müller, P., & Van Gool, L. (2009). Procedural Modeling for Digital Cultural Heritage. *EURASIP Journal on Image and Video Processing*, 2009, 1-11. doi: 10.1155/2009/852392
- Holden, J. J. a. L. (2007). Virtual Heritage: Living in the Past. *Technè*, 10.
- Hull, C., Feygin, M., Baron, Y., Sanders, R., Sachs, E., and, A. L., & Wohlers, T. (1995). Rapid Prototyping: Current Technology and Future Potential. *Rapid Prototyping Journal*, 1(1).
- J.-A. Beraldin, M. P., S.F. El-Hakim, G. Godin, V. Valzano, A. Bandiera. (2005). <Combining 3D Technologies for Cultural Heritage Interpretation and Entertainment.pdf>. *SPIE: Electronic Imaging 2005*.
- Kus, A, Unver, E and Taylor, A (2009) A comparative study of 3D scanning in engineering, product and transport design and fashion design education, *Computer Applications in Engineering Education*, 17 (3). pp. 263-271. ISSN 1061-3773
- Lavender, D. A. (1990). Solid Modeling of Roman Bath. *Communication in Archaeology: A Global View of the Impact of Information Technology*.
- Levy, R. M. (2001). Temple Site at Phimai: Modeling for the Scholar and the Tourist *Proceedings of Seventh International Conference on Virtual Systems and Multimedia IEEE Computer Society*(7), 147 - 158
- Lindgren-Streicher, A., & Reich, C. A. (2007). Visitor Usage of Digital and Physical Artifacts in Two Museum Programs. *Visitor Studies*, 10(2), 152-167. doi: 10.1080/10645570701603666
- Losier, L. M., Pouliot, J., & Fortin, M. (2007). 3D geometrical modeling of excavation units at the archaeological site of Tell 'Acharneh (Syria). *Journal of Archaeological Science*, 34(2), 272-288. doi: 10.1016/j.jas.2006.05.008
- M, H. P. Duchenne Discourses of Aesthetics, Sexuality, and Power in Nineteenth-Century Medical Photography
- Osborne, B. S. (2002). Moose Jaw's "Great Escape": Constructing Tunnels, Deconstructing Heritage, Marketing Places. *Material History Review*, 55.
- Parent, A. (2005). Duchenne De Boulogne: A Pioneer in Neurology and Medical Photography. *THE CANADIAN JOURNAL OF NEUROLOGICAL SCIENCES*, 32(3).
- Pavlidis, G., Koutsoudis, A., Arnaoutoglou, F., Tsioukas, V., & Chamzas, C. (2007). Methods for 3D digitization of Cultural Heritage. *Journal of Cultural Heritage*, 8(1), 93-98. doi: 10.1016/j.culher.2006.10.007
- Pujol, L. (2004). Archaeology, museums and virtual reality. *Digit HVM. Revista Digital d'Humanitats*, 6.
- Reilly, P. (1989). Data Visualization in Archaeology. *IBM Systems Journal*(28).
- Richards, J. D. (1998). Recent Trends in Computer Applications in Archaeology. *Journal of Archaeological Research*, 6(4), 331-382.
- Rooks, B. (2002). Rapid manufacturing advances at Loughborough. *Assembly Automation*, 22(4), 333-336. doi: 10.1108/01445150210446193
- Roos, H. d. (2004). The Digital Sculpture Project: Applying 3D Scanning Techniques for the Morphological Comparison of Sculptures. *Computer and Information Science*, 9(2).
- Rosenstone, R. A. (1986). History in Images History in Words. *Humanities Working Paper*(121).
- Ryan, N. S. (1996). Computer-based visualisation of the past: Technical 'realism' and historical credibility. *Imaging the Past, Occasional Paper* 114.
- Santos, D. M. C., Pertence, A. E. M., Campos, H. B., & Cetlin, P. R. (2005). The development of 3D models through rapid prototyping concepts. *Journal of Materials Processing Technology*, 169(1), 1-4. doi: 10.1016/j.jmatprotec.2004.06.035

- Sass, L., & Oxman, R. (2006). Materializing design: the implications of rapid prototyping in digital design. *Design Studies*, 27(3), 325-355. doi: 10.1016/j.destud.2005.11.009
- Sass, L., & Oxman, R. (2006). Materializing design: the implications of rapid prototyping in digital design. *Design Studies*, 27(3), 325-355. doi: 10.1016/j.destud.2005.11.009
- Schleif, C. (2008). <Are We Still Being Historical Exposing History and Theory.pdf>. *Different Visions: A Journal of New Perspectives on Medieval Art*(1).
- Stone, R. (2008). Serious games: virtual reality's second coming? *Virtual Reality*, 13(1), 1-2. doi: 10.1007/s10055-008-0109-7
- Stone, R. (2008). Serious games: virtual reality's second coming? *Virtual Reality*, 13(1), 1-2. doi: 10.1007/s10055-008-0109-7
- Trenholme, D., & Smith, S. P. (2008). Computer game engines for developing first-person virtual environments. *Virtual Reality*, 12(3), 181-187. doi: 10.1007/s10055-008-0092-
- Unver, E, Taylor, A (2012) Virtual Stonehenge Reconstruction. Progress in Cultural Heritage Preservation. Proceedings: Springer, pp. 449-460. ISBN 978-3-642-34234-9
- Unver, E, Atkinson, P Tancock, D (2006) Applying 3D scanning and modeling in transport design education.<<http://eprints.hud.ac.uk/231/>> Journal of Computer-Aided Design and Applications, 3 (1-4). pp. 41-48. ISSN 1686-4360
- Unver, E (2006) Strategies for the transition to CAD based 3D design education Computer-Aided Design and Applications, 3 (1-4). pp. 323-330. ISSN 1686-4360
- Wallenstein, S.-O. (2010). Space, time, and the arts: rewriting the Laocoon. *Journal of Aesthetics & Culture*, 2.
- Willis, A., Speicher, J., & Cooper, D. B. (2007). Rapid prototyping 3D objects from scanned measurement data. *Image and Vision Computing*, 25(7), 1174-1184. doi: 10.1016/j.imavis.2006.06.011
- Zhang, L. Y., Zhou, R. R., & Zhou, L. S. (2003). Model reconstruction from cloud data. *Journal of Materials Processing Technology*, 138(1-3), 494-498. doi: 10.1016/s0924-0136(03)00127-4

8.5. Magazine/Newspaper Articles

- Abrahams, T. (2010). The World's First Printed Building. *Blueprint Magazine - Architecture & Design*.
- Catterson, L. (2005). An Ancient Masterpiece or a Master's Forgery?, *New York Times*.

8.6. Reports/Hearings/Standards

- Abbot, M. (2012). Stonehenge Laserscan_Archaeological Analysis Report 6457 *Research Report Series* (Vol. Research Report Series). UK: English Heritage.
- Levy, R. M. (2002). Computer Visualization and Architectural Reconstruction: An Image of Reality. Canada: University of Calgary.
- Schenk, T. (2005). Introduction to Photogrammetry (D. o. C. a. E. E. a. G. Science, Trans.): The Ohio State University.
- Yastıklı, N. (2004). 3D MODEL GENERATION AND VISUALIZATION OF CULTURAL HERITAGE. Istanbul: Yildiz Technical University.
- Zhiqiang Du, T. W., Guanghui Liu. (2007). Detail Preservation: 3-D Modelling for Elaborate Buddha Sculpture. China: Wuhan University.
- Durham UNESCO World Heritage List Application*, (1985).
- Denard, H. (2009). FOR THE COMPUTER-BASED VISUALISATION OF CULTURAL HERITAGE (Vol. DRAFT 2.1). London.

8.7. Thesis

- Arvanigian, M. E. (2000). The Nevilles and the Political Establishment in North East England 1377-1413. (PHD), University of Durham, Durham.

- Finch, J. (1996). CHURCH MONUMENTS IN NORFOLK AND NORWICH.pdf. (PHD The), UEA, Norwich.
- Gain, J. E. (2000). Enhancing Spatial Deformation for Virtual Sculpting. (PhD), University of Cambridge.
- Hathaway-Smith, M. (2010). A Necessary Duty, A Hideous Fault: Digital Technology and the Ethics of Archaeological Conservation. (Master of Arts), Texas A&M University, Texas.
- Luff, A. N. M. (2001). THE PLACE OF DURHAM CATHEDRAL PRIORY IN THE POST-CONQUEST SPIRITUAL LIFE OF THE NORTH-EAST. (PhD), University of Durham, Durham.
- Lynne MCGoldrick, M. A. (1985). PATRONAGE OF THE BEAUCHAMP AND NEVILLE FAMILIES IN THE LATE MIDDLE AGES, c. 1390 - 1500. (PhD), Newcastle Polytechnic, Newcastle Upon Tyne.
- Marshall, J. J. (2008). AN EXPLORATION OF HYBRID ART AND DESIGN PRACTICE USING COMPUTER-BASED DESIGN AND FABRICATION TOOLS. (PhD), The Robert Gordon University.
- McCarthy, E. (2007). William Blake's Laocoon The Genealogy of a Form. (PhD), University of Kansas, USA.
- McClain, A. (2005). Patronage, Power, and Identity: the Social Use of Local Churches and Commemorative Monuments in Tenth to Twelfth-Century North Yorkshire. (PhD), University of York, York.
- Monteiro, P. Computer Graphics in Archaeology
- Premadasa, V. N. (2005). Reality and Realism in Virtual Architectural Reconstruction. (PhD), University of Strathclyde, Strathclyde Scotland.
- Salisbury, B. (2009). Of Gods, Beasts and Men: Digital Sculpture. University of Central Florida.

8.8. Web Pages

- Donnell, D. O. (2012). Is there a text in this edition: On the Implications of Multiple Media and Immersive Technology for the Future of the Scholarly Edition. Retrieved September 25, 2012, from <http://visionarycross.org>
- Prof. Brian Curless, J. C., John Gerth, Steve Marschner, Marc Levoy, Lisa Pacelle, Domi Pitorro, Kari Pulli. (2009). The Digital Michelangelo Project. Retrieved July 2012, 2012, from <https://graphics.stanford.edu/projects/mich/>
- Knowles, R. Medieval Livery Collars. Retrieved May 2012, 2012, from http://www.richard111.com/medieval_livery_collars.htm
- Eaton, Scott. 3D Artist from <https://www.scott-eaton.com>

9. Appendix

Please see attached DVD for associated digital files for this project