

Biomolecular Engineered Sensors for Diagnostic Applications

Maria Marti Villalba

A thesis submitted in partial fulfilment of the requirements of Nottingham Trent University for the degree of Doctor of Philosophy

September 2009

Declaration

This work is the intellectual property of the author, and may also be owned by the research sponsor(s) and / or Nottingham Trent University. You may copy up to 5% of this work for private study, or personal, non commercial research. Any re-use of the information contained within this document should be fully referenced, quoting the author, title, university, degree level and pagination. Queries or requests for any other use, or if a more substantial copy is required, should be directed in the first instance to the author.

Acknowledgments

I would like to take this opportunity to thank all the people who have helped and supported me through the duration of my study at Nottingham Trent University. Firstly I would like to deeply thank my first supervisor Dr James Davis, his expertise, understanding, patience, kindness and hard work, added considerably to my graduate experience and to whom this has been possible. I would like to thank my second supervisor Dr Jason Birkett for his help and supervision. I would also like to thanks to all the members of the group, Laura Newton and Duncan Sharp for their help and friendship and I would like to thanks Dr Rob Smith for his friendly support.

I would like to express my gratitude to all my friends, Cristina Bermejo, David Muñoz, Dr Souvik Mukherjee, Juan Moreno, Andrea March, Christophe Lemetre and specially to Juan Gassol, they have been a fundamental support during difficult moments and with whom I shared memorable experiences.

Finally I would like to thank all my family for their eternal love and support and in particular to my parents to whom I dedicate this thesis.

Abstract

Electrochemistry is a powerful technique that offers multiple possibilities and which is in constant evolution. Simple modifications of the electrode surface can result in an improvement of the selectivity and sensitivity of the method. However some situations require more complex modifications such as the incorporation of an external agent to the electrode surface, or within the actual electrode. This thesis describes the development and characterization of a range of novel electrochemical sensors for multiple applications covering agri-food, biomedical and environmental contexts. The foundations of the approach rest upon the development of carbon-loaded polycarbonate composite films. Their fabrication is described and the ease with which they can be modified and physically adapted is highlighted and critically evaluated. The response of the resulting sensors have been validated against conventional techniques.

An overview of the technologies employing carbon electrodes is presented in Chapter 1 and serves to set the context of the subsequent research. The various methodologies employed are outlined in Chapter 2. Preliminary modifications of the analytical process has evolved from the *ex situ* functionalisation of the conventional carbon electrodes with copper (Chapter 3) through to the examination of the versatility and complexities of sample pre-treatment (Chapter 4). The pre-treatment of the sample using naphthoquinones as labeling agents has been developed and this work was extended to examine a wholly new derivatisation agent which could have analytical and clinical/veterinary diagnostic merit. A new direction was sought to overcome the limitations of the conventional analytical approach and composite systems were envisaged as providing an accessible yet flexible method of developing electrochemical sensors for discrete probe and flow systems. The basic procedure has been characterized and optimized for a range of analytes such as neurotransmitters (Chapter 5), anti-oxidants (Chapter 6), purine metabolites (Chapter 8) and phosphate (Chapter 9). Each chapter highlights a different aspect and applicability of the composite and go from simple physical surface modification (Chapter 5) to the incorporation of chemical agents (Chapter 6) and more complex systems such as enzymes (Chapters 8 and 9).

i	Declaration
ii	Acknowledgments
iii	Abstract
iv	Contents
viii	Abbreviations
1	Chapter 1 : Introduction to carbon based sensors
2	1.1.Introducion
4	1.2. Core Detection Design
5	1.3. Carbon : A Versatile Substrate
6	1.4. Surface Modification
9	1.5 Polymer coatings
13	1.6. Carbon Composite Electrodes
16	1.7. Diamond Electrodes
17	1.8 Conclusions
18	1.9. Project Aims and Objectives
19	1.10.References
24	Chapter 2 : Experimental Techniques
25	2.1. Introduction to Chromatography
25	2.2. Classification of Chromatographic Methods
26	2.3. Principles and Theory
27	2.3.1. The chromatogram
28	2.3.2.Retention Parameters
28	2.3.3. Efficiency of Separation
29	2.3.4. Resolution
31	2.4. High Performance Liquid Chromatography
32	2.5. Introduction to Electrochemistry
33	2.5.1. Electrochemical Cells
33	2.5.2. Reference Electrodes
35	2.5.3. Working Electrodes
35	2.5.4. Auxiliary/ Counter Electrodes
35	2.6. Mass Transport
36	2.6.1. Diffusion
37	2.6.2 Convection
38	2.6.3. Migration
39	2.7. Voltammetry
41	2.7.1. Cyclic Voltammetry
45	2.8. Scanning Electron Microscopy (SEM)
46	2.9. Atomic Force Microscopy (AFM)
48	2.9.1 Modes of operation
49	2.10. References
50	Chapter 3 : New Strategies for Detecting Nitrate
51	3.1. Introduction
53	3.2. Commercial Field Systems

57	3.3 New Developments
63	3.4. Summary
64	3.5. Proposed Methodology
65	3.6. Experimental Set-up
65	3.6. 1. Carbon Fibre Electrode Construction
66	3.6.2 Copper-Gold Nano Deposit
66	3.6.3 Flow Cell Construction
67	3.7. Results and Discussion
74	3.7.1. Nano-Structured Cu-Au Flow Detector for Nitrate Analysis
80	3.8. Conclusions
81	3.9 References
84	Chapter 4 : Assessing some Novel Approaches to Thiol Detection
85	4.1. Introduction
85	4.1.1. Environmental Analysis
88	4.1.2 Veterinary Diagnostics
90	4.2. Experimental Details
90	4.2.1. Methods and Materials
90	4.2.2 Chemical Syntheses
95	4.3. Results and Discussion
95	4.3.1. Evaluation of Quinone Labelling Strategy
103	4.3.2. Evaluation of the Epoxide Labelling Strategy
105	4.4. Conclusions
107	4.5. References
109	Chapter 5 : A Composite Approach to Detecting Neurotransmitters and Their Metabolites
110	5.1. A New Direction
110	5.2. Background
111	5.3. Suicide Statistics
112	5.4. Current Practice
113	5.5. Neurochemistry of Suicide
114	5.5.1. The Serotonergic System – Serotonin and 5-Hydroxyindole-3-acetic Acid
118	5.5.2. Dopaminergic and Noradrenergic Systems
11	5.6. Detection Techniques
123	5.6.1. Direct Determination
124	5.6.2. Indirect Determination-Derivatisation
127	5.7. Sampling Issues
128	5.8. Review Summary
129	5.9. Proposed Methodology
131	5.10. Experimental
131	5.10.1. Preparation of Modified Electrode
132	5.11. Results and Discussion
132	5.11.1 Electrode Characterisation
134	5.11.2. Electrochemical Behaviour of the Laser Treated Carbon Composite

137	5.11.3. Determination of 5HIAA
138	5.11.4. Determination of 5-HIAA in Human Urine
138	5.11.5. From the Lab to the Clinic
140	5.12. Conclusions
142	5.3. References
147	Chapter 6 : Catalytic Composites – Determination of Ascorbate
148	6.1. Introduction
150	6.2. Experimental Details
150	6.2.1. Chemicals and Materials
151	6.3 Results and Discussion
151	6.3.1. Sensor Construction
152	6.3.2. Surface Characterisation
152	6.3.3. Electrochemical Characterisation
156	6.3.4. Electrode Stability
158	6.3.5. Ascorbic Acid Detection
158	6.3.5.1. FIA Analysis of Vitamin C
160	6.3.5.2. Determination of Ascorbate in Rose Hip Tea.
163	6.3.5.3. Determination of AA in Human Saliva
165	6.4. Analytical Application
166	6.5. Conclusions
167	6.6. References
169	Chapter 7: Composites-Bioelectrochemical Detection Strategies
170	7.1. Introduction
171	7.2. Biosensors – The Foundations
173	7.3. Engineered Composites – Form and Function
174	7.4. Inorganic Materials
177	7.5. Organic Systems
183	7.6. Carbon Nanotubes
185	7.7. Hybrid Systems
189	7.8. Conclusions
191	7.9. References
196	Chapter 8 : Biosensing of Purine Metabolites
197	8.1. A Further Development
197	8.2. Introduction
203	8.3. Experimental Set-up
203	8.3.1. Sample Collection
204	8.3.2. Electrode Construction
207	8.4. Results and Discussion
207	8.4.1. Saliva, A Biological Tool: Chromatographic Studies
210	8.4.2. Electrode Characterisation
218	8.5. Conclusions
219	8.6. References
220	Chapter 9 : Phosphate Detection: Assessing the Generic Applicability of the Filter Sensor

221	9.1. Introduction
222	9.2. Potentiometric Detection
225	9.3. Voltammetric Studies
226	9.4. Phosphate Biosensors
235	9.5. Future Directions and Proposed Methodology
237	9.6. Sample Preparation and Experimental Details
237	9.6.1. Electrode Construction
237	9.7. Results and Discussion
243	9.8. Conclusions
244	9.9. References
243	Chapter 10 : Conclusions and Further Work
243	10.1. Conclusions and Further Work

5-HT	Serotonin	LOD	Lactate oxidase.
TFAA	trifluoroacetic anhydride	Mb	Myoglobin.
5HIAA	5-Hydroxyindoleacetic acid	Mb	Miglobina
5HTTr	Serotonin Transporter	MCPE	Modified carbon paste electrode.
A	Allantoin	MDB	Medola's blue.
AA	Ascorbic acid.	MDD	Melancholic Major Depressive Disorders
AAO	Anodic aluminum oxide.	MHPG	3-methoxy-4-hydroxyphenylglycol
ABTS	2,2'-azinobis 3-ethylbenzothiazoline-6-sulfonate	MP	Maltose phosphorylase
AChE	Acetylcholine esterase	MPMSi	3-Mercaptopropyltrimethoxysilane
ACN	Acetonitrile	MPS	3-Mercapto-1-propanesulfonic acid
AD	Adenine.	MPT	Methyl-patanthion
AD drugs	Alzheimer diseases drugs.	MPTMS	3-Mercaptopropyl-trimethoxysilane.
ADH	Alcohol dehydrogenase.	MR	Mutarotase
ADP	Adenosine diphosphate	MS	Mass spectroscopy
AFSNPs	Acid-modified magnetic core-shell nanoparticles	MTMOS	Methyltrimethoxysilane.
AMP	Adenosine monophosphate	MUA	11-Mercaptoundecanoic acid.
AOB	Antimony oxide bromide.	MV	Methyl viologen.
AP	Alkaline Phosphatase	MWCNTs	Multi walled carbon nanotubes.
ATP	Adenine Tri-phosphate	NADH	Nicotinamide adenine dinucleotide
AuNPs	Gold nanoparticles.	NDA	naphthalene-2,3-dicarboxaldehyde
BMIM.BF4	1-Butyl-3-methylimidazolium Tetrafluoroborate.	NE	Norepinephrine
BMIMPF6	1-Butyl-3-methylimidazolium hexafluorophosphate	NOX	NADH Oxidase
BQ	Benzoquinone	NP	Nucleoside Phosphorylase
BR-Buffer	Britton Robinson	NPs	Nanoparticles.
BSA	Bovine serum albumin	NVZ	Nitrate Vulnerable Zones
BSSI	Beck Scale for Suicide Ideation	OP	Organophosphorus.
CF	Carbon fiber	P3MT	poly (3-methylthiopen),
CHIT	Chitosan.	P450 scc	Cytochrome P450scc
CHOX	Cholesterol oxidase.	PAA	Polyacrylamide
CILE's	Carbon ionic liquid electrodes.	p-ABSA	p-aminobenzene sulfonic acid
CNS	Central nervous System	PAG	Poly(glutamic acid)
CNT	Carbon Nanotube	PAH	polyallylamine hydrochloride
CNT's	Carbon nanotubes	PAMAM	Polyamidoamine.
CoHCF	Cobalt Hexacyanoferrate Modified Electrode	PANAA	Poly(acrylonitrile-co-acrylic acid)
Coll	Colloidal.	PAni	Polyaniline
CoPc	Cobalt phthalocyanine	Pani	Polyaniline
CPE	Carbon paste electrode	PB	Prussian blue
CPE	Carbon paste electrodes	PC-Fc	polycarbonate-carbon-ferrocene
CR	Creatinine	PDC	2,6-Pyridinedicarboxylic acid.
CSF	cerebral spinal fluid	PDDA	Poly(diallyldimethylammonium chloride).
CTAB	Cetyltrimethylammonium bromide.	PEA	Phosphatidyl-ethanolamine.
Cyt c	Cytochrome C.	PEG	Polyethylene glycol
DA	Dopamine	PEI	Polyethyleneimine.
DB71	Azo dye direct blue	PFIL	Polyethylenimine-functionalized ionic liquid.
DCM	Dichloromethane	PFPA	Pentafluoropropionic anhydride
DH	Dehydrogenase	PMF	polyelectrolyte multilayer film
DMF	Dimethylformamide	PNR	Poly(neutral red).
DNA	Deoxyribonucleotide acid.	POAP	Poly(o-aminophenol).
DPE	1,2-Diphenylethylenediamine	POD	Pyruvate oxidase.
D-Pro	D-Proline.	PPD	Poly(o-phenylenediamine)
D-Pro	D-Prolyne	PPF	Plasma-polymerized film
DSM	Pseudomonas putida.	PPO	Polyphenol oxidase
E	Epinephrine	PPY	Polypyrrole
ECD	Electrochemical detection	PSS	polysodium 4-styrenesulfonate
ECD-Coul	Coulometric Detector	Pt	Platinum.
EDOT	3,4-Ethyl-enedioxythiophene	PTHNW	Polythionine nanowire
EMIM.BF4	1-Ethyl-3-methylimidazolium tetrafluoroborate	PtNPs	Platinum nanoparticles
FAD	Flavin Adenine Dinucleotide	PTSD	Post Traumatic Stress Disorder
FAuNPs	Functionalized gold nanoparticles.	PU	Polyurethane.
FeMeOH	Ferrocene methanol	PVA	Poly(vinyl alcohol).
FCN	Ferrocyanide	PVA	Poly(vinyl alcohol)
FIA	Flow injection analysis.	PVC	Polyvinyl acetate.

FMC	Ferrocenemonocarboxylic acid.	PVF	Polyvinylferrocene.
GalOD	Galactose oxidase.	PVI-Os	Polyvinylimidazole-Osmium gel.
GC	Glassy carbon.	PVS	poly(vinylsulfate)
GluDH	Glutamate Dehydrogenase	RIGG	Rabbit IgG
GlutaOD	Glutamate Oxidase	ROS	Reactive Oxygen Species
GOD	Glucose oxidase.	RSH	Reduced sulphur compounds
GP	General Practitioner	Si-SG	Silica sol gel.
GU	Guanine.	SOX	Sulfhydryl oxidase.
HAO	Histamine Oxidase	SSNRI	Selective Serotonin norepinephrine reuptake inhibitors
Hb	Haemoglobin.	SSRI	Selective Serotonin Reuptake Inhibitor
HEX	Hexokinase	SSRI's	Selective Serotonin Reuptake Inhibitor's
HOPH	Highly orientated pyrolytic graphite	SWCNTs	Single walled carbon nanotubes.
HPA-Axis	Hypothalamic-pituitary – adrenal axis	TATP	Triacetone triperoxide.
HQ	Hydroquinone	TEOS	Tetraethoxysilane
HRP	Horse Radish Peroxidase	THY	Tryptophan.
HVA	Homovanillic acid	Ti-MCM-4	Mesoporous titanosilicate
HX	Hypoxanthine	TPPZ	Tetra-2-pyridyl-1
IgGs	Anti- immunoglobulin.	Try	Tryptophan
IL's	Ionic liquids	TTF-TCNQ	Tetrathiafulvalene-tetracyanoquinodimethane
IL's	Ionic liquids	TTP	Thiamine Diphosphate
ISE	Ion selective electrode.	Tyr	Tyrosinase.
ITO	Indium Tin Oxide	WHO	World Health Organisation (WHO)
LAC	Laccase.	XO	Xanthine oxidase.
LDH	Lactate dehydrogenase.	ZMCPE	Zeolite modified carbon paste electrode
LDL	Low Density Lipoproteins		

Instrumental Terminology

AC	
CE	Counter Electrode
CTR	Cathode Ray Tube
CV	Cyclic Voltammetry
EC	Electrochemical-Chemical process
EC'	Catalysed Electrochemical-Chemical process
ECD	Electrochemical Detection
ECE	Electrochemical-Chemical-Electrochemical process
ED	Electrochemical Detection
FIA-P	Flow Injection Potentiometric Analysis
FL	Fluorescence
GC	Gas Chromatography
HPLC	High Performance Liquid Chromatography
HPLC	High performance liquid chromatography
IEC	Ion Exchange Chromatography
ISE	Ion Selective Electrode
LC	Liquid Chromatography
LEC	Molecular Exclusion Chromatography
LLC	Partition Chromatography
LSC	Liquid -Solid adsorption chromatography
PISE	Phosphate Ion Selective Electrode
RE	Reference Electrode
RVC	Reticulated vitreous carbon
SEM	Scanning Electron Microscopy
SHE	Standard Hydrogen Electrode
WE	Working Electrode

Equation Definition

K_m	Enzyme affinity
B	longitudinal diffusion
CS	mass transfer in the stationary phase
D	Diffusivity
H	plate height
i	current
J	Flux
jm	migration flux
K'	Capacity Factor
N	number of plates
R	Resolution
R	electrical resistance
t_R	Retention Time
t_{R'}	Adjusted Retention Time
u	diffusion of the solute in the mobile phase
V_{max}	Enzyme velocity
W	Peak Width
W_{1/2}	Peak Width at middle of the height.
α	Selectivity Factor
Φ_s	potential of the solution
Φ_m	potential of the metal
Φ	electric field

Chapter 1

Introduction to Carbon Based Sensors

Abstract

Carbon has long been recognised as a versatile electrode material and has found numerous uses in analytical applications. The work presented in subsequent chapters has focused on the development of composite materials based on this material and their analytical characterisation. The present chapter outlines the overall aims and objectives of the project and gives an overview of recent developments in the applications and modification of carbon based sensors.

*The work presented in this chapter has been accepted for publication within the
Journal of Solid State Electrochemistry.*

1.1. Introduction

Chromatographic techniques are undoubtedly the most prevalent analytical technique that will be found within laboratories conducting routine analysis – whether for biomedical, industrial or environmental tasks. These techniques can offer superior resolution when dealing with complex samples as a consequence of the analyte separation that can be achieved in passage through a column. While post-column detection is usually provided by a spectroscopic detector (typically uv/vis), it has long been recognised that electrochemical detection can provide significant, albeit specialised, advantages over the former. While there are numerous situations in which hybrid liquid chromatography – electrochemical detection systems could be applied, their adoption as mainstream analytical processes has been slow to gather support. The core aim of the present project has been to develop new electrode materials that highlight the versatility of the methodology across a number of different analytical contexts and which could counter some of the problems that have contributed to the reluctance of the analytical community to embrace electrochemical detection. There is an increasing interest in the transfer of conventional lab based technologies to a portable, often disposable, format and thus the secondary aim of the work was to establish whether those same electrode materials could be adapted for use as the foundation of a discrete sensor capable of operation outside the laboratory.

One of the most important advantages offered by electroanalytical detection is that it can allow the direct detection of certain analyte classes and thereby considerably simplify the analytical process – removing the need for the derivatisation processes that must be employed where the target possesses a weak chromophore [1-3]. This has been extensively exploited in the present project through the detection of various organic species (thiols, purines and neurotransmitters) and inorganic species (nitrate and phosphate). These cover a variety of analytical contexts and seek to highlight the adaptability of the technique. It has been suggested that electrochemical detection is a more selective detection option than the spectroscopic approach as the majority of the

matrix will not be electroactive within conventional electrode operating windows and hence essentially invisible to the electrode [1-3]. This is true in terms of inducing a signal. However, the most common problem with the introduction of electrochemical detectors has been the fact that the sensing surface must come into contact with the sample in order to register a signal. Electrochemical detection is an interfacial technique and while most components may be invisible - they may nevertheless affect the signal magnitude of the intended target through fouling the electrode. The adsorption of matrix elements onto electrode surfaces and the need for regular and elaborate maintenance of the latter may well be a contributing factor in the relative absence of the latter from mainstream labs.

This is clearly a rather short-sighted view as electrochemical detection is inherently versatile. The placement of the electrodes in series have been shown to further aid the identification of co-eluting analytes and there have been more recent developments in using electrode arrays where the individually addressable electrodes are set at alternating potentials to induce the redox cycling amplification of the resulting signals. The choice of electrode material can be pivotal in optimising the analytical sensitivity – this could be viewed as additional complexity but it could offer superior performance. Such detectors have taken many forms and have exhibited sensitivities that can compliment or in many instances out perform conventional uv spectroscopic techniques [1-15]. They can offer greater procedural simplicity than fluorimetric systems [16-19] and are significantly less expensive, both to procure and operate, than mass spectroscopic detection (LC-MS) [20-24].

There have been many developments in the design and development of electrode materials for use in electrochemical detection. The work presented herein has focused on the use of carbon as this is a particularly flexible substrate and can easily be adapted to suit particular applications. This is especially true when considering its application as the base material in composite materials. The latter has been extensively exploited in subsequent chapters. Before considering the various analytical options presented by such materials it is necessary to consider the background to the development of

electrochemical detectors and the progress that has already been made. The various modifications that can be undertaken to enhance detector performance and the emergence and potential impact of new composite materials is considered in the following sections.

1.2. Core Detector Design

Electrochemical detectors generally take one of three core design formats and relate principally to how the working electrode is arranged with respect to the direction of the mobile phase flow. Schematics outlining these are detailed in **Figure 1-1**. The simplest relates to the insertion of a planar electrode within the flow system. This can be extended to porous carbon systems (typically pyrolytic graphite) that encompass the entire diameter of the flow channel. The latter are designed more for coulometric analysis in which the complete conversion of the analyte can be achieved [1,2]. The third design inserts the electrode perpendicular to the flow (wall jet). Each methodology has its merits depending on the nature of the electrode being used and there will always be variations in the design of the cell used within research environments. The construction of arrays introduces an extra dimension to those already outlined in **Figure 1-1** and can greatly enhance the selectivity allowing post column resolution at the detector. Multiple detectors placed in series, each set at a different operating potential can offer multi-dimensional analysis and is analogous to the diode array detectors though at considerably less expense. Hence, two or more analytes eluting at same time can be resolved at the detection array as a consequence of their potential dependent responses at each electrode. Thus, in a recent example, a single chromatographic signal arising from a conventional uv-vis detector was subsequently shown to possess more than 300 discrete components when resolved using a four channel coulometric detector [2].

It has long been recognised that different electrode substrates (even when poised at identical operating potentials) can elicit significantly different responses from a given analyte. As a result, postcolumn electrochemical detectors have exploited a variety of electrode substrates (Pt, Au, Ag, C, Cu, Ni) and modified systems (alloys, organometallic catalysts, enzymes) to improve analytical performance[1, 3]. Carbon can be viewed as the most flexible of these substrates as a consequence of the variety of physical forms it

can take but each of these can come with a diverse range of chemical properties (or functionalities) that can allow detector enhancements through surface modification. In this respect, carbon is a significantly more flexible diagnostic tool.

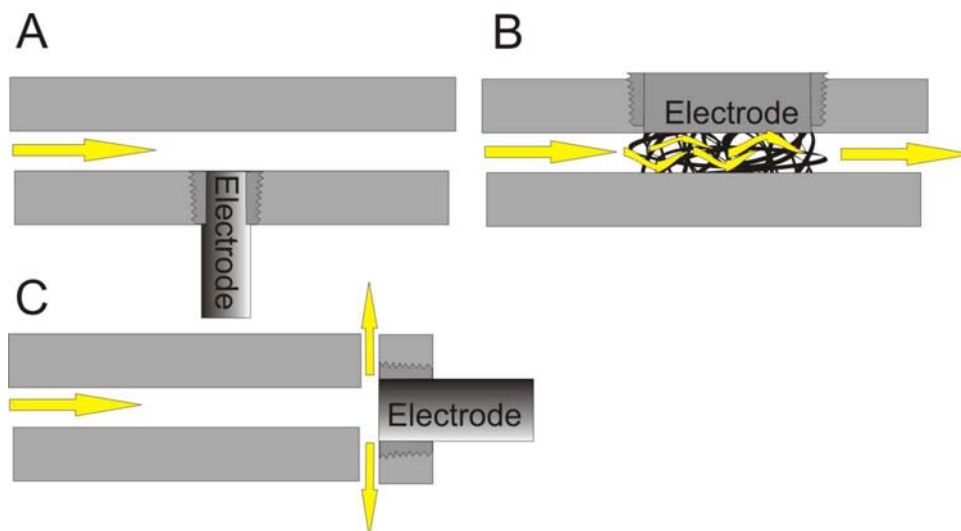

Figure 1-1: Common detector designs

1.3. Carbon: A Versatile Substrate

The multitude of physical forms that carbon can take allows for considerable flexibility in the design of the detector. Glassy carbon (GC), carbon fibre (CF), reticulated vitreous carbon (RVC) or graphite have all been used in a great number of analytical techniques [25]. Highly orientated pyrolytic graphite (HOPG) offering edge plane (eppg) and basal plane (bppg) morphologies are frequently used to explore the more fundamental side of electron transfer processes but can be of considerable value in LC-ED systems. The basal and edge plane possess different properties with the latter tending to exhibit considerably faster electrode kinetics and, as a consequence, possesses the potential for greater detection sensitivities [26-30]. It has been shown that the edge plane sites on carbon nanotubes (CNTs) are likely to be the major influence on the electrocatalytic effects observed at these modified electrode [26,30]. Glassy carbon is by

far the most common electrode material employed electroanalysis and is easily adapted for use in the detector designs outlined in **Figure 1-1**. Different studies reporting the use of carbon electrodes coupled with flow systems are presented in **Table 1-1** and highlight the diversity of application to which carbon can be utilised and provides an indication of the detection limits than can be achieved at the unmodified electrode surfaces.

Form	Analyte	Application	Detection Limits	Ref
GC	Rocuronium Impurities	Pharmaceutical	0.1-235 μ M	8
Carbon fiber microdisk (CFE)	Herb Acanthopax senticosus	Environmental	10-1.5 μ M	9
GC	Ag-ions	Biochemistry	20-67 μ M	10
eppg	Thiols	Bioanalytical	1.7-2.7 μ M	27
eppg	Sulfide	Analytical	4.9-10 μ ,M	28

Table 1-1: Different applications of carbon electrodes.

1.4. Surface Modification

The surface of carbon can be modified by mechanical [28-30], electrochemical [31-38], chemical [38-45] or thermal [46] means – the aim being to alter the interfacial reactivity of the base substrate and thereby improve the detector performance. In this review, surface modification is categorised in three levels, outlined in **Figure 1-2**. The first level is simply a modification of the species already present on the surface; on the second level - the modification implies the attachment of exogenous species onto the electrode surface and in the last level, the species are intercalated between the graphene layers of the base substrate. The latter can be induced through the electrochemical pre-treatment processes as a result of carbon fracturing [31, 36, 41]. The activation of the electrode is a term that is frequently used to describe a variety of superficial processes: the elimination of electrode's impurities, the creation of a fresh electrode surface, the increase of surface functional groups or an increase in electrode area. Mechanical activation such as polishing or sonication is widely used to clean the electrode and to expose fresh electrode area but can have the beneficial effect of increasing the availability

of edge sites [28,30] that can, as with eppg electrodes, serve to increase sensitivity. The most usual activation technique involves the electro-oxidation of the carbon surface by applying a fixed anodic or cyclic potential. The oxidation increases the proportion of oxygen species (**Figure 1-2A**) such as hydroxyl, carbonyl, carboxyl and quinones at the electrode surface [38]. These are well known to influence the wettability, surface reactivity, porosity and conductivity of the electrode [25,31,32,34].

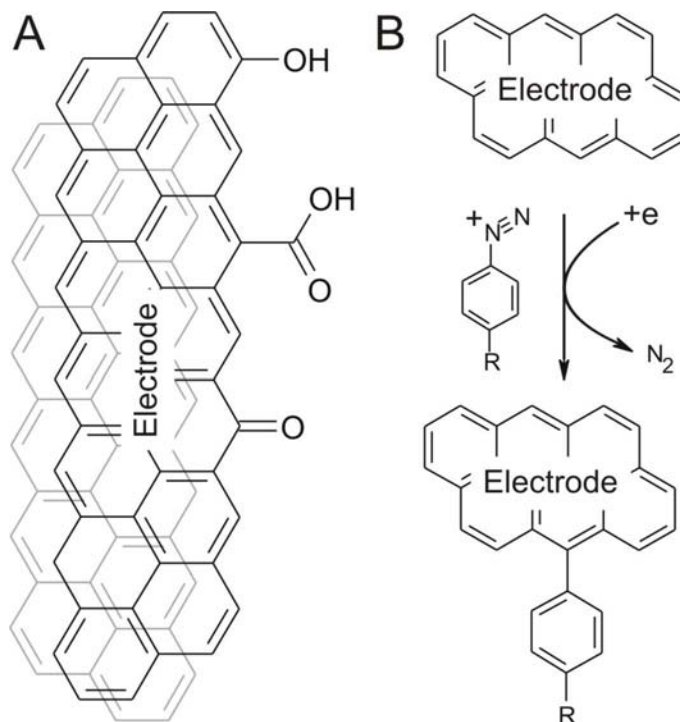

Figure 1-2: A) Carbon functionalities and B) Surface activation

Chemically modified electrodes (CME's) signify a more elaborate approach to surface modification and generally involve the deliberate attachment of new chemical components. This offers greater control over the electrochemical behaviour given the greater variety of functionality that can be introduced onto the surface – more so than that obtained by the activation of the intrinsic functionalities described previously. Three general approaches can be taken - formation of covalent bonds [42-45] irreversible adsorption [41]. Electrochemically induced functionalisation of surfaces by exogenous species can also be utilised and provides an effective alternative to purely chemical methods. A more recent strategy involves the reduction of diazo species (shown in

Figure 1-2B) whereby there is the direct covalent attachment of the target species [36,37,41, 43]. The most commonly adopted procedure however involves immobilisation of chemical species in a polymer film onto the carbon surface [50-91]. The latter will be considered in more detail in the next section. Irrespective of the procedure, the modifications can be used to good effect to influence hydrophilicity / hydrophobicity of the interface and thereby alter the adsorption characteristics of the matrix components – facilitating the accumulation of one species over another and thereby improving electroanalytical discrimination [25,30,31,32,34].

Form	Analyte	Pre-treatment / Modification	Application	Ref
GC	5-Hydroxyindoleacetyl 5-Hydroxytryptamine	Electrochemical oxidation H ₂ SO ₄ and Gold adsorption	Urine	13
GC	H ⁺	Electrochemical oxidation (NH ₄)	pH sensor	31
GC	Vitamins B ₂ , B ₆ , C	Electrochemical oxidation Phosphate Buffer salt (PBS)	Multi-vitamin tablets	32
Carbon Paste	Phenol	Electrochemical oxidation NaOH	Tap and waste water	33
GC	Mn	NH ₃ .NH ₄ Cl	Lake water	34
Carbon film	Glucose	Electrochemical oxidation PBS	Wines	35
GC	Uric Acid	Covalent bond -N ⁺ (CH ₃)	Uric Acid	36
Screen Printed	Organophosphate	Covalent bound (electrochemical reduction of 4-nitrobenzene) and enzyme attachment		37
GC	Erythromycin	Electrochemical oxidation NH ₃ -NH ₄	Tablets	41
GC	Guanine, Adenine	Covalent bond r-aminobenzene	Thiocoline	42
GC	Clozapine	Electrochemical oxidation PBS	Urine	43
Carbon Paste	Riboflavin	Covalent bound aza macrocycles	Pharmaceutical preparations and food.	45

Table 1-2: Electrode surface modifications

Alternatively, electrocatalytically active molecules or mediators bonded to the electrode surface can act as electron transfer bridges between the electrode and electroactive species in solution [55,60,70] and thereby modify the electrode properties of the base electrode. Some of the possible surface modifications and their application are detailed in **Table 1-2**.

1.5. Polymer Coatings

The use of polymers as a coating material has been used extensively to enhance the electrode performance and represents the most common approach to electrode modification[73]. The chemical and physical properties of the polymer will substantially influence the electrode response characteristics with the underlying carbon normally acting as a support material and the electrical conductor. In many cases, the form of carbon utilised will be determined more by availability and by detector design considerations. This is not to suggest that the inherent electrochemical properties of the base material can simply be ignored as it is still important to establish fast electrode kinetics [28,30] between the substrate and the electroactive material within the polymer. The dimensions (micro, macro, fibre), porosity, mechanical integrity and processing capability of the base substrate and the ease with which it can be incorporated within a flow cell will often be considerable factors in selecting the base substrate. The versatility of carbon in this respect contrasts the use of metal electrodes as the detecting substrate where the physical forms available are more restrictive. Glassy carbon, reticulated vitreous carbon [25] and pyrolytic graphite [30] are the most common electrodes in comparison to other carbon materials though polymer encapsulated carbon fibre systems have grown in popularity in recent years [50-53]. The latter can be rationalised in terms of the greater dimensional compatibility of the fibre systems within conventional LC architectures.

Numerous polymeric systems have been investigated and can be placed within several broad categories: non conducting [54-63], conducting [64-83] and redox gels [84-88]. While a large variety of systems have been examined – the most common and arguably the most successful tend to be those based on Nafion® [59,60], polyaniline

derivatives [64-74] and polypyrrole [51, 75-83]. The first falls across the preformed and non conducting categories of polymer modification and possess important anionic properties that can confer significant ion exchange properties to amperometric detectors. This is also true of the pyrrole and aniline systems but these possess the added advantage of being formed through electropolymerisation – and hence offer greater control over polymer morphology (thickness, permeability etc) but also the spatial localisation of the film. The latter is important given the increasing interest in miniaturised systems where the conventional solvent casting techniques common to Nafion® would not be appropriate. Some of the applications in which polymer modified carbon electrodes play a central role are detailed in **Table 1-3**.

The conducting polymers, especially those based upon pyrrole, can serve as an extremely flexible diagnostic tool offering a number of roles – electrocatalysis, molecular filter, enzyme entrapment etc [51, 81-83]. Polypyrrole can be over-oxidized resulting in a loss of conductivity and the expulsion of the dopant ions [81-83,69]. In such instances it has been shown to possess cation exchange (as opposed to the anion exchange when in the conductive state) and molecular filter properties. This has been shown to impart enhanced selectivity and sensitivity toward neurotransmitter analytes. They also confer the advantage of being able to detect those species that would not normally be electrochemically accessible. This relates to the exchange of the charged species within the cationic film (as counter ions) which alters the conductivity of the polymer backbone and thereby gives rise to the analytical signal [73].

Preformed redox gels represent the other main polymer grouping and almost invariably incorporate osmium complexes [84-88]. The gel serves to both entrap the enzyme at the electrode surface and relay electrons from the carbon surface to the redox centre within the protein.

Fig 1-3: Redox gel reaction scheme

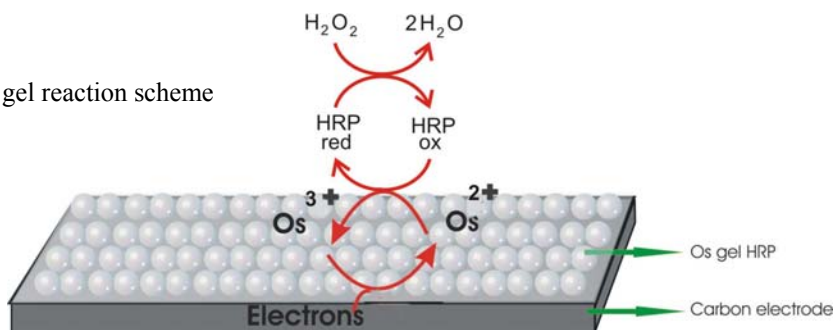

The basic mechanism is highlighted in **Figure 1-3** using an example of peroxide reduction in which an Osmium-gel-horseradish peroxidase (Os-gel-HRP) system is employed. Hydrogen peroxide is reduced enzymatically by the immobilised enzyme which in turn is converted to the oxidised form. It is re-activated by the transfer of electrons from the electrode but which are transported via the osmium shuttles ($\text{Os(III)} \leftrightarrow \text{Os(II)}$). The gels possess generic applicability allowing a host of enzyme systems to be used. The main drawback however is the fact that it requires the Os-gel to be cast onto the electrode surface [84-88]. A number of different polymer/mediator examples are highlighted in **Table 1-3**.

Polymer	Analyte	Modifier	Application	Ref
Melanin	Dopamine		N/A	55
L-Cysteine	Metal ions		N/A	56
Titania-sol-gel	Glucose	GOX/FcPF ₆	Serum Glucose	57
Eastman Kodak AQ55	X ⁻	Cyt C	Electrocatalysis studies	58
Nafion®	X ⁺	Fe ²⁺ , Fe ³⁺		59
Tosflex	X ⁻	Fe(CN) ₆ ⁴⁻ , Fe(CN) ₆ ³⁻		59
Nafion®	MPT	NiTSPc	Organophosphates	60
Methyl silicate		Antimony doped Tin oxide (ATO)	Transparent and conductive Electrodes	61
<i>o</i> -Aminophenol	NADH	NADH detection		65
<i>o</i> -Phenylenediamine	Paracetamol	Copolymer aniline	N/A	66
L-Arginine	Epinephrine and Dopamine		Human urine	71
Polyaniline	H ₃ O ⁺		pH measurements	72
Polyaniline		PB/Oxidase	Oxidase biosensors	73
Poly-Toludine Blue	NADH	NADH		73
Polyaniline	Choline	MWNTs		74
Polypyrrole	Nitrate	Nitrate, Parylene	Potentiometric <i>In situ</i> Nitrate biosensor	53
Polypyrrole	Ag ⁺	Sulfonated calixarenes	Ag ⁺	75
Pyrrrole-co-pyrrrole	Phenol	Amine and p-toluene sulphonated anions	Phenol	76
Polypyrrole	O ₂ ⁻	Anthraquinone(s)	Energy conversion systems	77
Polypyrrole	AA	FCN/Fe/Fe ₃ O ₄	AA in water samples	78
Pyrrrole	H ₂ O ₂	HRP/Fe(CN) ₆ ⁴⁻ , Fe(CN) ₆ ³⁻	Hydrogen Peroxide Biosensors	79
OPP	Catecholamines	Au nanoclusters	Human blood / serum	83
Os-gel-HRP	Histamine	HAO		84,85
Os-gel-HRP	Glucose, choline glutamate	GOX/ChOD / GlutaOD		86
Os-gel-HRP	Hypoxanthine	XOD		87
Os-gel-HRP	Glutamate	GluDH/NOX		88

Where; GOX= Glucose oxidase, Cyt C = Cytochrome C, MPT = Methyl-patanthion, NADH = Nicotinamide adenine dinucleotide, MWNTs = Multi walled nanotubes, HRP = Horseradish peroxidase, GluDH = Glutamate dehydrogenase, NOX = NADH oxidase, AA = Ascorbic acid, HAO = Histamine oxidase

Table 1-3: Applications of polymer modified electrodes.

1.6. Carbon Composite Electrodes

Composite electrodes typically consist of two or more components which together form the bulk of the base substrate. The composition of this group can be incredibly diverse depending on definition but, in general, the field can be sub-divided into carbon paste[89-109] and screen printed [110-118] systems. Despite the different formats and processing requirements – both share a common methodology in which carbon particles are bound together by a binder. The great strength of this approach is the fact that the composition - and hence properties - of the electrode can be easily manipulated by altering one or more of the components in the paste or ink or by the simple addition of a catalyst or other modifier during the initial mixing phase. Both systems have been used in LC applications and each approach can confer particular operational advantages.

Carbon paste electrodes typically rely upon carbon particles being held together by an impregnated organic liquid phase that is compacted into a holder and can then be used in much the same way as a conventional solid electrode and likewise can be incorporated within flow systems in much the same way as a commercial glassy carbon or HOPG electrode [89-98]. Their application within such is however less common – as indicated in **Table 1-4**. This is rather surprising as - irrespective of the particular form of carbon used – the paste electrodes can be rapidly constructed with little expense beyond the initial cost of the components. As such, they can facilitate a prototyping function that allows the *ad hoc* production of modified electrodes. Operationally, the paste electrodes can have the advantage of providing a low background compared to solid graphite and noble metal electrodes. They are also renewable in that, upon fouling, the surface can be regenerated by polishing [89,93]. There is clearly the potential for a huge number of variations in the preparation – the form of carbon used, the nature of the binder and presence of modifiers [125-127] or catalysts. The binder can take several forms and can include: mineral oil (nujol) [89-98], wax or epoxy [98], polymer [67] or ionic liquid [99].

Binder	Analyte	Modification	Applications	Ref
Nujol	Tryptophan	MWCNT/cobalt salophen	Human serum	89
Mineral oil	Cadmium	1-Furoylthioureas	Cadmium determination	90
Paraffin oil	Sugars and AA	Polyethylene glycol and Cu ₂ O	Biological samples	93*
Olive oil	Phenols	NA	Extra virgin olive oils	94
Paraffin	Phenol	Montmorillonite	Tap water	95
Paraffin oil	Anion	Ferrocene functionalized Calyx[4]pyrrole	Water	96
Wax	Hydrazine	Manganese hexacyanoferrate	Photographic developer	98*

Table 1-4: Carbon composite electrodes and their applications

* coupled with flow systems

Carbon nanotubes (CNT's) have risen to considerable prominence in recent years and have been widely investigated (**Table 1-5**) as an electrode modifier or as a direct replacement for the more traditional graphitic powder [100-109]. The duality of construction emphasizes the versatility of the material. The nanotubes can generally be found in two forms: single wall (SWCNT) or multi-walled (MWCNT) and, by analogy to graphite, the walls of the nanotube can be defined as basal plane while the ends are considered to be edge plane. It has been demonstrated that the edge plane effects, often in combination with increased oxygen functionalities, are largely responsible for the enhanced the electrode kinetics [28,30].

Analyte	Modification	Applications	Ref
Nitrite,AA, Uric acid	Polypyrrole	N/A	72
Homocysteine	Nafion®, CNT	N/A	103
Sugars	Nafion/CNT	Carbohydrate detection	104
Chlorate,Iodate Bromate	MWCNT/iron (III)-porphyrin	Chlorate,iodate,bromate	105
Estradiol	Nafion® / Ni (Cyclam)	Serum	106
Glucose	PtPbNP	Blood	107
H ₂ O ₂	Nafion® /Au/GOD	Beverages	108
NH ₃	SiO ₂ /Si/Li	N/A	109*

Table 1-5: Carbon nanotubes electrodes and their applications

* coupled with flow systems

Reviews covering the breadth of nanotube application and the fundamentals that underpin their action are widely available. In common with the paste systems they have the notable benefit of decreasing the capacitive background which increases the sensitivity of the electrode [103]. As in the case of the carbon paste systems, the exploitation of nanotubes within flow systems is more limited despite the considerable advantages they can potentially confer. This is likely to be a consequence of the field being relatively young and it could be expected that more electrode designs incorporating nanotubes will emerge in the future.

Screen printed electrodes are generally inexpensive to fabricate when considering large scale processing in which the costs of individual electrodes can be expected to fall dramatically. Access to such facilities and the large volumes of the reagents required can however be prohibitive – especially when considering the incorporation of expensive biological reagents (cf carbon paste systems). Mass manufacture does however open an avenue to the production of disposable electrodes that can overcome the fouling and surface deactivation effects that repeated analysis can bring. The batch production of near identical sensors can therefore minimise the reproducibility problems associated with the regeneration of conventional electrochemical detectors [110-118]. Some of the applications are detailed in **Table 1-6**

Analyte	Modification	Applications	Ref
Thiocholine	Acetylcholinesterase	Organophosphates	111
Organophosphates	Tyrosinase	River water	112
Nitric oxide	None / Direct oxidation	Biological samples	110
H ₂ O	Glucose Oxidase	Glucose	107
Glucose	Osmium complex	N/A	114
Ascorbic acid	Fe(CN) ₆ ⁴⁻ , Fe(CN) ₆ ³⁻	N/A	115
Immunoglobulin G	Antigen/antibody	Immunoenzyme	116
Sulphide	Cinder/hexacyano cobaltate	N/A	117
H ₂ O ₂	Copper	N/A	118

Table 1-6: Screen-printed electrodes and their applications

The SPE's can be integrated into conventional flow systems – operating under planar or the wall jet schemes outlined in **Figure 1-1**. The latter is highlighted in the analysis of hydrogen peroxide on a copper modified screen printed carbon electrode [118]. The radial flow of the analyte across the wall of the electrode minimizes the diffusion layer which amplifies the signal and can give a significant advantage over the planar arrangement.

1.7. Diamond Electrodes

The increasing availability of diamond electrodes hold much promise for electroanalytical applications as they can offer substantial advantages over conventional glassy carbon or HOPG systems[119-123]. They generally possess a much wider electrochemical window in aqueous and non aqueous media. It has also been shown that polar molecules adsorb less at the surface and, as such, the electrode operating lifetime can be significantly greater than that achievable with conventional carbon surfaces. It has been shown that the repeated oxidation of catechol can be achieved without the cumulative loss in sensitivity that occurs in biological matrices [119]. Boron doped

diamond also demonstrates a marked insensitivity to dissolved oxygen and thereby provides a significant improvement over glassy carbon or HOPG when considering cathodic operations [120]. A range of applications in which the performance of boron doped diamond electrodes have been investigated are compared and contrasted in **Table 1-7**.

Analyte	Ref
Azide ions	119
Dopamine (in presence of AA)	119
Histamine and Sulfa drugs	120
Polyamines	120
Chlorophenols and theophylline	122

Table 1-7: Applications of diamond electrodes

1.8. Conclusions

It is clear that carbon possesses unrivalled flexibility in its ability to be modified and effectively tailored to specific applications and stands in contrast to the more limited options available when considering metallic electrodes. These features have been long recognised for general electroanalytical investigations but are now increasingly finding application as detectors in flow systems. While bare carbon substrates were once the default option in electrochemical detection, the modified systems are capable of significantly enhancing performance. This has been demonstrated by the use of diamond and nanotube composite electrodes which extend the range of accessible analytes and the response sensitivity. The requirement for miniaturised systems has seen the introduction of carbon within micro-analytical systems and lab-on-a-chip prototypes [87,98,135, 97].

The use of micro-arrays is a future addition in which the main gain is the possibility of multi-parametric detection within a single sample [124-129]. Redox cycling has yet to be widely adopted but again could offer significant gains in detector performance [126,129]. Issues over fouling and the consequent compromises that occur in terms of reproducibility could be countered through the adoption of screen printed detectors [97, 124]. It could be envisaged that these could be integrated within

conventional LC architectures but, more importantly, their inherent disposability could herald an opportunity for the fabrication of standalone miniaturised chip/sensor based systems. These could eventually induce the transfer of the more traditional lab based LC to decentralised testing environments. A diverse range of applications is apparent from the various tables and it can be seen that carbon, as the core sensing detection element, can have a significant impact on a highly varied range of chemicals that cross the agri-food, biomedical, environmental and industrial sectors. It is with this expectation that the project and the work detailed in subsequent chapters has focused on the use of this versatile material. The incorporation of carbon as central conductive component within composite material has not received much attention but the ease with which it can be adapted for use in a variety of sensing applications clearly warrants further investigation.

1.9. Project Aims and Objectives

The aims of the present project were to investigate the design and development of carbon composite materials as the basis of sensing substrates capable of integration within flow analysis systems. The objectives were:

- implement and optimise flow injection and liquid chromatographic protocols for the analysis of analytes of biomedical and environmental significance;
- explore the integration of electrochemical detection or inline or postcolumn detection processes;
- design and develop the fabrication processes for the production of conductive composite electrodes and their further modification with catalytic materials;
- characterise the electrodes and evaluate their performance within various electroanalytical contexts;
- investigate the integration of the electrodes within flow systems and critically appraise their applicability and performance with respect to conventional analytical methodologies and
- explore the possible transfer of the technology to discrete, disposable sensing formats.

1.10. References

1. Erickson BE, (2000), *Anal. Chem.* 72: 353A-357A,
2. Acworth IN, Gamache PH, (1997) *American Laboratory*, 29: 15 -20
3. Baldwin RP, (1999) *J. Pharmaceut. Biomed. Anal.*, 19: 69
4. Lau. YY, Hanson GD, Ichpurani N, (1996) *J. Chromatography. B.* 683:209-216.
5. Ranta VP, Hämäläinen KM, Aureola S, Urti A, (1998) *J. Chromatography B* 709: 1-10.
6. Peñalver A, Pocurrull E, Borrull F, Marçé RM, (2002) *J. Chromatography A* 964:153-160.
7. Papa-Louis A, Pascalidou S, (1998). *Analytical Biochemistry* 263:176-182
8. Delgado-Zamarreño MM, Bustamante-Rangel M, García-Jiménez M, Sánchez-Pérez A, Carabias-Martínez R, (2006). *Talanta* 70: 1094-1099
9. Blazewicz A, Fijalek Z, Warowana-Grésiewicz M, Boruta M, (2007) *J Chromatography A* 1149:66-72.
10. Zhou X, Zheng C, Huang J, You T, (2007) *Analytical Sciences* 23:705-711.
11. Mikelova R, Baloun J, Petrova J, Adam V, Havel L, Petrek J, Horna A, Kizek R, (2007) *Bioelectrochemistry* 70:508-518.
12. Narita M, Maurakami K, Kauffmann JM (2007) *Analytica Chimica Acta*, 588:316-320.
13. Xu H, Zhang W, Wang D, Zhu W, Jin L (2007) *J. Chromatography B* 846:14-49.
14. Rancan M, Rossi S, Sabatini AG. (2006) *J. Chromatography A* 1123: 60-65.
15. D'Avloio A, Sciandra M, de Requena DG, Ibanez A, Bonora S, Di Perri G (2006). *Therapeutic Drug Monitoring* 28:110-115.
16. Pérez I, Montes S, Boll MC, Ramírez J, Ríos C (2004) *J. Chromatography B* 806:133-139.
17. Zhang GF, Maudens KE, Storozhenko S, Mortier KA, Van der Straeten D, Lambert WE, (2003) *J. Agriculture and Food Chemistry* 21:7872-7878.
18. Ndaw S, Bergaentzle M, Aoude-Werner D (2003) *J. Chromatography A* 928:77-99.
19. Takeuchi T, Aspanut Z, Imui TA, Lim LW, (2007) *J. Chromatography A* 1147:42-45.
20. Lee MS, Hook DJ, Kerns EH, Volk JK, Rosenberg IE (1993). *Biological Mass Spectrometry* 22:84-88.
21. Yap BK, Johnston GAR, Kazlauskas R (1992). *J. Chromatography* 573:183-190.
22. Engel E, Ratel J (2007) *J. Chromatography A* 1154 :331-341.
23. Murugaiyah V, Chan KL (2007) *J Chromatography B* 852: 138-144.
24. Wang Y, Al-Gazzar A., Seibert C, Sharif A, Lane C, Griffiths W J (2006). *Biochemical Society Transactions* 34:1246-1251
25. Friedrich JM, Ponce-de-León C, Reade GW, Walsh FC. (2004) *J. Electroanal. Chem.* 561:203-217
26. Banks CE, Compton RG (2006) *Analyst*, 131:15-21.
27. Krizkova S, Beklova M, Pikula J, Adam V, Horna A, Kizek R (2007). *Sensors* 7:1271-1286.
28. Moore RR, Banks CE, Compton RG, (2004). *Analyst* 129:755-758.
29. Lawrence J, Robinson KL, Lawrence NS (2007) *Analytical Sciences* 23:673-676.

-
30. Banks CE, Compton RG (2005) *Analytical Sciences* 21:1263-1268.
 31. Paixao TRLC, Kosminsky L, Bertotti M, (2002) *Sensors and Actuators B* 87:41-46.
 32. Gu HY, Yu AM, Chen HY, (2001). *Analytical Letters* 34 (13):2361-1374.
 33. Liu S, Miller B, Chen A (2005). *Electrochemistry Communications* 7:1232-1236.
 34. Di J, Zhang F (2003) *Talanta* 60:31-36
 35. Florescu M, Brett CMA (2005) *Talanta* 65:306-312
 36. Farhadi K, Karimpour A, (2007) *Analytical Sciences* 23:479-483.
 37. Wang HS, Ju HX, Chen HY (2002) *Analytica Chimica Acta* 46:243-250.
 38. Tao Y, Lin ZJ, Chen XM, Chen XI, Wang XR, (2007) *Analytica Chimica Acta* 594:169-174.
 39. Thorogood CA, Wildgoose GG, Crossley A, Jacobs RMJ, Jones JH, Compton RG (2007) *Chemistry of Materials* 19: 4964-49741
 40. Chen S, Yuan R, Chai Y, Zhang L, Wang N, Li X. (2006) *Biosensors and Bioelectronics* 22:1268-1274.
 41. Wang H, Zhang A, Cui H, Liu D, Liu R (2000) *Microchemical Journal* 64:67-71.
 42. Li X, Wan Y, Sun C (2004) *J. Electroanal. Chem.* 569:79-87.
 43. Lin XQ, Jin GP (2005) *Electrochimica Acta* 50:3210-3216.
 44. Vakurov A, Simpson CE, Daly CL, Gibson TD, Millner PA (2004) *Biosensors and Bioelectronics* 20:1118-1125.
 45. Kotkar RM, Desai PB, Srivastava AK (2007). *Sensors and Actuators B* 124:90-89.
 46. Morita K, Shimizu Y (1989). *Anal. Chem*, 61: 159-162
 47. Tokuda K, Morita K, Shimizu Y, (1989) *Anal. Chem* 61:1763-1768.
 48. Dayton MA, Brown JC, Stutts KJ, Wightman RM, (1980) *Anal Chem* 52:946-950.
 49. Shimizu Y, Morita K (1990) *Anal Chem* 62:1498-1501
 50. Kang HM, Yoom TH, Bump M, Riffle JS (2001) *J Appl. Polym. Sci* 79:1042-1053.
 51. Chiu HT Lin JS (1992). *J. Mater. Sci* 27:319-327
 52. Dilsiz N, Ebert E, . Weisweiler W, Akovali G (1995) *J. Colloid Interface. Sci* 179:241-248.
 53. Bendikov TA, Miserendino S, Tai YC, Harmon TC(2007). *Sensors and Actuators B* 123:127-134.
 54. Wei. M, Sun. DM (2007) *Chinese Journal of Analytical Chemistry*, 35: 66-70.
 55. Rubianes MD, Rivas GA(2003) *Analytical Letters* 36:329-345.
 56. Fu P, Zhao Y, An X, Dong Y, Hou X, (2007) *Electrochimica Acta* 52:5281-52-85.
 57. Yu J, Liu S, Ju H (2003) *Biosensors and Bioelectronics* 19:401-109C
 58. Ugo P, Zangrando V, Moretto LM, Brunetti B (2002) *Biosensors and Bioelectronics* 17:479-487.
 59. Ugo P, Moretto LM, De Boni A, Scopece P, Mazzocchin GA, (2002) *Analytica Chimica Acta* 474:147-160.
 60. Sbaï M, Essis-Tome H, Gombert U, Breton T, Pontié M (2007). *Sensors and Actuators B* 124:368-375.

-
61. Sadeh A, Sladkevich S, Gelman F, Prikhodchenco P, Baumberg I, Berezin O, Lev.O (2007). *Anal. Chem* 79:5188-5195.
 62. Bismarck A, Lee AF, Saraç AS, Schulz E, Wilson K, (2005). *Composites Science and Technology* 65:1564-1573.
 63. Wildgoose GG, Leventis HC, Davies IJ, Crossley A, Lawrence NS, Jiang L, Jones TGJ, Compton (2005) *J. Mater. Chem* 15:2375-2382.
 64. Kim TH, Park SM, (2005) *Electrochimica Acta* 50:1461-1467.
 65. Nassef HM, Radi AE, O'Sullivan CK (2006) *Electrochemistry Communications* 8:1719-1725.
 66. Gómez-Caballero A, Goicolea MA, Barrio RJ (2005) *Analyst* 130:1012-1018.
 67. Zou Y, Sun LX, Xu F, (2007). *Biosensors and Bioelectronics* 22:2669-2674.
 68. Wang Z, Zhu ZZ, Li HL (2007). *Acta Chimica Sinica* 65 (12):1149-1154.
 69. Luo X, Killard AJ, Smyth MR (2007) *Chem. Eur. J* 13:2138-2143.
 70. Chen Y, Yuan J, Tian C, Wang X (2004) *Analytical Sciences* 20:507-511.
 71. Zhang L. (2007) *Electrochimica Acta* 52:6969-6975.
 72. Tanase I, Nidelea M, Buleandre W (2003). *Revista de Chimie*, 54: 202-207.
 73. Nagels LJ, Staes, E (2001) *Trends in Analytical Chemistry*, 20:178-185
 74. Qu F, Yang M, Jiang J, Shen G, Yu R, (2005) *Analytical Biochemistry* 344:108-114.
 75. Mousavi Z, Bobacka J, Ivaska A, (2005) *Electroanalysis* 17:1609-1615.
 76. Takashima W, Kaneto K (2004) *Sensors and Actuators B* 102:271-277
 77. Zhang G, Yang F (2007) *Electrochimica Acta* 52:6595-6603.
 78. Malinauskas A, Kuzmarskyte J, Meškys R, Ramanavičius A (2004) *Sensors and Actuators B* 100:387-394.
 79. Li G, Wang Y, Xu H (2007). *Sensors*, 7:239-250.
 80. Heung Y, Bange A, Heineman WR, Halsall HB, Shanov VN, Dong Z, Pixley S, Behbehani M, Jazieh A, Tu Y, Wong DKY, Bhattacharya A, Schulz MJ (2007) *Sensors and Actuators B* 123:177-182.
 81. Li Y, Wang P, Wang L, Lin X (2007) *Biosensors and Bioelectronics*, 22:3120-3125.
 82. Hamdi N, Wang J, Monbouquette HG (2005) *J. Electroanal. Chem.* 58:258-264.
 83. Li J, Lin X. *Sensors and Actuators B* 142:486-493.
 84. Malinauskas A, Kuzmarskytė J, Meškys R, Ramanavičius A, (2004) *Sensors and Actuators B* 100:387-394.
 85. Anne A, Blanc B, Moiroux J, Savéant JM, Langmuir (2007) *Encyclopedia of Electrochemistry*. Vol 10, Chap 13.
 86. Shi GY, Yamamoto K, Zhou TS, Xu F, Kato T, Jin JY, Jin LT (2003) *Electrophoresis* 24:3266-3272.
 87. Mao L, Yamamoto K (2000). *Analytica Chimica Acta* 415:143-150.

88. Liu Z, Niwa O, Horiuchi T, Kurita R, Torimitsu K, (1998) *Biosensors and Bioelectronics* 14:631-638.
89. Shahrokhian S, Fotouhi L (2007) *Sensors and Actuators B*, 123:942-949.
90. Estévez-Hernández O, Naranjo-Rodríguez I, Hidalgo de Cisneros JL, Reguera E (2006) *Sensors and Actuators B* 123: 488-494.
91. Cai XH, Ogorevc B, Tavcar G, Kalcher K (1995) *Electroanalysis* 7:639-643.
92. Ghiaci M, Rezaei B, Kalbasi RJ (2007) *Talanta* 73:37-45
93. Dong S, Zhang S, Cheng X, He P, Wang Q, Fang Y (2007) *J. Chromatography A* 1161:327-3333
94. Apetrei C, Gutierrez F, Podrígez-MéJ ML. de Saja A, (2007) *Sensors and Actuators B* 121:567-575.
95. Wang H, Zhang A, Cui H, Liu D, Liu R (1998) *Microchemical Journal* 59:448-456.
96. Szymańska I, Radecka H, Radecki J, Gale PA, Warriner CN (2006) *J. Electroanal. Chem.* 591:223-228.
97. Pividori MI, Alegret S (2005) *Analytical Letters* 38:2541-2565.
98. Jayasri D, Narayanam SS, (2006) *Journal of Hazardous Materials* 144:248-354.
99. Zhang Y, Zheng JB (2007) *Electrochimica Acta* 52:7210-7216.
100. Thorogood CA, Wildgoose GG, Jones JH, Compton RG (2007) *New J. Chem.* 31:958-965.
101. Moghaddam AB, Ganjali MR, Dinarvand R, Norouzi P, Saboury AA, Moosavi-Movahedi AA, (2007) *Biophysical Chemistry* 128:30-37.
102. Chakraborty S, Raj CR (2007) *Electrochemistry Communications* 9:1323-1330.
103. Gong K, Dong Y, Xiong S, Chen Y, Mao L, (2007) *Biosensors and Bioelectronics* 20:253-259.
104. Deo RP, Wang J (2004) *Electrochemistry Communications* 6:284-287.
105. Salimi A, MamKhezri H, Hallaj R, Zandi S (2007) *Electrochimica Acta* 52:6097-6105.
106. Liu X, Wong DKY (2007) *Analytica Chimica Acta* 549:184-191.
107. Hart JP, Crew A, Crouch E, Honeychurch KC, Pemberton RM, (2004) *Analytical Letters* 37:789-830.
108. Manso J, Mena ML, Yáñez-Sedeño P, Pigarrón J (2007) *J. Electroanalytical Chemistry* 603:1-7.
109. Nguyen LH, Phi TV, Phan PQ, Vu HN, Nguyen-Duc C, Fossard F (2007) *Physica E* 37:54-57.
110. Miserere S, Lerdru S, Ruillé N, Griveau S, Boujtita M, Bedioui F (2006) *Electrochemistry Communications* 8:238-234.
111. Vakurov A, Simpson CE, Daly CI, Gibson TD, Millner PA (2004) *Biosensors and Bioelectronics* 20:118-1125.
112. Tanimoto de Albuquerque TD, Ferreira LF, (2007) *Analytica Chimica Acta* 596:210-221.
113. Li G, Liao JM, Hu GQ, Ma NZ, Wu PJ, (2005) *Biosensors and Bioelectronics* 20:2140-2144.
114. Zhang C, Gao Q, Aizawa M (2001). *Anal. Chim. Acta* 426 (2001) 33-41.
115. Zen JM, Tsai DM, Kumar AS (2003) *Electroanalysis* 15:1171-1176.
116. Gao Q, Ma Y, Cheng ZL, Wang WD, Yang MR (2003) *Anal. Chim. Acta* 488:61-70

-
117. Zen JM, Chen PM, Kumar AS (2002) *Electroanalysis*, 14:513-518.
 118. Zen JM, Chung HH, Kumar AS (2000) *Analyst* 25:1633-1637.
 119. Granger MC, Xu J, Strojek JW, Swain GM, (1999) *Analytical Chimica Acta* 397:145-161.
 120. Rao TN, Fujishima A (2000) *Diamond and Related Materials* 9:384-389.
 121. Witek MA, Swain GM (2001) *Analytica Chimica Acta*, 440:119-129.
 122. Fujishima A, Rao TN (2001) *Diamond and Related Materials*, 10: 1799-1803.
 123. Compton RG, Foord JS, Marken F (2003) *Electroanalysis* 15: 1349-1363
 124. Kovarik ML, Torrence NJ, Spence DM, Martin S (2004) *Analyst* 129:400-405.
 125. Palchetti I, Mascini M (20005) *Current Chemistry* 261 27-43.
 126. Hoogvliet JC, Reijn JM, Vanbennekom WP, (1991). *Anal. Chem.* 63:2418-2423.
 127. Paz, MA Martin P, Flückiger R, Mah J, Gallop PM (1996) *Analytical Biochemistry* 238:145-149.
 128. Okuno J, Maehashi K, Matsumoto K, Kerman K, Takamura Y, Tamiya E (2007) *Electrochemistry Communications* 9:13-18.
 129. Vanderveer WR, Woodward DJ, Fritsch I (2003) *Electrochimica Acta* 48:3341-3348.

Chapter 2

Experimental Details and Core Methodologies

Abstract

An overview of the major analytical techniques used during the project is presented. The main emphasis of the work has focused on the use of chromatographic and electrochemical methodologies and for this reason this chapter is focused mainly on those. Supplementary methods that enabled the more rounded characterisation of the electrode systems are also discussed

2.1. Introduction to Chromatography

Chromatography is a general term for a group of techniques used to separate and / or analyze a complex matrix. The separation process is based on the injection of the sample matrix into a mobile phase (gas or liquid) that will pass through a stationary phase (solid or liquid) which stays inside the column where the compounds will be separated. Chromatography was developed by the Russian botanist Mikhail Semyonovich Tsvet in 1901 when he produced a colourful separation of different plant pigments with a column of calcium carbonate. Since then chromatography has developed into a useful laboratory tool for the separation of compositionally complex samples and, as alluded to in Chapter 1, is undoubtedly the most powerful and indeed common analytical technique used for routine quantification of multiple analytes within a single analytical procedure.

2.2. Classification of Chromatographic Methods

There are two main classifications. The first is based on the way that the stationary and mobile phases interact. In column chromatography, a thin tube contains the stationary phase through which the mobile phase flows - usually aided by the application of pressure from a suitable pump. The second and more fundamental classification is based on the interactions of the solute between the stationary and mobile phase.

Adsorption Chromatography or Liquid-solid Adsorption Chromatography (LSC):

In this instance, the stationary phase is a solid and the mobile phase is either liquid or gas. The analytes are adsorbed onto the surface of the stationary phase with those exhibiting stronger attraction to the stationary phase travelling slower through the column.

Partition Chromatography (LLC): The stationary phase is a liquid adsorbed into a solid; the liquid is physically retained by a solid support. The analyte will equilibrate between the liquid of the stationary phase and the mobile phase.

Molecular Exclusion Chromatography (LEC): The stationary phase is a polymeric solid with controlled porous size. The separation is due to ability of the analyte to fit within the pore size of the polymer phase. It is the only form of chromatography where the mobile phase does not influence the separation and is simply a way to transport the analyte through the stationary phase. Small molecules will be retained within the porous framework and will spend more time on the stationary phase than larger molecules.

Affinity Chromatography (AC): This is the most selective chromatography in which the stationary phase is an immobilized molecule with very specific characteristics which will interact with a very explicit analyte.

Ion-exchange Chromatography (IEC): In this case, the stationary phase is a charged resin. Analytes possessing the opposite charge to the groups immobilised on the stationary phase will be attracted to the latter by electrostatic forces. The mobile phase is always a liquid.

2.3. Principles and Theory

The time that the analyte spends in the column is called the Retention Time (t_R), and it depends on the interactions of the analyte with each phase: mobile and stationary. The interactions of the analyte with each depend on a combination of: ionic interactions, hydrogen bonds and van der Waals' interactions. The separation is represented in a graphic form called a chromatogram; ideally, each peak within the chromatogram represents one analyte. For specific conditions, the retention time will be characteristic of a precise analyte which can therefore allow the subsequent identification of the analyte within a real sample. A good separation is qualitatively represented by a chromatogram with narrow and symmetrical peaks.

2.3.1. The Chromatogram

Solutes eluted from a chromatographic column are typically analysed with detectors typically employing electrochemical or, more commonly, spectrometric methodologies. As mentioned previously, a chromatogram is a graphic representation of the separation, showing the response of the detector as a function of time. Under ideal conditions, the height and area of the chromatographic peak are proportional to the concentration of a particular analyte, and in specific conditions the retention time is exclusive for that specific analyte. These characteristics make the chromatographic techniques a tool not only for the quantification of analytes but also for their identification. **Figure 2-1** shows a chromatogram of the reaction between naphthoquinone and glutathione.

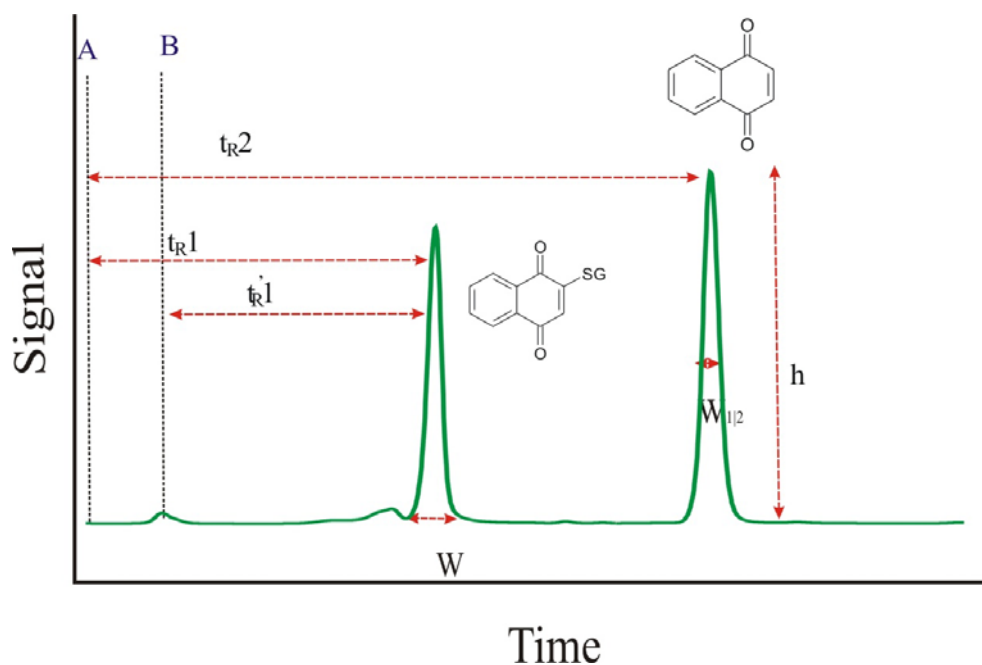

Fig 2-1: Chromatogram of the reaction between naphthoquinone and glutathione. A: Injection, B: beginning of the interaction of the analytes with the column, h: height, W: peak wide, $W_{1/2}$; peak wide at middle of the height, t_R ; retention time, t_R' ; adjusted retention time.

2.3.2. Retention Parameters

The Retention Time (t_R) is the time that an analyte spends in the column since it was originally injected, and the Adjusted Retention Time (t_R') is the time that an analyte spends in the column itself and (t_M) is the time taken for the mobile phase to pass through the column. The Capacity Factor (K') measures the time that an analyte spends within the column compared with the time that the analyte spends in the mobile phase and is defined as:

$$K' = \frac{t_R - t_M}{t_M}$$

The longer an analyte is retained by the column, the bigger will be the capacity factor. The Selectivity Factor (α) indicates the separation between two peaks in a chromatograph but does not indicate the shape of the peak. The Selectivity Factor is defined as:

$$\alpha = \frac{K'_B}{K'_A} = \frac{t_{RB}}{t_{RA}} > 1$$

Given that the Selectivity Factor does not give information about the shape of the peak, it is important to bear in mind other parameters such as resolution or efficiency.

2.3.3. Efficiency of Separation

Two main factors have an effect on the separation efficiency; one is the difference in elution time between peaks. The further apart the peaks are - the better is the separation. The other parameter is the width of the peak. The wider the peak, the poorer is the separation. Decreases in the peak height decrease the sensitivity and the increase in the peak width increases the risk of overlapping. Two theories are used to measure the efficiency of the separation and are discussed in turn:

Plate Theory: This is based on thermodynamic laws. In a chromatographic column, a plate is equal to the distribution of equilibrium in each stage where the equilibrium between the analyte and the stationary phase takes place. Two parameters can be quantitatively used to determine the efficiency of the column and therefore for the chromatographic separation. The first parameter is the plate height and the second is the number of plates. Both factors are related in the following equation

$$H = L/N$$
$$N = 16 \left(\frac{t_R}{W} \right)^2$$

Where H is plate height, L is total column length, W is the peak width and N is the number of plates. The greater the number of equilibrium stages – the greater the efficiency and this implies a high number of plates of low height. Plate Theory explains the Gaussian shape of the chromatographic peaks, and the velocity of the displacement of the peaks through the column, however this theory has some disadvantages in that it fails to explain the widening of the peaks. The theory was later modified to give the rate theory which is considered to be a more complete and robust theory.

Rate Theory: This approach is based on the movement of the analytes in a determined velocity which can be controlled by controlling some experimental parameters such as the mobile phase or the nature of the stationary phase and it is defined by the equation of Van Deemter:

$$H = A + B/u + C_s u + C_m u$$

The diffusion of the solute A depends of the homogeneity of the flux and the difference in the length of the paths that the analyte has to run through the column. The analytes can travel through different paths due to the fact that the particles of the stationary phase are never identical, and therefore the chromatographic peaks will have

some width. However this factor can be reduced by reducing the particle diameter (which will result in an increase of the column back pressure) and by narrowing the size distribution.

The longitudinal diffusion B follows from the diffusion of the solute in the mobile phase (u) and from the time that the solute spends in the column. The mass transfer in the stationary phase (C_s) depends on the thickness of the mobile phase - if the thickness increases - the solute has to make more effort to interact with the interface and allow equilibrium to take place. It is inversely proportional to the diffusion coefficient of the analyte in the mobile phase. The mass transfer in the mobile phase (C_m) is proportional to the particle diameter of the particles in the column and to the diameter of the column and it is inversely proportional to the diffusion coefficient of the analyte to the mobile phase.

Plate height (H) will therefore be at a minimum when the diameter of the particles of the stationary phase, the diameter of the column and the thickness of the mobile phase are low and in the case of gas chromatography - when the temperature of the mobile phase is high.

2.3.4. Resolution

Resolution (R) refers to the separation between two following peaks. The separation of two wide peaks can be the same as the separation between two narrow peaks but the resolution will be different. This is highlighted in **Figure 2-2** where the green chromatogram illustrates the case where the peaks will have bad resolution and in the second case (red chromatogram) where the peaks exhibit good resolution.

$$R = \frac{t_{R,B} - t_{R,A}}{(W_A + W_B) / 2}$$

R = 1.5 good separation

R = 1.0 overload of 4%

R = 0.75 bad separation.

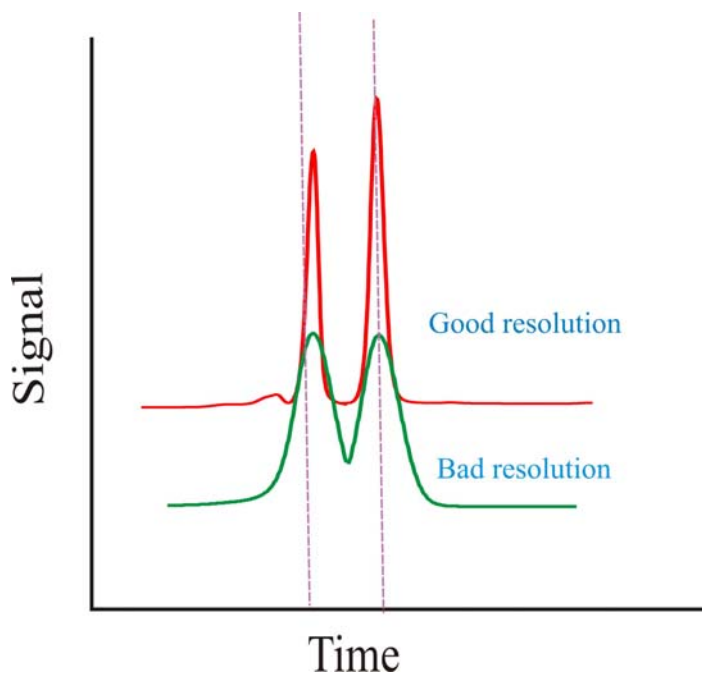

Fig 2-2: Chromatograms showing the difference in resolution between two sequentially eluting peaks

2.4. High Performance Liquid Chromatography

High performance liquid chromatography (HPLC) is a highly efficient form of chromatography that appeared in the mid 1960s, and is based on the use of small particles within a column with the mobile phase transported through under high pressure **Figure 2-3**. The use of the latter increases the velocity of the components which mean they will have less time to interact with the stationary phase leading to improved resolution of the chromatogram. Over the years, different improvements have been introduced due to the increasing demand for information on chemical concentrations in almost every facet of modern life covering a multitude of biomedical, environmental and industrial applications. The efficiency of the separation has been improved with modifications on the particle size of the chromatographic column. In the past decade, the size of the particles were typically between 30-50 μm whereas recent years has seen the introduction of particles with a diameter range between 3-5 μm . Another substantial advantage is the

diversity of detectors that can be coupled to the chromatographic columns and can include: uv/vis[1], fluorescence[2], electrochemical[3], or mass spectroscopy detectors[4].

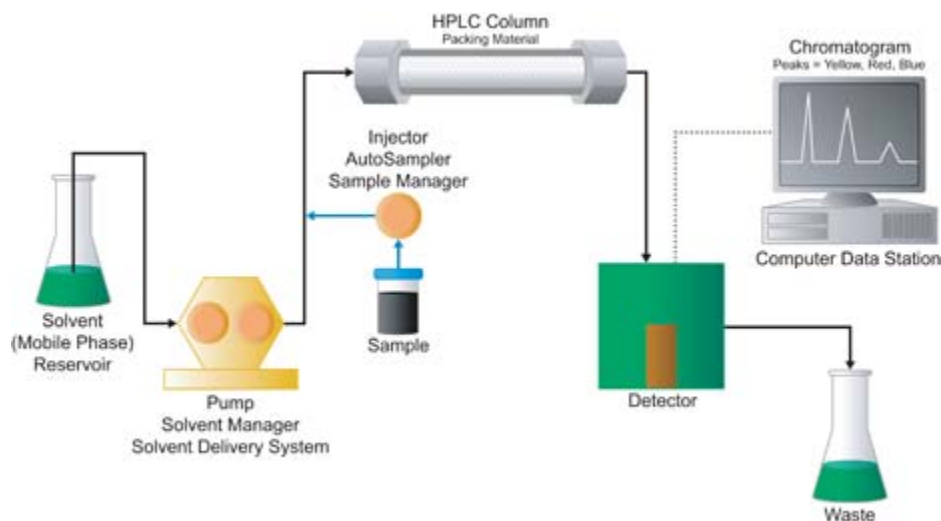

Figure 2-3: Schematic of a typical HPLC system

2.6. Introduction to Electrochemistry

Electrochemistry is a branch of chemistry that relates chemical and electrical effects. Electrochemical measurements can offer quantitative and qualitative information and also enlighten about the thermodynamics and kinetics of a chemical reaction. Electrochemistry has different advantages over other techniques, the low cost of the instrumentation if it is compared with other techniques such as those based on spectroscopic methodologies. Varying the electrode material, electrode design, and system set up can increase the selectivity and sensitivity of the technique.

2.6.1. Electrochemical cells

In electrochemical systems the action occurs at the interface of the working electrode (WE) and the ionic conductor or electrolyte. The process that takes place in a voltammetric cell is the transfer of electrons at the electrode – electrolyte interface. The electrode at which the reaction of interest (oxidation or reduction) occurs is called the working electrode (WE) and the potential of the latter is fixed relative to a reference electrode (RE). This has a constant potential of known value. In most electrochemical investigations, the cell consists of a three electrode system, the WE where the reaction of interest takes place, RE possessing a fixed potential, and the auxiliary or counter electrode (CE). The latter is included to ensure that the current does not flow through the reference electrode. The current passes through the interfaces at the working electrode and the auxiliary electrode. A potentiostat maintains the potential of the working electrode with respect to the reference.

2.6.2. Reference Electrodes

Reference electrodes are characterised as having a well known and constant potential that is generally unaffected by the composition of the sample solution. Their stability is of a great importance and they are usually contained within a half cell design which can be introduced into the test solution. The internal solution of the half cell contains a solution with either a known concentration, or in some instances a saturated solution, of the redox species responsible for maintaining the potential. In order to allow the interaction of the electrons with the external cell, the half cell tube is capped with a device which forms a liquid junction such as fritted disc or a porous plug and effectively serves as the salt bridge. Two of the more common reference electrodes are described in the following sections:

The Standard Hydrogen Electrode (SHE) consists of a platinised platinum electrode immersed in a solution of hydrochloric acid under standard conditions. The SHE is mainly used to measure electrode potentials and is given the internationally recognised potential of zero volts. The hydrogen electrode can be used as a cathode or as an anode, depending of the half cell with which the electrode is coupled. The standard reduction equation for the halfcell is:

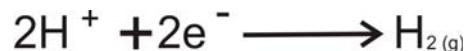

While it is the reference electrode against which all other standard reduction potentials are measured its practical application in a sensing context is severely limited due to the nature of the electrode setup. There are considerable issues with maintaining the surface activity of the electrode and there is a need for highly acidic conditions and a hydrogen gas supply – neither of which are appropriate for routine analysis.

Silver / Silver Chloride Electrode. This is one of the most common reference electrodes. It exploits the redox system of silver metal (Ag) and its halide salt - silver chloride (AgCl). The filling solution is typically either 3M potassium chloride or a saturated solution of the latter. In contrast to the SHE, the Ag/AgCl electrode is easier to construct and to incorporate within a conventional electrochemical cell. Moreover, it can be readily miniaturised and forms the basis of numerous disposable sensors in which the reference is formed from an Ag/AgCl ink or paste. In the present project, the reference within the flow cells was generally constructed by incorporating a chloridised silver wire. This was prepared through the oxidation of the silver wire (connected initially as the WE) in the presence of 0.1M hydrochloric acid according to the following process:

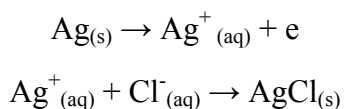

This results in the initial stripping of silver and the rapid formation of a layer of silver chloride which essentially mimics the system found within commercial Ag/AgCl reference electrodes (ie those supplied by Bioanalytical Systems). The only difference is

that it is not contained within a discrete half cell with its own internal chloride solution. The potential of the reference electrode was therefore maintained at a constant value through introducing a known concentration of chloride ion (0.1M KCl) within the test solutions.

2.6.3. Working Electrodes

An ideal working electrode (WE) will exhibit fast electron transfer kinetics and respond in a reproducible manner to changes in the activity of the analyte. The WE is made from a conductive but, normally, chemically inert material. The most common examples are the noble metals – platinum and gold – though more reactive systems such as copper and nickel have been used extensively for specialist applications such as carbohydrate detection. Carbon is another electrode material that has wide applicability and has emerged as an extremely flexible material that possesses many advantages over the others given the relatively inexpensive nature of the material, the diversity of forms it can take and its ability to be modified and processed. These aspects were summarised in Chapter 1 and the opportunities that they provide for developing new electrochemical sensors and detectors is explored in the subsequent chapters.

2.6.4. Auxiliary/Counter Electrodes

The counter electrode (CE), also called the auxiliary electrode, is used in a three electrode system to prevent the current having to go through the reference electrode. It is usually an inert material such as platinum and often has a surface area much larger than that of the working electrode so as not to limit the electrode processes being investigated at the WE.

2.7. Mass Transport

The transport of material from the bulk solution to the surface of the electrode where the reduction or oxidation of the molecules occurs is a vital component when attempting to understand the processes that can take place. There are three main processes that control movement of material from the bulk solution to the surface of the electrode: diffusion, migration and convection.

2.7.1. Diffusion

Diffusion is a mass transport process that will be present in all electrochemical measurements, and involves the transport of molecules from a region of high concentration to where the concentration is less and is highlighted in **Figure 2-4**. During an electrochemical process, the analyte will be oxidized or reduced only at the surface of the electrode and in doing so, the analyte will be consumed at the electrode surface. To equilibrate this imbalance, molecules of the analyte in the bulk solution will diffuse to the electrode surface.

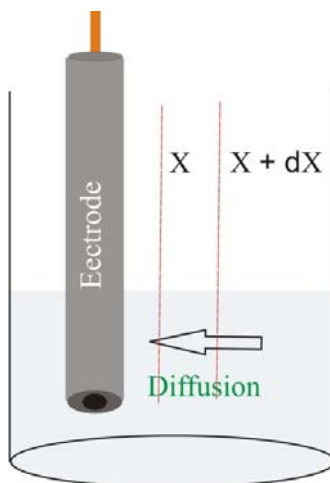

Figure 2-4: Diffusion mechanism on a bulk solution

This behaviour can be explained by Fick's laws but a number of terms must be defined before considering these in more detail. Flux (J) is defined as a number of molecules penetrating a unit area of an imaginary plane in a unit of time ($\text{mol}/\text{cm}^2\text{s}$). Diffusivity (D)

is the constant that describes how fast or slow a molecule diffuses (cm^2 / s). Fick's First Law explains how the flux goes from high concentration to places with less concentration with a magnitude proportional to the concentration gradient with the following equation:

$$J = -D \frac{\delta [c]}{\delta x}$$

However, Fick's First law does not explain how diffusion changes the concentration gradient with time. This is outlined in Fick's Second Law by the following equation:

$$\frac{\delta [c]}{\delta t} = D \frac{\delta^2 [c]}{\delta x^2}$$

2.7.2. Convection

Convection is due to the action of a force (usually mechanical or thermal) in the solution. This is commonly encountered in the form of stirring a solution or having a gas bubbling in the solution. Natural convection is present in all solutions due to small differences in thermal or density properties which mix the solution in an arbitrary way. Natural convection can be a difficulty if the measurement takes longer than 20 seconds. This problem can be avoided by introducing forced convection which is several orders bigger than natural convection and removes the casual aspects of the experimental measurements. However this will be true only if the convection is well defined and this is highlighted by the different flow regimes in **Figure 2-5**

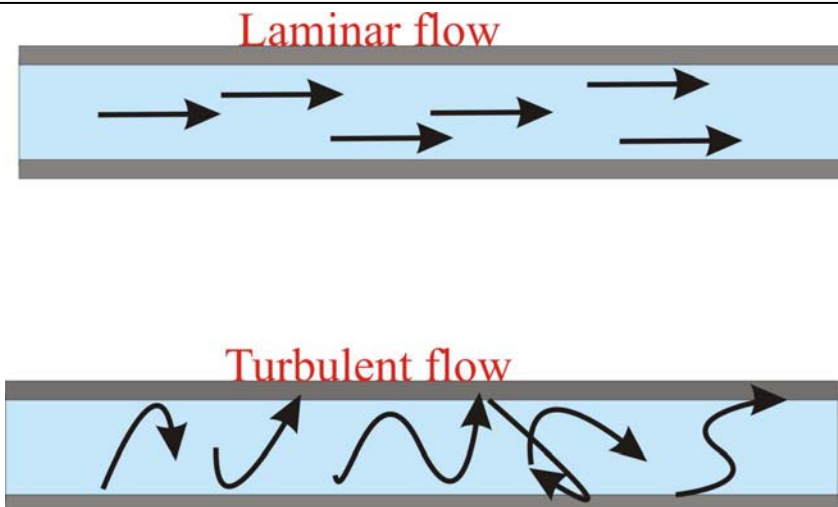

Figure 2-5: Representation of laminar and turbulent flow

In linear flow, the movement is predictable and controllable with the particles following a specific direction, no mixing is produced and the movement can be quantified. In turbulent flow, the convection is unpredictable producing random movements and mass transport cannot be easily quantified. Reynolds (1940) was the first to create a predictive model for convection mass transport in a linear flow condition with the follow equation:

$$Re = v_{ch} l/v$$

Where v_{ch} is the characteristic velocity (cm /s) and l (cm) is the characteristic length for the system of interest.

2.7.3. Migration

Migration takes place whenever a voltage is applied to an electrode and is an electrostatic effect. When a voltage is applied, the electrode becomes charged and any charged species near the electrode surface will either be attracted or repelled depending

on the voltage applied. This form of mass transport can be described mathematically by the following equation:

$$j_m \propto -u[C] \frac{\delta\Phi}{\delta x}$$

where migration flux is represented by j_m , $[C]$ is the concentration of the ion, Φ is the electric field and u is the ionic mobility.

However in real solutions migration is difficult to quantify due to ion solvation effects and diffuse layer interactions in solution. In order to solve these problems voltammetric measurements are usually done in the presence of an inert electrolyte. This is normally a salt that protects the reactant from migration. The function of the electrolyte is not only to prevent migration effects but to help the current pass through the solution. It can also serve additional purposes – buffering the solution or, the case of KCl, fixing the reference potential.

2.8. Voltammetry

In voltammetry, the current is measured as a function of an applied potential. Normally an increasing potential is applied to the working electrode and a residual current is observed until the reactant reacts on the electrode surface and an increase of the current value is observed – often leading to a peak shaped response. It is a dynamic technique due to the fact that the applied potential changes the concentration of electroactive species at the electrode surface. The electrode process (oxidation or reduction) involves the transfer of a charge between two different phases; the charge will be transferred between the electrode, metal phase and the solution phase, a charge separation must develop between the two phases which creates a potential difference between the electrode and the solution. If the potential of the solution is Φ_s and the potential of the metal is Φ_m , the potential drop between the two phases is,

$$\Delta\Phi_{m/s} = \Phi_m - \Phi_s$$

The quantification of this difference at a single interface is not feasible experimentally, therefore can be done with the introduction of a reference electrode which also possesses a potential drop but which is constant so any device that measures the voltage will measure the potential drop at both interfaces, consequently the voltage observed is defined by the following equation:

$$E = (\Phi_m - \Phi_s) + \text{constant}$$

where the constant refers to the potential drop at the reference electrode. When a potential is applied between the working electrode and the reference electrode, current flows between both electrodes and a third term must be added to the previous equation to give:

$$E = (\Phi_m - \Phi_s) + iR + \text{constant}$$

Where R is the electrical resistance of the solution and i is the current that flows between the two electrodes. When measuring low currents the term iR can often be neglected, however for the measurement of large currents iR is no longer negligible and the potential drop of the reference electrode can suffer changes due to the change of the chemical composition of the reference electrode by the passage of current through the latter. This problem can be avoided with the use of a third electrode - the auxiliary electrode. The potentiostat ensures that the current only flows through the working electrode and the auxiliary electrode and thus the reference electrode will maintain a constant potential. The most common uses for voltammetry are the quantification of organic and inorganic compounds in aqueous and non aqueous systems, determination of

electron transfer mechanisms or the determination of kinetics. The analyte must be capable of being oxidised or reduced in a potential range where there is no contribution to the current from the decomposition of the solvent.

2.8.1. Cyclic Voltammetry

Cyclic voltammetry is based on applying a triangular waveform in which a potential range is “scanned” at a constant rate (scan rate). This is highlighted in **Figure 2-6**. Varying the potential in both directions backward and forward and recording the current. It is a technique widely used for the study of redox processes, and for the study of reaction intermediates. A cyclic voltammogram detailing the profile observed for a reversible electron transfer reaction is highlighted in **Figure 2-7**. The potential is swept from 0 V to 0.55 V. At the beginning of the cycle, a residual current is observed but when the potential is going to more positive values we observe an increase of the current due to the oxidation of the analyte, the second peak is due to the reduction of the analyte previously oxidised.

The shape of the peak indicates a diffusion process and as

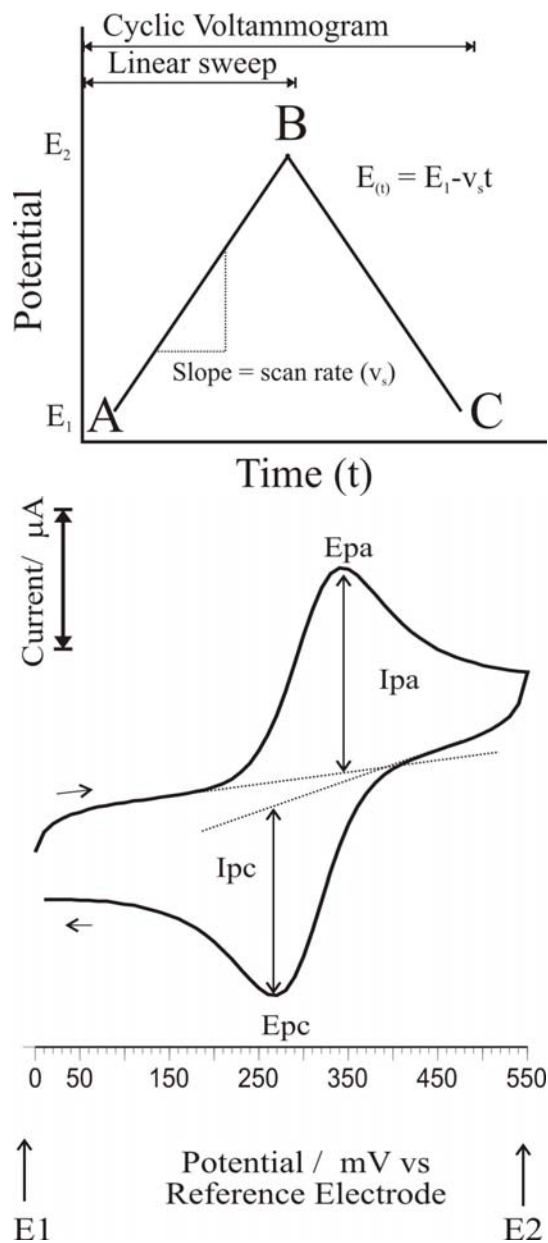

Figure 2-7: Voltammogram of a reversible electron transfer

we get close to the ideal potential the kinetics of the reaction are more favourable. The distance between the two peaks can be used to gauge whether or not the reaction has a fast electron transfer. In irreversible reactions the product of the oxidation is not reduced and no backward peak is observed as shown in **Figure 2-8**.

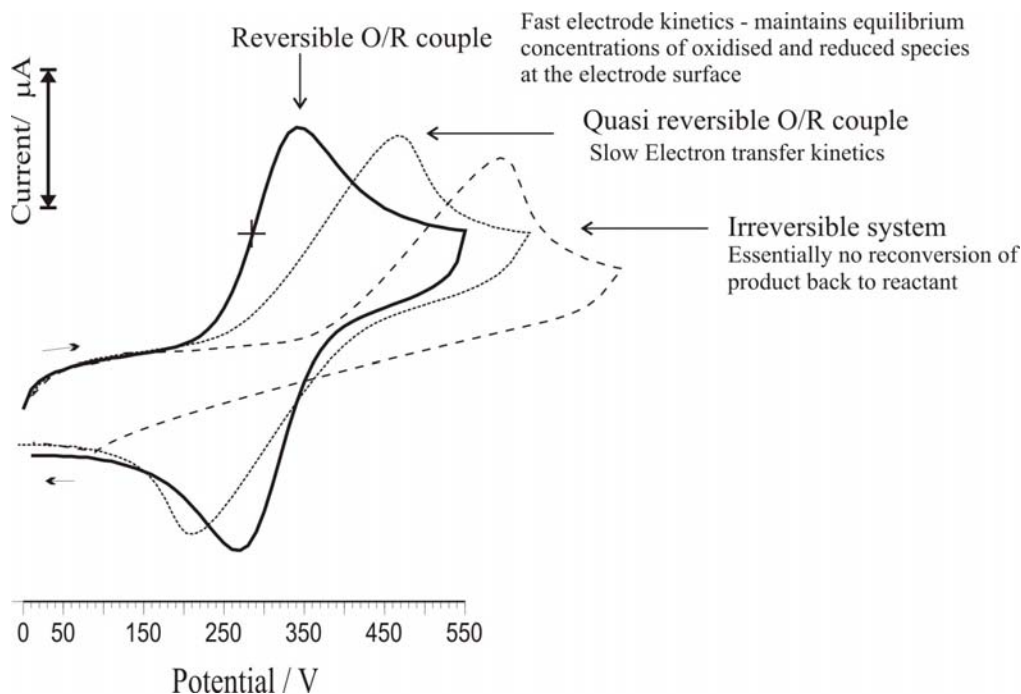
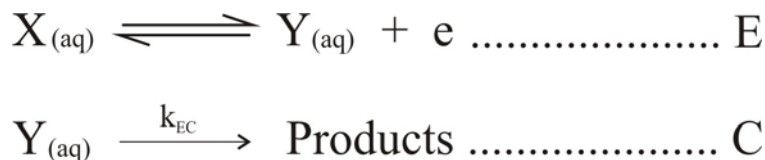

Figure 2-8: Voltammograms comparing the profiles typical of reversible, quasi reversible and irreversible electron transfer

Cyclic voltammetry can be used to study organic or inorganic reactions. Until now we have been assuming that the formation of the product is stable and that it does not react with anything within the sample matrix. One interesting aspect of electrochemistry is that the addition or removal of electrons from one molecule could generate a new redox site or a reactive molecule that will interact with the solvent or other species present in the medium. A variety of mechanisms, some of which involve complex sequences of electrochemical and chemical reactions can however occur:

EC Mechanism: This is where there is a following chemical reaction in which the product of the electrochemical process undergoes a further chemical transformation reacting with solvent or with some other component in the solution at a rate characterized by the constant rate k .



If the rate constant of the chemical reaction is very high, as soon as the intermediate is produced at the electrode it is consumed through the chemical reaction, therefore the backward sweep in the cyclic voltammetry will be substantially reduced in magnitude and may even be absent. If the rate constant is small, the chemical reaction is slow and thus no difference from the reversible cyclic voltammogram may be observed. These cases are highlighted in **Figure 2-9**. If the rate of the chemical reaction is not very fast the scan rate will contribute in the shape of the voltammogram and can be used in the elucidation of the reaction mechanism and reaction kinetics.

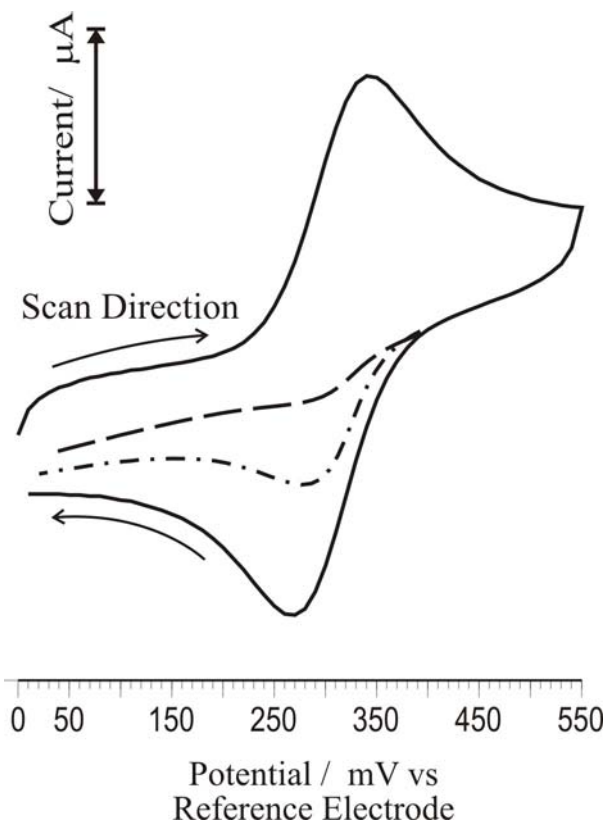
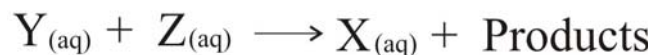

Figure 2-9: Cyclic voltammograms detailing an EC type mechanism. Influence of the rate constant on the magnitude of the reduction process. Large rate constants are typified by the dashed line - intermediate by the dot-dash line and small rate constants by the solid line

EC' Mechanism, also called a catalytic reaction is a special type of EC mechanism in which the electrogenerated species Y react with another component Z to regenerate the starting material X as shown below.



This gives rise to a characteristic sigmoidal profile (**Figure 2-10**) and is found with both chemical (ferrocene composites) and the enzyme systems discussed in later chapters.

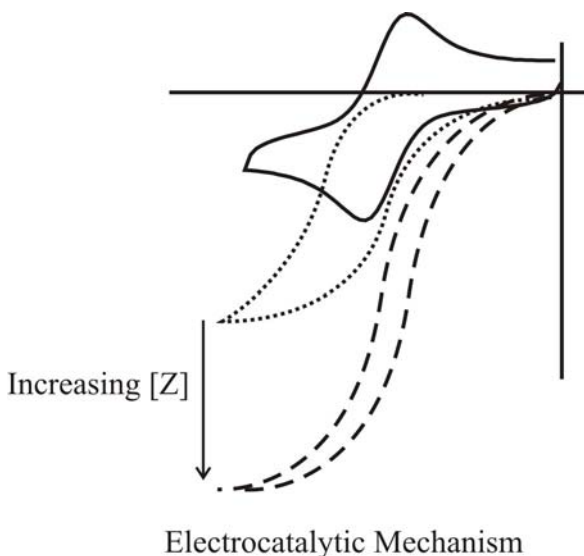

Figure 2-10: Cyclic voltammograms detailing an EC' type mechanism.

ECE. This involves an electron transfer, a chemical reaction and another electron transfer as indicated in the abbreviation. It is based on the generation of a reactive species which reacts with another component in the solution but, in contrast to the EC mechanism, the resulting product is electroactive within the potential window being studied. Thus a similar profile to that shown in **Figure 2-9** is initially observed but with

the addition of another, *new*, process observed. The position depending on the nature of the resulting electroactive product.

2.9. Scanning Electron Microscopy (SEM)

Scanning electron microscopy is an observational technique that uses electrons instead of light to create an image. The electrons interact with the sample and produce signals that contain information about the topology and composition of the sample.

Figure 2-11 details the main components of a scanning electron microscope.

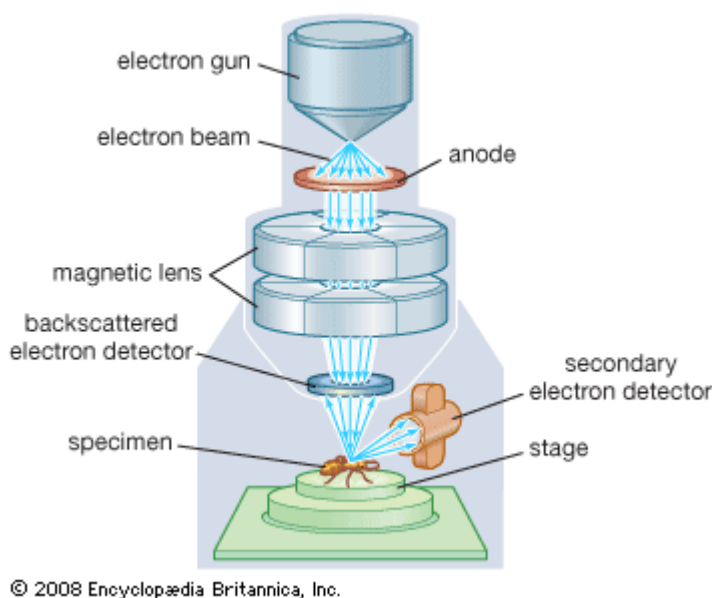

Figure 2-11: Components of a scanning electron microscopy (SEM)

The electrons are generated in the “gun” that is situated on the top of the column. The electron source comes from a filament - normally a Tungsten hairpin. The filament acts as a cathode, then a potential is applied and the filament is heated, the electrons generated migrate to a ring (anode) that is held positive with respect to the cathode. Some of the electrons are accelerated right to the anode and then are focused by a condenser lens into a very small point at the sample. The electrons that hit the sample produce both photon and electron signals. X-Ray signals can supply information about the thickness

and composition of the sample. Primary backscattered electrons will inform about atomic number and topography. Secondary electrons will inform about the topography. Specimen current will report about the conductivity of the sample. Cathodoluminescence will give electrical information and auger electrons will give surface sensitive and compositional information. All of these signals are present in the SEM but not all are used to obtain information. The signals most commonly used are the Secondary Electrons, the Backscattered Electrons and X-rays. These electrons collected by a secondary detector or backscatter detector are converted to a voltage, and amplified. The amplified voltage is applied to the grid of the CRT causing the intensity of the spot of light to change. The image consists of thousands of spots of varying intensity on the face of a CRT that correspond to the topography of the sample. In a modern SEM the scans signals are generated digitally by computer controlled circuit.

It is very important to maintain the vacuum into the column. The reason is that if the column is filled with gas, the electron beam cannot be maintained. The electrons could react with the gases and burn out or cause electrons in the beam to ionize, which produces random discharges and leads to instability in the beam. The SEM has a large depth of field, which allows a large amount of the sample to be in focus at one time. The SEM also produces images of high resolution, which means that closely spaced features can be examined at a high magnification. The limit of detection depends on the instrument but falls between 1 and 50nm. Preparation of the samples is relatively easy since most SEMs only require the sample to be conductive. This is accomplished by sputtering the sample with a conductive material normally gold or carbon. In some cases dehydration of the sample – especially those of biological origin may be required. The combination of higher magnification, larger depth of focus, greater resolution, and ease of sample observation makes the SEM one of the most heavily used instruments in materials research.

2.10. Atomic Force Microscopy (AFM)

This technique is a high probe imaging system that provides a great deal of information about the surface chemistry as well as the general topography of the surface

of the sample – whether it is conducting or non conducting. The AFM can offer image resolution down to the atomic scale, although many users of the AFM rarely need this resolution, working instead mainly in the molecular or in the sub-micrometer regime. The AFM consists of cantilever with a sharp tip (probe) at its end that is used to scan the specimen surface as indicated in **Figure 2-12**.

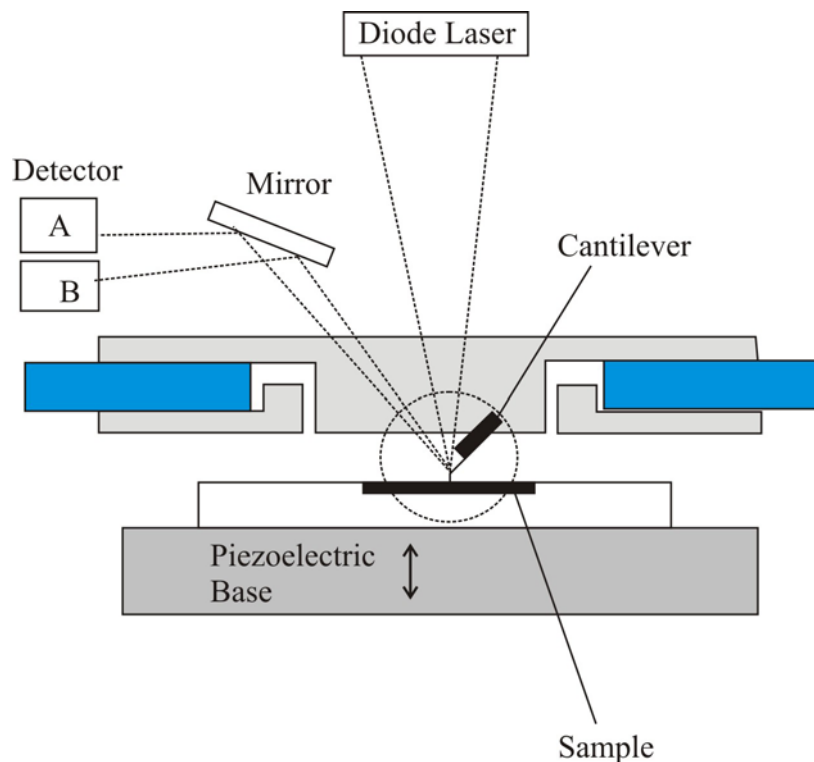

Figure 2-12: Components of a simple Atomic Force Microscope (AFM)

The cantilever is typically silicon or silicon nitride with a tip radius of curvature on the order of nanometers. When the tip is brought into proximity of a sample surface, forces between the tip and the sample lead to a deflection of the cantilever according to Hooke's law. Hooke's law is a simple equation that express the force generated within a spring when compressed in terms of spring constant and spring length.

$$F = -kx$$

Cantilevers are essentially springs, typically 50-200 micrometers in length. The detection system measures the deflection of the cantilever. A diode laser is focused onto the back of the cantilever and as the tip scans the surface of the specimen the laser deflected from the back of the cantilever to a dual element photodiode. The photodetector measures the difference of light intensity between the upper and lower photodetectors.

2.10.1. Modes of Operation

Contact / Non Contact Modes. In the former, the tip is in contact with the surface and it is deflected as it is scanned across the surface. In constant force mode, the tip is constantly adjusted to maintain a constant deflection, and therefore constant height above the surface. It is this adjustment that is displayed as data. Sometimes the tip is allowed to scan without this adjustment, and one measures only the deflection. This is useful for small, high-speed atomic resolution scans, and is known as variable-deflection mode. In non contact mode the cantilever oscillates, meaning that the tip is quite close to the specimen surface but it is not in contact.

Lateral Force Microscopy measures frictional forces by measuring the twist of the cantilever instead its deflection. It can be use to determine areas of different frictions.

Dynamic Force also called tapping mode. The cantilever oscillates closer than in the non contact mode and the tip, sporadically get in contact with the surface of the sample. The main advantage is that the lateral resolution increases for soft samples.

Force Modulation. This mode uses the properties of the probe material for sample tip interaction. The tip oscillates at high frequency and pushed into the repulsive force, the slope of the force-distance curve is measured which is correlated to the sample's elasticity.

Phase imaging. The phase shift of the oscillating cantilever relative to the driving signal is measured and this can be correlated to specific material that affects the sample/tip interaction. This mode is used to determine different property areas of the material such as friction, elasticity or adhesion.

2.11. References

1. Johns B A, Broten T, Stranieri M T, Holahan M A, Cook J J (2001) *Journal of Chromatography B* 754 343-348
2. Paul E. Minkler P E, Janos Kerner, North K N, Hoppe C L (2005) *Clinica Chimica Acta*, 352 81-92
3. Koide K, Zhang X M, Ohishi K, Usami Y, Hotta Y, Hiramitsu T (2006) *Experimental Eye Research*, 82 88-873
4. Mazuel C, Grove J, Gerin G, Keenan K P (2003) *Journal of Pharmaceutical and Biomedical Analysis*, 33 1093-1102

Chapter 3

New Strategies for Detecting Nitrate

Abstract

The present chapter presents a number of different approaches that have been taken in the development of analytical methods for the determination of nitrate within both the lab and field. A critical appraisal of the chemistry that underpins current commercial nitrate systems is presented and the need to remove the dependence on hazardous heavy metals (typically Cadmium) and concentrated acid components discussed. Two electrochemical detection pathways were investigated. The oxidation of nitrite arising from the electro-reduction of nitrate was assessed as a means through which to determine the latter without the need for prior degassing of test solutions. The possibility of transferring the approach to a disposable format was assessed through the development of carbon fibre composite sensors. The analytical performance of the prototype sensors have been evaluated. In the second approach - a gold electrode array for use in flow injection analysis applications is described. The detection of nitrite and nitrate have been used a model analytes with the latter quantified using a nano-structured copper plug formed by the in situ plating directly within the array.

*The work presented in this chapter has been accepted for publication within
Electroanalysis.*

3. 1. Introduction

The contamination of ground and surface water by nitrate has been of interest to both the scientific community and the wider public – particularly in relation to concerns over the potential hazard to health [1-5]. The anion is ubiquitous in nature but excessive loading can have significant impact – in terms of local ecological alteration but also from a human health viewpoint – particularly where drinking water is to be extracted. Legislative controls, such as the European Nitrate Directive (91/676/EC), are increasingly used to preserve the integrity of water systems through imposing limits on the amount of nitrogen that can be applied to various soils as the most common source of contamination tends to arise from agricultural run off. Nitrate Vulnerable Zones (NVZ) have been identified in most European countries and presently accounts for approximately 55% of the land within England [6, 7]. Compliance with the various statutory limits is typically enforced by a combination of on-site inspection and periodic waterway / borehole monitoring [8]. It is no surprise to find that there is a burgeoning interest in the development of technologies that can facilitate rapid field measurements of nitrate concentration. This chapter has sought to examine the various detection strategies that are being employed within commercial systems and explore potential developments that could be future face of environmental research and monitoring.

There are numerous reviews and books on the environmental fate of nitrate and also its potential, though contentious, influence on human health [1-5, 9-12]. This initial discussion assumes that the reader will be more than familiar with the background to the bio-geochemical transformations within which the anion has a role. There have been several reviews on the merits and limitations of various analytical strategies targeting nitrate from both environmental and biomedical viewpoints [13-16] but, as yet, none have focused on the field application of the methodologies within the former. A critical review of the chemistry that underpins the analytical systems currently available was thought to be appropriate and the material is compared and contrasted with more fundamental approaches that possess the potential for transfer from the research bench to a field setting. The material presented herein makes no claim to be comprehensive. The focus is on the different methodologies being promoted rather than incremental improvements of

one particular technique and considers the movement towards detection systems that are inherently safer and more environmentally acceptable. The “Green”-ing of nitrate

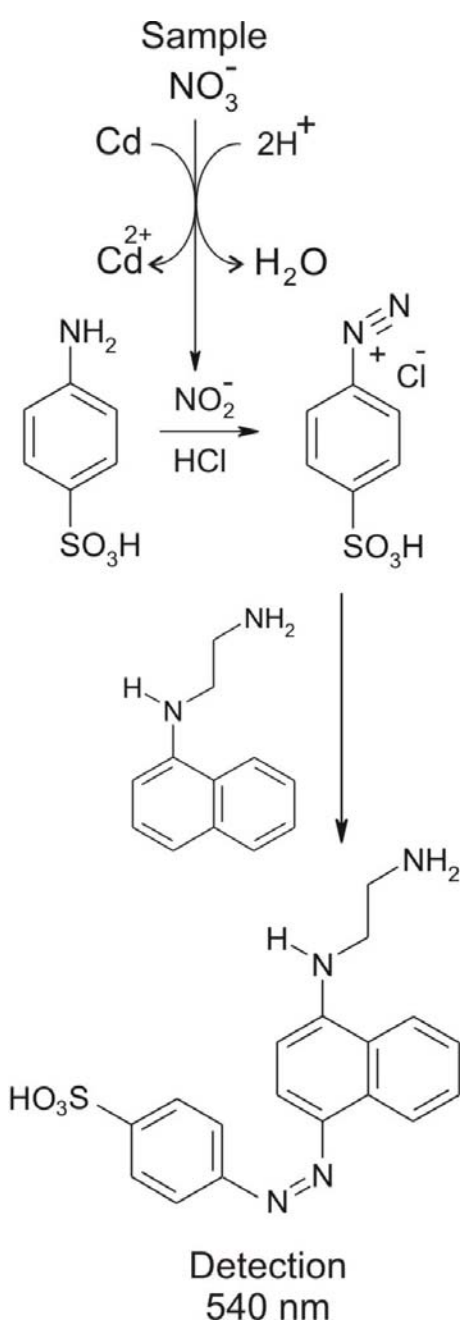

Scheme 3-1: Standard Griess test for the determination of nitrate.

detection has long been promoted within the research literature as the *raison d'être* for many investigations and stems from the fact that historically, the most successful field method of measuring the anion relies upon the interplay of several toxic chemicals – cadmium and 1-naphthyl-N-ethylene diamine [13-16]. The former to reduce the nitrate to the more reactive nitrite which can then be quantified by the coupling of the latter to nitrite diazotised sulphanilic acid in what is the now the classical Griess test method [17] shown in **Scheme 3-1**. There are obvious issues over the handling of such agents but their effectiveness, at least in part, explains their longevity as the foundation upon which many of the disposable dipstick tests are currently built. The lack of suitable alternatives is the other factor and the continuing driving force behind nitrate detection research. The latter encompasses a varied mix of technologies as befits the challenge presented by a target that can be remarkably uncooperative even when considering the many options open to conventional lab based analytical methodologies and is a consequence of the unreactive nature of the anion. The main workhorses of the environmental analysis lab are based on ion chromatography and its variants and relies upon column resolution of the various anions prior to detection by either conductivity or spectroscopic (UV) methodologies [18-24].

Flow injection analysis is an alternative and simpler system and almost invariably relies upon the reduction of nitrate to the more reactive nitrite and its determination after suitable derivatisation [25-30]. This involves some intricate chemistry – some of which has been successful in making the leap from lab to field. The transfer to field based measurements and the much more limited chemistry that can be applied in such settings obviously increases the challenge. The difficulty is increased further by the need to cover a fairly wide concentration range. The official limits for nitrate in drinking water vary from country to country with the World Health Organisation recommending 50 mg/L [30]. The European limits follow the latter while the US Environmental Protection Agency stipulates a more rigorous limit of 10 mg/L. Nitrate can vary between sub microgram per litre (nano-molar) common to marine environments to many hundreds of milligram per litre (milli-molar) for soil samples [13-16]. The concentration range will clearly depend on the source and nature of sample being investigated and, as such, the correct choice of the field test will be crucial and is not simply a question of economics or usability.

3.2. Commercial Field Systems

Most commercial nitrate monitoring systems designed specifically for field use are based on either the disposable test strip or the reaction vial. These differ only in terms of sample and reagent handling and both almost invariably rely on assessing the colour change associated with the introduction of the nitrate containing sample. These are commonly marketed for aquacultural monitoring purposes along with nitrite, phosphate and various other nutrient tests. The test strip is clearly the easiest system to use and in many cases will utilise a variant of the cadmium / Griess test (**Scheme 3-1**). The presence of the heavy metal will rarely be found on the advertising literature but it will nevertheless be a microscale version of the cadmium reduction column common to the laboratory [25-29]. Many of the Merck systems utilise the synergistic interaction of cadmium, copper sulphate and zinc. The advantages of the strip system are that they are essentially “reagentless” from the point of user manipulation with the chemicals impregnated within the detection pad with the simple immersion and removal of the strip

all that is required. Storage and hence disposal of the used strip is relatively simple and arguably the most convenient of all the commercial systems used.

The vial approach is the alternative and employs a miniature chemistry set in which aliquots or sachets of various reagents are mixed along with the sample. There is a significant drawback in that the resulting mixture must then be disposed of properly – which can be difficult in a field setting – especially if a large number of samples are required. This is not a trivial matter given the possible presence of cadmium (metal and ion) in the waste. There are alternatives to the use of cadmium. The most common, not surprisingly the least expensive, is where the nitrate is induced to react directly with an aromatic indicator – the nitration reaction yielding a coloured product that can be used to quantify the anion. Ordinarily, this approach would be the preferred option and is a

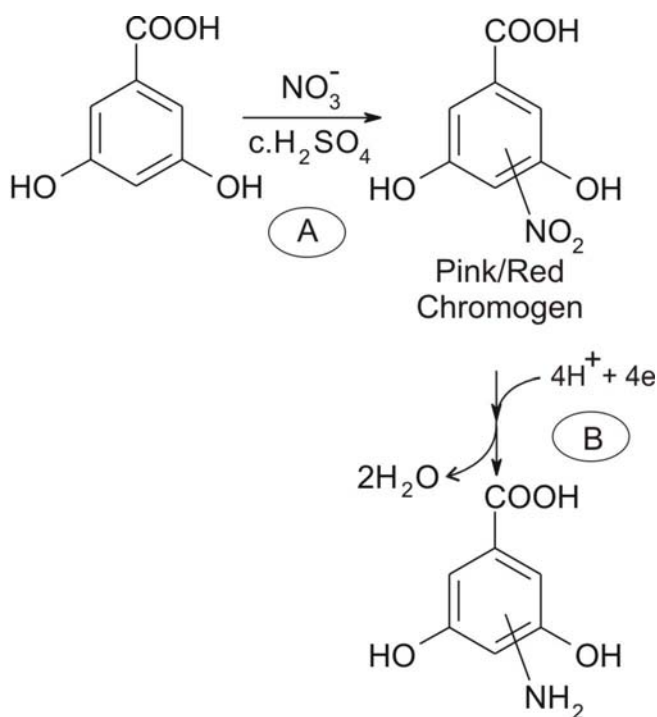

Scheme 3-2: Derivatisation-Detection of Nitrate. A) Colorimetric determination of nitrate through conventional nitration pathway. B) Electroanalytical determination through reduction of the nitro to corresponding amino derivative.

generic strategy employed in many water quality measurements for a whole host of anions and cations. The problem in this instance, however, lies in the fact that nitrate, as mentioned previously, is incredibly stable and requires significantly harsh conditions before it will participate in even simple reactions. The latter are typically supplied by the addition of a concentrated sulphuric acid solution. This is the archetypal nitration reaction common to most undergraduate laboratory courses but carried out by the river side. Concentrated sulphuric serves a number of purposes: one is to dehydrate the nitrate sample added; the second is to generate heat (as a consequence of the exothermic heat

of hydration released by mixing the concentrated acid with water from the sample) and the third is to generate the nitronium ion (NO_2^+) which will then react with an activated aromatic through conventional electrophilic substitution [31] as indicated in **Scheme 3-2**.

In commercial terms, several variants of the Merck Microquant system employ 3,5-dihydroxybenzoic acid as the activated indicator. In principle, there is potentially a huge number of possible contenders and many variations have appeared in both the historical and recent research literature (eg. resorcinol [32], 1-naphthol-8-sulfonic acid[33], anisole [34], Brucine [35], salicylic acid [36]) – the main requirement is an aromatic with electron releasing groups to facilitate the electrophilic substitution and ensure that the kinetics are sufficient that the test is accomplished within a few minutes. Similar assays have been developed but serve as the derivatisation step prior to analysis by gas or liquid chromatography [36-41]. Again the principles are the much the same – activated aromatic, concentrated acid and the addition of the nitrate sample. In terms of a field test - changing the nature of the indicator has a relatively minor influence on the detection wavelength but there will be clear advantages when considering a lab based system where seemingly minor variation in chemical structure may significantly influence the molar absorptivity and hence detection sensitivity. Irrespective of the indicator employed - the main practical issue relates to the handling and disposal of the concentrated acid solution once the test has been completed. Both the cadmium-Griess hybrid and the nitration routes hark back to classical chemistry. A more modern alternative relies upon the inherent selectivity and catalytic ability of nitrate reductase enzyme to convert the nitrate to nitrite[42-43] as indicated in **Scheme 3-3**.

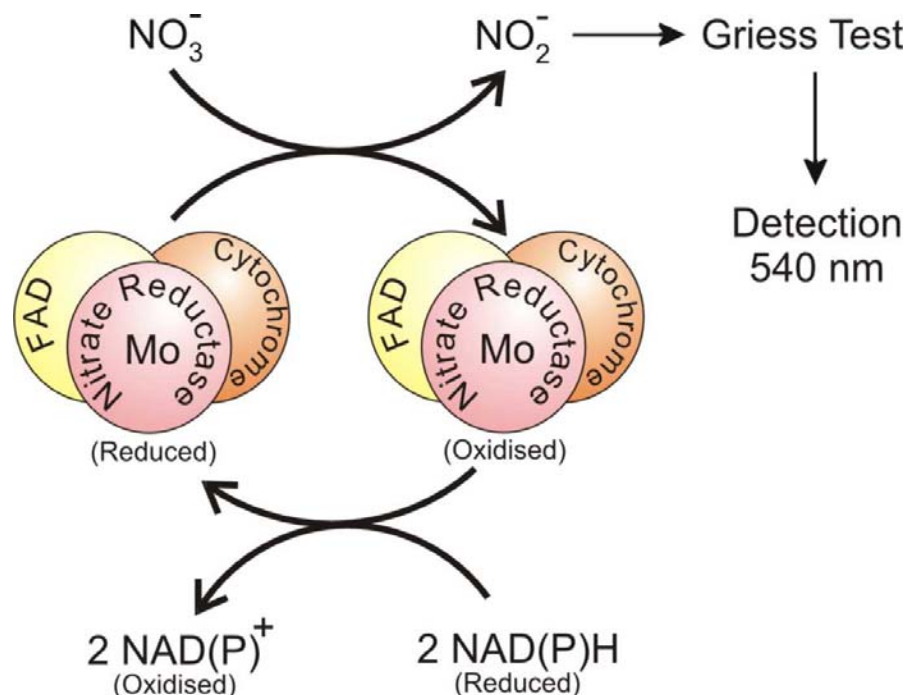

Scheme 3-3: Enzymatic reduction pathway for the determination of nitrate

The enzyme is produced by a variety of animals, plants, and microorganisms and usually contains three cofactors – the flavin dinucleotide (FAD), a heme-iron (cytochrome) and a molybdenum (Mo-molybdopetrin) centre. The latter is the site at which nitrate is reduced while the first is principally where the NAD(P)H is oxidised to regenerate/re-activate the enzyme. Providing an excess of the latter is provided the enzyme will effectively consume the nitrate producing nitrite which can be determined using conventional Griess chemistry (**Scheme 3-1**). The advantages being the very notable omission of cadmium or the concentrated acids such that disposal of the test is no longer an issue. The disadvantage however is that the system is significantly more expensive (almost by a factor 10) than the purely chemical approaches and this is borne out when examining the range of commercial systems that are currently available. There is an abundance of suppliers offering the simple nitrate test strip or reaction vial approach with very few promoting the enzymatic system.

Whether test strip or reagent vial is used and irrespective of cadmium, concentrated acid or enzyme chemistry; the analytical signal and the eventual nitrate concentration is obtained simply through comparing the colorimetric response with a colour chart included with the test typically covering the range of 0-500 mg/L. These often appear as a series of graduated coloured blocks (i.e. 0, 10, 25, 50, 100, 250, 500 mg/L) delineating the various nitrate concentration steps. There can often be considerable ambiguity in ascribing the colour to a series of shades (be it orange or pink) on the comparator chart but the errors associated with colour perception can be overcome electronically through the insertion of the vial within a portable colorimeter or reflectometer. While these are moderately expensive (when compared to the simple test strip package) this can often be mitigated through their versatility / generic applicability in measuring a range of different analytes simply by changing the filter.

Barring the introduction of the enzyme based systems, there has been relatively little change in the nature of the tests over the past few decades but this could be expected to change in the future as more stringent regulations are imposed over the use of the chemicals associated with the test – particularly cadmium. The pertinent question is therefore – what are the alternatives that could emerge in the near future?

3.3. New Developments

There is a substantial body of literature on the development of new analytical methods for nitrate determination. In most cases these are based on traditional chromatographic methodologies which will have little prospect of transfer to a field setting. These exploit the pre-derivatisation of the nitrate – in much the same way as is done with the colorimetric vial systems discussed previously – the difference being that a more rigorous quantitation is possible [37-41]. While portable chromatographs have been in existence for many years – it is unlikely any would be a realistic competitor with the existing test strips. Lab-on-a-chip systems can offer micro-capillaries that mimic chromatographic systems but the derivatisation step is still reliant upon concentrated acids and there appears to be little extra value to be gained from the increased sophistication of the detection system. Similar arguments could be used for

electrophoretic systems [44-47] but these have an inherent advantage over conventional liquid or chromatographic systems in that they are more suited to the separation of charged species and could, in principle, offer multi-analyte resolution without pre-derivatisation. Assuming the instrumentation could be packaged in a portable format then these may well represent the future of ion based field measurements. At present, they are laboratory based systems restricted to research groups through the inherent complexity in their operation and maintenance.

Electrochemical sensors may represent the most immediate contender to challenge the supremacy of the test kits. This methodology already has a tentative foothold in the commercial market through the availability of nitrate ion selective electrodes (ISE). These serve a niche market in that they are more likely to be used for continuous monitoring purposes rather than for *ad hoc* field measurements. They have some considerable advantages over the existing technologies – being reagentless – relying upon the selective membrane interaction of lipophilic anion receptors such as N,N,N-triallyl leucine betaine [48-50]. They are reversible and possess a large dynamic range (micro to molar nitrate). They almost represent the ideal alternative as the underlying potentiometric signal transduction is akin to that used in conventional pH sensing. In principle, this should offer a relatively simple means of monitoring nitrate but the system can be far from intuitive and perceived by many as a complex instrument that requires frequent calibration, is rather slow with a near continual drift in response that will pose an obvious ambiguity to those less experienced in the use of ISE's.

Much of the emphasis is on ion *selective* rather than ion specific but while there is continuing research into the design of new anion receptors, the majority of the electroanalytical nitrate effort however relates to voltammetric rather the potentiometric detection methodologies. The former is a more aggressive approach in that rather than passively monitoring the potential, as in the latter, the potential is actively controlled such that the nitrate is electrochemically reduced with the transfer of electrons from electrode to target used as a mean as of quantifying the anion. The current is monitored as a function of potential and offers a degree of selectivity in that the potential at which nitrate undergoes the reaction will be characteristic of the anion, electrode and electrolyte being used. A wide range of electrode substrates have been investigated and include silver [51],

cadmium [52], platinum [53], gold [54] and, more recently, boron-doped diamond [55,56]. Various alloys and catalytic deposits have also been investigated – typically involving nickel [57], copper [58-60], tin / palladium [61,62] and platinum / rhodium [63].

The typical reaction profile observed with a voltammetric scan is shown in **Figure 3-1** and highlights the response of a freshly deposited macroporous copper electrode to nitrate [58]. The measurement is initiated at a potential where there is essentially no electrode reaction and hence little observed current. The potential at the electrode is then made more negative (cathodic) and several peaks can be seen to emerge. These correspond to the different species present with Cu(I), Cu(II) and NO_3^- transitions clearly visible. The Current then increases dramatically towards the end of the scan as the breakdown of the electrode occurs (reduction of protons to hydrogen gas).

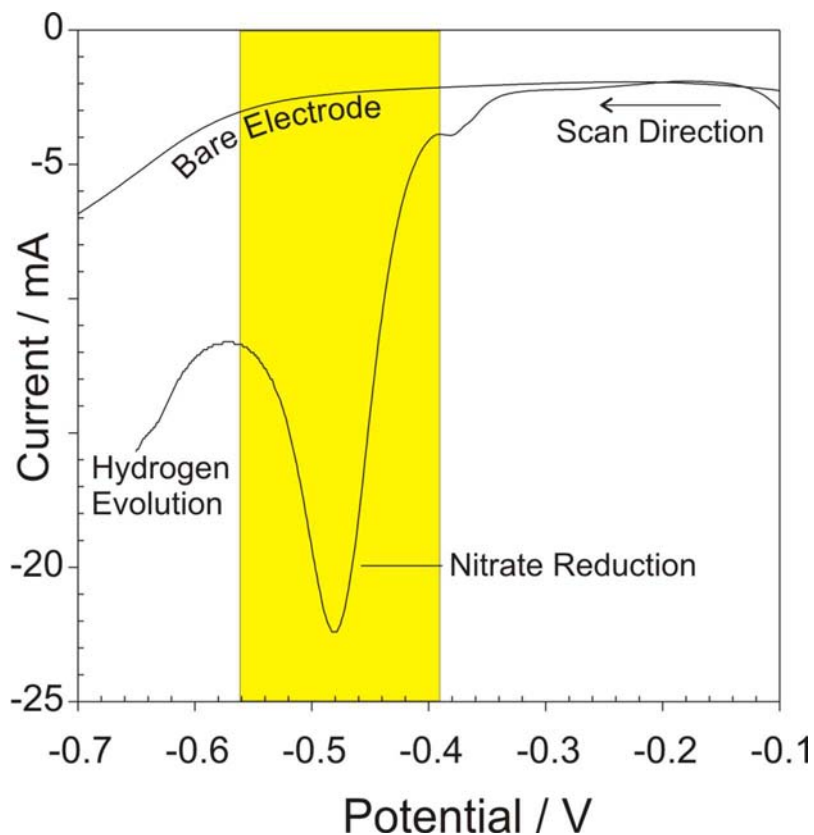

Figure 3-1: Linear sweep voltammograms detailing the reduction of nitrate at a freshly plated copper electrode. Adapted from Davis et al [58].

The height of the peaks is proportional to the concentration of the various species and hence it could offer a relatively rapid means of quantifying nitrate. The response in **Figure 3-1** is at a freshly plated copper electrode which possesses sites that are highly reactive towards nitrate [58]. The electroanalytical determination of nitrates at simple, un-treated / un-modified electrodes is not simple as the kinetics of charge transfer associated with the direct reduction of the anion is slow, despite the thermodynamic feasibility of the reduction and, as such, the current response and hence the sensitivity of the technique suffers [63]. Increasing the applied potential – hence driving the reaction forward – is one approach to overcoming the poor response but this can compromise selectivity as different processes overlap. This can be inferred from **Figure 3-1** where increasing the applied (negative) potential increases the possibility of the nitrate being obscured by the significantly larger current arising from the hydrogen evolution process.

Electrode modifications to improve both the sensitivity and resolution capabilities of base element substrates are common but these incur the overhead of restricting application to specific research groups through increasing the technical and procedural complexity of both sensor and the protocol. There are however a number of simpler options that can be readily adopted and rely upon the *in situ* plating of the metal to provide the large surface area of highly active catalytic particles [56, 60]. This can often be achieved simply by adding an aliquot of the sample to an electrolyte solution containing the appropriate metal salt. The electroanalytical procedure is fairly independent of the base electrode material as the nitrate reduction occurs at the freshly deposited metal layer, and this is a major benefit for this approach. This has been exploited in the development of disposable capillary fill devices in which screen printed carbon electrodes were used in conjunction with cupric sulphate to provide a response to nitrate [64]. A simpler, and arguably more intuitive, protocol that offers reagentless sensing capabilities is where the anodic dissolution of a copper electrode is initiated to release cupric ion within the diffusion layer which, upon re-deposition, effectively provides a fresh layer of nitrate active copper [65].

An alternative approach is to prepare the electrode *ex situ* where the surface of the electrode is conditioned in a plating solution of defined composition and then transferred to the analysis solution [58]. In the case of a cupric ion / sulphate / chloride mixture, it

was found that this approach offers greater control over the morphological features of the deposit which, in this case, leads to a particularly active and macroporous granular deposit. This approach was found to retain considerable activity over a 24 h period of continuous use, but is more susceptible to cumulative passivation effects (adsorption of fulvic / humic material). Surface activation and cleaning of electrodes to counter the latter have been examined through the application of 20 kHz ultrasound and could be one option when considering highly passivating matrices such as sewage [66].

Indirect detection of nitrate can also be considered and mimics the colorimetric assays in which nitration of an aromatic compound to introduce a nitro functionality is the key step [67]. The latter can be electrochemically reduced at most conventional electrodes without the need for any elaborate modification. The measurement process is invariably voltammetric with a measurement profile not too dissimilar to that seen with direct nitrate – in that the reduction will give rise to a peak process characteristic of the aromatic indicator compound under investigation. In this instance, manipulation of the substituent functional groups within the indicator will influence the redox properties and hence the potential at which reduction of the assay appended nitro group will occur. This can often be achieved with relative ease (within a less negative potential region) and contrasts the large negative potentials required for the direct/catalytic reduction of the anion. This strategy is simply the application of the colorimetric assays but using an electrochemical quantitation. The limitations of the system are the same as those encountered with the former – principally the use of the concentrated acids to induce the initial derivatisation and the subsequent disposal of the test medium [67].

The adoption of enzyme electrodes again seeks to adapt the colorimetric format to one which can be read easily by the exchange of electrons at the electrode. In this case, however, the natural electron donor (NADH or NADPH) is replaced by an artificial mediator that effectively shuttles electrons between electrode and enzyme [68-74]. The protein coat surrounding the latter effectively prevents any direct transfer from electrode to enzyme redox centre and hence regeneration of the latter must be done through indirect means. The electrode kinetics for the regeneration of NADH are generally too slow to be of any electroanalytical use and hence the need for artificial electron donors. The underlying reaction mechanism is shown in **Scheme 3-4**.

The enzyme operation is the same as per the colorimetric system but the analytical signal is taken from the regeneration of the mediator that supplies electrons to the oxidized form of the enzyme. This is a catalytic cycle in which - the more nitrate present - then the rate at which the mediator is re-reduced at the electrode increases and hence the reductive current monitored at the electrode increases accordingly. There is a wide range of mediator available – with microperoxidase-11 [68,69], heterocyclic dyes [70] or methylviologens [71-76] being among the more commonly used. The main pre-requisites being that the redox chemistry is reversible and that the standard reduction potential is sufficiently negative to facilitate the reduction of the enzyme. There is an added caveat in that there is also a desire to avoid having to apply potentials that are too negative as this will obviously bring in to question selectivity and sensitivity issues as per the case for the metal based catalysis described earlier.

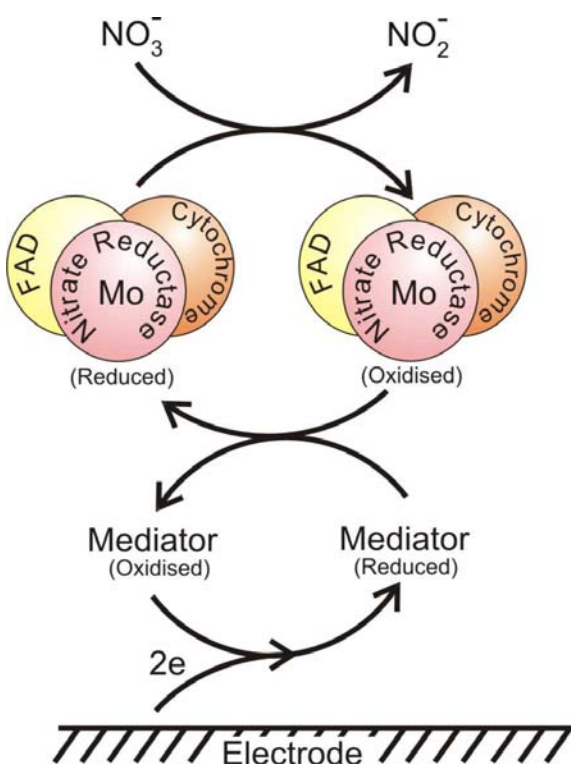

Scheme 3-4: Electrocatalytic determination of nitrate utilising nitrate reductase

In its simplest terms, the system outlined in **Scheme 3-4** has few practical advantages over the colorimetric system. It could be promoted on the basis that it is independent of the matrix colour but the increased complexity and instrumental overhead outweigh this minor advantage when considering simple solution based electrocatalysis. It could, of course, be possible to incorporate the enzyme within screen printed electrodes along with the mediator in a format not dissimilar to the glucose enzyme strips that dominate the sensor market as this could be a viable alternative in the future. An alternative approach would be the design of a reagentless, re-usable probe (similar to the nitrate based ISE's). This would require

the immobilization of both enzyme and mediator at the surface of an electrode – usually

through the use of an appropriate polymer film [71-75]. Such approaches are well established in the development of electrochemical biosensors and while many variations have been demonstrated with glucose oxidase, few attempts have been made with nitrate reductase systems – largely as a result of enzyme cost. One very pertinent example however, has been the use of polypyrrole [75]. In this instance, a pyrrole modified viologen is electropolymerized in the presence of the enzyme and results in the encapsulation of both mediator and enzyme at the electrode surface. The enzyme is retained as a consequence of its macromolecular bulk with the mediator prevented from leaching through the covalent attachment to the polymer backbone. Long term stability of such systems remains an issue and like the ISE – the complexities of their actual operation and maintenance may be a strong inhibitor of uptake.

3.4. Summary

While the ultrasound system is certainly novel from a research viewpoint, it is expensive, far from simple and is not readily portable. As such, it is unlikely to generate a substantial user base but may have application with certain niche areas. The more simple and financially inexpensive voltammetric systems will obviously possess more commercial feasibility in that they could be further developed with a format similar to the technology used for glucose monitoring. The potential has already been demonstrated through the extrapolation of the technology to the disposable strip format and they could rival the portable colorimeters that are presently available – offering not simply the opportunity for a more unambiguous, quantitative evaluation of nitrate but the operational versatility that could be extended to other test parameters – depending on the nature of the disposable strip used. The latter is effectively the electrochemical equivalent of changing the vial/filter system utilized by the colorimeters.

It could be expected that the increasing availability of nitrate reductase will inevitably replace the use of cadmium and the other nitration based systems for colorimetric test kits. The integration of the enzyme within conventional electroanalysis has been demonstrated and it is likely that its incorporation within the disposable strip format could be a feasible electrochemical strategy. The incorporation of the enzyme is

not without its difficulties and there is still room for alternative electrochemical strategies. The remainder of this chapter explores a novel approach to the determination of nitrate that could address some of the limitations identified in the previous sections.

3.5. Proposed Methodology

Two approaches were investigated: the development of a new approach to nitrate sensing that could be applied to a field based sensor and, second, an investigation of the applicability of a nanostructured deposit as a laboratory based flow injection analysis detector. The first investigation sought to exploit the reduction of nitrate as an initiation step in which the *in situ* deposition of copper promotes the chemical reduction of nitrate to nitrite. The analytical step, however, is not the current that arises from the electrocatalytic nitrate reduction but, rather, relies upon the re-oxidation of the electrogenerated nitrite. Both the reductive pre-treatment and oxidative analysis steps can be accomplished at the same electrode – simplifying the construction of the potential sensor. The basic rationale that underpins the proposed analytical methodology is outlined in **Scheme 3.5**.

Scheme 3-5: Proposed detection pathway involving the electro-reduction of nitrate at the copper modified electrode (1) with subsequent release of cuprous ion and nitrite. Oxidation of either the $\text{Cu(I)} > \text{Cu(II)}$ (2) or nitrite to nitrate (3) can provide the core analytical signal.

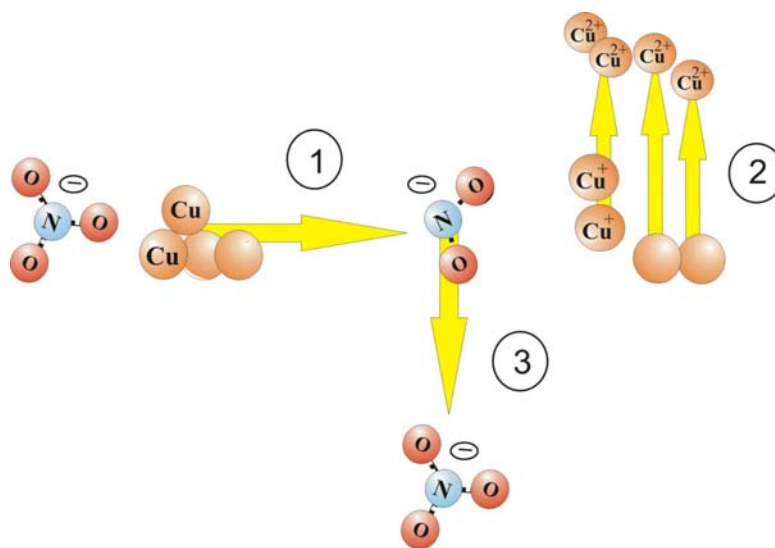

The core advantage is that it avoids the interference of dissolved oxygen which, in conventional electro-reduction strategies, would be reduced at the potentials applied, would contribute to the detection signal and it could be expected that it would severely limit the accuracy of a field sensor. The initial investigation therefore sought to explore

the mechanism promoted in **Scheme 3.5** using cyclic voltammetry and to assess its transferability to an amperometric methodology and critically evaluate the operational boundaries liable to be encountered in a future sensor. In contrast, the lab based system exploits the deposition of copper onto an array of gold electrodes within a flow system to form the basis of a catalytic layer. It is anticipated that the reactive nature of the nano-structured deposit could facilitate the electro-reduction of nitrate. The construction of the copperised gold detector is described and the analytical performance characterised. The main issues to be addressed in the investigation, however, relate to the challenges faced by the detector in achieving the required selectivity and sensitivity towards nitrate.

3.6. Experimental set-up

All reagents were of the highest grade available and used without further purification. Stock solutions of nitrate and nitrite (typically 10 mM) were prepared in 0.1M sodium sulphate adjusted to pH 3 through the addition of hydrochloric acid. Electrochemical measurements were conducted using an Autolab PGStat computer controlled potentiostat (Eco-Chemie, Utrecht, The Netherlands) using a three electrode configuration consisting of either a glassy carbon working electrode (3mm diameter, BAS Technicol, UK) or carbon fibre laminate. Platinum wire served as the counter electrode with a 3 M NaCl Ag | AgCl half cell reference electrode (BAS Technicol, UK) completing the cell assembly. Unless otherwise specified – all measurements were conducted without pre-degassing with the solution temperature being $22^{\circ}\text{C} \pm 2^{\circ}\text{C}$ throughout.

3.6.1. Carbon Fibre Electrode Construction

Laminated carbon fibre prototypes were prepared by thermally sandwiching carbon fibre sheet between sleeves of a laser etched (1 mm diameter window) resin-polyester lamination pouch (75 μm thick) using a commercially available laminator [78]. Electrical connection to the carbon film was made through the presence of a strip of copper shielding tape. The electrodes were baked at 100°C for 1 hour in order to ensure the complete permeation of the resin between the fibres within the laminate. This is

necessary to ensure the mechanical integrity and coherence of the seal between the sensing fibre layer and the insulating polyester sheath such that no solvent creep or delamination would occur during the electrochemical investigations [78].

3.6 2. Copper-Gold Nano Deposit

The gold electrodes were functionalised as required through the electrodeposition of copper. This was achieved through using a conventional equimolar copper sulphate / sodium sulphate (0.1 M, pH 3) plating solution as the mobile phase [66]. The appropriate gold electrode within the array was held at -1.0 V relative to the silver/silver chloride pillar electrode and the copper plating solution pumped through the detector cell at 1 mL/min for periods up to 1 hour – depending on the thickness of the copper deposit required.

3.6.3. Flow Cell Construction

The flow cell consisted of a linear array of seven single element metal rods - one silver (to function as the reference electrode) and six gold (independently addressable working electrodes). Each rod was 1mm in diameter set with a 2.5 mm spacing between each and carefully “pierced” through silicone tubing (1mm internal diameter) such that the rod passes precisely through the centre of the internal channel. Each rod acts as a cylindrical electrode or “pillar” that sits in the path of mobile phase – which must flow around. The silicone tubing would normally be considered to be self sealing but as the diameter of each “pillar” matches that of the internal tubing, there will be an inevitable pressure build up as the solution squeezes between the wall of the tubing and the metal pillar. This can induce leakage at the point where the electrode protrudes through the silicone. To counter this, the entire array was sealed with epoxy. The auxiliary/counter electrode was a stainless steel flow connector placed downstream of the gold pillar electrodes.

3.7. Results and Discussion

Linear sweep voltammograms detailing the response of an unmodified glassy carbon (GC) electrode to increasing nitrite ($100\ \mu\text{M}$ additions, pH 3) are shown in the inset profiles within **Figure 3-2**. Well defined oxidation processes are observed at $+0.9\text{V}$ which increase linearly with increasing nitrite concentration highlighting the ease with which the measurement can be accomplished. The response to nitrate ($200\ \mu\text{M}$, pH 3) in the presence of $400\ \mu\text{M}$ Cu(II) is shown in **Figure 3-2**.

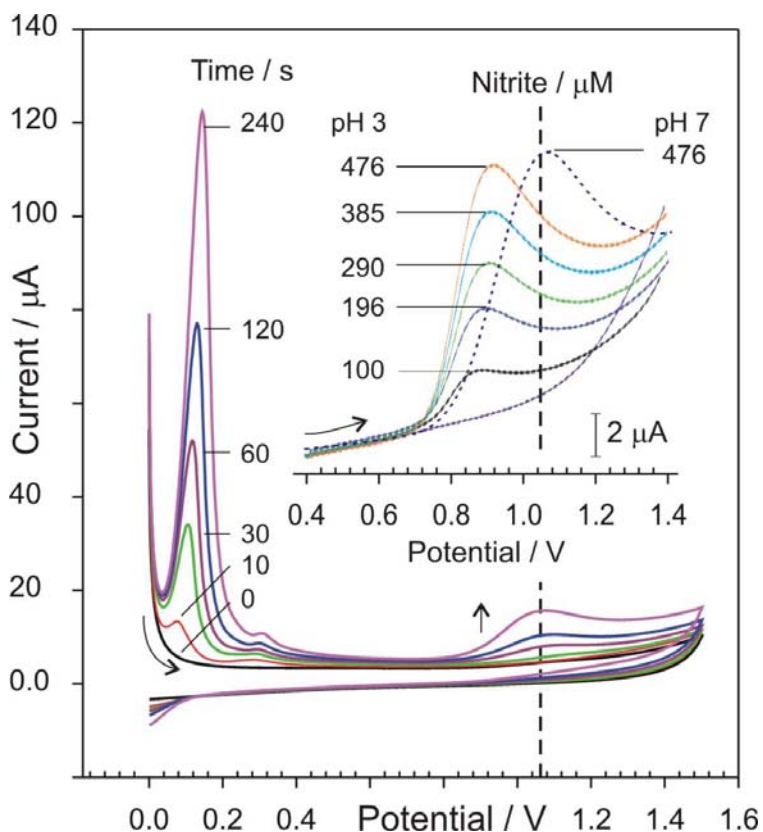

Figure 3-2: Cyclic voltammograms detailing the response of a glassy carbon electrode to $100\ \mu\text{M}$ nitrate in the presence of Cu(II) ($400\ \mu\text{M}$) in Na_2SO_4 electrolyte (pH 3). The electrode was subjected to a conditioning potential (-1V) of varying duration (0-240s). Inset: Linear sweep voltammograms comparing the response of the GC electrode to increasing nitrite within electrolyte adjusted to pH 3 and pH 7. Scan rate: 100mV/s .

In the absence of any cathodic pre-treatment – no oxidation process is observed at +0.9V. Upon imposing an initial conditioning potential of -1V to be followed by the “analysis” scan, the oxidation process attributed to electro-generated nitrite begins to emerge. Increasing the duration of the conditioning potential results in a corresponding increase in the nitrite produced and hence the magnitude of the oxidation process. The voltammetric profile would appear to confirm the reaction pathway outlined in **Scheme 3-5** - whereby reducing Cu(II) to copper leads to the subsequent reduction of nitrate to nitrite. The latter being detected in the following anodic scan. The influence of the conditioning/copper deposition duration on the response to increasing nitrite is detailed in **Figure 3-3**.

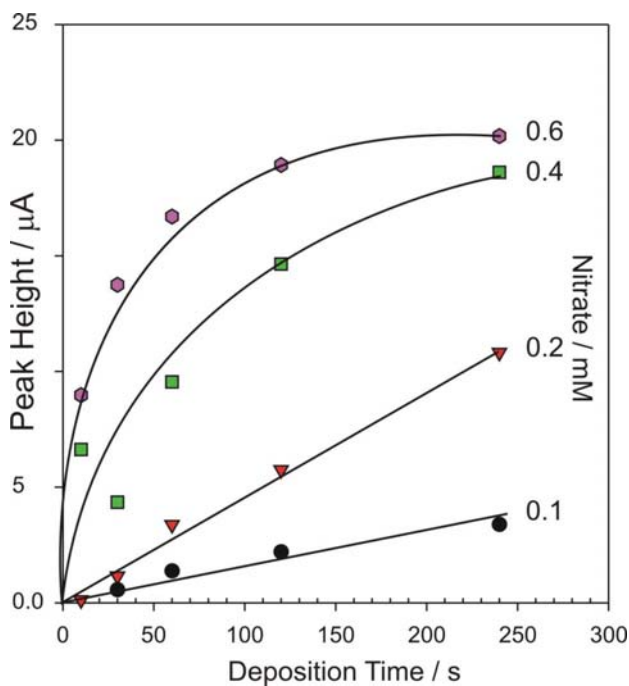
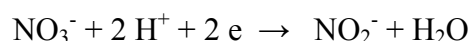

Figure 3-3: Influence of deposition time and nitrate concentration on the nitrite oxidation peak magnitude observed at a glassy carbon electrode in pH 3 electrolyte

As expected from the initial responses observed in **Figure 3-2**, the greater the duration of the electrode conditioning, the greater the magnitude of the nitrite signal. There is however a plateau profile in the response curves at long conditioning periods. This could be attributed to competitive depletion of the interfacial nitrite through a combination of diffusion to the bulk solution and the further reduction to ammonia [13]. The latter arises as a consequence of the redox duality of nitrite being both easy to

oxidise and reduce. This has been highlighted in previous studies in which copper was the used as the catalyst. The efficiency of the nitrate-nitrite electro-reduction-detection process was measured against the nitrite calibration data extracted from the data in **Figure 3-2**.

The influence of pH on the electro-reduction process was also examined. The electro-oxidation of nitrite can be achieved with relative ease across a wide pH spectrum (pH 3-8) with the peak potential found to exhibit a +65 mV shift per pH unit between pH 3 and 5 - becoming effectively independent of pH above this zone. The electrode responses to nitrite at pH 3 and pH 7 (dashed line) are compared in the inset within **Figure 3-2**. An interesting point to note is that upon reducing nitrate to nitrite – the nitrite oxidation potential is more positive when compared to the direct oxidation of nitrite (vertical dashed line, **Figure 3-2**) and is indicative of a pH shift at the electrode interface. While the bulk solution is pH 3, the electro-reduction process initiated at –1V will lead to the deposition of copper, the reduction of nitrate but also the reduction of protons. It is likely that the interfacial pH will increase as a consequence of the removal of protons through hydrogen evolution and as a consequence of the nitrate reduction ($2e, 2H^+$) and hence the shift in the nitrite peak position. This has consequences for the dynamic range over which the analytical method could be employed as the initial reduction process is dependent upon the presence of protons as per:



Thus, the increasing neutralisation of the interfacial zone will lead to the termination of the nitrate reduction process. This can be observed in **Figure 3-3** at high concentrations of nitrate and long conditioning periods in which the response plateaus. It could be expected that neutral or alkaline solution would also increase the propensity of the copper stripping process to yield copper oxide and copper hydroxide layers. The insolubility of such deposits could result in a loss of active electrode area through which the oxidation of nitrite can occur. It also prevents repetitive measurements given the degradation in reproducibility through cumulative build up oxide layers.

The adaptation of the approach to a purely amperometric system was then examined. A sequential three step potential waveform was adopted to facilitate copper deposition/nitrate electro-reduction (-1V, 240s) and the subsequent analysis of nitrite (+0.9V). An intermediate step (+0.4V) was introduced to enable the stripping of residual copper from the electrode prior to the oxidation of the nitrite. This was to avoid the ambiguities associated with two Faradaic processes commencing at +0.9 V immediately after the electro-reduction. Chronoamperometric data relating to the response observed at the glassy carbon electrode towards varying nitrate (0-1 mM) in the presence of 400 μM

copper is shown in **Figure 3-4**.

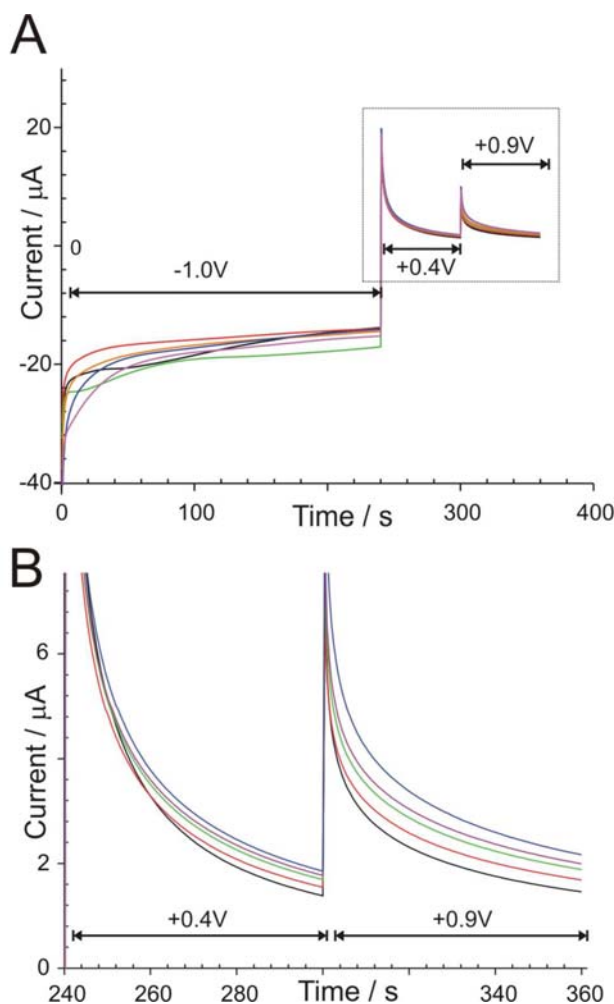

Figure 3-4: Three step chronoamperometric responses of a glassy carbon electrode towards increasing nitrate concentration in the presence of 400 μM Cu(II)

Closer inspection of the copper stripping process at +0.4 V reveals an unexpected twist in that the current can be seen to increase with increasing nitrate. The electro-generated nitrite is not oxidised at such low potentials (c.f. **Figure 3-2**). Had the electro-deposition of copper only served as a conduit for the electro-reduction of nitrate then it would have been expected that there would be little change in the amperometric profile observed at +0.4V step. If the nitrate was being chemically reduced by the copper with the corresponding production of cupric ion (corresponding to the 2e transformation of nitrate to nitrite) then it can be anticipated that the current would decrease in response to the presence of increasing nitrate as more copper is released.

However, the fact that the electrode was being maintained at -1 V would suggest that the majority would be re-deposited at the electrode and hence stripped at +0.4 V on the subsequent step. The net result would be a current profile that should be effectively independent of nitrate concentration. The alternative possibility is that the reduction of nitrate occurs through two 1e processes in which the Cu(I) ions are produced. The assumption being that the Cu(I) ions are not re-reduced at the electrode under the present conditions. Upon completing the deposition / electro-reduction step, the change to the +0.4V leads to an increase in the current beyond that normally expected as the interfacial Cu(I) is oxidised to Cu(II). This hypothesis is corroborated in the cyclic voltammograms shown in **Figure 3-2**. The Cu(I) oxidation is observed at +0.14 V and can be seen to increase with increasing deposition time.

The third step, +0.9V, results in the oxidation of the electro-generated nitrite back to nitrate. The current profile increases with increasing nitrate and provides a linear response over the range 0.2 mM-1 mM ($I / A = 6.97 \times 10^{-7} (\text{NO}_3^- / \text{mM}) + 7.78 \times 10^{-8}$, $R^2 = 0.922$, $N = 6$). As eluded to in the introduction, the core advantage is that measurement can be done without prior degassing of the sample. There are however a number of issues regarding this system. The most immediate is that fact that any endogenous nitrite will also be oxidised in the course of measuring the nitrate concentration. This can be overcome by imposing a fourth step (+0.9V) prior to commencing the three potential steps associated with the nitrate measurement. In doing so, the concentration of nitrite can be estimated and a suitable correction applied to the combined nitrate / nitrite signal. A second issue relates to the fact that a large positive potential is required to oxidise the nitrite and it could be envisaged that the application of such could induce the oxidation of other components within the sample (ie phenolic components of fulvic material).

This interference however could be overcome through the exploitation of the Cu(I) signal. In principle, the oxidation of Cu(I) to Cu(II) at +0.4V could be used as the analytical signal rather than direct nitrite oxidation at +0.9V with the less positive potential of the former avoiding the unwanted oxidation of other matrix constituents. The response, in the presence of increasing nitrate, is linear ($I / A = 4.46 \times 10^{-7} (\text{NO}_3^- / \text{mM}) + 6.92 \times 10^{-8}$, $R^2 = 0.869$, $N = 6$) and mirrors that of the direct nitrite oxidation. It could be argued that the ubiquity of copper ion within environmental samples may introduce some

interference should this analytical option be adopted. The amount of nitrite produced will be clearly be dependent upon the amount of copper deposited at the electrode (c.f. **Figure 3-3**) – the greater the concentration of copper ion at the deposition stage – the greater the copper deposit and hence, in principle, the more nitrate will be reduced. The concentration of endogenous copper ion in such instances is invariably at a level that would be insignificant when compared to the copper ion deliberately added to promote the nitrate conversion.

The methodology would appear to provide a number of new diagnostic handles through which nitrate could be measured but the experimental setup is utilised thus far is less than ideal in terms of transfer to a portable field device. A disposable strip design was proposed based on a carbon fibre – polymer composite. A scanning electron micrograph detailing the morphology of the carbon laminate structure is shown in **Figure 3-5**.

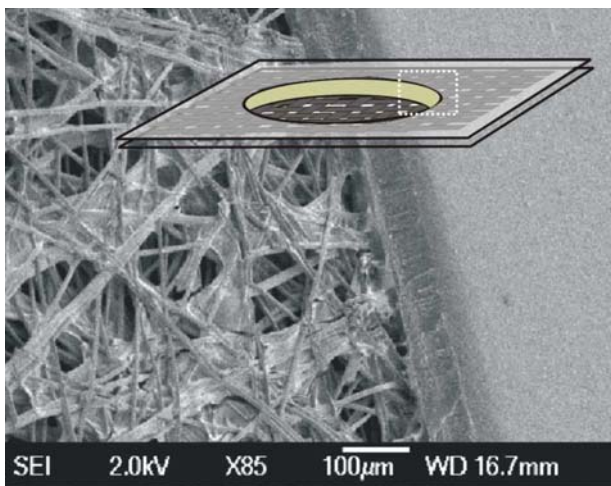

Figure 3-5: Scanning electron micrograph detailing the surface morphology of a laser etched carbon fibre composite sensor

The exposed carbon fibre provides a 3-dimensional network which acts as the sensing surface. The fibres have been demonstrated to possess superior electrode characteristics when compared to the screen printed systems traditionally associated with decentralised testing devices [78]. The high inherent conductivity of the underlying fibre network being significant in the present instance where resolution of the nitrite oxidation (+0.9V) from solvent decomposition is required. More importantly, it was hoped that the fibrous mesh would reduce the diffusional path of nitrite and hence facilitate a greater ability to capture electro-generated anion than the planar, glassy carbon. The

chronoamperometric responses to increasing nitrate (0.2 -1 mM, pH 3, 400 μM Cu(II)) obtained at a 1mm diameter carbon fibre disc are detailed in **Figure 3-6**. The response was linear for nitrate ($I / A = 4.58 \times 10^{-8} (\text{NO}_3^- / \text{mM}) + 1.86 \times 10^{-9}$, $N = 6$, $R^2 = 0.923$).

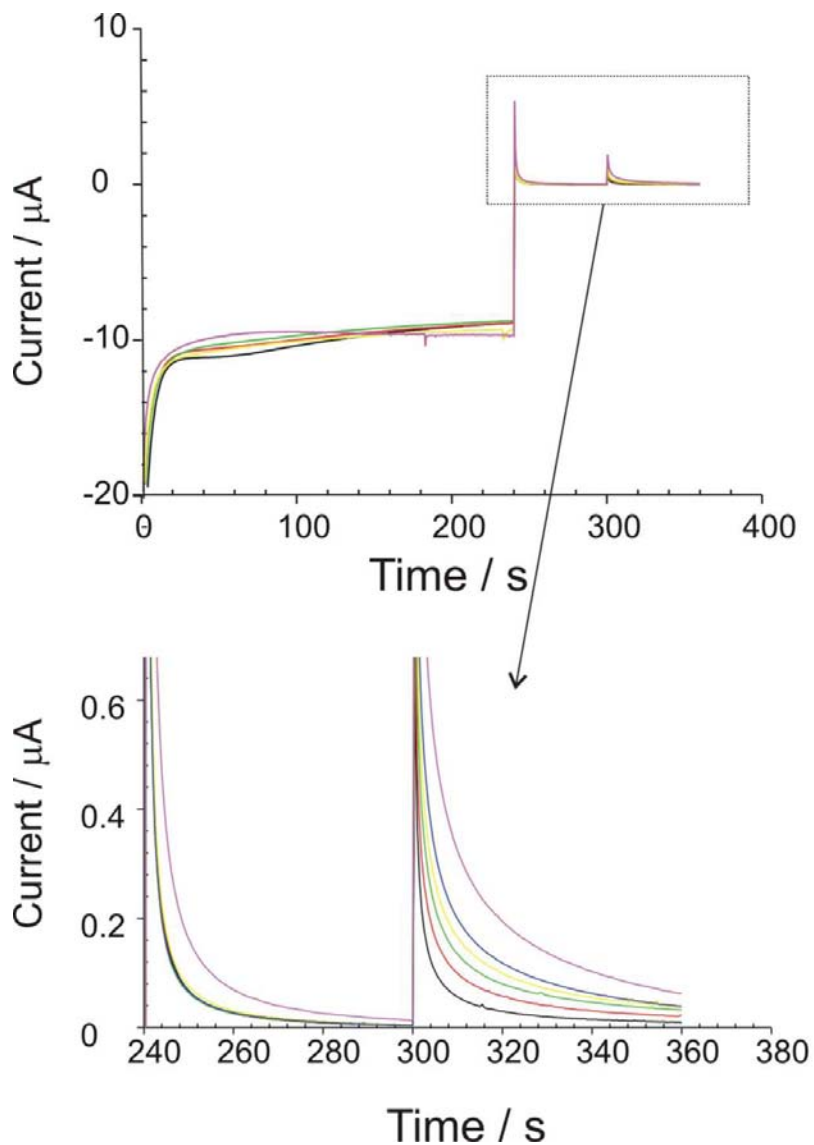
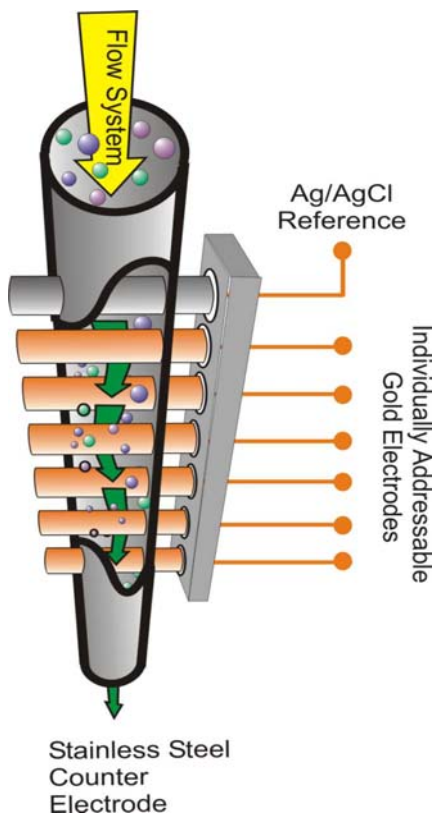

Figure 3-6: Three step chronoamperometric responses of the carbon fibre laminate electrode towards increasing nitrate (0-1 mM) concentration in the presence of 400 μM Cu(II)

3.7.1. Nano-Structured Cu-Au Flow Detector for Nitrate Analysis

The approach taken here exploits the former with the deposition of copper onto an “in-line” gold pillar flow detector. It is anticipated that the high surface area and reactive nature of the nano-structured deposit could be used as the catalyst for the electro-reduction of nitrate. The design of the flow sensor and the basic rationale that underpins the proposed analytical methodology is outlined in **Scheme 3-6**.



Scheme 3-6: Design of the generic gold electrode detector array

A prime consideration in the design of the detector was that it should be capable of direct integration within conventional flow systems but which avoids the expense and complexities associated with traditional chromatographic approaches to monitoring the anion..

Nitrite was chosen as the principal model analyte through which to test the initial operation of the flow sensors. This was partly due to its close association with nitrate chemistry – in terms of environmental significance and analytical detection. It was chosen partly as a consequence of the fact that it provides a more facile electrochemical behaviour than nitrate. This is borne out in the cyclic voltammograms of nitrite at a gold electrode in pH 3 electrolyte detailed in **Figure 3-7**. Well defined oxidation processes can be observed at +0.85V which increase linearly with increasing nitrite concentration (100 μ M additions). The response of the gold FIA system to nitrite was first optimised by examining the hydrodynamic peak response at various detection potentials. The results are summarised in **Figure 3-7** whereby it can be seen that the peak response plateaus after +0.85V which is consistent with the cyclic voltammograms detailed in **Figure 3-7**.

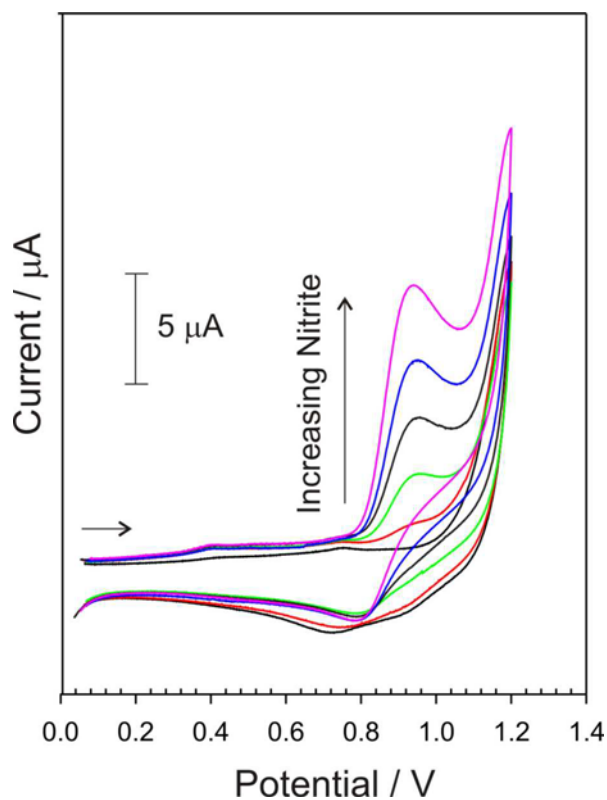

Figure 3-7: Cyclic voltammograms detailing the response of a gold disk electrode to 100 μ M nitrite (pH 3). Scan rate 100mV/s.

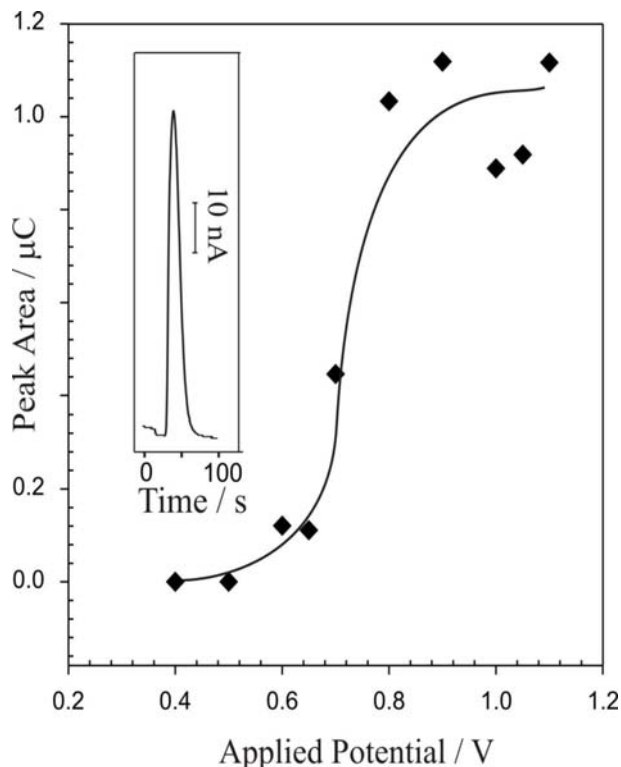

Figure 3-8: Influence of applied detection potential on the peak response to injections of nitrite (0.5mM) at the unmodified gold FIA detector. Inset. Typical response obtained at +0.9V

It is clear that there is little change in the voltammetric profile upon the addition of the anion and contrast to response to nitrite. In order to elicit a response to nitrate – it is necessary to modify the gold electrode within the array with a catalytic layer that will facilitate the reduction of nitrate. This was done through the *in situ* plating of the gold electrode with copper.

The typical peak response obtained at the gold FIA electrode operating at +0.9V is shown in the inset within **Figure 3-8**. A linear response to various injections of nitrite (0-1 mM) was observed which confirms the operational viability of the prototype flow system. Obtaining a response to nitrate however is significantly more challenging. Cyclic voltammograms detailing the response of a gold electrode to increasing concentration of nitrate (0-500 μM , pH 3), are shown in **Figure 3-9**

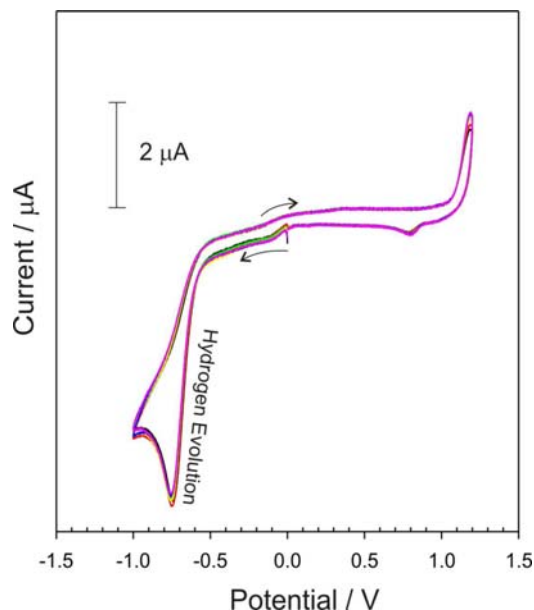

Figure 3-9: Cyclic voltammograms detailing the response of a gold disk electrode to 100 μM nitrate (pH 3). Scan rate 100mV/s.

This was achieved through simply changing the mobile phase within the flow system to one containing 0.05M copper sulphate [58]. This was passed through the array which was held at a potential of -1V. This has the effect of electro-reducing the cupric ion with the resulting deposition of copper directly at the electrode surface. Scanning electron micrographs detailing a cross section through one array which had previously modified with copper are shown in **Figures 3-10 A-C**. The deposition of copper within the flow channel leads to a granular, fractal like deposit which effectively coats the entire electrode. The coating was purposefully damaged within **Figure 3-10B** to expose the underlying gold pillar electrode. A more detailed examination of the copper micro/nano structure is shown in **Figure 3-10C**.

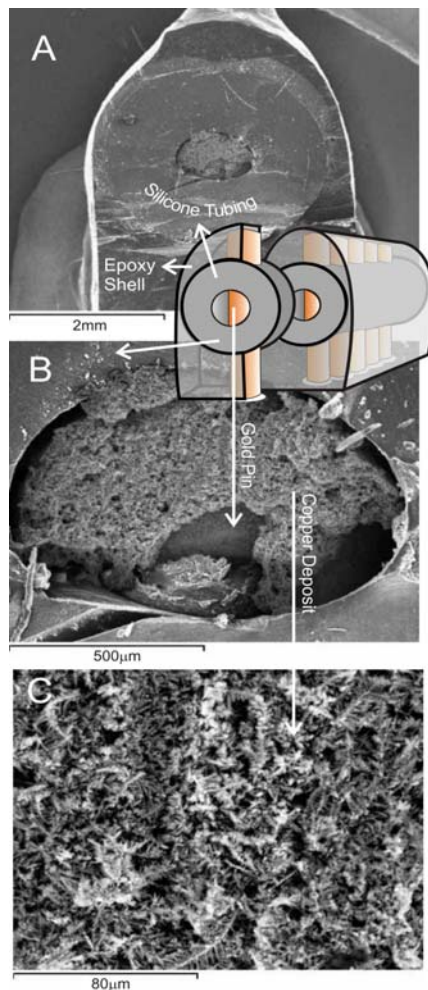

Figure 3-10: Electron micrographs detailing: A) cross-section overview of the FIA detector array, B) the detector channel, copper deposit and underlying pillar electrode and C) the nano-structured morphology of the deposit.

The initial response of the copper modified pillar electrode in the presence of electrolyte (0.1M Na₂SO₄ pH 3) with a detection potential of -0.8V is detailed in **Figure 3-11A**. The cathodic operating potential was based on previous studies of copper induced electro-reduction of nitrate. A large cathodic current is immediately evident from the chronoamperometric profile in **Figure 3-11A** and relates the presence of dissolved oxygen within the mobile phase. The macroporous copper electrode facilitates the reduction of oxygen and hence that large and somewhat noise background signal. Degassing the mobile phase by purging with nitrogen results in the steady decrease in the magnitude of the background current and noise level and can attributed to the steady removal of the oxygen interferent. The injection of nitrate into the system leads to a well defined peak response – similar, though opposite, to that observed with nitrite. The repetitive injections of 0.6 mM nitrate are shown in **Figure 3-11B**. It is important to note that no response was observed when injecting nitrate within the unmodified gold array and the response observed in **Figure 3-11B** is attributed to the interaction of the nitrate with the gold deposit highlighted in **Figures 3-11A-B**.

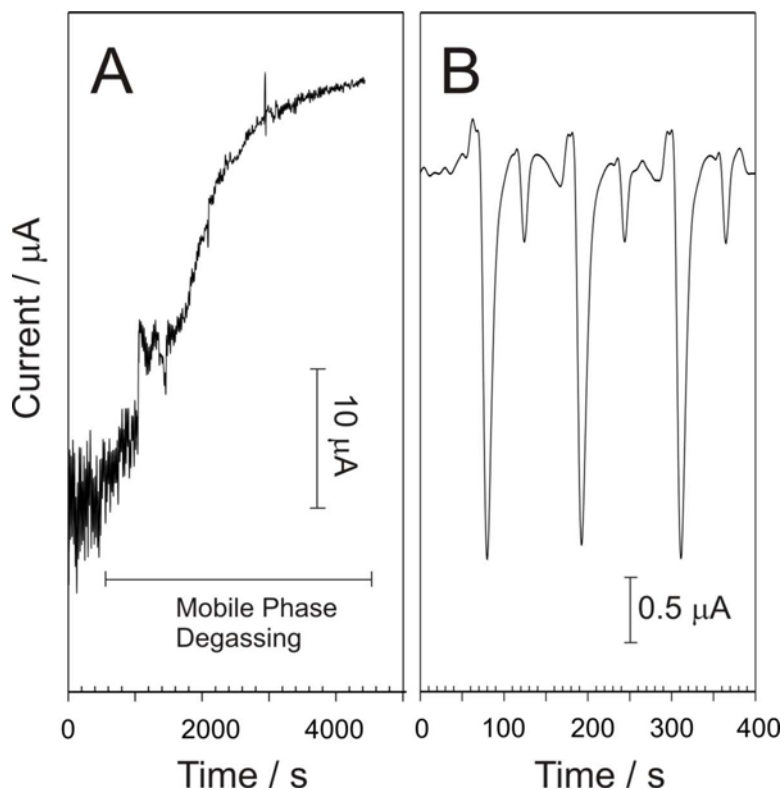

Figure 3-11: A) Chronoamperometric response obtained at the copper modified FIA detector – initially in the presence of air and with subsequent degassing. B) Repetitive injections of nitrate at the array after degassing. Detection Potential -0.8V

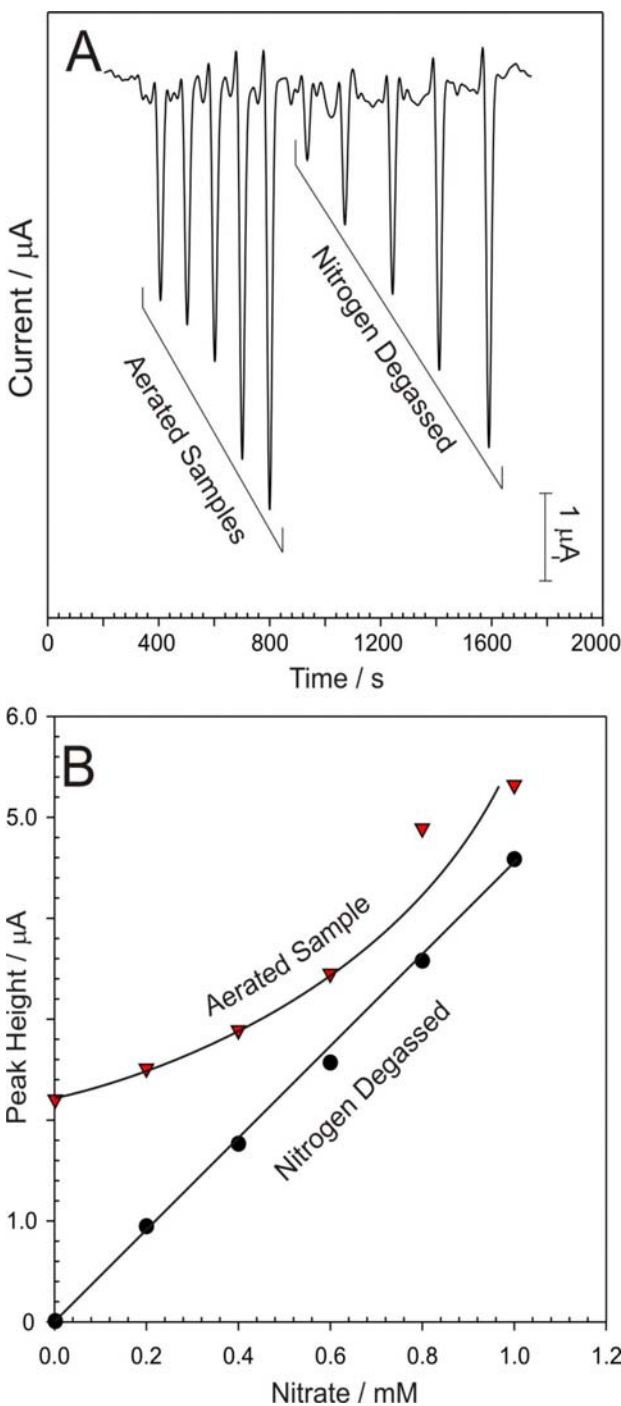

Figure 2-12: A) Influence of degassing of standard solutions on the nitrate (0.2mM increments, pH 3) peak response obtained at the copper modified detector. B) Quantitative comparison of aerated and degassed standard nitrate solution peak responses

The need for system degassing is an obvious limitation in terms of background noise as it is clear from the magnitude of the peaks observed in **Figure 3-11B** that these would be indistinguishable from the noise level initially observed within the aerated mobile phase. There is also another issue that must be addressed and relates the potential accuracy of any measurements conducted using the system. Calibration data obtained using a degassed flow system are shown in **Figure 3-12A**.

Increasing concentration of nitrate standards were injected and the peak responses observed (obtained at a detection potential of -0.8V). The first set of peaks were obtained without prior degassing of the standard solutions. The results from second set were obtained after degassing the standards. In both cases, the actual mobile phase was thoroughly purged of oxygen beforehand and subject to continuous nitrogen bubbling throughout the subsequent measurements.

There is a clear discrepancy between the two sets of data and relate again to the fact that dissolved oxygen

within the standards prior to injection will compromise the integrity of the measurement – particularly at low nitrate concentrations. A more quantitative evaluation is detailed in **Figure 3-12B**. The degassed standards provide a linear response (peak height = 4.45×10^{-6} ($\text{NO}_3^- / \text{mM}$) + 3.74×10^{-8} , $N = 5$, $R^2 = 0.997$) whereas the non degassed standards exhibit a significant non-zero intercept and a distinct curvature of the calibration line. It can be anticipated that the influence of dissolved oxygen is predominant at low nitrate concentrations – leading to a substantial (>100%) overestimation of the nitrate content.

3.8. Conclusions

The implementation of the three step waveform has been shown to offer a viable alternative to the more conventional electro-reduction strategies and can be easily transferred to a disposable format. The proposed methodology is straightforward in contrast to the more elaborate electrode modifications that have been investigated in recent years; it is inexpensive in comparison with biosensing designs and the disposable carbon-composite sensor platform could offer a more accurate system than the semi-quantitative colorimetric spot tests. It also utilises a more acceptable chemical assembly in that it avoids the need for cadmium metal – which is the common component of most spot test systems targeting nitrate.

The design of a simple gold array that can be easily incorporated with conventional flow systems has been described. While the response to nitrite is readily achieved at the bare gold, nitrate was found to require modification. This can be easily achieved through the in situ plating of the gold surface – by means of manipulating the mobile phase. The electrode system was found to respond to nitrate and provides a more green and accessible alternative than the conventional use of cadmium reductor columns. There is however an issue over the interference from dissolved oxygen and the investigations have shown that considerable caution is required if the basic system outlined here is to be used for the rigorous quantification of nitrate with authentic samples. Nevertheless, the system clearly provides a generic platform that can be modified and applied to the detection of analytes using both anodic and cathodic detection potentials.

3.9. References

1. Ward MH, deKok TM, Levallois P, Brender J, Gulis G, Nolan BT, VanDerslice J (2005) *Environmental Health Perspectives*, 113 1607-1614
2. Addiscott TM, Benjamin N, (2004) *Soil Use and Management*, 20 98-104
3. Archer DL(2002) *Journal of Food Protection*, 65 872-875
4. Fan AM, Steinberg VE (1996) *Regulatory Toxicology and Pharmacology*, 23 35-43
5. Lundberg JO, Weitzberg E, Cole JA, Benjamin (2004) *Nature Reviews Microbiology*, 2 593-602
6. The Nitrate Vulnerable Zones (Additional Designations) (England) (No. 2) Regulations 2002, Dept Environment and Rural Affairs, ISBN 0 11 042932 X, UK Government
7. Guidelines for Farmers in NVZs, Department for Environment, Food and Rural Affairs, 2002, PB 5505, UK Government
8. The Action Programme for Nitrate Vulnerable Zones (England and Wales) Regulations 1998, Department for Environment, Food and Rural Affairs, ISBN 0 11 079114 2. UK Government
9. Umar S, Iqbal M (2007) *Agronomy for Sustainable Development*, 2 45-57
10. Burgin AJ, Hamilton SK (2007) *Frontiers in Ecology and the Environment*, 5 89-96
11. Camargo JA, Alonso A, Salamanca A (2005) *Chemosphere*, 58 1255-1267
12. Wakida FT, Lerner DN (2005) *Water Research*, 39 3-16
13. Moorcroft MJ, Davis J, Compton RG, Detection (2001) *Talanta*, 54 785-803
14. Cruz C, Loucao MAM (2002) *J. Plant Nutrition*, 25 1185-1211
15. Kmecl V, Susin J, Zupancic-Kralj L (2005) *Accreditation and Quality Assurance*, 10 172-176
16. Sah RN (1994) *Communications in Soil Science and Plant Analysis*, 25 2841-2869
17. Mathews J E, George S, Mathews P, Mathai E, Brahmadathan K N, Seshadri L (2008) *Australian and New Zeland Journal of Obstetrics and Gynecology*, 38 407-410 Griess Test
18. Thabano JRE, Abong'o D (2004) *J. Chromatography A*, 1045 153-159
19. Raessler M, Hilke I (2006) *Microchimica Acta*, 154 27-29
20. Ito K, Takayama Y, Makabe N, Mitsui R, Hirokawa T (2005) *J. Chromatography A*, 1083 63-67
21. Rozan TF, Luther GW (2002) *Marine Chemistry*, 77 1-6
22. Connolly D, Paull B (2001) *Analytica Chimica Acta*, 441 53-62
23. Kapinus EN, Revelsky IA, Ulogov VO, Lyalikov YA (2004) *J. Chromatography B.*, 800 321-323
24. Butt SB, Riaz M, Iqbal MZ (2001) *Talanta*, 55 789-797
25. Burakham R, Oshima M, Grudpan K, Motomizu S (2004) *Talanta*, 64 1259-1265
26. Gal C, Frenzel W, Moller J (2004) *Microchimica Acta*, 146 155-164
27. Yue XF, Zhang ZQ, Yan HT (2004) *Talanta*, 62 97-101
28. Monser L, Sadok S, Greenway GM, Shah I, Uglow RF (2002) *Talanta*, 57 511-518.
29. Kazemzadeh A, Ensafi AA (2001) *Analytica Chimica Acta*, 442 319-326

30. WHO Guidelines for Drinking-water Quality, First Addendum to Third Edition, Volume 1 Recommendations, World Health Organisation, 2006, ISBN 92 4 154696 4
31. Vogel AI, Tatchell AR, Furnis BS, Hannaford AJ, Smith PWG, Vogel Textbook of Practical Organic Chemistry, Prentice Hall, 5 edition (6 Nov 1989), ISBN-10: 0582462363
32. Zhang JZ, Fisher CJ (2006) *Marine Chemistry*, 99 220-226
33. Guo Y (2006) *Bunseki Kagaku*, 55 765-771
34. Gou Y (2007) *Bunseki Kagaku*, 56 167-171
35. Nagaraja P, Kumar MH, Yathirajan H, Prakash J (2003) *Analytical Sciences*, 19 961-963
36. Lastra OC (2003) *J. AOAC International*, 86 1101-1105
37. Smyth GA, Matanovic G, Yi DH, Duncan MW, (1999) *nitric-oxide-biology and chemistry*, 3 67-74
38. Tsikas D, Gutzki FM, Frolich JC, (1992) *Fres.J. Anal. Chem.*, 342 95-97
39. Englmaier P (1983) *J. Chromatography*, 270 243-251.
40. Mitschke A, Gutzki FM, Tsikas D (2007) *J. Chromatography B.*, 851 287-291
41. Lohumi N, Gosain S, Jain A, Gupta VK, Verma KK (2004) *Analytica Chimica Acta.*, 505 231-237
42. Patton CJ, Fisher AE, Campbell WH, Campbell ER (2002) *Environmental Science and Technology*, 36 729-735
43. Dziedzic B, Mazanowska-Gajdowicz J, Walczewska A, Sarniak A, Nowak D (2003) *Clinica Chimica Acta*, 335 65-74
44. Gao L, Patterson EE, Shippy SA (2006) *Analyst*, 131 222-228
45. Miyado T, Tanaka Y, Nagai H, Takeda S, Saito K, Fukushi K, Yoshida Y, Wakida S, Niki E (2004) *J. Chromatography A*, 1051 185-191
46. Fukushi K, Nakayama N, Tsujimoto J (2003) *J. Chromatography A*, 1005 (2003) 197-205
47. Kikura-Hanajiri R, Martin RS, Lunte SM (2002) *Anal. Chem.*, 74 6370-6377
48. Le Goff T, Braven J, Ebdon L, Chilcott NP, Scholefield D (2002) *Analyst*, 127 507-511
49. Gallardo J, SAlegret S, del Valle M (2004) *Sensors and Actuators B*, 101 72-80
50. Perez MD, Marin LP, Quintana JC, Yazdani-Pedram M (2003) *Sensors and Actuators B*, 89 262-268
51. Fedurco M, Kedzierzawski P, Augustynski J (1999) *J. Electrochem. Soc.*, 146 2569-2572
52. Davenport RJ, Johnson DC (1973) *Anal. Chem.*, 45 1979-1980
53. Safonova TY, Petrii OAJ. *Electroanal. Chem.*, 448 (1998) 211-216
54. T. Ohmori, M.S. El-Deab, M. Osawa (1999) *J. Electroanal. Chem.*, 470 46-52
55. Welch CM, Hyde ME, Banks CE, Compton RG (2005) *Analytical Sciences*, 21 1421-1430
56. Ward-Jones S, Banks CE, Simm AO, Jiang L, Compton RG (2005) *Electroanalysis*, 17 1806-1815
57. Moorcroft MJ, Ne Li, Davis J, Compton RG (2000) *Analytical Letters*, 33 3127-2137
58. Davis J, Moorcroft MJ, Wilkins SK, Compton RG, Cardosi MF (2000) *Analyst*, 125 737-741

-
59. Wang Y, Qu JH (2006) *Water Environment Research*, 78 724-729
 60. Solak AO, Cekirdek P (2005) *Analytical Letters*, 38 271-280
 61. Shimazu K, Goto R, Piao SY, Kayama R, Nakata K, Yoshinaga Y (2007) *J. Electroanal. Chem.*, 601 161-168
 62. Shimazu K, Goto R (2002) *Chem. Letts*, 2 204-205
 63. da Cunha MCPM, De Souza JPI, and Nart FC (2000) *Langmuir*, 16 771-777
 64. Fogg AG, Scullion SP, Edmonds TE, Birch BJ (1991) *Analyst*, 116 573-579
 65. Paixo TRLC, Cardoso JL, Bertotti M (2007) *Talanta*, 71 (2007) 186-191
 66. Davis J, Moorcroft MJ, Wilkins SJ, Compton RG, Cardosi MF (2000) *Electroanalysis*, 12 1363-1367
 67. Fogg AG, Scullion P, Edmonds TE (1989) *Analyst*, 114 579-581
 68. Patolsky F, Katz E, Heleg-Shabtai V, Willner I (1998) *Chemistry-A European Journal*, 4 1068-1073
 69. Narvaez E, Dominguez I, Katakis E, Katz KT, Ranjit I, Ben-Dov I, Willner I (1997) *J. Electroanal. Chem.*, 430 227-233
 70. Ferreya NF, Solis VM (2004) *Bioelectrochemistry*, 64 (2004) 61-70
 71. Willner I, Katz E, Lapidot N, Bauerle P (1992) *Bioelectrochemistry and Bioenergetics*, 29 29-45
 72. Ferreyra NF, Coche-Guerente L, Labbe P, Calvo EJ, Solis VM (2003) *Langmuir*, 19 3864-3874
 73. Cui Y, Barford JP, Renneberg R (2006) *Analytical and Bioanalytical Chemistry*, 386 1567-1570
 74. Qua D, Shim JN, Kim JD, Park HS, Cha GS, Nam H (2005) *Anal. Chem*, 77 4467-4473
 75. Da Silva S, Shan D, Cosnier S (2004) *Sensors and Actuators B*, 103 397-402
 76. Xuejiang X, Dzyadevych S, Chovelon JM, Renault NJ, Ling C, Siqing X, Jianfu Z (2006) *Talanta*, 69 450-455
 77. DeAngelis KM, Ji PS, Firestone MK, Lindow SE (2005) *Applied and Environmental Microbiology*, 71 8537-8547
 78. Platts M, Smith RB, Mould N, Davis (2006) *Electrochem. Comm*, 8 633-637.

Chapter 4

Assessing Some Novel Approaches to Thiol Detection

Abstract

The versatility of using naphthoquinone as a rapid derivatising agent through which to trap reduced organosulfur species (RSH) was evaluated. The reaction proceeds through a nucleophilic addition leading to the production of the corresponding quinone-thiol conjugate. The quinone moiety provides a label that can be quantified using colorimetric, electrochemical and chromatographic means and offers a significant advantage over conventional thiol labelling agents. The reaction to sulfide (HS^-) has also been assessed and a disparity in response between the detection methods observed and a possible reaction pathway outlined. An alternative approach involving the use of an epoxide label system as the basis of a new approach to monitoring thiol species relevant to animal welfare contexts was also assessed. The system, like the naphthoquinone label, is shown to be selective for thiols but, in contrast to simpler labelling systems, could offer potential for speciation studies. The spectroscopic and electrochemical properties are explored and the possible reaction mechanisms elucidated.

The naphthoquinone work presented in this chapter has been accepted for publication within the Journal of Biochemical and Biophysical Methods and the industrial aspects considered within the Journal of Hazardous Materials. The epoxide label was presented in Electrochemistry Communications

4.1. Introduction

Reduced thiols (RSH) have many roles in nature and can have a Jekyll and Hyde personality in which they are protective to the body's processes on the one hand but can be deleterious in another. Glutathione is a tripeptide in which the central residue contains an SH functional group. This molecule serves as a potent cellular defence mechanism and is responsible for mopping up free radicals before they can do damage to the cellular machinery that is necessary for wellbeing. Homocysteine, is another biologically significant thiol but, rather than being protective, it has been speculated that it possesses a more malign role in which high concentrations have been associated with the onset of cardiovascular diseases. There are numerous other contrasting and contradictory examples of RSH function covering biomedical, environmental and industrial processes[1-6].

It is therefore little surprise that there is considerable interest in being able to monitor these compounds but their determination is problematic from both conventional spectroscopic and electrochemical perspectives. The thiols lack any well defined chromophore and are largely invisible to most direct uv or colorimetric assays. The electrochemistry is little better exhibiting slow electron transfer kinetics which leads to poor sensitivity and large detection potentials that can induce interference from other matrix constituents. The present chapter has sought to investigate two approaches that could counter both issues in a single step through labelling the thiol with a functional group that is highly visible to both spectroscopic and electrochemical detection. Two separate contexts are investigated – the first examines thiols from a industrial / environmental perspective, the second from a veterinary view on oxidative stress processes. Central to both sections is the need for rapid detection.

4.1.1. Environmental Analysis

Reduced sulfur compounds (RSH) are routinely found in a wide spectrum of effluents resulting from various industrial processes – particularly those associated with paper pulp and petroleum feedstock [1-4]. Their presence within such fluids and the

associated effluent presents an obvious environmental risk to ecosystems but also a considerable occupational hazard to those involved in handling such material both pre and post discharge[5,6]. While they tend to be characterised by particularly noxious odours – cumulative de-sensitisation of those workers directly exposed will inevitably compromise the perception of the latent hazard possessed by the effluent. There is a clear need to be able to characterise the sulfur composition in a more robust and quantitative process. Much effort has been expended in the development of technologies to monitor hydrogen sulfide [6-9] but little attention has been paid to other reduced sulfur components that can arise in the processing liquors. Such measurements can be problematic due to selectivity issues and the inherent reactivity of the reduced sulfur functionality where delays in sampling can lead to significant degradation in the more reactive moieties. The approach taken herein has sought to investigate the efficacy of labelling the latter – effectively trapping and thereby preserving the compound prior to analysis such that more accurate assessments of hazard could be made and false negatives minimised.

Numerous chemical derivatisation strategies have been developed that target the sulfhydryl (RSH) group and the more common reagents are summarised in **Table 4-1**.

Haloacetamides	FL
Maleimides	FL, ED
Benzoxadizoles	FL
Isoindoles	FL
Disulphide Exchange	UV-Vis
Dansylaziridines	FL

UV-Vis = Colorimetry
FL= Fluorescence
ED = Electrochemical Detection

Table 4-1: Common thiol labels and detection methodology

These have been reviewed and the various aspects of their chemistry has been discussed elsewhere [10]. The key points however are that they can vary widely in their ease of use, selectivity, expense and, in many cases, are designed for use in more specialised biochemical applications. The reaction of quinones with reduced sulfur functionalities are well established within synthetic contexts [11, 12]. The analytical exploitation of the

reaction as a possible label however has only recently been investigated and has been used for the detection of sulfide and various thiols of biomedical significance (principally cysteine, glutathione and albumin)[13-15]. The potential merits posed by the quinone label over the others outlined in Table 1 lies in the fact that it imparts a versatile functionality to the target that can serve as a chromophore and as a redox centre and, as such, is of considerable flexibility for spectroscopic or electrochemical detection. This is particularly true for the determination of alkyl sulfides which would otherwise be largely invisible to either methodology.

The approach advocated here has been to exploit the reaction of naphthoquinone (NQ) with reactive sulfur species (detailed in **Scheme 4-1**) to provide a liquid chromatographic label capable of either uv/vis or electrochemical detection. The basic reaction usually proceeds through a conventional 1,4-nucleophilic addition mechanistic pathway [11,12].

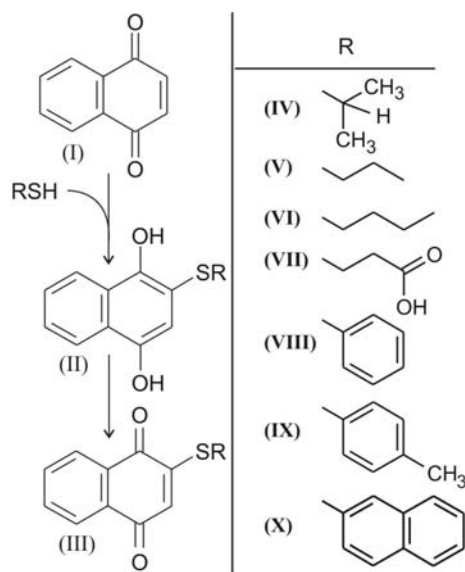

Scheme 4-1: Quinone labelling pathway and thiol derivatives prepared

The outcome is the covalent bond formation between quinone (I) and reduced thiol leading to the corresponding reduced form of the quinone-thiol conjugate (II) which, through a combination of intermolecular redox transition and aerobic oxidation, will be readily converted to the oxidised form (III). The potential benefits associated with the use of NQ relate to the fact that it is readily available, inexpensive, stable and soluble in both aqueous as well as non protic solvents. The investigation focused on elucidating the

nature of the reaction between label and target within a predominantly aqueous effluent environment and to explore the boundaries that define its applicability. As such, a number of novel quinone-thiol conjugates were prepared (**Scheme 4-1**) to serve as model reagents for the fundamental studies and the subsequent analytical assessment. A key aim was to develop a simple assay system that could be used for the speciation of a range of functionally disparate thiol targets and hence proffer a generic detection protocol for use in chromatographic detection.

4.1.2. Veterinary Diagnostics

Assessing animal welfare has risen to considerable importance in recent years given increasing public, media and regulatory concerns. Obtaining unambiguous measures of maltreatment however is contentious and, barring the presence of gross physical injury, can be highly subjective[16,17]. Cortisol measurements have been the main biochemical measure of “stress” but there are many limitations to their use and interpretation and there is a need for an alternative or a complementary system that could be used to monitor molecular level insults to the animal wellbeing[18,19]. Glutathione has emerged as a potential candidate given its application in the study of numerous human clinical conditions [20,21] and it could be anticipated that the underlying biochemical similarities would allow its extrapolation to animal contexts [22,23]. The approach taken in this instance is similar to that described above but rather than using quinones – a new class of label is exploited which results in the production of a quinone moiety. The central aim here was this new class of molecular label as potential contenders and elucidate the underlying reaction mechanisms involved in the detection processes.

The proposed system is based on an epoxide label which selectively reacts with the target thiol to yield a conjugate with unique spectroscopic and electrochemical properties (the quinone). The basic process is highlighted in **Scheme 4-2**. In contrast to previous studies involving quinone moieties, in the absence of the target thiol - the native indicator does not possess any native electrochemistry as the quinone component has been

removed by the presence of the epoxide functionality. Upon reaction with the target, a number of options can arise [24-26] and it is the objectives of the current investigation to identify those that predominate, assess selectivity and evaluate the use of the label as a quantitative measure of glutathione relative to conventional lab based procedures. A critical appraisal of its potential for being harnessed as the basis of a field test is also provided.

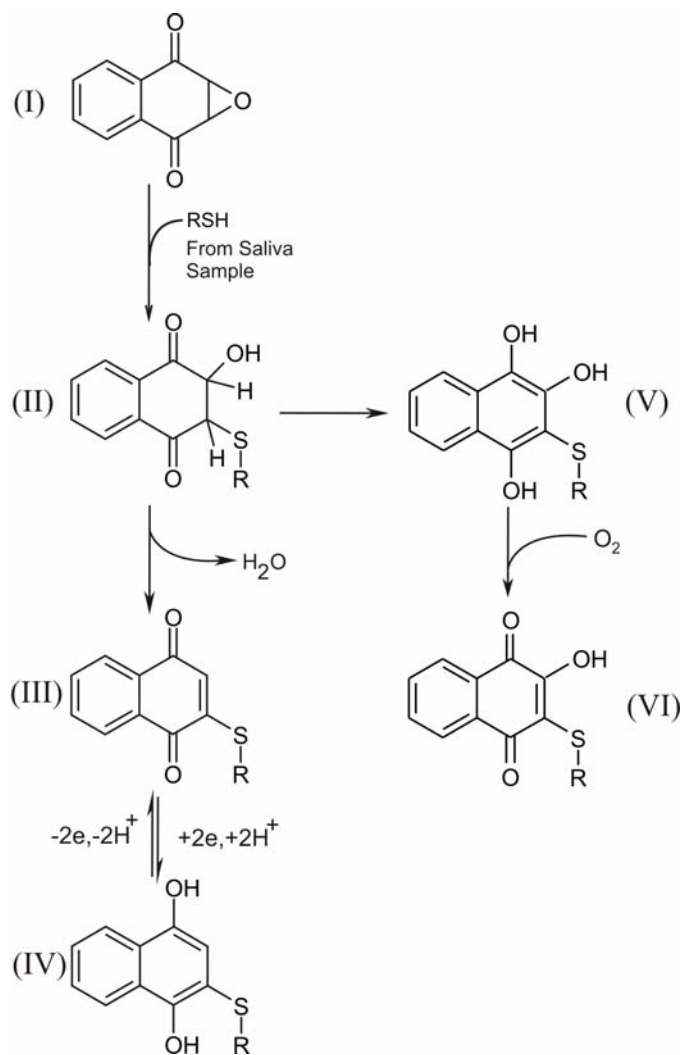

Scheme 4-2: Possible epoxide derivatisation pathways

4.2. Experimental Details

4.2.1. Methods and Materials

Electrochemical measurements were conducted using a μ Autolab type III computer controlled potentiostat (Eco-Chemie, Utrecht, The Netherlands) using a three electrode configuration consisting of a glassy carbon working electrode (3mm diameter, BAS Technicol, UK), a platinum wire counter electrode and a 3 M NaCl Ag | AgCl half cell reference electrode (BAS Technicol, UK). All measurements were done under nitrogen. NMR spectra were measured on a JEOL ECX 400 MHz spectrometer. Chemical shifts are reported in parts per million (ppm) downfield from tetramethylsilane (TMS). Mass spectra were recorded on a Micromass Platform LC-ESI-MS and a Micromass Quattro II. Flash chromatography was performed on 40–63 silica gel (Merck). All chemicals and solvents were bought from either Acros Organics or Sigma Aldrich and used without further purification. Chromatographic analysis was carried out in isocratic mode with an Agilent 1100 series HPLC system. An ODS 150 \times 4.6 mm Spherclone 3 μ m column (Phenomenex) was used throughout with a mobile phase consisting of 65/35 methanol / phosphate buffer (0.1 M, pH 7) at a flow rate of 1 mL / min. The detection wavelength in all cases was 250 nm. The concentration of total reduced thiols within horse saliva was obtained from a thoroughbred mare (14.5 years old) using commercial buccal type swabs before and after exercise. The analysis was performed using a conventional Ellman's assay procedure [15].

4.2.2. Chemical Syntheses

All the organic synthesis presented in this chapter was entired done by Dr Rob Smith

2-(Isopropylthio)-1,4-naphthoquinone (IV)

To a stirred solution of 1,4-naphthoquinone (1.58g, 10 mmol) in ethanol (40 mL) is added 2-propanethiol (0.93 mL, 10 mmol). The solution was stirred for 4 hours at room

temperature. The reaction mixture was taken to dryness under reduced pressure and the crude product purified by column chromatography using silica gel as adsorbent and chloroform as eluent. The pure product dried *in vacuo* to yield 2-(isopropylthio)-1,4-naphthoquinone (0.91g, 39.2%) as a brown solid.

^1H NMR (d- CDCl_3) δ 1.44 (s, 6H), 3.35-3.39 (m, 1H), 6.64 (s, 1H), 7.74 – 7.80 (m, 2H), 8.06 – 8.09 (m, 2H); ^{13}C NMR (d- CDCl_3) δ 22.05, 34.49, 118.72, 126.43, 126.83, 127.41, 131.93, 133.20, 134.23, 154.45, 181.62, 182.27; CI-MS (m/z) 233 $[\text{M} - \text{H}]^+$.

2-Propylthio-1,4-naphthoquinone (V) & 2-Butylthio-1,4-naphthoquinone (VI)

To a solution of 1,4-naphthoquinone (1.58g, 10 mmol) in ethanol (40 mL) is added either 1-propanethiol (0.90 mL, 10 mmol) or 1-butanethiol (1.07 mL, 10 mmol). The solution was refluxed at 100°C for 4 hours. The reaction mixture was poured into ice and filtered to leave a brown solid. This was recrystallised from boiling methanol with activated charcoal to yield 2-propylthio-1,4-naphthoquinone (0.51g, 22%) as orange crystals or 2-butyl-1,4-naphthoquinone (0.53g, 21.5%) as yellow crystals.

2-Propylthio-1,4-naphthoquinone

^1H NMR (d- CDCl_3) δ 1.08 – 1.12 (t, 3H), 1.77 – 1.81 (m, 2H), 2.79 – 2.82 (t, 2H), 6.59 (s, 1H), 7.69 – 7.73 (m, 2H), 8.06 – 8.08 (m, 2H); ^{13}C NMR (d- CDCl_3) δ 13.62, 20.82, 32.50, 126.45, 126.79, 126.91, 131.85, 132.12, 133.18, 134.24, 155.23, 181.51, 182.10; ESI-MS (m/z) 233 $[\text{M} + \text{H}]^+$.

2-Butylthio-1,4-naphthoquinone

^1H NMR (d- CDCl_3) δ 0.94 – 0.98 (t, 3H), 1.50 – 1.52 (m, 2H), 1.72 – 1.76 (m, 2H), 2.79 – 2.83 (t, 2H), 6.58 (s, 1H), 7.68 – 7.72 (m, 2H), 8.04 – 8.06 (m, 2H); ^{13}C NMR (d- CDCl_3) δ 13.50, 22.14, 29.26, 30.29, 126.42, 126.76, 126.89, 131.83, 132.11, 133.15, 134.20, 155.23, 181.44, 182.05; ESI-MS (m/z) 247 $[\text{M} + \text{H}]^+$.

(1,4-naphthoquinone-2-yl)-mercaptopropionic acid (VII)

A solution of 1,4-naphthoquinone (1.58g, 10 mmol) was in ethanol (40 mL) warmed until a clear yellow solution was obtained. 3-Mercaptopropionic acid (0.90 mL, 10 mmol) was added to the warm solution and the reaction proceeded with stirring for 4 hours at room temperature. The solution was removed under reduced pressure to leave a brown solid. Ethanol (20 mL) was added to the solution with hexane (100 mL) and the solution was placed in the fridge overnight. The reaction mixture was stirred at room temperature for 1 hour then filtered to yield (1,4-naphthoquinone-2-yl)-mercaptopropionic acid (1.98g, 75.5%) as yellow crystals.

^1H NMR (d_6 -DMSO) δ 2.65 – 2.69 (t, 2H), 3.11 – 3.12 (t, 2H), 6.77 (s, 1H), 7.81 – 7.86 (m, 2H), 7.95 – 7.97 (m, 2H); ^{13}C NMR (d_6 -DMSO) δ 24.76, 31.95, 126.03, 126.34, 127.28, 131.43, 131.68, 133.65, 134.74, 153.40, 172.48, 180.95, 181.83; ESI-MS (m/z) 262 [M – H].

2-(Phenylthio)-1,4-naphthoquinone (VIII)

To a solution of 1,4-naphthoquinone (1.58g, 10 mmol) in ethanol (40 mL) is added 4-thiophenol (1.02g, 10 mmol). The solution was taken to 100^oC with stirring for 4 hours. The reaction was poured into water and extracted into chloroform. The organic layer removed, dried with Na₂SO₄, filtered and the solvent removed under reduced pressure. The red solid was recrystallised from ethyl acetate to yield 2-(phenylthio)-1,4-naphthoquinone (0.65g, 24.7%) as red cubic crystals.

^1H NMR (d_6 -DMSO) δ 5.86 (s, 1H), 7.61 – 7.63 (m, 6H), 7.84 – 7.86 (m, 2H), 7.87 – 7.91 (d, 1H), 8.03 – 8.06 (d, 1H); ^{13}C NMR (d_6 -DMSO) δ 126.07, 126.45, 126.91, 127.54, 130.60, 130.77, 131.30, 131.60, 133.88, 134.86, 135.49, 155.54, 181.13, 181.55; CI-MS (m/z) 266 [M – H].

2-[(4-Methylphenyl)thio]-1,4-naphthoquinone (IX)

To a solution of 1,4-naphthoquinone (1.58g, 10 mmol) in ethanol (40 mL) is added 4-thiocresol (1.26g, 10 mmol). The solution was taken to 100°C with stirring for 4 hours. The reaction mixture was taken to dryness under reduced pressure and the crude product purified by column chromatography using silica gel as adsorbent and chloroform as eluent. The pure product was dried *in vacuo* to yield of 2-[(4-methylphenyl)thio]-1,4-naphthoquinone (1.60g, 57.1%) as a brown solid.

¹H NMR (d-CDCl₃) δ 2.79 (s, 3H), 6.47 (s, 1H), 7.65 – 7.67 (d, 2H), 7.76 – 7.78 (d, 2H) 8.06 – 8.08 (m, 2H), 8.36 – 8.38 (d, 1H), 8.47 – 8.49 (d, 1H); ¹³C NMR (d-CDCl₃) δ 21.49, 123.79, 126.59, 126.89, 128.19, 128.57, 129.87, 131.27, 131.84, 132.33, 133.39, 134.41, 135.66, 157.17, 182.07; CI-MS (*m/z*) 280 [M – H].

2-(2-Naphthylthio)-1,4-naphthoquinone (X)

To a solution of 1,4-naphthoquinone (1.58g, 10 mmol) in ethanol (40 mL) is added 2-naphthalenethiol (1.60g, 10 mmol). The solution was taken to 100°C with stirring for 4 hours. The solution was evaporated to dryness under reduced pressure and recrystallised from ethyl acetate and hexane with activated charcoal to yield 2-(2-naphthylthio)-1,4-naphthoquinone (2.02g, 64%) as orange shards.

¹H NMR (d-CDCl₃) δ 6.13 (s, 1H), 7.50 – 7.76 (m, 5H), 7.84 – 8.03 (m, 4H), 8.11 (s, 1H), 8.14 – 8.17 (m, 1H); ¹³C NMR (d-CDCl₃) δ 124.41, 126.52, 126.84, 127.09, 127.87, 127.91, 127.95, 128.37, 130.24, 131.01, 131.71, 132.22, 133.32, 133.72, 133.96, 134.35, 136.17, 156.63, 181.88, 182.10; CI-MS (*m/z*) 316 [M – H].

(1,4-Naphthoquinone-2,3-yl)-dimercaptopropionic acid (XI)

To a solution of (1,4-naphthoquinone-2-yl)-mercaptopropionic acid (0.80g, 3 mmol) in ethanol (20 mL) heated with 3-mercaptopropionic acid (0.90 mL, 10 mmol) at reflux for 2 hour until the solution was clear brown. The solution was allowed to cool to room temperature and a brown liquid was observed with no precipitation. The solution was

removed under reduced pressure to leave a brown solid. Ethanol (20 mL) was added to the solution with hexane (100 mL) and the solution was stirred overnight. The reaction mixture was filtered to yield 3,3'-(1,4-dihydro-1,4-dioxo-2,3-naphthylenedithio)di-propionic acid (0.48g, 42.8%) as a yellow powder.

^1H NMR (d_6 -DMSO) δ 2.65 – 2.69 (t, 2H), 3.11 – 3.12 (t, 2H), 6.77 (s, 1H), 7.81 – 7.86 (m, 2H), 7.95 – 7.97 (m, 2H); ^{13}C NMR (d_6 -DMSO) δ 24.76, 31.95, 126.03, 126.34, 127.28, 131.43, 131.68, 133.65, 134.74, 153.40, 172.48, 180.95, 181.83; ESI-MS (m/z) 366 $[\text{M} - \text{H}]^+$

2,3-Epoxy-1,4-naphthoquinone (Scheme 4-3 I)

Into a boiling tube (**A**) was placed 1,4-naphthoquinone (0.91 g, 5.8 mmol) and ethanol (10 mL) and the tube was heated until all the yellow solid dissolved. Into a second boiling tube (**B**) was added sodium carbonate (0.2 g), distilled water (5 mL) and cold 30% hydrogen peroxide (2 mL). Boiling tube **A** was placed under a cold tap until very slight crystallization occurred, then boiling tube **B** was added to **A** all in one go. With swirling boiling tube **A** was cooled in ice water which produced a white solid. The white solid was filtered using suction filtration and the solid was washed with water (3 x 10 ml) and air dried to yield 2,3-epoxy-1,4-naphthoquinone (0.39 g, 39%) as white crystals.

^1H NMR δ : 4.01 (s, 2H, C-H) 7.99–7.95 (m, 2H, Ar-H) 7.77–7.73 (m, 2H, Ar-H); ^{13}C NMR δ : 55.10, 127.02, 131.65, 134.57, 190.59. LCMS – ESI ($m-z$) 174 $[\text{M}-\text{H}]$

2, 3-Epoxy-2-methyl-1,4-naphthoquinone

Into a boiling tube (**A**) was placed 2-methyl-1,4-naphthoquinone (1.0 g, 5.8 mmol) and ethanol (10 mL) and the tube was heated until all the yellow solid dissolved. Into a second boiling tube (**B**) was added sodium carbonate (0.2 g), distilled water (5 mL) and cold 30% hydrogen peroxide (2 mL). Boiling tube **A** was placed under a cold tap until very slight crystallization occurred, then boiling tube **B** was added to **A** all in one go. With swirling boiling tube **A** was cooled in ice water which produced a white solid. The

white solid was filtered using suction filtration and the solid was washed with water (3 x 10 ml) and air dried to yield 2,3-epoxy-2-methyl-1,4-naphthoquinone (0.96 g, 88%) as white crystals.

^1H NMR δ : 1.78 (s, 3H, CH_3), 3.90 (s, 1H, C-H), 7.75 - 8.07 (m, 4H, Ar-H). ^{13}C NMR δ : 14.75, 61.40, 61.48, 126.88, 127.50, 132.01, 132.12, 134.47, 134.64, 191.84, 192.00. LCMS – ESI (m-z) 188 [M-H]

4.3. Results and Discussion

4.3.1 Evaluation of a Quinone Labelling Strategy

The spectroscopic profile of NQ (58 μM , pH 7) is detailed in **Figure 4-1**. Upon the introduction of a reduced thiol – a new absorption process typically emerges at 425 nm and corresponds to the formation of the conjugate indicated in **Scheme 4-1**. This process is exemplified in **Figure 4-1**

through the use of mercaptopropionic acid (14 μM additions) which although lacking a native chromophore, is easily identifiable subsequent to reaction with NQ. Mercaptopropionic acid (MPA) can arise through numerous chemical and biochemical pathways and is often the prominent thiol within pore water and organic rich sediments where anoxic environments predominate[27-29]. As such, it been used as the principal model thiol throughout the subsequent experiments. The identity of the conjugate was initially corroborated through comparing the synthetically

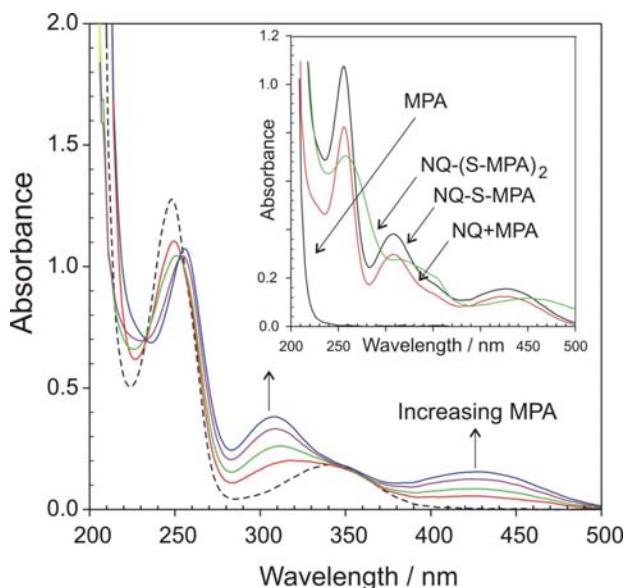

Figure 4-1: Absorption spectra detailing the reaction of 54 μM naphthoquinone (NQ) with increasing additions of mercaptopropionic acid (MPA, 14 μM). Inset: comparison of assay products with the spectra from synthetic mono and di-thiol conjugates.

produced mono and di-thiol conjugate absorption spectra (inset diagram, **Figure 4-1**) with that resulting from the assay.

The spectral profiles of the monothiol conjugate and assay mixture are in close agreement and it would suggest that the predominant product is indeed the former. Similar responses were recorded for the other thiols but, while it is clear that the use of NQ provides a quick and simple approach to attaching a visible label to otherwise invisible targets, there are a number of significant limitations. The sensitivity of the NQ-S-conjugate chromophore is relatively weak ($2586 \text{ L mol}^{-1} \text{ cm}^{-1}$) especially when compared with the commercially available ligands such as Ellman's reagent ($\sim 13,000 \text{ L mol}^{-1} \text{ cm}^{-1}$) [15,30] found in **Table 4-1**. The peak process also lies within a spectral region ($\lambda_{\text{max}} 425 \text{ nm}$) that is liable to be obscured, at least to some extent, by the coloured nature of the sample – whether natural or effluent. The common peak process also prevents direct speciation of the various components.

The great flexibility of NQ however means that it is also possible to interrogate the system using electrochemical techniques. This is where the system offers potential advantages over the predominantly spectroscopic systems detailed in **Table 4-1**. Cyclic voltammograms detailing the response of a conventional glassy carbon electrode to NQ (0.45 mM, pH 7) in the presence of increasing additions of MPA (90 μM) are shown in **Figure 4-2**. The reduction of the quinone is observed as a sharp peak at -0.2V with the corresponding oxidation at -0.1V. Upon the addition of the MPA to the solution, the magnitude of the NQ reduction process diminishes and a second peak process emerges at -0.25V. The latter corresponds to the cumulative formation of the conjugate.

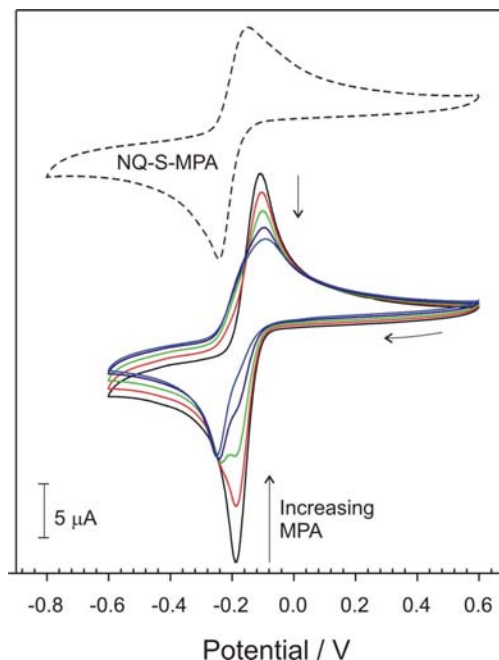

Figure 4-2: Cyclic voltammograms detailing the response of 0.45 mM naphthoquinone (NQ) to increasing additions of mercaptopropionic acid (MPA, 90 μM) in pH 7. The response to the synthetic mono-thiol analogue is included for comparison (dashed line). Scan Rate : 0.1V/s.

Confirmation of the latter was again provided by comparing the voltammetric response of the assay product to the purely synthetic conjugate (dotted line) where it can be seen that the peak positions are essentially identical. The main problem in attempting to exploit the reaction as an electroanalytical method for quantifying thiols within real samples however relates to the poor voltammetric resolution between the NQ indicator and the resulting conjugate. As in the case with direct spectroscopic analysis, similar voltammetric responses were obtained with the different thiols with only minor shifts in peak position (**Table 4-2**) compromising the prospect of speciation. It could however provide a simple method of measuring total reduced thiol content.

	R	t _R / min
(IV)	CH(CH ₃) ₂	8.45
(V)	CH ₂ CH ₂ CH ₃	9.79
(VI)	CH ₂ CH ₂ CH ₂ CH ₃	15.18
(VII)	CH ₂ CH ₂ COOH	1.9
(VIII)	C ₆ H ₅	13.35
(IX)	p- C ₆ H ₄ CH ₃	20.99
(X)	C ₁₀ H ₇	36.79

Table 4-2: Retention times (t_R) of the NQ-S-R derivatives

The NQ label clearly provides a versatile handle for both spectroscopic and electrochemical investigation but their scope is somewhat limited for the direct detection and identification of thiols in complex media. The true value of the NQ label is liable to lie in its incorporation within liquid chromatographic systems whereby column resolution of the various thiols can be complimented by post column detection that exploits either the NQ chromophore or its redox centre properties. The chromatographic profile detailing the reaction of MPA (32 μM) with NQ (0.8 mM) to yield the conjugate NQ-S-MPA is shown in **Figure 4-3**. A linear response was obtained with increasing concentrations of MPA (peak area = 21484 [MPA / mol L⁻¹] - 29.68; N = 6; R² = 0.994). The identity of the

peak was again confirmed by examining the response to the synthetic NQ-S-MPA conjugate (82 μ M, dotted line).

A small, transient peak was observed at 2.2 mins in **Figure 4-3** and has some significance in the elucidation of the reaction pathway. The peak is attributed to the formation of reduced naphthoquinone (naphthol, NQH₂) and arises as an intermediate in the conversion of the initial, reduced, conjugate to the more stable oxidised form (**Scheme 4-1, II**→**III**). This was again confirmed by comparison with commercially available p-naphthol (Sigma Aldrich). In the presence of excess NQ, the predominant product is the single substituted conjugate. It must be noted that while di-substitution is possible, it is likely that the kinetics of formation are significantly slower as a consequence of the steric hindrance

imposed by the initial derivatisation. There is a second influence on the nature of the substitution which leads on from the previous identification of reduced NQH₂ moieties within the assay. The initial reaction with the sulfur nucleophile results in the formation of the reduced form of the conjugate (**Scheme 4-1, II**). This is unreactive towards further addition until it is re-converted back to the oxidised form (**Scheme 4-1, III**) through interaction with dissolved oxygen or NQ electron acceptors. Excess NQ should therefore have a scavenging effect on the target thiol minimising the occurrence of a multi-product distribution. That the di-substituent was not formed under the assay conditions was confirmed by the bulk preparation of the derivative and its subsequent chromatographic characterisation. The peak (**Figure 4-3**, dashed line) displays a shorter retention time than

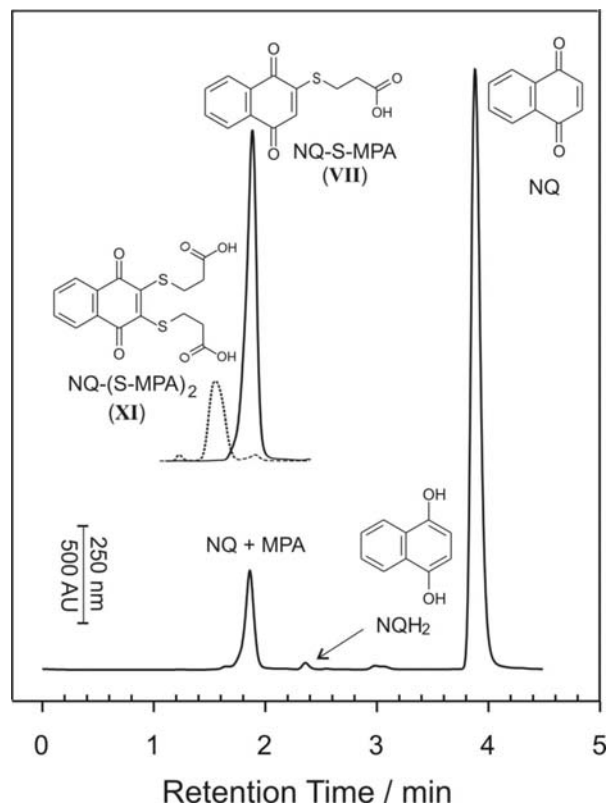

Figure 4-3: Chromatograms comparing the naphthoquinone (0.8 mM) -mercaptopropionate (32 μ M) assay conjugates to the synthetic analogues.

that of the mono substituted derivative, as expected, given the greater polarity afforded by the additional carboxyl group.

Similar reaction profiles were obtained for the other thiol derivatives (IV→X) outlined in **Scheme 4-1** but each possesses a markedly different retention time in keeping with the nature of the individual sulfur substituents. The variation in retention characteristic for each derivative is highlighted in **Table 4-2**. Speciation of the individual components is clearly possible. It can be argued that such resolution would have been obtained irrespective of whether or not the NQ label had been attached. The principal advantage of utilising NQ relates to the fact that, with the exception of the aryl derivatives, the majority will be invisible to conventional uv detectors.

The assay selectivity was assessed through examining the response to a range of organic functionalities. The nucleophilic potential of amino groups was thought to be the more likely interference given that reaction of amines with quinones is well established and known to occur through a common reaction pathway to that outlined in **Scheme 4-1** [11,12]. Providing the solutions are neutral (or subsequently buffered to pH 7), the nucleophilic character of the amino group should be significantly reduced through protonation as the pKa for most alkyl amines lies within the range of 10-11. Aryl amines, in contrast, should be more of a concern as their pKa can be significantly below that of the sample pH. A range of amines were tested covering both alkyl and aryl moieties (various amino acids, imidazoles and aniline derivatives in 100 fold excess, millimolar concentration) but were not found to illicit any appreciable reaction under the conditions and the initial timescale of the investigations [31]. Prolonged standing however is obviously problematic allowing the possibility of gradual reaction [32, 33].

The degree to which this could compromise the detection sensitivity of the target thiol will obviously depend on the nature of the interfering group and their associated retention characteristics. In the event of peak overlap, acidification of the solution directly after commencing the assay will significantly impede the reaction of both aryl and alkyl amino functionalities. Acidification also prevents reaction with thiols through the same process. It is important that the initial reaction solution is neutral and then acidified. The rationale is that such an approach will exploit the speed through which the

reduced sulfur group attacks the quinone allowing the introduction of a terminating acidic shot before any appreciable reaction with an amine occurs.

As the assay is selective for the reduced sulfur nucleophile, there should, in principle, be a reaction with hydrogen sulfide and its dissociated anion (HS^-). The reaction characteristics were however significantly different from that of the other thiols outlined in **Scheme 4-1**. A sequential decrease in the NQ peak was observed as expected yet no new peaks were observed in the chromatograms. Extending the run time to over 40 minutes did not uncover any new peaks. The discrepancy lies not in the fact that the product is not being detected in the uv range but rather that the product simply does not reach the detector. Upon the reaction of the sulfide with the quinone – secondary reactions occur that lead to the formation of oligomeric or polymeric products. A possible reaction pathway is highlighted in **Scheme 4-3**. Examination of the assay solution yielded evidence of a precipitate which, when collected and analysed by nmr spectroscopy, appears to confirm the presence of oligomeric products. The simple single addition product is not observed.

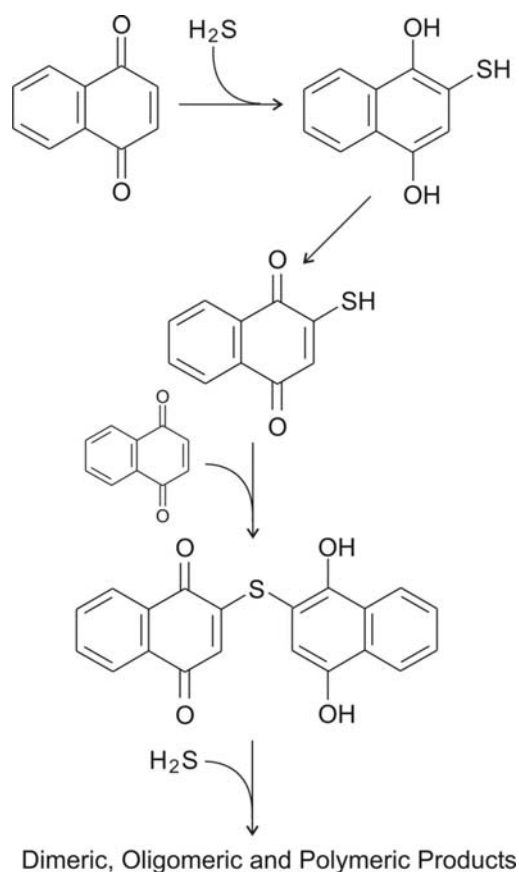

Scheme 4-3: Possible reaction pathway of sulphide in the presence of 1, 4-Naphthoquinone

The applicability of the overall approach was evaluated through recovery experiments of MPA from industrial receiving river water samples extracted from sources local to Nottingham. The recovery of 100 μM MPA using the HPLC NQ assay outlined above with detection at 250 nm yielded 96.3% ($N = 5$, %RSD = 5). There was no appreciable loss over the initial 24 hours following derivatisation effectively preserving the reduced sulfur components and minimising losses that would otherwise be attributable to air oxidation or volatilisation.

4.3.2. Evaluation of the Epoxide Labelling Strategy

The need for the development of on-site analysis kits or devices was highlighted by comparing the results obtained from equine saliva swabs sampled before and immediately after exercise. The swabs were divided into two batches - one batch being reacted with Ellman's Reagent on site - the other transported back to the lab without pre-treatment. The analysis was conducted using the standard Ellman's Reagent (ER) assay [15,30] and the results are detailed in **Table 4-3**. It can be seen that there is an appreciable difference between pre-and post exercise swabs reacted on-site. The concentration of thiol obtained from the untreated swabs was not detectable – even though the delay between sampling and analysis was less than 3 hours. The main drawback of the ER system however is the need for a portable spectrometer as the low concentrations prevent discrimination by simple visual inspection. This could be prohibitively expensive if considering mainstream use and is further hampered by the fact that it does not discriminate between the different thiols. It was hoped that the spectroscopic and electrochemical properties of the various epoxide intermediates (**Scheme 4-2**) may provide an advantage in terms of selectivity and sensitivity over the conventional assay systems such as ER.

Sample Category	Sample	RSH/ μM
Pre Exercise (Clean)	1	227,5
	2	242,9
Post Exercise (Clean)	1	178,4
	2	158,1

Table 4-3: Equine Saliva Swabs Analysed by Ellman's Assay

The spectroscopic properties of the system were briefly assessed through comparing the reaction to glutathione, cysteine and homocysteine. The uv-visible spectra relating to increasing concentrations of the respective thiol (0-200 μM) are compared in **Figure 4-4**. It can be seen that the profiles are markedly different with the cysteine generating a purple colour in contrast to the orange hues of glutathione and homocysteine. It is clear however from the cysteine profile that there are two distinct species ($\lambda_{\text{max}1} = 475 \text{ nm}$ and $\lambda_{\text{max}2} = 610 \text{ nm}$) and it is likely that these reflect the single substituted open-ring derivative (similar to that attainable by glutathione at $\lambda_{\text{max}} = 455 \text{ nm}$) and a second which is attributed to the ring closed intermediate. The spectra relating to glutathione exhibit no absorbance at the higher wavelength ($\lambda_{\text{max}2} = 610 \text{ nm}$).

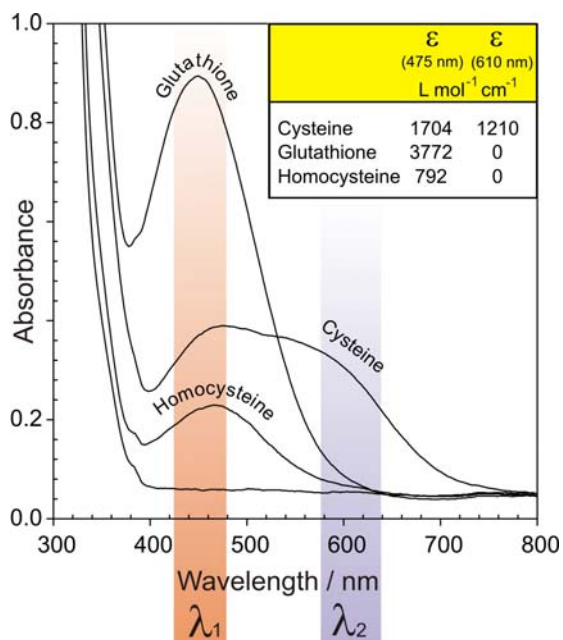

Figure 4-4: UV-Vis spectra detailing the epoxide response towards the glutathione, cysteine and homocysteine, (200 μM , pH 7). Inset: Molar absorptivity data

It is possible therefore to consider that in a mixture of the two it could be possible to determine the respective concentration of both systems through conventional two

component multi-parametric analysis. The assays were repeated with the methyl epoxide derivative. In contrast to the unsubstituted derivative there was no purple coloration upon the addition of cysteine with little difference observed in the spectroscopic profile between the different thiols. As such it was not investigated further.

Two possible reaction routes (I-II-III-IV and I-II-V-VI) were presented **Scheme 4-2**. Previous spectroscopic studies based on the reaction of naphthoquinone [12] and naphthoquinone bromide [33] with either glutathione or cysteine would be expected to lead to the production of derivatives identical to those postulated in **Scheme 4-2** III and **Scheme 4-2** IV. However, the spectroscopic profile from those reactions failed to match the products resulting from the epoxide-glutathione or epoxide-cysteine. There was no purple colouration upon the reaction of naphthoquinone with cysteine and stands in marked contrast to the profile observed in **Figure 4-4**. In addition, the naphthoquinone-glutathione conjugate yield a species with a λ_{max} of 420 nm [12,33] and not the 455nm shown in **Figure 4-4** for the epoxide system. It would appear that route V-VI in **Scheme 4-2** is predominant though it must be noted that it is unlikely to be the sole process under the assay conditions and a competitive mixture is inevitable. That the reaction yields a number of products was corroborated by examining the product spread through HPLC analysis (not shown). While it is not possible to conclusively identify the various moieties – there were at least three defined products in the chromatograms irrespective of which thiol was used as a probe which indicates the viability of both routes.

The selectivity of the epoxide system towards other physiological species was also assessed using the spectroscopic assay and HPLC systems and there was found to be no reaction to 0.2 mM lysine nor 0.2 mM histidine under the timecourse of the reaction. The reaction of such species with epoxides are well recognised [34] but providing the analysis is done within 30 minutes under ambient conditions there are no appreciable interferences. There was however a response to homocysteine ($\lambda_{\text{max}} = 475$ nm) but the profile mirrored that of glutathione. Similarly, N-acetylcysteine ($\lambda_{\text{max}} = 475$ nm) mimicked the glutathione response in deference to the purple coloration apparent with cysteine. This provides some additional evidence indicating that the unprotected primary

amino is required and that it is the extra stability inherent to the six-member ring that is responsible for the variation in colour. The molar absorptivities of the various components at the different wavelengths are compared in **Table 4-4** (inset **Figure 4-4**). In all cases it can be seen that the intensity is markedly less than Ellman's Reagent ($\epsilon = 13,600 \text{ L mol}^{-1} \text{ cm}^{-1}$). Again, visual discrimination between the different thiol concentrations could not be achieved – the main strength of the proposed system, from a spectroscopic viewpoint, clearly lies in the potential for instrumental speciation based on the two component analysis.

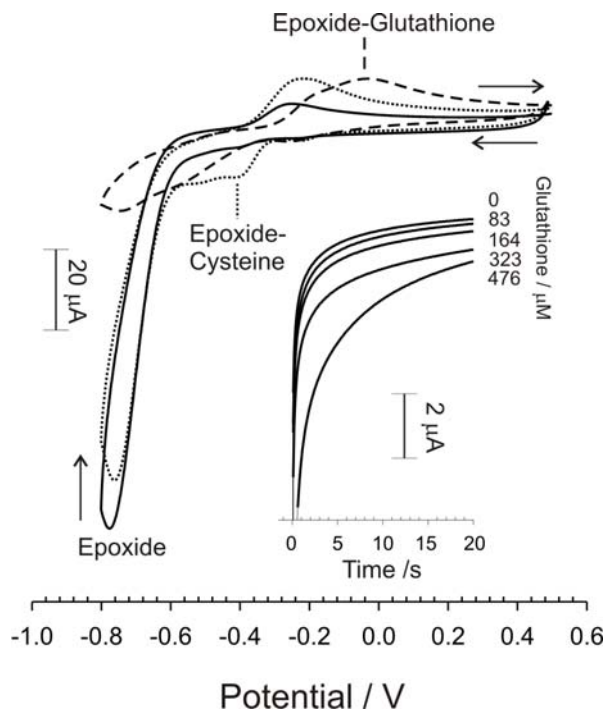

Figure 4-5. Cyclic voltammograms detailing the response of a glassy carbon electrode towards the epoxide epoxide (455 μM , pH 7) in the presence of cysteine and glutathione (178 μM , pH 7). Inset: chronoamperometric responses to increasing glutathione (-0.6V in air)

The electrochemical properties of the epoxide system were investigated as a means of countering the intensity deficiencies of the spectroscopic systems and provides a technological solution that would be more amenable to device development. Cyclic voltammograms detailing the response of a glassy carbon electrode to cysteine and glutathione (both 178 μM) in the presence of the epoxide (455 μM , pH 7) are compared in **Figure 4-5**. In the absence of any thiol there is a single reduction at -0.75V which corresponds to the reduction of the epoxide itself. There is an oxidation peak on the reverse scan indicating that the ring has been opened to yield the corresponding quinone. Upon the addition of thiol however a second reduction process is observed whose position is dependent upon the nature of the conjugate being formed.

In common with the spectroscopic results, different profiles are obtained with the cysteine assay yielding two reduction peak processes indicating the presence of two conjugates representing the ring-opened and ring-closed derivatives [35]. The glutathione

conjugate provides a single broad reduction process at potentials more negative than the initial cysteine reaction product (-0.55V vs -0.4V respectively).

The use of simple naphthoquinones for the electrochemical detection of thiols is well established and possess the advantage of being relatively insensitive to common physiological species [12,35,36]. The main problem with developing an amperometric system based on naphthoquinone relates to the fact that in any true field test, the measurement would be done in air – re-oxidation of the quinone by dissolved oxygen in the sample could introduce further ambiguities through changing the relative concentrations of the oxidised and reduced forms. Such irreproducibility would effectively negate the diagnostic value. This is a common problem with applying potentiometric naphthoquinone based systems outwith the controlled lab environment [12].

The great strength of the epoxide label relies upon the generation of the oxidised form with the subsequent measurement based on the reduction of an analyte that can only arise as a consequence of reaction with a thiol. As such, a positive signal should be acquired upon the introduction of the thiol. In principle, the target analyte should be insensitive to dissolved or ambient oxygen. The application of a measurement potential sufficient to reduce the oxidised form the conjugates but not the epoxide itself could therefore be utilised as the analytical signal. Chronoamperometric responses (**Figure 4-5**: Inset) were measured at a fixed potential of -0.6V using a glassy carbon electrode without degassing. The current was extracted at 20s and a linear relationship to glutathione was obtained (Response / A = 2.53×10^{-3} [GSH/mol L⁻¹] + 3.94×10^{-8} ; N = 5; R² = 0.992). There is a crucial assumption in the previous relationship in that glutathione is the predominant thiol species but, in any real sample, there would be an obvious contribution from the other thiol species – mono and macromolecular. It could be anticipated that lowering the detection potential to -0.4V would enable the selective measurement of cysteine as there is no appreciable signal to glutathione and as such – with further refinement could be used to provide a degree of speciation.

4.4. Conclusions

Naphthoquinone has been shown to be a selective and highly versatile label for the trapping and subsequent analysis of reduced thiol functionalities. The reaction pathway has been investigated and the identity of the products and intermediates confirmed through comparison with their synthetic analogues. The assay has comparable detection sensitivity (sub micromolar concentrations in aqueous solution across spectroscopic, electrochemical and chromatographic assays) with a more elaborate mercuric trapping system [4] but possesses greater method flexibility, is inexpensive, avoids issues over reagent handling and can be conducted using conventional analytical systems. The analytical characteristics of the system have been critically appraised and the applicability of the approach demonstrated through the analysis of receiving water samples.

The epoxide system investigated lays the foundation of a new approach that could address many of the shortcomings inherent to the simple naphthoquinone systems and could promote a productive avenue for the development of the technology. The epoxide system is especially relevant when considering application outside the controlled environment of the lab. The animal welfare is an obvious application as there is at present, a clear conflict between subjective measures that can be taken at the scene and objective measures that require a time delay between collection and the results being available. Such delays may render the investigation redundant as the slaughter of the animal or export may occur before the results are retrieved. An objective test that can provide immediate *in-situ* results is therefore a much-needed development in the monitoring of animal welfare standards.

4.5. References

1. Sheu S H, Weng H S (2001) *Water Research*, 35 (2001) 2017-2021
2. Bordado J C M, Gomes J F P (2002) *Chem. Eng. Proc*, 41 667-671
3. Sharipov A K (2004) *Petroleum Chem*, 44 1-7
4. Bramanti E, D'Ulivo L, Lomonte C, Onor M, Zamboni R, Raspi G, D'Ulivo A (2006) *Anal. Chim. Acta*, 579 38-46
5. Hendrickson R G, Chang A, Hamilton R J (2004) *Am. J. Ind. Med.*, 45 346-350
6. Lawrence N S, Davis J, Compton R G (2000) *Talanta* 52 771-784
7. Lawrence N S (2006) *Electroanalysis*, 18 1658-1663
8. Robinson K L, Lawrence N S (2006) *Electrochem Comm*, 8 1055-1061
9. Lawrence N, Tustin G J, Faulkner M, Jones T G J (2006) *Electrochim. Acta*, 52 499-503
10. Shimada K, Mitamura K (1994) *J. Chrom. B*, 659 227-241
11. Patai S (Ed), *The Chemistry of the Thiol Group, Part 1* (1974) Wiley
12. Patai S (Ed) *The Chemistry of the Thiol Group, Part 2* (1974) Wiley
13. Digga A, Gracheva S, Livingstone C, Davis J (2003) *Electrochem. Comm*, 5 732-736
14. Yonge L, Gracheva S, Livingstone C, Davis J (2004) *J. Am. Chem. Soc.*, 126 7732-7733
15. Gracheva S, Livingstone C, Davis J (2004) *Anal. Chem*, 76 3833-3836
16. Clark J D, Rager D R, Calpin J P (1997) *Laboratory Animal Science*, 47 586-597
17. Cockram M S (2004) *Animal Welfare*, 13 283-298
18. Lane J (2006) *Animal Welfare*, 15 331-342
19. Pearson B L, Judge P G, Reeder D M (2008) *American Journal of Primatology*, 70 1145-1151
20. Livingstone C, Davis J (2007) *British Journal of Diabetes and Vascular Diseases*, 7 258-265
21. Lang C A, Mills B J, Mastropaolo W, Liu M C (2000) *Journal of Laboratory and Clinical Medicine*, 135 402-405
22. Williams C A, Gordon M E, Betros C L, McKeever K H (2008) *Journal of Animal Science*, 86 576-583
23. Frankiewicz-Jozko A, Szarska E (2000) *Biology of Sport*, 17 217-222
24. Chen Q, Doss G A, Tung E C, Liu W, Tang Y S, Braun M P, Didolkar V, Strauss J R, Wang R W, Stearns R A, Evans D C, Baillie T A, Tang W (2006) *Drug Metabolism and Disposition*, 34 145-151
25. Kalgutkar A S, Henne K R, Lame M E, Vaz A D N, Collin C, Soglia J R, Zhao S X, Hop C E C A (2005) *Chemico-Biological Interactions*. 155 10-20
26. Kamenjicki M, Asher S A (2005) *Sensors and Actuators B*, 106 373-377
27. Vairavamurthy M A, Goldenberg W S, Ouyang S, Khalid S (2000) *Marine Chem*, 70 181-189

-
28. Dyrssen D, Haraldsson C, Westerlund S, Aren K (1985) *Marine Chem.*, 17 323-327
 29. Vairavamurthy M A, Manowitz B, Maletic D, Wolfe H (1997) *Org. Geochem.*, 26 577-585
 30. Ellman G L (1959) *Arch. Biochem. Biophys.* 82 70-77
 31. Smith R B, Canton C, Lawrence N S, Livingstone C, Davis J (2006) *New J. Chem.*, 30 1718-1724
 32. Bittner S (2006) *Amino Acids*, 30 205-224
 33. Srivastava V K, Kaushik N K, Khera B (1987) *Synth. React. Inorg. Met.-Org. Chem.*, 17 15.
 34. Lobo G A M, Chitre S A, Rathod S M, Smith R B, Leslie R, Livingstone C, Davis J (2008) *J. Chromatography B - Biomedical Applications*. 864 173-177
 35. Newman J W, Hammock B D (2001) *Journal of Chromatography A*, 925 223-240
 36. Stone C G, Cardosi M F, Davis J (2003) *Anal. Chim. Acta.* 491 203-210
 37. White P C, Lawrence N S, Davis J, Compton R G (2002) *Electroanalysis*. 14 89-98

Chapter 5

A Composite Approach to Detecting Neurotransmitters and their Metabolites

Abstract

Suicide is an ever present concern in healthcare provision and with over 1 million fatalities attributed to this cause each year – it is a problem that is continually seeking a solution. A key issue is the identification of those individuals at risk such that effective interventions can be employed. It has long been acknowledged that there are significant differences in the neurochemical picture of those suffering from suicidal ideation and normal individuals. Analytical techniques have been widely used to elucidate the various pathways involved in the neurochemistry of depression and suicide with the aim of developing more effective treatments. There is, however, a clear opportunity for exploiting the advances made in those previous investigations as the foundation for the development of screening assays that, through measuring the variations in neurochemical composition, could offer a more objective assessment of suicide risk. The present chapter gives an overview of the various species involved in suicidal behaviour, their significance to risk assessment and introduces the development of a lasered composite electrode for the determination of 5-hydroxyindoleacetic acid – a breakdown product of serotonin whose concentration has been shown to be significantly decreased in those with a propensity towards suicidal ideation.

The work in this chapter has been accepted for publication within:

Trends in Analytical Chemistry

5.1. A New Direction

The previous chapters have introduced flow injection and liquid chromatographic analysis but in both cases the detection assembly relied upon on the use of conventional electrode materials to detect the target analyte. The latter was found to be generally unresponsive at the unmodified electrode surface and, as such, the detection strategy had to be adapted to counter either the poor selectivity or sensitivity or the combination of both. This involved the modification of the electrode (gold-copper nano deposit) or the target analyte (derivatisation with a quinone or epoxide). In a positive light it could be said that these options highlight the versatility of the electroanalytical system as demonstrated by the overview in Chapter 1. However, the complexity involved in the adaptation is clearly a disadvantage and could easily be taken as a barrier to adoption. The following chapters have sought to take the technology forward by employing composite technology in a form that provides a much more accessible means of obtaining engineered substrates that can have a high activity towards the specified target. Each chapter seeks to explore a generic approach but with a different context. The start of the composite section of the work explores a possible application for which electroanalytical detection could be well suited.

5.2. Background

Suicide is an age-old concern in healthcare provision and there has been extensive research in relation to the treatment of the underlying problems and many studies have subsequently been translated to clinical practice. Treatment, however, is usually instigated where the patient is either demonstrating gross symptoms or has subsequently failed in a suicide attempt. Identifying those at risk of progressing from, what may outwardly appear to be, a manageable depressive episode to deliberate self harm is much more problematic and is, more often than not, reliant on the observational and deductive experience of the General Practitioner [1, 2]. The subjective element of such assessments can be compromised by a number of factors – the two most common being: the

willingness of the patient to participate in a dialogue with the GP and the time available in a given consultation. There has been a substantial effort to elucidate the neurochemical basis of depression and suicide. In the past, the aim has been largely focused on utilising the resulting information as the basis for developing new drug mediated treatment regimes; the exploitation of those same investigations as a more objective means of assessing suicidal risk has however recently gathered a more concerted interest within the biomedical community. The present chapter provides a brief overview of the neurochemistry that relates to suicidal intent, identifies advances that have been made in the analysis and detection of those neurochemical markers associated with suicidal intent. It critically assesses the application of a polymer-carbon composite electrode system for the detection of the neurotransmitter metabolites. The ultimate aim being to develop more accessible and accurate measurement systems capable of providing a more robust assessment of the potential applicability of the metabolites as indicators for suicide prevention.

5.3. Suicide Statistics

It has been estimated by the World Health Organisation (WHO) that the annual suicide rate exceeds 1 million in global terms but this is a relatively shallow statistic as it does not include attempted suicides - estimated at 20 for every fatal suicide. In 2005, in the United States alone (WHO Regional Statistics), there were 32,637 reported suicides but again this provides no indication as to unsuccessful attempts requiring medical assistance nor those that may go unreported. In previous years, it has been generally accepted that those within the more elderly section (typically 75+ yrs) of the population were at the highest risk of suicide accounting for 65.8 suicides per 100,000 of that cohort [3]. This has changed in recent years with younger people found to be at greater risk. According to the World Health Organisation, 55% of all suicides are now aged between 15 to 44 years, with suicide being among the three leading causes of death for this age group worldwide [3].

There is also a gender divide, with more males committing suicide compared to females. In the UK, in 2006, the suicide rate for males and females was 17.4 and 5.3 respectively per 100,000 population. This is matched by figures from the United States which, in 2005, for males and females was 17.7 and 4.5 respectively per 100,000 population. Despite these figures, women attempt suicide more often than men but the latter are clearly more successful. The difference in suicide rates between the genders has been a common theme throughout recent years but it can also vary between the various age groups and in regional contexts and may reflect differing socio-economic and cultural factors. One example highlighting such disparity can be extracted from the WHO statistics where Chilean males had a higher suicide rate at 75+ whereas females had a greater propensity to suicide between the ages 45-54. Suicide is often linked to psychiatric illnesses with statistics showing that up to 90% of adults who commit suicide had at least one recognised mental health disorder [4]. It has been estimated that 15% of depressives eventually commit suicide. Another important predictor of suicidal intent is alcohol and substance abuse where previous trends lead to an estimated 18% of alcoholics eventually committing suicide [5].

5.4. Current Practice

Structured clinical interviews in one form or another are currently used as the diagnostic tools used in assessing suicide risk [1, 2, 6, 7]. There are a number of different “Scales” but none has been universally adopted. The Suicide Ideation Scale (SIS) was initially based on an interviewer-patient consultation but this approach can be supplemented by self assessment protocols. The response integrity (comparison with the interviewer led questionnaires) have been validated in a number of studies and the Beck Scale for Suicide Ideation (BSSI) is one of the more common of this type [1,2]. It typically consists of 15-21-items graded in terms of increasing suicidal intensity with the cumulative total being used as a potential measure of the patient’s psychological profile (attitude, perception, behaviour and planning) with regard to suicide. It is a short term instrument designed to assess the propensity for a suicide act based on the patient’s behaviour in the past 7 days. The criteria relate to queries covering a diverse range of

characteristics that probe: the patients desire to die; preparation for the proposed suicide attempt (i.e. mode, duration, frequency) and the seriousness of the suicidal desire (previous attempts) [1].

Such tests are inevitably limited by a number of factors: they are subjective and rely on the experience of the interviewer and the subsequent interpretation of the responses and, as such, they are almost invariably administered in a clinical environment under psychiatric supervision. The patients will, in all likelihood have been identified as a potential suicide risk already – either by referral by a GP or the patient having had a failed attempt. The development of a biochemical assay that can provide an alternative, though complementary, assessment is needed – particularly where it could be used as a screening tool by GPs prior to the use of the more, intimidating psychiatric evaluations. Much of the research towards this goal has been directed at various neurochemical pathways: serotonergic, dopaminergic, noradrenergic and the hypothalamic–pituitary – adrenal axis (HPA-axis). Disturbances in metabolic compositions within these pathways can lead to a variety of conditions – it is has been shown that there are defined variations between individuals suffering from suicidal ideation and healthy control groups. Given such variations in the biochemical pattern, it has been suggested that it could be possible for investigators to exploit these as a semi-quantitative test through which to evaluate suicide risk or at least corroborate the findings of a structured interview/assessment.

5.5. Neurochemistry of Suicide

Investigating the small molecule variations in cerebrospinal fluid, blood, urine and brain components has revealed several compounds that could be key players involved in the neurochemistry of suicide. The main biomarkers associated with suicide are monoamines, a class of small neurotransmitter, which can be further divided, depending on their structure, into indoleamines (Serotonin (5-HT), 5-Hydroxyindoleacetic acid (5HIAA)) and catecholamines (Dopamine, Epinephrine, Norepinephrine). The chemistries and detection methods for each neurochemical are briefly reviewed in the following sections.

5.5.1. The Serotonergic System – Serotonin and 5-Hydroxyindole-3-acetic Acid

Serotonin has long been implicated as a key protagonist in various mood disorders that can encompass impulsivity [9], eating disorders [10], alcohol addiction [11], aggression [12], anxiety [13], depression [14], bipolar disorders [14, 15] and suicidal behaviour [14-16]. While the role and significance of low serotonergic activity as a tool for clinical diagnosis remains contentious – particularly in the case of depression - there is an increasing body of evidence to support the association of the former with those individuals deemed to possess a higher propensity towards suicide – particularly violent suicide [14, 16-21]. Reductions in serotonergic activity can occur through an impaired release of the neurotransmitter, the expression of fewer receptor sites or the failure of the binding event to result in signal transduction. When serotonin is released into the synapse (**Figure 5-1**), it is inactivated mainly by reuptake into the presynaptic neuron through a variety of serotonin transporters ($5HTT$, $5HT_{1A}$, $5HT_{2A}$ etc), where it is recycled [8].

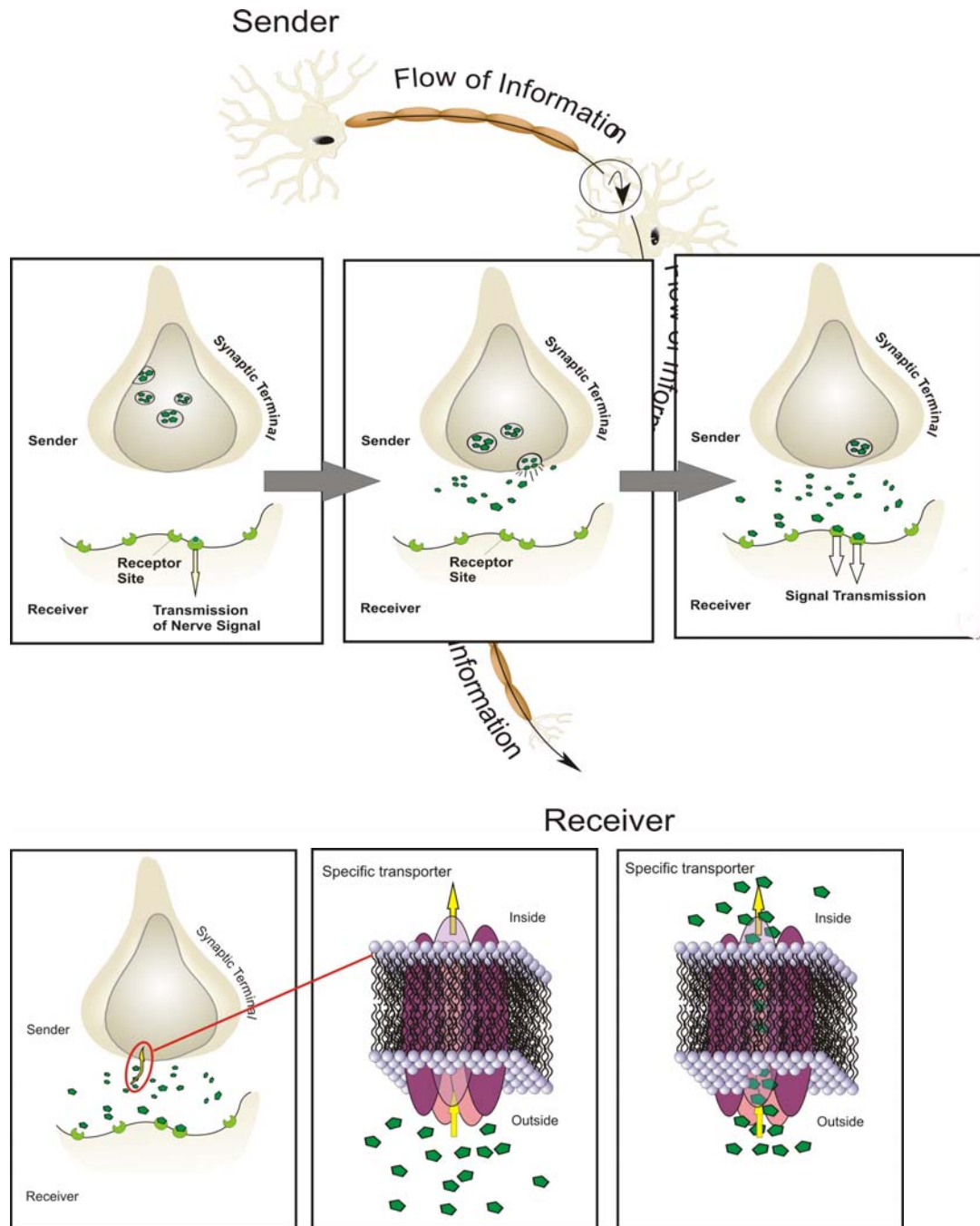

Figure 5-1: Serotonin release, receptor activation and reuptake

These transporters are the target for a group of anti-depressants known as Selective Serotonin Reuptake Inhibitor's (SSRI's) whose action is to block the reuptake of serotonin from synapses into the presynaptic neuron [8,22]. These areas have been extensively studied and reviewed in recent years but, in this instance, our interest lies

predominantly with assessing the methods used to assay the concentration of the neurotransmitter.

Post-mortem studies of brain tissue from suicide victims has revealed decreased levels of serotonin transporters (5HTT) and/or serotonin receptor binding [23-27]. There are however some conflicting studies where no change in 5HTT was observed [28-32]. There is also considerable evidence for serotonergic asymmetry in the brain and arises from studies of suicide victims and those who died from natural causes. Arató et al. [33] found a higher number of free binding sites (found on brain serotonergic neurons) in the left frontal cortex of suicide victims in contrast to findings in control subjects and was further corroborated by Demeter et al. ([34] and Arató et al [35]. The majority of the clinical studies utilise the serotonin metabolite 5-hydroxyindolacetic acid (5HIAA) as an indirect measure of the serotonin activity or the ratio of 5HT/5HIAA as guide to serotonin turnover. The basic reaction pathways through which serotonin arises, is metabolised and 5HIAA produced are detailed in **Figure 5-2**.

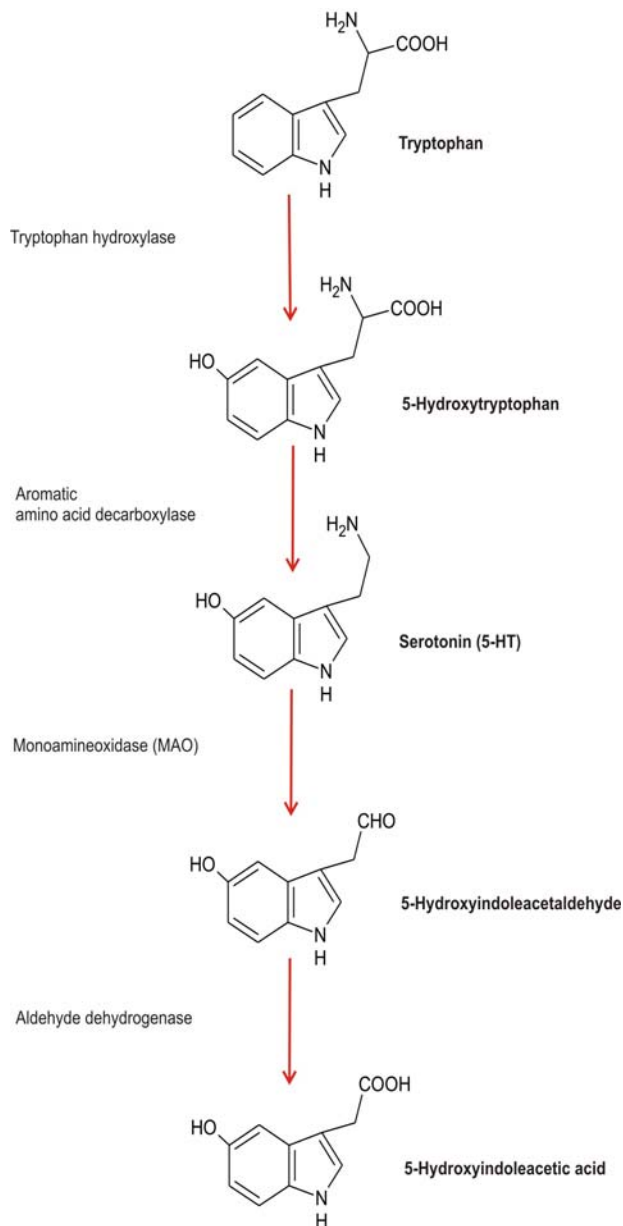

Figure 5-2: Reaction pathway for serotonin and 5-HIAA

The most common approach has been to exploit cerebral spinal fluid (CSF) as the primary source of the analyte and this has been widely accepted as the principal matrix on the basis of a direct association between CSF-5HIAA and brain serotonin activity. Support for the latter has arisen primarily through the observation that CSF 5-HIAA correlates with many of the post mortem studies of 5HIAA in the pre-frontal cortex [36]. While the evidence for the correlation of low serotonergic activity with the severity of depression remains speculative and clearly warrants further investigation – the correlation with serious suicidal behaviour is more robust. Corroboration for the latter has been provided by a number of independent studies examining depressed patients admitted after a failed suicide attempt [37-40], from studies of patients possessing suicidal ideation at the time of admission [41,42] or a lifetime history of suicide attempt [43]. The implication of low CSF-5HIAA with covert anger, aggression and violent suicide has also been suggested [39,43]. Follow-up studies of patients with a history of suicide attempts has revealed an association with low CSF-5HIAA and it has been suggested that the latter could therefore be used as a predictive diagnostic towards pathological aggression and further suicide attempts / relapse [44-45].

It is important to note that many of the investigations examining neurotransmitters and their corresponding metabolite levels almost invariably utilise CSF but sampling is far from trivial and induces significant procedural complexities as well as safety and ethical issues. Platelet serotonin has been suggested as a peripheral biomarker and, in contrast to CSF, presents a much more accessible sample for diagnostic and screening purposes [46-47]. These have been routinely used as fundamental models for CSF serotonin activity as the platelets possess many of the core characteristics of the central serotonin neurons with common receptor and transporter protein assemblies effectively reflecting the CSF dynamics associated with uptake, storage and release of the neurotransmitter [46]. As with CSF serotonin and 5HIAA studies, investigations involving platelet 5HT and 5HIAA are also subject to debate but there have been a number of studies that again provide significant evidence for a link between suicide and low serotonergic activity [47]. In a recent investigation of war veterans diagnosed with post traumatic stress disorder (PTSD) – those assessed as a clear suicide risk or who had attempted suicide had a significantly lower concentration of platelet serotonin than those

categorised as depressed [47]. Moreover, the respective results matched those of non-PTSD patients but evaluated as being either suicide risk or depressed. In the case of those placed within the suicidal category – a clear differentiation between healthy controls and suicidal patients (with or without PTSD) was possible but less so between the former and the depressed groups. This again reflects the controversy found with attempting to use serotonergic deficiency as a tool for depression.

5.5.2. Dopaminergic and Noradrenergic Systems

The other biomarkers believed to have a significant role in suicide are dopamine and norepinephrine (noradrenalin) / epinephrine (adrenalin). All are present in the body and act as both hormone and neurotransmitter. All three are synthesized from the amino acid L-tyrosine in an enzyme promoted cascade shown in **Figure 5-3**. Dopamine, norepinephrine and epinephrine can be inactivated in two main ways: enzyme deactivation or reuptake into presynaptic nerve terminals. Monoamine oxidase degrades dopamine and norepinephrine into their metabolites, which are homovanillic acid (HVA) and 3-methoxy-4-hydroxyphenylglycol (MHPG) respectively. The structure of HVA and MHPG are shown in **Figure 5-3**.

As with Serotonin, many of the studies investigating Dopamine, HVA, Norepinephrine and MHPG use CSF [48,49] and, as with Serotonin / 5HIAA, the levels of HVA and MHPG in the CSF have provided an indirect but more manageable insight on dopamine and norepinephrine levels in the brain. For normal controls the typical concentrations are 200 nM and 40 nM for HVA and MHPG respectively [17-18].

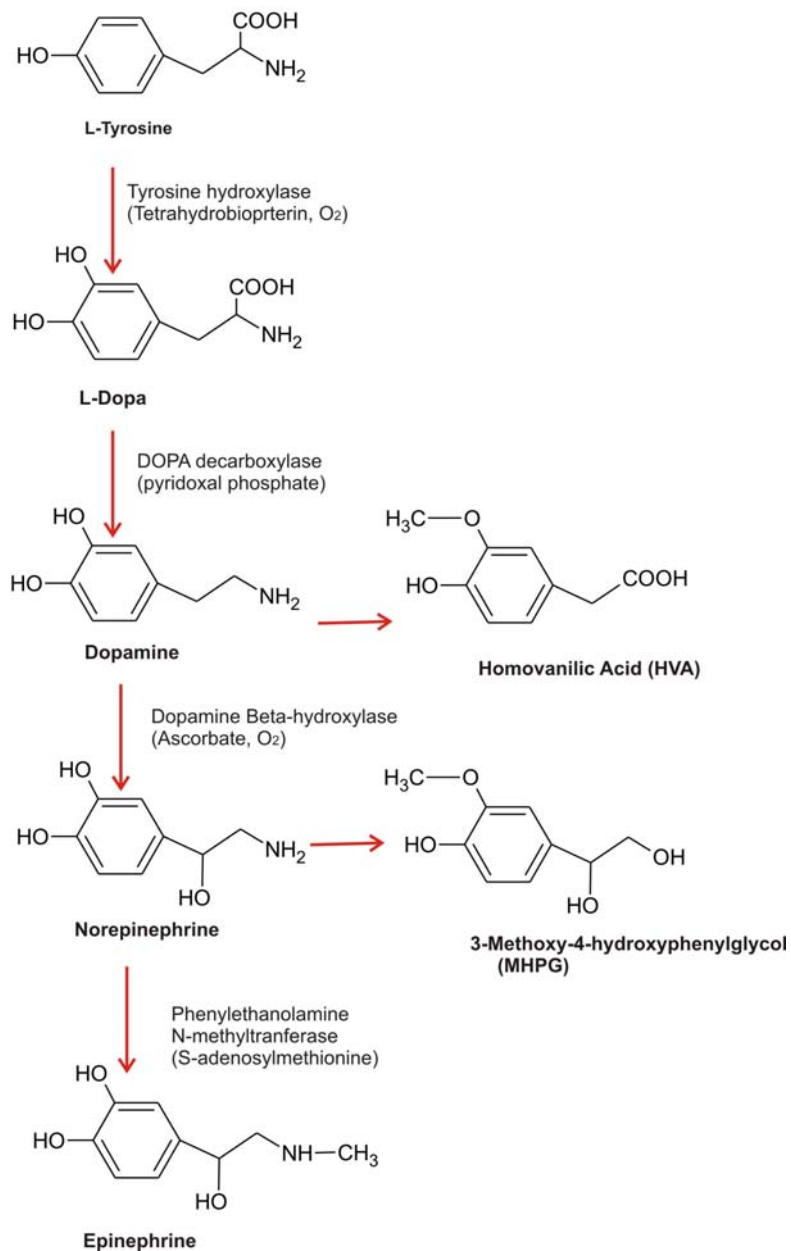

Figure 5-3: Reaction pathway for catecholamines

The role of the dopaminergic system in the pathophysiology of depression is supported by a number of reports that have found abnormally low central nervous system dopamine and HVA metabolite levels. Lower CSF concentrations of HVA has been found in melancholic major depressive disorders (MDD) than non-melancholic MDD [50]. In addition, reduced veno-arterial plasma concentrations of HVA in treatment-

resistant depression have been found [51]. There have been a number of studies that report low dopamine and/or HVA levels in the serum, CSF and urine of suicidal patients. Lower CSF HVA was also found in 120 hospitalized suicide attempters versus healthy controls [52]. Lower urine HVA concentrations have also been found in suicide victims with significant differences between suicide attempters and non-attempters or normal controls but contrasts previous studies where there was little differentiation between alcoholics who had and had not attempted suicide [53]. In fact, Roy et al. (1989) reported a greater risk of attempting suicide over a 5-year follow-up in MDD patients who had low CSF HVA levels at baseline [54].

The role of noradrenalin in mood disorders became evident when patients treated with drugs for hypertension subsequently were diagnosed with depression and were found to have a significant decrease in the catecholamines within both the CNS and peripheral nervous system[55]. There have been numerous investigations into the pathways through which this can occur – examining tryptophan hydrolase and monoamine oxidase enzyme systems and receptor studies. As neurotransmitters, norepinephrine is found throughout much of the brain while epinephrine is found predominantly in the adrenal gland and only in small amounts in the central nervous system [19]. Norepinephrine is known to have an important effect on behaviour, with its influence on depression and suicide being the subject of numerous investigations [48,49]. The results of studies on norepinephrine and MHPG however have been largely inconsistent, with some showing no significant difference while others have showed a lower level of the neurochemical compared to control groups [17,18]. Individuals with levels of dopamine, HVA, norepinephrine and MHPG lower than age and gender matched controls have however been shown to have a greater propensity to depression, but not suicide[56]. The inconsistency in the studies can, in part, be due to the low contribution that the catecholamines make to the urinary output.

Reuptake into the presynaptic nerve is the major mode of inactivation in the CNS and, in common with serotonin, occurs through specific transporters. Once reuptake has occurred, storage vesicles take up the amine. The success of SSRI's as antidepressants has led to the introduction of dual action serotonin-norepinephrine reuptake inhibitors (SNRI's) [57] act upon reuptake sites across a range of transporters. It has been suggested

that psychiatric illness is not caused by a deficiency of one monoamine, but rather by the variations in the transition and interconversion of species within the monoamine systems and one approach has been to use monoamine metabolite ratios as an indicator for such relationships. One study found that HVA/5HIAA and HVA/MHPG ratios were significantly lower in patients who had attempted suicide compared to the control group [58, 59].

There have been a host of other systems investigated [8]. Cholesterol is, perhaps, one of the more unusual given its dietary ubiquity and the quest to reduce its consumption. Interestingly, low levels of the lipid have been linked to both depression and suicide [60-62]. There have also been studies that have suggested links between low cholesterol and violent suicides [60]. Other protagonists are nitric oxide [63], and various hormones associated with the HPA-axis [64-66].

5.6. Detection Techniques

Many of the techniques that have been used for the detection and quantification of neurochemicals tend to include the standard systems common to most clinical biochemistry laboratories and tend to rely upon HPLC and GC-MS. The former comes with a range of different detectors including UV, fluorescence and electrochemical systems. There are, however, several problems associated with detecting neurochemicals – the principal issue being their intrinsic low concentration within the body coupled to the fact that inactivation takes place quickly after their initial release degrading them into their metabolites (i.e. dopamine into HVA and serotonin into 5HIAA). It is clear that, in order to detect such low concentrations, the technique used must be highly sensitive.

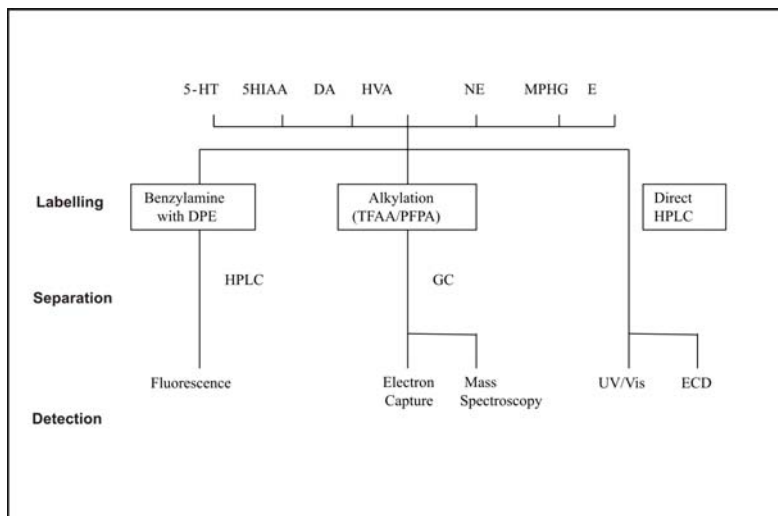

Figure 5-4: Common neurotransmitter detection routes

The sample requirements for each mode of detection can also be very variable. Sample derivatisation is necessary to convert the neurochemical into a more volatile compound for use with GC [67-68]. Derivatisation is often carried out with HPLC systems to allow the analytes to be more easily detected once separated, therefore increasing the sensitivity. An example of this is the use of benzylamine as a derivative to aid fluorescence detection [69]. While HPLC can also require some form of derivatisation, direct analysis is also possible (providing macromolecular material has been removed). The ideal HPLC technique, however, is Liquid Chromatography-Mass Spectrometry (LC-MS). This approach is increasingly favoured for investigative procedures such as reaction pathway elucidation as it provides unrivalled selectivity and sensitivity particularly when dealing with a complex matrix. The overall expense however can be problematic when considering it for routine screening purposes. There are several different approaches that can be used to detect the different neurochemicals – some of which are described in **Table 5-1**. The basic routes for detection are summarised in **Figure 5-4**.

Method	Analyte	Sample	Detector	Detection Limit ng/mL	Ref
HPLC-ECD	Serotonin	CSF	ECD	0.3	77
HPLC-MS	5-HIAA	Urine	MS	15	78
HPLC-MS	5-HIAA	Brain	MS	2	75
HPLC-ECD	Dopamine	CSF	ECD	0.15	74
HPLC-ECD	Dopamine	Brain	ECD-Coul	8	80
HPLC-ECD	HVA	Plasma	ECD-Coul	20	42
HPLC-ECD	HVA	CSF	ECD	0.1	8
HPLC	Norepinephrine	Brain	Fluorescence	0.001	81
HPLC -ECD	MHPG	CSF	ECD	0.1	76
HPLC-MS	Epinephrine	Chromaffin cell	MS	1.9	82

Where : MS = Mass Spectrometer; ECD = Amperometric Detection; ECD-Coul = Coulometric Detector

Table 5-1: Detection of common neurotransmitters

5.6.1. Direct Determination

While pre-column derivatisation is typically carried out to increase the sensitivity [69], it is not always necessary. The intrinsic aromaticity of the neurotransmitter core provides a UV active chromophore (typically $\sim\lambda$ 250 nm) and can allow direct determination. Conventional UV/Vis detectors are readily available, relatively selective (assuming column resolution is efficient) and easy to use, however they are not as sensitive as other detectors [769-72]. Electrochemical detectors offer the advantage of having a higher sensitivity than UV-detectors and again no sample derivatisation is needed [70,71,73]. There are two main forms of electrochemical detection: Amperometric (current) and Coulometric (charge). Both of these are extremely sensitive and are selective for a wide range of analytes including many phenols, aromatic amines.

The most common method used in detecting neurotransmitters is amperometric detection because of the ease with which such detectors can be constructed. It detects indolic, phenolic and catecholic functional groups through direct oxidation at the electrode surface and has been used with HPLC to determine the different neurotransmitters present in a host of biological samples [70-81].

The use of LC-MS is an obvious alternative but its availability and the expertise required is often viewed as a limiting factor and its use for routine screening is, at the present, questionable as the other detectors are capable of reaching the concentrations of neurotransmitter or metabolite in most biofluids. Its adoption in the future is almost inevitable and will reflect the evolutionary upgrade path of clinical biochemistry labs. LC-MS offers the advantage of being the more selective and sensitive option and while the samples require no derivatisation, the column will often be the limiting factor and pre-analysis preparation to remove macromolecular contaminants must still be considered [70].

5.6.2. Indirect Determination – Derivatisation

Fluorescence detectors have also be used with HPLC [72-70] and can offer increased sensitivity and selectively over the other spectroscopic and electrochemical methods. However, the neurotransmitters do not have any significant inherent fluorogenic activity and require chemical derivatisation prior to entering the column to enhance the signal. Derivatisation agents include naphthalene-2,3-dicarboxaldehyde (NDA) in the presence of a cyanide ion [82] and benzylamine either independently [72-83] or coupled with 1,2-diphenylethylenediamine (DPE) [84]. There are problems with some of these derivatives however, for example NDA does not react with secondary amines therefore cannot be used to detect epinephrine. In addition, NDA does not react with acidic catecholamines, so cannot be used to detect HVA. The structures of these derivatives and the corresponding preparative reaction schemes are detailed in **Table 5-2**.

Reaction pathways for Fluorescent labelling		Ref
<p>NDA</p> <p>Dopamine/Norepinephrine</p> <p>Fluorescent derivative 1-cyano-2-substituted -benz[f]isoindoles (CBI)</p> <p>NDA with CN Dopamine R1 = H Norepinephrine R1 = OH</p>		
<p>Benzylamine / DPE</p> <p>5-Hydroxyindoles</p> <p>Benzylamine</p> <p>2-Phenyl-4,5-pyrrolobenzoxazoles (Fluorescent derivative)</p>		85
<p>Catecholamines</p> <p>DPE</p> <p>2-Phenyl (4,5 dihydropyrrolo)(2,3-F) benzoxazoles Fluorescent derivative</p> <p>Serotonin R1 = CH₂CH₂NH₂ 5HIAA R1 = CH₂COOH Dopamine R2 = H R3 = H Norepinephrine R2 = OH R3 = HH R3 = CH₃</p>		67

Table 5-2: Fluorophore derivatisation reactions

Another method for detecting neurotransmitters is GC but this also requires derivatisation to turn the sample into a volatile compound.

Reaction Pathways for Gas Chromatography				
Trifluoroacetic anhydride				
<p>TFAA + Catecholamines → TFA derivative</p>				
<p>TFAA + 5-Hydroxyindoles $\xrightarrow{\text{CH}_3\text{CN}}$ TFA derivative</p>		88		
<p>Dopamine R1 = H R2 = H Norepinephrine R1 = OH R2 = OCOCF₃ Serotonin R3 = CH₂CH₂NH₂ R4 = CH₂CH₂NH₂ COCF₃ 5HIAA R3 = CH₂COOH R4 = CH₂COOCH₃ (Note: For 5HIAA, the reaction takes place in the presence of CH₂N₂ and Na₂SO₄.)</p>				
Pentafluoropropionic Anhydride				
<p>PFPA + Catecholamines → PFP derivative</p>				
<p>PFPA + 5-Hydroxyindoles → PFP derivative</p>		69		
<p>Dopamine R1 = H R2 = H R3 = H R4 = H Norepinephrine R1 = OH R2 = H R3 = COC₂F₅ R4 = H Epinephrine R1 = OH R2 = CH₃ R3 = COC₂F₅ R4 = CH₃ Serotonin R5 = CH₂CH₂NH₂ R6 = CH₂CH₂NHCO C₂F₅ 5HIAA R5 = CH₂COOH R6 = CH₂COOCH₂C₂F₅</p>				
<p>Note for 5HIAA the reaction takes place in the presence of C₂F₅CH₂OH</p>				

Table 5-3: GC derivatisation reactions.

Examples of derivatising agents include trifluoroacetic anhydride (TFAA) [67] and pentafluoropropionic anhydride (PFPA) [68] to produce trifluoroacetyl and pentafluoropropionyl derivatives respectively as indicated in **Table 5-3**.

5.7. Sampling Issues

There are a number of critical sampling issues that need to be addressed upon attempting to transfer the techniques to a more routine screening process. The majority of the samples analysed are CSF with the lumbar puncture done, under rigorous clinical conditions and invariably for purely research investigations. This is clearly inappropriate for routine testing. Blood platelets have been proposed as an alternative matrix and proffered as a model for central neuron functions associated with serotonin [46,47,85-88]. The primary advantages of this approach are that it only requires a simple venous blood sample which could, in principle be obtained by a trained nurse at the patients bedside, home or medical centre. Although the function of the platelet differs markedly from that of a CNS neuron, there are a number of core similarities: in terms of serotonin uptake, storage and release and in the expression of key enzymes and receptors [46,47,97].

The use of saliva measurements would be a more preferable sampling method given the non invasive premise. There are few studies on this aspect though it has been demonstrated that salivary MHPG has a high correlation with CSF MHPG [89]. The clinical knowledge base surrounding the platelet-CSF correlates would, at present, provide a more robust foundation for the development of a routine screening assay than the salivary measurements. However, saliva measurements hold out the opportunity for ease of sampling which could be a critical issue in attempting to screen uncooperative patients – such as those in prisons. The latter is an increasingly important issue with higher rates and where suicidal intent may well be disguised and thus fails to reach the attention of a psychological counsellor [90].

5.8. Review Summary

The prevalence of suicide reinforces the need for a reliable way of assessing risk and thereby offer a more effective, and ideally preventative, intervention. There is clear evidence that malfunctions in the serotonergic, dopaminergic and noradrenergic neuro pathways are involved in the pathophysiology of suicide but it is also clear that the variations in the key chemicals are measurable. Low CSF 5HIAA has been demonstrated to predict suicide attempts and it has been demonstrated that CSF 5HIAA and HVA levels can be negatively correlated with the lethality of the suicide attempt. The availability of a biochemical assessment for the neurochemical family identified here could therefore offer a more objective view which could be used in a complementary role to existing psychological profiles. The shift from CSF to platelet and urine sampling is a case in point and while it could offers a more manageable solution and opens a window of opportunity for the development of a screening assay.

There are clear ethical concerns both for the general public and incarcerated populations over the sole use of such a technique, however, it is unlikely that such a test, used in isolation, would be sufficiently robust as to provide a definitive evaluation. It is more likely to be employed as screening option where it could be an essential aid given the increasing time restraints placed upon GP consultations and could be an alert through which better prioritisation of the patient population could occur and more robust evaluations made. More importantly, it could also offer a means of assessing the effectiveness of subsequent treatment regimes. At present, there is a large body of supportive evidence to suggest that measuring the biomarkers identified here could be used as a first step but there have also been many conflicting studies across the monoamine range and reflect the heterogeneous nature of the sample population. Greater care in the study design but also in the analytical characterisations carried out are required such that reliable and informative reference ranges can be obtained before such a test could evolve and have clinical merit.

The ongoing debate about the possible link between the serotonin metabolite – 5-hydroxyindoleacetic acid (5-HIAA) - and suicidal behavior requires a more robust specification of reference ranges for normal and “at risk” subjects. As such, there is a

need for a revision of analytical techniques for the speedy, selective and sensitive detection of the monoamine biomarkers. A new approach to the production of a carbon composite electrode and its solvent free, laser ablative modification to enhance the performance in the detection of the neurotransmitters was proposed as an alternative and the remainder of the chapter focuses on the development and assessment of the technology.. The integration of the electrodes within conventional chromatographic architectures is assessed and its use in the quantification of 5-HIAA within human urine has been critically evaluated and found to be superior to the HPLC-UV.

5.9. Proposed Methodology

Different techniques have been used for the detection of these neurotransmitters but the majority of clinical studies rely upon chromatographic techniques. These have been coupled with uv [91, 92], fluorescence [93, 95] or luminescence [96] detectors but they are limited in terms of the need for sample derivatisation prior to analysis. This is due to the lack of a suitable chromophore. Electrochemical methods are arguably the best option offer direct analysis and avoiding the procedural complexities and additional errors that can arise through the sample processing and derivatisation steps [97-119]. The main limitation of electrochemical methods is the potential interference from other species present in the biological fluid which are capable of being oxidised at potentials similar to the target analyte. Electrode surface modification offers numerous possibilities through which to avoid these interferences, and to increase the sensitivity and selectivity of the detection [97-105]. These include some of the exogenous modifiers mentioned in Chapter 1 - such as polymeric coatings [97-100], metal or metal oxide particles [101,102] and carbon nanotubes [103-105] either to screen out the interferences [97-105] or to improve the electron transfer [103-105].

The underlying electrode material can also be directly modified to improve sensitivity and selectivity. Modification of carbon or carbon composite surfaces can be done by modifying the surface properties such as the incorporation of quinoids and acid groups at the surface of the carbon material by simple anodization of the electrode and which increases electron transfer. This can be done using chemical, thermal or

electrochemical methods. In the present work, laser anodisation was viewed as a more convenient method that is chemical free, patternable and more controllable than conventional wet techniques for modifying carbon based substrates [114]. The basic rationale has been to develop a disposable electrode detector that could be easily integrated within a conventional HPLC architecture as shown in **Figure 5-5**.

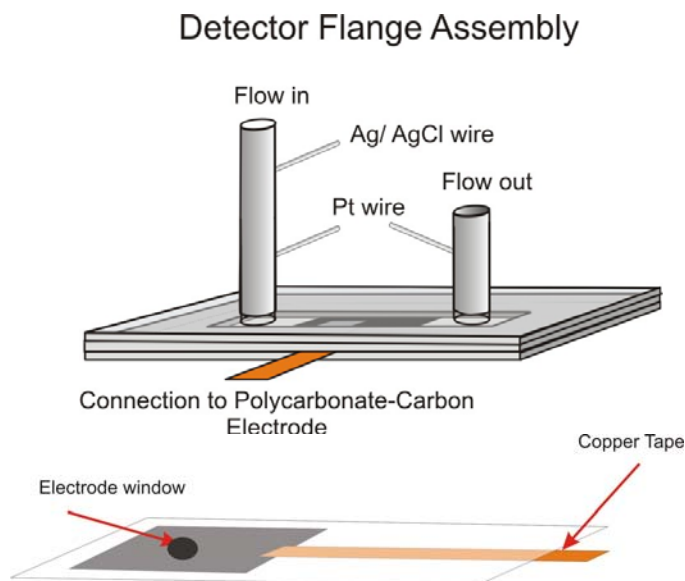

Figure 5-5. Design of the HPLC-ED flow system and disposable electrode

The possibility of modifying the electrode surface using a direct and controllable strategy to improve the sensitivity and selectivity of the electrode toward specific analytes offers an alternative to current electrode modification methods used for the detection of neurotransmitters. Moreover, the relatively inexpensive nature of the electrode fabrication process advocated herein provides an option for disposability and counters the issues of electrode fouling that have traditionally been levied at HPLC-ED systems. An investigation of the applicability of the approach and characterisation of the material properties and electrode performance toward monoamine neurotransmitters in human urine as the model biological fluid was conducted.

5.10. Experimental Details

5-Hydroxyindoleacetic acid and graphite powder, ascorbic acid (AA), uric acid (UA) dopamine (DA) and Urinary metabolite lyophilizate from human male patients were obtained from Sigma Aldrich. Polycarbonate granules were obtained from Goodfellow, and Dichloromethane (DCM), Methanol and Acetonitrile were purchased from Fisher Scientific. All reagents were analytical reagent grade and deionised water was used for all solutions.

Electrochemical experiments were performed with an Autolab PGStat 12 computer controlled potentiostat (Eco-Chemie, Utrecht, The Netherlands). The three electrode system consisted of a carbon polymer composite electrode (CPE) as a working electrode, a platinum wire as a counter electrode and a silver - silver chloride wire as reference electrode was used in bulk analysis. HPLC experiments were conducted on an Agilent 1200 system with a quaternary pump and an autosampler. The injection volume was 10 μ L. The column was an ODS(1) 3 μ m diameter (150 x 4.60 mm) (Phenomenex) . The mobile phase was a 97/3 of phosphate buffer (10 mM, pH = 5) - methanol combination which was delivered isocratically at a constant flow rate of 0.8 mL / min. The detection wavelength throughout was 280 nm. All experiments were performed at 22°C +/- 2°C. The modification of the electrode surface was conducted using a 250W CO₂ laser (LasereX alpha CadCam Technologies, Nottingham, UK). Characterization of the sensor substrates was done using a Nanite AFM (Nanosurf AG Liestal, Switzerland) with a Platinum/Iridium coated silicon probe (Nanoworld AG Neuchatel, Switzerland) and a JSM-840A JEOL Scanning electron microscope (Oxford instruments, Oxford, UK).

5.10.1. Preparation of Modified Electrode

The CPE was prepared by mixing graphite powder with polycarbonate granules in a 1.5/1 ratio respectively and dissolving the mixture in DCM. The paste was then deposited onto a smooth and plane surface and left to dry. The surface of the resulting film was then progressively etched using a CO₂ laser prior to the construction of the sensor assembly. The composite device was prepared by thermally sandwiching the

carbon-polymer film between sleeves of a commercial resin backed-polyester lamination pouch (75 μm thick) in which the electrode window (3 mm diam.) had been previously patterned. Electrical connection to the carbon-polymer film was made by the addition of a copper tape. The basic design of the sensor is shown in **Figure 5-5**

5.11. Results and Discussion

5.11.1. Electrode Characterisation

Initial characterisation of the carbon-polymer composite electrode was conducted through examination of the surface morphology with a conductive atomic force microscope (CAFM). It was found that there is a difference in the conductivity between the upper and lower side of the composite with the lower side exhibiting a higher conductivity. This can be explained, in part, by a difference in the morphology of the sides, as it can be appreciated in **Figure 5-6**.

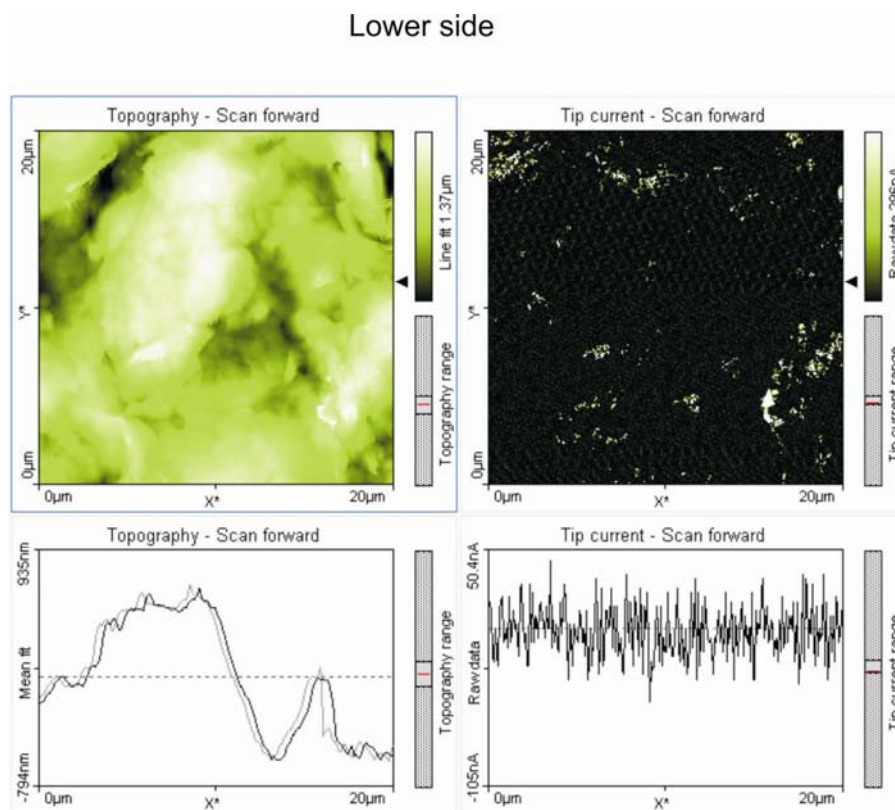

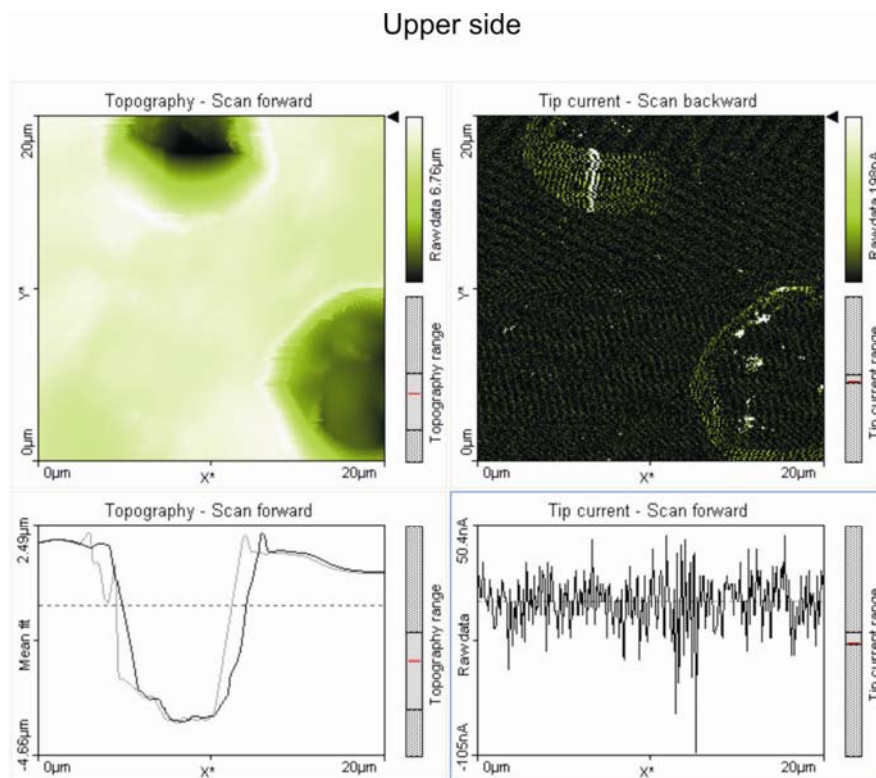

Figure 5-6: CAFM images of the polycarbonate carbon-polymer composite electrode

CAFM experiments were done by David Morgan from Windsor Scientific.

The upper side was found to be highly pitted – which contrasts the smooth profile observed in the lower (base) side. This is due to an artifact in the casting process and can be attributed to the evaporation of the solvent from the polymer mesh. While the sides are markedly different in the initial phases of the film fabrication – they are rendered effectively identical in the follow up processing as the laser treatment ablates the top most layers.

Scanning electron micrographs detailing the different in surface morphology before and after the imposition of laser ablation are shown in **Figure 5-7**. After treatment, it was found that the graphite particles were more exposed and highly fractured (with size distribution in the sub micro-nano region than in the micron scale observed with the unmodified sample). This will obviously result in an increase in the electrode surface area. Given that the film is effectively a mesh of non conductive polymeric binder into which carbon particles are impregnated, the laser removal of the interfacial polymer

mesh, should increase the amount of “active - carbon” electrode area (highlighted in **Figure 5-7**) and hence improve the electrochemical performance of the electrode

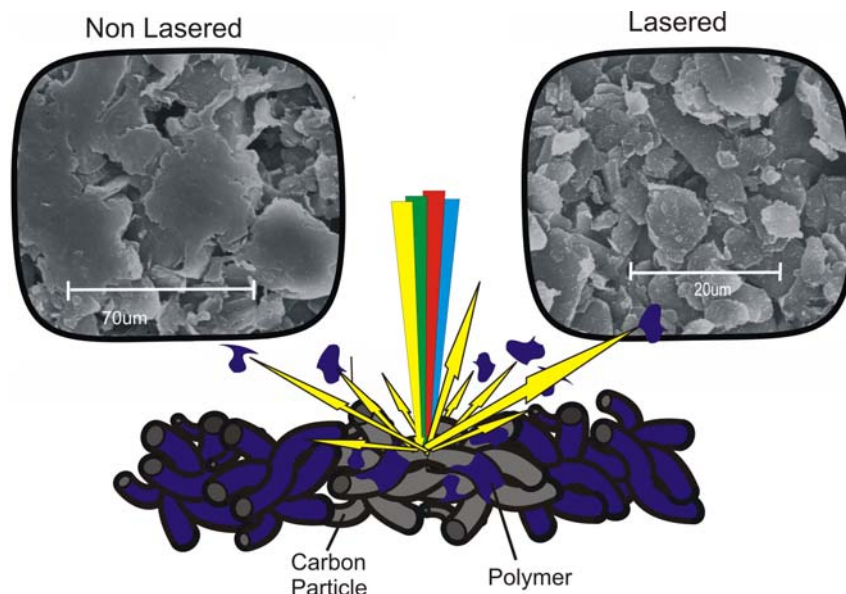

Figure 5-7: SEM images of the carbon-polymer film electrode before and after the laser treatment.

5.11.2. Electrochemical Behaviour of the Laser Treated Carbon Composite

In order to assess the influence of laser treatment on electrode performance, the laser power applied to the surface modification was varied. Cyclic voltammograms detailing the response of the composite electrode to dopamine (1 mM, pH 7) after 5, 10 and 15% laser ablation is shown in **Fig 5-8**.

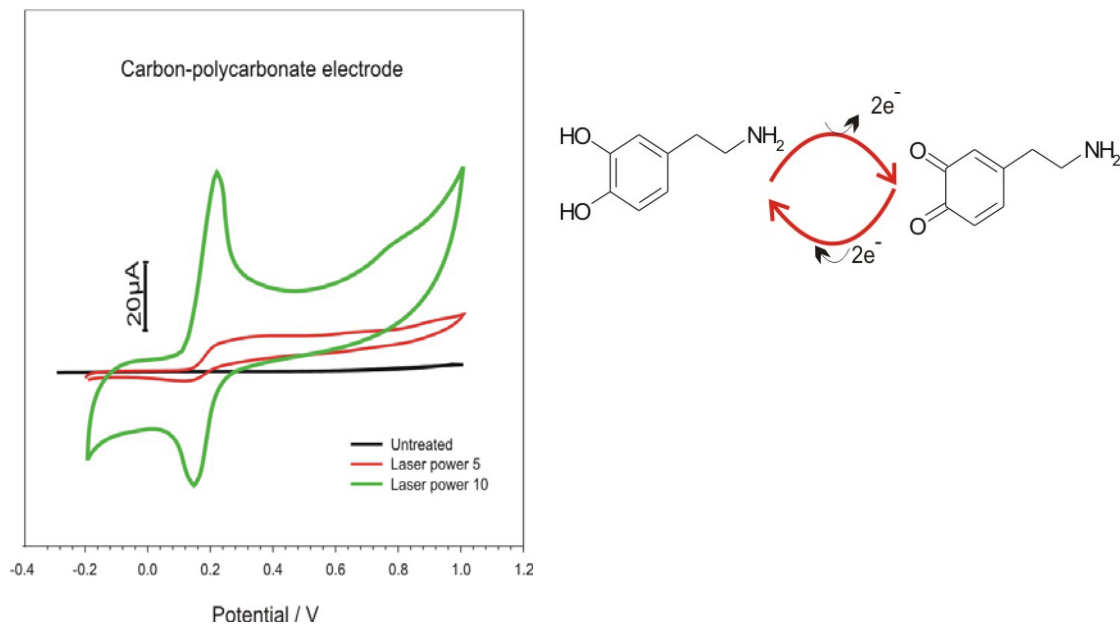

Figure 5-8: Cyclic voltammograms of dopamine (1 mM, pH 7, Scan Rate = 0.1 V/s) at the carbon polymer film electrode after different laser treatments.

Well defined oxidation and reduction peaks were observed at +0.22V and +0.16V respectively after the appliance of 15% of laser power. As the power of the laser is increased, the response of the electrode improved in terms of peak magnitude and definition. It was found however that increasing the laser power beyond 15% led to a significant degradation in the electrode performance. This can be explained on the basis that as the laser power is increased, the amount of polymer that is removed is increased and the graphite particles will break down decreasing their size (**Figure 5-7**). It can be envisaged that excessive ablation will lead to increased fracturing – a consequence of which can be the over oxidation and vaporisation of the carbon particles and hence result in a subsequent decrease in performance through loss of “active” conductive particles.

The laser treatment is a method of electrode anodisation [114]. The laser not only increases the surface area of the electrode but enhances the electron transfer by the incorporation of functional groups such as carboxyl and hydroxyl groups onto the electrode surface. Square wave voltammograms of the composite before and after the

laser modification in a mixture of ascorbate, dopamine and urate (1 mM, pH 7) are compared in **Figure 5-9**.

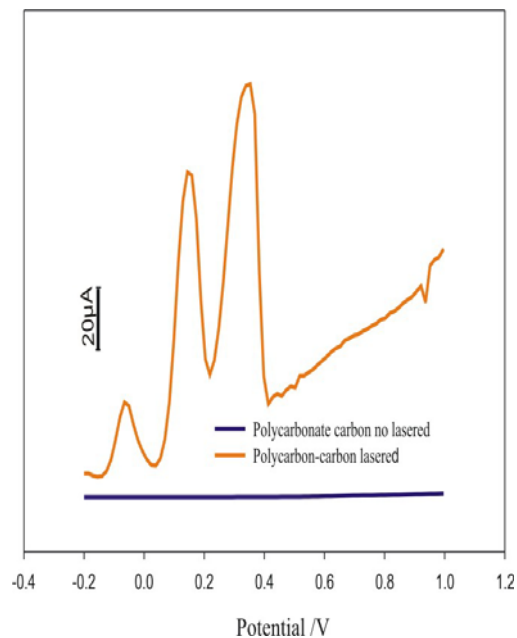

Figure 5-9: Square wave voltammograms of an equimolar (1 mM pH 7) mixture of ascorbate (AA), dopamine (DA) and urate (UA) at the carbon paste electrode before and after the laser modification.

The major problem normally associated with the simultaneous electrochemical determination of these analytes tends to be the overlap of the respective signals which compromises their quantification. The presence of ascorbate and urate are ubiquitous within biological fluids and their low oxidation potential tends to be a significant handicap to the determination of neurotransmitters – particularly as they are both normally present at a far greater concentration than the target analyte. Three well defined and potential resolved peaks were observed with the laser ablated CPE, at -0.08 V, +0.14 V and +0.36 V for AA, DA and UA respectively and opens up the possibility for the simultaneous determination of these analytes. A shift of the anodic potentials of ascorbic acid and uric acid was observed when compared with a conventional glassy carbon electrode. This catalytic behaviour can be explained by the incorporation of oxygen functional groups with the laser treatment and the increase in edge plane sites resulting from the fracturing of the carbon particles.

5.11.3. Determination of 5HIAA

The next step was to incorporate the electrode into a flow cell that could be directly integrated within a conventional HPLC system and placed in series to the uv/vis detector. This dual detector arrangement allowed direct comparison in the performance of the respective system to a given sample injection. The flow cell shown in **Figure 5-5** consisted of a polystyrene structure with a linear channel where the mobile phase flowed over the working electrode surface. The working potential of the CPE detector was set to +0.5 V vs Ag/AgCl (0.1M KCl).

Different concentrations of 5-HIAA were injected in the HPLC with the two detectors in series, the uv/vis followed by the CPE flow cell respectively. The results obtained are shown in **Figures 5-10A and B** respectively. On first inspection, both systems appear to be good candidates for the detection of this analyte with good linearity up to 100 μM (UV/Vis: Response/AU = $6.196 [5\text{HIAA} / \mu\text{mol L}^{-1}] - 9.89$, $R^2 = 0.997$, $N = 3$; CPE: Response/A = $2 \times 10^{-8} [5\text{HIAA} / \mu\text{mol L}^{-1}] - 3 \times 10^{-8}$, $R^2 = 0.997$, $N = 3$)

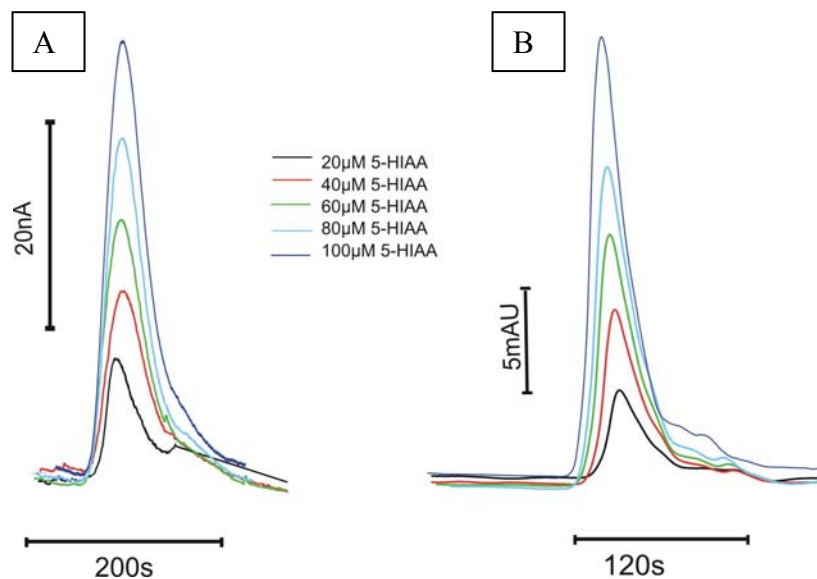

Figure 5-10: A) Amperometric (+0.5V) and (B) spectroscopic (250 nm) response to different concentrations of 5-HIAA

5.11.4. Determination of 5-HIAA in Human Urine

The utilization of the laser modified carbon-polymer composite electrode for the determination of 5-HIAA in real samples was tested by measuring its concentration in urine from a male patient. Two test solutions were prepared from the original sample – the first was used as a blank and the second sample spiked with 50 μM of 5-HIAA. Before injection into the HPLC system, the samples were diluted with the same volume of Acetonitrile (0.5 mL) and centrifuged to precipitate any macromolecular species. Chromatographic profiles analogous to those highlighted in **Figure 5-10** were obtained and the results summarised in **Table 5-4**.

HPLC –UV	HPLC-UV Detection (N=3)	HPLC-EC Detection (N=3)
Recovery	238.6%	97.98%
Relative Standard Deviation	14.69%	0.61%

Table 5-4: Urine analysis

The recovery values obtained with the UV detector were significantly high - indicating the interference of another spectrometric active species in the urine which co-elutes with the 5-HIAA. In contrast, the use of the CPE detector (**Figure 5-5**) for the determination of 5-HIAA showed an excellent recovery and clearly superior performance to the direct uv detection. In “normal” subjects, the 5-HIAA urine concentration is $<40 \mu\text{M}/24\text{h}$. Standard addition analysis of the urine sample revealed a concentration of $10.9 \mu\text{M}$ 5-HIAA which is within the expected range.

5.11.5. From the Lab to the Clinic

The next step would be to develop a portable sensor capable of performing the measurements out with the laboratory. This could ultimately be for screening purposes at a clinic or GP surgery. A prototype device was investigated for the purpose and consisted of layers of laminating sheet possessing a capillary path was incorporated through which the sample could flow through by capillary action. All the electrodes were incorporated

into the system with the exception of the counter electrode which was placed external to the main laminate assembly at the exit of the capillary flow. Chloridised silver wire was used as the reference electrode, the working electrode was the laser ablated polycarbonate.

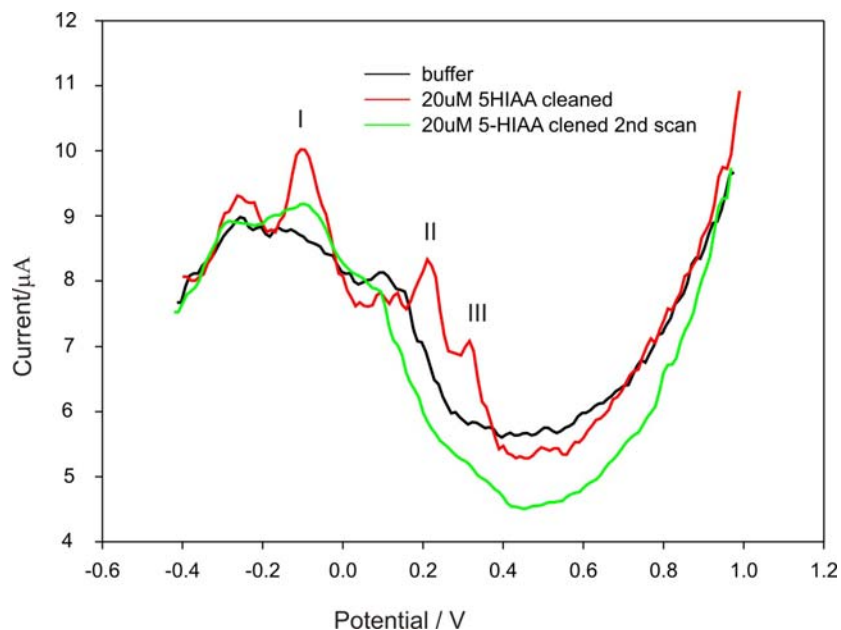
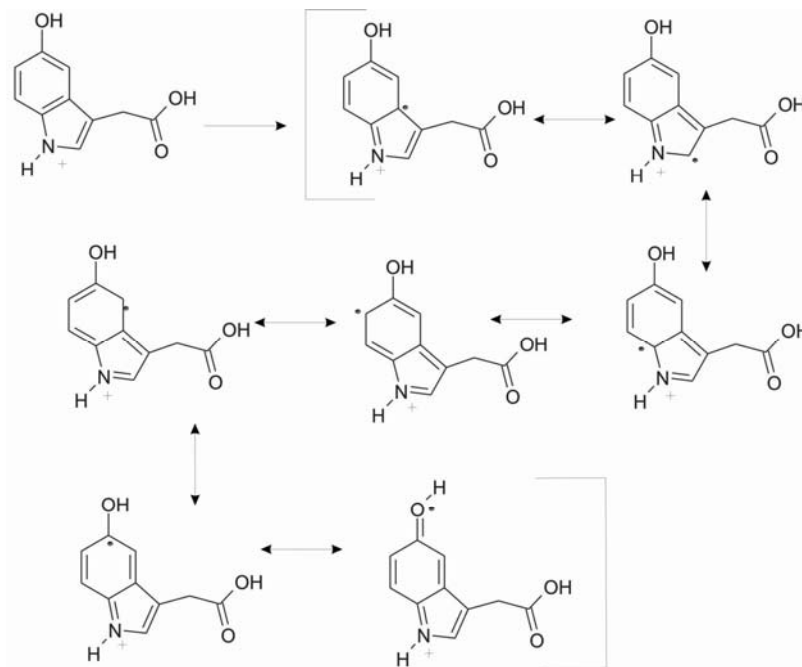

Figure 5-11: Squarewave voltammograms obtained with the capillary sensor in the absence and presence of 5-HIAA.

Figure 5-11 shows the response of the capillary sensor to 5-HIAA. Different peaks were observed possibly due to the polymerization (**Scheme 5-1**) of the neurotransmitter onto the sensor but it could be also that the neurotransmitter is absorbed in the ablated surface. In either case it was found that the electrode gave different responses depending on the level of absorption, time and previous history.



Scheme 5-1: Proposed polymerisation mechanism

Some studies were conducted but no clarification was achieved. It is clear that further studies need to be carried out.

5.12. Conclusions

The development of a carbon-polymer electrode system that allows the selective and sensitive detection of monoamine neurotransmitters has been demonstrated. The electrode system has been characterized and the response characteristics elucidated. The fabrication method advocated here is capable of both *ad hoc* production and mass manufacture through the stepwise bulk laminate processing of the carbon-polycarbonate mixture and contrasts the steps required in Chapters 3 and 4. The inexpensive nature of the system renders the approach more accessible than the exogenous electrode modifications that are normally used to improve bare electrode responses to monoamine neurotransmitters previously outlined in Chapter 1. The system has been shown to be

capable of integration within a traditional HPLC system and exhibited a performance that was superior to the conventional uv detector. In principle, the electrode detector satisfies the initial requirement of a system that could facilitate the analysis of the analytes within real biofluids and hence thereby aid the establishment of more reliable reference ranges. This has been demonstrated through direct comparison with the uv system for the determination of 5-HIAA in urine. The potential portability of the sensor has been demonstrated but further studies are clearly needed in order to understand the interaction of 5-hydroxyindoleacetic acid on the electrode surface and how it affects the performance. Such studies are beyond the remit of the present project but the results obtained leave an opportunity for further investigations.

5.13. References

1. Beck AT, Kovacs M, Weissman A, Consult J. (1979) *Clin. Psychology*, 47 343-352.
2. Niméus A, Alsén M, Träskman-Bendz L (2000) *Eur. Psychiatry*, 15 416-423.
3. World Health Organization. World Health Report 2000. Health Systems: Improving Performance. Geneva: World Health Organization; 2000.
4. Maris RW (2002) *Lancet*, 360 319-326.
5. Roy A, Linnoila M (1986) *Suicide and Life-Threatening Behaviour*, 16 244-273.
6. Bongiovi-Garcia ME, Merville J, Almeida AG, Burke A, Ellis S, Stanley BH, Posner K, Mann JJ, Oquendo MA (2009) *Journal of Affective Disorders*, 115 183-188.
7. Preston E, Hansen L, (2006) *Crisis-The Journal of Crisis Intervention and Suicide Prevention*, 26 170
8. Mann JJ, Currier D, Quiroz JA, Manji HK (2006) *Neurobiology of Severe Mood and Anxiety Disorder, Basic Neurochemistry*, 7th Ed, Elsevier
9. Novkovic VH, Rudan V, Pivac N, Nedic G, Muck-Seler D (2009) *Neuropsychobiology*, 59 17-22.
10. Howell MJ, Schenck CH, Crow SJ (2009) *Sleep Medicine Reviews*, 13 23-34
11. Mukherjee S, Das SK, Vaidyanathan K, Vasudevan DM (2008) *Current Neurovascular Research*, 5 266-272.
12. McCloskey M, Ben-Zeev D, Lee R, Berman M, Coccaro E (2009) *Psychopharmacology*, 203 53-61
13. Pine DS, Helfinstein SM, Bar-Haim Y, Nelson E, Fox NA (2009) *Neuropsychopharmacology*, 34 213-228.
14. Mann JJ, Apter A, Bertolote J, Beautrais A, Currier D, Haas A, Hegerl U, Lonnqvist J, Malone K, Marusic A, Mehlum L, Patton G, Phillips M, Rutz W, Rihmer Z, Schmidtke A, Shaffer D, Silverman M, Takahashi Y, Varnik A, Wasserman D, Yip P, Hendin H (2005) *J. American Medical Association*, 294 2064-2074.
15. Miklowitz DJ, Johnson SL (2006) *Annual Review of Clinical Psychology*, 2 199-235.
16. Asberg M, Traskman L, Thoren P (1976) *Arch. Gen. Psychiatry*, 33 1193-1997.
17. Mann JJ (2003) *Nat. Rev. Neurosci*, 4 819-828.
18. Mann JJ, Malone KM, Sweeney JA, Brown RP, Linnoila M, Stanley B, Stanley M, (1996) *Neuropsychopharmacology*, 15 576-586.
19. Lidberg L, Belfrage H, Bertilsson L, Evenden MM, Asberg M (2000) *Acta Psychiatr, Scand.* 101 395-402.
20. Placidi GP, Oquendo MA, Malone KM, Huang YY, Ellis SP, Mann JJ (2001), *Biol. Psychiatry*, 50 783

21. Cremniter D, Jamain S, Kollenbach K, Alvarez JC, Lecrubier Y, Gilton A, Jullien P, Lesieur P, Bonnet F, Spreux-Varoquaux O (1999) *Biol. Psychiatry*, 45 1572-1579.
22. Valuck RJ, Libby AM, Sills MR, Giese AA, Allen RR (2004) *CNS Drug*, 18 1119-1132.
23. Stanley M, Mann JJ (1983) *Lancet*, 1 214-216.
24. Gross-Isserdorf R, Israeli M, Biegon A (1989) *Archives of General Psychiatry*, 46 237-241.
25. Leake A, Fairbairn A, McKeith I, Ferrier I (1991) *Psychiatry Research*, 39 155-165.
26. Arango V, Underwood M, Mann JJ (1997) *New York Academy of Sciences*, 836 269-287.
27. Mann JJ, Huang Y, Underwood M, Kassir S, Oppenheim S, Kelly T, Dwork A, Arango V (2000) *Archives of General Psychiatry*, 57 739-740.
28. Owen F, Chambers D, Cooper S, Crow T, Johnson J, Lofthouse R, Poulter M (1986) *Brain Research*, 362 185-188.
29. Arora R, Meltzer H (1989) *American Journal of Psychiatry*, 146 730-736.
30. Lawrence K, De Paermentier F, Cheetham S, Crompton M, Katona C, Horton R (1990) *Brain Research*, 526 17-22.
31. Hrdina P, Demeter E, Vu T, Sotonyi P, Palkovits M (1993) *Brain Research*, 614 37-44.
32. Lowther S, de Paermentier F, Cheetham S, Crompton M, Katona C, Horton R (1997) *Journal of Affective Disorders*, 42 199-207.
33. Arató M, Tekes K, Tothfalusi L, Magyar K, Palkovits M, Demeter E, Falus A (1987) *Psychiatry Research*, 21 355-356.
34. Demeter E, Tekes K, Majorossy K, Palkovits M, Soos M, Magyar K, Somogyi E (1989) *Life Sciences*, 44 1403-1410.
35. Arató M, Frecska E, MacCrimmon D, Guscott R, Saxena B, Tekes K, Tothfalusi L (1991) *Progress in Neuropsychopharmacology and Biological Psychiatry*, 15 759-764.
36. Stanley M, Traskman-Bendz L, Dorovini-Zis K (1985) *Life Sciences*, 37 1279-1286.
37. Oreland L, Wiberg A, Asberg M, Traskman L, Sjostrand L, Thoren P, Bertilsson L, Tybring G (1981) *Psychiatry Research*, 4 21-29.
38. van Praag HM (1982) *J. Affective Disorders*, 4 275-290.
39. Banki CM, Arato M, J. (1983) *J. Affective Disorders*, 5 223-232.
40. Banki CM, Arato M, Papp Z, Kurcz M (1984) *J. Affective Disorders*, 6 341-350.
41. Agren H (1983) *Psychiatric Developments*, 1 87-104.
42. Lopez-Ibor JJ, Saiz-Ruiz J, Perez de los Cobos JC (1985) *Neuropsychobiology*, 14 67-74.
43. Agren H (1980) *Psychiatry Research*, 3 225-236.
44. Traskman L, Asberg M, Bertilsson L, Lantto O, Schallin D (1981) *Archives General Psychiatry*, 37 761
45. van Praag HM, de Haan S (1979) *Psychiatry Research*, 1 219-224.
46. Mendelson SD (2000) *J. Affective Disorders*, 57 13-24.

47. Kovacic Z, Henigsberg N, Pivac N, Nedic G, Borovecki A (2008) *Progress in Neuro-Psychopharmacology & Biological Psychiatry*, 32 544–551.
48. Lester D (1995) *Pharmacopsychiatry*, 28 45-50.
49. Arranz B, Blennow K, Eriksson A, Mansson JE, Marcusson J (1997) *Soc. Biol. Psychiatry*, 41 1000-1009.
50. *Neuropsychopharmacology*, 15 576-586.
51. Roy A, Pickar D, Linnoila M, Potter WZ (1985) *Archives General Psychiatry*, 42 1181-1985.
52. Lambert G, Johansson M, Gren H, Friberg P (2000) *Archives General Psychiatry*, 57 787-793.
53. Engstrom G, Alling C, Blennow K, Regnell G, Traskman-Bendz L (1999) *European Psychopharmacology*, 126 399
54. Roy A, Lamparski D, de Jong J, Adinoff B, Ratviz B, George DT, Nutt D, Linnoila M (1990) *Acta Psychiatry Scandinavia*, 81 58-61.
55. Roy A, de Jong J, Linnoila M (1898) *Archives General Psychiatry*, 46 609-612.
56. Schildkraut JJ (1965) *American Journal Psychiatry*, 122 509-522.
57. Traskman L, Asberg M, Bertilsson L, Sjostarnd L (1981) *Arch. Gen. Psychiatry*, 38 631
58. Papakostas GI, Thase ME, Fava M, Nelson JC, Shelton RC (2007) *Biological Psychiatry*, 62 1217-1227.
59. Engstrom G, Alling C, Blennow K, Regnell G, Traskman-Bendz L (1999) *European Neuropsychopharmacol*, 9 399-405.
60. Atmaca M, Kuloglu M, Tezcan E, Ustundag B (2008) *Psychiatry Res*, 158 87-91.
61. Diaz-Sastre C, Baca-Garcia E, Perez-Rodriguez MM, Garcia-Resa E, Ceverino A, Saiz-Ruiz J, Oquendo MA, de Leon J (2007) *Prog. Neuropsychopharmacol. Biol. Psych*, 31 901-905.
62. Sarchiapone M, Camardese G, Roy A, Della Casa S, Satta M.A, Gonzalez, B, Berman J, De Risio S (2001) *J. Affect. Disord*, 62 217-219.
63. Alvarez J, Cremniter D, Gluck N, Quintin P, Leboyer M, Berlin I, Therond P, Spreux-Varoquaux O, (2000) *Psychiatry Res*, 95 103-108.
64. Kima YK, Paik JW, Lee SW, Yoon D, Han C, Lee BH, (2006) *Progress in Neuro-Psychopharmacology & Biological Psychiatry*, 30 1091-1096.
65. Rasmusson AM, Pinna G, Paliwal P, Weisman D, Gottschalk C, Charney D, Krystal J, Guidotti A (2006) *Biol. Psychiatry*, 60 704-713.
66. Jokinen J, Samuelsson M, Nordström AL, Nordström P (2008) *Journal of Affective Disorders*, 111 119-124.
67. Sullivan GM, Mann JJ, Oquendo MA, Lo ES, Cooper TB, Gorman JM *Biol Psychiatry* (2006) 60 500-506.
68. Bergquist J, Sciubisz A, Kaczor A, Silberring J, *Neurosci J* (2002) *Methods*, 113 1-13.
69. Fri CG, Wiesel FA, Sedvall G, (1974) *Life Sci*, 14 2469-2480.
70. Yoshitake T, Fujine K, Kehr J, Ishida J, Nohta H, Yamaguchi M, (2003) *Anal Biochem*, 312 125

71. Zangen A, Overstreet DH, Yadid G, (1997) *J. Neurochem*, 69 2477-2483.
72. Poceta JS, Parsons L, Engelland S, Kripke DF (2007) *Sleep Medicine*, corrected proof, DOI: 10.1016 / J. Sleep.11.002.
73. Zhao E, Suo YR (2008) *Talanta*, 76 690-697.
74. Zangen A, Overstreet DH, Yadid G (1997) *J. Neurochem*, 69 2477-2483.
75. Poceta JS, Parsons L, Engelland S, Kripke DF (2007) *Sleep Medicine*, corrected proof, DOI: 10.1016 / J. Sleep11.002.
76. Zhao E, Suo YR, (2008) *Talanta*, 76 690-697.
77. Sher L, Oquendo M, Shuhua L, Burke AK, Grunebaum MF, Zalsman G, Huang Y, Mann JJ (2005) *European Neuropsychopharmacology*, 15 203-209.
78. Musshoff F, Menting T, Madea B (2004) *Forensic Sci. Int.*, 142 211-219.
79. Lionetto L, Lostia MA (2008) *Clin. Chim. Acta*, 398 53-56.
80. de Jong WHA, Graham KS, de Vries EGE, Kema IP (2008) *J. Chromatogr. B* 868 28.
81. Yang Z, Zhang X, Guo H, Gan Y (2006) *Anal. Lett.*, 39 1837.
82. Aymard N, (2002) *Prog. Neuro-Psychopharmacol. Biol. Psych.* 26 975-988.
83. Carrera V, Sabater E, Vilanova E, Sogorb MA (2007) *J. Chromatogr. B*, 847 88-94.
84. Paik MJ, Yu J, Hu MB, Kim SJ, Kim KR, Ahn YH, Choi S, Lee G (2008) *Clin. Chim. Acta*, 396 62.
85. Vuorensola K, Sirén H, Karjalainen U (2003) *J. Chromatogr. B*, 788 277-289.
86. Kawasaki T, Higuchi T, Imai K, Wong OS (1989) *Anal. Biochem.* 180 279-285.
87. Ishida J, Yoshitake T, Fujino K, Kawano K, Kehr J, Yamaguchi M, (1998) *Anal. Chim. Acta*, 365 227-232.
88. Fujino K, Yoshitake T, Kehr J, Nohta H, Yamaguchi M, (2003) *J. Chromatogr. A*, 1012 169-177.
89. Camacho A, J.E. Dimsdale, (2000) *Psychosom. Med.* 62 326-336.
90. Lesch P, Balling U, Gross J, Strauss K, Wolozin BL, Murphy DL, Riederer P (1994) *J. Neural. Transm.* 95 157-162.
91. Pivac N, Jakovljevic M, Muck-Seler D, Brzovic Z (1997) *Psychiatry Res*, 73 123-132.
92. Muck-Seler D, Jakovljevic M, Pivac N, (1996) *J. Affect. Disord.* 39 73-80.
93. Reuster T, Rilke O, Oehler J (2002) *Psychopharmacology*, 162 415-418.
94. Jorgensen S, Nielsen EO, Peters D, Dyhring T (2008) *J. Neurosci. Methods*, 169 168-176.
95. Adcock JL, Barnett NW, Costin JW, Francis PS, Lewis SW (2005) *Talanta*, 67 585-589.
96. Xu HH, Zhang W, Wang D, Zhu W, Jin LT (2007) *Journal of Chromatography B-Analytical Technologies in the Biomedical and Life Sciences*, 846 14-19.
97. T. Z. Peng, L. J. Yang, H. P. Li, G. S. Wang, J. Q. Hong. (1995) *Chemical Journal of Chinese Universities-Chinese*, 16 1847
98. Xu F, Gao MN, Shi GY, Wang L, Zhang W, Xue J, Jin LT, Jin JY (2001) *Anal. Chim. Acta*, 439 239-246.

-
99. Zheng JH, Zhu W, Wang D, An YR, Zhang W, Jin LT, (2008) Chinese Journal of Analytical Chemistry, 36 1316
 100. Goyal RN, Oyama M, Gupta VK, Singh SP, Sharma RA (2008) Sensors and Actuators B-Chemical, 134 816-821.
 101. Xu H, Wang D, Zhang W, Zhu W, Yamamoto K, Jin LT (2006) Anal.Chim.Acta, 577, 207-213.
 102. Goyal RN, Oyama M, Gupta VK, Singh SP, Sharma RA (2008) Sensors and Actuators B-Chemical, 134 816-821.
 103. Zhang W, Wan FL, Xie YF, Gu J, Wang J, Yamamoto K, Jin LT (2004) Anal.Chim.Acta, 512, 207-214.
 104. Zhang W, Xie YF, Ai SY, Wan FL, Wang J, Jin LT, Jin JY (2003) Journal of Chromatography B-Analytical Technologies in the Biomedical and Life Sciences, 791 217-225.
 105. Yang ZD, Zhang XZ, Guo H, Gan YR (2006) Anal.Lett, 39, 1837.
 106. Xu H, Wang D, Zhang W, Zhu W, Yamamoto K, Jin LT (2006) Anal.Chim.Acta, 577 207-213.
 107. Xu F, Gao MN, Shi GY, Wang L, Zhang W, Xue J, Jin LT, Jin JY (2001) Anal.Chim.Acta 439 239-246.
 108. Zhang W, Cao XN, Wan FL, Zhang S, Jin LT (2002) Anal.Chim.Acta, 472 27-35.
 109. Zhang S, Xu Q, Zhang W, Jin LT, Jin JY. (2001) Anal.Chim.Acta, 427, 45-53.
 110. Zhang W, Xie YF, Gu J, Ai SY, Wang J, Yamamoto K, Jin LT (2004) Analyst, 129 229-234.
 111. Zhang W, Cao XN, Xie YF, Ai SY, Jin LT, Jin JY (2003) Journal of Chromatography B-Analytical Technologies in the Biomedical and Life Sciences, 785 327-336.
 112. Jiang XH, Lin XQ (2005) Anal.Chim.Acta, 537 145-151.
 113. Li J, Lin X (2007) Sensors and Actuators B-Chemical 124 486-493.
 114. Bukola E, Sharp D, Marti-Villalba M, Davis J (2008) Journal of Physics and Chemistry of Solids, 69 2932

Chapter 6

Catalytic Composites – Determination of Ascorbate

Abstract

The present chapter outlines the development and characterisation of a ferrocene composite electrode for the selective detection of ascorbic acid. The electrode material has been shown to be capable of use as either a discrete, reagentless sensor or as a detection system for use in both flow injection and liquid chromatographic analysis. The electrode was evaluated as a sensor for the determination of ascorbic acid in commercial tablets and beverages. In addition, its viability for use in more complex samples was assessed through the determination of ascorbic acid in human saliva.

6.1. Introduction

Ascorbic acid (vitamin C) is one of the most important water soluble vitamins and plays many different roles within the body. Its antioxidant properties prevent the oxidation of low density lipoproteins (LDL) which are implicated in the development of atherosclerosis and neutralises free radicals before they can damage macromolecules such as proteins or DNA [1]. The attack of free radicals on the latter and its subsequent damage can ultimately lead to the development of cancer. Different theories have been proposed to explain how this antioxidant can help in the prevention or minimisation of the latter – the most prominent being that the ascorbate neutralises free radicals before they can interact with the cellular machinery responsible for cell division and repair. In contrast, it has been proposed that it is the pro-oxidant properties of ascorbic acid that can help the body to generate its own free radicals to destroy the tumours. There is as yet inconclusive evidence for the latter and there is much debate where some studies have shown that ascorbate acts as pro-oxidant when present in low amounts – others when it is found in excess [2]. The vitamin does however have a much more general role as a protective agent and is responsible for recycling other antioxidants such as glutathione and α -tocopherol (vitamin E). It also has a pivotal role in the regeneration / synthesis of collagen which is critical for wound healing. The provision of adequate amounts of the vitamin is clearly important and there are numerous food and health products which seek to use their ascorbate content (natural or additive) as a marketing aid.

The great interest in vitamin C content from the agri-food-health sectors stems from the fact that humans lack the enzyme responsible for the *de novo* synthesis and thus the need for dietary provision. Fortunately, it is present in many vegetables and fruits. Given the increasing public interest in the health foods, supplements and nutrition – there is considerable demand for processes and technologies that can measure and/or monitor the concentration of ascorbate – within agri-food products but also within body fluids. The levels of ascorbic acid in the latter (ie blood, urine or saliva)_could, in principle, be used to determine the level of oxidative stress that an individual may be subject to and

therefore has some, albeit contentious, merit as a preventative screening tool for the onset of disease or illness.

Many different techniques have been used for its determination such as colorimetric[3-7], electrochemical[8,9], chromatographic[10-12], chemiluminescence[13-15] and fluorimetric[16-18]. Among them, the electrochemical techniques have the advantage of simplicity and low cost if compared with the spectroscopic procedures and avoids the need for derivatisation procedures. The main problem encountered in the electroanalytical detection of ascorbic acid is the interference of uric acid. Both ascorbate (AA) and uric acid (UA) have similar anodic potentials and the oxidation peaks invariably overlap [19]. One of the most promising routes through which this problem can be remedied is the modification of the electrode surface with polymers or metal complexes as indicated in **Table 6-1**.

Base electrode	Modification	Sample	Application	Ref
GCE	Db71	AA, UA	Commercial Tablets	18
GCE	SWCNTs/DNA	DA, UA, AA	NA	19
GCE	P3MT/Au nanoparticles	DA, AA, A	Urine	23
CF	p-ABSA / ADN	AA, UA	NA	25
GCE	PAN / ABSA	AA, UA	NA	26
GCE	Au nanoparticles	AA UA	Urine	29
—	(Fe ³⁺ / ZMCPE)	Try, AA, UA	NA	32
—	Th(IV)Hexacyanoferrate CPE	AA	NA	33
Graphite rod	CoHCF	AA	Commercial samples	34
GCE	PAR	AA,UA	NA	35
—	PEG /Cu ₂ O CPE	AA, sugars	beverages	36

Abbreviations: Glassy Carbon Electrode (GCE), Carbon fiber (CF), Single wall carbon nanotubes (SWCNTs), Azo Dye Direct blue(DB71), poly (3-methylthiopene) (P3MT), Zeolite Modified Carbon Paste, Electrode (ZMCPE), Cobalt Hexacyanoferrate Modified Electrode (CoHCF), Poly(glutamic acid) (PAG), Polyethylene Glycol (PEG). Carbon Paste Electrode (CPE), Tryptophan (Try), Ascorbic Acid (AA), Uric Acid (UA).

Table 6-1: Modified electrodes for the detection of ascorbic acid

The most commonly used base material for electrode construction is carbon due to the wide potential window and the easy modification of its surface. Among carbon materials, carbon nanotubes have attracted considerable interest as a surface modifier and it has been suggested that they possess catalytic properties toward different compounds – or which ascorbate is one - and that they enhance electron transfer[20-21]. Other common modification routes include the use of metal nanoparticles or complexes which enhance electron transfer [28-30]. Chemical or physical anodisation of carbon surface to obtain carboxylic, hydroxyl and keto groups is also commonly used to enhance electron transfer. Recently it has been reported that hydroquinone compounds have been used for the electrocatalysis of ascorbic acid, by the use of 2,2'-[3,6-dioxa-1,8-octanedylbis(nitroethylidene)-bis-hydroquinone to build a carbon paste electrode[37]. The present work builds on the approach of the previous chapter and the hydroquinone-paste system outlined by (Beitollahi et al, 2008). Instead of using a paste electrode, the work involved the construction of a polymeric matrix (polycarbonate) in which ferrocene was incorporated. It sought to develop an alternative to the paste system but in a format that could be more easily accommodated within either a distinct probe type sensor or for flow injection (FIA) or chromatographic (LC) analysis systems.

6.2. Experimental Details

6.2.1. Chemical and materials

All reagents were of the highest grade available and used without further purification. Redoxon and commercial Vitamin C tablets were purchased from Bayer. Rose-hip tea was made from *R. rugosa* collected from the field. Working solutions were prepared daily typically using either Britton Robinson or phosphate buffer (pH 7). Electrochemical measurements were conducted using an Autolab PGStat computer controlled potentiostat (Eco-Chemie, Utrecht, The Netherlands) using a three electrode configuration consisting of either a glassy carbon working electrode (3mm diameter, BAS Technical, UK) or a polycarbonate/carbon/ferrocene composite. Platinum wire

served as the counter electrode with a 3 M NaCl Ag | AgCl half cell reference electrode (BAS Technicol, UK) completing the cell assembly. Unless otherwise specified – all measurements were conducted without pre-degassing with the solution temperature being $22^{\circ}\text{C} \pm 2^{\circ}\text{C}$ throughout. For the determination ascorbate within commercial vitamin C tablets and saliva, a flow injection system (Gilson) was used with a BR-Buffer (pH 7) mobile phase at a flow rate of 1.2 mL / min. The detector consisted of a three electrode system with PC-Fc as the working electrode. Chromatographic analysis of ascorbate within the Rose-hip tea and saliva was done with an Agilent 1200 series HPLC system equipped with a quaternary pump. An ODS 150 \times 4.6 mm Spherclone 3 μm (Phenomenex) column was used throughout with a mobile phase consisting of 10 mM Phosphoric acid (pH 6.64) at a flow rate of 0.8 mL / min. The detection wavelength in all cases was 250 nm.

6.3. Results and Discussion

6.3.1. Sensor Construction

A solution consisting of polycarbonate granules dissolved in dichloromethane was mixed with carbon in a ratio 1:2 by weight in an analogous manner to that described in Chapter 5. Before adding the carbon however, 2% w/w of ferrocene (with respect to the carbon) was added. The polycarbonate-carbon-ferrocene (PC-Fc) mixture was stirred over a period of 15 minutes to ensure homogenisation. The mixture was then placed onto a glass surface and the solvent allowed to evaporate at room temperature to form a thin film. The construction of the electrode followed a similar procedure to that described in the previous chapter. A piece of the PC-Fc composite film was connected with a copper tape with both parts sandwiched between two pre-patterned laminate sheets by thermal means. A 3mm hole in the upper laminate served to expose the underlying PC-Fc composite.

6.3.2. Surface Characterisation

The composite was initially studied by scanning electron microscopy. A micrograph detailing the surface morphology of a representative sample is detailed in **Figure 6-1** and indicates that the surface of the electrode is irregular. There were no gross morphological differences between the two faces which is in contrast to the simple composite film discussed in the previous chapter. In the case of the polymer-carbon binary mixture examined previously - there was a marked difference in the electrochemical responses of the two faces. In this case no difference in the

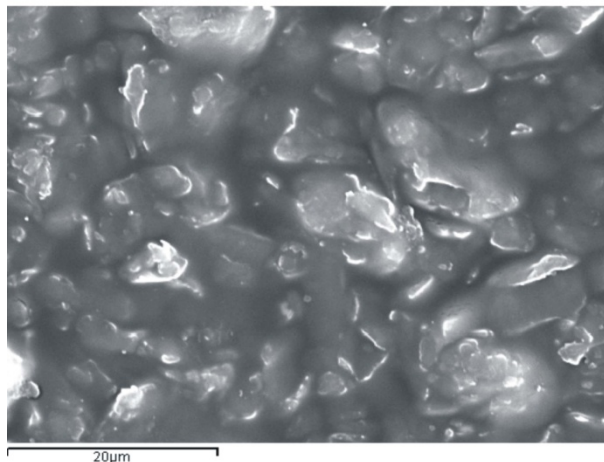

Figure 6-1: SEM image of the PC-Fc composite electrode

electrochemical performance was observed. This could be expected given there was no morphological difference in the faces of the PC-Fc film.

Elemental analysis (SEM-EDX) confirmed the presence of iron and thereby the inclusion of ferrocene. Different regions of the film were subsequently studied to ensure the homogeneity not only in the morphology but also in the distribution of the catalytic material within the electrode composition.

6.3.3. Electrochemical Characterisation

The sequential determination of ascorbic acid and uric acid with a commercial glassy carbon electrode can be difficult as the potential at which the analytes are oxidised are quite close which results in overlapping signals and an absence of selectivity. The addition of ascorbic acid to a solution of uric acid results in an increment

of the peak current of uric acid measured at a glassy carbon electrode as well as an increase in the width of the peaks as indicated in **Figure 6-2A**.

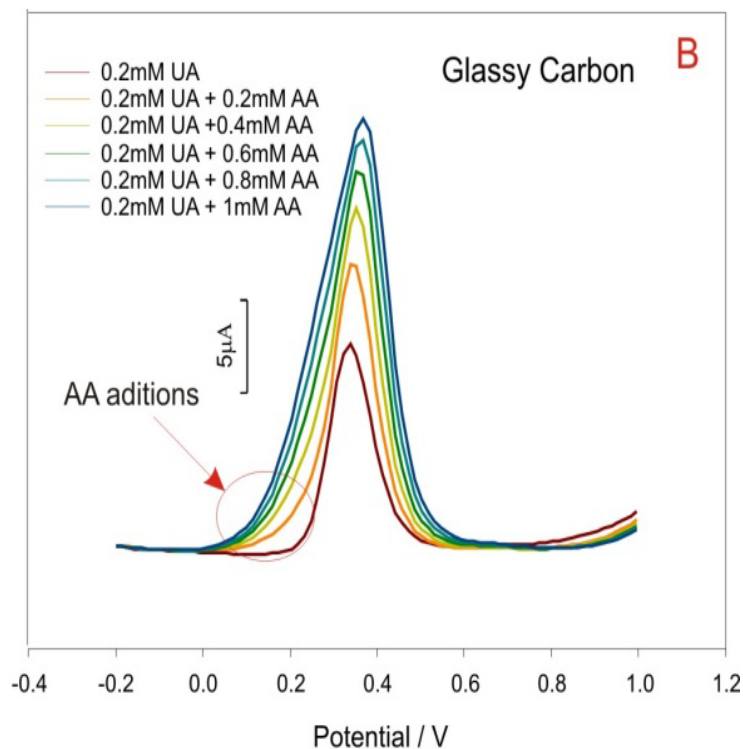

Figure 6-2: Squarewave voltammograms detailing the response of glassy carbon electrode to uric acid before and after the addition of aliquots of ascorbate.

It has been previously shown that ferrocene derivatives catalyse the oxidation of both ascorbic and uric acids [37,38]. In order to study the behaviour of the catalytic oxidation of ascorbic acid on the electrode surface, polymer-carbon composite electrodes with and without the mediator were prepared - the construction following the processes described in Chapter 5 within experimental section.

It can be anticipated that the ferrocene within the polycarbonate-carbon framework would catalyze ascorbic acid oxidation by an EC' mechanism, where the chemical reaction that follows the electron transfer regenerates the starting material. Cyclic voltammograms detailing the electrode response to increasing additions of ascorbate are shown in **Figure 6-3**. The catalytic oxidation peak current was linearly dependent on the concentration of ascorbic acid within an experimental range from 50

μM to $250 \mu\text{M}$ according to: Electrode Response $\mu\text{A} = 5 \times 10^{-9} [\text{AA} / \mu\text{mol L}^{-1}] + 3 \times 10^{-8}$, $R^2 = 0.9956$,

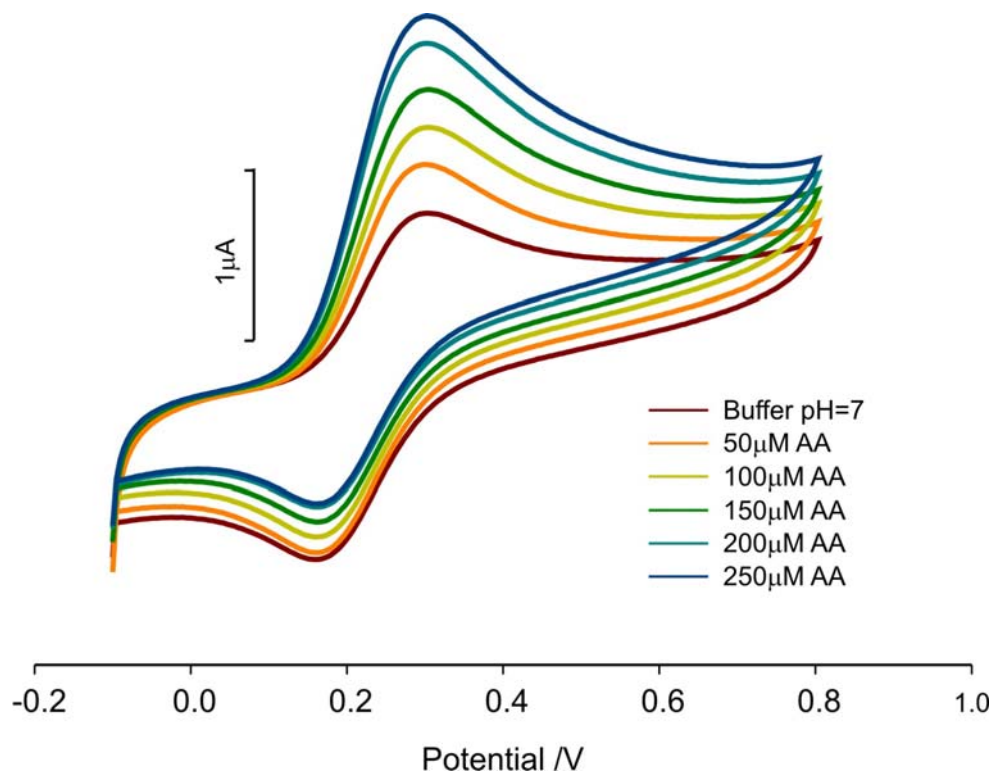

Figure 6-3: Cyclic voltammograms detailing the response of the PC- F_c composite electrode towards increasing additions of ascorbic acid. Scan rate 0.1 V/s

The response to increasing scan rate was then investigated to establish whether the ferrocene was behaving as a freely diffusing species or one immobilised on the surface. The resulting voltammograms are detailed in **Figure 6-4** with the corresponding peak height vs scan rate plot shown in the inset.

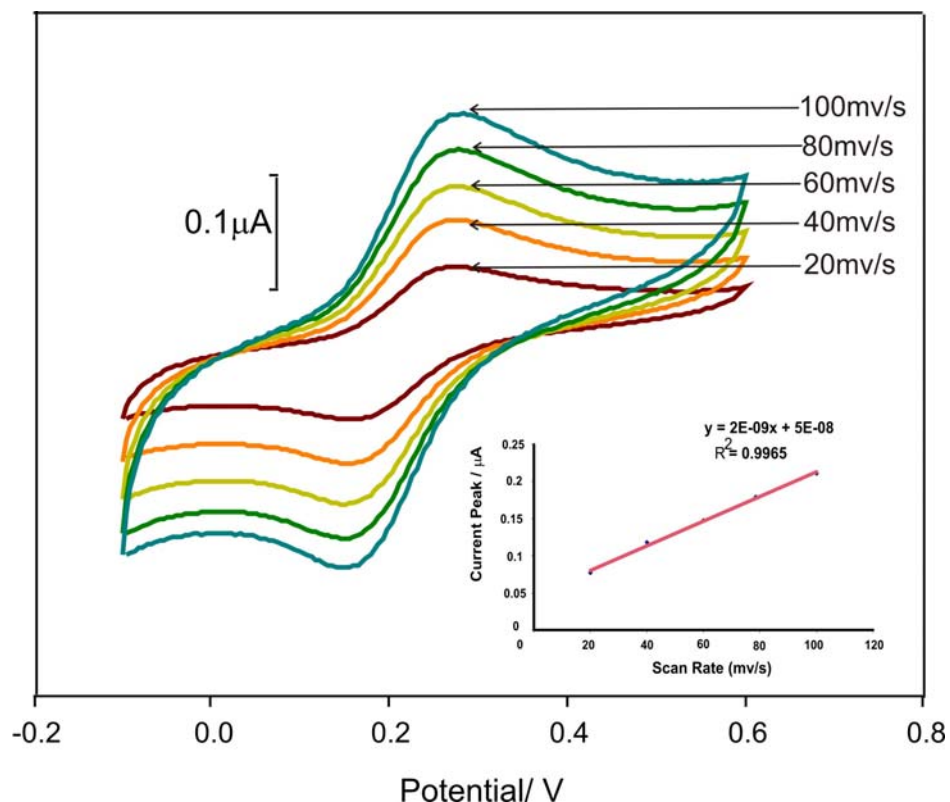

Figure 6-4: Cyclic voltammetry of the PC-Fc electrode in Britton Robinson buffer pH=7 at different scan rates.

As anticipated, the plot of the scan rate versus the peak current gives a linear response: Peak Current (A) = 2×10^{-9} [Scan Rate (mV/s)] + 5×10^{-8} , which is consistent with the ferrocene being effectively immobilized onto the electrode. This can be explained by the insolubility of the ferrocene in aqueous solution such that it remains at the interface. Further corroboration was provided by examining the relationship between peak height against the square root of the scan rate (not shown) which gave a curved profile. This fits with previous experimental finding where the peak magnitude of the ferrocene was not found to diminish when the electrode was repeatedly placed in fresh pH 7 buffer. Had the ferrocene not been insoluble then it would have diffused into the bulk solution such that subsequent measurement would result in a decrease in peak height.

Squarewave voltammograms detailing the response of the PC-Fc –Ferrocene is incorporated within the polycarbonate- electrode towards ascorbate is shown in **Figure 6-4**. A linear increase in the magnitude of the oxidation peak is observed and is similar to that observed with the cyclic voltammetry results in **Figure 6-3**. The introduction of urate however did not unduly influence the ferrocene peak nor the catalysis of the ascorbate and resolution between the latter and urate is clearly possible. Unlike the response obtained with the GC electrode, **Figure 6-2**, PC-Fc the composite is able to separate the two analytes as illustrated in **Figure 6-5**.

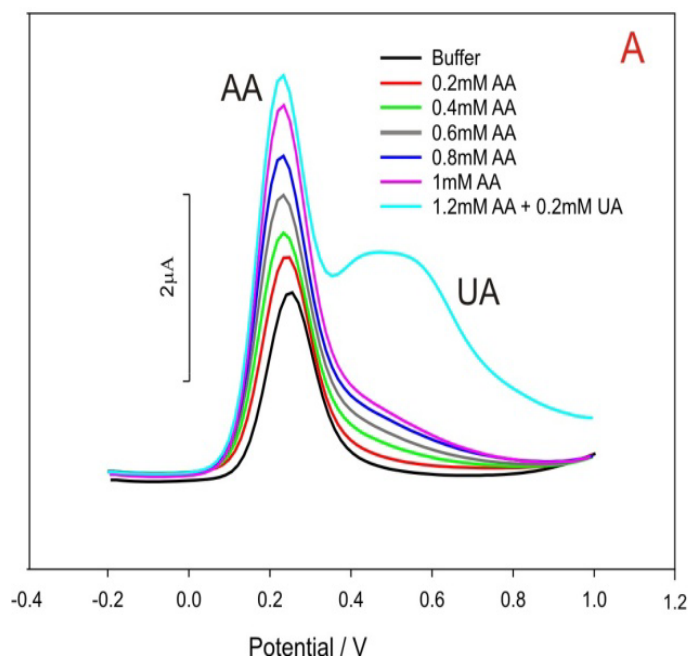

Figure 6-5: Squarewave voltammograms of different concentrations of ascorbic acid in the presence of uric acid recorded at a PC-Fc electrode

6.3.4. Electrode Stability.

The main problem of mediated composite electrodes is the stability of the mediator within the electrode. As mentioned previously, Ferrocene is largely water insoluble, so it is unlikely to diffuse into the bulk test solution. However, oxidation

results in the product of the ferrocinium ion, Fc^+ , which, as a consequence of the charged nature could be expected to be slightly soluble in water and, as such, could be released from the electrode to the solution. A number of experiments were conducted to assess leaching. The first experiment had the aim of proving the stability of ferrocene after the application of an oxidative potential. A potential of 0.8V was applied

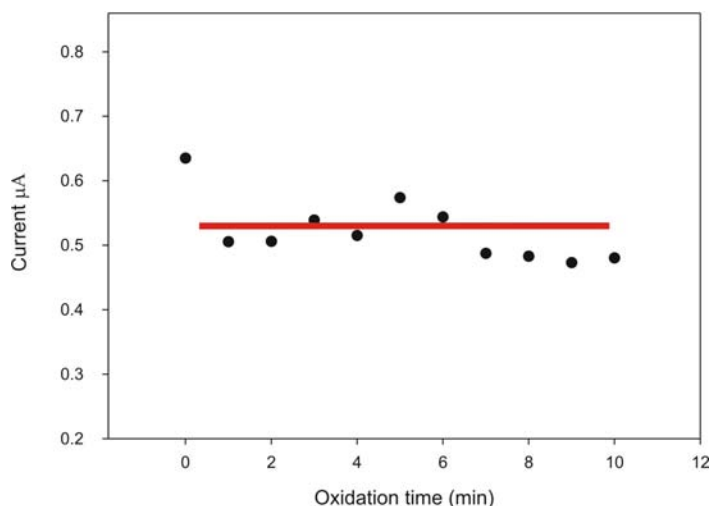

Figure 6-6: Stability assay of the ferrocene composite showing the peak current after different oxidation times.

over a period of 1 minute during which the solution was stirred. It could be anticipated that forced convection would remove the Fc^+ from the electrode surface. A cyclic voltammogram was recorded before and after the oxidative conditioning potential. This was repeated ten times. The electrode was reasonably stable as indicated in **Figure 6-6** where there is very little degradation in the peak height response. After the first minute, the electrode varies a little but it remains constant thereafter. This can be attributed to the initial charging of the electrode interface and removal of loosely bound material. It is possible to confirm that the mediator does not dissolve into the solution after submitting the electrode to prolonged anodic conditions.

This partly addresses the issue of using mediated electrodes in flow systems. In bulk solutions, if the electrode loses an amount of the mediator, the latter will still be present in the solution at the interface and could be recaptured upon the re-reduction of the mediator. However in flow systems, the mediator could be permanently displaced from the electrode surface by the flow and removed to waste and therefore no possibility of recovering the latter. The leaching of the mediator from the electrode under such circumstances would result in a loss of catalytic capability and hence sensitivity. It is important that, in this instance, the oxidative conditioning under stirred conditions did not

result in any significant loss of the mediator. In a follow up experiment - the same electrode was used over a period of seven days accounting for almost 18h operation within a flow cell at a fixed potential of 0.2V – the detection potential required for the analysis of ascorbate. No loss in sensitivity was observed and confirms the potential for its use both as sensor substrate or for incorporation within FIA or LC systems.

6.3.5. Ascorbic Acid Detection

The next phase was to assess the performance of the electrode in the analysis of ascorbate within authentic samples of varying complexity. After the construction of the electrode, we applied it for the detection of ascorbic acid within different matrixes, and we compared the results with the commercial amounts indicated in the labels to demonstrate the accuracy of the sensor.

6.3.5.1. FIA Analysis of Vitamin C

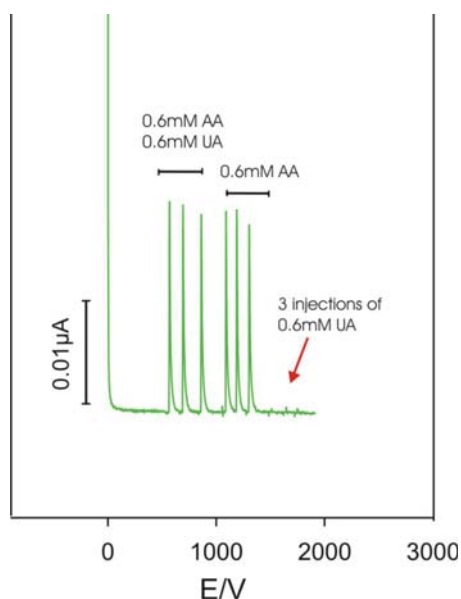

Figure 6-7: FIA of ascorbic acid and uric acid with the PC-Fc electrode.

The first stages of the analytical investigation focused on the use of Redoxon tablets which are basically ascorbic acid along with some binders and flavourings. A second experiment involved Ribena, a blackcurrant soft drink which is marketed on its reputed high vitamin C content. In both cases, the analysis was done in a flow injection system (FIA) with a home made electrochemical cell (similar to that described in Chapter 5). The electrochemical cell consisted of a three electrode system. The PC-Fc electrode was used as a working electrode, silver/silver chloride wire previously anodised in

3M potassium chloride was used as the reference electrode and a platinum wire as a counter electrode. To overcome the interference of Uric acid in the analysis we choose a potential of +0.2 V which was enough for the oxidation of ascorbic acid and avoids the oxidation of uric acid. **Figure 6-7** shows that the electrode responds to ascorbic acid, however when uric acid was injected through the flow system no signal was observed. In addition, the injection of an equimolar mixture (0.6mM) of ascorbic acid and uric acid gave the same response that the injection of the same amount of ascorbic acid. This demonstrates that ascorbic acid can be detected in the presence of uric acid. Once the correct potential was set, a calibration for the quantification of Vitamin C was conducted and is detailed in **Figure 6-8**.

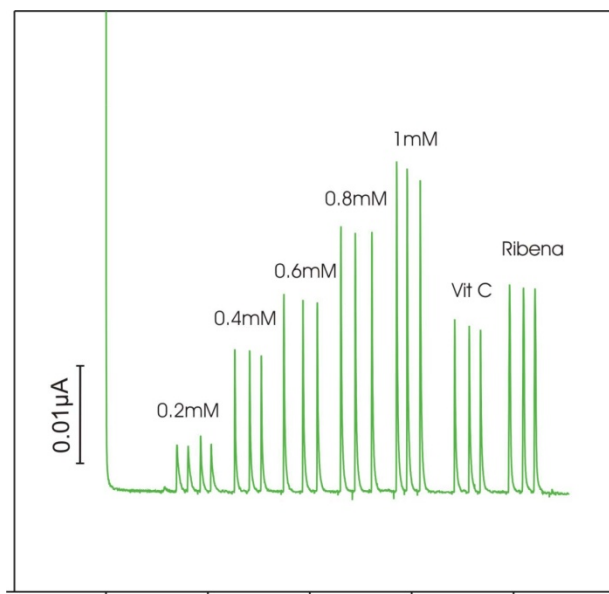

Figure 6-8: FIA of Vitamin C present in Redoxon tablets and in a Ribena soft drink

A linear response was obtained with increasing concentrations of ascorbic acid (peak height = 3×10^{-8} [ascorbic acid / mmol L⁻¹] - 3×10^{-10} ; N = 3; R² = 0.996). Moreover, the repetitive injection of the sample yielded excellent height and area reproducibility as shown in Figure 6-8. Commercial Redoxon tablets contain 1000mg of ascorbic acid per pill. A solution of 0.57mM of Ascorbic acid in distilled water was prepared and then directly injected (10µL loop). The solution was injected three times and the FIA analysis gave a concentration of 0.58 mM (N=3 %RSD=0.0187) of ascorbic acid. In the case of

the Ribena analysis, 5 mL of the blackcurrant drink was diluted up to 10 mL with distilled water, resulting in a solution containing 0.68mM of ascorbic acid (according to the nutritional data supplied by the manufacturer). The FIA analysis indicated a concentration of 0.716mM (N=3, %RSD=0.63) of ascorbic acid. In both cases the value obtained with the composite electrode was under 5% the theoretical value, 1.7% for Redoxon tablets and 4.97% for Ribena drink.

6.3.5.2. Determination of Ascorbate in Rose Hip Tea.

Rose Hip tea is made from rose hip which is the fruit of the rose plant. These fruits have a high content of vitamin C and often more than citrus fruits. As such, they are highly valued for their alleged medicinal properties when prepared as an infusion or tea. Rose hips were collected and cut into small pieces and 6g samples of the rose hip boiled with 100 mL of distilled water during 15 minutes. The Tea was then filtered and stored at 4°C until used. The response of a glassy carbon electrode to the introduction of an aliquot (200 μ L) of rose hip tea is shown in Figure 6-9 and is compared with the PC-Fc electrode. An anodic peak at 0.46V with the glassy carbon electrode was observed and was taken to indicate the presence of ascorbic acid. As expected, the peak shifted toward a less positive potential 0.34V when the PC-Fc electrode was used as a working electrode and a catalytic behavior was observed due to the ferrocene immobilized on and in the electrode.

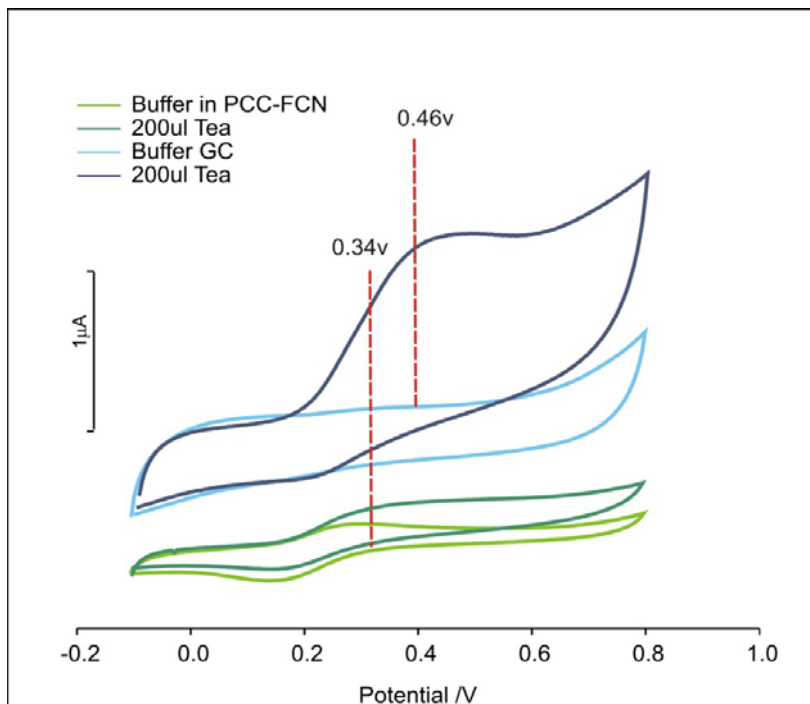

Figure 6-9: Cyclic voltammograms detailing the response of the Rose Tea with a glassy carbon electrode and with the PC-Fc electrode. Scan rate 0.1V/ s

To corroborate the presence of ascorbic acid, and to validate the method, rose hip tea was injected - after filtration- to the HPLC-UV system in which we coupled the electrochemical cell containing the PC-Fc composite electrode. In this case and because the absence of uric acid we applied a potential of 0.3v. The results are shown in **Table 6-2**.

	HPLC-UV	HPLC-EC
Sample 1	8.81mg/g	7.96mg/g
Sample2	12.53mg/g	11.22mg/g
Sample 3	11.77mg/g	11.4mg/g

Table 6-2: Ascorbic acid concentration of different extractions of rose hip tea measured with a uv detector and with the composite electrode.

We obtained similar results with both detectors; the spectrometric detector incorporated to the HPLC and the coupled electrochemical detector with the former serving to validate the response of the sensing properties of the PC-Fc electrode. The investigation thus far has had the sensor always coupled with a flow system. In order to simplify the method, the analysis was conducted using chronoamperometry with the PC-Fc electrode within a quiescent solution. In chronoamperometry, the mass transfer occurs mainly by diffusion, herein the current of interest is that at fixed time after the imposition of the oxidizing (detection) potential. Representative current-time profiles for the analysis of Rose Hip tea recorded at +0.3 V are shown in **Figure 6-10**.

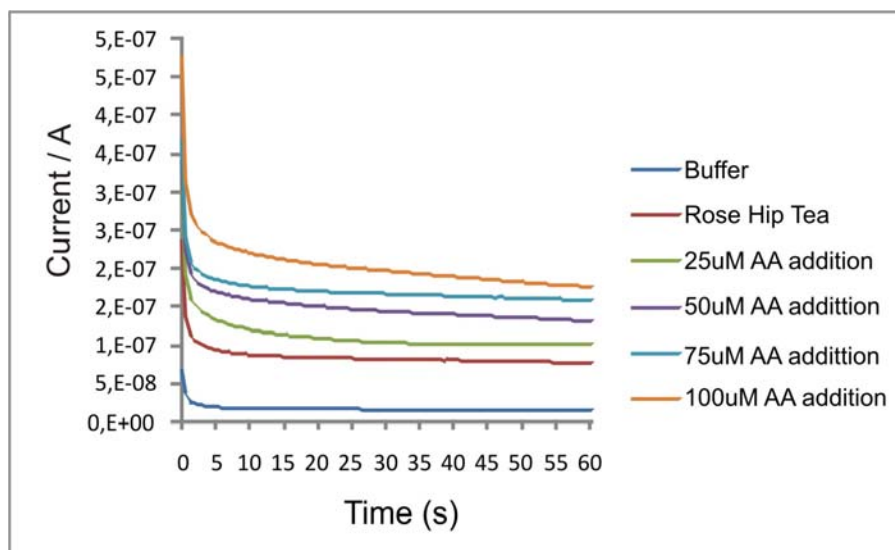

Figure 6-10: Chronoamperometry of the Rose Hip tea solution before and after the addition of different concentrations of AA

In order to be directly representative, the same samples used to do the HPLC experiments were analysed with the chronoamperometric technique. The samples were stored in the freezer until the same day of the experiment. The results are presented in **Table 6-3**.

Sample 1	8.55mg/g
Sample 2	11.69mg/g
Sample 3	11.22mg/g

Table 6-3: Ascorbic acid concentrations obtained with the composite electrode by transient chronoamperometry

The results obtained with transient chronoamperometry were similar to those obtained before with the HPLC-UV and HPLC-EC. This confirms the validity of the system. Thus the PC-Fc electrode can be used for quantitative determinations of AA using a variety of instrumental platforms – sensor or detector.

6.3.5.3. Determination of AA in Human Saliva

As mentioned before, one of the main problems for electrochemical detection of ascorbic acid is the lack of selectivity due to the interference of other substances such as uric acid. Biological fluids such as saliva are quite complex and it could be expected that their analysis could be difficult. The aim of this section is to demonstrate that the sensor could be used in more complex samples without the interference from uric acid.

Saliva was collected from volunteers and stored at 4°C until the moment of analysis. The analysis was achieved using the same procedure as detailed above with an HPLC system with an UV-detector and which was then compared with PC-Fc sensor coupled with a FIA system. The main advantage of HPLC is that we can separate the possible interferences that could compromise the response of the sensor but the sample preparation is complex if compared with the FIA system. Because of the dimensions of the particles of the chromatographic column, it is necessary to precipitate large molecules such as proteins in order to avoid the obstruction of the column. The FIA has no column

and relies solely upon the selectivity of the detector – thus a more simple system which also allows direct injection of the sample.

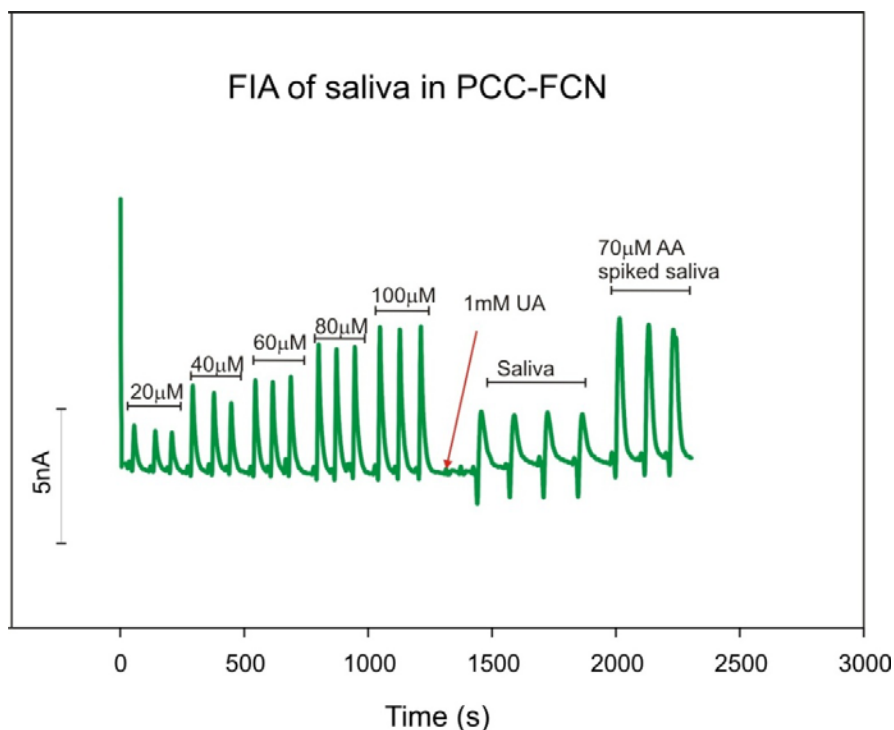

Figure 6-11: Flow injection analysis of saliva

For the precipitation of large molecules, the sample was treated with acetonitrile (ACN) then centrifuged over a period of 15 minutes at 11000 rpm. The recovery experiments with the HPLC system showed poor reproducibility, and it was thought that this may be due to the fact that the dissolution of the sample with ACN will change the electrolyte content going through the detector; this may affect the conductivity and therefore the electrode response. For the FIA experiments the saliva was diluted with phosphate buffer (pH 7) and centrifuged to precipitate the larger molecules, but no ACN was added. The injected saliva sample acts as a blank and then the saliva was spiked (standard addition procedure) with 70 μM of ascorbic acid. The recovery experiments conducted are shown in Figure 6-11 with the results presented in **Table 6-4**

N	RSDblank	RSD additions	Recovery
3	4.19%	3.76%	103.1%

Table 6-4: Recovery results from the flow injection analysis of saliva

6.4. Analytical Application

Different uses can be attributed to the sensor. The sensor was able to accurately quantify ascorbic acid in beverages and pharmaceuticals which can be used to evaluate the index of quality of the latter since it could easily vary during production and storage – especially where natural products are concerned. The sensor has also proved to be capable of quantifying ascorbic acid in complex matrixes such as saliva without the interference of uric acid. As mentioned briefly in the introduction, ascorbic acid is one of the main antioxidants in the body and its evaluation could be used for the determination of the level of oxidative stress and its effect on the general health of individuals. The ability to transfer the electrode to a sensor format is very encouraging as it could open an avenue for the development of point of care technologies based on the evaluation of ascorbate. Moreover, the greater availability of such detection systems could serve as a useful tool through which to encourage more clinical analysis that could be used to clarify the role of this antioxidant in the body.

6.5. Conclusions

The results confirm the viability of the sensor for the detection of ascorbic acid in the presence of uric acid in both simple and complex matrixes. The mediated, ferrocene composite electrode has been shown to have different catalytic behaviour toward ascorbic acid than uric acid, allowing the separation of both compounds. The principle of manufacture is relatively simple and could be easily adopted within general lab environments. In addition the format is considerably more flexible than the paste systems and provides a mechanically robust material in which the mediator is retain and can be applied in discrete sensing systems or in flow detection analysis.

6.6. References

1. Abudu N, Miller JJ, Attaelmannan M A, Levinson SS (2003) *Clinica Chimica Acta*, 339 11-25
2. Naidu K A (2003) *Nutritional Journal* 2 7-17
3. Wu S, Wang T, Gao Z, Xu H, Zhou B, Wang C (2008) 23 1776-1780
4. Blagojeviae N ZVukasinoviae-Pesiae V L. (2008)*Res.J.Chem.Envirion.*,18-22
5. .Ding Jian-Hua, Chen Huan-Wen, You Hai-Zhu, Hu Bin, Zhang Xie, Ren Yu-Lin. (2008)*Chinese Journal of Organic Chemistry*,1971-1977
6. Nejati-Yazdinejad M. (2007)*International Journal of Food Science and Technology*,1402-1407
7. .Salkic M, Jasic M, Keran H, Pasalic H. (2008)*Actual Tasks on Agricultural Engineering*,451-458
8. Schulz A, Trage C, Schwarz H, Kroh L W. (2007)*International Journal of Mass Spectrometry*,169-173
9. Civit L, Nassef H M, Fragoso A, O'Sullivan C K. (2008)*J.Agric.Food Chem.*,10452-10455
10. .ello A, Giannetto M, Mori G, Seeber R, Terzi F, Zanardi C. (2007)*Sensors and Actuators B-Chemical*,430-435
11. Burini G. (2007)*Journal of Chromatography a*,97-102
12. Fontannaz P, Kilinc T, Heudi O. (2006)*Food Chem.*,626-631
13. Maia A M, Baby A R, Yasaka W J, Suenaga E, Kaneko T M, Velasco M V R. (2007)*Talanta*,639-643
14. Dai H, Wu X, Wang Y, Zhou W, Chen G. (2008)*Electrochim.Acta*,5113-5117
15. Pires C K, Lavorante A F, Marconi L M T, Meneses S R P, Zagatto E A G. (2006)*Microchemical Journal*,70-74
16. Song Z, Yue Q, Xie X, Bian L, Lei G. (2006)*Chemia Analityczna*,499-508
17. Dilgin Y Nisli G. (2005)*Chem.Pharm.Bull.*,1251-1254
18. Iglesias J, Gonzalez M J, Medina I. (2006)*European Food Research and Technology*,781-786
19. Kumar S A, Lo P H, Chen S M. (2008)*Biosens.Bioelectron.*,518-523
20. Li Y X, Wang P, Li F, Huang X, Wang L, Lin X Q. (2008)*Talanta*,833-838
21. Yogeswaran U Chen S. (2007)*Electrochim.Acta*,5985-5996
22. Yogeswaran U Chen S. (2008)*Sensors and Actuators B-Chemical*,739-749
23. Huang X, Li Y X, Wang P, Wang L. (2008)*Analytical Sciences*,1563-1568
24. Liu A L, Chen W, Huang L Y, Lin X H. (2008)*Chem.Pharm.Bull.*,1665-1669
25. Lu L Lin X. (2008)*Electrochemistry Communications*,704-708
26. Zhang L, Zhang C H, Lian J Y. (2008)*Biosens.Bioelectron.*,690-695
27. Wu S, Wang T, Gao Z, Xu H, Zhou B, Wang C. (2008)*Biosens.Bioelectron.*,1776-1780

-
28. Holt-Hindle P, Nigro S, Asmussen M, Chen A C. (2008) *Electrochemistry Communications*, 1438-1441
 29. Hu G, Ma Y, Guo Y, Shao S. (2008) *Electrochim. Acta*, 6610-6615
 30. Huang J S, Liu Y, Hou H Q, You T Y. (2008) *Biosens. Bioelectron.*, 632-637
 31. Taleat Z, Ardakani M M, Naeimi H, Beitollahi H, Nejati M, Zare H R. (2008) *Analytical Sciences*, 1039-1044 .
 32. Babei A, Zendejdel M, Khalilzadeh B, Taheri A (2008) *Colloids and Surfaces B: Biointerfaces*, 226-232.
 33. Farhadi K, Kheiri F, Golzan M (2008) *J. Braz. Chem. Soc*, 1404-1412.
 34. Kumar SS, Narayanan SS (2006) *Chm. Pharm. Bull*, 963-967.
 35. Liu a, Chen W, Huang L, Lin X *Chem (2008) .Pharm. Bull*, 1665-1669.
 36. Ashok Kumar S, Po-Hsun L, Shen-Ming C (2008) *Biosensors and Bioelectronics*, 518-523.
 37. Fernández I, Carrero H (2005) *Electrochimica Acta* 50 1233-1240.
 38. Ndaanisha J C, Guo L (2008) *Biosensors and Bioelectronics* 23 1680-1685.

Chapter 7

Composites – Bioelectrochemical Detection Strategies

Abstract

The integration of biological components within an electrochemical device has given rise to a large number of different strategies – in terms of the immobilisation and interpretation of the resulting signal. A review was conducted of the different approaches taken and materials exploited over recent years. The relative merits and limitations are critically appraised and possible future strategies highlighted. The chapter aims to prepare the ground for the transformation of the composites developed in Chapter 5 and 6 to a foundation upon which to introduce enzyme recognition.

*The work presented has been accepted for publication as a book chapter within
“Composite Laminates: Properties, Performance and Applications”*

7.1. Introduction

The detection of biological molecules has always been of great interest but the complexity of many biofluids and the possible interference of other matrix components can often make the detection of the target analyte difficult. The resolution capabilities inherent to chromatographic techniques has led to the latter dominating much of the analytical research effort in recent years. There has, however, been an increasing interest in the development of decentralised testing whereby direct measurement and reporting of the analyte concentration is achieved at the site of the analysis – whether it be in the home, in the workplace or in the field. Electrochemical technologies have found a niche application in such technologies given their inherent suitability towards miniaturisation but their selectivity has always been open to question – particularly when compared with the more established laboratory based procedures. Composite systems based on the complex interplay of biological and synthetic recognition components with modern materials has led to a revolution in the applicability of such hybrid devices and has effectively opened up a new vista of analytical science.

The transfer of laboratory based systems for use by the average person has, until recently, been the dream of Science Fiction writers but the technology has matured considerably in the past few decades and numerous commercial products are now widely available within the retail sector. The devices offer rapid response and hence proffer the possibility of immediate action (i.e. glucose measurements by diabetics) or, in some instances, an opportunity for taking more long term preventative measures (typified by weekly cholesterol measurements). They obviate the need for the transfer of the samples to the lab, the inevitable delays in processing and the possibility of sample degradation that can occur either in transport or storage.

The advent of domestic diagnosis as promised by such technology generates the supposition that allowing the user to actively participate in the measurement process will generate a greater degree of responsibility in the management of their health. This is typified by the analysis of heart disease biomarkers whereby the patient, rather than the healthcare provider, is given a degree of responsibility for maintaining appropriate level of lipoproteins through dietary manipulation. Similar arguments can be made for a host of

other applications – not necessarily medical. Maintaining garden fertility is a million miles from the hospital ward but the technology used to assess such is the close cousin of that being used in the latter. The basic monitoring and subsequent participatory management premise is the same irrespective of end user application.

There are however issues to be resolved – selectivity - is still a major issue as is the integration of the sensing component with the transducing hardware. In order to be usable out with the lab – the eventual devices have to be robust – in terms of the actual measurement process but also in the handling and storage by the user. The latter is seldom an issue with lab based systems where the environment is carefully controlled and the operators are assumed to have a greater degree of scientific knowledge. Compare that with the situation where the average person may be conducting the analysis in their home. Composite technologies have come to fore in both scenarios but the remit of the present review has been to examine the development of novel materials that underpin the measurement interface rather than those that simply provide the plastic shroud that protects is. A wide spectrum of methodologies has been employed in the development of portable biosensor systems but the remit of this review has been restricted to those involving predominately electrochemical transduction. At present, the latter represents the majority interest in the sensor community. Nevertheless, it is likely the materials being discussed will also have application to the other detection methodologies.

7.2. Biosensors – The Foundations

Biosensors have traditionally been viewed as chemical sensors onto which a biological agent has been bolted – be it a protein, antibody, cell or tissue. The central rationale being that the biocomponent will selectively react with one particular chemical (ie glucose oxidase) or class of chemical (alcohol oxidase) with the chemical sensing part being responsible for the acquisition or transformation of the bioevent to a meaningful physical signal. The integration of chemical and materials technology with the biological entity has resulted in an extensive literature base on immobilization techniques and substrate/product/co-factor analysis – both being vital for the development of a biosensor.

It is important that the bioagent recognizes the target analyte but it is equally vital that the sensor can detect such recognition processes – ideally in a quantitative manner.

Enzyme systems predominate within the literature and are also the main target of the present work. These proteins can vary tremendously in terms of structure and function and monitoring the enzymatic reaction can be equally varied. There are however some relatively generic approaches and these are highlighted in Figure 7-1A, 7-1B and 7-1C. These reaction schemes are typical of oxidase enzyme systems (the principal systems investigated in this project) and follow much the same pattern irrespective of enzyme/analyte. Upon oxidizing the target substrate, the enzyme donates the electrons to an electron acceptor – usually molecular oxygen (Figure 7-1A). The consumption of oxygen can be monitored electrochemically. Alternatively, the production of peroxide can be measured. In both cases, the current generated or consumed can be related to the concentration of the enzyme substrate. The more substrate, the more oxygen is consumed and the more peroxide produced.

These approaches have some inherent limitations – the detection of oxygen is a slow process and depends on the oxygen content within the sample. Peroxide is by far the more common approach and has the advantage of the enzyme reaction producing a positive signal in contrast to the diminishing oxygen signal. The core disadvantage is that large potentials are required to oxidize the peroxide which can induce interference from other electroactive species. A more recent trend has been to introduce artificial electron acceptors (Figure 7-1C) such as ferrocene derivatives or metal complexes. The rationale being to select a mediator that can accept the electrons from the enzyme and which can be subsequently regenerated at the electrode through the imposition of potentials that are unlikely to induce the oxidation of other matrix components (typically ascorbate or urate). The re-oxidation of the mediator results in a current that can be related to the substrate concentration.

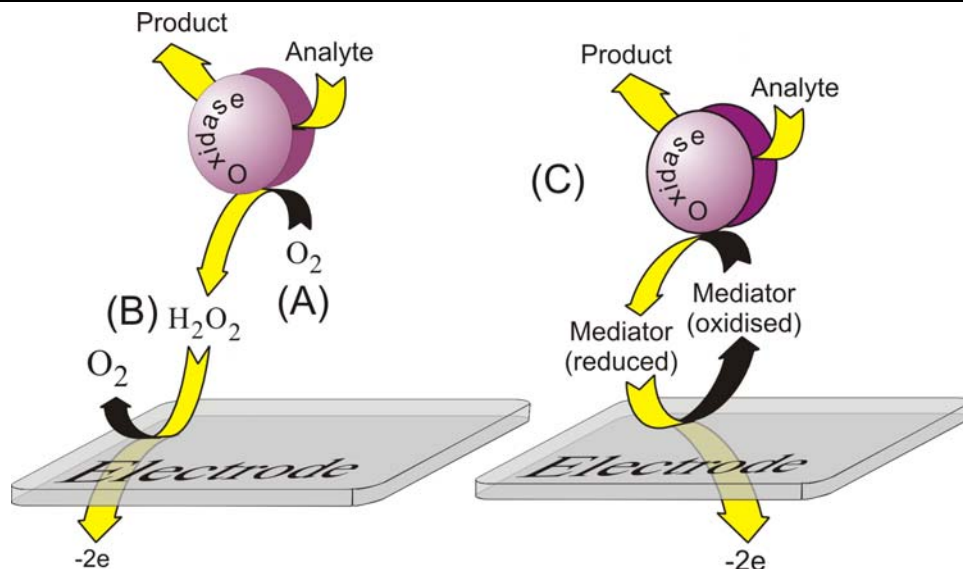

Figure 7-1: Conventional Oxidase Type Biosensor Reaction Schemes

7.3. Engineered Composites – Form and Function

The transfer and acquisition of an unambiguous signal from the recognition element (irrespective of type) to the transducer will normally be the weak link in the design of the sensor. The products of the reaction may possess slow electron transfer kinetics thereby reducing sensitivity or requiring the imposition of large potentials to drive the electrode process before a quantifiable signal can be obtained. As a consequence, other competing reactions may occur and contribute to the current, and thereby lead to an over-estimation in the target concentration. Such problems have long been recognised within the electroanalytical community and there have been considerable developments in the design of materials that can address these issues. Polymers have been designed to aid the retention of the recognition component but also to pre-concentrate the target and screen out interference from other matrix species. Polymers have also been used to enhance electron transfer from receptor to transducer. Inorganic films have been designed to catalyze the electrode processes and overcome slow electron transfer or to facilitate the electrochemical conversion of molecules that would otherwise be invisible to traditional transducer materials.

The diversity of material that can be brought into play has created a wide window of opportunity for sensor design and construction and this is reflected in the increasing number of papers (**Figure 7-2**) investigating the use of polymers, inorganic scaffolds and new carbon materials in biosensor development.

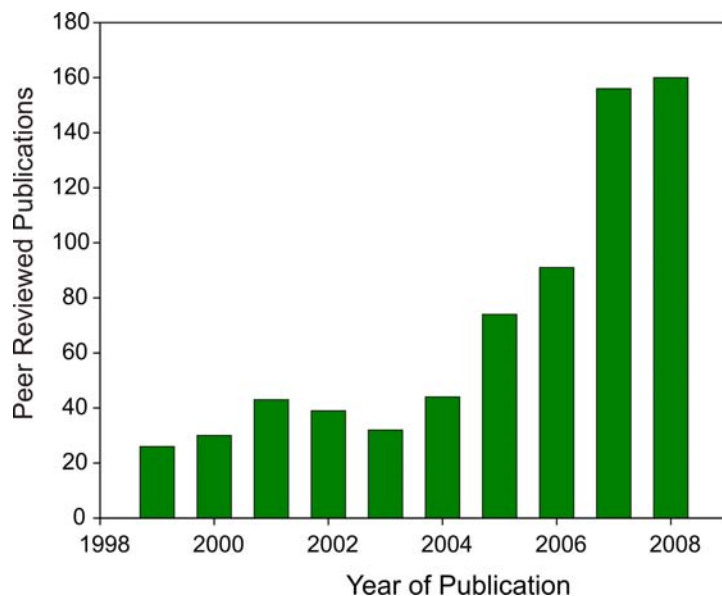

Figure 7-2: Articles reporting the use of a composite approach to biosensor construction.

Our definition of a composite in the present context is where two or more materials have been brought together to enhance the performance of a sensor beyond what could be achieved using the single components. In principle, the combination of an enzyme and an electrode could be classed as both a biosensor but also a composite as both components are materially different. Our rationale is that this combination represents the bare bones of our model biosensor but our interest lies in the materials that form the nerves, muscle and skin and in the interactions that bind them all together to form the body of a working system.

A survey of the different materials is presented and their application critically appraised. No attempt has been made to present a comprehensive list, rather, a selection of strategies that have a particular analytical merit or design novelty are presented. The materials have been grouped into broad classes depending on their primary composition (inorganic [4-17], organic [18-100], inorganic-organic hybrids [101-127]) but this is

somewhat artificial and overlaps are inevitable. Each is discussed in turn in the following sections:

7.4. Inorganic Materials

Metal oxides [4,5] or metal nanoparticles [6], normally in conjunction with sol gel silica matrices, represent the core members of this group with the majority of applications targeting either glucose [4,6-11] or phenol detection [11-14]. The inorganic systems are arguably the less common when compared to the other types of composite assembly. They have been used largely as an immobilisation matrix but have, in some instances, been exploited as a means of enhancing sensor performance.

Sol gels have long been recognised as a versatile immobilisation matrix in the pursuit of reagentless devices and provide a framework for the synthesis of optically transparent, amorphous bulk glasses and thin films [15]. They have a number of advantages – most relating to the ease of processing of the films and the fact that they can be formed under ambient conditions which can help preserve the catalytic activities of entrapped biocomponents. The films are mechanically robust and, depending on processing factors, have controllable porosity which can be manipulated to enhance electron transfer between biocomponent and transducer substrate [16]. The basic reaction scheme is highlighted in the **Figure 7-3** but the process can be catalysed by either acid or base and the morphology of the resulting film will differ as a consequence. Acid catalysis is known to lead to a linear chain with a low degree of branching whereas base catalysis leads to hyper branched systems with a greater degree of nanostructure.

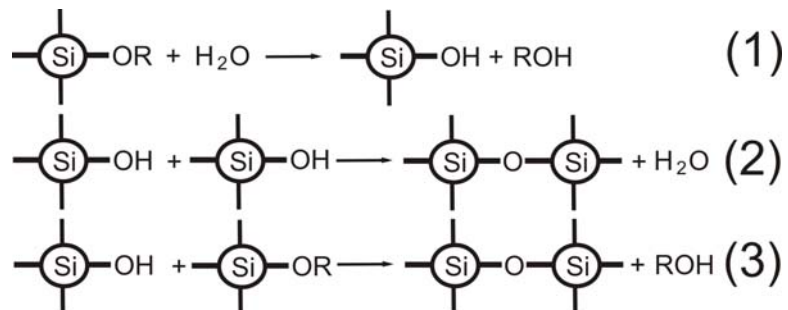

Figure 7-3. Silica sol gel formation. Hydrolysis (1) is followed by condensation (2 & 3) to yield a macromolecular scaffold.

Silica dominates the sol gel literature [10] but titania and ceria [4] have also been studied. The main limitation in the use of the more exotic systems is the markedly lower degree of biocompatibility however – this is really only an issue when considering *in vivo* applications. As such, the advantages associated with the processing ability of the material are liable to be the overriding factors in the selection of these materials for *in vitro* sensor systems. To overcome this problem, hybrid sol-gel materials have attracted some interest¹⁶. A selection of inorganic biocomposites and their target analyte are detailed in **Table 7-1**.

Base electrode	Biocomponent	Component 1	Component 2	Analyte	Ref
ITO	ChOx	CeO ₂	—————	Cholesterol	4
GC	Mb	ZrO ₂	—————	H ₂ O ₂	5
Au	GOX	AuNPs	SBA-15	Glucose	6
Pt bare	GOX	Pt	SiO ₂ NPs	Glucose	8
Pt disk	GOX	Zn ₃ Al(OH) ₈	—————	Glucose	11
GC	PPO	CaCO ₃	—————	Phenol	12
CE	Tyr, Lacsase	Titania gel	—————	Phenol	14
Pt disc	Gox	CaCO ₃ NPs	—————	H ₂ O ₂	17
GC	Hb	A-ZrP	—————	H ₂ O ₂	65
GC	AChE	AuNPs	Si-SG	Pesticides	129

Table 7-1: Composites possessing predominantly inorganic character

Anionic clays, which are essentially layered double hydroxides, represent a more unique method of entrapping both enzyme and mediator (Glucose Oxidase / Ferrocenyl Methanol) [11]. Microporous calcium carbonate, more common as the main component of eggshell, have also featured as a particularly useful environment for Glucose Oxidase [17] and Polyphenol Oxidase systems [12] and possess the potentially invaluable attribute

of biocompatibility. Processing the material, however, may be the rate determining factor in the exploitation of such materials.

Nano-materials have risen to considerable prominence in recent years due to the larger surface area and the unique catalytic properties that can be observed at such scales. The increased “effective” surface area can be an invaluable asset as it allows a greater degree of adsorption for biomolecules – whether to immobilise a potential receptor or, itself act serve as a receptor for the accumulation of a target analyte. A key feature is the rapidity of the electron transfer between the biomolecule and the sensor surface [17].

7.5. Organic Systems

This section represents a diverse range of materials encompassing – monomeric and polymeric systems. There are also some materials that could, depending on viewpoint, fall within both divisions – the carbon nanotube systems being a prime example and, as such, they are discussed under their own section. In the previous examples, the composite was the whole assembly and the addition of exogenous inorganic material was there, with a few exceptions, primarily to serve as little more than the glue that held the components together. Similar approaches have been taken in the application of the organic systems – but perhaps to a more significant extreme. A brief survey of some of the more diverse applications to which organic systems have been employed are detailed in **Table 7-2**. In the previous cases the transducer was not mentioned. In most cases, it represents a benign substrate (metal or carbon) that simply transfers charge. There are however a number of notable alternative systems in which the transducer, itself, is a composite material.

Carbon paste and screen printed carbon electrodes are essentially composite materials whereby conductive carbon particles are held together – usually by a non conductive binder which can be either mineral oil (as in the case of pastes) or polymer (epoxy and screen printed systems). The combination of graphite with agglutinating agents such as epoxy resins [18-20] silicone [20], Nafion® [21] or Teflon® [22] have been investigated as potential transducers in an attempt to enhance the sensor performance (largely through enhancing electron transfer rates). Graphite-epoxy

biosensors are rigid composites that can be used in aqueous or non aqueous medium and it is their application within the latter that gives them an advantage over the more conventional paste systems. The epoxy electrodes offer low background currents, high mechanical strength whilst retaining the processing ease common to the paste systems. This combination has been used for the detection of different analytes such as hydroquinones [20], hydrogen peroxide [21-23] and bacteria [24].

Base electrode	Biocomponent	Component 1	Component 2	Analyte	Ref
GC	D-Pro DH	Agar	—————	D-amino acid	1
GC	Ferritin protein	SWCNTs	—————	—————	2
—————	DIG-HRP	Graphite	Epoxy	DNA amplify	18
GC	Carboxyl esterase	Graphite	Epoxy	Ethanol	19
—————	Alcohol oxidase	Graphite	Epoxy resin	Aspartate	20
—————	PPO	Graphite-MTMOS	Nafion	Hydroquinone	21
—————	LAC and TYR	Graphite	Teflon-Ferrocene	H ₂ O ₂	22
—————	HRP	Graphite	CNT	Catalase	23
—————	POX	Graphite	—————	H ₂ O ₂	24
GC	Gox, Gpox	Teflon	Graphite	Bacterial pullution	27
GC	Mb	EMIM.BF ₄	HA	H ₂ O ₂	28
GC	GOX	PAn/PAA	TEOS	Glucose	29
Au	HRP	BMIMBF ₄	CHIT	H ₂ O ₂	31
—————	Urease	PAN-CHIT	—————	Glucose	32
Pt rod	LOD	Mucin	Albumin	Lactate	33
Pt foil	PPO	PAN	Pan	Benzoic acid	34
Pt	GOX	—————	PANAA	Glucose	36
ISE	Urease	PVA-PAA	—————	Urea	37
ITO	Gox	Ppy	PVS	Glucose	39
GC	Hb	MCWC	—————	H ₂ O ₂	40
ITO plate	GOX	MWCNTs/PDDA	PMMA	Glucose	41
GC	ADH	PDDA-SWCNTs	Nafion	Ethanol	42
GC	GOX	MWCNTs	PDDA	Glucose	44
GC	GIDH	CNTs	MDB	NADH	45
GC	AChE	MWCNTs	CHIT	OP	46
GC	GalOD	SWCNTs	CHIT	Galactose	47
GC	LDH	MWCNTs	CHIT	Lactate	48
Pt ink	HRP	WWCNTs	PS	H ₂ O ₂	66
GC	GOX	SWCNHs	Nafion	Glucose	67
GC	DNA	MWCNTs	PDC	Gen sequence	68
GC	Mb	MWCNTs	CHIT	H ₂ O ₂	69
GC	DNA	MWCNTs	CHIT	DNA	70
GC	Tyrosinase	Eggshell	—————	Dopamine	71
GC	HRP	Ionic liquid	—————	Redox proteins	72
—————	Gox	PU/PPy	—————	—————	73
Graphite rods	P.fluorescens	EDOT	—————	Biochemical oxygen	74
Pt disc	GOX	SWCNTs	PDDA	Glucose	75
—————	GOX	PVC	TTF-TCNQ	Glucose	76
—————	GOX	CNTs	PPF	Glucose	77
MCPE	GOX	FMC	AFSNPs/CHIT	Glucose	78
SCPE	GalRG-HRP	MWCNTs	Polysulfone	H ₂ O ₂	79
GC	Tyr	MWCNTs	Nafion	Phenols	80
—————	SOX	Graphite	Mineral oil	Thiol	81
GC	Hb	PS	PAH/PAA	H ₂ O ₂	82
—————	HRP	Graphite-Epoxy	PS	H ₂ O ₂	83
GC	Hb	DMWCNTs	CTAB-PSS	H ₂ O ₂	84
CPE	Hb	TATP	—————	H ₂ O ₂	85
GC	ADH	MWCNTs	PVA	Ethanol	86
GC	CcNiR	MV	Nafion	Nitrite	87
SPE	GIDH	MB	Polysulfone	NADH	88
—————	—————	PPD	PEI	L-Glutamate	89
Pt wire	GOX	Agarose	—————	—————	90
GC	Tyr	guar gun	—————	Catechol	91
Pt	GOX	PPD	PEA	Glucose	92
GC	HRP	MWCNTs	CHIT	H ₂ O ₂	93
—————	Tyr	Agar guar-gun	—————	Dopamine	94
—————	—————	GC μspheres	Mineral oil	4MSNC	95
Au	HRP	PAH-PSS	MPS	2,4,5-THT	96
GC	HRP	BMIM.BF ₄	CHIT	Phenol	97
GC	GOX	MWCNTs	PNR	H ₂ O ₂	98
—————	GOX, DSM	Graphite	Epoxy	Glucose	99
Pt	GOX	PPY	TPPZ	Phenol	99
GC	Tyr	Polyacrilamide	—————	Glucose	99

Table 7-2. Organic biocomposites

Developments with regard to the monomeric composite class however are represented by advances in the development of ionic liquids (IL). These have led to a resurgence of interest in the paste systems where the IL's have replaced the more traditional mineral oils. Carbon ionic liquid electrodes (CILE's) demonstrate some advantages over the conventional carbon paste electrodes such as high conductivity, fast electron transport and antifouling properties and low detection limits [25]. One of the limitations of ILs however is the relatively large high background current; however M.M Musameh et al. reported a carbon paste electrode combined with ionic liquids showing a low background current by the incorporation of n-octyl-pyridinium [26].

The use of ionic liquids as the principal solvent within which to conduct the analysis represents a step change in the electroanalytical knowledge base. It offers a far greater potential window over which to probe target analytes and stands in stark contrast to the potential window limitations imposed by aqueous buffer systems. They also appear to offer a medium that can be compatible with bioreceptors such as enzymes and have, in some instances, been demonstrated to actively stabilise the latter [27]. Hybrid systems have begun to emerge where the ILs are used in combination with the more traditional polymer matrices such as Nafion® [21], Polyacrylamide (PAA) [28] and Chitosan (CHIT) [29]. They have also been used with sol gel based materials to improve the direct electron transfer between the biomolecule and the electrode without the need of a mediator and have given rise to the so called third generation sensor [28].

The vast majority of biosensors utilise some form of organic polymer and like the previous materials – these can fulfill a number of functions depending on application. Historically, their main role was simply as an entrapment matrix through which the enzyme electrode could be re-used. Initial work used dialysis membranes but the field has advanced significantly. The emergence of electropolymerisable monomers and polymer backbones that possess inherent conductivity led to an explosion in the number of papers investigating the development of reagentless sensors – in which the polymer is used to entrap the enzyme at the surface of the transducer but also to facilitate electron transfer between the two components. Two subdivisions exist – the preformed polymers and the electropolymerised systems

Preformed polymers are typified by the Nafion®, polyvinyl pyridine, chitosan and redox hydrogels. These essentially represent the first generation of polymer systems utilised in biosensor construction. Their role was principally to immobilise the sensing element and prevent it leaching into the sample matrix. It was quickly realised that their inclusion yielded additional advantages and could be used to pre-concentrate the target analyte while excluding both macromolecular (protein) and monomolecular (ascorbate, urate) interferences. Nafion® stands as one of the most effective anti-interference screens as its anionic character dramatically reduced the influence of negatively charged ascorbate and urate (**Figure 7-4**) which, until recently, have been the two most problematic agents present within biofluids [30]. Moreover, the film could pre-concentrate positively charged neurotransmitters (i.e. dopamine) by ion exchange and minimises the problem of biofouling of the electrode substrate by other macromolecular species through providing a permselective action.

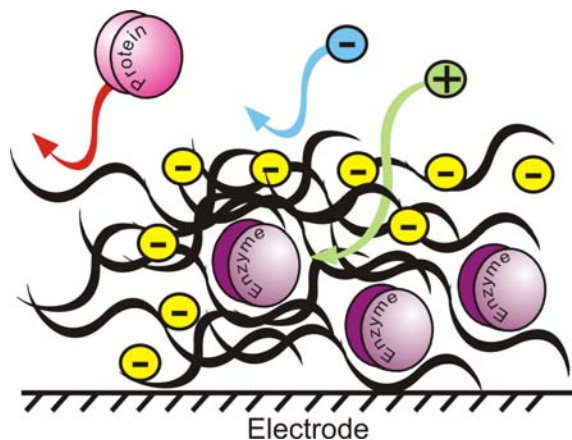

Figure 7-4: Multi-role influence of Nafion® in biosensor construction.

Chitosan has found an almost unique application. It is an aminoglycoside polymer – possessing primary amino functionalities (RNH_2) that can be used to covalently bind enzymes [31]. It is a hydrophilic polymer that swells in the presence of water or biological fluids, forming a gel. Hydrogels, stabilize the three dimensional structure of the enzyme by mimicking cytoplasmic or cytosolic properties [32]. Chitosan also has excellent capability for film formation and possesses a degree of biocompatibility which can allow *in vivo* measurements.

The other subdivision is represented by pyrrole and aniline type derivatives. Both molecular classes can be oxidised at an electrode and, in doing so, the electrogenerated radical cations – couple head to tail to form long chain polymers that retain conductivity. They provide a facile method for enzyme entrapment [33,34] and can often be polymerised (**Figure 7-5**) from buffered solution (in contrast to the organic solvents used to deposit Nafion®) [28,31,33-27]. Conducting polymers combine the mechanical properties of polymers (elasticity, malleability and flexibility) with high electrical conductivity and, as such, these properties make them an interesting tool for electrochemical devices and consequently for the construction of biosensors [28].

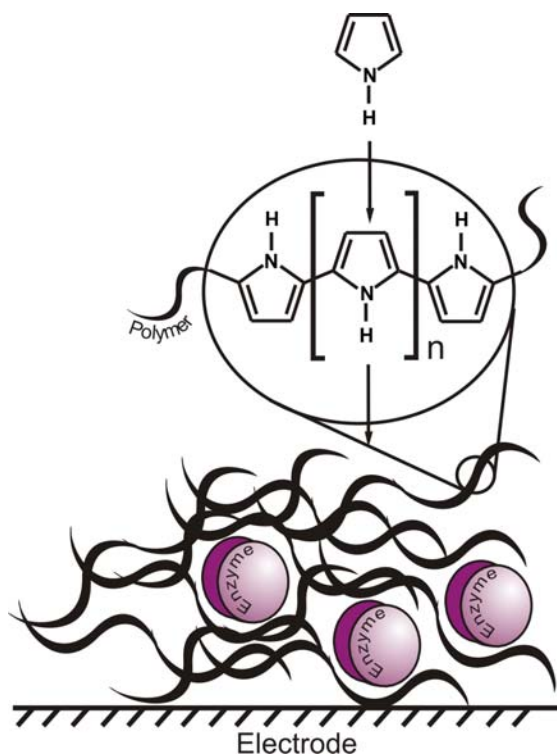

Figure 7-5: Electropolymerisation of pyrrole facilitating simultaneous polymer growth and enzyme entrapment

Polysulfone is also frequently used in biocomposites, because of its thermal, chemical and biological stability and because its solubility in dimethylformamide make the preparation of polysulfone membranes straightforward. Polysulfone have been used in combination with different biocomponents such as haemoglobin or horseradish peroxidase. More recently, Ordóñez and Fàbregas introduced this polymer as a reservoir

for immunological material for the construction of a graphite-polysulfone composite containing HRP and IgG [38].

7.6. Carbon Nanotubes

The unique mechanical, electronic and structural properties of carbon nanotubes (CNT) make them a useful component for sensing technologies. CNTs enhance the electrochemical reactivity of biomolecules, enhancing the electron transport. More recently, they have been used as key structural components in the immobilization of enzymes or other biomolecules. The latter has been achieved by a variety of methods: noncovalent adsorption of the biomolecules by supramolecular interaction or by covalent immobilization. The latter leads to a more stable attachment without losing enzyme activity. The functionalization of carbon nanotubes to improve the immobilization of the biomolecule can also be achieved through a variety of processes. Extensive sonication in acid conditions [2] or by anodization, to introduce carboxylic groups which creates a negative charge (**Figure 7-6**) have been found to be particularly effective, and can be used for binding positively charged enzymes or proteins such as haemoglobin [39].

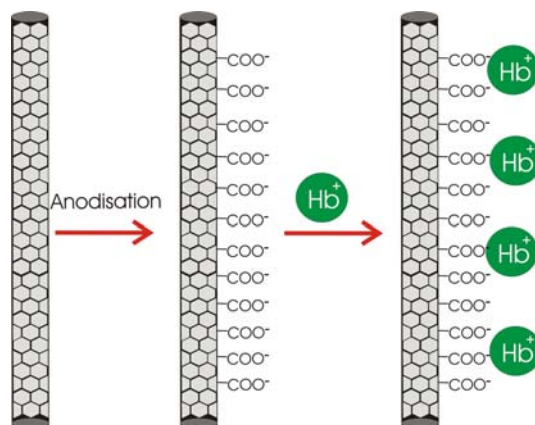

Figure 7-6: Surface modification of nanotubes to improve adhesion of biomolecules.

Excessive oxidative treatment can however harm the chemical or physical properties of carbon nanotubes or destroy the sp^2 structure of CNTs and wipe out their properties. A more attractive modification is to functionalize the carbon nanotubes by wrapping with a polymer (**Figure 7-7**) which will introduce a charge, positive or

negative, that will be used to immobilize the enzyme on the surface [40-42]. It has been established that carbon nanotubes can act as an electrocatalyst for some molecules such as NADH, ascorbate, dopamine and nitric oxide. It has also been reported to facilitate direct electron transfer with enzymes where its nanoproperties allow close interaction with the protein redox centre [43]. Wang and co-workers were the first to report the use of CNTs for the oxidation of biomolecules [44]. V.B.Kandimalla and H. Ju, reported the use of composite carbon nanotubes for the detection of thiocholine [45]. The carbon nanotubes catalyse the oxidation of thiocholine and shift the oxidation peak toward more negative potentials. However Compton [100] and co-workers have shown that the electrocatalytic properties of CNTs are similar to edge plane pyrolytic graphite electrodes and there is some debate as to the nature/origin of the enhanced electrode performance that has been reported in the past.

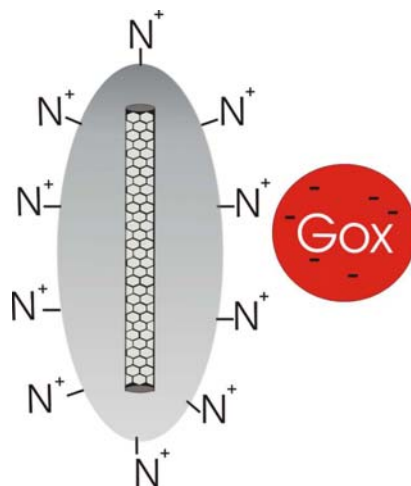

Figure 7-7: Influence of cationic polymer wrapper for the immobilisation of biomolecules.

One of the limitations of CNTs is their low solubility in most common solvents due to their hydrophobic surface. Two main modifications are normally used to improve the solubility of carbon nanotubes. The first involves the functionalization of CNT surface through acidic anodization or through noncovalent binding with dispersants via either Π - Π interactions or electrostatic interactions. Dan Wen et al [42]. reported the modification of carbon nanotubes by wrapping carbon nanotubes with a polyelectrolyte to create a material that could be dispersed in water. It was also shown to adsorb Glucose Oxidase

(GOx) without the use of any cross-linking agent [42]. Tsai and Huang, reported the use of poly (vinyl alcohol) (PVA) to solubilise carbon nanotubes. Another modification that has been frequently used to solubilise CNTs is the use of dimethylformamide, Nafion® and, more recently, Chitosan[46-47].

CNTs have been also used in the preparation of inks which have proved to be suitable for micro fabrication of thick-film electrochemical sensors [48]. Screen printed electrodes offer large scale production of low cost micro sensors and therefore the incorporation of CNTs offer a new promising combination for the design of biosensors.

7.7. Hybrid Systems

Hybrid biocomposites typically consist of both inorganic and organic components in addition to the biosensing component. They normally consist of metal nanoparticles combined with an organic polymer or carbon nanotubes. Furthermore, the use of metal nanoparticles in the construction of electrodes [49] or in the modification of its surface [50-52] has lead to some novel developments in electrocatalysis as indicated by the literature survey detailed in **Table 7-3**. Metal oxide nanoparticles possess important characteristics such as high surface area, ease of fabrication, chemical stability and the ability to promote electron transfer kinetics between the biosensing component and the electrode or transducer. All these properties make metal nanoparticles a potential tool for the development of biosensors. Metal oxide semiconductors such as ZnO are common nanomaterials for the construction of biocomposites. The nanoscale porosity of the material becomes an advantage for enzyme immobilization and they can provide a protective environment for the enzyme [53-54]. The combination of ZnO nanoparticles with different polyelectrolytes such as Nafion® or chitosan for enzyme immobilization has been reported. In fact a comparative study reported an improvement in direct electron transfer, of porous nanosheets compared with ZnO microspheres possessing a smooth surface [53]. Another metal oxide that has attracted attention is aluminium oxide which has been used to create artificial membranes for electrochemical sensing with the combination of polymers like polyethyleimine and Polyaniline [55]. The use of other metal oxides such as Co₃O₄ [56] has also been reported.

Park et al. treated the electrode with gold to improve its sensitivity by sputtering and electrochemical deposition [3]. Gold nanoparticles are gaining interest in analytical electrochemistry since they are highly conductive nanomaterials which can possess fast electron transfer. The use of gold nanoparticles as a matrix to immobilize different enzymes is well known [57, 16] and they have been reported to adsorb redox enzymes and proteins without compromising the biological properties of the biomolecule. It has been speculated that the gold redox environment is similar to that where biocomponents are found in nature in which the biomolecules have more freedom in orientation [58]. Gold has been used in combination with different materials such as different polymers [23,35,59], ionic liquids, or graphite to build hybrid composites.

Base electrode	Biocomponent	Component 1	Component 2	Analyte	Ref
ITO	GOX	Au sputtered	PEDOT-PSS	Glucose	3
GC	GOX	CNTs-PtNPs	CHIT-MTOS*	Glucose	16
_____	HRP	Graphite	Ionic liquid	H ₂ O ₂	25
_____	GOX	Au colloid	Teflon	Glucose	24
_____	GOX	Graphite	Ionic liquid	H ₂ O ₂ , Glucose	26
GC	GOX	Pt	ZrOPr	Glucose	30
GC	GOX	AuNPs-AgCl	PANI	_____	35
GC	HRP	MWCNT-AuNPs	Thionine	H ₂ O ₂	43
GC	HRP	AuNPs-Thi	P-ABSA	H ₂ O ₂	50
GC	HRP	PTHNW-Au	CHIT	H ₂ O ₂	52
GC	Hb	ZnO microsphere	Nafion	H ₂ O ₂ , NaNO ₂	53
ITO	ChOx	ZnO	CHIT	Cholesterol	54
_____	HRP, Trypsin	AAO	PEI or PANT	N/A	55
GC	Gox	Co ₃ O ₄ nanoflakes	Nafion	H ₂ O ₂	56
GC	ACHe	AuNPs	TEOS-CHIT*	AD drgs	57
Au	ACHe	AuNPs /Au	MUA	ATCI	59
_____	Tyr	Au coll	Graphite-Teflon	Phenol	58
_____	ADH	MWCNTs-AuNPs	Teflon	Ethanol	60
GC	Cyt c	Au nanoparticles	CNT	H ₂ O ₂	61
GC	HRP, GOX	TEOS*	CNT-PAMAM	Glucose	62
GC	PPO	Laponite clay	CHIT	Phenol	64
GC	L- lactose oxidase	MWCNTs/Pt nano	Sol-gel	L-lactose	102
Rodum-graphite Screen printed	P450scc	MWCNT/Au nano	_____	Cholesterol	103
_____	Catalase	Cysteine	Bentonite	N/A	104
Pt disc electrode	Hb	Au-Cysteine	CHIT	H ₂ O ₂	105
ITO	HRP	TiO ₂	CHIT	Antibodies Proteins	106
_____	XO	AuNPs	GC Powder	Xanthine Hypoxanthine	107
BPG	Cyt c	Au nanoparticles	Ionic liquid	O ₂	108
GC	GOX	PFIL*	Ionic liquid	Glucose	109
_____	Lacase	ABTS-Graphite	MTMOS	O ₂	110
Au glass	GOX	PB	Nafion	Glucose	111
GC	GOX	PPy-PtNPs	POAP	Glucose	112
Au	LOD	CHIT-PVI-Os	CNTs	Lactate	113
_____	Tyr	Graphite-Au	Teflon	Organo- phosphorus	114
_____	Tyr	CoPc	Cellulose Graphite	Progesterone	115
GC	GOX	DMF-AuNPs	OMiMPF ₆	Glucose	116
_____	HRP-ssDNA	AuNPs	Graphite paraffin oil	CDNA	117
GE	Gox	AuNPs	DHP	Glucose	118
GC	Hb	CaCO ₃ NPs	CHIT	H ₂ O ₂	119
GC	Gox	FMC-BSA	Ormosil*	Glucose	120
GC	HRP	FMC-BSA	Ormosil*	H ₂ O ₂	121
GC	Gox	AuNPs-PANI	Nafion	Glucose	122
ITO	Chox-HRP	BSA	TEOS*	Cholesterol	123
GC	HRP-IgG	ZnO	CHIT	IgG	124
GC	Gox	PB	CHIT-AuNPs	Glucose	125
GC	HRP	AOB	CHIT	H ₂ O ₂	126
ITO	Apo A-I antigen	FAuNPs	APMSi*	Apo A-I	127
GC	Thrombin and Apartamer	AuNPs	CHIT	Thrombin	128

Table 7-3: Hybrid systems employing defined inorganic and organic components.

It is well known that both carbon nanotubes and gold nanoparticles have unique and interesting properties as well as simply increasing electrocatalytic activity. One of the first applications of nanoparticles for the construction of a hybrid biosensor was reported by Yogeswaran et al [130] for the determination of tyrosine, adenine, guanine and thymine. More recently, nanoparticles have been extensively used for the detection of different substances such as ethanol [60] or hydrogen peroxide [61,43]. The latter is important as it is often the byproduct of many enzyme reactions (c.f. **Figure 7-1**) and hence could be an invaluable asset as an interface to those biomolecules. Normally, the construction of these hybrids includes the use of organic solvents, polymers such as chitosan or Teflon [60] and a surfactant [28], However, Wang and co-workers reported the use of thionine to link gold nanoparticles to the carbon nanotubes [43] without using any polymer or organic solvent for the construction of the sensor (**Figure 7-8**). There have been a number of investigations into the role of thionine to act both as a mediator and as linker between gold materials and negatively charged polymers such as p-ABSA [50] or carbon [43] materials. Components possess carboxyl groups or hydroxyl groups interact with the positively charged thionine through electrostatic attraction.

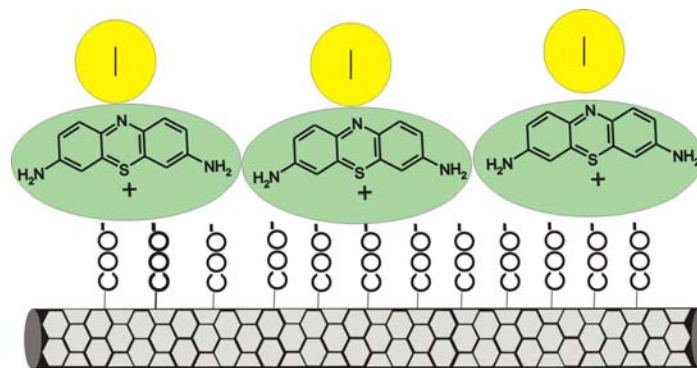

Figure 7-8: Thionine used as a linker between functionalised CNTs and Gold nanoparticles.

Sol-gel electrodes are an expanded group within hybrid materials, where they combine traditional sol-gel materials (mostly silica materials such as TEOS) with organic polymers and or carbon nanotubes. In most applications, the sol gel material is used to provide a micro-porous support matrix in which sensing element is entrapped but through which smaller molecules can diffuse [15]. As mentioned at the beginning of the chapter, inorganic sol-gel sensors lack of biocompatibility can often be solved or partially

minimised by the combination of biocompatible organic components into the mixture, as a result hybrid sol-gel composite materials are widely used for biosensing [62,28]. Carbon ceramic is a new carbon electrode material, mainly constructed by sol-gel type process. Carbon ceramic electrodes possess the ability of surface removal like other carbon materials, porosity, low temperature encapsulation, chemical inertness, optical transparency, negligible swelling, mechanical stability and the ability to control the surface wettability in aqueous solution by choosing the appropriate sol-gel monomers [63].

Other novel combinations that have been explored are the fusion of charged polymers with charged clays. This approach is typified by the construction of sensors based on laponite-clay chitosan nanocomposite for the amperometric detection of phenols [64]. In this instance, the mixture becomes a useful tool for the immobilization of polyphenol oxidase without the need for a covalent cross-linking procedure.

7.8. Conclusions

Interest in the use of composites within biosensor development has increased dramatically in recent years and the advances in materials is often viewed as the answer to many of the selectivity and sensitivity problems that have plagued the early prototypes. In addition, the need to improve the stability and reproducibility is becoming much more of an issue now that, in most cases, research is steadily progressing from proof of concept to application demonstrators. The successful integration of the sensing component with the transducer is highly dependent on the selection of appropriate materials that can enhance the transducer-bio interaction and retain activity beyond the first few measurements.

Nanoparticles have received a great deal of attention and it is likely that their use within biosensing designs will evolve steadily in the future. A glimpse of what they can offer has been provided here but it is almost inevitable that more has yet to be found. Gold nanoparticles have been shown to provide redox microenvironments similar than that experienced by the biocomponent in nature. The electrocatalytic properties of carbon nanotubes are a source of considerable debate but there is little doubt that they provide an

extremely versatile addition to the materials library and several novel features such as their scaffolding for enzyme and capacity for intimate contact with redox sites are without quarrel.

Ionic liquids are another emerging material for which much is yet to be written. The wide potential range is an undoubted bonus. Recent developments have seen the focus turn towards third generation sensors or mediator free electrodes and this area is central to the following chapters. Different systems have been reported to facilitate electron transfer. It is clear that composites have a central role in biosensor development and it is a role which seems to be ever on the increase given the advances in new materials.

7.9. References.

1. Tani Y, Tanaka K, Yabutani T, Mishima Y, Sakuraba H, Oshima, T, Motonaka J (2008) *J. Analytica Chimica Acta*, 619 215-220.
2. Lee J W, Shin K M, Lyman C, Spinks GM, Wallace GG, Kim SJ (2008) *Smart Materials and Structures*, 17 1-5.
3. Park J, Kim H K, Son Y (2008) *Sensors and Actuators B*, 133 244-150.
4. Ansari AA, Kaushik A, Solanki P R, Malhotra B D (2008) *Electrochemistry Communications*, 10 1246-1249.
5. Zong S, Cao Y, Zhou Y, Ju H (2007) *Biosensors and Bioelectronics*, 22 1776-1782.
6. Bai Y, Yang H, Yang W, Li Y, Sun C (2007) *Sensors and Actuators B*, 124 179-186
7. Dai Z, Fang M, Bao J, Wang H, Lu T (2007) *Analytica Chimica Acta*, 591 195-199.
8. Yang H, Zhu Y (2007) *Biosensors and Bioelectronics*, 22 2898-2993.
9. Ballarin B, Cassani MC, Mazzoni R, Scavetta E, Tonelli D (2007) *Biosensors and Bioelectronics*, 22 1317-1322.
10. Liu S, Su Y (2007) *Biosensors and Bioelectronics*, 22 905-911.
11. Shan D, Yao W, Xue H (2007) *Biosensors and Bioelectronics*, 23 432-437.
12. Shan D, Zhu M, Han E, Xue H, Cosner S (2007) *Biosensors and Bioelectronics*, 23 648-654.
13. Carvalho R H, Lemos F, Lemos MANDA, Cabral JMS, Ribeiro F R (2007) *Journal of Molecular Catalysis A: Chemical*, 278 47-52.
14. Kochana J, Nowak P, Jarosz-Wilkolazka A, Bieroń (2008) *Microchimica Acta*, 89 171-174.
15. Bagal D S, Vijayan A, Aiyer RC, Karekar RN, Karve M S (2007) *Biosensors and Bioelectronics*, 22 3072-3079.
16. Kang X, Mai Z, Zou X, Cai P, Mo J (2008) *Talanta*, 74 879-886.
17. Shan D, Zhu M, Xue H, Cosner S (2007) *Biosensors and Bioelectronics*, 22 1612-1617.
18. Lermo A, Campoy S, Barbé J, Hernández S, Alegret S, Pividori M I (2007) *Biosensors and Bioelectronics*, 22 2010-2017.
19. Kirgöz U A, Odaci D, Timut S, Merkoçi A, Alegret S, Beşün N, Telefoncu A. (2006) *Analytica Chimica Acta*, 570 165-169.
20. Lupetti K O, Zanotto-Neto G, Fatibello-Filho O (2006) *Journal of the Brazilian Chemical Society*, 17 1329-1333.
21. ElKaoutit M, Naranjo-Rodrigues I, Tamsamani K R, Domínguez M, Hidalgo-de Cisneros JL (2008) *Talanta*, 75 1348-1355.
22. Serra B, Zhang J, Morales M D, Guzmán-Vázquez de parad A, Revejo A J, Pingarrón JM (2008) *Talanta*, 75 1134-1139.

23. Odaci D, Tlefoncus A, Timur S (2008) *Sensors and Actuators B*, 132 159-165.
24. Morales MD, Serra B, Guzmán-Vázquez de Prada A, Reviejo A J, Pingarrón J M (2007) *Analyst*, 132 572-578.
25. Ding C, Zhang M, Zhao F, Zhang S (2008) *Analytical Biochemistry*, 378 32-37.
26. Musahmed M M, Kachoosangi R T, Xiao L, Russell A, Compton R G (2008) *Sensors and Actuators B*, 24 87-92.
27. Zhang Y, Zheng J (2008) *Electrochemistry Communications*, 10 1400-1403.
28. Xian Y, Liu F, Feng L, Wu F, Wang L, Jin W (2007) *Electrochemistry Communications*, 9 773-780.
29. Xi F, Liu L, Wu Q, Lin X (2008) *Biosensors and Bioelectronics* 24 29-34.
30. Kim H, Yoon S H, Choi H N, Lyu YK, Lee W Y (2006) *Bulletin of the Korean Chemical Society*, 27 65-70.
31. Gabrovska K, Georgieva A, Godjevargova T, Stoilova O, Manolova N (2007) *Journal of Biotechnology* 129 674-680
32. Romero M R, Gary F, Baruzzi AM (2008) *Sensors and Actuators B* 131 590-595.
33. Shan D, Shi Q, Zhu D, Xue H (2007) *Talanta*, 72 1767-1772.
34. Shan D, Wang S, He Y, Xue H. (2008) *Materials and Engineering C*, 28 213-217.
35. Yan W, Feng X, Chen X, Hou W, Zhu JJ (2008) *Biosensors and Bioelectronics*, 23 925-931
36. Jha S K, Topkar A, D'Souza S F (2008) *Journal of Biochemical and Biophysical Methods*, 70 1145-1150.
37. Gade V K, Shirale D J, Gaikwad P D, Savale P A, Kakde KP, Kharat HJ, Shirsat M D (2006). *Reactive & Functional Polymers*, 66 1420-1426.
38. Huang J, Song Z, Li J, Yang Y, Shi H, Wu B, Anzai J, Osa T, Chen Q (2007) *Materials Science and Engineering C*, 27 29-34.
39. Ma G X, Wang Y G, Wang C X, Lu T H, Xia Y Y (2008) *Electrochimica Acta* , 53 4748-4753.
40. Manesh K M, Kim H T, Santhosh P, Goplan AI, Lee K P (2008) *Biosensors and Bioelectronics*, 23 771-779.
41. Liu S, Cai C (2007) *Journal of Electroanalytical Chemistry* 602 103-114.
42. Wen D, Liu Y, Yang G, Dong S (2007) *Electrochimica Acta*, 52 5312-5317.
43. Wang Z, Li M, Zhang Y, Shen Y, Han D, Iwasaka A, Niu L (2008) *Electrochemical Communications*, 10 306-310.
44. Chakraborty S, Raj C R (2007) *Electrochemical Communications*, 9 1323-1330.
45. Kandimalla V B, Ju H (2006) *Chemistry-A European Journal*, 12 1074-1080.
46. Tkac J, Whittaker J W, Ruzgas T (2007) *Biosensors and Bioelectronics*, 22 1820-1824.
47. Tsai Y C, Chen S Y, Liaw H W (2007) *Sensors and Actuators B*, 125 474-481
48. Sánchez S, Pumera M, Cabruja E, Fàbregas E (2007) *Analyst*, 132 142-147.

-
49. Manso J, Mena M L, Yáñez-Sedeño P, Pingarrón (2007) *J. Journal of Electroanalytical Chemistry*, 63 1-7.
 50. Gao F, Yuan R, Chai Y, Chen S, Cao S, Tang, M (2007) *Journal of Biochemical and Biophysical Methods*, 70 407-413.
 51. Sulak MT, Gökdoğan Ö, Gülce A, Gülce H (2006) *Biosensors and Bioelectronics*, 21 1719-1726.
 52. Shi AW, Qu L F, Yang MH, Shen G L, Yu R Q (2007) *Sensors and Actuators B*, 129 779-783.
 53. Lu X, Zhang H, Ni Y, Zhang Q, Chen J (2008) *Biosensors and Bioelectronics*, 24 93-98.
 54. Khan R, Kaushik A, Solank P R, Ansari A A, Pandey MK, Malhotra B D (2008) *Analytica Chimica Acta*, 616 207-213.
 55. Bezerra-Oliveira G, Lima-Filho J L, Cavalcante-Chaves M E, Mendes-Azevedo W, Bezerra-Carvalho L (2008) *Reactive & Functional Polymers*, 68 27-32.
 56. Lu X, Zou G, Li J (2007) *Journal of Materials Chemistry*, 17 1427-1432.
 57. Du D, Chen S, Cai J, Song D (2007) *Journal of Electroanalytical Chemistry*, 611 60-66.
 58. Carralero V, Maena M L, Gonzalez-cortes A, Yanez-Sedeno P, Pingarron J M (2006) *Biosensors and Bioelectronics*, 22 730-736.
 59. Du Dan, Ding, Cai J, Zhang J, Liu L (2008) *Talanta*, 74 1337-1343.
 60. Manso J, Mena M L, Yáñez-Sedeño P, Pingarrón. (2008) *Electrochimica Acta*, 53 4007-4012.
 61. Xiang C, Zou, Y, Sun LX, Xu F (2008) *Electrochemistry Communications*, 10 38-41.
 62. Zeng Y L, Huang Y F, Jiang J H, Zhang X B, Tang C R, Shen G L, Yu R Q (2007) *Electrochemistry Communications*, 9 185-190.
 63. Yu H, Sheng Q L, Li L, Zheng J B (2007) *Journal of Electroanalytical Chemistry*, 606 55-62.
 64. Fan Q, Shan D, Xue H, He Y, Cosiner S (2007) *Biosensors and Bioelectronics*, 22 816-821.
 65. Liu Y, Lu C, Ho W, Zhu J J (2008) *Analytical Biochemistry*, 375 27-34
 66. Liu X Shi, L; Niu, W; Li, H; Xu, G. *Biosensors and Bioelectronics*, 2008, 23, 1887-1890.
 67. Yang, T; Zhang, W; Du, M; Jiao, K. *Talanta*, 2008, 75, 987-994.
 68. Duan LS, Xu Q, Xie F, Wang S F (2008) *International Journal of Electrochemical Science*, 3 118-124.
 69. Galandova J, Ziyatdinova G, Labuda (2008) *J. Analytical Sciences*, 24 711-716.
 70. Tembe S, Kubal B S, Karve M, D'Souza S F (2008) *Analytica Chimica Acta*, 612 212-217.
 71. Li J, Liu L, Xiao F, Gui Z, Yan R, Zhao F, Hu L, Zeng B (2008) *Journal of Electroanalytical Chemistry*, 613 51-57.
 72. Kayrak-Talay D, Akman U, Hortaçsu Ö (2008) *Journal of Supercritical Fluids*, 44 457-465.
 73. Odaci D, Kayahan S K, Timur S, Toppare L (2008) *Electrochimica Acta*, 53 4101-4108.
 74. Wang Y, Wang X, Wu B, Zhao Z, Yin F, Li S, Qin X, Chen Q (2008) *Sensors and Actuators B*, 130 809-815
 75. Wang Y, Wang X, Wu B, Zhao Z, Yin F, Li S, Qin X, Chen Q (2008) *Sensors and Actuators B*, 130 809-815.

-
76. Muguruma H, Shibayama Y, Matsui Y (2008) *Biosensors and Bioelectronics*, 23 827-832.
 77. Qui J, Peng H, Liang R (2007) *Electrochemistry Communications*, 9 2734-2738.
 78. Sánchez.S, Pumera M, Fàbregas E (2007) *Biosensors and Bioelectronics*, 23 332-340.
 79. Tsai YC, Chiu CC (2007) *Sensors and Actuators B*, 125 10-16.
 80. Timur A, Odaci D, Dincer A, Zihnioglu F, Telefoncu A, Gorton L (2007) *Sensors and Actuators B*, 125 234-239.
 81. Song M, Ge L, Wang Z (2008) *Journal of Electroanalytical Chemistry*, 617 149-156
 82. Ordóñez S S, Fàbregas E (2007) *Biosensors and Bioelectronics*, 22 965-972.
 83. Chen L, Lu G (2007) *Sensosr and Actuators B*, 121 423-429.
 84. Shan D, Zhu M, Xue H, Cosiner S (2007) *Biosensors and Bioelectronics*, 22 1612-1617.
 85. Tsai YC, Huang J D, Chiu C C (2007) *Biosensors and Bioelectronics*, 22 3051-3056.
 86. Almeida M G, Silvera C M, Moura J J G (2007) *Biosensors and Bioelectronics*, 22 2485-2492.
 87. Prieto-Simón B, Macanás J, Muñoz M, Fàbregas E (2007) *Talanta*, 71 2102-2107.
 88. McMahan CP, Rocchitta G, Kirwan AM, Killoran SJ, Serra PA, Lowry JP, O'Neill RD (2007) *Biosensors and Bioelectronics*, 22 1466-1473.
 89. Tembe S, Inamdar S, Haram S, Karve M, D'Souza SF (2007) *Journal of Biotechnology*, 128 80-85
 90. McMahon A C, Rocchitta G, Serra P A, Kirwan S M, Lowry J P, O'Neill R D (2006) *Analyst*, 131 68-72.
 91. Qian L, Yang X (2006) *Talanta*, 68,721-727.
 92. Tembe S, Karve M, Inamdar S, Harm S, Melo J, D'Souza S F (2006) *Analytical Biochemistry*, 349 72-77.
 93. Rodríguez M C, Monti MR, Argaraña C E, Rivas GA (2006) *Talanta*, 68 1671-1676.
 94. Yang S, Li Y, Jiang X, Chen Z, Lin X (2006) *Sensors and Actuators B*, 114 774-780.
 95. Lu X, Zhang Q, Zhang L Li J (2006) *Elctrochemistry Communications*, 8 874-878.
 96. Qu F, Yang M, Chen J, Shen G, Yu R (2006) *Analytical Letters*, 39 1785- 1799.
 97. Kırğöz U A, Odaci D, Timur S, Merkoçi A, Pazarlioğlu, Telefoncu A, Alegret S. (2006) *Bioelectrochemistry*, 69 128-131.
 98. Alves W A, Fiorito A F, Córdoba de Torresi, S I; Torresi, R M. (2006) *Biosensors and Bioelectronics*, 22 298-305.
 99. Hervás Pérez, Sánchez-Panigua López M , López-Cabarcos E , López-Ruiz B (2006) *Biosensors and Bioelectronics*, 2006, 22, 429-439.
 100. Banks C E, Compton R G (2005) *Analytical Sciences*, 11 1263-1268.
 101. Kaushik A, Solanki P R, Ansari AA, Ahmad S, Malhotra B D (2008) *Electrochemistry Communications*, 10 1364-1368.
 102. Huang J, Li J, Yang Y, Wang X, Wu, B Anzai, J Osa T, Chen,Q (2008) *Materials Science and Engineering*, 271070-1075.

-
103. Carrara S, Shumyantseva V V, Archakov AI, Samori B (2008) *Biosensors and Bioelectronics*, 2008, 148-150.
 104. Öztürk N, Tabak A, Akgöl S, Denizli A (2008) *Colloids and Surfaces B*, 322 148-154.
 105. Yang G, Yuan R, Chai Y Q (2008) *Colloids and Surfaces B*, 61 93-100.
 106. Khan R, Dhayal M (2008) *Electrochemistry Communications*, 10 263-267.
 107. Khan R, Dhayal M (2008) *Electrochemistry Communications*, 10 263-26..
 108. Xu J S, Zhao G C (2008) *International Journal of Electrochemical Science*, 3 519-527.
 109. Yang F, Jiao L, Shen Y, Xu X, Zhang Y, Niu L (2007) *Journal of Electroanalytical Chemistry*, 608 78-83.
 110. Nolgala W, Rozniecka E, Zawisza I, Rogalski J, Opallo M (2006) *Electrochemistry Communications*, 8 1850-1854.
 111. Zhang N, Wilkop T, Lee S, Cheng, Q (2007). *Analyst*, 132 164-172.
 112. Li J, Lin X (2007) *Biosensors and Bioelectronics*, 22 2898-2905.
 113. Ciu X, Li C M, Zang, J, Yu S (2007) *Biosensors and Bioelectronics*, 22 3288-3292.
 114. Carralero V, Gonzalez-Cortes A, Yanez-Sedeno P, Pingarron JM (2007) *Analytica Chimica Acta*, 596 86-91.
 115. Tanimoto de Albuquerque Y D, Franco-Ferreira L (2007) *Analytical Chimica Acta*, 596 210-221.
 116. Li J, Fan C, Xiao F, Yan R, Fan S, Zhao F, Zeng B (2007) *Electrochimica Acta*, 52 6178-6185.
 117. Pan J (2007) *Biochemical Engineering Journal*, 35 183-190.
 118. Wu Y, Hu S (2007) *Bioelectrochemistry*, 70 335-341.
 119. Shan D, Wang S, Xue H, Cosiner S (2007) *Electrochemistry Communications*, 9 529-534.
 120. Kandimalla V B, Tripathi V S, Ju H (2006) *Biomaterial*, 27 1167- 1174.
 121. Tripathi V S, Kandimalla V B, Ju H (2006) *Biosensors and Bioelectronics*, 21 1529-1535.
 122. Sulak M T, Gökdğan Ö, Gülce A, Gülce H (2006) *Biosensors and Bioelectronics*, 21 1719-1726.
 123. Kumar A, Pandey R R, Brantley B (2006) *Talanta*, 69 700-705.
 124. Wang Z, Yang W, Li Y, Gong J, Shen G, Yu R (2006) *Talanta*, 69 686-690.
 125. Xue M H, Xu Q, Zhou M, Zhu JJ (2006) *Electrochemistry Communications*, 8 1468-1474.
 126. Lu X, Wen Z, Li J (2006) *Biomaterials*, 27 5740-5747.
 127. Hang S, Huang F, Liu B, Ding J, Xu X, Kong J (2008) *Sensors and Actuators B*, 131 590-595.
 128. Kang Y, Feng K J, Chen JW, Jiang J H, Shen G L, Yu R Q, (2008) *Bioelectrochemistry*, 73-76-81.
 129. Du D, Chen S, Cai J, Zhang A (2008) *Talanta*, 74 766-772.
 130. Yogeswaran U, Thiagarajan S, Chen S M (2007) *Carbon*, 14 2783-2796

Chapter 8

Biosensing of Purine Metabolites

Abstract

The present chapter can be divided into two main parts. The first involves a chromatographic study of the composition of saliva from different species (human, horse, donkey, sheep and llama) and an evaluation its potential usefulness as a non invasive tool for the evaluation of oxidative stress in animal welfare studies. The second section is based on the development and characterization of a novel electrochemical composite biosensor for the determination of xanthine and its potential application for the evaluation of the latter in saliva.

8.1. A Further Development

Throughout the thesis, the sensing strategy has been modified according to the needs of the detection methodology and the application context. The first chapters focused the attention on the introduction of different electrochemical methods to expose the versatility of electrochemical techniques but no effort was involved in the preparation of the electrode itself and the measurements were done with plain electrodes without further modifications. In successive chapters, the developments of different electrode modifications were reported, from simple physical modification such as laser anodisation through to the introduction of a chemical catalyst in the electrode such as a ferrocene. The last chapter seeks to exploit the latter in a more complex assembly by using a biocatalyst in the sensing strategy.

8.2. Introduction

Purine compounds are a group of aromatic organic molecules consisting of a pyrimidine ring fused to an imidazole ring. They play an important role in the body and

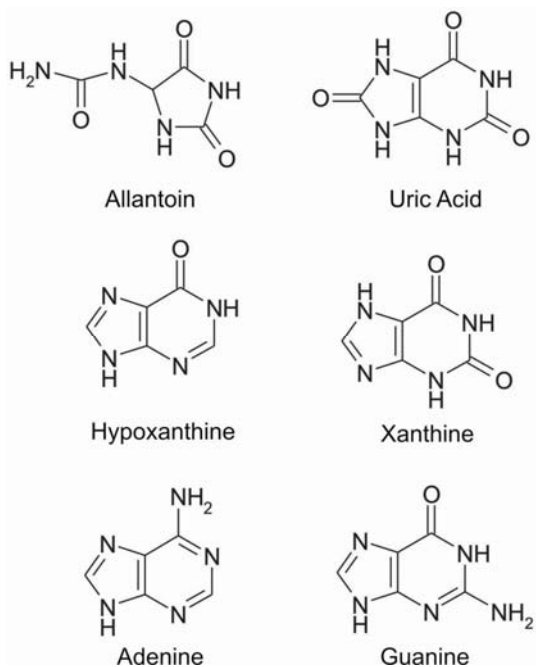

their evaluation has been used for a variety of different biomedical applications. Some of the more common biologically significant purines are shown in **Figure 8-1**. Allantoin, although not a purine itself, is included in the figure because it is the oxidation product of uric acid, being the last breakdown product of purines such as adenine and guanine. Xanthine is one of the metabolic products of purine nucleotides. It penetrates cell membranes and accumulates in extracellular fluids. Nucleotides such as Adenine triphosphate

Figure 8-1: Common Purines

(ATP) is degraded to hypoxanthine by the action of nucleoside phosphorylase, then hypoxanthine (HX) is converted to xanthine(X) which finally is further oxidised to uric acid (UA). In humans, the process stops there but in most other mammals and microbes – the breakdown continues through to allantoin. The last two steps are normally catalyzed by xanthine dehydrogenase; however in some conditions (i.e. ischemia), xanthine oxidase catalyzes the degradation of these two metabolites to uric acid [1]. Guanine is also converted to xanthine by the action of guanase and then xanthine is converted to uric acid by xanthine dehydrogenase.

The determination of xanthine has been of great interest in the food industry [2-4]. Xanthine and hypoxanthine are produced in the degradation process of food, therefore the evaluation of these two purine metabolites can be indicative of the freshness of food. Clinical interest in the determination of xanthine is due to the relation of xanthine concentration with different pathologies. Xanthuria is a genetic disorder where the lack of xanthine oxidase results in the accumulation of xanthine with its low solubility leading to stone formation - the diagnosis is commonly done by urine evaluation [5,6]. Lesh-Nyhan syndrome is a failure in the salvage pathway for hypoxanthine because the deficiency of the enzyme hypoxanthine-guanine phosphoribosyltransferase and causes a build up of uric acid in all body fluids [7]. Diagnosis can be achieved in the early stages where the clinician is alerted to the possibility through the onset of hyperuricemia.

Another interesting fact found in the literature is the relation of ischemia and oxidative damage [8-12]. Intense exercise can cause ischemia or hypoxia in certain parts of the body. In this situation ATP will be metabolized to ADP, AMP, inosine, hypoxanthine, xanthine and finally to uric acid. In normal physiological conditions xanthine dehydrogenase, which is the dominant form of the enzyme will use NAD^+ , as the electron acceptor in the oxidation of xanthine and hypoxanthine to uric acid, however under anaerobic conditions the xanthine dehydrogenase will be converted to xanthine oxidase, which, instead of using NAD^+ , directly reduces oxygen to superoxide and hydrogen peroxide. During ischemia, the concentration of oxygen is low and xanthine and hypoxanthine are accumulated in the extracellular fluids and thus upon reperfusion a high concentration of ROS are produced which will result in oxidative damage. The

accumulation of xanthine could be considered as a useful tool for the evaluation of the level of oxidative stress within the body under conditions of excessive/strenuous exercise. As such, it could be considered to be a more specific indicator of oxidative stress than the ascorbate which was discussed in the previous chapter.

Oxidative stress caused by reactive oxygen species contributes to many diseases including inflammation, autoimmune diseases, cancer, neurodegenerative diseases or heart attacks. Humans and animals are exposed to oxidative stress by different sources, not only internal, also external sources. The mastication and digestion of foods provide different reactions such as lipid peroxidation. For this reason, saliva can be considered as one of the first lines of defence within the body against oxidative stress. The use of saliva as a medium through which to assess the level of oxidative stress can be more convenient when compared with other sampling methods. It is generally a non invasive method that does not need professional expertise (cf. blood sampling) which greatly simplifies the sampling process. This chapter informs about the study of the purine content in saliva and explains the development of a novel biosensor that could ultimately be used as part of point of care sensing strategy for the determination of xanthine.

Diverse methods have been reported for the determination of xanthine - most of them combine the use of HPLC with spectrometric detectors [5,13-15] however these methods are tedious, expensive and time consuming. Electrochemical sensing techniques have been growing in interest because they are generally of simple operation (in terms of sampling and processing), low cost and the response can be obtained immediately at the site of analysis or point of care. However the electrochemical determination of xanthine is not so simple and there are some issues that need to be taken into account.

One of the main problems for the determination of purines is that the oxidation potentials of these analytes are very similar to those of other electroactive components and with other purines and can compromise the selectivity of the method. Xanthine for example has a similar potential to guanine and adenine. Cyclic voltammograms detailing the response of some purines at a glassy carbon electrode are shown in Figure 8-2. Moreover, the oxidation of xanthine therefore can require a relatively large detection

potential which, as discussed in Chapter 6, can compromise those sensors based on a chronoamperometric detection methodology.

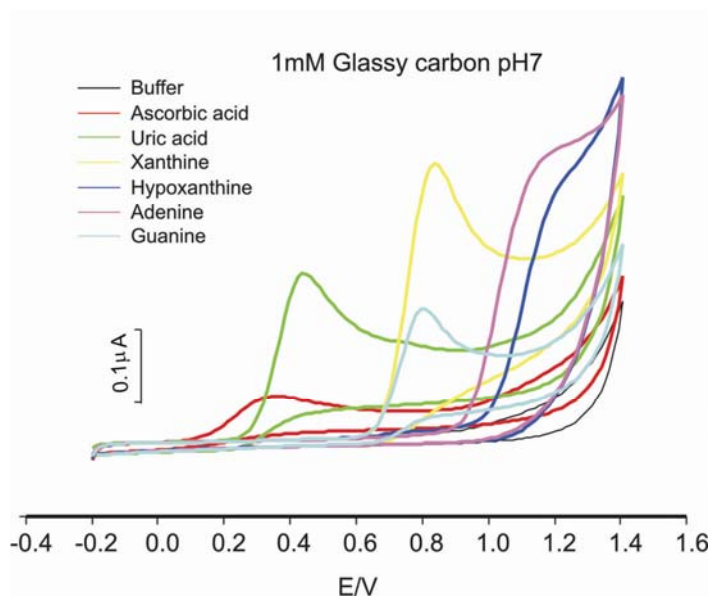

Fig 8-2: Cyclic voltammograms of different purine compounds at a glassy carbon electrode in Ph 7 buffer. Scan rate 0.1 V/s

The potential of uric acid is considerably different from that of xanthine and, as such, it could be possible to distinguish between them using a single voltammetric scan. However, the large anodic potential required to oxidise the xanthine can be problematic in a real sample where other species may also be oxidised. Fast scan cyclic voltammetry at a carbon fiber electrode has been successfully used for the simultaneous determination of xanthine, hypoxanthine and uric acid [16]. Another alternative and the strategy being investigated here involves the use of enzyme biosensors as they offer highly selective analyte/substrate recognition and thereby can allow a route through which to avoid possible interferences such as uric acid. Biosensors based on Xanthine Oxidase are one of the most common approaches for the determination of xanthine [2,3,17-22].

The sensing strategy for xanthine biosensors is based on the indirect determination of H_2O_2 production or O_2 consumption. Monitoring the consumption of O_2 has some issues, biological samples contain a relatively high concentration of O_2 and it can be

difficult to detect the small amounts of O_2 consumed. The indirect determination of xanthine or hypoxanthine by the evaluation of H_2O_2 produced is much easier because biological fluids normally do not contain H_2O_2 . However the high potential at which hydrogen peroxide is oxidized may still compromise the selectivity of the biosensor and supposed advantage of the molecular recognition provided by the enzyme will be lost. Uric acid which is present in most biological fluids will interfere in the sensing process because it is oxidizable at the potential at which hydrogen peroxide is oxidized. Different strategies have been raised to overcome this problem. Usually the use of mediators such as $CuPtCl_6$, 1,1-dimethylferricinium or osmium-poly(vinylpyridine) can easily solve the problem. The mediator acts as a redox acceptor which can be oxidized at lower potentials. The use of a less positive potential for the determination of xanthine also increases the lifetime of the sensor avoiding the use of extreme potentials. Another approach that was recently reported is the use of a Pt electrode covered with a polyelectrolyte multilayer film (PMF) composed by poly (allylamine hydrochloride) (PAH) an poly(vinylsulfate) (PVS) in combination with xanthine oxidase. The polyelectrolyte film blocks the surface of the electrode from uric acid but remains permeable to hydrogen peroxide [17].

The construction of enzyme biosensors has some concerns. Enzyme immobilization is one of the most important steps in the construction of enzyme biosensors. The enzyme needs to be immobilized in a manner that the enzyme upholds its conformation to preserve its activity. Different techniques have been reported for the immobilization of xanthine oxidase on the electrode surface. It has been immobilized by entrapment in nano Na_2CO_3 , where the highly hydrophilic properties of the latter provides a comfortable environment for the enzymes which retain most of their activity [2]. The 3D structure of the nanoparticles results in a high surface area for enzyme attachment – immobilisation being achieved through cross linking with glutaraldehyde. A novel immobilization strategy was reported by Renayldo Vilallonga and co-workers where they modified xanthine oxidase with 1-adamantanyl residues to immobilize the latter in a supramolecular architecture with cyclodextrin with the enzyme reported to retain 82% of its initial activity [17].

Another issue to consider is that the catalytic centre of the enzyme is normally located deep in the structure of the enzyme which is difficult for the direct transfer of electrons to the electrode surface. The small size of nanoparticles has been used to facilitate the transfer of electrons from the catalytic centre to the electrode. A variety of micro-nano materials have been used for this purpose. Gold nanoparticles have shown to retain most of the activity of the biomolecule and together with its high surface area, and good electronic properties create an excellent material for the construction of biosensors [4, 18, 23]. A novel material that has been used in combination with gold nanoparticles and mineral oil for the determination of xanthine and hypoxanthine is glassy carbon microparticles resulting in a novel glassy carbon paste biosensor [18]. The authors suggest that the immobilization of the enzyme by the incorporation of the latter in the paste is superior for the conservation of the enzyme bioactivity than if the enzyme were immobilized onto the gold nanoparticles alone. Platinum electrodes have been often used as a base material but this has more to do with providing a conduit for the detection of the peroxide than stabilising the enzyme [17, 21].

The approach being taken in this chapter involves the non covalent encapsulation of xanthine oxidase within a patterned durapore filter-polycarbonate-carbon matrix. The sensor is built on a novel platform that allows an easy incorporation of the enzyme without losing the enzyme freedom and therefore it could be anticipated will retain activity. The approach is relatively generic and offers a simple route to other analyte sensing strategies through simply changing the enzyme. There are no immobilisation issues and, as such, it offers a procedurally simple alternative to conventional polymer entrapment of gluteraldehyde cross linking. Monitoring the levels of xanthine is most commonly done in serum, blood and urine but few reports have been done in saliva. Given that there is a clear relation between extreme exercise and oxidative damage - the present chapter aims to develop a new biosensor which facilitates the study of oxidative stress resulting from overexercise in animals rather than humans.

The interest in animals follows on from the initial animal welfare investigations outlined in Chapter 4. Again the focus was on horse, donkey and llama saliva samples given the possibility of abuse relating to overexercise – whether as a consequence of

sport (horse racing), leisure (ie beach donkey) or work (pack animal) activities. The studies were meant to complement those investigations by providing a more specific indicator rather than the thiols (Chp 4) or ascorbate (Chp 6) which are indicative of general wellbeing. To the best of our knowledge no reports have been conducted on the determination of xanthine in saliva as a biomarker of oxidative stress.

8.3. Experimental Set-up

All reagents were of the highest grade available and were used without further purification. Xanthine oxidase was purchased from Sigma-Aldrich, Xanthine solutions were prepared by dissolving the solid initially in a small volume of 0.1M NaOH and then adjusted with BR buffer to pH 7. Electrochemistry was conducted with a μ Autloab computer controlled potentiostat. A three electrode configuration was used, the filter biosensor acting as a working electrode, Ag/AgCl (3M KCl) as reference electrode and Pt wire as a counter electrode. All electrochemical measurements were done at $22\pm 2^\circ\text{C}$ in 0.4M BR buffer. Chromatographic experiments were conducted with an Agilent HPLC 1200 series. The column was an ODS (1) sphereclone $3\mu\text{m}$ particle diameter. The mobile phase consisted of 30mM phosphate buffer (pH 7) at a flow rate of 0.7 mL / min. A CO_2 laser (Cad Cam Technologies) was used for the construction of the filter paper sensor.

8.3.1. Sample Collection.

Saliva samples were collected with a baby sterlin buccal swab, the device was swabbed over the mouth of the subjects and the cotton/saliva soaked portion cut off and placed in an eppendorf with $0.75\mu\text{L}$ 0.1M Na_2SO_4 to stop the action of any enzymes that may be present with the saliva fluid. The high concentration of salt also helps to precipitate the proteins from solution. After the chemical treatment, samples were

centrifuged at 4,000 rpm during 30 minutes to eliminate the proteins. The samples were then stored within a fridge/freezer at under 4 °C until use.

8.3.2. Electrode Construction

For the construction of the sensor, a durapore® membrane filter of 0.22µm pore size was used as a platform for the enzyme immobilization. This serves as a 3D mesh framework through which the enzyme can, in principle freely move and thus has little impact on the activity. The filter is then encased in a polycarbonate-carbon sleeve (prepared using the method described in Chapter 5). The filter pore structure prevents the polymer/carbon particles from encroaching into the filter and localises the conductive material at the interface. This essentially creates a sandwich type arrangement in which the enzyme is free to move within the centre of the framework with the polymer-carbon layers serving as the detection conduit. A hole is created in the top polymer layer which allows the sample fluid to diffuse into the filter network and thus reach the enzyme – but the same network retards the loss of the enzyme to the external solution. In one sense it acts like a frit. The filter was pre-patterned with a CO₂ laser to define a working area within which the enzyme would be entrapped and effectively stops its movement along the either mesh framework. The basic design of the filter is shown in Figure 8.3.

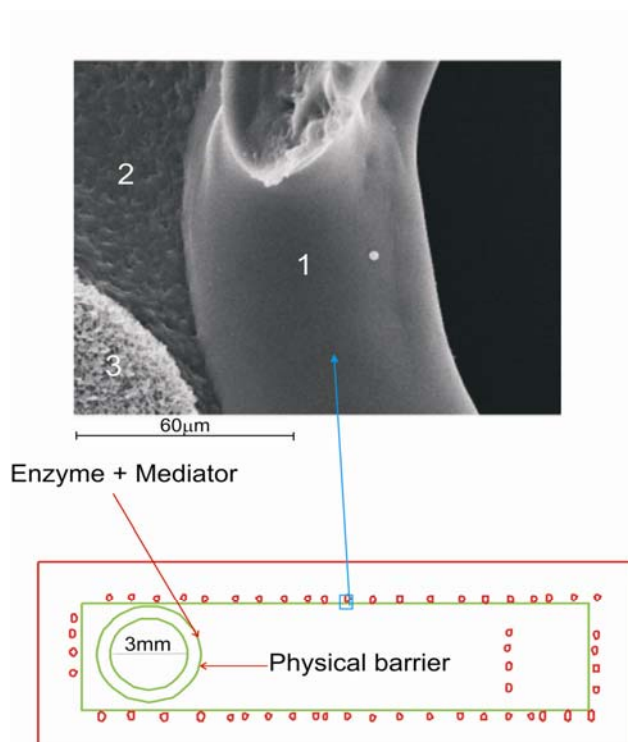

Figure 8-3: SEM image of the filter after laser treatment and a sketch of the filter pattern.

Different filters were used to encapsulate the enzyme along with the mediator but preliminary experiments found that the best results were obtained with Durapore® membrane filters (Polyvinylidene fluoride, PVDF) 0.22 μm pore diameter. The filter needs to be able to entrap the enzyme but if the diameter of the pore mesh that constitutes the framework of the filter is too large, the enzyme will leak into the sample solution. The laser was used to produce selective melt zones which effectively seal the pores and creates a barrier against solution transport along the length of the durapore filter. The selection of the laser conditions is vital as if the power is too high it will ablate the polymer resulting in holes rather than melt the filter material. The conditions of the laser are shown in **Table 8-1**.

N°pases	1	1
Arc error	25	25
Velocity cm/s	11.6	8
Max power %	8.5	5
Min power %	8	4

Table 8-1: Laser conditions

The first circle has a 3mm diameter and was intended to contain the enzyme and the mediator in a defined area, the second circle was built as a physical barrier to avoid the enzyme and mediator dispersing throughout the filter. The holes were used to attach the carbon polymer to the filter and prevent the polymer from peeling from the filter. The SEM image of the filter after laser patterning is shown in **Figure 8-3**. Different laser power was used to pattern the filter, Number **1** shows the result of the appliance of a power of 10 which was used to make the holes on the side to attach the carbon filter, as it can be appreciated from the SEM picture, the porous nature of the filter is completely destroyed at that point by the laser. Number **2** shows the result of the appliance of the laser at power 5 to make the physical barrier to contain the enzyme and the mediator in a defined area, the porous nature of the filter is also destroyed but without burning the filter or making any hole. Number **3** shows the natural porosity morphology of the filter without any laser treatment. It is within the latter area where the enzyme and mediator will be encapsulated. A number of different enzyme/mediator ratios and the best results were obtained with 6 μL of the enzyme (10 mg/mL) and 1.5 μL of 25mM mediator. The solutions were allowed to evaporate and then coated with the polymer-carbon composite.

Another interesting finding was that the activity of the enzyme was better conserved if the enzyme was added before the mediator. Once the enzyme and the mediator were immobilized onto the filter, the latter was immersed in the carbon-polycarbonate solution. One of the hypotheses that could explain why the enzyme activity was best conserved if the enzyme was added previous to the mediator is that the mediator solution once dry can act as a protection layer in front of the dichloromethane (DCM) used in the preparation of the carbon polymer solution (Chapter 5) and which will probably damage the enzyme in a more drastic way. After the carbon polymer was dry, a connection was made with copper tape and then the sensor was immersed in a solution of polycarbonate (no carbon) dissolved in DCM to insulate the sensor. To expose the enzyme and mediator, a hole was introduced directly above the 3mm entrapment zone and pierced through the polymer layers exposing an access pathway to the underlying filter network.

8.4. Results and Discussion

8.4.1. Saliva, A Biological Tool: Chromatographic Studies

As saliva is a complex matrix, a chromatographic method was developed to separate and analyse the different components and to quantitatively study the differences between the purine species. A standard mixture containing 1mM of allantoin (A), uric acid (UA), creatinine (CR) and xanthine (X) in Na_2SO_4 was injected into the HPLC prior to conducting the actual saliva analysis.

The main difference between humans and animals in the salivary content was the high levels of uric acid in human saliva if compared with the results obtained in the analysis of saliva of different animals. This can be explained through the absence of the enzyme uricase in human biochemistry which converts the urate to allantoin [6]. In humans uric acid can have a protective role as an anti-oxidant - being oxidized by reactive oxygen species to allantoin and thereby protecting the body.

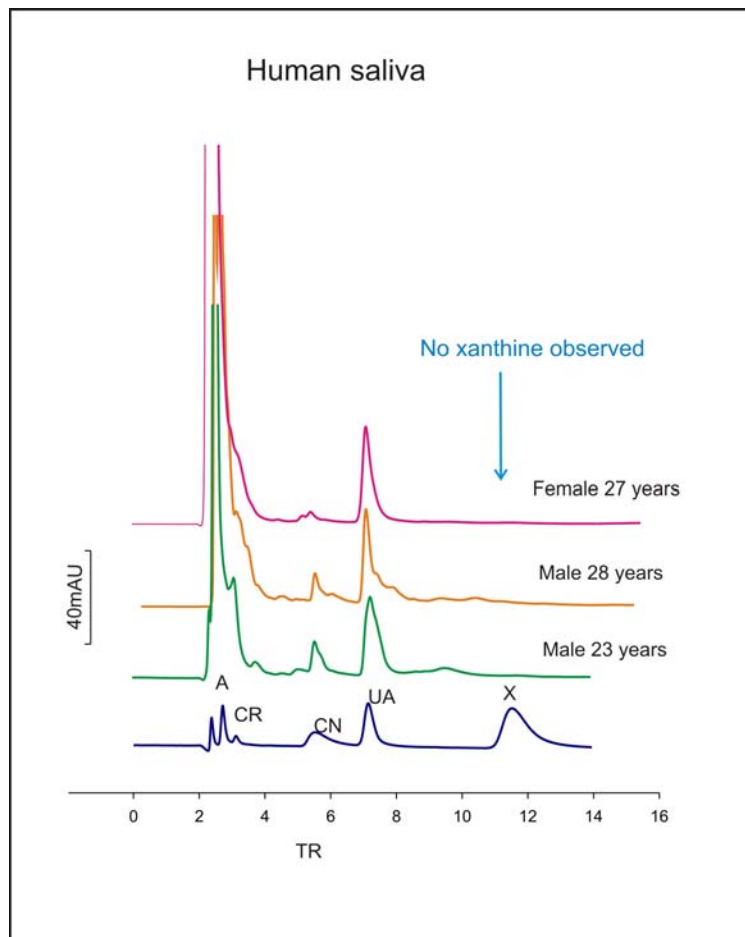

Figure 8- 4: Chromatograms detailing the analysis of different human saliva samples

Figure 8-4 shows the chromatograms obtained from the injection of human saliva. The sample pool is very limited but a number of interesting features can be extracted from the profiles highlighted in **Figure 8-4**. The content of creatinine was found to be higher in males than in females and there is no detectable xanthine in any. Kočańska. et al [24] reported that the content of human salivary xanthine is between $0.88\mu\text{M}$ and $1.58\mu\text{M}$. The low content of xanthine in human saliva could be the reason why it was not possible to quantify this analyte in the above samples. The chromatograms highlighted in **Figure 8-5** stands in marked contrast to the human study with xanthine found in all of the animal samples.

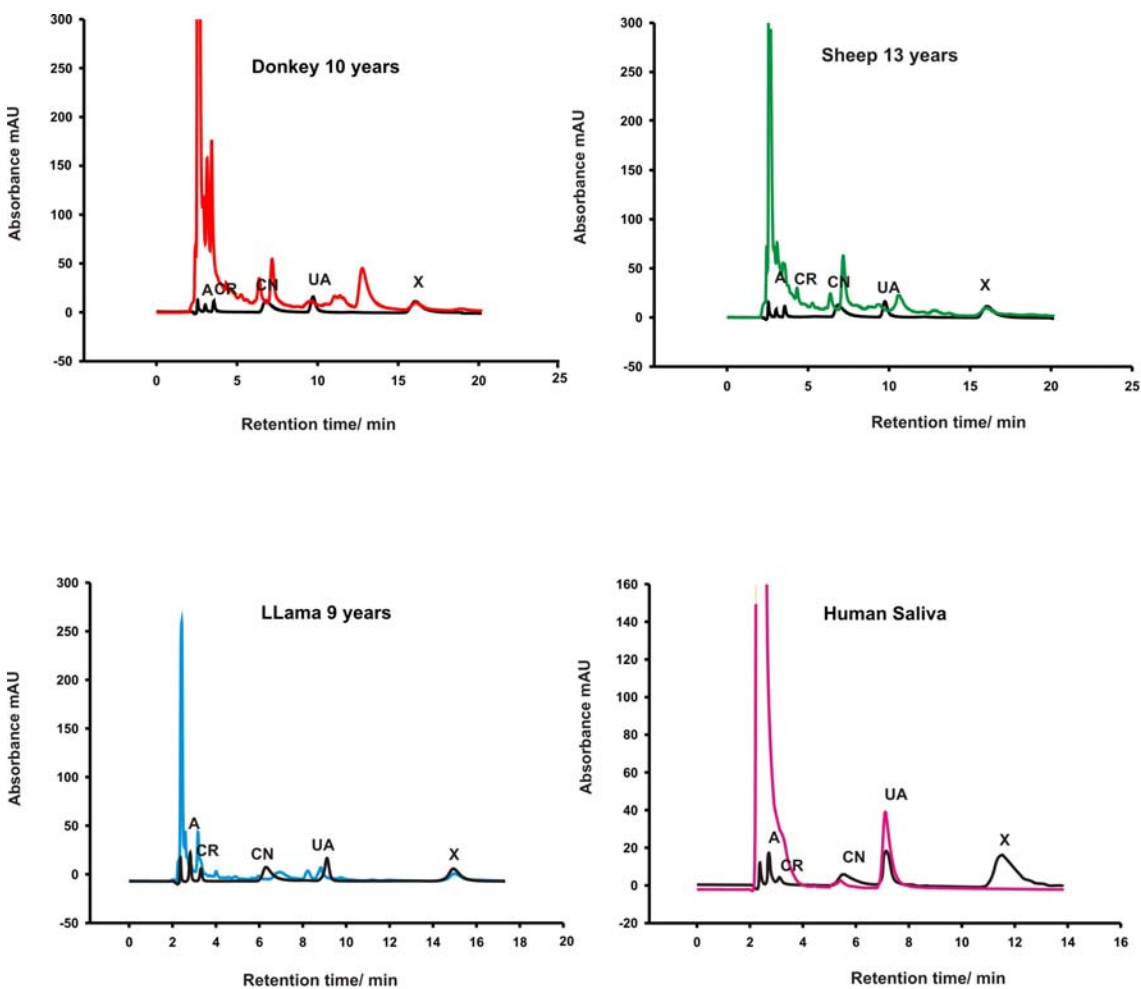

Figure 8-5 : Chromatograms obtained from donkey, sheep, llama and human saliva compared to the standard analyte chromatogram (black line)

A calibration graph of xanthine was prepared and quantification of xanthine in saliva from different llamas was carried out. To study the stability of the sample under 0.1M Na_2SO_4 , the same analysis was performed during different days. The results (**Table 8-2**) showed that the sample was stable after 5 days and that Na_2SO_4 inhibits the action of any enzyme present in saliva.

	Llama1	Llama2
First day	22,14 μ M	21,07 μ M
Third day	14,8 μ M	21,33 μ M
Fifth day	21,7 μ M	28,1 μ M

Table 8-2: Xanthine amounts obtained from llama's saliva

The results (**Table 8-2**) showed that saliva has a high content of purine metabolites and could be a non invasive way to evaluate the wellbeing of animals and individuals. The chromatographic analysis of saliva shows some interesting results and HPLC has been shown to be a useful tool capable of separating and quantifying the content of purine metabolites. However, the chromatographic analysis of saliva is tedious- the sample needs to be treated to precipitate the proteins, is time consuming - each analysis taking 20 minutes and requires a high level of expertise to interpret and subsequently quantify the respective components. It is clear that a more accessible and simple analytical option would be required.

8.4.2. Electrode Characterization

Among all purine metabolites it was decided to focus the investigation in the detection of xanthine because it is an interesting biomarker of different disorders as explained in the introduction. Moreover, the enzyme xanthine oxidase is readily available in a highly active form and could be readily integrated into an electrochemical device – which could ultimately be as simple to use as the commercial glucose meters. The next step was to study whether or not the device building process would affect the xanthine

enzyme and to ensure that it would respond to xanthine. The conventional sensing approach would be to measure the production of hydrogen peroxide by the enzyme in the presence of the substrate. As mentioned previously, the detection of hydrogen peroxide normally requires a high oxidation potential - this will compromise the selectivity of the signal and will shorten the life of the sensor. To overcome this problem, a mediator was incorporated into the sensing strategy. The mediator needed to be relatively insoluble in aqueous solutions, to avoid the leaching of the latter during the sensing process and must possess a low oxidation potential to overcome the interference of other analytes that it can be present in real samples. In addition, it needs to be electrochemically reversible and that it will react rapidly with the enzyme. Ferrocenyl Methanol was chosen because it is sparingly soluble in aqueous solutions, is reversible and has an oxidation potential around 0.3V vs Ag/AgCl. The sensing strategy to be adopted is highlighted in **Scheme 8-1**.

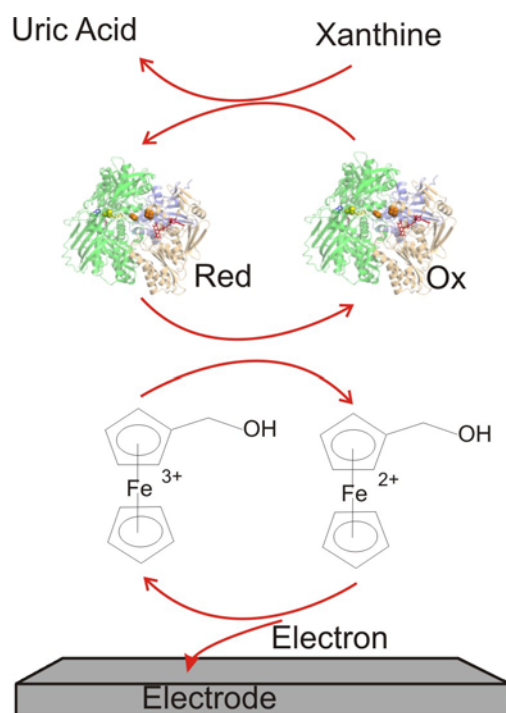

Scheme 8-1: Sensing strategy

The electrode design outlined in **Figure 8-3** takes a novel approach to biosensing so rather than immediately start with xanthine oxidase – preliminary investigations of the design construction, operation and fabrication optimisation were conducted using glucose

oxidase as a biocomponent as it is relatively cheaper than the xanthine oxidase and its electrochemical behaviour has been extensively studied.

Voltammetric measurements of the filter device were conducted with a three electrode system; the working electrode was the filter sensor, Ag/AgCl acting as a reference electrode and Platinum wire as a counter. A drop of BR buffer (pH7) was added to the electrode surface and 10 voltammetric scans were run to stabilise the sensor response. The peak current increased proportionally with the first 6 scans and then remains constant. This may be due to the filter slowly absorbing the solution and therefore the surface of the electrode in contact with the solution increases. As the electrode area is proportional to the electrochemical signal, the signal will increase with the activation of the electrode area.

Cyclic voltammograms detailing the typical response of the enzyme in the presence of both mediator (ferrocenyl methanol) and substrate (glucose) within the prototype device are shown in **Figure 8-6**. A good catalytic response was obtained in the presence of glucose and confirms the analytical viability of the model system.

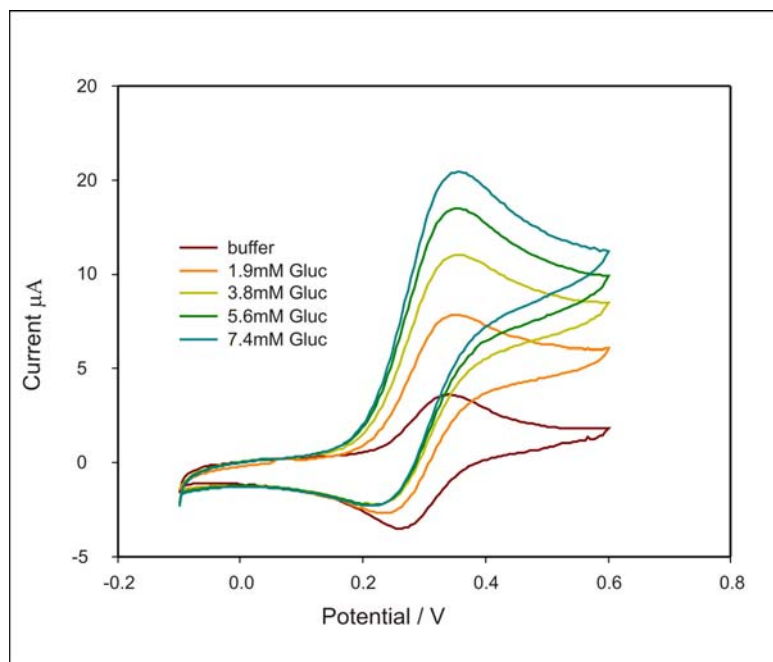

Figure 8-6: Cyclic voltammograms detailing the response of a glucose oxidase/ferrocenyl methanol mediated system to increasing concentration of glucose. Scan rate: 50 mV/s

Cyclic voltammograms showing the catalytic behaviour of the mediated xanthine biosensor are shown in **Figure 8-7** and provides a profile not dissimilar to those observed with the glucose system. Xanthine oxidase catalyses the oxidation of xanthine to uric acid, the electrons produced in the reaction will be accepted by the ferrocene derivative, which acts as a cofactor replacing dioxygen, The enzyme is returned to its oxidised state and the ferrocene is reduced. The reduced form of the ferrocene derivative is then oxidised at the electrode surface with the current produced being related to the concentration of the xanthine. The small current of the cathodic peak of ferrocene is because the ferrocene is chemically reduced by the enzyme.

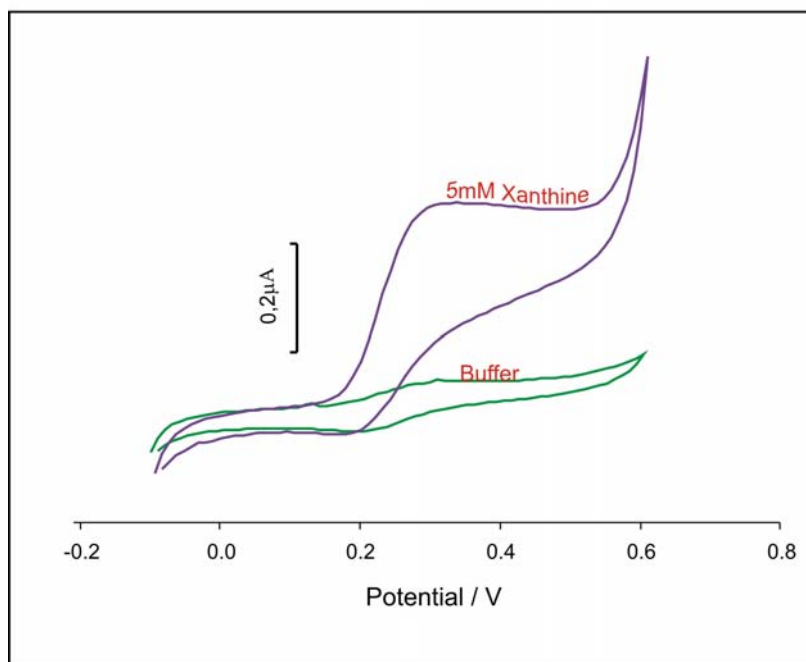

Figure 8-7: Cyclic voltammograms showing the catalytic behavior of the mediated enzyme biosensor. Scan rate 0.1 V/s

In a normal response for a mediated catalysed enzyme reaction, a large anodic current is expected with a limiting or plateau current. In **Figure 8-8** it can be observed that there is an absence of this plateau current, instead we observe an anodic current after 0.6V greater than that obtained with the catalytic reaction. This can be attributed to the direct oxidation of xanthine. This feature was not observed with the glucose system as the

glucose is electroinactive at the carbon electrode. The main point to be taken from the experiment is that the xanthine oxidase remains active after the fabrication process and is capable of catalysing the oxidation of xanthine. The mediated system will also allow the imposition of lower detection potentials and hence avoids the need to extend the range to the large anodic potentials required for the direct oxidation of the analyte as indicated in **Figure 8-7**.

The next step was to establish the linearity of the sensor as shown in **Figure 8-8**. The anodic peak was found to increase linearly with the increase in xanthine concentration.

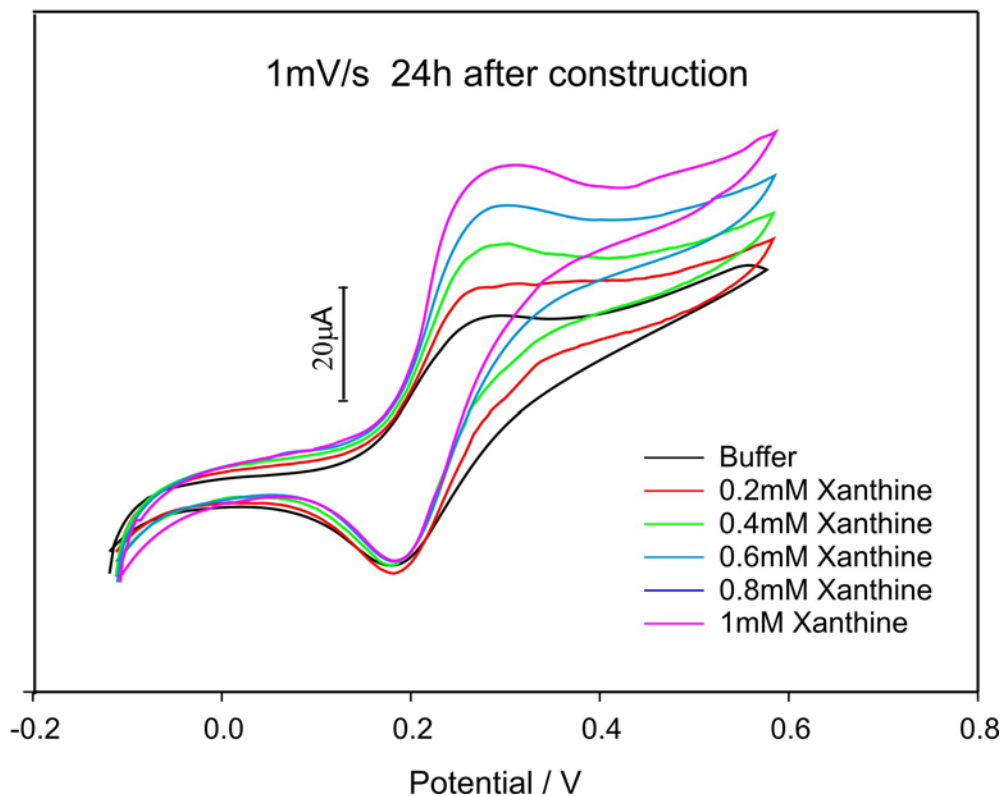

Figure 8-8: Cyclic voltammograms in 0.4M BR-buffer (pH 7) of the mediated xanthine oxidase biosensor obtained by the addition of different xanthine concentrations. Scan rate 1mV/s

It is likely that the development of the sensor to a portable format would require a chronoamperometric detection methodology – given the considerable instrumental simplicity offered and again mirror the type of technology exploited in the glucose meter systems. Thus, to further confirm the ability of the sensor to quantify xanthine, steady state chronoamperometry measurements were conducted. In order to avoid the noise caused mainly by the magnetic stirrer, the set up was placed within Faraday cage. The potential applied was +0.3V and the electrolyte was BR-buffer (pH7) and the amperometric response detailed in **Figure 8-9**

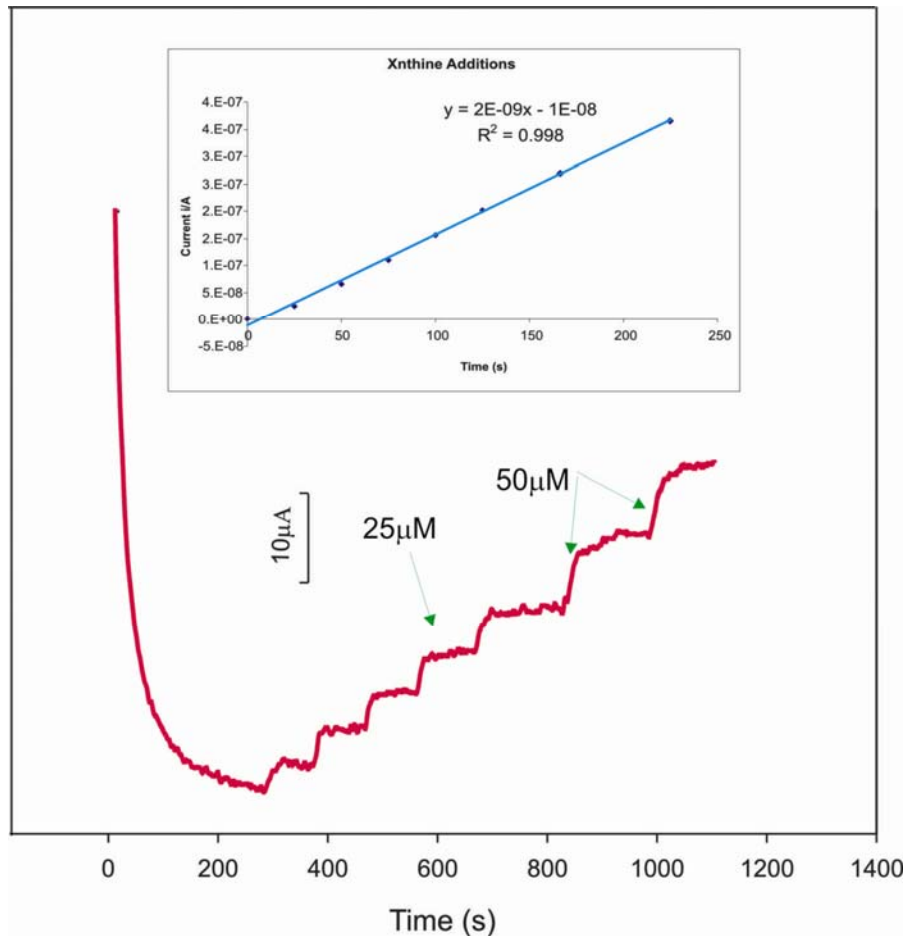

Figure 8-9: Steady state chronoamperometry of the additions of xanthine with the composite biosensor.

A linear dependence of the amperometric response with the biosensor operating at 0.3V was found in the linear range between 50-250 μ M ($R^2 = 0.998$). The data obtained with the steady state chronoamperometry was subsequently evaluated with a Lineweaver-Burk plot (**Figure 8-10**). The immobilized enzyme showed K_m and V_{max} values of 1,26 mM and 2,15 μ mol/s respectively. The K_m was higher than the corresponding native enzyme $K_m = 0,45$ mM suggesting that the affinity of the enzyme for substrate is attenuated after entrapment. This results were, to some extent, expected as in the entrapment process, the enzyme will lose some freedom and therefore some activity, however this value is better than the values found in previous publications, Villalonga and co-workers developed a sensor with 9.9mM and another with 2,1mM, This fact corroborates the ability of the filter paper sensor as a platform for enzyme entrapment.

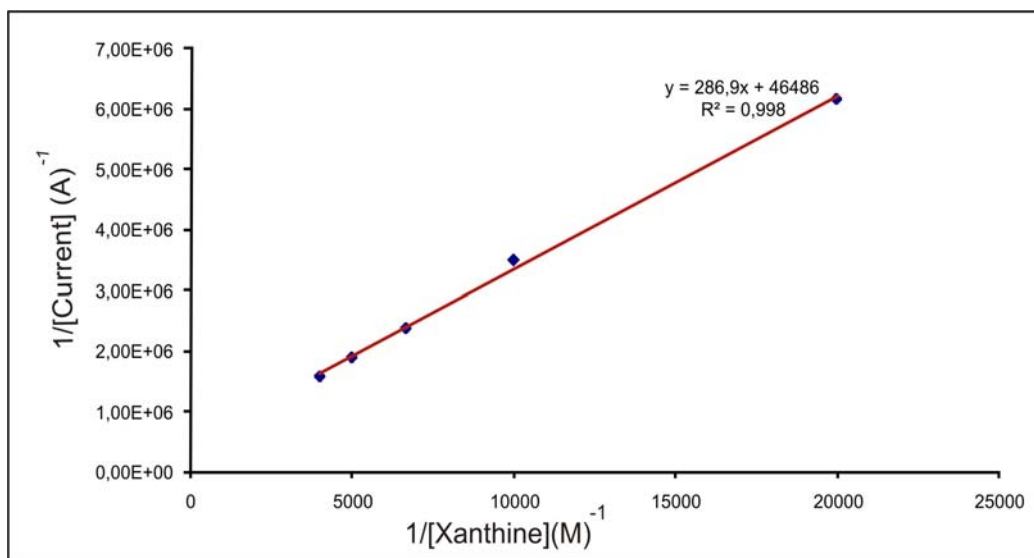

Figure 8-10: Lineweaver-Burke plot of the data obtained with chronoamperometry measurements detailed in Figure 8-10

When the sensor was tested with saliva, a high response was obtained but it was envisaged that this was not only due to xanthine. Given the ability of ferrocene and its derivatives to catalyse the oxidation of ascorbate (as indicated in Chapter 6). It is highly possible that the vitamin response to the mediator results in an artificial amplification of

what should be the xanthine response. In order to avoid the interference of ascorbic acid we coated the biocomposite with Nafion. The latter forms a polymer containing sulphonic acid (R-SO₃H) groups which when placed in aqueous solution result in the polymer acquiring a negative net charge. This polymer has been extensively used to remove the interference of ascorbate however in the attempts to coat the filter electrode resulted in a loss of activity. No response to xanthine was observed and could be attributed to either the solvents used for coating the filter denaturing the enzyme or the simple fact that the xanthine, like ascorbate, is excluded from the device.

The next approach was to investigate the possible use of copper oxide to eliminate ascorbic acid. A thin layer of copper oxide was deposited in a centrifugal filter placed within an eppendorf. An aliquot of ascorbic acid (200 μL, 10mM) was added and left to react. The rationale was to exploit the capability of copper oxide as a catalytic surface through which to oxidise the ascorbate. After a period of 45-60 minutes, the sample was centrifuged at 2000 rpm during 10 minutes. The centrifugation force is a crucial step, the speed needs to be high enough to allow the flow of the solution through the centrifugal filter of the eppendorf but slow enough to encourage the ascorbate to slowly filter through the copper oxide and thus come into contact with it. The copper oxide particles are retained in the filter and the sample (hopefully minus ascorbate) is collected in the filtrate. The results obtained after filtration showed that the ascorbate had been largely eliminated. Unfortunately time constraints on the project prevented the transfer of this approach to the prototype filter but would obviously be an avenue for further development.

8.5. Conclusions

The chromatographic studies of saliva demonstrate the potential of this biological fluid as a non invasive screening method to assess and study the levels of oxidative stress in the body. The development of a more portable and simple approach was made by the construction of a novel biocomposite electrode which builds on the work in previous chapters but has resulted in a generic design allows the rapid production of reagentless

bioprobe. The biocomponent was found to provide the selectivity required for the evaluation of complex matrixes and offers an alternative to chromatographic methods. The fundamental characterisation of the electrode design has been conducted but future work would involve a more robust investigation of the sensor performance in real samples. Chromatographic analysis has confirmed the presence of measureable quantities of xanthine in saliva and the application of the biosensor could be directed towards the follow-up of oxidative stress in animals such as race horses or pack animals.

The novelty of the approach takes root in the platform used to immobilize the enzyme. Durapore® membrane filters were shown to be a good base for enzyme immobilization with the K_m being quite similar to the one of the native enzyme which implies that the enzyme does not lose much of its activity upon entrapment. Another advantage is that the enzyme immobilization does not need any pre-treatment and it is done simply by drop casting the enzyme into the filter paper. The entrapment of the mediator within the electrode can also serve as the basis of reagent free sensor – requiring only the addition of the test sample. The influence of ascorbate was found to be problematic but a possible remedy has been identified through the use of copper oxide particles. The latter requires further work to establish its applicability but clearly lays the foundations for further development of the sensor.

8.6. References

1. Millis PC, Smith N C, Harris R S, Harris P (1997) *Research in Veterinary Sciences*, 62 11-16
2. Shan D, Wang Y, Xue H, Cosiner S (2009) *Sensors And Actuators B*,136 510-515
3. Shan D, Wang Y, Zhu M, Xue H, Cosiner S, Wang C (2009) *Biosensors and Bioelectronics*, 24 1171-1176
4. Çubku M, Timur S, Anik U (2007) *Talanta*, 74 43-439
5. Bory C, Chantin C, Boulieu R (1996) *Journal of Chromatography* 730 329-331
6. Shihabi Z K, Hinsdale M E, Bleyer A J (1995) *Journal of Chromatography B*, 669 163-169.
7. Bavaresco C S, Chiarani F, Matté C, Wajner M, Netto C A, de Souza-Wyse A T (2005) *Brain Research*, 104 198-204.
8. Xu X, Hu X, Lu Z, Zhang P, Zao L, Wessale J L, Bache R J, Chen Y (2008) *Journal of cardiac Failure*, 14 746-753
9. Huang C C, Tsai S W, Lin W T (2008) *Experimental Gerontology* 43 571-577
10. Kne W L, Coombes J S, Jenkins D G (2006) *Sports Med*, 36 429-431
11. Sanchdev S, Davies K J A (2008) *Free Radical Biology & Medicine*, 44 215-113
12. Luchtemberg M N, Petronilho F, Constantino L, Gelain D P, Andrades M A, Riter C, Moreira J C F, Streck E L, Dal-Pizzol F (2008) *Clinical Biochemistry*, 41 1186-1190
13. Samanidou V F, Metaxa A S, Papadoyannis I N (2002), *J.Liq.Chrom & Rel.Technol*, 25 43-57
14. Czaudern M, Kowalczyk J (2000) *Journal of Chromatography B*, 744 129-138
15. Safranow K, Machoy Z (2005) *Journal of Chromatography B*, 819 29-235
16. Cavalheriro E T G, El-Nour K A, Brajter-Toth A (2000) *Soc. Bras. Quimica*, 11 512-515
17. Hoshi T, Noguchi T, Anzai J (2006) *Materials Science and Engineering C*, 26 100-103
18. Agüí L, Manso J, Yáñez-Sedeño P, Pingarrón M (2006) *Sensors and Actuators* , 113 272-280
19. Salinas-Castillo A, Pastor I, Mallavia R, Reyes Mateo C (2008) *Biosensors and Bioelectronics*, 24 103-1056.
20. Villalonga R, Camacho C, Cao R, Hernández J, Matías J C (2007) *Chem. Comun*, 942-944
21. Shi G, Li M, Zhu M, Zhou T, Chen J, Jin J Y (2002) *Analyst*, 127 396-400
22. Villalonga R, Matos M, Cao R (2006) 9 454-458
23. Dronov R , Kurth D G, Möhwald H, Scheller F W, Lsdar F (2007) *Electrochimica Acta*, 53 1107-1113
24. Kochańska B, Smoleński R T, Knap N (2000) *Acta Biochimica Polonica*, 3 877-879.

Chapter 9

Phosphate Detection: Assessing the Generic Applicability of the Filter Sensor

Abstract

The previous chapter introduced the use of a filter network as a platform for enzyme entrapment. The work presented herein evaluates the transfer of the technology from one context to another and focuses, in this instance, on phosphate detection. This necessitates the replacement of the enzyme and the inclusion of additional co-factors. Pyruvate oxidase was selected on the basis that it catalyzes the conversion of pyruvate to acetyl phosphate. The enzyme reaction only proceeds in the presence of phosphate and involves a redox reaction that is similar to that utilised with the xanthine oxidase. The present chapter describes the first steps for the development of a promising pyruvate oxidase biosensor for the determination of phosphate however the transfer encountered a number operational issues – principally the competition of molecular oxygen. Its role and influence has been elucidated and a number of options highlighted that could lead to the further development of the sensor.

*The work presented in this chapter has been accepted for publication within the
Journal of Molecular Catalysis B-Enzymatic*

9.1. Introduction

The detection of phosphate in surface waters is important for the assessment of nutrient transformations from biogeochemical and ecological viewpoints and ever increasingly, from a regulatory and legislative standpoint [1-2]. The latter reflects increasing concerns of eutrophication of inland waterways by agricultural run off and other anthropogenic inputs [3-12]. Recent figures from UK government sources (Dept of Environment Farming and Rural Affairs) point to over 60% of river lengths in England possessing phosphate concentrations greater than 0.1 ppm and it is estimated that 40% of phosphate in inland water arises principally from agricultural sources. Such figures will obviously vary markedly depending on regional and seasonal factors [9,10]. Nevertheless, there is a clear need to monitor the concentration of such species in order to aid the balanced and sustainable management of water resources. Detecting the diffuse agricultural sources from which excessive amounts of phosphate are released to water courses is however a considerable challenge and it could be argued that field based measurements could be used to provide a versatile and indeed potentially invaluable screening option.

The interest in the use of field based measurements stems from a need to provide quick on-site assessments that could cover a greater geographical spread while obviating much of the costs, time delays and issues of sample integrity associated with traditional laboratory based analysis [1, 2]. Methods that allow for rapid detection are clearly of benefit when considering field measurements but there are numerous other practical considerations that must be weighed. While a variety of colorimetric spot test kits are commercially available and possess supreme portability, they can be prone to interference and provide, at best, qualitative results. The need for quick and quantitative site evaluations that can be conducted by non expert investigators could be addressed by the use of electrochemical detection methods. Issues of miniaturization, portability and operational simplicity have been addressed by various detectors commonly employed within decentralised sensing [12-14]. The extrapolation of such technologies to yield a viable technology platform for field testing of phosphate would appear feasible but issues of selectivity and sensitivity must be clarified [14,15].

Various detection strategies for phosphate have been proffered and include phosphate ion selective electrodes based on potentiometric techniques [16-30], indirect voltammetric detection based on the reaction of phosphate with various metals and associated complexes [31-40], and the development of sensors exploiting enzymatic reactions [41-67]. The aims of this chapter are to place these competing technologies within a critical framework that compares the merits and limitations of each, highlights the progress that has been made in recent years and investigate the application of the composite methodology developed in previous chapter for the production of a sensor capable of detecting phosphate.

Phosphates can exist in several forms depending on the source/nature of the discharge but are generally grouped within three broad classes: orthophosphates, condensed phosphates (pyro-, meta- and poly-) and organic phosphorus [1, 2]. The present chapter concentrates primarily on the determination of orthophosphate – the principal component within agricultural run off and the target to which most field based measurement are / will be designed. Instrumental techniques have long dominated phosphate detection with spectroscopic and flow injection / ion chromatographic methodologies routinely used for laboratory based analysis [68-76]. These are not considered in great detail here but, rather, are used for comparative purposes where appropriate. The material contained within the following discussion covers the application of electromolecular technologies in the broadest sense, but focuses on the bio-electrochemical interface that is increasingly being examined for environmental phosphate determination. Restricting the remit of the discussion to those reports solely based on environmental contexts has been avoided. A more general approach has been taken where the evolution of technological features that could, irrespective of proposed application, subsequently be adapted and harnessed within an environmental context are presented and critically appraised.

9.2. Potentiometric Detection

Potentiometric detection is one of the earliest direct electrochemical approaches taken to the detection of phosphate and has the attraction of possessing numerous

advantages when considering the development of sensing technologies, The recording instrumentation is inexpensive to produce, highly portable and it could be envisaged that the operational qualities would mirror those adopted within other ion selective electrode (ISE) sensors. While these features would appear to offer a mature foundation from which a sensor could be readily fabricated, the acquisition of sufficient selectivity and sensitivity to operate at the concentrations reported within the DEFRA analysis (typically below 0.1 ppm) remains problematic. Various approaches have been investigated and typically fall within the following divisions:

- 1) Metal / metal phosphate
- 2) Solid state membrane electrodes
- 3) Heterogeneous metal membrane electrodes (Metal phosphates covered with polymeric membranes)
- 4) Liquid ion exchanger
- 5) Redox electrodes

The merits and limitations of these have been reviewed [16] but there have been a number of subsequent developments that have sought to overcome the poor selectivity and advance the attractiveness of a phosphate ion selective electrode (PISE) systems. The measurement of phosphate concentration in a sample by a PISE depends on the change in potential as phosphate sample is added. Selectivity has to be the major criterion applied to any proposed PISE because related ions could also affect the potential and thereby interfere with the analytical signal. The design of a phosphate selective membrane however has proven to be difficult. In the first instance, the phosphate molecule is of a size that makes it difficult to devise a macrocyclic host-guest interaction that possesses sufficient specificity for that particular moiety. Also, the molecule is very hydrophilic due to the four oxygen atoms attached to the phosphorous atom. This demotes phosphate to the bottom of the Hoffmeister selectivity series, i.e.:

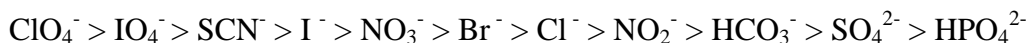

This means that the selective element of a potential PISE has firstly to reject the more lipophilic ions, then select for the least available ion. Many of the early PISE's failed by responding to ions other than phosphate. Some progress has been made with the use of metal / metal phosphate class of PISE in recent years with bismuth phosphate [17] and silver orthophosphate [18] as the selective components. While selectivity has increased with the developments in this field, there is still significant interference from chloride, bromide, iodide and sulphide.

A distinct group of PISE that has demonstrated some success for phosphate determination is based on a cobalt / cobalt oxide electrode [19-21]. The response mechanism is subject to some debate, being either a host - guest relationship [20] or a mixed potential response [21]. Nevertheless, it has been shown to be capable of detecting phosphate to 0.1 ppm (1 μM) whilst retaining a high degree of selectivity. Another promising development of PISE has been found with the use of organic complexes of tin. Electrodes made from PVC impregnated with different forms of organotin were found to be selective for phosphate and other oxyanions [22-25]. The tin (IV) centres facilitate binding of the oxygen atoms of the phosphate molecule and the organic complex increases this binding by withdrawing electrons from the tin. This electron withdrawing property, and consequent phosphate selectivity, could be further increased by replacing alkyltin compounds with benzyltin [23]. The more powerful electron withdrawing aromatic rings lower the Hammett constant [24] and provide superior selectivity to phosphate when considering the other Hoffmeister series anions. The main drawback of using the organotin membrane includes a short lifetime due to hydrolysis in the membrane.

Indirect detection through the formation of secondary components has also been investigated and typically exploits the interaction of metal ion with phosphate. This approach is based around the detection of the metal ion whose removal through the formation of an insoluble phosphate complex can be inversely related to phosphate concentration. Chief examples are molybdate [26], lead [27], cadmium [28] and silver ion selective electrodes [29]. A similar approach was taken with fluoride where the corresponding ISE was used to detect the release of the halide ion from its aluminum complex through the preferential binding of the phosphate [30]. While in principle these

methods are relatively sensitive – selectivity within complex media is questionable where other, similarly competitive, complexation reactions are liable to impact on the analytical performance.

9.3. Voltammetric Studies

Orthophosphate is not directly accessible to voltammetric studies and strategies adopting this methodology almost invariably rely upon the indirect association with molybdate complexes. The protocols are normally derived from the spectroscopic assay developed in the 1920's and are based on the blue coloured phospho-molybdate complex formed from the reaction of ammonium molybdate and orthophosphate [1,2].

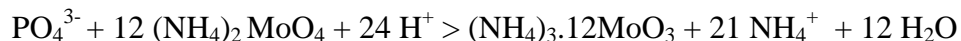

The voltammetric signal can be detected using a bare glassy carbon electrode at a potential of +1.3V and has been reported to offer detection limits in the micromolar range (typically 0.5 ppm, 5 μM). These compare favourably with many of the conventional spectroscopic procedures. However, the reaction is slow and can be prone to interference from a variety of sources (heavy metals, proteins). Nevertheless, several electrochemical methods have been successfully based on this reaction [31-39]. The main drawbacks relate to the very large operating potential – essentially at the limits of the electrode window and which could elicit responses from other matrix constituents.

An alternative approach employing host-guest interactions has also been the subject of voltammetric studies. Based on the cyclic oligosaccharide β -amino-cyclodextrin [22], phosphate was detected indirectly through the preferential displacement of ferrocene derivatives from the cavity of the macrocycle. The initial addition of the cyclodextrin derivative reduces the amperometric peak current response of the ferrocene. This is due to the complexation of the ferrocene by the CD host. Adding the phosphate ion to this mixture produces a cyclic voltammogram which corresponds to free ferrocene. There have been attempts to attach cyclodextrins to gold [40] for attachment to electrodes. The voltammetric studies though technologically promising

have yet to be submitted to a more rigorous analytical appraisal. Nevertheless, the voltammetric method does appear to offer a viable route than but, as yet, there is no phosphate selective device based on a carrier made from a cyclodextrin.

9.4. Phosphate Biosensors

The principal problem in the development of a phosphate sensor clearly centres on the acquisition of selectivity. Thus far, electrochemical methodologies appear unable to provide sufficient answers when confronted with real samples and there has arguably been an impasse in the evolution of traditional technologies. Potentiometric techniques lack a suitably specific ionophore while voltammetric approaches suffer from the redox inaccessibility of the phosphorus centre ion under aqueous conditions. The increasing interest in biosensing approaches however offers an alternative route that could provide greater selectivity through exploiting the molecular recognition capabilities inherent to biological catalysts. Orthophosphate has many roles within biological systems and a multitude of enzymes are responsible for the specific transfer of the anion to and from various organic carriers. The main questions that need to be addressed relate to how such biological components could be harnessed for the detection of phosphate and how they can be integrated within conventional electrochemical architectures.

Despite the promise of high selectivity, phosphate selective enzymes are not readily amenable to direct electrochemical interrogation. Biosensing detection methodologies commonly employ the electrochemical detection of either the enzymatic consumption of molecular oxygen or the production of hydrogen peroxide byproduct. One of the few, single enzyme, designs to adopt this approach for the detection of phosphate is based on pyruvate oxidase (POD) [41-44]. The reaction involves the conversion of pyruvate to acetyl phosphate. The reaction scheme is shown in **Figure 9-1** with the concentration of phosphate being inferred from the amperometric measurement of either oxygen depletion (**A**) [41] or the increase in concentration of hydrogen peroxide (**B**) [42].

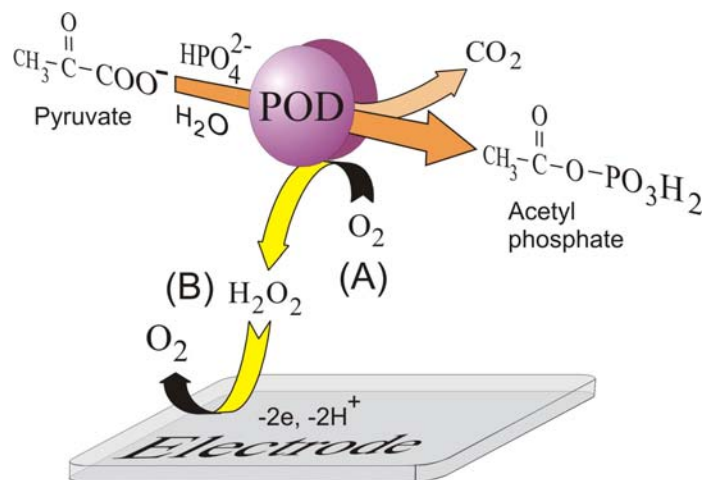

Figure 9.: Pyruvate oxidase sensing system allowing phosphate concentration to be quantified through detecting A) the consumption of oxygen or B) the production of peroxide.

These detection systems have the attraction of being relatively simple to implement – being built around mature electrochemical techniques – but they do possess a number of limitations. Attaining a stable signal can make the measurement of oxygen relatively slow or ambiguous with the magnitude of the signal dependent upon the concentration of dissolved oxygen within the sample – which may be problematic for some anoxic waters. The oxidation of peroxide is hampered by poor electrode kinetics at conventional electrode materials and requires the imposition of a significant overpotential ($\sim +1\text{V}$ vs Ag|AgCl) before quantifiable currents can be obtained. These can induce a degree of interference through the oxidation of other matrix components and may lead to an erroneous amplification in the signal. More recent designs have taken advantage of mediated systems where oxygen is replaced by an artificial electron acceptor that can be regenerated directly at the electrode [43,44]. The current obtained from re-cycling the electron shuttle is then related to the concentration of phosphate. The main advantages being that vagaries in oxygen tension are removed and the electrode potential required for the re-oxidation of the mediator can often be set within a region where the oxidation of other matrix components is avoided.

The most commonly employed enzyme in phosphate biosensors however is alkaline phosphatase (AP). This enzyme acts upon phosphate ester functionalities and will cleave the bond releasing the inorganic orthophosphate and the corresponding alcohol derivative. The latter has traditionally been chosen to provide a distinct signal that can be easily quantified using conventional spectroscopic techniques. The classic example is highlighted in **Figure 9-2A** where the hydrolysis of p-nitrophenylphosphate releases the chromogenic nitrophenolate ion. The absorbance of the anion (~ 400-420

nm) can be related to enzyme action and is usually exploited as a means of quantifying AP and forms the basis of countless enzyme linked immunoassay protocols [45]. The adaptation of the methodology for the detection of orthophosphate relies upon the inhibitory action of the latter on the hydrolysis of the ester substrate. Sample is assayed using known concentrations of enzyme/substrate with the deviation (decrease) of the signal from that expected in the absence of added phosphate being inversely related to the concentration of the latter.

Electrochemical adaptations rely upon the selective and sensitive oxidation of the hydrolysis product. The nitrophenolate systems are predominately used for spectroscopic detection but are also electrochemically accessible. One drawback is that the potentials required to oxidise the phenol component (~ +1V vs Ag/AgCl) are relatively large and, as with peroxide measurements, can promote interference from the oxidation of other components within the sample. A second factor that arises is where the oxidation leads to polymeric deposits on the electrode. These tend to block the electrode

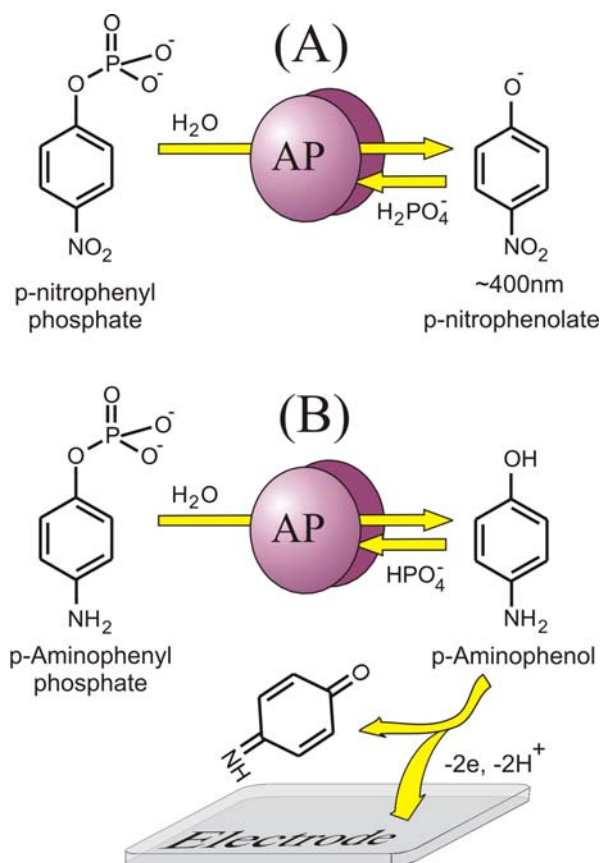

Figure 9-2: Spectroscopic (A) and amperometric (B) reaction schemes based on Alkaline Phosphatase (AP)

reducing sensitivity and compromising the reproducibility of the technique. An alternative approach is to select a label whose oxidation can be achieved at less positive potentials. Ferrocenyl [46] or aminophenol [47] derivatives (**Figure 9-2B**) have been investigated as they possess reversible behaviour (less likely to foul the electrode) and can be detected at significantly lower potentials ($\sim +0.3\text{V}$). The concentration of orthophosphate is determined by the magnitude of the decrease in oxidation current recorded at the electrode as a consequence of the inhibition process. There are few potentiometric biosystems for phosphate but one approach has successfully harnessed the AP enzyme induced cleavage of phosphate. In this case the ester is based on salicylate (o-carboxyphenyl phosphate), **Figure 9-3**, with the potentiometric detection of the latter with an ion selective membrane providing the basis of the analytical signal [48].

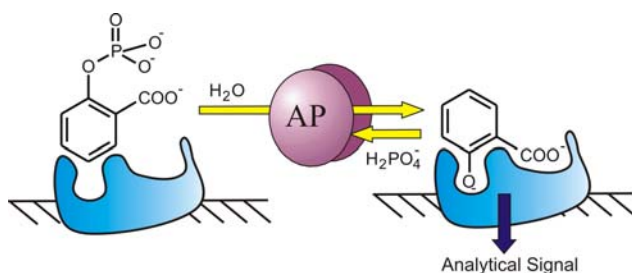

Figure 9-3. Potentiometric detection of phosphate exploiting Alkaline Phosphatase (AP) inhibition [48].

The majority of systems using AP tend to combine it with other enzyme catalysts – though inhibition remains the key determinant in signal processing. Such systems rely upon the synergistic interaction of the multi-enzyme assembly to yield a product (typically peroxide) that is electrochemically active and more amenable to detection than the labelled esters. The typical arrangement involves the phosphate selective enzyme (AP) producing a product which can then act as the substrate for a secondary enzyme whose purpose is to produce the electrochemical label. Quantification of the latter can therefore allow the amount of phosphate to be determined. Early implementations of bienzyme couples involved AP / Glucose Oxidase (GOX) assemblies with glucose-6-phosphate as the key substrate in the reaction, outlined in **Figure 9-4**.

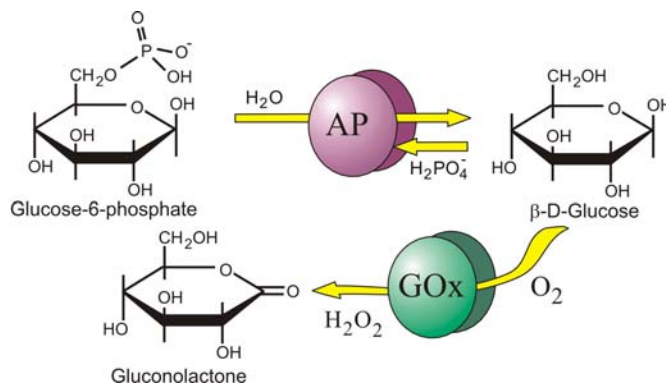

Figure 9-4: Bi-enzyme coupling of Alkaline phosphatase (AP)/ Glucose Oxidase (GOX) for the amperometric measurement of phosphate [49-52].

Increased sample phosphate inhibits the production of glucose and hence the consumption of oxygen is decreased [49-51] as is the yield of peroxide [52]. Immobilised enzymes systems are by their nature more complex to produce but such assemblies have been proven to operate within a range of environmental matrices and include fresh and sea water samples. Interference from heavy metal ions (mercuric, cupric and zinc) can occur, but these are not likely to appear in any appreciable concentration in natural samples. The limit of detection for phosphate using the AP / GOX combination was typically 0.4ppm (4 μ M) and is comparable to those obtained using the molybdate systems.

Improvements in detection limit can be achieved through the catalytic cycling of the hydrolysed label. A number of formats can be pursued but the prime requirement is that the label possesses reversible electrochemical behaviour (capable of fast redox inter-conversion). An early approach successfully exploited for the detection of sub picomolar concentrations of AP (and hence could be adapted for orthophosphate – albeit at higher detection limits) is outlined in **Figure 9-5**. In this case an excess of glucose is employed – and maintains the enzyme (GOX) in the reduced state. The electrochemical oxidation of the hydrolysed AP product, hydroquinone, produces benzoquinone which is chemically reduced through interaction with the flavin redox centre within GOX. A catalytic cycle builds up through which the current recorded at the electrode is effectively amplified [53].

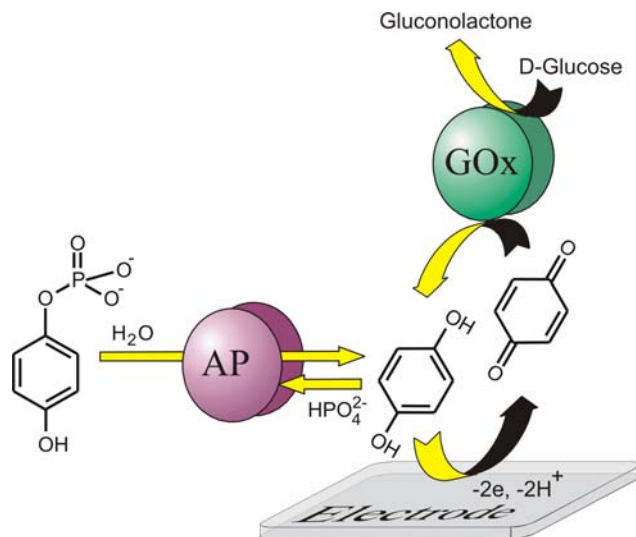

Figure 9-5.: Signal amplification through the Glucose Oxidase (GOX) promoted enzymatic recycling of the alkaline phosphatase (AP) hydrolysis product [53].

It could be envisaged that the introduction of a sample containing phosphate would inhibit AP. Signal amplification would be retained through the HQ/BQ-GOX cycle but would be less than that experienced in the absence of the added phosphate and hence could offer a means of improving the detection limits currently available to the simple AP/GOX system.

The key strength of alkaline phosphatase is that it is relatively non specific in terms of the nature of the phosphate ester upon which it can act. This provides a significant operational advantage over some of the other enzymes in that it can be directly coupled with a wider range of secondary enzymes. The use of phenylphosphate is an important example as it provides a route through which polyphenoloxidase (PPO), an enzyme of directly facilitating substrate recycling amplification, can be incorporated within the sensing structure [54]. The basic outline is shown in **Figure 9-6** and involves the cleavage of the phosphate group by AP with PPO acting upon the phenolic component to yield the ortho quinone. In contrast to most redox enzymes systems, the detection strategy involves the imposition of a cathodic potential (-0.2V) in order to reduce the quinone to the corresponding hydroquinone derivative. The current for the reduction will again be inversely related to phosphate concentration in keeping with its

inhibitory action upon the AP catalysed ester hydrolysis. The major advantage in this instance is that oxidation of other matrix constituents can often be avoided. The PPO component therefore serves to aid both selectivity and sensitivity providing a detection limit of 0.2ppm (2 μ M) for phosphate [55].

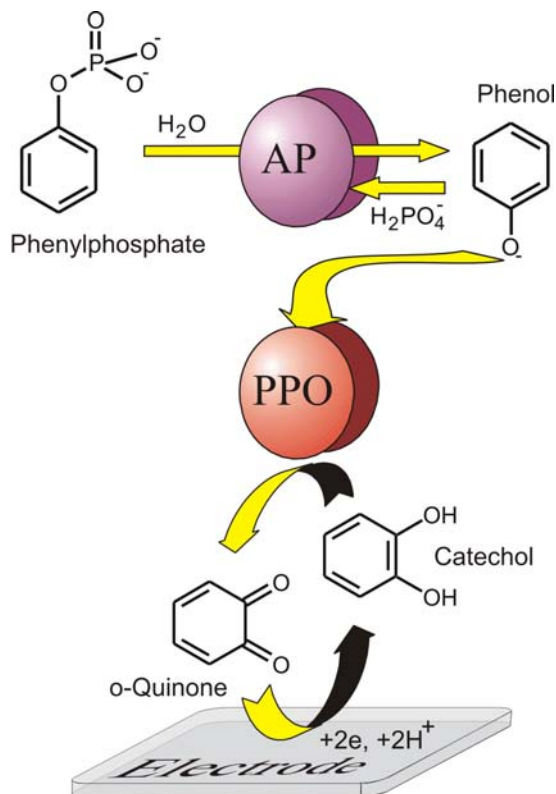

Figure 9-6: Alkaline Phosphatase (AP) / Poly phenol oxidase (PPO) promoted detection of phosphate through the electroreduction of orthoquinone [54,55].

More recent studies have focused on the use of nucleoside phosphorylase (NP) / xanthine oxidase (XOD) bioenzyme combination as shown in **Figure 9-7A**. Nucleoside phosphorylase functions only in the presence of orthophosphate, producing xanthine from inosine, which is in turn oxidised to uric acid by XOD. A number of detection strategies can be employed with this assembly. The level of phosphate can be related to the decrease in concentration of oxygen [55-57], the increase in uric acid production [58-60], or the increase in H_2O_2 concentration [56, 60-63]. In general, the limits of detection afforded by this method are greater (ppb, sub micromolar) than those with the AP, AP /

GOX, or POD enzymes. The ability to exploit the uric acid signal is of considerable significance and provides an important operational advantage. Urate is endogenous to physiological systems and hence would prove to be a substantial interferent in actual analysis of clinical samples [12]. In the context of environmental analysis – few samples would be expected to contain the purine and hence the direct oxidation of the base at the electrode can be assumed to be derived solely from the enzymatic sensor assembly. The advantage of exploiting this label rather than peroxide lies in the relatively low oxidation potential of the purine ($\sim +0.2$ to $+0.5V$). The oxidation of peroxide tends to be characterised by the poor electrode kinetics at conventional electrode substrates and large overpotentials ($\sim +0.8$ to $+1V$ vs $Ag/AgCl$) are often needed to extract a quantifiable signal [12].

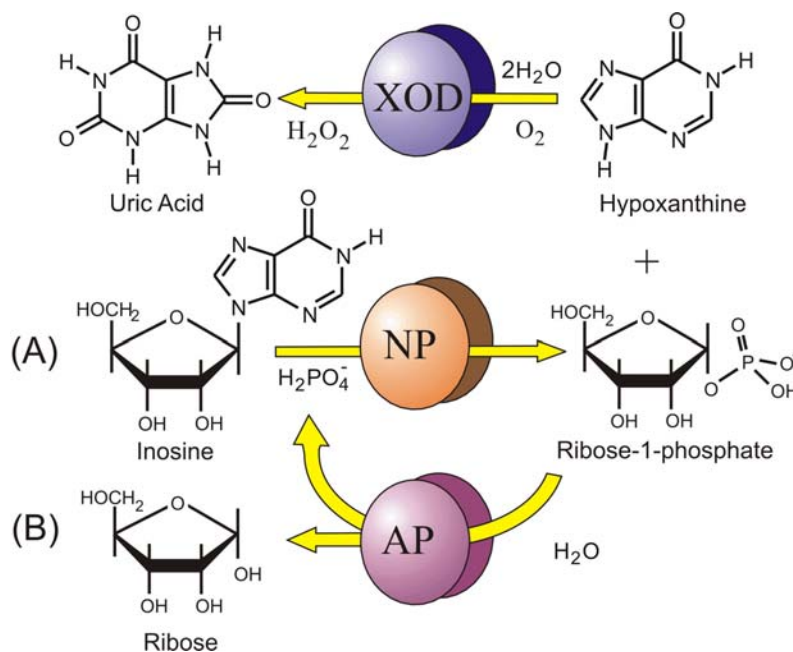

Figure 9-7: A) Synergistic interaction of Nucleoside Phosphorylase (NP) / Xanthine Oxidase (XOD) for the detection of orthophosphate [56-63] B) Catalytic recycling of phosphate through the addition of Alkaline Phosphatase (AP) to enable signal amplification [60,64].

The system can be further refined and lower limits of detection achieved however through employing substrate recycling. In previous catalytic protocols – sample orthophosphate was implicated in the mediation of the AP enzyme activity and the hydrolysed orthophosphate was not considered in any great detail beyond contributing to

the sustained enzymic inhibition. The hydrolysed alcoholic ester was the chief reagent upon which re-cycling was targeted. In contrast, the NP system, **Figure 9-7B**, focuses on recycling the hydrolysed orthophosphate through the addition of AP to the native NP / XOD system [60, 64]. Thus, phosphate itself is recycled to act as a substrate again, and in an excess of inosine, for every phosphate molecule, a number of hypoxanthine molecules are produced to go into the xanthine oxidase catalysed reaction. This leads to amplification of the response to phosphate to provide a limit of detection in the sub ppb (nanomolar) range. The analytical signal arising from the NP system is directly proportional to the concentration of phosphate present and a increasing (positive) signal is always preferable to a decrease which could be attributed to factors other than the increase in phosphate (ie heavy metal ions).

Another phosphate recycling protocol investigated involved a combination of maltose phosphorylase (MP) / mutarotase (MR) / AP / GOX enzymes biosensor configuration [65-67] and is shown in **Figure 9-8**. In an excess of maltose, the introduction of phosphate activated MP which cleaves the disaccharide whilst also phosphorylating one of the glucose moieties. As maltose is linked through an α 1-4 linkage, the unphosphorylated glucose anomer will be in the alpha form. Mutarotase is added to convert between alpha and beta form as only the latter is an acceptable substrate for GOX. The inclusion of AP enables the release of a further glucose molecule but also effectively recycles the orthophosphate and effectively sustains MP activity. A catalytic cycle emerges

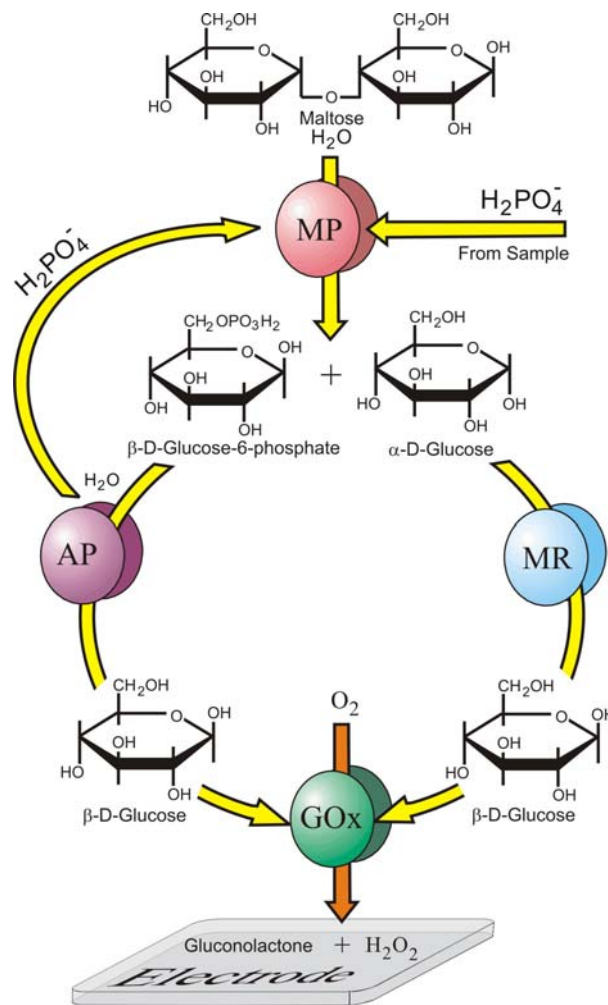

Figure 9-8 . Maltose phosphorylase (MP) / Mutarotase (MR) / Glucose Oxidase (GOX) / Alkaline Phosphatase (AP) catalytic cycle for the trace detection

that, although complex has proven to be very effective for low level phosphate detection resulting in a limit of detection in the ppb (10^{-8} M) range which is sufficient to probe endogenous phosphate concentrations within inland riverways.

9.5. Future Directions and Proposed Methodology

The basic mechanistic implications of incorporating biological catalysts within an electroanalytical framework targeted at phosphate detection have been highlighted. A summary of the various approaches that have been taken in recent years to facilitate the detection of phosphate is provided in **Table 9-1** and compares and contrasts the different electrochemical assemblies with spectroscopic methods. It is clear that conventional direct electrochemical procedures are unlikely to reach the concentrations necessary for onsite testing. It must be acknowledged however that most of the laboratory based systems themselves can only achieve the sub ppm detection limits through employing sample separation techniques such as IC [68-70], FIA [71-73] or electrophoresis [74-76]. None of these approaches are readily transferable to field testing nor for operation by inexperienced staff. While it could be argued that it is only necessary to identify gross abuses and that simpler technologies could be adopted, it is nevertheless important to provide nutrient profiles such that trends in the biogeochemical balance, and not just anthropogenic inputs, for a particular area can be established. This would require reaching the low ppb limits found within water untainted by agricultural, domestic or industrial discharge. The amplification routes available to the biological systems could comfortably operate within these trace detection limits and are comparable to the more sensitive fluorescent techniques [77-79] whilst possessing a more inherent capability for field implementation. Phosphate enzyme systems are widely exploited in biomedical research and it should be possible to transfer the technology to environmental contexts with relative ease.

Methodology	Reagents	LOD / μM	Ref
FIA-P	Cobalt Electrode	100	19
ISE	Molybdate Complex	0.06	26
Amperometric	Molybdate Complex	0.3	36
Amperometric	POD / O ₂	1	41
Amperometric	POD/ H ₂ O ₂	3.6	42
Amperometric	NP, XOD, AP	0.01	64
Amperometric	MP, MR, GOX, AP	0.01	65-67
Ion Chromatography	N / A	0.069	68-73
Capillary Electrophoresis	N / A	0.0051	74-76
Luminescent Plate	Europium–tetracycline	3	77
Fluorescent Probe	NP, XOD, HRP	0.05	78
Fluorescent PVC Matrix	Al-Morin Ionophore	0.2	79

NP: Nucleoside Phosphorylase; XOD: Xanthine Oxidase; HRP: Horseradish Peroxidase; POD: Pyruvate Oxidase; MP: Maltose phosphorylase; MR: Mutarotase; GOD: Glucose Oxidase; AP: Alkaline Phosphatase; FIA-P: Flow injection potentiometric analysis; ISE: Ion selective electrode; N/S: Not Specified.

Table 9-1: Analytical Characteristics of Common Phosphate Detection Methodologies

The matrices are, from an electrochemical sensing viewpoint, simpler as they possess fewer sources of electroactive interference. The multi-enzyme assemblies are however complex and beyond simple *ad hoc* fabrication using conventional electrode geometries and materials. The adoption of the filter framework explored in chapter 8 however could offer a much more accessible option – whether for simple or multiple enzyme systems as it would simply require the deposition of the enzymes or mixture of enzymes within the filter in the same way as done for the xanthine oxidase. There are no complex or sequential immobilisation strategies which would unduly compromise the enzyme activity. The work presented herein has sought to explore the possibility of transferring the technology piloted in Chapter 8 but using pyruvate oxidase (**Figure 9-1**) instead of xanthine oxidase. The former is slightly more complex than the latter as it

requires additional co-factors for its operation. The main aims of the investigation were to assess the transferability of the entrapment process and the generic applicability of the detection strategy.

9.6. Sample Preparation and Experimental Details

All reagents were of the highest grade available and were used without further purification. A solution of 0.1M citrate buffer (pH 6.5) containing 70 μ M thiamine diphosphate (TPP), 10 μ M flavin adenine dinucleotide (FAD), 3 mM MgCl_2 and 1mM pyruvate was used as a electrolyte. A solution containing 10 mM of Na_2HPO_4 in distilled water was used as a standard solution for the detection of inorganic phosphate. Electrochemistry was conducted with a μ Autolab computer controlled potentiostat. A three electrode configuration was used throughout, the filter biosensor acting as a working electrode, Ag/AgCl (3M KCl) as reference electrode and Pt wire as a counter electrode. Anaerobic conditions were achieved by supplying a constant flow of oxygen free nitrogen through and over the solution. A CO_2 laser (Cad Cam Technologies) was used for the construction of the filter sandwich sensor.

9.6.1. Electrode Construction

The construction of the electrode was similar to that previously reported in Chapter 8, however, in this case xanthine oxidase was replaced by pyruvate oxidase. As it will be shown in the following sections, different conformations have been studied due to the complexity of the enzyme mechanism and the design previously used for the determination of xanthine has been modified and discussed more fully in the next section.

9.7. Results and Discussion

The first approach was very similar to the one presented in Chapter 8, where the mediator and the enzyme were both entrapped within the filter paper. Unfortunately, no response to phosphate (2 mM) was observed with this design. It was initially thought that the amount of the enzyme incorporated within the sensor was insufficient such that

substrate turnover is too low. In order to try and counter this deficiency, the amount of pyruvate oxidase was doubled from 0.5 unit to 1 unit but again no response was obtained. Dang and co-workers in contrast have reported a reagentless polymer-modified electrode for pyruvate oxidase recycling based on ferrocenyl methanol [80]. In principle, this should be analogous to the approach taken here but as some of their measurements were done by using large amounts of the mediator the amount of mediator entrapped within the filter matrix was doubled (12 μ L, 25 mM drop cast on to the filter). However the system still failed to respond.

The majority of reports found in the literature are based on the measurement of oxygen consumed instead of monitoring the production of hydrogen peroxide [81-83]. However, the disadvantages of using such have already been discussed in Chapter 8 and it is, in principle, better to use a mediated system – providing of course such a system works. Where ferrocene derivatives have been used as mediators – the measurements were done under rigorously controlled anaerobic conditions in which the ferrocene was at relatively high concentration within the analysis solution. [80]. These requirements can be attributed to competition between the mediator and oxygen to act as the electron acceptor and it would appear that the latter is more efficient than the ferrocene. Repeating the measurement under anaerobic conditions did not yield any improvement in the response towards the phosphate. It was decided that the mediator should be added to the solution and the previous experiments repeated under anaerobic conditions. In this case the filter paper was only loaded with the enzyme and no mediator was added to it. Given the difficulties associated with the design prototyping and the expense associated with ferrocenyl methanol, Ferrocene was used instead for the optimization of the conditions.

After a number of attempts it was found that the introduction of the mediator directly into the analysis solution improved, the sensor response such that a signal could be obtained to additions of phosphate. Cyclic voltammograms detailing the response of the entrapped pyruvate oxidase towards phosphate in the presence of the ferrocene mediator (0.5mM) are shown in **Figure 9-9**.

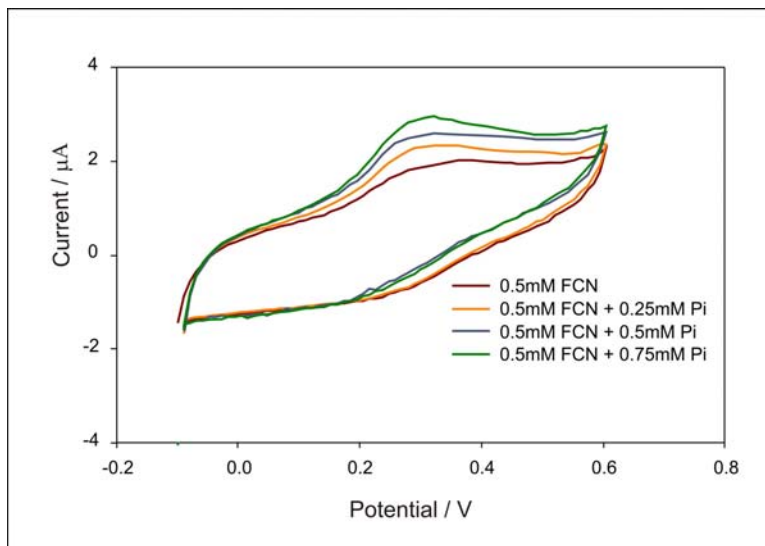

Figure 9-9: Cyclic voltammogram detailing the response of the enzyme biosensor in a solution containing 0.5mM of ferrocene under anaerobic conditions .Scan rate 50mV/ s

The sensor can be seen to increase linearly to increasing additions of phosphate but the sensitivity is very low and the concentrations of phosphate used for the investigation are unlikely to be found in environmental contexts. It was obvious that the introduction of the mediator into the solution rather than having it drop cast into the filter positively affected the response of the sensor. It was unclear if the drop casting of the mediator somehow damaged the enzyme such that it would not respond to the phosphate. It was found in the case of the xanthine oxidase (chapter 8) that the introduction of the mediator on top of the enzyme had a protective influence on enzyme activity given that completing the fabrication involved coating the external surfaces of the filter with a polycarbonate-carbon mesh that had been dissolved in dichloromethane. In this case however there was a suspicion that the deposition of the mediator was the primary cause of the poor response.

In order to assess this possibility – the filter sensor was loaded with enzyme and mediator but the latter was additionally added to the test solution. Cyclic voltammograms detailing the response of the resulting sensor to phosphate are shown in **Figure 9.10**

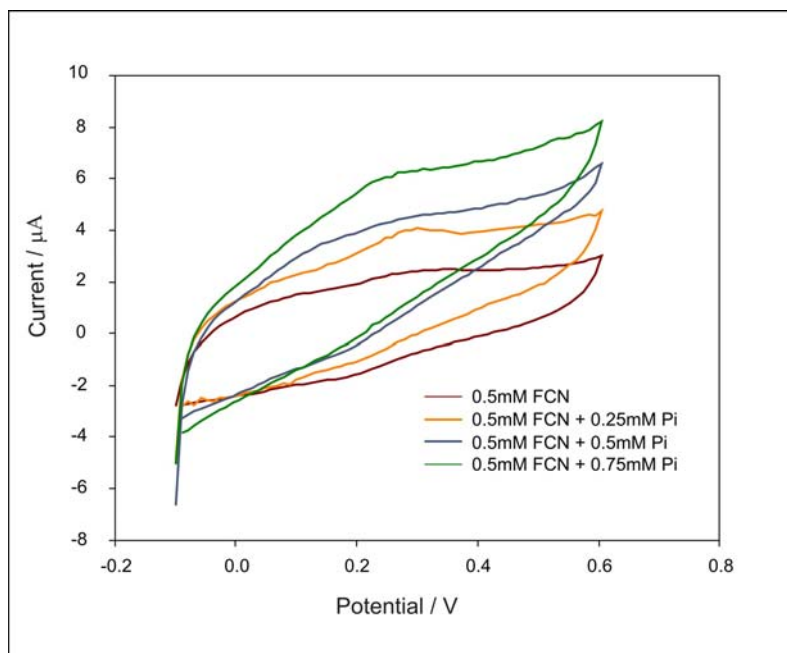

Figure 9-10: Cyclic voltammograms obtained with the filter sensor, when ferrocene was present in both the solution and immobilized in the sensor. Scan rate 50mV/s

The increment in the current with additions of phosphate was higher than when the mediator was only present in the solution, marginally improving the sensitivity of the sensor however the response was slightly erratic and not quite as linear as that previously found when the mediator was only present in solution. It would appear that the deposition of the mediator through drop casting from methanol and its subsequent evaporation did not lead to the degradation of the enzyme itself.

The process was repeated but using the ferrocenyl methanol, which was originally the mediator of choice. This was incorporated within the filter. Once the biosensor was constructed, cyclic voltammetry was used to assess the response in the absence of any co-factors, phosphate or solution based mediator. These are shown in **Figure 9-11** and an increase in the current of both anodic and cathodic peak with the increase of the scan number was observed. This was attributed to the desorption of the mediator from the electrode or from the filter framework into the solution / filter voids.

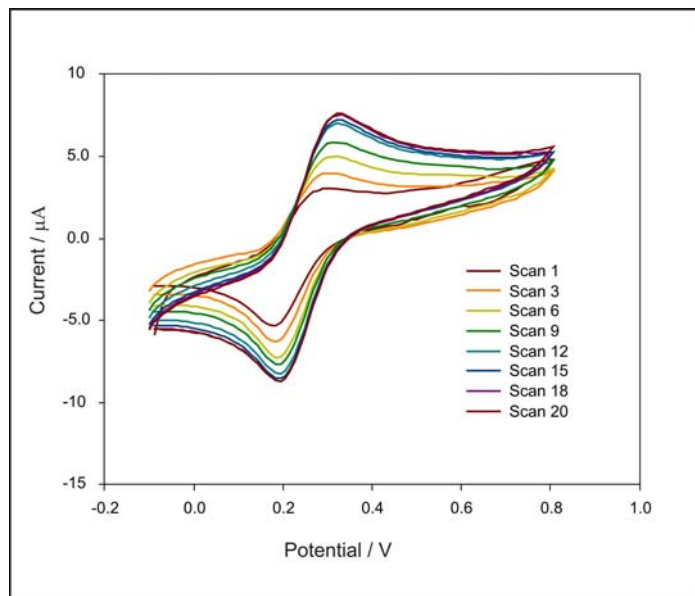

Figure 9-11: Successive cyclic voltammograms of the filter biosensor in 0.1M Citrate buffer pH=6. Scan rate 0.1V /s

The contrast in behaviour between the xanthine oxidase system and the pyruvate enzyme is marked but there could be a number of possibilities for the poor response of the latter. It has already been established and supported in the literature that the enzyme will preferentially interact with oxygen rather than the artificial electron acceptor. The measurements in the present investigation were obtained by placing the filter sensor into a solution containing electrolyte. This solution can be rigorously degassed but there is an inherent flaw. The introduction of the degassed solution into the filter network requires the displacement of air. Given that oxygen will be prominent in the encapsulated air contained within the voids, it means there is liable to be a residual supply throughout the analytical process which apparently is able to out compete the adsorbed mediator. This is made worse by the slow release of the adsorbed mediator into solution (**Figure 9-11**) and hence the concentration of the latter is never likely to reach the levels required compete with the oxygen and thereby produce a sensitive response.

It could be envisaged that this problem could be countered by continued/prolonged degassing but this would make the analysis time incredibly long in order to ensure complete removal of the trapped oxygen. This can be alleviated to some extent by swamping the system with a large amount of mediator (**Figures 9-9 and 9-10**) whereby

the increased concentration can then out run the remnants of dissolved oxygen that remain. Such an approach is contrary to the overall aim of providing a reagentless sensor. The superior performance of the xanthine oxidase system can be attributed to the faster kinetics associated with the artificial mediator than the natural acceptor such that even in the presence of small concentration of mediator and under ambient oxygen levels – a mediated response is still achievable. It would appear that there are three possible solutions to the problem of developing the filter based phosphate sensor:

- utilise the natural oxygen acceptor and optimise the polycarbonate-carbon electrode to detect either oxygen or peroxide;
- select another mediator with superior electron transfer kinetics than the ferrocene derivatives assessed or
- change the enzyme.

As regards the latter, nucleoside phosphorylase in combination with xanthine oxidase (**Figure 9-7**) may be a more viable replacement that would be worthy of consideration given the proven performance of the xanthine enzyme investigated in Chapter 8. The only disadvantage is the additional complexity and expense associated with a two enzyme cascade. The competition from oxygen is the most severe test in this case as the deployment of the sensor within a field setting is unlikely to enable the degassing of the solution and sensor prior to analysis. One worthy point is that the filter design is generic and easily adaptable such that replacing either mediator or enzyme is relatively simple. Moreover – changing the composition to include catalytic particles which could enhance the response to either oxygen or peroxide could also be achieved with ease as shown in Chapter 6 with the inclusion of ferrocene within the polymer matrix. These factors are however beyond the scope of the present investigation but could certainly form the basis of follow-up studies.

9.8. Conclusions

The determination of inorganic phosphate is especially important in the environmental field as well as from a medical point of view. The contamination of water due to the eutrophication caused by high levels of phosphate is well known. This increment in aquatic phosphate content can cause an excess in the intake in food products and illustrates the need for sensing strategies that can work in a variety of different matrices. While many different methods have been reported for the determination of phosphate all have limitations. These were identified and an alternative strategy proposed that would build upon the composite technologies developed thus far. It was anticipated that the translation of pyruvate oxidase to the filter mesh sensor could be easily achieved despite the slightly more elaborate requirement for co-factors. The replacement of one enzyme for another is possible but it is obvious that the process must take into account the individual nature of the enzymes being integrated.

Pyruvate oxidase appears simple but its preference for oxygen ran counter to the detection strategy being pursued. While this could be overcome, the resulting protocol would not offer any advantages over current procedures. The investigation was not however a failure as it was still possible to prove that enzyme entrapment within the filter is still a very viable process and that process appears to be independent of the enzyme. The ability to manipulate the composition of the polymer-carbon mesh with a catalytic species sensitive to oxygen reduction or peroxide oxidation is likely to be the way forward for the sensor development. The work provided here has identified the limitations but has also shown how they could be overcome. Optimisation of the detection strategy and electrode response is the issue that needs to be addressed.

9.9. References

1. vanLoon GW, Duffy SJ (2000) Environmental Chemistry Oxford: Oxford University Press
2. Williams I (2001) Environmental Chemistry New York: Wiley
3. Jarvie H P, Neal C, Withers P J A, Robinson A, Salter N (2003) Hydrol Earth Syst Sci, 7 722-743
4. Uncles R J, Frickers P E, Harris C (2003) Sci Total Environ, 314 727-736
5. Stalnacke P, Vandsemb S M, Vassiljev A, Grimvall A, Jolankal G (2004) Water Sci Technol, 49 29-36
6. Gachter R, Steingruber S M, Reinhardt M, Wehrli B (2004) Aquat Sci, 66 117-122
7. Langlois J L, Mehuys G R (2003) J Environ Qual, 32 2301-2310
8. Krogerus K, Ekholm P (2003) Hydrobiology, 492 15-28
9. Pant H K, Reddy K R (2003) Water Res, 37 965-972
10. Arheimer B, Liden R (2009) J Hydrol, 227 140-159
11. Balls P W, Macdonald A, Pugh K, Edwards A C (1995) Environ Pollut, 90 311-321
12. Lawrence N S, Beckett E L, Davis J, Compton R G (2002) Analytical Biochemistry, 303 p 1
13. Honeychurch K C, Hart J P, Cowell D C, Arrigan D W M (2001) Sensors and Actuators, B 77 642-652
14. Engblom S O (1998) Biosensors & Bioelectronics, 13 981-994
15. Zen J M, Kumar A S, Tsai D M (2003) Electroanalysis, 15 1073-1087
16. Antonisse M M G, Reinhoudt D N (1999) Electroanalysis, 11 1035-1048
17. Grabner E W, Vermes I, Konig K H (1986) J Electroanal Chem, 214 135-140
18. Vermes I, Grabner E W (1990) Journal of Electroanalytical Chemistry, 284 (1990): 315-321
19. Parra A, Ramon M, Alonso J, Lemos S G, Vieira E C, Nogueira A R A (2005) J Agricultural and Food Chemistry, 53 7644-7648
20. Meruva R K, Meyerhoff M E (1996) Anal Chem, 68 2022-2026
21. Chen Z L, Demarco R, Alexander P W (1997) Anal Comm, 34 93-95
22. Glazier S A, Arnold M A (1988) Anal Chem, 60 2540-2542
23. Glazier S A, Arnold M A (1991) Anal Chem, 63 754-759
24. Demeulenaere R L, Onsrud P, Arnold M A (1993) Electroanalysis, 5 833-838
25. Chaniotakis N A, Jurkschat K, Ruhlemann A (1993) Anal Chim Acta, 282 345-352
26. Ganjali M R, Norouzi P, Ghomi M, Salavati-Niasari M (2006) Anal Chim Acta, 567 196-201
27. Hara H, Kusu S (1992) Anal Chim Acta, 261 411-417
28. Davey D E, Mulcahy D E, O'Connell GR (1990) Talanta, 37 683-687
29. Pietrogrande A, Zancato M (1988) Talanta, 35 664-666
30. Sorokina N V, Urusov Y I, Petrukhin O M (1995) J Anal Chem, 50 236-238
31. Fogg A G, Bsebsu N K (1981) Analyst, 106 1288-1295

32. Fogg A G, Bsebsu N K, Birch B J (1981) *Talanta*, 28 473-476
33. Fogg A G, Cripps G C, Birch B J (1983) *Analyst*, 108 1485-1489
34. Fogg A G, Bsebsu N K (1984) *Analyst*, 109 19-21
35. Fogg A G, Scullion S P, Edmonds T E, Birch B J (1990) *Analyst*, 115 1277-1281
36. Calvo Quintana J, Idrissi L, Palleschi G, Albertano P, Amine A, Raíz M, Moscone D (2004) *Talanta*, 63 567-574
37. Matsunaga K, Kudo I, Yanada M, Hasebe K (1985 *Anal Chim Acta*, 185 355-358
38. Chalk S J, Tyson J F (1994) *Talanta*, 41 1797-1805
39. Nikiforova T G, Russkikh Y V, (1995) *J Anal Chem*, 50 286-289
40. Rojas M T, Koniger R, Stoddart J F, Kaifer A E (1995) *J Am Chem Soc*, 117 336-343
41. Akyilmaz E, Yorganci E (2007) *Electrochimica Acta*, 52 7972-7977
42. Kwan R C H, Leung H F, Hon P Y T, Bradford J, Renneberg R (2005) *App Microbiol Biotech*, 66 377-383
43. Mak W C, Chan C Y, Barford J, Renneberg R (2003) *Biosensors and Bioelectronics*, 19 233-237
44. Gajovic N, Habermuller K, Warsinke A, Schuhmann W, Scheller F W (1999) *Electroanalysis*, 11 1377-1383
45. Warsinke A, Benkert A, Scheller F W (2002) *Fres J Anal Chem*, 366 622-634
46. Bagel O, Limoges B, Schöllhorn B, Degrand Cl (1997) *Anal Chem*, 69 4688-4694
47. Duan C, Meyerhoff M E (1994) *Anal Chem*, 66 1369 – 1377
48. Katsu T, Kayamoto T (1992) *Anal Chim, Acta* 265 1-4
49. Schubert F, Renneberg R, Scheller F W, Kirstein L (1984) *Anal Chem* ,56 1677-1682
50. Campanella L, Cordatore M, Mazzei F, Tomassetti M, Volpe G P (1992) *Food Chemistry*, 44 291-297
51. Campanella L, Cordatore M, Mazzei F, Tomassetti M (1990) *Journal of Pharm Biomed Anal*, 8 711-716
52. Su Y S, Mascini M (1995) *Anal Letts*, 28 1359-1378
53. Ciana L D, Bernacca G, Bordin F, Fenu S, Garetto F (1995) *J Electroanal Chem*, 38 129-135
54. Cosnier S, Gondran C, Watelet J C, De Giovanni W, Furriel R P M, Leone F A (1998) *Anal Chem* ,70 3952-3956
55. Watanabe E, Endo H, Toyama K (1988) *Biosensors*, 3 297-306
56. Haemmerli S D, Suleiman A A, Guilbault G G (1990) *Anal Biochem*. 191 106-109
57. Wollenberger U, Schubert F, Scheller F W (1992) *Sensors and Actuators B-Chemical*, 7 412-415
58. Yao T, Wasa T (1993) *Electroanalysis*, 5 887-890
59. Yao T, Kobayashi N, Wasa T (1990) *Anal Chim Acta*, 238 339-343
60. Male K B, Luong J H T (1991) *Biosensors & Bioelectronics*, 6 581-587
61. Durso E M, Coulet P R (1990) *Anal Chim Acta*, 239 1-5
62. Yao T, Satomura M, Nakahara T (1994) *Talanta*, 41 2113-2119

-
63. Durso E M, Coulet P R (1993) *Anal Chim Acta*, 281 535-542
 64. Wollenberger U, Neumann B, Riedel K, Scheller F W (1994) *Fres J Anal Chem*, 34 563-566
 65. Huwel S, Haalck L, Conrath N, Spener F (1997) *EnzMicrob Tech*, 21 413-420
 66. Conrath N, Grundig B, Huwel S, Cammann K (1995) *Anal Chim Acta*, 309 47-52
 67. Mousty C, Cosnier S, Shan D, Mu SL (2001) *Anal Chim Acta*, 443 1-8
 68. Antony P J, Karthikeyan S, Iyer C S P (2002) *J Chromatogr, B* 767 363-368
 69. Yang L, Sturgeon R E, Lam J W H (2001) *J Anal At Spectrom*, 16 1302-1306
 70. Ruiz-Calero V, Puignou L, Diez M, Galceran M T (2001) *Analyst*, 126 169-174
 71. Fernandes R N, Reis B F (2002) *Talanta*, 58 729-737
 72. Grudpan K, Ampan P, Udnan Y, Jayasvati S, Lapanantnoppakhun S, Jakmune J, Christian G D, Ruzicka J (2002) *Talanta*, 58 1319-1326
 73. Li Y S, Muo Y, Xie H M (2002) *Anal Chim Acta*, 455 315-325
 74. Ahumada I, Mendoza J, Escudero P, Mossert K, Ascar L (2001) *J AOAC Int* 84 1057-1064
 75. Izco J M, Tormo M, Harris A, Tong P S, Jimenez-Flores R (2003) *J Dairy Sci*, 86 86-95
 76. Nakashima Y, Goto T, Kitazumi I Himeno S (2001) *Electrophoresis*, 22 337-3381
 77. Duerkop A, Matejka T, Lobnik A, Wolfbeis O S (2006) *Anal Chim Acta*, 555 292-298
 78. Vasquez M J, Rodríguez B, Zapatero C, Tew D G (2003) *Biochem*, 320 292-298
 79. Lin X C, Wu X P, Xie Z H, Wong K Y (2006) *Talanta*, 70 32-36
 80. Dang LA Haccoun J Piro B Pham MC (2005) *Eleetrochinica Acta*, 51 3934-3943
 81. Ganjali M R, Norouzi P, Ghomi M, Salvati-Niasari M (2006) *Analytica Chimica Acta*, 567 196-201.
 82. Mak W C, Chan C, Barford J, Renneberg R (2003) *Biosensors and Bioelectronics*, 19 233-237.
 83. Akyilmaz E, Yorganci E (2007) *Electrochimica Acta*, 52 79727977.
 84. Fletcher S, Horne M D (1999) *Electrochemistry Communications*, 1 502-512.

10.1. Conclusions and Future Work

Electrochemical techniques are a versatile analytical tool which are in constant development. The expansive breadth of electroanalytical science is provided mainly by three factors. Two are integral to the electrode itself and encompass the possibility of the electrode modification and the diversity of detection methodologies that can be applied. The third component revolves around the modification of the analyte prior to its analysis. All three approaches have been investigated in this thesis and the versatility of electrochemistry as a viable analytical technique has been highlighted.

Chapter 3, the start of the experimental work, demonstrated how the electrode parameters can be manipulated and the surface modified to enhance the determination of nitrate. This is a very pertinent example as it is generally unreactive but can, through the application of an innovative detection sequence and or the addition of catalytic copper, be “encouraged” to produce a quantifiable signal. This work resulted in two electrode systems being investigated. The first design can be applied for field systems and the second can be coupled in a flow system for laboratory analysis.

Chapter 4 deals with a similar problem to that found in Chapter 3 with an electrochemically “difficult” target. However, in this case the target was modified prior to electrochemical analysis to improve its visibility to the electrode. Quinones were used as a label because they offer the possibility to incorporate an electroactive as well as a chromophore centre, which can be used for the detection of the analyte using both spectrometric and electrochemical methods. The approach was applied to the determination of sulphur derivatives in river samples. These two chapters epitomise conventional approaches to the detection of analytes – whether unreactive or those present within a complex matrix. The usual solution is to modify either the electrode surface or the target. These procedures can vary tremendously in terms of complexity and thus their adoption and real world applicability is often limited. It was clear that a more accessible means of electrode modification was required and this was the direction taken for the remainder of the thesis.

A new direction was established by investigating the construction of a polymer-carbon composite electrode that could be used as the basis of sensing strategy that could not only prove to be easily accessible but which would be sufficiently flexible for use over a range of differing analytical contexts. Chapter 5 examined the development of the basic composite and its modification through the use of a simple laser treatment, which enhanced the performance of the sensor by fracturing the surface - increasing the electrode area and generating active groups such as quinoid and hydroxyl groups. The resulting films were applied to the detection and quantification of 5-hydroxyindoleacetic acid, an important neurotransmitter that could ultimately find application as means of assessing suicide risk. In order to validate the performance of the sensor the latter was coupled with an HPLC and the results obtained with the electrochemical sensor were found to be superior to the spectrometric detector confirming the analytical viability of the proposed route.

The strategy was progressively developed and tested. Chapter 6 took the basic composite recipe and sought to explore the incorporation of a catalytic material through simple mixing. Ferrocene is an electroreversible compound that has been widely used in electrochemical methods and used in a large variety of electroanalytical applications. In the present work, the encapsulated ferrocene was used to catalyse the oxidation of ascorbic acid. The resulting sensor was found to allow the determination of the target in the presence of uric acid and was subsequently tested in a variety of real samples - pharmaceutical preparations, infusions, soft drinks but also in more complex systems such as saliva. Again the sensor was integrated in a flow system and highlights its adaptability for incorporation with conventional probe systems, disposable strips or continuous monitoring or analysis. Further modifications were then introduced where a biocatalyst was used in the sensing scheme. Biosensors are a simple and fast alternative to more complex and tedious methods such as chromatographic or colorimetric methods that were briefly investigated in Chapter 4. The selectivity is achieved by the high affinity of the enzyme for the analyte. One of the crucial steps in the development of biosensors is the immobilization of the enzyme. The novelty of the approach taken here lies in the incorporation of the enzyme within an entirely new sensing platform. The enzyme was not so much immobilized but rather entrapped within a polymeric filter matrix. This

creates a scaffold within which the enzyme and associated cofactors/mediators can reside in a fluid filled pore network which mimics that of their natural environment and thereby should result in minimal activity loss. A number of enzymes of increasingly complexity were investigated – glucose, xanthine and pyruvate oxidases. These were encapsulated in the polymer-carbon composite developed in the previous chapters which served to retain the enzyme but also provided a conductive conduit through which to extract the analytical signal. These sensors required some innovative approaches to be developed for their fabrication – involving selective laser treatment of the base filter to yield melt zones that would corral the enzymes. The Durapore filter paper shown to be an excellent platform with the enzyme maintaining an activity close to its native function. Moreover, no chemicals were required for the immobilisation processes and thus the possibility of degrading the enzyme avoided.

Chapter 9 examined the translation of the strategy to pyruvate oxidase. This proved to be a much more complicated species than first envisaged. As an oxidase it was expected that it would behave in an analogous manner to the earlier investigation involving glucose and xanthine oxidases. However the enzyme appeared to be reluctant to respond to the phosphate substrate. There were a number of variables that could affect the response of the sensor such as the optimal ratio of cofactors, the temperature and the pH, oxygen and possible denaturing of the enzyme by the actual fabrication process. The enzyme was subsequently found to be active but acquiring a quantifiable and meaningful signal was the limiting factor. While a workable phosphate sensor was not achieved – it was proven that the sensor filter platform was indeed a generic and viable option for enzyme entrapment irrespective of the nature of the protein or cofactor. The subsequent detection of the enzymatic reaction however is something that would need to be considered in future work.

The electrode modifications investigated have been used in a wide range of applications, from agri-food to environmental to medical and different designs have been developed to incorporate some of these sensors within flow injection systems. The simplicity of these modifications and the capability for mass production is a characteristic of most of the approaches presented here. Portability is an essential property required in

field analysis and it is clear that some of the sensors presented have already demonstrated potential (Chapter 3 and 5) for further development and optimisation.

The present work illustrates the utility of different modifications but they present only a small taste of what could be developed. Further study remains to be performed to evolve the basic designs outlined here to a truly portable sensing system. It would for example be interesting, not to mention clinically valuable, to test the performance of the laser treated sensor with other biological samples such as cerebral spinal fluid to understand the role of 5-hydroxyindoleacetic acid in suicide ideation. The use of the sensor for monitoring animal welfare is also of considerable interest. Chapters 4, 6 and 8 all investigate different aspects of oxidative stress – whether as a general indicator or more specific in the case of xanthine. They were examined in isolation but their integration into a multiparametric sensor could provide a more robust clinical picture of wellbeing – be it a human or animal patient. As a future project the design of a sandwich electrode containing different enzymes could easily be designed as shown in **Figure 10-1**

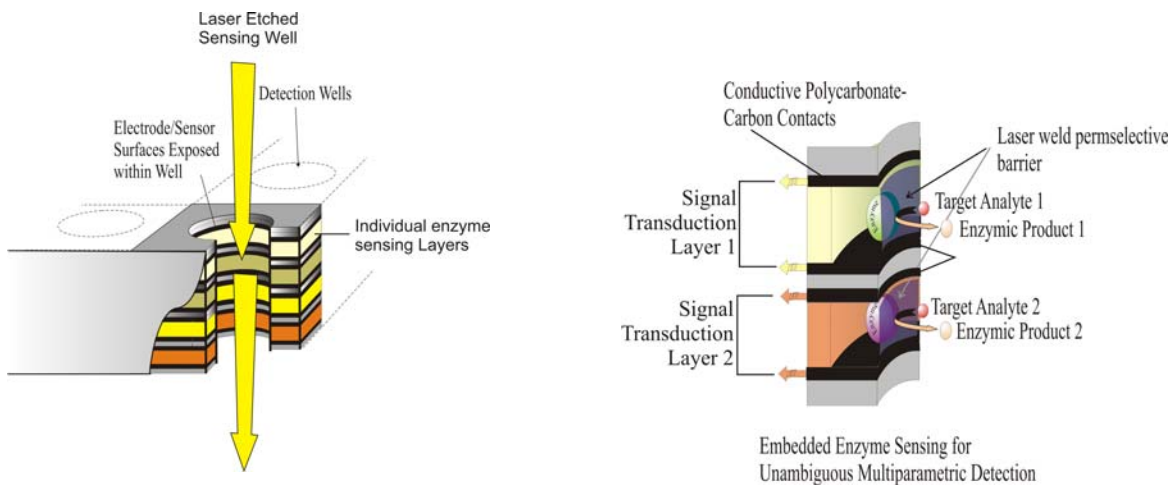

Figure 10-1: Design of the sandwich sensor.

The main advantage of the sensor is the ease with which different enzyme layers can be incorporated into the device simply by building one layer on top of the other to create the multi-parameter sensor. The composite approach advocated here would easily facilitate such a structure. The project has laid the foundations of a new approach, answered many questions relating to sensor construction but, more importantly, it has provided results that ask many more questions that will help to evolve the design process and indicated the avenues that could be explored.

Publications

M.M. Villalba, V. Litchfield, R. Smith, A.M. Franklin, C. Livingstone and J. Davis A chromatographic tool for preparing combinatorial quinone–thiol conjugate libraries, J. Biochem. Biophys. Methods 70 (2007) 797–802.

M.M. Villalba and J. Davis. New directions for carbon-based detectors: exploiting the versatility of carbon substrates in electroanalysis. Journal of Solid State Electrochemistry, 12 (2008) 125-1254

M.M. Villalba V. Litchfield, R. Smith, A.M. Franklin, N.S. Lawrence, and J. Davis. Rapid assessment of the latent hazard posed by dissolved mercaptans within aqueous effluent Journal of Hazardous Materials 154 (2008) 444–450.

K Bown, E. Cowham, M.M Villalba, R. Smith N. Mould, S. Billington and J. Davis . Solvent free essential oil extraction. A simple and rapid approach to microwave Hydrodistillation. Revista de Educación en Ciencias N 2, vol. 9, (2008) 106-108

H.B. Ezekiel, D. Sharp, M.M. Marti and J. Davis. Laser-anodised carbon fibre: Coupled activation and patterning of sensor substrates. Journal of Physics and Chemistry of Solids 69 (2008) 2932–2935.

M. M. Villalba, J. McKeegan, D.H. Vaughan, M.F. Cardosi and J. Davis. Bielectroanalytical determination of environmental phosphate: a review. Journal of Molecular Catalysis B; Enzymatic 59 (2009) 1-8.

L. Lee, M. M. Villalba, R. B. Smith and J. Davis. Epoxide-quinone transformations: Multi-parametric indicators for assessing animal welfare. Electrochemistry communications 11 (2009) 1555-1558

S. Slater, M. M. Villalba and J. Davis. Key neurochemical markers for the prevention of suicide. Trends in Analytical chemistry. Xx (2009)

M. M. Villalba and James Davis Micro-Nano engineered composite- New direction in Biosensing Technologies. Nova Science Publishers, Inc. Book chapter.

R. Desai, M. M. Villalba, S. Lawrence and James Davis. Green approaches to field nitrate analysis: An electrochemical perspective. Electroanalysis 7 (2009) 787-890

Appendix 1

H. Sahni, M. M Villalba, L.A.A. Newton, R. Leslie and J. Davis, Electrochemically modulate film permeability: A functional controlled reagent release, Chemistry Letters Xx (2009)

Conferences

- Rhine Meeting (2009) Hull, UK-Oral presentation and Poster exposition
- Eurovariety in Chemistry Education Conference (2009) Manchester, UK- Attendance.
- 215th ECS Meeting (2009) San Francisco, USA-Oral Presentation
- The tenth world congress on biosensors, Shanghai (2008) China- Poster Presentation
- School Annual Research Conference (2008) Nottingham, UK –Poster Presentation
- Analytical Research Forum, by the RSC (2008) Hull, UK- Poster presentation
- JCF-Fruehjarssymposium (2008), Rostock, Germany-Oral Presentation
- 234 ACS National Meeting & Exposition (2007) Boston, USA- Poster presentation
- 1ST UK-USA Conference on Chemical and Biological Sensors and Detectors, London,(2007) UK- Attendance.