

No. O-139

## Analysis of Electric field and Modeling Design of High Voltage Cable terminators for PD Testing Using SF<sub>6</sub> Insulator

T.Lantharthong<sup>1,2</sup> and S.Nedphograw<sup>1</sup>

<sup>1</sup>Department of Electrical Engineering , Faculty of Engineering  
Rajamangala University of Technology Phra Nakhon (North Bangkok),Thailand.  
Email:Supawudn\_p\_g@hotmail.com.,Sup\_EP37@rmutp.ac.th

S.Hiranvarodom<sup>2</sup> and P.Apiratikul<sup>2</sup>

<sup>2</sup>Department of Electrical Engineering , Faculty of Engineering  
Rajamangala University of Technology Thanyaburi,Thailand.

### Abstract

This paper presents the analysis of electric field by using FEMLAB simulation tool to find the optimal electric field and component designs. Design of Cable terminator is tested by finding PD Value with IEC standard. This paper also proposes the electric stress when we design the cable terminator includes SF<sub>6</sub> insulator. The modeling design is very useful for High Voltage engineers to find the optimal solution of Cable terminator design.

keywords : Insulation, Electric Field Stress,Tesla Transformer

### 1. Introduction

Because of the country has a lot of improvement in distribute the electricity power. Underground Cable is a part of system. The testing to find the Partial Discharge inside the cable so that the stem of the High Voltage Cable XLPE is important for testing analysis. From the several study of the Stem Model which is connect to the High Voltage Cable. The example has model by analyze the High Voltage Electric Field from the calculation. But in this article would lead for analytical for finding Electric Field that happen in the cable so that it would be improve the stem model. From the oil transformer insulation and other insulation substance to be the insulation substance in the past to be the insulation which is using gas SF<sub>6</sub> to be insulation substance in the stem connection to High Voltage Cable that has present in this research.

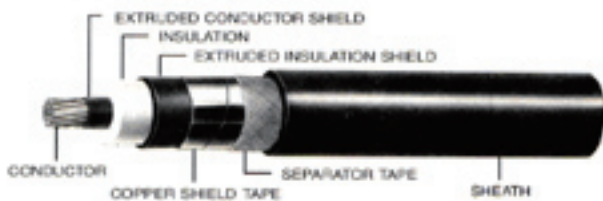

Figure 1: Structure inside the High Voltage Cable

In the consistent of insulation against electric voltage is the highest electric filed stress can endure without damage or lose the insulation state. In general, there could find from the regular electric field

From the first equation 1

$$E_{\max} = \frac{U}{d\eta^*} \quad (1)$$

By  $E_{\max}$  : is highest Electric Field Stress (kV/mm.)

$U$  : is Electric Voltage (kV)

$d$  : is the distance between electrons (mm)

$\eta^*$  : is Electric Field Factor

Electric Field in the high voltage cable,to be use the insulation that has the value  $E_r$  that difference is suite for the irregular electric equation so that it would help the electric field stress in each insulation to have  $E_r$  value differently to be similar. The damage of electric field in the insulation that can count from the 2<sup>nd</sup> Equation

$$E_{r_x} = \frac{\epsilon_1 \epsilon_2 U}{r_x \epsilon_x \left( \epsilon_1 \ln \frac{r_3}{r_2} + \epsilon_2 \ln \frac{r_2}{r_1} \right)} \quad (2)$$

By  $E_{r_x}$  : is the Electric Filed Stress in the insulation  
at  $r_x$  (kV/mm.)

$U$  : is Electric voltage that provide (kV)

$\epsilon_1, \epsilon_2$  : is Permittivity of the insulation 1 and 2  
 $r_1$  : is the radius of the conductor (mm.)  
 $r_2, r_3$  : is the Radius of the insulation 1 and 2

**2. The Calculation of Electric Field Theory**

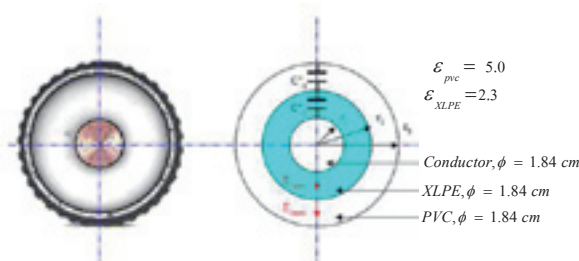

Figure 2: Showing the structure in the period that has the electric field stress in the high voltage cable XLPE

The diameter of the stem cable from figure, can finding the diameter of the stem cable from the 3<sup>rd</sup> equation. By  $r_1$  is the radius of the conductor is worthy 9.2 mm > and  $r_2$  is the radius of the stem so that it would be (High Voltage Engineering Book, Dr. Sumreuy Sungsaard)

$$\begin{aligned} r_2 &= r_1 \times e \\ &= 9.2 \times e \\ &= 25.01 \text{ mm} \end{aligned}$$

Instead the 2<sup>nd</sup> equation

$$\begin{aligned} Er_2 &= \frac{2.3 \times 1 \times 24000}{16 \times 1 \left( 2.3 \ln \left( \frac{25.01}{16} \right) + 1 \ln \left( \frac{16}{9.2} \right) \right)} \\ &= 2.18 \text{ kV/mm} \end{aligned}$$

$$\begin{aligned} Er'_3 &= \frac{2.3 \times 1.00191 \times 24000}{25.01 \times 1 \left( 2.3 \ln \left( \frac{25.01}{16} \right) + 1 \ln \left( \frac{16}{9.2} \right) \right)} \\ &= 1.395 \text{ kV/mm} \end{aligned}$$

Suppose  $r_3 = 50$  mm. Cause of his will create the stem connection which would have a radius equal to 50 mm. so that:

$$\begin{aligned} Er_3 &= \frac{2.3 \times 1 \times 24000}{50 \times 1 \left( 2.3 \ln \left( \frac{50}{16} \right) + 1 \ln \left( \frac{16}{9.2} \right) \right)} \\ &= 348.69 \text{ kV/mm} \end{aligned}$$

From the Electric Field Stress  $Er_2$  and  $Er_3$  will find that can be use in the test without breakdown. This research is chose to use the stem model connect with the clear acrylic to be the insulation material for stem connection, which is durable for

the electric field stress around 35 kV/mm. By using the diameter 60 mm. and 5 mm. thick

**3. Analysis of the Electric Field in the High Voltage Cable**

The length of cable stem, consider from the voltage testing and the peel line system between the conductor and the ground. By the high voltage that uses to test according to the standard IEC 60502-2 is  $2U_0$  equal to 24 kV. For the peel system distance, from the model of electric field stress distribute. It would be the distance of peel system equal 6.5 cm. According to the Figure by consider from contour of electric field between the tip of line system and ground. While consider with the tip of electric line system so that the all distance of a peel line system will equal to 9.5 cm. And when the oil transformer is control the distribution of the electric field in the whole distance at the tip of line system. It would be length at 20 cm.

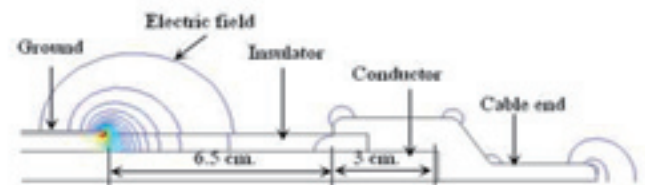

Figure 3: Contour of Electric Field at the tip of cable line

The model of electric distribution of the component. This project has bring the rule of finite element to help in the analysis of electric field stress distribute. By using 2 dimensions of analysis and without thinking the result of left purgative left. Use FEMLAB program which is high voltage in the test that is 24 kV and the value  $E_r$  from the result of electric distribution model from several component of the line system that design according the 3<sup>rd</sup> -4<sup>th</sup> picture

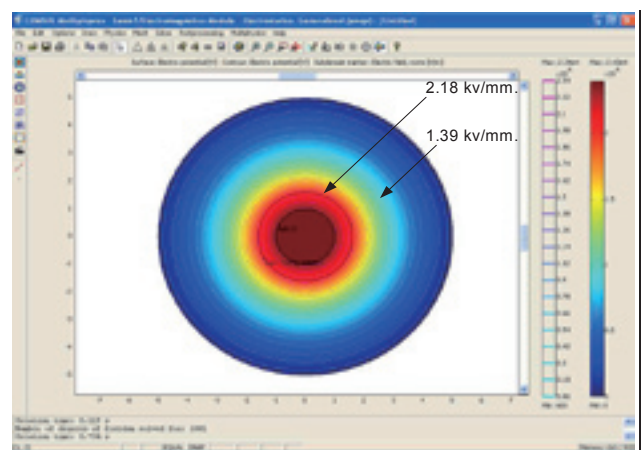

Figure 4: Show Simulations Electric Field Analysis

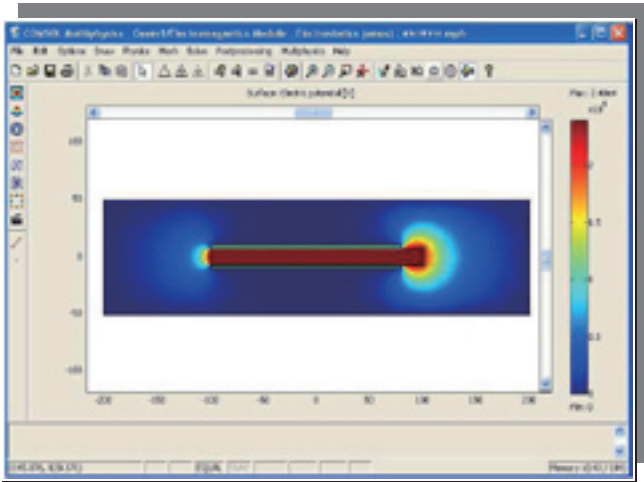

Figure 5: Show Simulations Electric Field Analysis

According to the theory of cylinder overlap axle that suitable. It can calculate the side of cylinder  $r_2 = 25.01$  mm. or the diameter would worthy 50.02 mm. that is very difficulty in establishment. Because the area of cylinder face is less and difficult to insult the gas pressure meter which is space and valve for air pressure and the important thing is cannot seal for gas inside. So that the suitable for the create and comfortable for the model so the design of the high voltage cable stem to be the diameter equal to 100 mm. The main test of the finite element program that model of electric field equal to 100 mm. The result that the value of the electric field would be insider the radius, its show that the cylinder that has 100 mm. diameters can be use

The model of the base support for the high voltage XLPE. A part of base support will have the touching with the high voltage cable stem. It should has a suitable point which would not built up the capacitance at the connection point so that it would be Partial Discharge. If the connection point is not match and the other task would be the cable connection point for testing to connect with the distributor. It's use as the aluminum from the picture 5-8

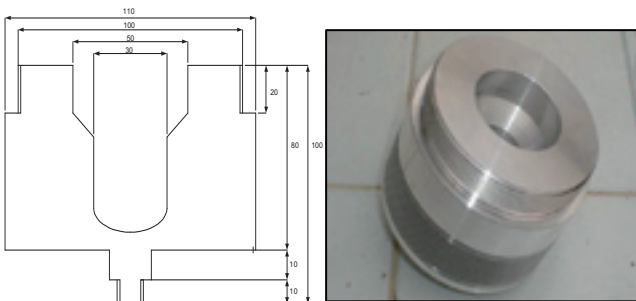

Figure 6: Show the pattern and the base supporter for the high voltage cable terminator

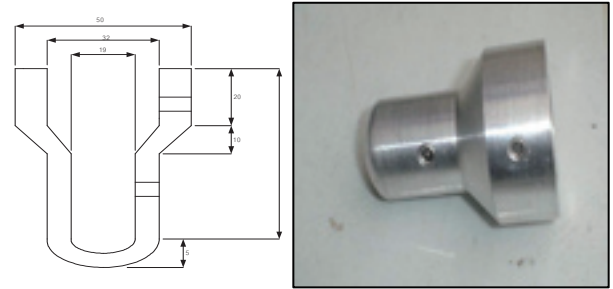

Figure 7: Show the pattern and high voltage cable terminator

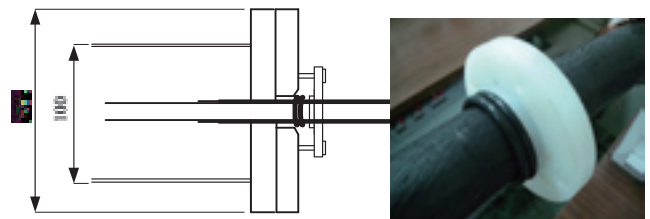

Figure 8: Show the pattern and Sail Gas SF<sub>6</sub> that leak out from the connection cylinder.



Figure 9: Show the pattern and line connection which is using gas SF<sub>6</sub> to be insulation



Figure 10: Show the circle of line connection which is using gas SF<sub>6</sub> to be insulation testing for finding the partial discharge value in the high voltage cable in the side of 24 kV

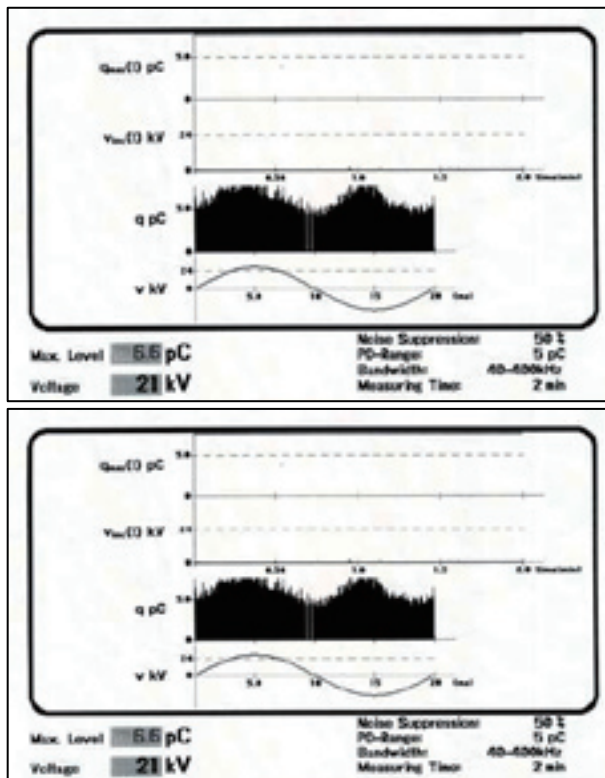

Figure 11: Show the example of the testing in the Partial Discharge Model

#### 4. Summary of the Analysis

From the analysis finding the result of Electric Field Stress which occurs in the cable would make the line connection model in this research is easily done. Including help to know the distance of the cable peel which would mixture with the line system that has design from the analysis of electric field. It is easy to create the high voltage cable connection model for testing partial discharge which is using SF<sub>6</sub> to be insulation. It would be the improvement and innovative of the partial discharge measure that more effective for the future use.

#### 5. References

- [1] Somruey Sangsaard ,High Voltage Engineering Book, Chulalongkorn University, 2549
- [2] Kuffel, E., & Abdullah, M., High-Voltage Engineering, Pergamon Press, 1977
- [3] N.Ahmed,O.Morel, N.Srinivas “Partial discharge measurement in Transmission cable Termination” IEEE Transec. On Dielectric and Electrical Insulation ,Nov.,1993, p.p 14-24
- [4] C. Boonseng, P. Apiratikul and K. Nakaviwat, “ A High Voltage Cables Terminator for Partial Discharge and Dielectric Loess Measurement”, IEEE 2002 International Symposium on Electrical Insulation ISEI’2002, April 7-10 2002, Boston Massachusetts USA, pp62-65.

#### 6. Biographies (Optional)



**Thong Lantharthong** received his B.s.Tech (Electrical Technology) and M.s.Tech (Electrical Technology) degrees from Rajamangala Institute of Technology and King Mongkut’s Institute of Technology North Bangkok (KMIT NB). and M.Eng (Electrical Engineering) student at RMUTT. He has worked as lecturer at the Department of Electrical Power Engineering in RMUTP.,Thailand, His main research interests are applications of highvoltage Technology and highvoltage applications



**Supawud Nedphograw** received his B.Eng. and M.Eng. degrees in Electrical Engineering from Rajamangala University of Technology Thanyaburi (RMUTT.), King Mongkut’s Institute of Technology Ladkrabang (KMITL.) He has worked as lecturer at the Department of Electrical Power Engineering of RMUTT. since June 1998. In November 2006 he worked as lecturer and Head ,Department of Electrical Power Engineering in RMUTP, Thailand. His main research interests are applications of highvoltage Technology, highvoltage applications and Power energy saving.



**Asist.Prof.Dr. Somchai Hiranvarodom** received his B.s.Tech(Electrical Technology) and Ph.D (Electrical Engineering),UNN, Newcastle,England. He has worked as lecturer at the Department of Electrical Power Engineering and Dean, Faculty of Engineering Rajamangala University of Technology Thanyaburi (RMUTT.) Thailand His main research interests are applications of Photovoltaic in Rural area, Solar Energy



**Promsak Apiratikul** received his B.Eng. and M.Eng.degrees in Electrical Engineering from Rajamangala University of Technology Thanyaburi (RMUTT.), King Mongkut’s Institute of Technology Ladkrabang (KMITL.) &D.Eng (Electrical Engineering) Student at Kasetsart University (KU.),Thailand. He has worked as lecturer at the Department of Electrical Power Engineering of RMUTT.Thailand. His main research interests are applications of high voltage Technology , highvoltage applications