



Aalborg Universitet

AALBORG UNIVERSITY
DENMARK

Mission Profile-Oriented Control for Reliability and Lifetime of Photovoltaic Inverters

Sangwongwanich, Ariya; Yang, Yongheng; Sera, Dezso; Blaabjerg, Frede

Published in:

Proceeding of the 2018 International Power Electronics Conference (IPEC-Niigata 2018 - ECCE Asia)

DOI (link to publication from Publisher):

[10.23919/IPEC.2018.8507577](https://doi.org/10.23919/IPEC.2018.8507577)

Publication date:

2018

Document Version

Accepted author manuscript, peer reviewed version

[Link to publication from Aalborg University](#)

Citation for published version (APA):

Sangwongwanich, A., Yang, Y., Sera, D., & Blaabjerg, F. (2018). Mission Profile-Oriented Control for Reliability and Lifetime of Photovoltaic Inverters. In *Proceeding of the 2018 International Power Electronics Conference (IPEC-Niigata 2018 - ECCE Asia)* (pp. 2512-2518). [8507577] IEEE Press.
<https://doi.org/10.23919/IPEC.2018.8507577>

General rights

Copyright and moral rights for the publications made accessible in the public portal are retained by the authors and/or other copyright owners and it is a condition of accessing publications that users recognise and abide by the legal requirements associated with these rights.

- ? Users may download and print one copy of any publication from the public portal for the purpose of private study or research.
- ? You may not further distribute the material or use it for any profit-making activity or commercial gain
- ? You may freely distribute the URL identifying the publication in the public portal ?

Take down policy

If you believe that this document breaches copyright please contact us at vbn@aub.aau.dk providing details, and we will remove access to the work immediately and investigate your claim.

Mission Profile-Oriented Control for Reliability and Lifetime of Photovoltaic Inverters

Ariya Sangwongwanich, Yongheng Yang, Dezso Sera, and Frede Blaabjerg
 Department of Energy Technology, Aalborg University, Aalborg DK-9220, Denmark
 ars@et.aau.dk, yoy@et.aau.dk, des@et.aau.dk, fbl@et.aau.dk

Abstract—With the aim to increase the competitiveness of solar energy, the high reliability of Photovoltaic (PV) inverters is demanded. For PV applications, the inverter reliability and lifetime are strongly affected by the operating condition that is referred to as the mission profile (i.e., solar irradiance and ambient temperature). Since the mission profile of PV systems is location-dependent, the inverter reliability performance and lifetime expectation can vary accordingly. That is, from the reliability perspective, PV inverters with the same design metrics (e.g., component selection) may be over- or under-designed under different mission profiles. This will increase the overall system cost, e.g., initial cost for over-designed cases and maintenance cost for under-designed cases, which should be avoided. This paper thus explores the possibility to adapt the control strategies of PV inverters to the corresponding mission profiles. With this, similar reliability targets (e.g., component lifetime) can be achieved even under different mission profiles. Case studies have been carried out on PV systems installed in Denmark and Arizona, where the lifetime and the energy yield are evaluated. The results reveal that the inverter reliability can be improved by selecting a proper control strategy according to the mission profile.

Index Terms—PV inverters, lifetime, reliability, mission profile, control, power device, capacitor.

I. INTRODUCTION

There is a strong demand to further reduce the cost of PV energy, in order to increase its competitiveness and enable more renewable energy harvesting [1]. For instance, the U.S. Department of Energy has set a target to reduce the cost of PV energy from 0.18 USD/kWh (in 2016) to 0.05 USD/kWh by 2030 (for residential PV systems in the USA) [2]. The similar cost reduction tendency is also expected in other countries globally [3]–[5]. In order to achieve this target, PV systems should be improved in several aspects. Among those, enhancing the reliability and lifetime of PV inverters has high potential for a significant cost reduction [5]. The field experience has shown that the PV inverter failure contributes to a large portion of the unexpected operating and maintenance cost [6]–[8]. This gives a negative impact to the overall cost of energy in addition to the energy production loss during the inverter down-time periods. Thus, avoiding PV inverter replacements during the entire lifespan of PV power plants (e.g., 20 years) is one of the keys to the cost reduction [2].

Accordingly, the reliability engineering approach has recently been more involved in the design phase of PV inverters (in general, power electronic systems) [9]–[12]. This is normally referred to as a Design for Reliability (DfR) approach, as it is illustrated in Fig. 1. Following the DfR approach, the

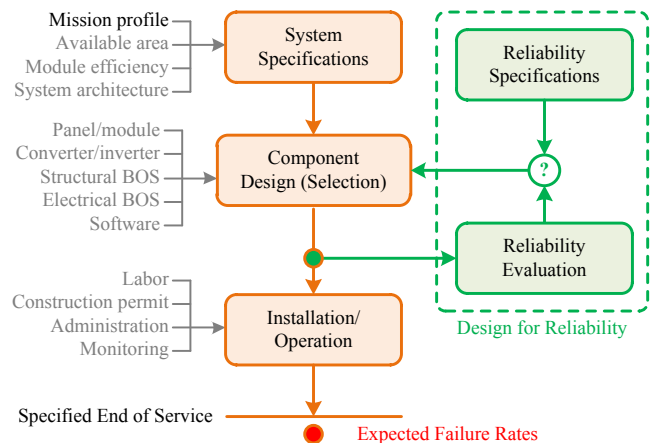

Fig. 1. Flow diagram of the Design for Reliability (DfR) approach applied to the design of power electronics in PV systems (BOS: Balance of System).

reliability specification (e.g., the lifetime target) is defined and it should be fulfilled during the design phase. In that respect, the lifetime prediction tool plays an important role in assessing the reliability of the designed inverter under given operating conditions (e.g., the mission profile of the installation site).

In the prior-art research, it is suggested that the reliability and lifetime of power electronic systems (e.g., PV inverters) are strongly affected by the operating conditions [13]–[18], referred to as mission profiles. Thus, the mission profile is usually required as an input of the DfR process. For PV applications, the solar irradiance and the ambient temperature are normally considered as the components of a mission profile, as they determine the PV power production (i.e., the PV inverter loading). Since the solar irradiance and ambient temperature are location-dependent (due to the climate condition of the installation site), the mission profile can vary significantly, and thus the reliability of PV inverters [15]–[18]. From the design perspective, this is a challenge for the DfR approach, where the concept of “one design fits all” is difficult to be achieved. For instance, if the PV inverter is designed to achieve the lifetime of 20 years under cold climate conditions (e.g., low average solar irradiance level), there is a high risk that the same inverter design (e.g., component selection and cooling system design) will not fulfill the reliability target when it is installed in a hot climate region (e.g., high average solar irradiance level).

On the other hand, the PV inverter designed with respect to the hot climate condition with strong average solar irradiance and high ambient temperature will be considered as an over-designed case for other installation sites with cold climate conditions. This is not preferable in the DfR concept, as it will increase the overall system cost, e.g., initial cost for over-designed cases and maintenance cost for under-designed cases. Moreover, applying different inverter designs according to installation sites is impractical with respect to the cost.

Actually, the inverter control strategies can affect the reliability and lifetime performances in addition to the mission profile. For instance, PV power variations (reflecting mission profile characteristics) induce thermal fluctuations on the inverters. Hence, limiting the maximum feed-in power can smooth the temperature variations and lower the thermal loading to some extent [19]–[21]. This contributes to improved lifetime, which can also be seen in smart de-rating control strategies [22]. Furthermore, at the switching timescale, the thermal loading of the PV inverters can be regulated [23]. This opens a direction to enhance the reliability and lifetime of PV inverters through a proper control, where the mission profiles are considered.

In light of the above, a Power Limiting Control (PLC) scheme is employed in this paper to enhance the PV inverter reliability, where mission profiles are also considered. The proposed strategy is applied to 6-kW single-phase PV inverters. In § III, the lifetime evaluation of PV inverters is presented, where two mission profiles in Denmark and Arizona are used. The results in § IV demonstrate that the same reliability target (e.g., the lifetime target of 20 years) can be achieved under both mission profiles with the proposed control strategy. Finally, concluding remarks are provided in § V.

II. SINGLE-PHASE GRID-CONNECTED PV INVERTERS

A. System Description

The system configuration and control structure of a single-phase grid-connected PV systems are shown in Fig. 2 and its parameters are given in Table I. Here, a DC-DC converter is employed to step up the PV array voltage v_{pv} to match the minimum required DC-link voltage and also provide the control of PV power extraction [24]. This is normally achieved through the regulation of the PV voltage, whose reference (v_{pv}^*) is determined by a Maximum Power Point Tracking (MPPT) algorithm. However, the PLC strategy can also be implemented in the control of the DC-DC converter, instead of the MPPT algorithm, to limit the PV power extraction to a certain level (below the maximum available power) [25], [26]. The extracted power is then delivered to a full-bridge DC-AC inverter (PV inverter), which provides grid-integration control (i.e., current control, grid synchronization) [27].

Regarding the power components, IGBT devices from [28] are used. The cooling system (e.g., heat sink sizing) is designed to ensure that the power device maximum junction temperature is 100 °C at 120% of the rated power (i.e., 7.2 kW). The dc-link is realized by connecting two electrolytic capacitors (2200 $\mu\text{F}/350\text{ V}$) from [29] in series.

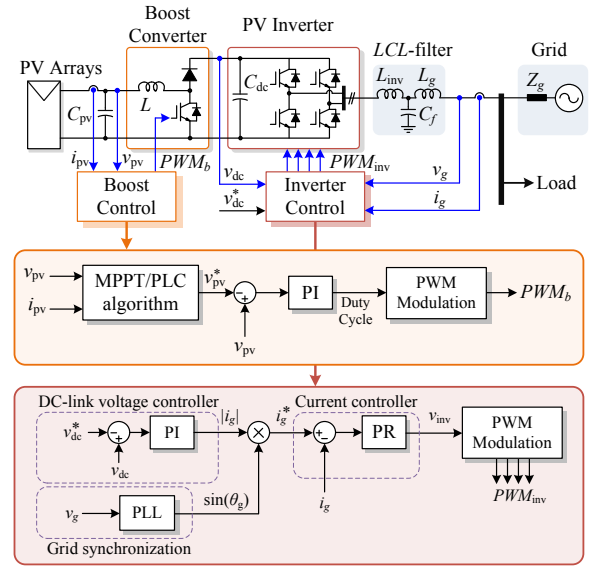

Fig. 2. System configuration and control structure of a two-stage single-phase grid-connected PV system (MPPT: Maximum Power Point Tracking, PLC: Power Limiting Control, PI: Proportional Integral, PR: Proportional Resonant, PLL: Phase-Locked Loop, PWM: Pulse Width Modulation).

TABLE I
PARAMETERS OF THE TWO-STAGE SINGLE-PHASE PV SYSTEM (FIG. 2).

PV inverter rated power	6 kW
Boost converter inductor	$L = 1.8\text{ mH}$
DC-link total capacitance	$C_{dc} = 1100\ \mu\text{F}$
LCL -filter	$L_{inv} = 4.8\text{ mH}$, $L_g = 2\text{ mH}$, $C_f = 4.3\ \mu\text{F}$
Switching frequencies	Boost converter: $f_b = 16\text{ kHz}$, Full-Bridge inverter: $f_{inv} = 8\text{ kHz}$
DC-link reference voltage	$v_{dc}^* = 450\text{ V}$
Grid nominal voltage (RMS)	$V_g = 230\text{ V}$
Grid nominal frequency	$\omega_0 = 2\pi \times 50\text{ rad/s}$

B. Power-Limiting Control (PLC) Strategy

Instead of always tracking the Maximum Power Point (MPP), the PV output power P_{pv} can be limited at a certain level P_{limit} below the available PV power P_{avai} . This operation can be achieved by regulating the operating PV voltage below the MPP, as it is demonstrated in Fig. 3. This is called power-limiting control in the literature, which is normally required when the available PV power becomes higher than the PV inverter rated power P_{rated} [25]. This situation usually occurs in the PV system with an over-sized PV array (i.e., the PV array is intentionally designed to have higher rated power than the inverter in order to gain more energy yield during the low solar irradiance condition) [30]. Another incident is due to the solar irradiance reflection from the cloud, resulting in the solar irradiance level higher than 1000 W/m^2 . Conventionally, the power-limit level is selected as the inverter rated power to ensure the safety of the inverter [30]. However, it should be pointed out that the PLC strategy is capable of flexibly

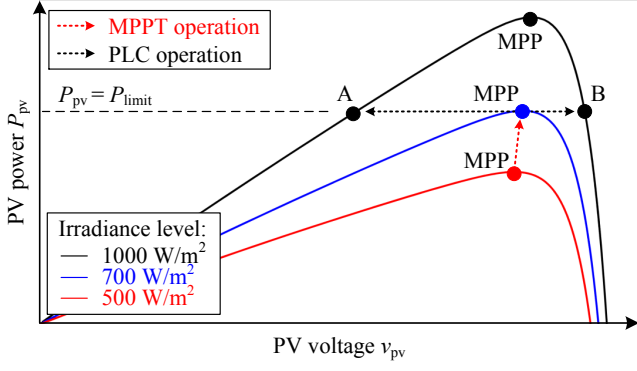

Fig. 3. Operational principle of the PV system with the Power-Limiting Control (PLC) strategy, e.g., operating point of the PV array is regulated at A or B in order to limit the extracted PV power at $P_{pv} = P_{limit}$.

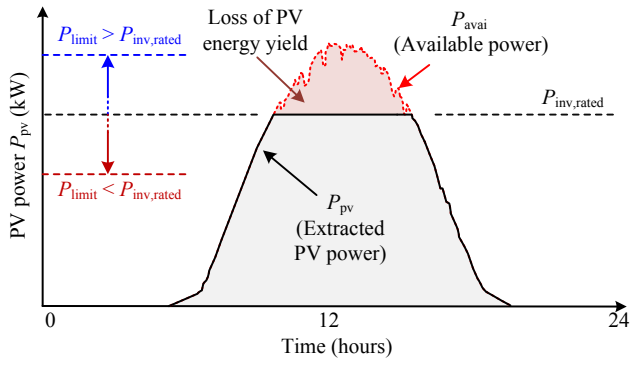

Fig. 4. PV power extraction with the Power-Limiting Control (PLC) strategy (P_{avai} : available PV power, P_{pv} : extracted PV power, P_{limit} : power-limit level, $P_{inv,rated}$: PV inverter rated power).

regulating the extracted PV power at any power level below the available power P_{avai} (i.e., $0 \leq P_{pv} < P_{avai}$), as it is illustrated in Fig. 4. This flexible power controllability is suitable to be employed in the mission profile-oriented control strategy, which will be analyzed in this paper. More details regarding the design and implementation of the PLC strategy have been discussed in [25].

III. RELIABILITY ASSESSMENT OF PV INVERTERS

The mission profile is important in the reliability assessment and lifetime prediction of PV inverters. Thus, it is usually considered during the reliability evaluation process as it is illustrated in Fig. 5. From the mission profile, the PV inverter loading (e.g., power loss of the component) is determined from the PV panel model and the control strategy. Then, the power losses are applied to the thermal models of the components (e.g., power device and capacitor) to obtain the thermal loading during the operation, which is required for the lifetime model. This procedure will be discussed in the following and the mission profiles in Denmark and Arizona will be applied. The lifetime of the components in the PV inverter (e.g., power devices and capacitor) will be evaluated, where the 20-year lifetime is selected as a reliability target.

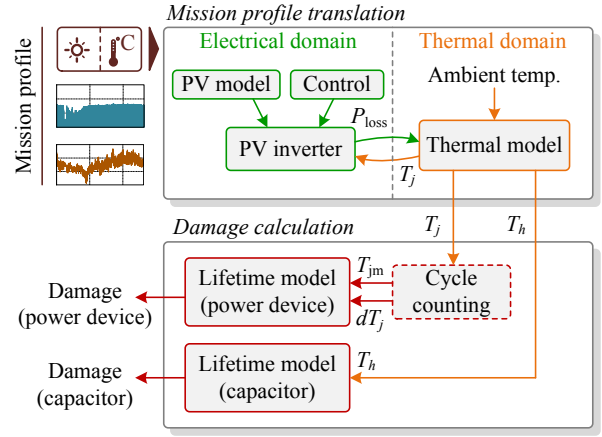

Fig. 5. Reliability assessment of PV inverters based on mission profiles [12].

A. Mission Profiles

The mission profiles recorded in Denmark and Arizona are used in this study, as they are shown in Fig. 6. It can be seen from Fig. 6 that the average solar irradiance level in Arizona is constantly high through the year, while the average solar irradiance level in Denmark is relatively low through November to February. The same trend is applied to the ambient temperature profile. The mission profiles in Denmark and Arizona represent the installation site in a cold and hot climate condition, respectively. It can be expected from the mission profile that the PV power production of the PV system in Arizona will be higher than that in Denmark.

When translating the mission profile into the inverter loading (following Fig. 5), it can be expected that the PV inverter installed in Arizona will experience higher loading during the operation. In that case, the reliability-critical components in the system (e.g., power devices and capacitor) will be subjected to higher thermal stresses than those installed in Denmark. Consequently, the reliability and lifetime of the PV inverter under the two installation sites can differ considerably, which will be demonstrated in the following.

B. Damage Calculation

For the reliability-critical components in the PV inverter such as power devices and capacitors, the main cause of component wear-out failures is related to the thermal stress. In the case of power devices (e.g., IGBT), the thermal cycling is one of the main stress factors that cause bond-wire lift-off and solder fatigue after a number of thermal cycles, which can be determined from the lifetime model as

$$N_f = A \times (\Delta T_j)^\alpha \times (ar)^{\beta_1 \Delta T_j + \beta_0} \times \left[\frac{C + (t_{on})^\gamma}{C + 1} \right] \times \exp\left(\frac{E_a}{k_b \times T_{jm}}\right) \times f_d \quad (1)$$

where N_f is the number of cycles to failure [31]. In (1), the thermal cycle amplitude ΔT_j , the mean junction temperature T_{jm} , and cycle period t_{on} are the stress levels obtained from the cycle counting algorithm, while the lifetime model parameters are given in Table II.

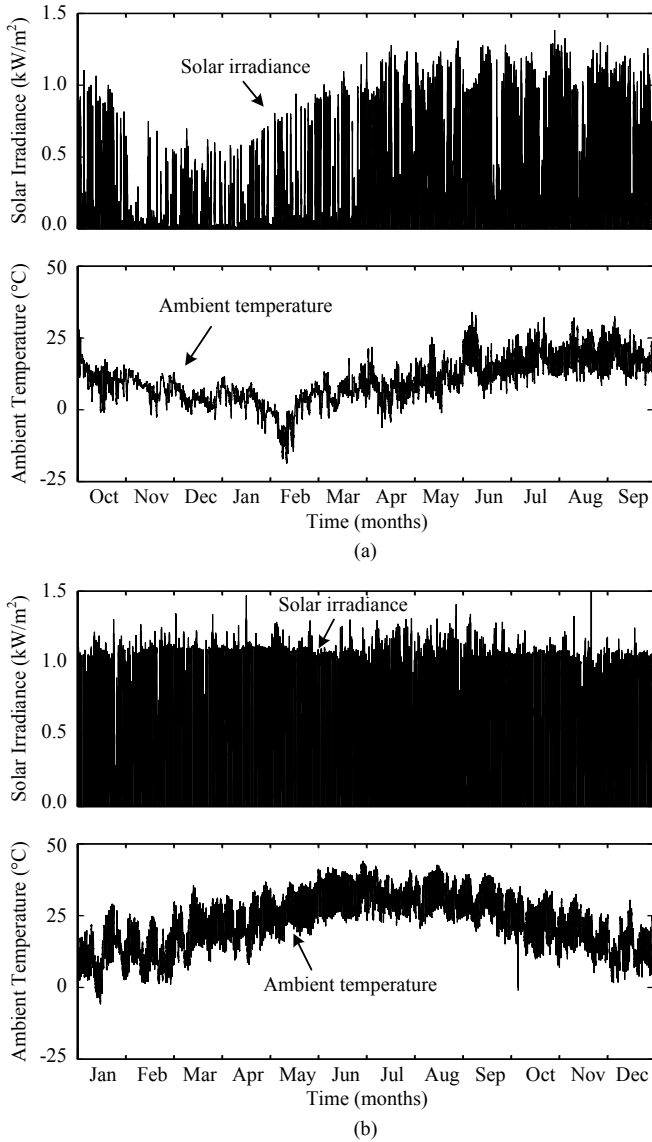

Fig. 6. Yearly mission profiles (i.e., irradiance and ambient temperature with a sampling rate of 5 mins per sample) in: (a) Denmark and (b) Arizona.

Normally, it is assumed that the contribution of each thermal cycle to the failure of power device is accumulated linearly and independently during operation following the Miner's rule as

$$AD = \sum_i \frac{n_i}{N_{fi}} \quad (2)$$

where n_i is the number of cycles at a certain stress level (T_{jm} , ΔT_j , and t_{on}), and N_{fi} is the number of cycles to failure calculated from (1) at that stress condition. Here, AD is the accumulated damage of the power device during operation. When the damage is accumulated to unity (i.e., $AD = 1$), the power device is considered to reach its end-of-life.

The DC-link capacitor is another lifetime-limiting component in the PV inverter, where the hotspot temperature T_h is

TABLE II
PARAMETERS OF THE LIFETIME MODEL OF AN IGBT MODULE [31].

Parameter	Value	Experimental condition
A	3.4368×10^{14}	
α	-4.923	$64 \text{ K} \leq \Delta T_j \leq 113 \text{ K}$
β_1	-9.012×10^{-3}	
β_0	1.942	$0.19 \leq ar \leq 0.42$
C	1.434	
γ	-1.208	$0.07 \text{ s} \leq t_{on} \leq 63 \text{ s}$
f_d	0.6204	
E_a	0.06606 eV	$32.5 \text{ }^\circ\text{C} \leq T_j \leq 122 \text{ }^\circ\text{C}$
k_B	$8.6173324 \times 10^{-5} \text{ eV/K}$	

TABLE III
PARAMETERS OF THE LIFETIME MODEL OF A CAPACITOR [29].

Parameter	Symbol	Value
Rated lifetime (at V_{rated} and T_m)	L_m	3000 hours
Rated operating voltage	V_{rated}	350 V
Rated operating temperature	T_m	105°C

the main stress parameter. The lifetime model of the capacitor (e.g., aluminum electrolytic capacitor) is given as

$$L_f = L_m \times \left(4.3 - 3.3 \frac{V_{op}}{V_{\text{rated}}}\right) \times 2^{\left(\frac{T_m - T_h}{10}\right)} \quad (3)$$

in which L_f is the time-to-failure under the thermal stress level of T_h and the voltage stress level of V_{op} [32], and the other parameters are given in Table III [29].

Then, the Miner's rule can also be applied to the lifetime calculation of the capacitor as

$$AD = \sum_i \frac{l_i}{L_{fi}} \quad (4)$$

where l_i is the operating time for a set of T_h and V_{op} (e.g., the mission profile time resolution) and L_{fi} is the time-to-failure calculated from (3) at that specific stress condition.

C. Case Study

Following the reliability assessment method in Fig. 5, the damage occurred in the power device and capacitor during the operation can be calculated and used as a reliability metric. For instance, the operation with high accumulated damage indicates low reliability and a high failure rate of the component. In this case study, the MPPT operation is applied to demonstrate the mission profile-dependency of the PV inverter reliability. Notably, for the installation site in Denmark, the rated installed power of the PV arrays is 8.4 kW, which is 1.4 times higher than the PV inverter rated power. In this case, the PV arrays are over-sized, which is practical for the installation site with relatively low solar irradiance conditions (e.g., Denmark) [30].

By applying the mission profiles in Fig. 6, the corresponding damage of the component in the PV inverter installed in Denmark and Arizona can be obtained, as shown in Fig. 7(a) and (b), respectively. For the mission profile in Denmark, it can be seen in Fig. 7(a) that only small damage occurs in the

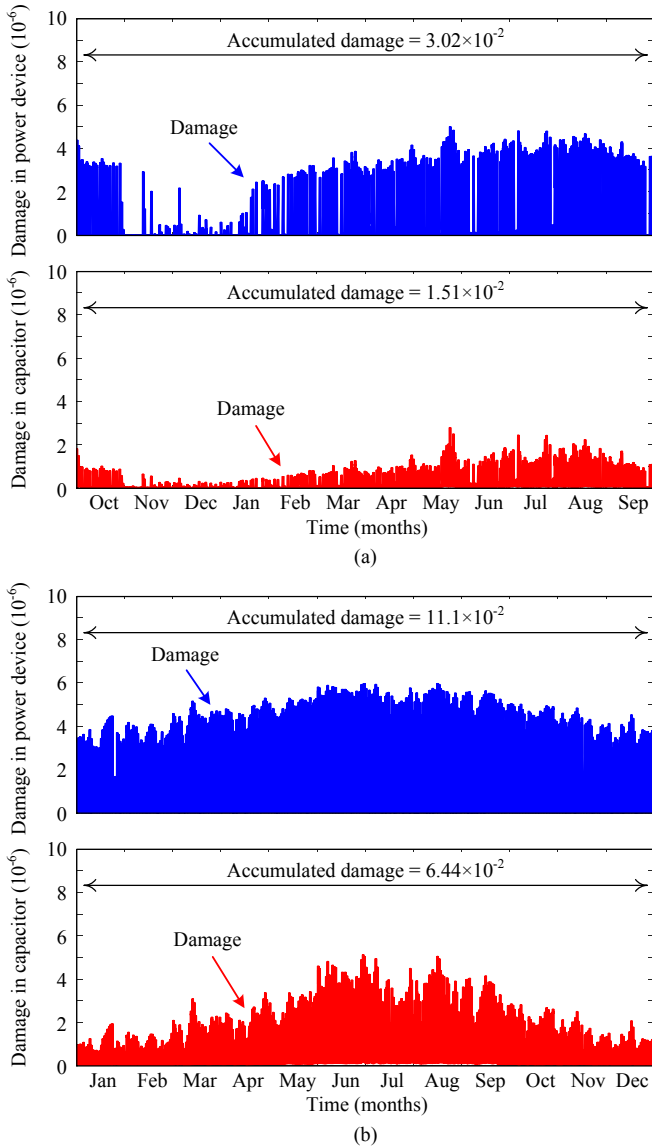

Fig. 7. Damage in the power device and capacitor of the PV inverter under one-year mission profile in: (a) Denmark and (b) Arizona.

power device and capacitor of the inverter during winter (e.g., November to February) due to low solar irradiance conditions. In fact, most of the damage occurs from April to August. The accumulated damage over one year of the power device and capacitor in the PV inverter is $AD = 3.02 \times 10^{-2}$ per year and $AD = 1.51 \times 10^{-2}$ per year, respectively. This corresponds to the component lifetime of 33 years for the power device and 66 years for the capacitor. Accordingly, the reliability target (i.e., the component lifetime of 20 years) is fulfilled with the designed inverter under the mission profile in Denmark.

For the PV inverter installed in Arizona, the damage in the power device and capacitor is relatively high through the entire year, as it is shown in Fig. 7(b), which reflects the mission profile characteristics. In that case, a one-year operation under the Arizona mission profile contributes to the accumulated

damage of $AD = 11.1 \times 10^{-2}$ per year for the power device and $AD = 6.44 \times 10^{-2}$ per year for the capacitor. Thus, the power device is expected to fail after 9 years, while it is 15 years for the capacitor. In this case, the reliability target (i.e., the component lifetime of 20 years) is not fulfilled for the given inverter design.

IV. MISSION PROFILE-ORIENTED CONTROL STRATEGY

As shown previously, the designed PV inverter cannot fulfill the reliability target in the Arizona case, while it is considered to be over-designed when installed in Denmark. In the following, the PLC strategy is applied to reshape the inverter reliability according to the mission profile.

A. Control for Reliability

As discussed in § II-B, the PLC strategy can be employed to flexibly regulate the extracted PV power (i.e., PV inverter loading) during the operation. However, there is always a trade-off between the PV inverter loading improvement and the PV energy yield, which needs to be considered when applying the PLC strategy. For instance, decreasing the power-limit level of the PLC strategy will reduce the peak-load of the PV inverter during the operation. This will certainly be beneficial to the PV inverter reliability, as it will reduce the thermal stress of the components. However, the energy yield will also be reduced due to the power curtailment. On the other hand, more PV energy yield can be gained by increasing the power-limit level, but the PV inverter loading will also increase, which decreases the PV inverter reliability.

B. Lifetime Evaluation

Following the above consideration, the power-limit level should be increased for the PV inverter installed in Denmark, since it is considered to be an over-designed case compared to the lifetime target of 20 years. In that case, more energy yield can be gained with a reduced margin in terms of reliability performance (e.g., lower component lifetime). Notably, the power-limit can be increased up to 120 % of the inverter rated power, following the design in § II in order to ensure that the components still operate within the safe operating area (according to [28] and [29]). The lifetime of the power device and capacitor of the PV inverter installed in Denmark under different power-limit levels are demonstrated in Fig. 8(a). From the result, it can be seen that the power-limit should not be increased to more than 108.5 % of the inverter rated power, which is the case when the lifetime target of 20 years is marginally fulfilled for the power device.

In contrast, the PV inverter in Arizona should operate with a reduced power-limit level to improve the reliability, since the pre-designed inverter cannot achieve the reliability target. The evaluation results in Fig. 8(b) show that the power device lifetime of 20 years can be achieved, if the power-limit level is kept at 87.5 % of the inverter rated power. By further decreasing the power-limit below 87.5 % of the inverter rated power, the component lifetime can be further increased but it will also result in more energy yield loss. This is not preferable from the cost-of-energy point of view.

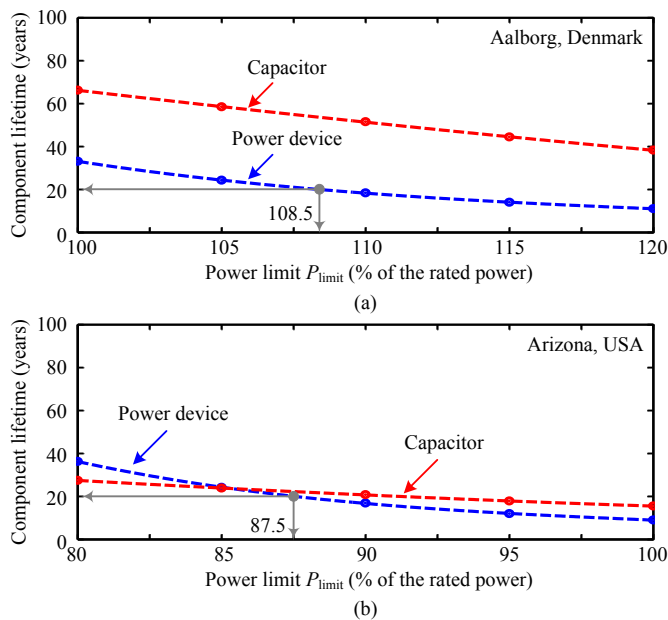

Fig. 8. Lifetime of power device and capacitor with different power-limit levels under one-year mission profile in: (a) Denmark and (b) Arizona.

C. PV Energy Yield

As a trade-off of the PLC strategy, the energy yield has to be considered together with the reliability improvement. The relative increase/decrease in the PV energy yield (compared to the case with the MPPT operation) with different power-limit levels is evaluated and shown in Fig. 9. For the mission profile in Denmark, more PV energy can be extracted by increasing the power-limit level above the inverter rated power. By increasing the power-limit level to 108.5 % of the inverter rated power (i.e., when the obtained lifetime is 20 years), the energy yield is increased by 2.74 %. For the case of PV inverter installed in Arizona, 7.47 % of the energy yield needs to be sacrificed to achieve a lifetime target of 20 years.

The above results (Figs. 8 and 9) suggest that the PLC strategy can be employed to minimize the overall cost of solar energy concerning the total energy yield together with the operation and maintenance cost (e.g., cost associated with the inverter failure). For instance, the multi-objective optimization problem to minimize the life-cycle cost of the overall PV system should be used for determining the optimal power-limit level for each mission profile.

V. CONCLUSION

In this paper, a mission profile-oriented control strategy for PV inverters has been presented. The proposed control strategy is based on the power-limiting control scheme, which has been adaptively applied according to the mission profile characteristic. A case study of the mission profiles in Denmark and Arizona has been carried out, where the reliability target is specified as the component lifetime of 20 years. For the Denmark case, where the inverter is over-designed, the energy yield can be increased up to 2.74 % by allowing the PV

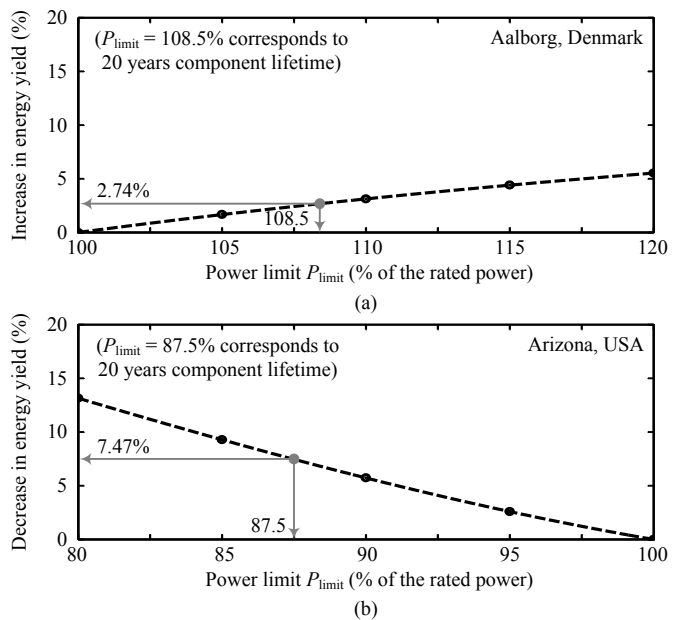

Fig. 9. Impact of the energy yield of the PV inverter with different power-limit levels under one-year mission profile in: (a) Denmark and (b) Arizona.

inverter to operate above the rated power. In contrast, the PV inverter installed in Arizona cannot fulfill the lifetime target with the conventional MPPT control, when the same inverter design of the Denmark case is adopted. However, by limiting the feed-in power at 87.5 % of the designed inverter rated power, the power device lifetime can be prolonged to 20 years with the compromise of 7.47 % reduction in the energy yield.

REFERENCES

- [1] REN21, "Renewables 2017: Global Status Report (GSR)," 2017. [Online]. Available: <http://www.ren21.net/>.
- [2] National Renewable Energy Laboratory, "On the path to sunshot: The role of advancements in solar photovoltaic efficiency, reliability, and costs," Tech. Rep. No. NREL/TP-6A20-65872, 2016.
- [3] Fraunhofer ISE, "Current and future cost of photovoltaics. long-term scenarios for market development, system prices and LCOE of utility-scale PV systems," February, 2015. [Online]. Available: <http://www.pv-fakten.de/>.
- [4] M. Taylor, P. Ralon, and A. Ilas, "The power to change: Solar and wind cost reduction potential to 2025," International Renewable Energy Agency (IRENA), Tech. Rep., Jun. 2016.
- [5] KIC InnoEnergy, "Future renewable energy costs: solar photovoltaics," Tech. Rep., 2015.
- [6] L. M. Moore and H. N. Post, "Five years of operating experience at a large, utility-scale photovoltaic generating plant," *Progress Photovoltaics: Res. Appl.*, vol. 16, no. 3, pp. 249–259, 2008.
- [7] A. Golnas, "PV system reliability: An operator's perspective," *IEEE J. of Photovolt.*, vol. 3, no. 1, pp. 416–421, Jan. 2013.
- [8] P. Hacke, S. Lokanath, P. Williams, A. Vasan, P. Sochor, G. Tamizhmani, H. Shinohara, and S. Kurtz, "A status review of photovoltaic power conversion equipment reliability, safety, and quality assurance protocols," *Renew. Sustain. Energy Rev.*, vol. 82, pp. 1097–1112, 2018.
- [9] H. Wang, M. Liserre, and F. Blaabjerg, "Toward reliable power electronics: Challenges, design tools, and opportunities," *IEEE Ind. Electron. Mag.*, vol. 7, no. 2, pp. 17–26, Jun. 2013.
- [10] N. C. Sintamarean, F. Blaabjerg, H. Wang, F. Iannuzzo, and P. de Place Rimmen, "Reliability oriented design tool for the new generation of grid connected pv-inverters," *IEEE Trans. Power Electron.*, vol. 30, no. 5, pp. 2635–2644, May 2015.

- [11] K. Ma, H. Wang, and F. Blaabjerg, "New approaches to reliability assessment: Using physics-of-failure for prediction and design in power electronics systems," *IEEE Power Electron. Mag.*, vol. 3, no. 4, pp. 28–41, Dec. 2016.
- [12] Y. Yang, A. Sangwongwanich, and F. Blaabjerg, "Design for reliability of power electronics for grid-connected photovoltaic systems," *CPSS Trans. Power Electron. Appl.*, vol. 1, no. 1, pp. 92–103, 2016.
- [13] H. Huang and P. A. Mawby, "A lifetime estimation technique for voltage source inverters," *IEEE Trans. Power Electron.*, vol. 28, no. 8, pp. 4113–4119, Aug. 2013.
- [14] M. Musallam, C. Yin, C. Bailey, and M. Johnson, "Mission profile-based reliability design and real-time life consumption estimation in power electronics," *IEEE Trans. Power Electron.*, vol. 30, no. 5, pp. 2601–2613, May 2015.
- [15] S. E. D. Leon-Aldaco, H. Calleja, F. Chan, and H. R. Jimenez-Grajales, "Effect of the mission profile on the reliability of a power converter aimed at photovoltaic applications - a case study," *IEEE Trans. Power Electron.*, vol. 28, no. 6, pp. 2998–3007, Jun. 2013.
- [16] A. Anurag, Y. Yang, and F. Blaabjerg, "Reliability analysis of single-phase PV inverters with reactive power injection at night considering mission profiles," in *Proc. of ECCE*, pp. 2132–2139, Sep. 2015.
- [17] C. Felgelmacher, S. Araujo, C. Noeding, P. Zacharias, A. Ehrlich, and M. Schidleja, "Evaluation of cycling stress imposed on IGBT modules in PV central inverters in sunbelt regions," in *Proc. of CIPS*, pp. 1–6, Mar. 2016.
- [18] A. Sangwongwanich, Y. Yang, D. Sera, and F. Blaabjerg, "Lifetime evaluation of grid-connected PV inverters considering panel degradation rates and installation sites," *IEEE Trans. Power Electron.*, vol. 33, no. 2, pp. 1225–1236, Feb. 2018.
- [19] Y. Yang, H. Wang, F. Blaabjerg, and T. Kerekes, "A hybrid power control concept for PV inverters with reduced thermal loading," *IEEE Trans. Power Electron.*, vol. 29, no. 12, pp. 6271–6275, Dec. 2014.
- [20] M. Andresen, G. Buticchi, and M. Liserre, "Thermal stress analysis and mppt optimization of photovoltaic systems," *IEEE Trans. Ind. Electron.*, vol. 63, no. 8, pp. 4889–4898, Aug. 2016.
- [21] Y. Yang, E. Koutroulis, A. Sangwongwanich, and F. Blaabjerg, "Pursuing photovoltaic cost-effectiveness: Absolute active power control offers hope in single-phase PV systems," vol. 23, no. 5, pp. 40–49, Sep. 2017.
- [22] I. Vernica, K. Ma, and F. Blaabjerg, "Optimal derating strategy of power electronics converter for maximum wind energy production with lifetime information of power devices," *IEEE J. Emerg. Sel. Topics Power Electron.*, vol. 6, no. 1, pp. 267–276, Mar. 2018.
- [23] D. A. Murdock, J. E. R. Torres, J. J. Connors, and R. D. Lorenz, "Active thermal control of power electronic modules," *IEEE Trans. Ind. Appl.*, vol. 42, no. 2, pp. 552–558, Mar. 2006.
- [24] S.B. Kjaer, J.K. Pedersen, and F. Blaabjerg, "A review of single-phase grid-connected inverters for photovoltaic modules," *IEEE Trans. Ind. Appl.*, vol. 41, no. 5, pp. 1292–1306, Sep. 2005.
- [25] A. Sangwongwanich, Y. Yang, F. Blaabjerg, and H. Wang, "Benchmarking of constant power generation strategies for single-phase grid-connected photovoltaic systems," *IEEE Trans. Ind. Appl.*, vol. 54, no. 1, pp. 447–457, Jan.-Feb. 2018.
- [26] A. Sangwongwanich, Y. Yang, and F. Blaabjerg, "Development of flexible active power control strategies for grid-connected photovoltaic inverters by modifying MPPT algorithms," in *Proc. IFEEC 2017 - ECCE Asia*, pp. 87–92, Jun. 2017.
- [27] F. Blaabjerg, R. Teodorescu, M. Liserre, and A.V. Timbus, "Overview of control and grid synchronization for distributed power generation systems," *IEEE Trans. Ind. Electron.*, vol. 53, no. 5, pp. 1398–1409, Oct. 2006.
- [28] *SGP30N60*, Infineon Technologies AG, 2007, rev. 2.3.
- [29] *Type 381LX / 383LX 105 C High Ripple, Snap-In Aluminum*, Cornell Dubilier, Liberty, SC, USA. [Online]. Available: <http://www.cde.com/resources/catalogs/381-383.pdf>
- [30] SolarEdge, "Oversizing of SolarEdge inverters, technical note," Tech. Rep., July 2016.
- [31] U. Scheuermann, R. Schmidt, and P. Newman, "Power cycling testing with different load pulse durations," in *Proc. of PEMD 2014*, pp. 1–6, Apr. 2014.
- [32] *Application guide, Aluminum Electrolytic Capacitors*, Cornell Dubilier, Liberty, SC, USA. [Online]. Available: <http://www.cde.com/catalogs/AEappGUIDE.pdf>