



Aalborg Universitet

AALBORG UNIVERSITY
DENMARK

Adaptive reactive power control of PV power plants for improved power transfer capability under ultra-weak grid conditions

Yang, Dongsheng; Wang, Xiongfei; Liu, Fangcheng; Xin, Kai; Liu, Yunfeng; Blaabjerg, Frede

Published in:
Proceedings of 2017 IEEE Power & Energy Society General Meeting

DOI (link to publication from Publisher):
[10.1109/PESGM.2017.8273911](https://doi.org/10.1109/PESGM.2017.8273911)

Publication date:
2017

Document Version
Accepted author manuscript, peer reviewed version

[Link to publication from Aalborg University](#)

Citation for published version (APA):
Yang, D., Wang, X., Liu, F., Xin, K., Liu, Y., & Blaabjerg, F. (2017). Adaptive reactive power control of PV power plants for improved power transfer capability under ultra-weak grid conditions. In *Proceedings of 2017 IEEE Power & Energy Society General Meeting* IEEE Press. IEEE Power and Energy Society General Meeting <https://doi.org/10.1109/PESGM.2017.8273911>

General rights

Copyright and moral rights for the publications made accessible in the public portal are retained by the authors and/or other copyright owners and it is a condition of accessing publications that users recognise and abide by the legal requirements associated with these rights.

- ? Users may download and print one copy of any publication from the public portal for the purpose of private study or research.
- ? You may not further distribute the material or use it for any profit-making activity or commercial gain
- ? You may freely distribute the URL identifying the publication in the public portal ?

Take down policy

If you believe that this document breaches copyright please contact us at vbn@aub.aau.dk providing details, and we will remove access to the work immediately and investigate your claim.

Adaptive Reactive Power Control of PV Power Plants for Improved Power Transfer Capability under Ultra-Weak Grid Conditions

Dongsheng Yang¹, Xiongfei Wang¹, Fangcheng Liu², Kai Xin², Yunfeng Liu², Frede Blaabjerg¹

1.Department of Energy Technology, Aalborg University.

Pontoppidanstraede 101, Aalborg, 9220, Denmark

2.Watt Lab, Central Research Institute of Huawei Technologies Co., LTD.

No.2222, Xin jinqiao Road, Shanghai, 201206, China

doy@et.aau.dk, xwa@et.aau.dk, formula.liu@huawei.com, kai.xin@huawei.com, yf.liu@huawei.com, fbl@et.aau.dk,

Abstract—The Photovoltaic (PV) power plant are usually deployed in remote areas with the high solar irradiance, and its power transfer capability can be greatly limited by the large impedance of long-distance transmission lines. This paper investigates first the power transfer limit of the PV power plant with the Short-Circuit Ratio (SCR) close to 1. It explicitly identifies that a minimum SCR of 2 is required for the PV power plant to deliver the rated active power when operating with the unit power factor. Then, considering the reactive power compensation from PV inverters, the minimum SCR along with the different Power Factor (PF) is derived. An adaptive reactive power droop control is further proposed to improve the power transfer capability of the PV power plant. Simulation results of a 20MW solar farm demonstrate that the proposed method can ensure the rated power transfer of PV power plant with SCR of 1.25, provided that PV inverters with $PF_{min}=0.9$ is used.

Index Terms—Adaptive Control, Power Transmission, Photovoltaic systems, Reactive Power Compensation.

I. INTRODUCTION

Utility-scale Photovoltaic (PV) power plants have recently gained wide acceptance, thanks to their environmentally-friendly feature and the substantial cost decline of PV panels [1]. Due to the low energy densities and uneven distributions of solar resources, many PV power plants are deployed in remote areas with the high solar irradiance. As a consequence, the long-distance power transmission lines with a low Short-Circuit Ratio (SCR) challenges the power transfer capability of PV power plants [2]. The new transmission technology based on the High Voltage Direct Current (HVDC) system, together with advanced reactive power compensation devices, such as Static Synchronous Compensator (STATCOM), have recently been used to improve the power transfer capacity [3]. However, the dynamic interaction among the HVDC system, reactive power compensation devices and PV inverters in the PV power plant poses new challenges on the system stability and power quality [4]. It hence becomes more appealing to utilize the power controllability of PV inverters for the improved power transfer capability under weak grid conditions, which is also more advantageous by sharply cutting down the cost of grid infrastructure upgrade.

Many research works have been reported on the advanced power control methods for PV inverters, yet most of them are

concerned with the PV hosting capacity on distribution feeders [5]-[6]. Few works have studied the power transfer capability of PV power plants in weak grids. This paper thus attempts to fill in this gap by identifying the relationship between the SCR and the Power Factor (PF) of PV inverters for transferring the rated active power. Then, an adaptive reactive power control method is proposed for PV power plant which can dynamically compensate the voltage fluctuation at the point of common coupling (PCC) caused by active power injection, and meanwhile automatically allocate the required reactive power to the individual inverters in a decentralized way, so that the power transfer capacity of PV power plant can be improved to its theoretical limitation.

II. POWER LIMITATION WITHOUT REACTIVE POWER COMPENSATION UNDER ULTRA-WEAK GRID CONDITON

Fig. 1 shows the typical configuration of the PV power plant. It contains numerous of generation units and each units contains a DC/DC converter for local MPPT control and a DC/AC PV inverter for the grid-connection. All the generation units are connected to PCC through low-voltage cables and then fed into the high-voltage transmission network through the substation. To minimize the power loss, the generation units are distributed evenly around the substation so as to shorten the length of low-voltage cables as much as possible.

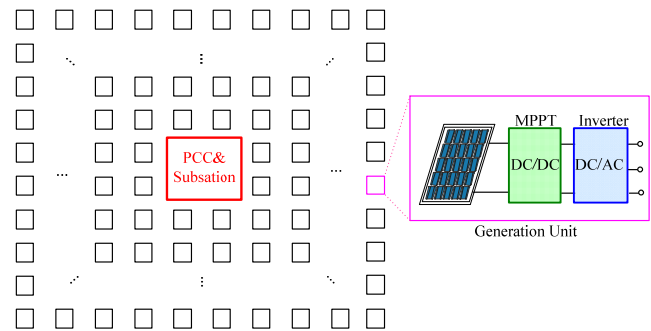

Figure 1. Configuration of the PV power plant.

The PV inverters are usually current-controlled to improve the power quality, so the whole farm can be treated as an ideal current source at the fundamental frequency. Meanwhile, the grid can be represented by its thevenin equivalent circuit.

Therefore, the simplified circuit of the whole grid-connection system can be obtained as shown in Fig. 2, where i_{pv} is the current injected by PV power plant, v_{pcc} is the voltage at PCC, v_g and Z_g are equivalent grid voltage and grid impedance at the PCC. Here, a resistor R_g series connected with an inductance X_g are used to model the grid impedance Z_g that introduced by long transmission lines and step-up power transformers.

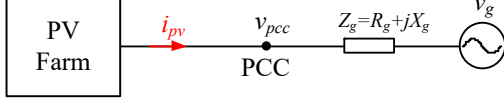

Figure 2. Equivalent circuit.

Under the weak grid condition, the grid impedance Z_g can impose a great limitation on the power transmission. The stiffness of the grid at the PCC can be depicted by the short circuit ratio, which can be expressed as:

$$SCR = \frac{P_{SC}}{P_{pv_rated}} = \frac{V_g^2 / |Z_g|}{P_{pv_rated}} \quad (1)$$

Accordingly, $|Z_g|$ can be represented by SCR, expressed as:

$$|Z_g| = \frac{V_g^2}{P_{pv_rated}} \cdot SCR \quad (2)$$

When the PV power plant is operated with unit PF, the phasor diagram is shown in Fig. 3, where \dot{i}_{pv} , \dot{v}_{pcc} and \dot{v}_g are the phasors of i_{pv} , v_{pcc} and v_g , respectively.

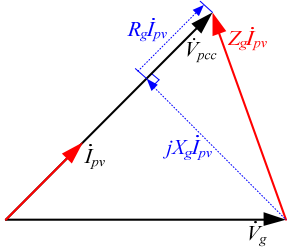

Figure 3. Phasor diagram when PV power plant is operated with unit PF.

According to Fig. 3, the root-mean-square (RMS) value of v_{pcc} can be derived as:

$$V_{pcc} = \sqrt{V_g^2 - (X_g \cdot I_{pv})^2} + R_g \cdot I_{pv} \quad (3)$$

The active power injected by PV power plant is given by:

$$P_{pv} = V_{pcc} \cdot I_{pv} \quad (4)$$

According to (2) and (3), the curves of V_{pcc} vs. I_{pv} and P_{pv} vs. I_{pv} under different R_g/X_g ratios when $SCR=1$ can be obtained, as shown in Fig. 4 and Fig. 5, respectively. As seen, V_{pcc} drops significantly at the rated I_{pv} injection, especially under the low R_g/X_g ratio. Correspondingly, the active power injected by PV power plant P_{pv} is also greatly. According to (2)~(4), the maximum power of P_{pv} can be derived as:

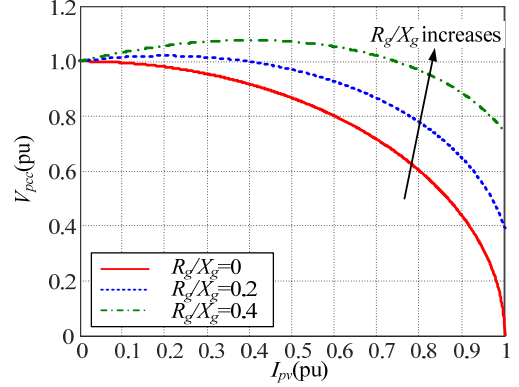

Figure 4. Curves of V_{pcc} vs. I_{pv} under different R_g/X_g ratios when $SCR=1$.

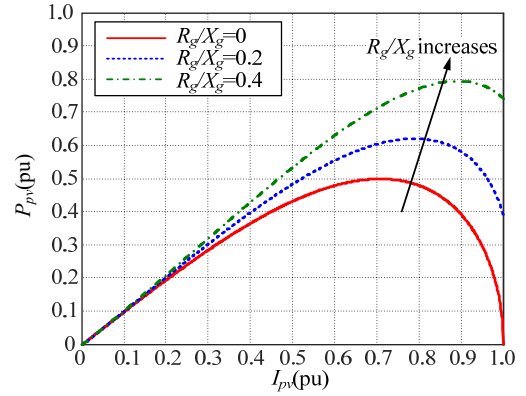

Figure 5. Curves of P_{pv} vs. I_{pv} under different R_g/X_g ratios when $SCR=1$.

$$P_{pv_max} = \frac{1}{2} \cdot \frac{1}{1 - \frac{1}{\sqrt{1 + (X_g/R_g)^2}}} \cdot \frac{V_g^2}{|Z_g|} \quad (5)$$

In order to deliver the rated power into the grid, i.e., $P_{pv_max} > P_{pv_rated}$, the minimum SCR is required, and its expression can be derived according to (2) and (5), given by:

$$SCR_{min} = 2 - \frac{2}{\sqrt{1 + \frac{1}{(R_g/X_g)^2}}} \quad (6)$$

It can be seen that lower SCR_{min} can be achieved when the R_g/X_g ratio of the grid impedance is increased. However, since the PV power plant is usually directly fed into the high voltage transmission network with low R_g/X_g ratio, the power limitation is more serious. According to (6), a minimum SCR of 2 is required when R_g/X_g ratio approaches to 0.

III. REACTIVE POWER COMPENSATION OF PV POWER PLANT

In order to operate PV power plant under the ultra-weak grid condition, additional reactive power compensation is necessary to raise up the voltage at PCC. In the following analysis, the grid impedance is assumed to be pure inductive to draw the worst case, i.e., $Z_g = jX_g$.

A. Comparison of different reactive power compensation solutions

Basically, the reactive power compensation can be implemented in two ways: 1) Installing external reactive power compensation equipment, such as STATCOM, SVG, to generate the reactive power; 2) Using the remaining power rating of PV inverters to generate reactive power.

Assumed that $Q=0.5P_{rated}$ is required, a reactive compensation equipment with the power rating of $0.5P_{rated}$ has to be installed for the first solution. Nevertheless, PV inverters with $1.12 P_{rated}$ is competent to provide the same reactive power at the rated active power rejection for the second solution. So the inverter-based reactive power compensation solution would be superior to the external compensation solution in terms of lower cost, higher efficiency. Moreover, since reactive power is provided by multiple distributed inverters and thus system reliability can be also improved.

B. Inverter-based reactive power compensation

To provide the reactive power compensation, the inverters in PV power plant should be operated with reduced PF . Assumed that PF angle is φ , the phasor diagram of the PV power plant and the grid with inverter-based reactive power compensation is shown in Fig. 6, where $\dot{I}_d = \dot{I}_{pv} \cos \varphi$ is the d -axis current component which is in phase with \dot{V}_{pcc} , and $\dot{I}_q = \dot{I}_{pv} \sin \varphi$ is the q -axis current component which is vertical to \dot{V}_{pcc} .

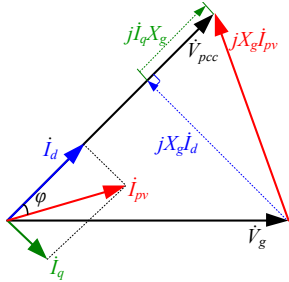

Figure 6. Phasor diagram using self-provided reactive power

According to Fig. 6, the output active power can be expressed as

$$P_{pv} = V_{pcc} \cdot I_d = \left(\sqrt{V_g^2 - (X_g \cdot I_d)^2} + X_g \cdot I_q \right) \cdot I_d \quad (7)$$

And the maximum of P_{pv} can be derived as:

$$P_{pv_max} \Big|_{I_{pv} = \frac{1}{\sqrt{2(1-\sin \varphi)}} \frac{V_g}{X_g}} = \frac{\cos \varphi}{2(1-\sin \varphi)} \cdot \frac{V_g^2}{X_g} \quad (8)$$

In order to deliver the rated power to the grid, i.e., $P_{pv_max} > P_{pv_rated}$, the minimum SCR requirement can be derived according to (2) and (8), given by:

$$SCR'_{min} = \frac{2(1-\sin \varphi)}{\cos \varphi} \quad (9)$$

This is the theoretical minimum SCR without considering the PF limitation of inverters. As for PV power plant using inverters which can be operated with $PF=0.9$ at rated power injection, the minimum SCR can be reduced to 1.254.

IV. ADAPTIVE REACTIVE POWER CONTROL TO IMPROVE THE POWER TRANSFER CAPACITY OF THE PV POWER PLANT

In the inverter-based reactive power compensation solution, the required reactive power must be allocated to the individual inverters properly, and the decentralized control without communication is more preferable because it can save the cost of establishing communication network among huge number of PV inverters. Moreover, it is also beneficial to enhancing the reliability of the system.

The most popular decentralized reactive power control is droop control, i.e., all the inverters regulated its reactive power according to the PCC voltage. The basic control scheme is shown in Fig. 7(a). When the V_{pcc} is below its nominal value V_n , the inverter will generate inductive reactive power to provide grid voltage support. Otherwise, it will absorb inductive reactive power to get the grid voltage down. In order to equally sharing the reactive power, the inverters are tuned with same ΔV_{max} and Q_{max} . The output reactive power of each inverter is given by:

$$Q = (V_n - V_{pcc}) \frac{Q_{max}}{\Delta V_{max}} \quad (10)$$

Since all the inverters regulate their reactive power according the variation of V_{pcc} , a detectable value of ΔV_{max} must be guaranteed to ensure the good reactive power sharing among different inverters. Usually, ΔV_{max} is set to 5%~10% of V_n . As a result, V_{pcc} will be inevitably reduced below its nominal value when the PV power plant injects the active power, and the current rating of inverters has to be increased compared with the same active power injection when V_{pcc} is regulated to its nominal value V_n . In other word, the power transfer capacity can be reduced due to the limited current rating.

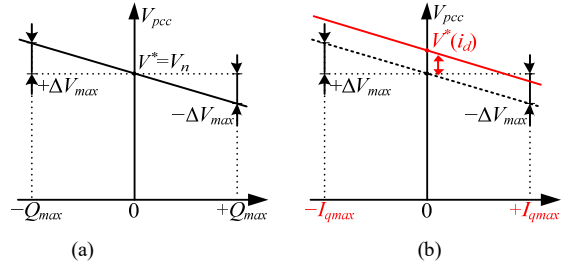

Figure 7. Distruted reactive power control method (a) Conventional droop control (b) Proposed adaptive droop control

In order to minimize the V_{pcc} variation, V^* can be regulated dynamically to restore V_{pcc} to its nominal value. Since V_{pcc} variation is mainly caused by the injected reactive power of PV power plant, an adaptive law is proposed to adjust V^*

dynamically so as to minimize V_{pcc} variation. The adaptive law utilizes the dynamic information of the d -axis current which is readily available in the inverter itself, so completely decentralized control can be realized without any communication. The control scheme of this adaptive droop control is shown in Fig 7(b), where I_{qmax} is the available output q -axis current at rated reactive power rejection limited by minimum PF_{min} , given by:

$$I_{qmax} = \frac{P_n}{V_n} \sqrt{\frac{1 - PF_{min}^2}{PF_{min}}} \quad (11)$$

So the output q -axis current is given by:

$$i_q = (V^*(i_d) - V_{pcc}) \cdot D_{iq} \quad (12)$$

where, $D_{iq} = I_{qmax} / \Delta V_{max}$ is the droop coefficient of q -axis current, and the adaptive law of $V^*(i_d)$ is derived as:

$$V^*(i_d) = V_n \left(1 + \frac{D_{iq}}{NX_g} \right) - D_{iq} \sqrt{\left(\frac{V_n}{NX_g} \right)^2 - i_d^2} \quad (13)$$

where N is the number of the paralleled inverters in the PV power plant. In this way, the voltage variation at PCC caused by the active power injected of PCC can be greatly eliminated, so the reactive power can be allocated to individual inverters in a distributed way without deteriorating V_{pcc} , and thus the power transfer capacity of the PV power plant can be increased to its theoretical maximum value.

V. SIMULATION RESULTS

A. Discription of the PV power plant

In order to verify the effectiveness of the proposed adaptive droop reactive power control method, a simulation model of 20MW PV power plant is built in the Matlab. It contains 1000 of PV inverters, and the key parameters of individual inverter is shown in Tab. I.

TABLE I. PARAMETERS OF THE PV INVERTER

Parameters	Value
Input voltage V_{in}	800 V
Rated output voltage(RMS) V_n	230 V
Rated output power P_n	20 kW
PF limitation	-0.9~+0.9
Maximum apprent power S_{max}	22.22 kVA
Maximum current rating (RMS) I_m	96.6 A

According to (9) and the PF limitation in Tab. I, the minimum SCR for the PV power plant to ensure rated power injection can be obtained as $SCR'_{min} = 1.254$. So PV power plant operated under the $SCR = 1.25$ to test this limitation. Meanwhile, the conventional droop control with $\Delta V_{max} = 5\% V_n$ is used for comparison.

B. Simulation Results

The daily generation curves using conventional droop control is shown in Fig. 8. To obtain a readable figure, 1000 inverters are divided into 10 groups, so each group has maximum current rating of $I_{max} = 100 I_m = 9.66 \text{ kA}$, and i_{group} in Fig. 9 refers to the group output current. P , Q , are the total output active and reactive power of the PV power plant, respectively. As seen, the V_{pcc} is reduced to 219V (95% V_n) at peak hours between 11:00 and 12:30, so actual power transfer ability of PV power plant is reduced because larger current is needed to deliver the rated real power. As a result, the power transfer capacity PV power plant is limited at 19MW. With the proposed adaptive droop control, as shown in Fig 9, the voltage drop can be compensated dynamically under different output power levels. Therefore, more real power can be delivered given the same current rating I_{max} , and 20MW rated power delivery can be approximately achieved.

Since the proposed method needs to estimate grid impedance X_g to adjust V^* , simulation results with $\pm 20\%$ estimation error of X_g are presented to examine its robustness. As can be seen in Fig. 10 and Fig. 11, due the parameter mismatch, V^* can be less-adjusted or over-adjusted, and the voltage variation can be observed at PCC. Nevertheless, it still works much better than the conventional droop control in terms of voltage regulation and power transfer capacity. Similar simulation results can be obtained when the parameter N in (13) does not agree with the actual number of running inverters in PV power plant, so it will not be repeated here.

VI. CONCLUSION

This paper investigates the power limitation of PV power plant under ultra-weak grid condition with SCR close to 1. A minimum SCR of 2 is required for PV power plant to ensure the rated real power injection when it is operated with unit power factor. This requirement can be reduced when inverters in the PV power plants can provided the reactive power compensation, and the minimum SCR with different PF is derived. Moreover, an adaptive reactive power droop control method is proposed which can improve the power transfer capacity of the PV power plant to its theoretical limitation under the ultra-weak grid condition with SCR as low as 1.25.

REFERENCES

- [1] *Utility-scale solar photovoltaic power plants-A project developer's guide*, International Finance Corporation (IFC), 2015.
- [2] T. Brown, "Transmission network loading in Europe with high shares of renewables." *IET Renewable Power Generation*, vol 9, pp.57-65, Jan. 2015.
- [3] J. Z. Zhou and A. M. Gole, "VSC transmission limitations imposed by AC system strength and AC impedance characteristics," in *Proc. 2012 10th IET International Conference on AC and DC Power Transmission (ACDC 2012)*, pp. 1-6.
- [4] L. Shen, M. Barnes, and J. V. Milanović, "Interactions between STATCOM and VSC HVDC in dynamic GB system" in *Proc. IET International Conference on Power Electronics, Machines and Drives*, pp. 1-6.
- [5] E. Demirok, "Control of grid interactive PV inverters for high penetration in low voltage distribution networks," Ph.D. dissertation, Dept. Energy Technology, Univ. Aalborg, 2012.
- [6] S. Weckx, J. Driesen, "Optimal local reactive power control by PV inverters," *IEEE Transactions on Sustainable Energy*, vol 7, pp.1624-1633, Oct. 2016.

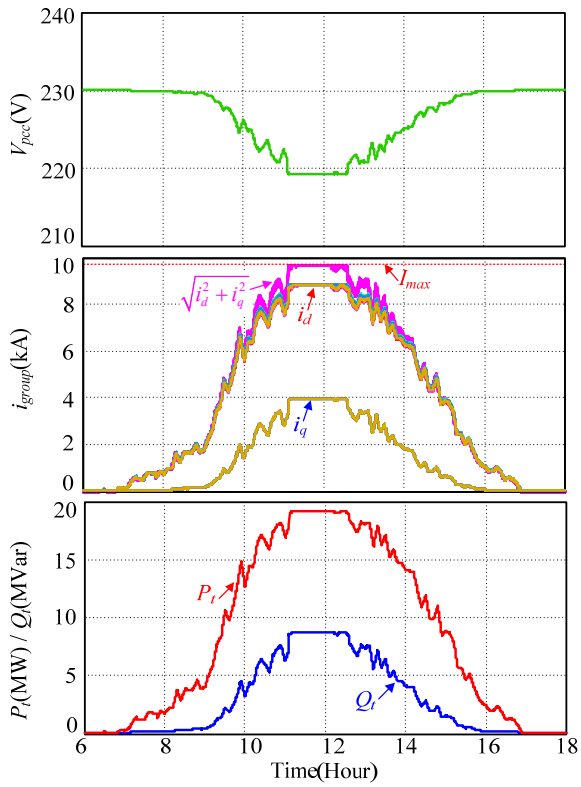

Figure 8. Key waveforms with conventional droop control

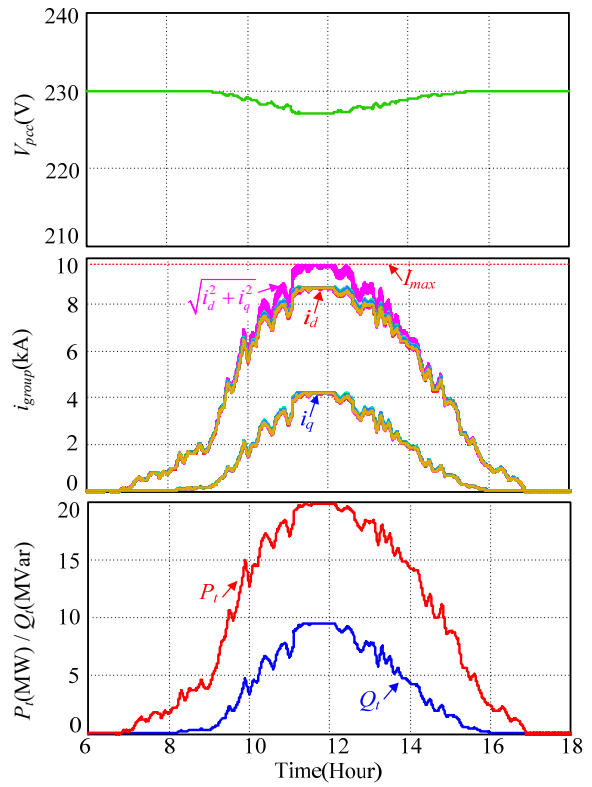

Figure 10. Adaptive droop control with -20% parameter mismatch

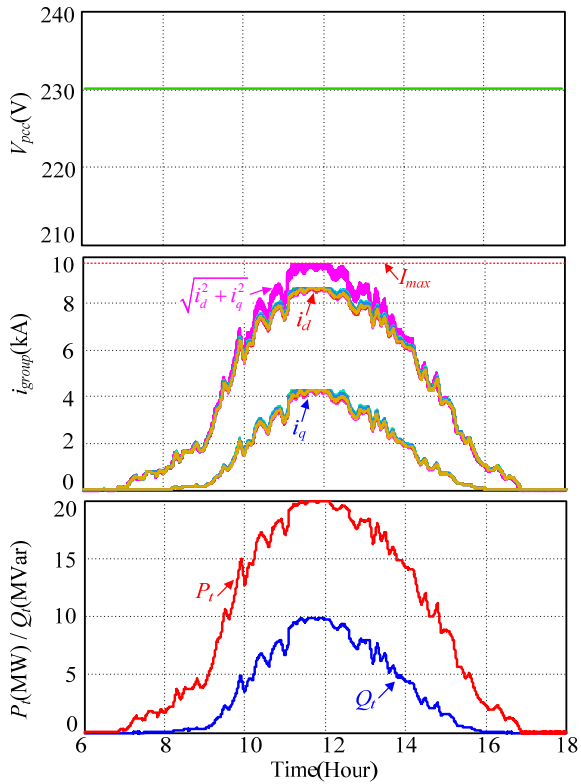

Figure 9. Key waveforms with adaptive droop control

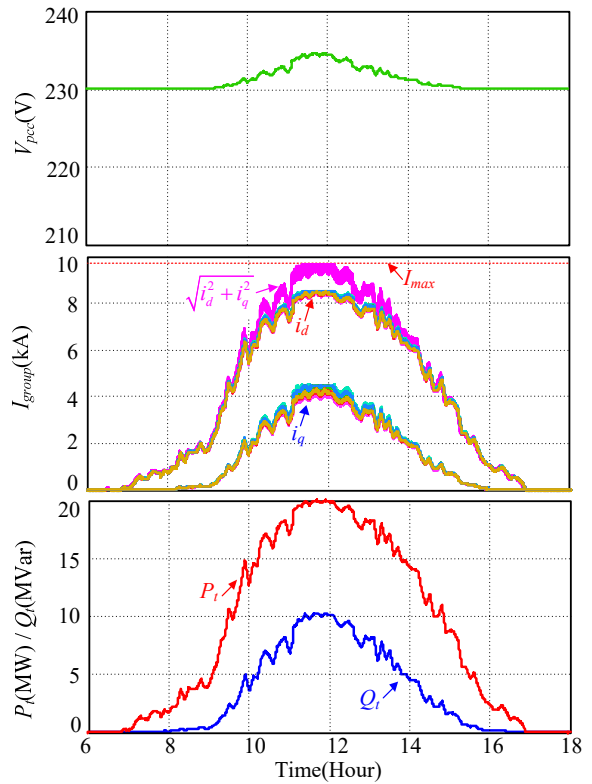

Figure 11. Adaptive droop control with $+20\%$ parameter mismatch