



Aalborg Universitet

AALBORG UNIVERSITY  
DENMARK

## Multiple time-scale optimization scheduling for islanded microgrids including PV, wind turbine, diesel generator and batteries

Xiao, Zhao xia; Nan, Jiakai; Guerrero, Josep M.; Fang, Hongwei

*Published in:*

Proceedings of 43rd Annual Conference of the IEEE Industrial Electronics Society, IECON 2017

*DOI (link to publication from Publisher):*

[10.1109/IECON.2017.8216436](https://doi.org/10.1109/IECON.2017.8216436)

*Publication date:*

2017

*Document Version*

Early version, also known as pre-print

[Link to publication from Aalborg University](#)

*Citation for published version (APA):*

Xiao, Z. X., Nan, J., Guerrero, J. M., & Fang, H. (2017). Multiple time-scale optimization scheduling for islanded microgrids including PV, wind turbine, diesel generator and batteries. In *Proceedings of 43rd Annual Conference of the IEEE Industrial Electronics Society, IECON 2017* (pp. 2594-2599). IEEE Press. <https://doi.org/10.1109/IECON.2017.8216436>

### General rights

Copyright and moral rights for the publications made accessible in the public portal are retained by the authors and/or other copyright owners and it is a condition of accessing publications that users recognise and abide by the legal requirements associated with these rights.

- ? Users may download and print one copy of any publication from the public portal for the purpose of private study or research.
- ? You may not further distribute the material or use it for any profit-making activity or commercial gain
- ? You may freely distribute the URL identifying the publication in the public portal ?

### Take down policy

If you believe that this document breaches copyright please contact us at [vbn@aub.aau.dk](mailto:vbn@aub.aau.dk) providing details, and we will remove access to the work immediately and investigate your claim.

# Multiple Time-Scale Optimization Scheduling for Islanded Microgrids including PV, Wind Turbine, Diesel Generator and Batteries

Xiao Zhaoxia<sup>1</sup>, Nan Jiakai<sup>1</sup>, Josep M. Guerrero<sup>2</sup>

1. Tianjin Key Laboratory of Advanced Technology of Electrical Engineering and Energy  
Tianjin Polytechnic University, P. R. China, Email: xiaozhaoxia@tjpu.edu.cn

2. Department of Energy Technology, Aalborg University, Denmark [joz@et.aau.dk](mailto:joz@et.aau.dk), [www.microgrids.et.aau.dk](http://www.microgrids.et.aau.dk)

**Abstract**—A multiple time-scale optimization scheduling including day ahead and short time for an islanded microgrid is presented. In this paper, the microgrid under study includes photovoltaics (PV), wind turbine (WT), diesel generator (DG), batteries, and shiftable loads. The study considers the maximum efficiency operation area for the diesel engine and the cost of the battery charge/discharge cycle losses. The day-ahead generation scheduling takes into account the minimum operational cost and the maximum load satisfaction as the objective function. Short-term optimal dispatch is based on minimizing the adjustment of the day-ahead scheduling and giving priority to the use of renewable energy. According to the forecast of the critical and noncritical load, the wind speed, and the solar irradiation, mixed integer linear programming (MILP) optimization method is used to solve the multi-objective optimization functions. Simulation results shown that the proposed multiple time-scale optimization scheduling approach minimizes the battery usage and maximize the use of renewable energies.

**Keywords**—Islanded microgrid, multiple time-scale, multi-objective, mixed-integer linear programming (MILP)

## I. INTRODUCTION

With the development of microgrid technology, one of the important research topics is how to properly manage the distributed sources and energy storages [1]. The energy management system (EMS) of a microgrid is based on managing the output power of the distributed sources and energy storages based on the forecasting the solar irradiation of photovoltaic (PV), wind speed, and the load power in a microgrid. In an islanded microgrid, the power and energy balance should be ensured, while achieving maximum economic benefits and environmental friendliness.

Due to high variability of renewable energy output power, it is a big challenge to settle the optimum scheduling. In addition, the accuracy of the renewable generation forecast in a microgrid is directly related to its time scale. Due to the random changes of the wind speed, wind power generation forecast error large, usually from 25% to 40% for day-ahead forecast [2]. While, short-term prediction of the output error can usually be reduced to 10% [3]. Due to the cloud-passing effects, the day-ahead forecast error of the output power in photovoltaic (PV) is usually about 20% [4], [5], and the short-term prediction of the output error can be reduced to 10% [6].

At present, the research in optimal scheduling of microgrids contains the following aspects: (i) output and cost model of

different generation units; (ii) optimization of scheduling time scale; and (iii) establishment and solution of objective functions.

In terms of output and cost model of different generation units, the different cost models for wind turbines (WTs), PV arrays, diesel generators (DG) and batteries are built in [7] and the objective function was to reduce the operational costs of the microgrid. Nevertheless, although the battery storage does not directly produce operational costs in the every operation cycle, the charge/discharge processes will affect its longevity. A detailed analysis of the impact of the battery charge/discharge depth and power rates are presented in [8], [9].

In [10], a three-level optimization frame of the day-ahead, short-time, and real-time scheduling is proposed. A multiple time-scale scheduling model of microgrid considering the random of wind generation is presented in [11].

In terms of the establishment and solution of objective functions for a microgrid, it mainly includes single and multiple objective functions, and the solution method is mainly mixed integer linear programming (MILP) and nonlinear programming (NP). In [12], [13], each objective function of the microgrid is given different weights, which transforms the multi-objective function into a single-objective function by using MILP. NP mainly includes the particle swarm algorithm, improved differential evolution algorithm, bacterial foraging algorithm, improved genetic algorithm, and so on [14], [15], [16]. The main consideration includes whether there is a conflict between different objective functions, and the optimal solution is global.

Considering the forecasting uncertainties of WTs, PV, and load power, the operational efficiency of the DG, and the effect of shiftable load on the economic operation of the microgrid, an optimal scheduling model of the day-ahead and short-term for an islanded microgrid is established. A MILP method is used to solve the multiple objective functions of the microgrid.

The structure of this paper is as follows. Section II introduces the objective function and constraint condition of the day-ahead scheduling. Section III introduces the objective function and the constraint condition of the short-term scheduling. Section IV gives the scheduling results of the two time-scale optimization methods. Conclusion is given in the Section V.

## II. OBJECTIVE FUNCTIONS OF DAY-AHEAD SCHEDULING AND CONSTRAINTS

Fig. 1 presents the structure of a 3-phase 400V islanded microgrid, which includes six WT, four PV inverters, a DG, and a lead-acid battery set, to supply critical and non-critical loads.

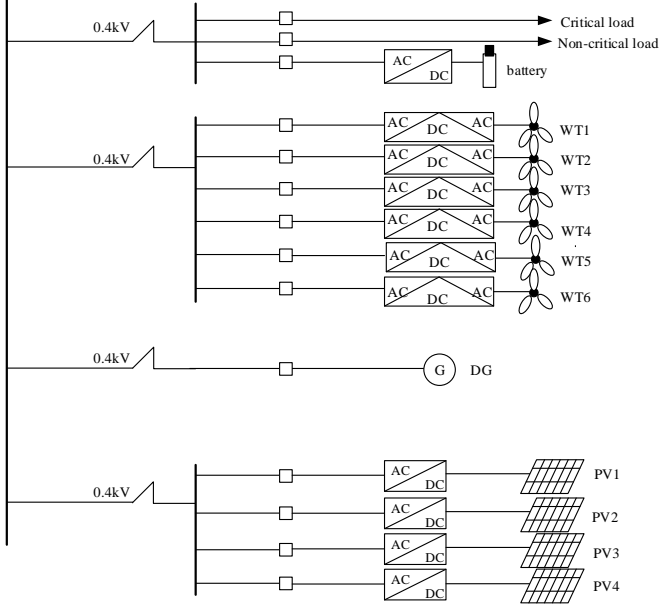

Fig. 1. Islanded microgrid structure.

### A. Objective functions of day-ahead scheduling

Day-ahead scheduling is an overall time-step method that can be used to dispatch the output power of each generation unit in a microgrid, which divides the future day into 24 time periods, 1 hour each time period, and plans in advance the output power of each generation unit in 24 time periods. Two goals are considered: 1) minimize the operational; 2) to meet the load supply as much as possible, that is, maximize load demand satisfaction. The total cost function includes the operation costs of each generation unit, the lack of compensation and the loss caused by the load shifting. The operational cost of the microgrid is expressed follows:

$$\min(COST_{\text{sum}}) = \min(COST_{\text{invest}} + COST_{\text{PV}} + COST_{\text{WT}} + COST_{\text{DG}} + COST_{\text{bat}} + COST_{\text{Loss}} + COST_{\text{T-load}}) \quad (1)$$

where  $COST_{\text{invest}}$  represents a fixed investment of each generation unit converted to per day;  $COST_{\text{PV}}$  is the PV maintenance cost of per day, expressed as:

$$COST_{\text{PV}} = \sum_{i=1}^{24} P_{\text{PV}}(i) \cdot M_2 \quad (2)$$

where,

$P_{\text{PV}}(i)$  is the actual output power of PV of per hour,

$M_2$  is the maintenance cost coefficient of per kW of PV.

In (1),  $COST_{\text{WT}}$  is the WT maintenance cost of per day, expressed as:

$$COST_{\text{WT}} = \sum_{i=1}^{24} P_{\text{WT}}(i) \cdot M_1 \quad (3)$$

where,

$P_{\text{WT}}(i)$  is the actual output power of WT of per hour,

$M_1$  is the maintenance cost coefficient of per kW of WT.

The total cost of the DG is the sum of the fuel costs, efficiency costs, maintenance costs, and environmental costs. The cost function of the DG is shown in the following equation:

$$COST_{\text{DG}} = \sum_{i=1}^{24} P_{\text{DG}}(i) \cdot (M_3 + E_3) + \sum_{i=1}^{24} (k_1 P_{\text{DG}}(i) + k_2 P_{\text{DG-rated}}) \quad (4)$$

where,

$COST_{\text{DG}}$  is the DG operation cost of per day,

$P_{\text{DG}}(i)$  is the actual output power of DG of per hour,

$M_3$  is the maintenance cost coefficient of per kW of DG,

$E_3$  is the environmental cost coefficient of per kW of DG,

$P_{\text{DG-rated}}$  is the rated power of DG,

$k_1$  and  $k_2$  are correlation coefficient.

The values of  $k_1$  and  $k_2$  are related to DG efficiency. The efficiency characteristic versus different output power is as shown in Fig. 2. The maximum output power of DG cannot exceed the rated power, and the minimum output power will not be less than 30% of the rated power. If the output power is between 70% and 100% of the rated power, the DG operates in the high efficient area. If the output power is between 30% and 70% of the rated power, the DG operates in low efficient area. In different efficient areas, the DG efficiency cost is not same, namely  $k_1$  and  $k_2$  take different values.

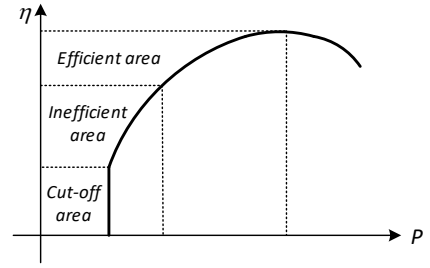

Fig. 2. Efficiency characteristics of DG.

The battery costs include operation losses costs and maintenance costs, and the initial investment costs of the battery are converted to operational losses per discharge. Battery charge and discharge cycle efficiency is 90%. The cost function of the battery is shown as:

$$COST_{\text{bat}} = \sum_{i=1}^{24} \beta P_{\text{bat}}(i) M_4 + g(\text{SoC}) \quad (5)$$

According to the lead-acid battery model, the operation cost  $g(\text{SoC})$  of its state of charge ( $\text{SoC}$ ) can be expressed as:

$$g(\text{SoC}) = \sum_{i=0}^{23} \int_{\text{SoC}_i}^{\text{SoC}_{i+1}} \lambda [308.66(\text{SoC})^3 - 473.55(\text{SoC})^2 - 129.54(\text{SoC}) + 307.99] d(\text{SoC}) \quad (6a)$$

Then, the next hour  $\text{SoC}$  estimation ( $\text{SoC}_{i+1}$ ) yields to:

$$\text{SoC}_{i+1} = \text{SoC}_i + \alpha \frac{P_{\text{bat}}(i+1)/90\%}{96} + (1-\alpha) \frac{P_{\text{bat}}(i+1)*90\%}{96} \quad (6b)$$

where,

$COST_{\text{bat}}$  is the battery operation cost of per day,

$P_{\text{bat}}(i)$  is the actual output power of the battery of per hour,

$M_4$  is the maintenance cost coefficient of per kW of the

battery,  
 $SoC_i$  is the state of charge of per hour,  
 $g(SoC)$  is the cost of operation loss.

Parameters  $\alpha$  and  $\beta$  are set as the following:

if  $P_{bat} > 0$ ,  $\alpha=0$  and  $\beta=0$ ; if  $P_{bat} < 0$ ,  $\alpha=1$  and  $\beta=-1$ .

That means the charging process is free of losses and we must consider the operation loss of the discharging process. So that,

if  $SoC_i \geq SoC_{i+1}$ ,  $\lambda = -1$ ; if  $SoC_i < SoC_{i+1}$ ,  $\lambda = 0$ .

The compensation cost caused by the electricity shortage is shown by the following equation:

$$COST_{LOSS} = A \frac{W_{LOSS}^2}{W_R} + BW_{LOSS} \quad (7)$$

where,

$COST_{LOSS}$  is the compensation cost caused by the electricity shortage;

$W_T = W_c + W_n$ ,  $W_T$  is the total electricity demand;  $W_n$  is the electricity of the non-critical load;  $W_c$  is the electricity of the critical load;

$W_{LOSS}$  is the difference between the total demand and the actual supply.

$A$  and  $B$  are the penalty coefficient caused by the electricity shortage.

The penalty function caused by load shifting is shown in equation:

$$COST_{T-Load} = CP_T^2 + DP_T \quad (8)$$

where,

$COST_{T-Load}$  represents the penalty function caused by load shifting,

$P_T$  is the switched load power,  $C$  and  $D$  are the penalty coefficient caused by the load shifting.

## B. Constraints

1) Power balance function is shown in inequality equation

$$P_c(i) \leq P_{WT}(i) + P_{PV}(i) + P_{DG}(i) - P_{bat}(i) \leq P_T(i) \quad (9)$$

where,  $P_c(i)$  is the average power of the critical load per hour,  $P_T(i)$  is the average power of the total load per hour.

The output generation power of every hour is less than the total load power, greater than or equal to the critical load power.

2) Energy balance function is shown in the following inequality:

$$W_c \leq W_{WT} + W_{PV} + W_{DG} - W_{bat} \leq W_T \quad (10)$$

where,

$W_{WT}$  is the output energy of WTs,

$W_{PV}$  is the output energy of PVs,

$W_{DG}$  is the output energy of DG,

$W_{bat}$  is the output energy of batteries.

## 3) Variable Boundaries

The PV power is bounded by the following expressions:

$$0 \leq P_{PV}(i) \leq P_{PVmp}(i) \quad (11)$$

$$P_{PVmp}(i) = P_{STC} G_{AC}(i) [1 + k(T_c(i) - T_r)] / G_{STC} \quad (12)$$

where,

$P_{PVmp}(i)$  is the maximum output power of PV of per hour,

$P_{STC}$  is the maximum power under the standard test conditions (the irradiation is  $1\text{kW/m}^2$  and the ambient temperature  $298.15\text{K}$ ),

$G_{AC}(i)$  is the average irradiation of per hour,

$G_{STC}$  is the irradiation under standard test conditions and its value is  $1\text{kW/m}^2$ ,

$k$  is the power-temperature coefficient and its value is  $-0.0047/\text{K}$ ,

$T_c(i)$  is the actual average temperature of the PV array of per hour,

$T_r$  is the reference temperature and its value is  $298.15\text{K}$ .

The wind power generation provided by the WT is bounded as follows:

$$0 \leq P_{WT}(i) \leq P_{WTmax}(i) \quad (13)$$

being,

$$P_{WTmp}(i) = \begin{cases} 0 & v(i) \leq v_{ci} \\ av(i)^3 - bP_r & v_{ci} < v(i) \leq v_r \\ P_r & v_r < v(i) \leq v_{co} \\ 0 & v(i) > v_{co} \end{cases} \quad (14)$$

where,  $P_{WTmax}(i)$  is the maximum output power of WT of per hour,  $v_{ci}$  is the cut-in wind speed, m/s;  $v_{co}$  is the cut-off wind speed in m/s;  $v_r$  is the rated wind speed, m/s;  $P_r$  is the rated output power of WT, kW; and  $a = P_r / (v_r^3 - v_{ci}^3)$ ,  $b = v_{ci}^3 / (v_r^3 - v_{ci}^3)$ .

The power generated by the DG is bounded as follows:

$$0.3P_{DG-rated} \leq P_{DG}(i) \leq P_{DG-rated} \quad \text{or} \quad P_{DG} = 0 \quad (15)$$

where  $P_{DG-rated}$  is the rated power of DG.

Finally, the charge/discharge power of the battery and the SoC are bounded by the following inequalities:

$$-P_{min} \leq P_{bat}(i) \leq P_{max} \quad (16)$$

$$0.4 < SoC < 1 \quad (17)$$

where  $P_{min}$  is the maximum discharging power of the battery, and  $P_{max}$  is the maximum charging power of the battery.

## III. OBJECTIVE FUNCTIONS OF SHORT-TIME SCHEDULING AND CONSTRAINTS

### A. Objective functions of short-time scheduling

Short-term scheduling is also overall time-step optimization method. The next one hour is divided into four time periods, each time period 15 minutes, and plans the output power of each generation unit of 4 time periods in advance. The objective functions are the minimum amount of adjustment for the day-ahead scheduling and prioritizing the use of renewable energy shown as follows.

$$\min(\Delta P) = \min(\Delta P_{wt} + \Delta P_{pv} + \Delta P_{DG} + \Delta P_{bat}) \quad (18)$$

The output power adjustment of each generation unit is expressed by the following equations:

$$\Delta P = m |P_{ave} - P_D| + n \cdot \frac{1}{4} \sum_{i=1}^4 |P_s(i) - P_D| \quad (19)$$

$$P_{ave} = \frac{1}{4} \sum_{i=1}^4 P_s(i) \quad (20)$$

where,

$P_{ave}$  is the average output power of each generation unit of per hour,

$P_D$  is the output power of the day-ahead scheduling of per hour,

$m$  and  $n$  are correlation coefficients,

$P_s(i)$  is the output power of each generation unit of per 15mins.

## B. Constraints

1) Power balance function is represented by the following inequality:

$$P_{c15}(i) \leq P_{WT15}(i) + P_{PV15}(i) + P_{DG15}(i) - P_{bat15}(i) \leq P_{T15}(i) \quad (21)$$

where,

$P_{c15}(i)$  is the average power of the critical load per 15m,

$P_{T15}(i)$  is the average power of the total load per 15m,

$P_{WT15}(i)$  is the output power of WTs of per 15m,

$P_{PV15}(i)$  is the output power of PVs of per 15m,

$P_{DG15}(i)$  is the output power of the DG of per 15m,

$P_{bat15}(i)$  is the output power of batteries of per 15m.

Note that the variable boundaries are same for the day-ahead scheduling.

## IV. SCHEDULING RESULTS

The cut-in, rated, and cut-off wind speed and the rated power of six sets of WTs is shown in Table I. The rated power of four sets of PVs is shown in Table II. The parameters of the scheduling model are shown in Table III. The total capacity of lead-acid battery is 96kW · h.

TABLE I. WTs PARAMETERS

WT	#1	#2	#3	#4	#5	#6	Total
$V_{ci}$ (m/s)	4	4	3	3	3	3	—
$V_r$ (m/s)	12	12	10	10	8	8	—
$V_{co}$ (m/s)	24	24	25	24	20	20	—
$P_{iWT}$ (kW)	10	10	8	8	7	7	50

TABLE II. PVs PARAMETERS

PV	#1	#2	#3	#4	Total
$P_{iPV}$ (kW)	12	10	8	10	40

TABLE III. PARAMETERS OF THE SCHEDULING MODEL

Parameter	Value
Irradiation under standard conditions, $G_{STC}/(kW/m^2)$	1
Power-temperature coefficient, $k/K^{-1}$	-0.0047

Reference temperature of PV, $T_r/K$	298.15
Maintenance cost coefficient of per kW of WT, $M_1$	0.0296
Maintenance cost coefficient of per kW of PV, $M_2$	0.0096
Maintenance cost coefficient of per kW of DG, $M_3$	0.0946
Maintenance cost coefficient of per kW of the battery, $M_4$	0.0832
Environmental cost coefficient of per kW of DG, $E_3$	0.0441
Penalty coefficient caused by the power shortage, A, B	10, 0.5
Penalty coefficient caused by the load shifting, C, D	0.1, 0.5
Correlation coefficients, m, n	0.9, 0.1
Correlation coefficient of battery charging $\alpha, \beta, \lambda$	0, 0, 0
Correlation coefficient of battery discharge $\alpha, \beta, \lambda$	1, -1, -1
Coefficient of efficient operation of DG $k_1, k_2$	0.5217, 1.5252
Coefficient of low efficiency operation of DG $k_1, k_2$	0.6379, 1.8649
The initial capacity $SoC_0$ of the battery	0.6

## A. Case Study 1

The forecasting temperature and irradiation of the next day are shown in Fig. 3. The forecasting wind speed of the next day is shown in Fig. 4.

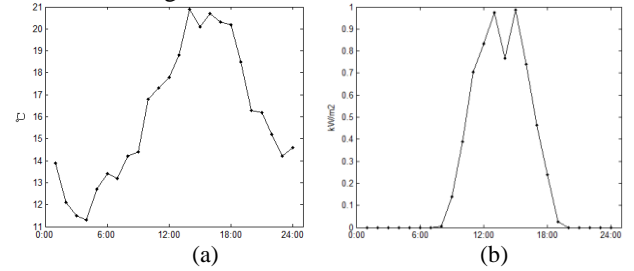

Fig.3. Day ahead forecasting: (a) temperature and (b) solar irradiation

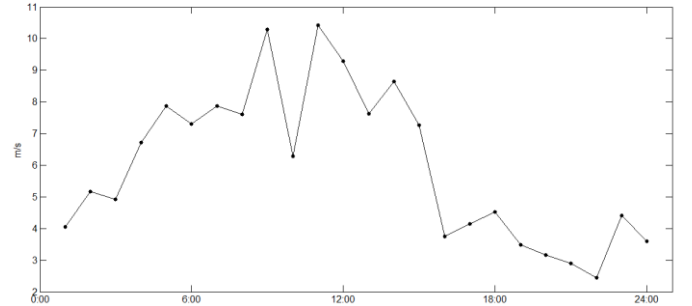

Fig. 4. Day ahead forecasting wind speed.

The optimization results of day-ahead scheduling are shown in Table IV. The load electricity supply is shown in the Fig. 5. The load power shifting is shown in the Fig. 6. The output power of the DG in 24 hours a day is shown in Fig. 7. From the above simulation results we can notice that:

(1) The actual output power is always between the critical load and the total load, that is, the critical load power is met. If the generation power is not sufficient, the non-critical load can be shed.

(2) From 8:00 to 11:00, the PVs and WTs generation cannot meet the load demand and the battery operation costs is lower than the DG, so we give priority to the use of battery. From 20:00 to 24:00, the  $SoC$  of the battery is close to the minimum, the DG provides the electricity and the operation cost increases.

(3) From 19:00 to 20:00, due to the effect of the load shifting, the operation cost is reduced.

TABLE IV. OPTIMIZATION RESULTS OF DAY-AHEAD SCHEDULING

Time	WT (kW)	PV (kW)	DG (kW)	Battery (kW)	Actual output (kW)	Cost per hour (RMB)
0:00-1:00	1.6	0	28	0	29.6	86.3
1:00-2:00	5.6	0	0	-13.6	19.2	48.3
2:00-3:00	4.6	0	21	0	25.6	81.7
3:00-4:00	15	0	0	1.2	13.8	22.2
4:00-5:00	25.8	0	0	14.3	11.5	22.6
5:00-6:00	20	0	0	8.9	11.1	22.3
6:00-7:00	25.6	0	0	6.7	18.9	22.5
7:00-8:00	22.8	0	0	-8.1	30.9	32.5
8:00-9:00	42.2	5.6	0	-10.8	58.6	42.4
9:00-10:00	12	16	0	-6.0	34.0	35.9
10:00-11:00	42.8	28.9	0	-3.9	75.6	55.7
11:00-12:00	35.4	34.4	0	0	69.8	36.1
12:00-13:00	23.2	40	0	0	63.2	26.1
13:00-14:00	31	31.1	0	1.9	60.2	22.9
14:00-15:00	19.8	40.1	21	0.4	80.5	82.3
15:00-16:00	1	30.	30	0.1	60.9	87.6
16:00-17:00	1.8	18.7	28	0.2	48.3	86.2
17:00-18:00	3	9.6	30	-2.1	44.7	96.6
18:00-19:00	0.6	0.9	30	0	31.5	99.6
19:00-20:00	0	0	30	0	30.0	87.3
20:00-21:00	0	0	30	0	30.0	87.3
21:00-22:00	0	0	30	0	30.0	87.3
22:00-23:00	2.6	0	30	0	32.6	87.4
23:00-24:00	0.6	0	29	0.1	29.5	86.7

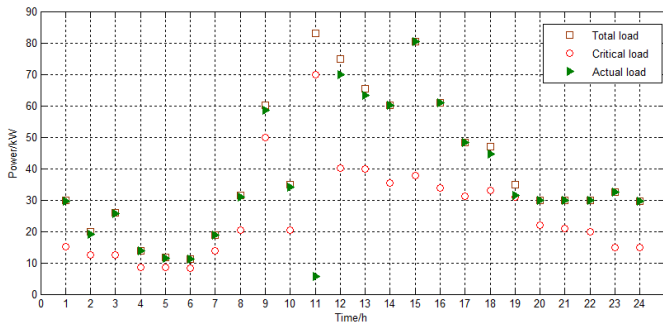

Fig.5. Load electricity supply.

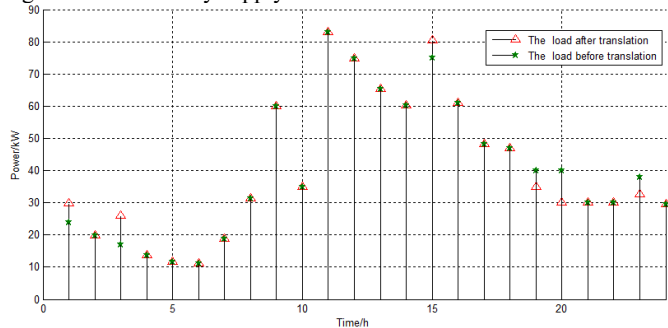

Fig.6. Shifting loads.

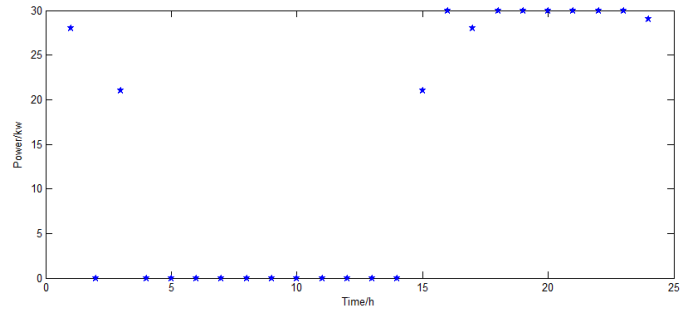

Fig.7. DG output power in 24 hours of a day.

## B. Case Study 2

The short-term scheduling result is shown in Fig. 8. A 15 minutes period forecasting of wind speed, solar irradiation, and load power is used. It can be seen from Fig. 8, short-term scheduling can further optimize the day-ahead results, and at the same time can achieve the minimum amount of adjustment with the day-ahead scheduling and to meet the load demand. In addition, high priority is given to the use of renewable energy resources.

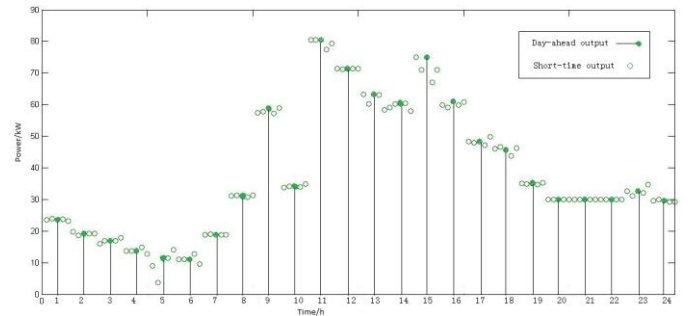

Fig. 8. Short-term scheduling results.

## V. CONCLUSION

A two time-scale optimization scheduling of the day-ahead and short-time applied to islanded microgrids was presented in this paper. The minimum operation cost and maximum load supply satisfaction were included into the objective function of the day-ahead scheduling, considering the compensation caused by electricity shortage. Thus a proper load power supply plan can be achieved. Further, a load shifting plan was also proposed to select a reasonable power consumption. The proposed approach can not only reduce the microgrid operational cost, but also increase the use the renewable energy resources.

The minimum adjustment of the day-ahead scheduling and priority for the use of renewable energy are the objective functions of the short-term scheduling. However, due to the short-time forecast data may be different from the day-ahead, the output power of each generation unit of the microgrid may be adjusted according to the actual situations. The combination of day-ahead and short-term scheduling can improve the reliability of power supply, thus increasing the utilization rate of renewable generation units, and reducing the influence of renewable energy output fluctuations on the operation of an islanded microgrid.

## ACKNOWLEDGEMENT

This work was supported by the Tianjin Science and Technology Support Program Key Project and National Natural Science Foundation of China (15JCZDJC32100, 17JCZDJC31300 and 51577124).

## REFERENCES

- [1] LU Zong-xiang, WANG Cai-xia, MIN Yong, *et al.* "Review on microgrid research," *Automation of Electric Power Systems*, 2007,19: 100-107.
- [2] Ding Ming, Zhang Yingyuan, Mao Meiqin, *et al.* "Economic optimization of micro-network system with energy storage of sodium-sulfur battery," *Proceeding of the CSEE*, 2011, 04, pp. 7-14.
- [3] Zhang Jianhua, Su Ling, Chen Yong, *et al.* "Energy management and control strategy of microgrid," *Power System Technology*, 2011,07, pp. 24-28.
- [4] Niu Huanna, Huang Xiuqiong, Yang Rengang, *et al.* "Research and design of functional architecture system of microgrid energy management system," *Renewable Energy Resource*, 2013, 31(6), pp. 47-51.
- [5] Qu Chaojie. "Independent New Energy Microgrid Energy Management System Design and Implementation," PhD Dissertation. Hunan University, 2012.
- [6] S. Drouilhet, B. L. Johnson, "A battery life prediction method for hybrid power applications," *AIAA Aerospace Sciences Meeting and Exhibit*, 1997.
- [7] Lu Jing, Zhai Haiqing, Liu Chun, *et al.* "Research on statistical methods of photovoltaic power generation forecast," *East China Electric Power*, 2010,38 (4), pp. 563-567.
- [8] J. Schiffer, *et al.* "Model prediction for ranking lead-acid batteries according to expected lifetime in renewable energy systems and autonomous power-supply systems," *Journal of Power sources*, 2007, 168.1: 66-78.
- [9] R. h. Lasseter, "Microgrids and distributed generation," *Journal of Energy Engineering*, 133.3, 2007, pp. 144-149.
- [10] A. G. Tsikalakis, N. D. Hatzargyriou, "Centralized Control for Optimizing Microgrids Operation," In Proc. *IEEE Power and Energy Society General Meeting*, San Diego, 2011, pp. 1-8.
- [11] Faisal A. Mohamed, Heikki N. Koivo, "Online Management of Micro Grid with Battery Storage Using Multi objective Optimization," *International Conference on Power Engineering, Energy and Electrical Drives*, Setubal, 2007, pp. 231-236.
- [12] T. Som, S. Raha, N. Chakraborty, "Economic Assessment of Indian Distributed Power Delivery System by Hybrid Genetic-Simulated Annealing Technique," *International Conference on Sustainable Energy and Intelligent Systems (SEISCON 2011)*, Chennai, 2011, pp. 12-17.
- [13] Xu Dongdong. *Micro-grid multi-time scale optimization algorithm*. PhD Dissertation. South China University of Technology, 2015.
- [14] Hong Bowen, Guo Li, Wang Chengshan, *et al.* "Micro-grid multi-objective dynamic optimization scheduling model and method," *Power Automation Equipment*, 2013,03, pp. 100-107.
- [15] F. Katiraci, *et al.* "Microgrids management," *IEEE power and energy magazine*, 2008, 6.3.
- [16] E. Barklund, *et al.* "Energy management in autonomous microgrid using stability-constrained droop control of inverters," *IEEE Transactions on Power Electronics*, 2008, 23.5: 2346-2352.