



**Aalborg Universitet**

**AALBORG UNIVERSITY**  
DENMARK

## **Coordinated Control of Multifunctional Inverters for Voltage Support and Harmonic Compensation in a Grid-Connected Microgrid**

Mousazadeh, Seyyed Yousef ; Jalilian, Alireza; Savaghebi, Mehdi; Guerrero, Josep M.

*Published in:*  
Electric Power Systems Research

*DOI (link to publication from Publisher):*  
[10.1016/j.epsr.2017.10.016](https://doi.org/10.1016/j.epsr.2017.10.016)

*Publication date:*  
2018

*Document Version*  
Early version, also known as pre-print

[Link to publication from Aalborg University](#)

*Citation for published version (APA):*

Mousazadeh, S. Y., Jalilian, A., Savaghebi, M., & Guerrero, J. M. (2018). Coordinated Control of Multifunctional Inverters for Voltage Support and Harmonic Compensation in a Grid-Connected Microgrid. *Electric Power Systems Research*, 155, 254-264. <https://doi.org/10.1016/j.epsr.2017.10.016>

### **General rights**

Copyright and moral rights for the publications made accessible in the public portal are retained by the authors and/or other copyright owners and it is a condition of accessing publications that users recognise and abide by the legal requirements associated with these rights.

- ? Users may download and print one copy of any publication from the public portal for the purpose of private study or research.
- ? You may not further distribute the material or use it for any profit-making activity or commercial gain
- ? You may freely distribute the URL identifying the publication in the public portal ?

### **Take down policy**

If you believe that this document breaches copyright please contact us at [vbn@aub.aau.dk](mailto:vbn@aub.aau.dk) providing details, and we will remove access to the work immediately and investigate your claim.

# Coordinated Control of Multifunctional Inverters for Voltage Support and Harmonic Compensation In a Grid-Connected Microgrid

Seyyed Yousef Mousazadeh Mousavi <sup>a</sup>, Alireza Jalilian <sup>a,b</sup> (Corresponding author),

Mehdi Savaghebi<sup>c</sup>, and Josep M. Guerrero<sup>c</sup>

[s\\_y\\_mosazade@iust.ac.ir](mailto:s_y_mosazade@iust.ac.ir), [jalilian@iust.ac.ir](mailto:jalilian@iust.ac.ir), [mes@et.aau.dk](mailto:mes@et.aau.dk), [joz@et.aau.dk](mailto:joz@et.aau.dk)

<sup>a</sup> School of Electrical Engineering, Iran University of Science and Technology

<sup>b</sup> Center of Excellence for Power System Automation and Operation, Iran University of Science and Technology

<sup>c</sup> Department of Energy Technology, Aalborg University, Denmark

*Abstract: In this paper, a coordinated harmonic compensation and voltage support scheme is presented for distributed generations' (DGs') interface inverters in a resistive grid-connected microgrid. Voltage support is performed by reactive power compensation which can mitigate the over/under voltage problem; furthermore, the active power curtailment is proposed in order to mitigate the overvoltage problem when the reactive power compensation is not sufficient. Harmonic compensation is achieved by using virtual admittances in selected harmonic frequencies. Reactive power and harmonic compensation currents are injected with regards to the limited capacity of the interface inverter. If necessary, the reference powers of the grid-tied inverters are changed. Voltage support and harmonic compensation can be achieved based on local or central (communication-based) measurement schemes. The effect of communication delay is also investigated in this study. Experimental and simulation results are obtained in order to demonstrate the effectiveness of the proposed method.*

**Keyword:** distributed generation; harmonics compensation; DG interfacing inverter; reactive power compensation.

## 1. Introduction

Voltage Source Inverters (VSIs) are widely used for interfacing Distributed Generation (DG) systems to the grid [1]. The DG interfacing inverters can contribute in voltage support [2-13] and harmonic compensation [12-21] of Microgrids (MGs) and utility grids. These inverters known as multifunctional inverters inject power to the grid and the remaining capacity of the inverter can be dedicated to voltage support and power quality enhancement [10].

To fully comprehend the voltage support of the DG interfacing inverters, reactive power compensation is conventionally proposed in distribution systems [2]-[7], [11], [12] and MGs [8]-[10] in order to mitigate the over/under voltage problems. Overvoltage can be created because of high penetration of Wind Turbine (WT) and Photovoltaic (PV) systems [2]. In [2] and [3], the voltage rise problem caused by high penetration of DGs in an LV distribution system has been studied and a droop-based reactive power control is proposed for Current Controlled Mode (CCM) of VSIs. In these papers, the reactive power compensation by DGs interfacing inverters is considered. In [4] and [5], the voltage rise mitigation based on active power curtailment in distributed systems has been proposed. The power curtailment algorithms of [4] and [5] are based on local measurement and communication system, respectively. In [6], different reactive power methods for DG units are studied. The reactive power control approaches in [6] can be classified into distributed and central controller based schemes. The reactive power control of DG interfacing inverters is also studied in [7]. In this paper, only a grid-connected interfacing inverter is

considered whereas in grid-tied MGs more DG units can exist while a coordinated control of the units is required. In [8] and [9], voltage and frequency support functions of utility scale PV systems have been proposed. In [8], the performance of a PV system in voltage sag/ swell compensation is evaluated based on the small signal modeling of utility scale PV and power system. In addition, the frequency support is added in [9]. In [10] and [11], the voltage support by Voltage Control Mode (VCM) VSIs in a grid-connected MG has been discussed, while, while it is obvious that, PV and WT systems are integrated as CCM VSIs.

On the other hand, use of DGs interface inverters for compensation of harmonics has been proposed in [12]-[22]. The harmonic compensation can be achieved based on communication systems and a central controller [12]-[17] or local measurement [18]-[22]. In the communication-based compensation, the data which is used for harmonic compensation is obtained by central controller or measurement whereas in the local compensation; the compensation is achieved without any need for communication systems. In central controller based methods, the compensation can be performed more exactly and more effectively whereas the reliability of the system is decreased and the cost and complexity of the system are increased. The method of [15] is based on central measurement of Point of Common Coupling (PCC) voltage in a grid-connected MG. In [15], the harmonic compensation is achieved by central measurement and using VCM VSIs with decentralized controller. In other words, inverters are controlled locally based on the information received from a remote bus. However, in grid-connected MGs, the interfacing VSIs of PV and WT units operate in CCM and their remaining capacity of them (which can be dedicated to harmonic compensation) changes during a day because of the maximum power point variation. The limited capacity of the inverters is not considered in [15] and the

communication system failure can deactivate the harmonics compensation.

Using capacitive virtual impedance which can compensate the harmonic voltage drops of lines and filter impedances has been recommended as a local compensation for VCM VSIs in [18]-[20]. Using virtual admittance is recommended for the harmonic compensation by CCM VSIs in distribution system [21] and VCM VSIs in a grid-connected MG [22]. In [21] and [22], the control of grid-tied VCM VSI is done by using a fixed value of virtual admittance and local measurement.

In the present paper, a coordinated harmonic compensation and voltage support method are proposed for CCM VSIs in a grid-tied MG. A weak MG with high resistance is chosen as a case study. A voltage support approach with local and central measurement of PCC voltage is proposed in this paper. The voltage support algorithm can mitigate under/over voltage problems of the grid-tied MG by using reactive power control with considering the limited capacity of the inverters; Furthermore, a power curtailment algorithm is proposed in order to mitigate voltage rise problem when the reactive power compensation is not sufficient. The voltage support algorithm is flexible in using central or local measurement of voltage. In addition, a harmonic mitigation method is proposed based on the virtual admittance which has also the flexibility for changing from central measurement to local measurement when the communication system failure happens or the delay of the communication system is too high.

The main contributions of the paper are listed below:

- A coordinated control of CCM VSIs for harmonic compensation and reactive power sharing/support.
- Considering the limited capacity of the inverter in harmonic and reactive power

compensation.

- Voltage rise mitigation by using reactive power control and power curtailment of the DG interfacing inverters.
- Flexibility for choosing the local or remote (central) measurement
- Considering the effect of communication system delay on power quality improvement.

Rest of the paper is presented as follows; Section 2 is focused on the general scheme of the system under study. Section 3 describes the details of the control system. Afterwards, simulation and experimental results are presented in Section 4. Finally, the paper is concluded in Section 5.

## **2. General Scheme of the system**

Fig. 1 shows the general overview of the grid-connected MG. As shown in this figure, each CCM VSI ( $DG_n$ ) which can be considered as interfacing inverter of PV or WT unit is connected to the PCC via impedance ( $Z_{Ln}$ ). The line impedances are considered resistive in order to simulate the distribution system lines. The MG is connected through a line and a transformer with impedances represented by  $Z_G$  and  $Z_T$ , respectively. The voltage of PCC bus is measured and the harmonics extraction is achieved using  $dq$  transformation. In order to increase the reliability of the communication system, low bandwidth communication (LBC) system is used; hence, the transmitted data should be in DC, as the results of the applied extraction method are DC values in  $dq$  synchronous reference frame. The details of PCC fundamental and harmonics extraction can be found in [15]. The fundamental and harmonic transmitted data are fed to each DG local controller for voltage support and harmonic compensation, respectively.

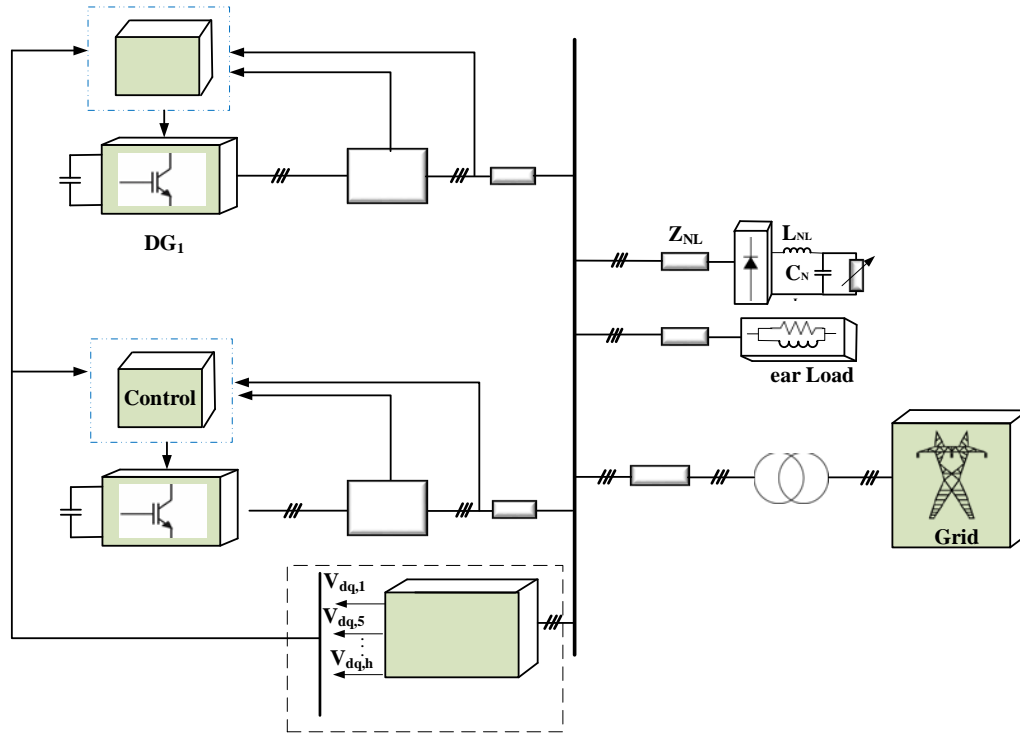

Fig. 1. General overview of the system

### 3. Control approach for DG interface inverter

Fig. 2 shows the control block of DG interfacing inverter. As mentioned before, the DG interfacing inverters are connected to the MG by using an LCL filter. Harmonic resonance problem can inherently endanger the stability of the system due to the use of LCL filter [23]. Different active and passive methods have been proposed by researchers to solve the resonance problem [24], [25]. In this paper, capacitor current feedback is used for damping the resonance (see  $K_D$  in Fig. 2). In this control scheme, multi-loop control scheme is used for controlling the injected current of the VSI. The reference power is tracked by the outer loop whereas the stability improvement and resonance damping are carried out through the inner loop [24].

In the outer control loop, Proportional Resonant (PR) controllers which are tuned at fundamental, 5<sup>th</sup>, 7<sup>th</sup> and 11<sup>th</sup> harmonics orders are used. The output voltage of LCL filter

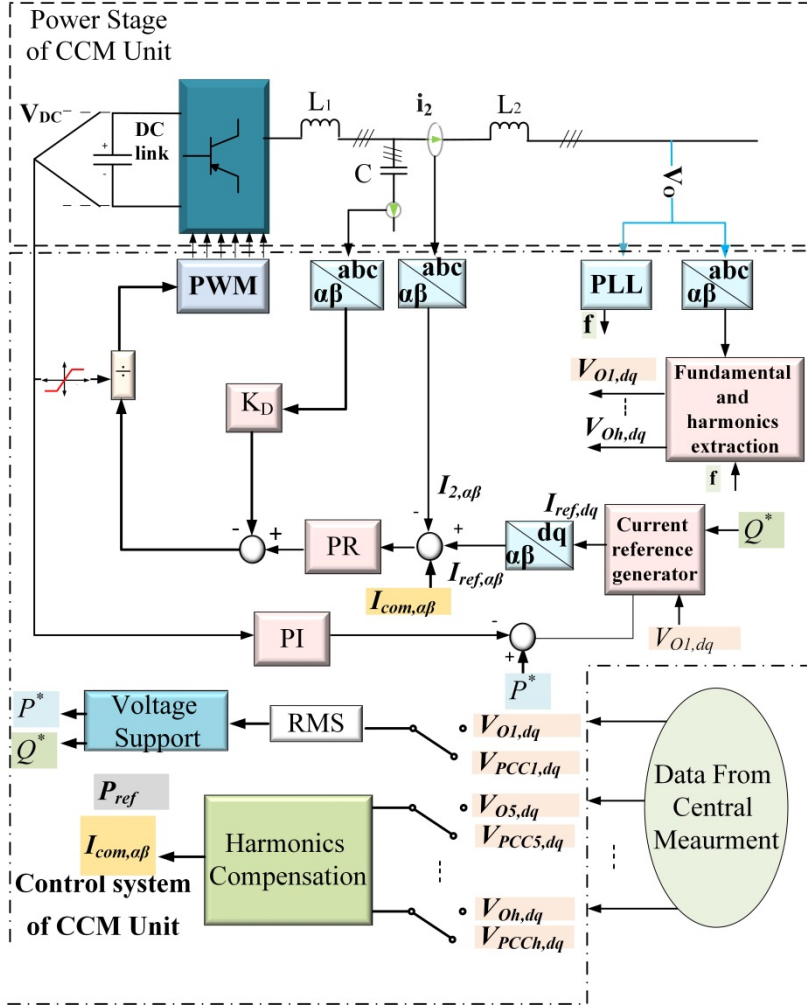

Fig. 2. Power and control stage of DG interfacing inverter

( $V_o$ ) is used as a feedback. Since this point is closer to the PCC than the filter capacitor, controlling its voltage provides a better voltage quality at PCC [16].

As depicted in Fig. 2, and mentioned before, fundamental component and harmonic orders of PCC voltage are extracted in  $dq$  frame ( $V_{PCC1,dq}$ ,  $V_{PCC5,dq}$ ,  $V_{PCC7,dq}$  and  $V_{PCC11,dq}$ ) and transmitted via the communication system as data from central measurement. However, the local measurements ( $V_{O1,dq}$ ,  $V_{O5,dq}$ ,  $V_{O7,dq}$  and  $V_{O11,dq}$ ) can be used if the communication system has a failure or long time delay. Hence, this flexibility can increase the reliability of the system.



In Fig.2,  $P_{ref}$  is the active power that can be injected to the grid. The reference active and reactive powers ( $P^*$  and  $Q^*$ ) and the reference harmonic compensation current ( $I_{com,\alpha\beta}$ ) are generated by voltage support and harmonics compensation blocks, respectively. After calculation of the reference of active and reactive powers ( $P^*$  and  $Q^*$ ), the fundamental current reference in  $dq$  frame ( $I_{ref,dq}$ ) is generated by (1) [26]. Generally DC voltage feedback is used in order to fix the DC bus voltage [26]. Since in this paper, the focus is on the inverter control, a constant DC voltage source is assumed; thus, the DC voltage feedback does not work. In order to prevent of any misunderstanding, the feedback is not considered in this equation:

$$\begin{bmatrix} I_{ref,d} \\ I_{ref,q} \end{bmatrix} = \begin{bmatrix} V_{O1,d} & V_{O1,q} \\ -V_{O1,q} & V_{O1,d} \end{bmatrix}^{-1} \begin{bmatrix} P^* \\ Q^* \end{bmatrix} \quad (1)$$

Division of the DC bus voltage which is applied before PWM block can isolate the tuning of the controller against the DC voltage changes. However, during the startup, since the amount of DC voltage is low, the division to DC voltage can cause a large gain which can lead to instability. In this paper, the measured DC voltage passes through a saturation block whose minimum and maximum values are defined as  $0.9 V_{DC,N}$  and  $1.1 V_{DC,N}$  (where  $V_{DC,N}$  represents the nominal value of  $V_{DC}$ )

#### **A. Voltage support function of the VSI interfacing inverter**

Reactive power control is conventionally used for voltage regulation in power systems. Incorporation of the free capacity of DGs inverters is considered as a potential for reactive power compensation and voltage support. Although IEEE 1547 standard [27] forbids the use of reactive power capability of inverter-based DGs for this purpose, this policy would be changed by increasing penetration of DG systems [28].

International Electrotechnical Commission (IEC) 61850-90-7 recommends advanced reactive functions and object models for power converter based Distributed Energy Resources (DERs) [29]. According to this standard, the DG units shall respond to the voltage variation in order to enhance the voltage profile of power system [30]. According to the standard and the method presented in [3], the reactive power compensation is implemented in this paper. For achieving this aim, the RMS of fundamental component of the measured voltage is compared to its reference value. Afterward, according to the voltage and the remaining capacity, the reference reactive power of the inverter is generated. The following criteria are utilized to compensate over/under voltage problems by the inverter according to IEC 61850-90-7 [3]:

$$Q^* = \begin{cases} Q_{max} & V < V_1 \\ Q_{max} - \frac{Q_{max}}{V_2 - V_1} (V - V_1) & V_1 \leq V \leq V_2 \\ 0 & V_2 \leq V \leq V_3 \\ -\frac{Q_{max}}{V_4 - V_3} (V - V_3) & V_3 \leq V \leq V_4 \\ -Q_{max} & V > V_4 \end{cases} \quad (2)$$

where  $V_1=0.9V_r$ ,  $V_2=0.95V_r$ ,  $V_3=1.025V_r$  and  $V_4=1.05V_r$ .  $V_r$  represents the rated voltage of the grid which is equal to 230V in this paper. The threshold values of  $V_1=0.9V_r$  and  $V_4=1.05V_r$  are determined according to IEEE 1159 standard as minimum and maximum allowable voltages, respectively [31]. According to IEEE 1547 standard, the maximum allowable voltage fluctuation caused by DG is set at 5%. Furthermore, it is compatible with U.S. grid code in which the normal operating range of a PV system is defined in the range of 0.95-1.05 p.u. while in extreme conditions the voltage range of 0.88-1.1 p.u. is defined [5]. However, the maximum value is more restricted than the EN 50160 European standard [32] in which the allowable voltage is in the range of 0.9-1.1 p.u. It should be mentioned

that in the above equation,  $Q_{max}$  represents the free capacity of the inverter for reactive power compensation which can be written as:

$$Q_{max} = \sqrt{S_r^2 - P^2} \quad (3)$$

Fig. 3 shows the reactive power compensation effort of DG interfacing inverter. As shown in this figure if the RMS value of the measured voltage ( $V$ ) is higher/lower than  $V_4/V_1$  (standard limitation), all of the capacity will be dedicated to voltage rise/ under voltage mitigation. The reactive power injection which changes linearly when  $V$  is in the range of  $V_1 \leq V \leq V_2$  or  $V_3 \leq V \leq V_4$ .

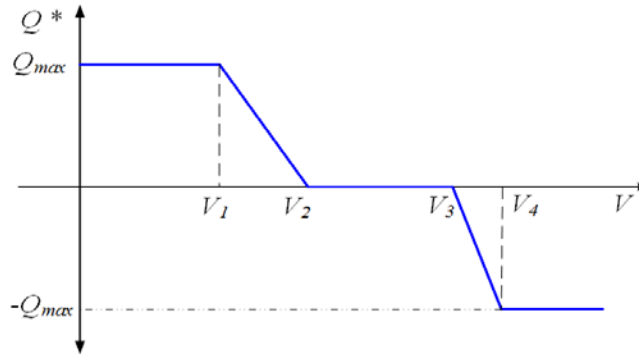

Fig.3- reactive power control of DG units

The method presented in [3] is only based on local measurements and the voltage rise mitigation is achieved by measuring the voltage of each DG. In this approach, since the different voltages may be measured by each DG in a distribution system, unfair reactive power compensation occurs between DGs. However, in the present paper, when central measurement is used, due to the fact that the PCC voltage information is sent to each DG, the same voltage is measured by DGs and the reactive compensation efforts of DGs are proportional to their capacities. If the communication system fails, the local control can undertake compensation; hence, the reactive power compensation will be active even a communication failure happens.

In [33], power curtailment approach has been recommended for PV systems in order to overcome the over frequency problem when the consumption is less than the production of DG units in an inductive islanded microgrid. However, in resistive systems, the voltage amplitude is depended on active power; hence, the power curtailment may mitigate the voltage rise problem [4], [5]. The presented method in [4] is based on local measurement and as mentioned before, this method can lead to unfair efforts of DGs due to the measurement of different voltages in each DGs terminal; Furthermore, measuring the PCC voltage can lead to proper reaction to voltage variation of PCC which is the aim of compensation. In the method of [5], a two-way communication system is required. In comparison to the methods which are proposed in [4] and [5], the proposed method in this paper has the flexibility in choosing central (remote) measurement by using only one-way communication system (from PCC to DGs) or local measurement when communication failure happens.

In case of over voltage, the reduction of active power can compensate it if the reactive power support is not sufficient. The following active power curtailment can be applied to the inverter.

$$P^* = \begin{cases} P_{ref} & V < V_5 \\ P_{ref} - K \cdot P_{ref} & V_5 \leq V \leq V_6 \end{cases} \quad (4)$$

where  $K$  is reduction coefficient which is defined as

$$K = \frac{V - V_5}{V_6 - V_5} \quad (5)$$

where  $V_5 = 1.05V_r$  and  $V_6 = 1.1V_r$ . This voltage rise mitigation approach is depicted in Fig. 4.

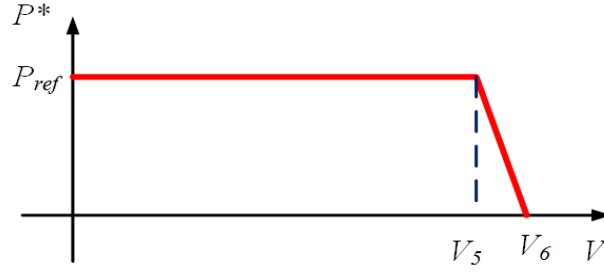

Fig. 4. Voltage rise mitigation by using power curtailment

In other words, firstly the reactive power compensation is applied to the inverters; afterwards the active power curtailment scenario will be utilized if the reactive power support is not sufficient.

#### B. Harmonics compensation

In this paper, the harmonic compensation function of DG units is also addressed. The harmonic compensation can either be performed based on PCC voltage measurement (central measurement) or local measurement (at the terminal of VSI LCL filter). Virtual admittance is used for harmonic compensation purpose. The limited capacity of the inverter is also considered in current harmonics compensation.

Fig. 5 shows the virtual admittance block. As shown in this figure, after harmonic extraction, individual harmonic indices ( $H_h$ ) are calculated by division of the RMS amount of each harmonic ( $V_{Oh}$ ) to the RMS fundamental component  $V_{O1}$ .

After comparison of  $H_h$  to its allowable amount ( $H_h^*$ ), a deadband block is used in order to prevent the controller to compensate harmonics when the value of  $H_h$  is lower than  $H_h^*$ . In other words, by using the deadband block the DG does not contribute in harmonics compensation when it is not required. Afterward, a proportional (P) controller is used to regulate controller, since the power curtailment is shared between different DG systems. In order to distribute harmonic compensation effort among DG units, the ratio of  $DG_i$  is rated

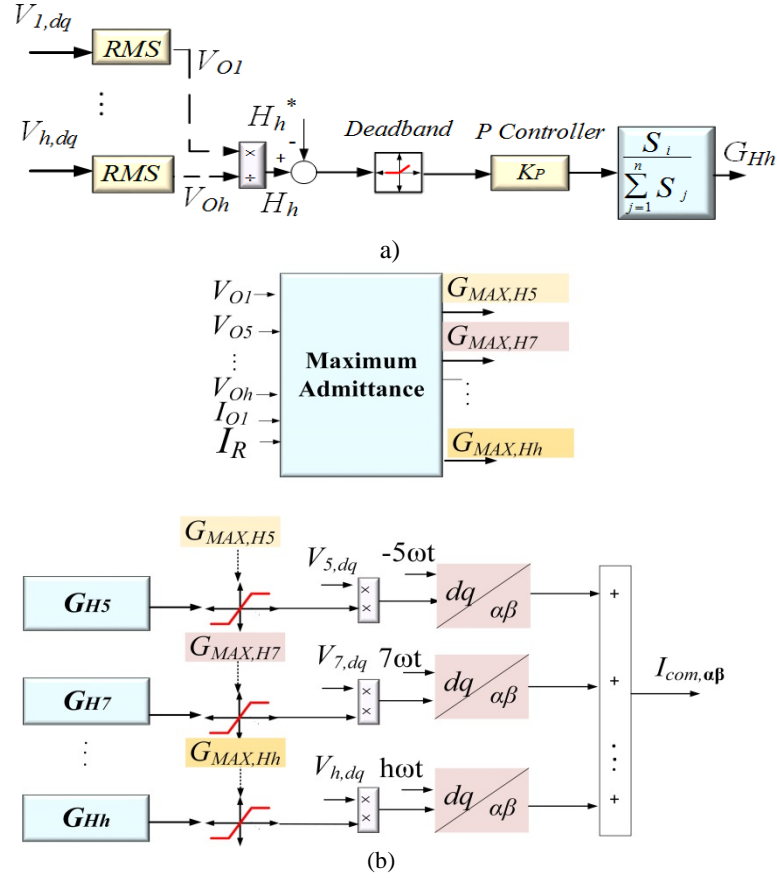

Fig. 5. Details of virtual admittance block of Fig 2; (a)  $G_{Hh}$  calculation block; (b) overall scheme

power and the total power of all MG DGs are used as a gain ( $S_i/\Sigma S_j$ ). By using the gain, the DGs with higher rated power contributes more in harmonic compensation.

Note that the  $H_h^*$  can be determined based on the sensitivity of the load to harmonics or grid codes and standards.

Fig. 5(b) shows the general overview of harmonic compensation block. The limited capacity of the inverter in harmonics compensation is considered by maximum admittance block. The maximum capacity of the inverter is calculated according to IEEE 1459 standard [34]. The maximum injectable harmonic current can be calculated as follows:

$$I_{H,\max} = \sqrt{I_R^2 - I_{0,1}^2} = \sqrt{G_{MAX,H5}^2 V_5^2 + G_{MAX,H7}^2 V_7^2 + \dots + G_{MAX,Hh}^2 V_h^2}$$

where  $I_R$  represents the RMS of rated current and  $I_{O,I}$  is the RMS of fundamental component of DG injected current. The calculated maximum values of virtual admittance are fed to the dynamic limiter blocks. Since (6) contains more than one unknown parameter, it is assumed that the values of maximum admittance for different frequencies are the same ( $G_{MAX, H5} = G_{MAX, H7} = \dots = G_{MAX, Hh}$ ); hence  $G_{MAX, Hh}$  can be written as

$$G_{MAX, Hh} = \frac{\sqrt{I_R^2 - I_1^2}}{V_{O1} \sqrt{H_5^2 + K_{G7,5}^2 H_7^2 + K_{G11,5}^2 H_{11}^2 + \dots + K_{Gh,5}^2 H_h^2}} \quad (7)$$

As shown in Fig. 3(b), the compensation current at  $h$  harmonic ( $I_{com,hdq}$ ) is calculated by multiplying the virtual admittance with corresponding voltage harmonic. Afterward, the compensation current in the  $dq$  frame is transformed to the  $\alpha\beta$  (stationary) frame. Finally, the compensation currents at different frequencies are added together to create the total compensation current ( $I_{com,\alpha\beta}$ ).

#### 4. Simulation and experimental results

The system shown in Fig. 1, with two inverter-based DGs is used as the case study. Each DG is connected to the PCC by using an LCL filters and a distribution line. PCC voltage measurement is implemented and fundamental and harmonics contents of PCC voltage are transferred to each DG by a one-way communication system. The parameters of power and control systems of the case study are listed in Tables 1 and 2, respectively. As it can be found in Table.1, the lines impedances of DG<sub>1</sub> and DG<sub>2</sub> are considered different in order to evaluate the proposed algorithm better; Furthermore, it is assumed that the capacities of the inverters are 10% more than their available maximum powers which can be delivered in order to provide some rooms for reactive power and harmonics compensation.

For evaluation of voltage support and harmonic compensation functions, one simulation scenario and two experimental scenarios are studied.

Table 1 Power Stage Parameters

DC link voltage			LCL filter ( $L_1/C/L_2$ )	Voltage/ Frequency
700V			For all DGs: 8.6mH/4.5 $\mu$ F/1.8mH	230V/50Hz
Nonlinear Load			Linear load (simulation)	Linear load (experimental)
$C_{NL}(\mu\text{F})$	$R_{NL}(\Omega)$	$L_{NL}(\text{mH})$	$Z_L(\Omega)$	$Z_L(\Omega)$
235	114	0.084	18+100j	0
Line impedance				
$Z_{L1}(\Omega)$		$Z_{L2}(\Omega)$		$Z_{NL}(\Omega)$
0.66		1		0.1+0.5j

Table 2 Control Parameters

Virtual admittance controller					
Allowable individual harmonic (%)			P controllers		
$H_5^*$	$H_7^*$	$H_{11}^*$	$K_{PH,5}$	$K_{PH,7}$	$K_{PH,11}$
1.5%	1%	0.5%	100	100	100

### A. First Scenario (simulation): High consumption and low power injection:

In order to evaluate the effectiveness of the method for compensation in voltage drop conditions, the DGs generated powers are assumed to be low (300 W); and a combination of nonlinear and linear loads is considered. The following steps are taken into account:

- Step I ( $t < 4\text{s}$ ): Without any power quality compensation
- Step II ( $4 \leq t < 8$ ): Voltage support activation
- Step III ( $8 \leq t < 16$ ): Activation of voltage harmonics compensation with central measurement considering 1ms delay for communication system.
- Step IV ( $16 \leq t < 20$ ): Failure of communication system and local measurement based compensation.

Fig. 6 shows the delivered reactive power of DG units while the PCC voltage amplitude is depicted in Fig.7. As shown in these figures, after activation of voltage support, the PCC under voltage problem is mitigated in Step II (voltage amplitude is about 0.905V, in Steps



II, III, and IV) by injection of reactive power to the grid. Furthermore, the voltage support is obtained in Steps IV in which the delay and failure of communication system take place. Since the active power of DG units and their related currents are low, the voltage across  $Z_{L1}$  and  $Z_{L2}$  (see Fig. 1) are low and the amplitudes of PCC and DGs output voltages ( $V_{O,1}$  and  $V_{O,2}$ ) are approximately the same; Hence there is no significant different between voltage amplitudes in Step III and IV where, respectively, PCC voltage measurement and DGs output voltages ( $V_{O,1}$  and  $V_{O,2}$ ) are used as input of “Voltage Support” block.

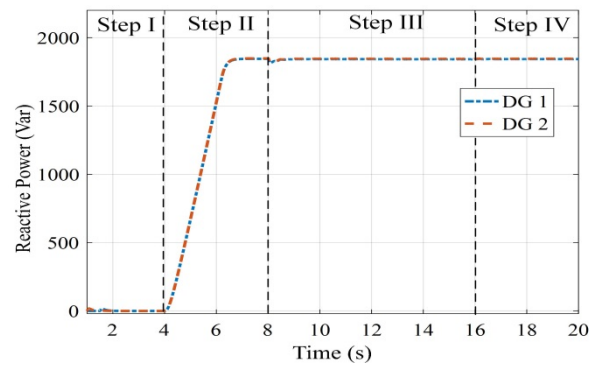

Fig. 6. Reactive power in first scenario

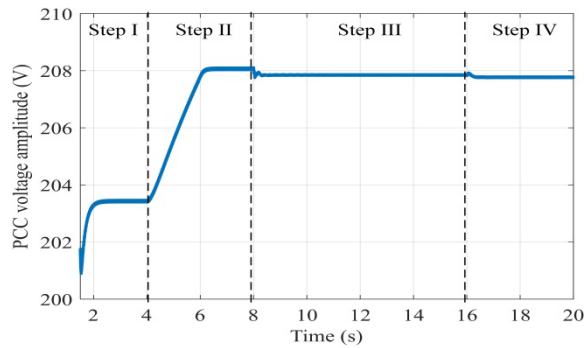

Fig. 7. Voltage amplitude in first scenario

Fig. 8 shows the harmonic content of PCC voltage in different steps. As depicted in Step 2 (only reactive power compensation), the PCC voltage harmonic content is high in this step while under-voltage mitigation occurs in this step. It shows that if the voltage support is the only objective of the controller (the method which is presented in [3-5]), the harmonic

distortion problem should be tackled by using additional dedicated harmonic compensation devices. As depicted in this figure, the PCC voltage compensation is achieved in different steps. The THD of voltage is decreased to 2.5 and 2.8 in Steps III and IV, respectively. It is shown that if the failure of communication system happens, the control system can compensate based on local measurement. This flexibility in choosing local and central measurement is the advantage of the proposed method in comparison with the communication-based methods reported in [13], [15] and [16]. Fig. 9 shows the PCC voltage before and after compensation (in Steps II and III).

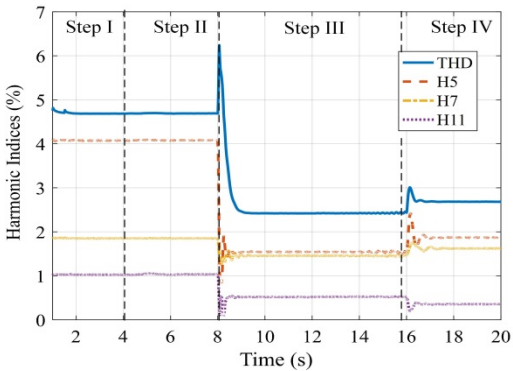

Fig. 8. Harmonic indices of PCC voltage in different steps of first scenario.

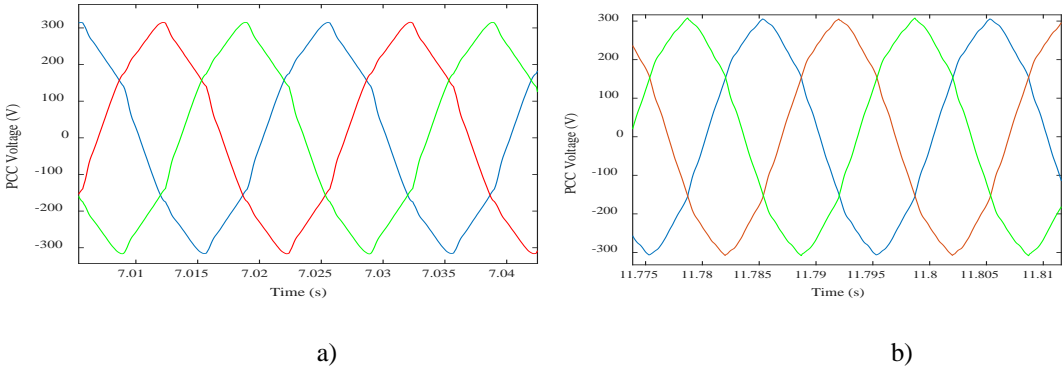

Fig. 9. PCC voltage in first scenario, a) before compensation (in Step II), b) after compensation (in Step III)

**B. Second scenario: High generation and low demand (without any load in PCC)**

Fig.10 shows the experimental setup for this study which consist of inverters, dSPACE controller, nonlinear load, distribution line panel and power quality analyzer.

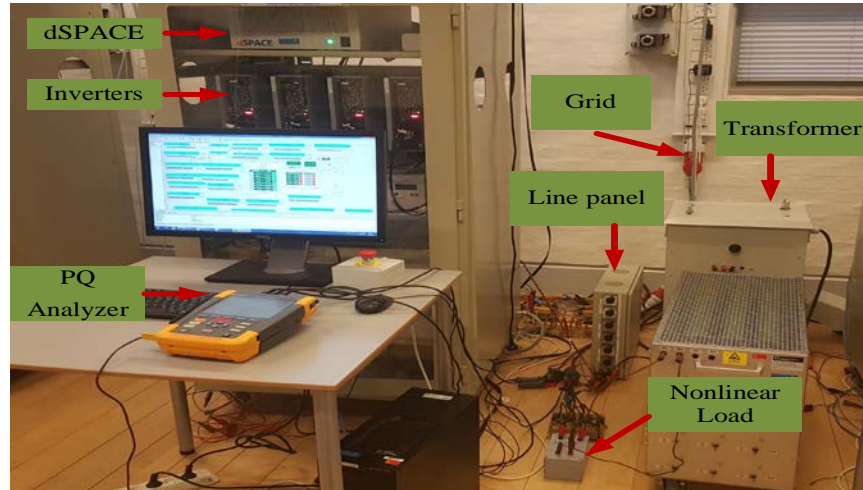

Fig. 10. Experimental setup of the grid tied inverters

For evaluation of voltage rise mitigation, it is assumed that the power generation is high and there is no local consumption in grid-connected MG. The parameters of the system are listed in Table 1. The diagram of the system is similar to the first scenario without any local load in order to evaluate the effectiveness of the method in voltage rise mitigation. The following steps are considered:

- Step A: integration of DGs without voltage support
- Step B: activation of voltage support by using central measurement and deactivation power curtailment algorithm
- Step C: Failure of communication system and activation of voltage support using local measurement
- Step D: activation of voltage support using local measurement and activation of power curtailment algorithm
- Step E: activation of voltage support using remote (at PCC) measurement and activation of power reduction.

The test is implemented when the grid voltage is approximately 231 V. Active and reactive

powers which are delivered by DGs and amplitudes of PCC and output voltage of DGs are depicted in Fig. 11. As depicted in Fig. 11 (a), both of these DGs can deliver their reference powers (the value 2000 W) to the grid in Step A. In this step, since high power and current are injected to the grid, voltage rise takes place in PCC and output voltages of DGs. Due to the high injected current and the high line resistances of  $Z_{L1}$  and  $Z_{L2}$ , the voltage rise of output voltages of DGs are higher than the PCC voltage. After activation of the reactive power compensation and using PCC voltage amplitude as the input of “Voltage Support” blocks in Step B, the PCC voltage rise mitigation is achieved and the PCC voltage amplitude is lower than the limit of  $1.05 V_r$  which is determined in Section 3.a, as depicted in Fig. 11 (a); however, the amplitudes of the DGs output voltage are higher than the standard limit.

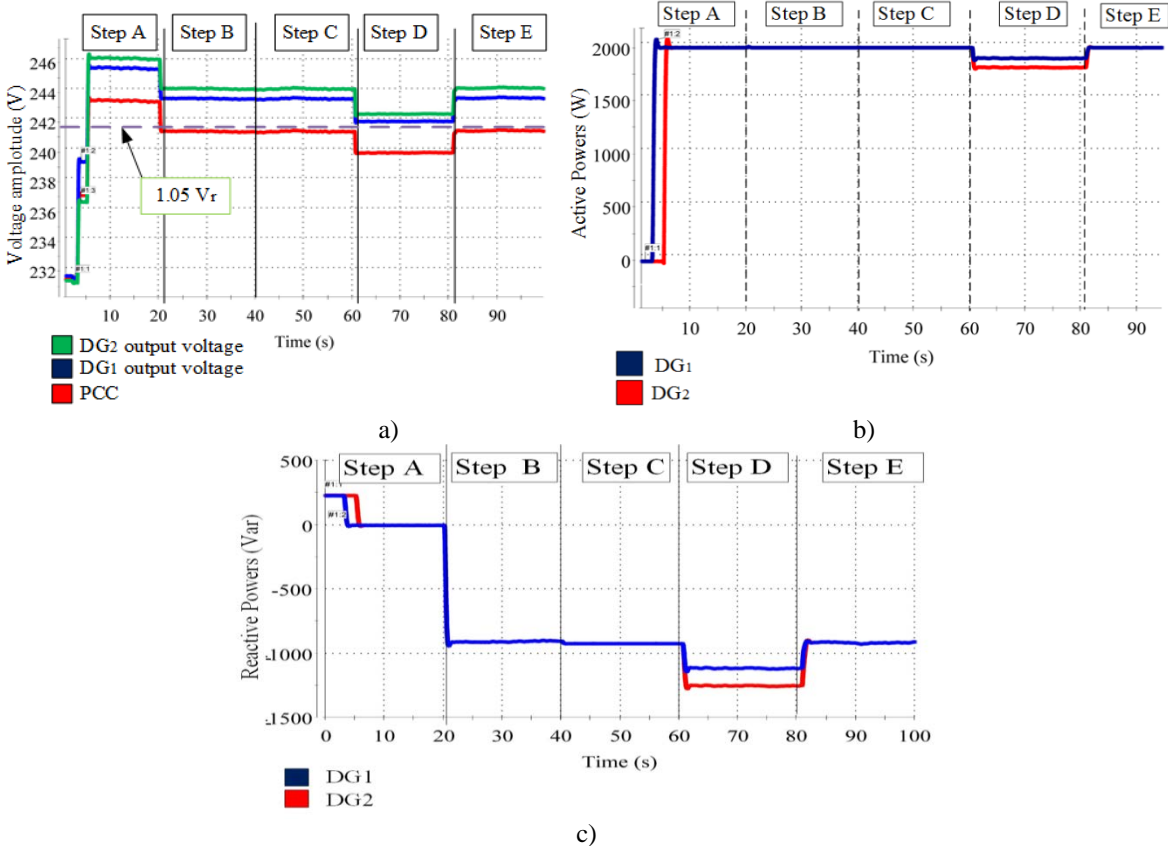

Fig. 11. Experimental results in second scenario with 231 V grid voltage , a) voltage amplitude, b) active power, c) reactive power

The figure also shows that in the case the local measurement is used in Step C, since the output voltages of both DGs are higher than  $1.05 V_r$ , all of their free capacities are dedicated to reactive power compensation.

After activation of power curtailment method and using output voltages of DGs as local measurement in Step D, the power curtailment takes place. In this step, the active power of DGs are decreased because, only the reactive power compensation alone is not sufficient for voltage rise mitigation of the output voltages of DGs. The power curtailment of DG<sub>2</sub> is higher than DG<sub>1</sub>. This is attributed to the higher voltage of DG<sub>2</sub> in respect to DG<sub>1</sub> due to the higher line resistance of DG<sub>2</sub>. In this step, due to the occurrence of power curtailment, the available reactive power increases according to Eq. 2; furthermore, it shows that if local measurement is used, the power curtailment is unfair between DGs due to different voltage measurement of DGs.

After reactivation of the communication system in Step E, the power curtailment does not happen because the reactive power compensation is enough to recover the PCC voltage as depicted in Fig. 11(a) and the PCC voltage amplitude is under the  $1.05V_r$ , which is defined as threshold of power curtailment algorithm according to Fig .4. It shows that using the PCC voltage measurement can provide a real evaluation of the voltage rise problem in PCC and can prevent the unnecessary compensation as reported in Step D and is used in [4].

In order to shows the effect of grid voltage on the voltage rise of PCC, another experimental test is performed with the grid voltage of 233 V. Fig. 12 shows the performance of the proposed method in voltage rise mitigation. Fig. 12(a) shows the PCC, DG<sub>1</sub> and DG<sub>2</sub> output voltages. The voltage amplitudes in Fig. 12 (a) are higher than those of Fig.11 (a), because of higher grid voltage. Furthermore, as depicted in Figs. 12(a) and

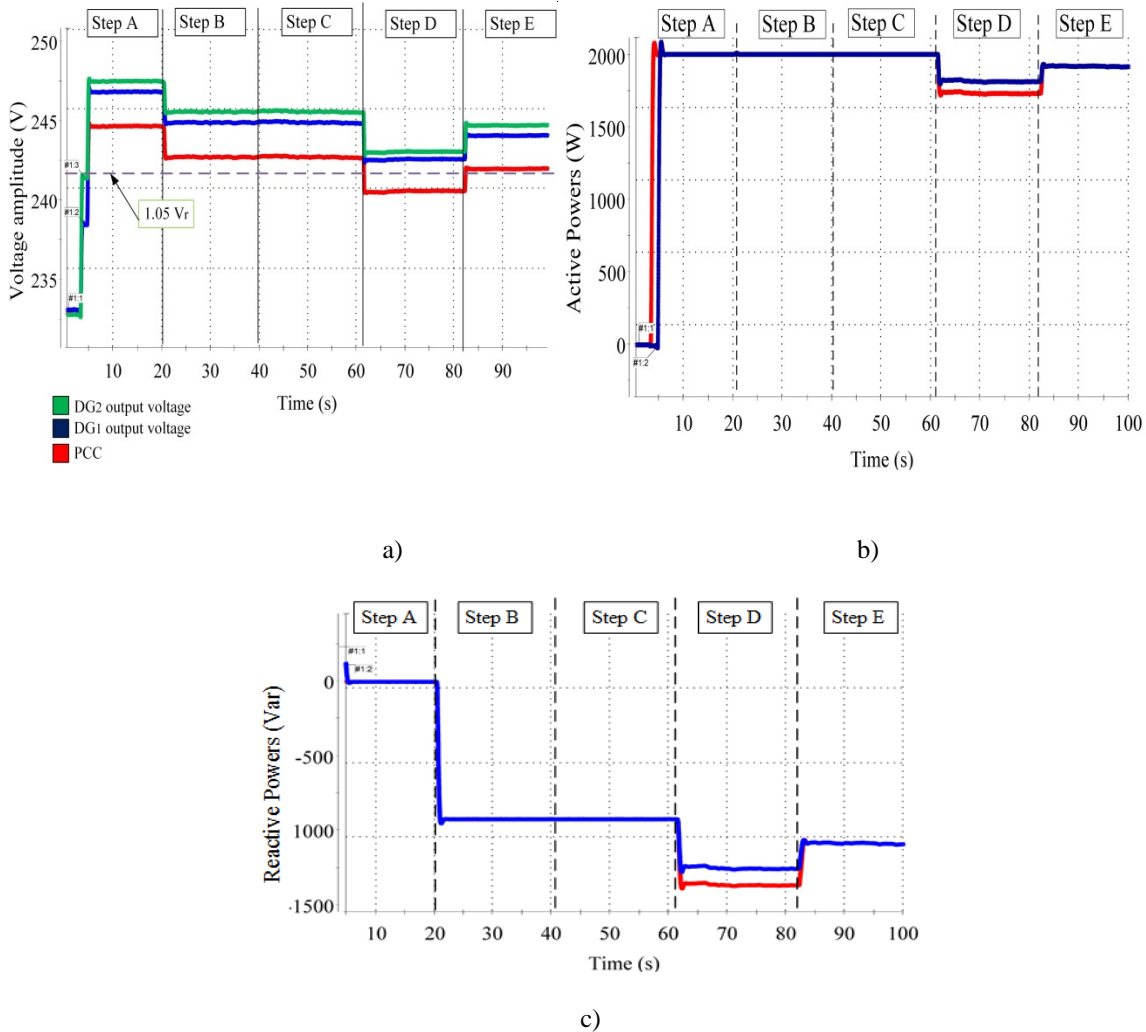

Fig. 12. Experimental results in second scenario with 233 V grid voltage, a) voltage amplitude, b) active power, c) reactive power

12(b), after activation of reactive power compensation in Steps b and c, although all of the remaining capacity of DGs are dedicated to reactive power compensation, the PCC and DGs output voltages are higher than  $1.05V_r$ . After activation of power curtailment method in Step D and using local measurement same as the methods proposed in [4], since the voltage rise in this case is more severe than the previous one, the power curtailments of DGs are also higher. It also shows that an unfair power curtailment happens because of different local measurements of DGs output voltages. After activation of the one-way

communication system in Step E, a fair power curtailment happens for DG<sub>1</sub> and DG<sub>2</sub>.

### **Third Scenario: High generation and medium demand (with nonlinear load)**

In this case, a nonlinear load is connected to the PCC bus in order to experimentally validate the harmonic compensation and reactive power support when the load is not as high as the first scenario and only nonlinear load is connected in PCC; the parameters of the nonlinear load are also listed in Table 1.

For evaluation of harmonic compensation, it is assumed that firstly the communication system is working properly with  $t=5\text{ms}$  delay. After that, the communication system fails and the local measurement is activated instead of the remote one.

Fig. 13 (a) shows the voltage waveform of PCC before compensation while the measured harmonic content is depicted in Fig. 13 (b). As shown in Fig. 13 (b), the THD and 5<sup>th</sup> order harmonic exceeds 5% and 3%, respectively, which are defined as allowable values according to IEEE 519 standard [35].

Fig.14 shows the PCC voltage waveform and its harmonics contents after compensation considering  $t=5\text{ms}$  delay time. As depicted in Fig. 14 (b), the harmonic compensation is achieved and the amounts of harmonics contents are below the limits of IEEE 519 standard.

Fig. 15 shows the PCC voltage waveform and its harmonic content after communication failure. As observed, by using local measurement, in the case of remote (at PCC) measurement, the voltage harmonic compensation is achieved; however, the compensation was more effective.

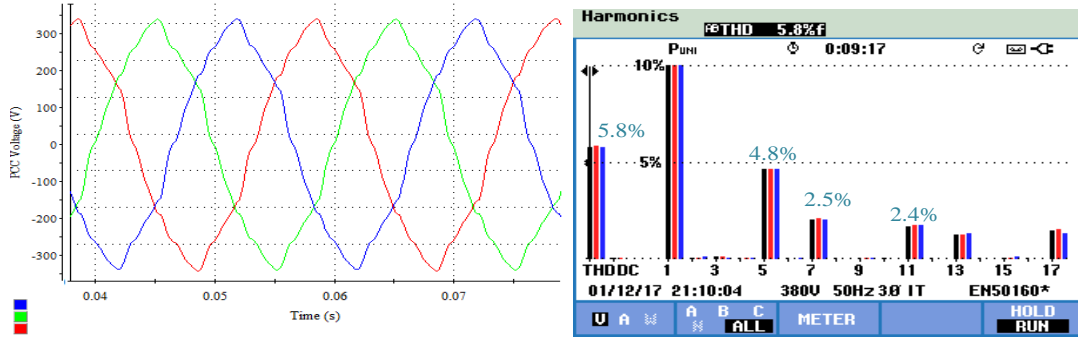

a)

b)

Fig. 13. PCC voltage before harmonic compensation in third scenario (Experimental results), a) voltage waveform, b) harmonic content

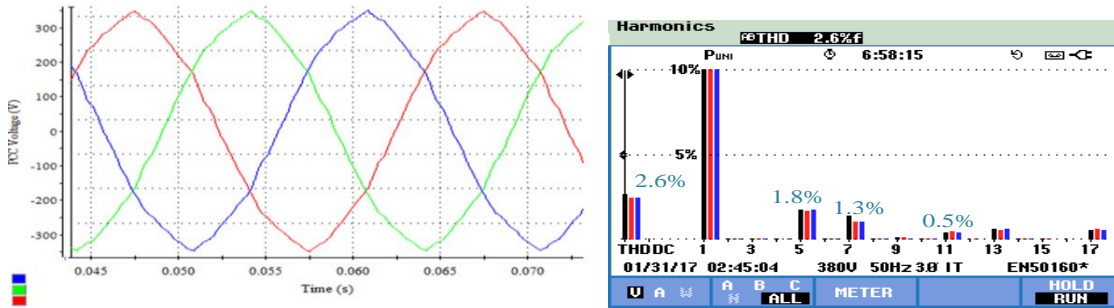

a)

b)

Fig. 14. PCC voltage, with communication system and 5ms delay in third scenario (Experimental results) a) voltage waveform, b) harmonic content

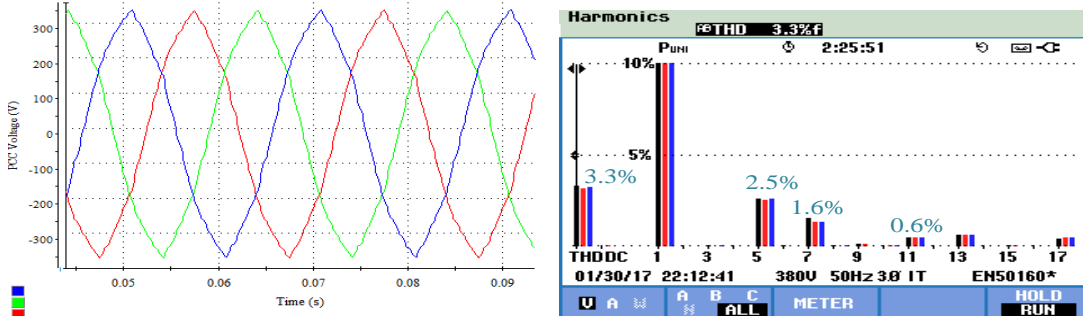

a)

b)

Fig. 15. PCC voltage without communication system third scenario (Experimental results) a) voltage waveform, b) harmonic content

By increasing the time delay of communication system, the harmonic content of PCC voltage increases as presented in Table 3. Also, it can be observed that the local measurement based compensation (the results shown in Fig. 15) can be more effective than



the remote measurement case when the delay of communication system is too high (for instance 50ms).

Table.3 Harmonics indexes in experimental study

Harmonics Indexes Delay Time	THD (%)	H <sub>5</sub> (%)	H <sub>7</sub> (%)	H <sub>11</sub> (%)
0.5 ms	2.4	1.5	1.1	0.5
10 ms	3.1	2.4	1.5	0.5
50 ms	3.7	2.9	1.7	0.6
Local measurement	3.3	2.5	1.6	0.6

For evaluation of reactive power control in this scenario, three following steps are implemented:

- Step a: without reactive power compensation
- Step b: reactive power compensation without communication system
- Step c: reactive power compensation with communication system

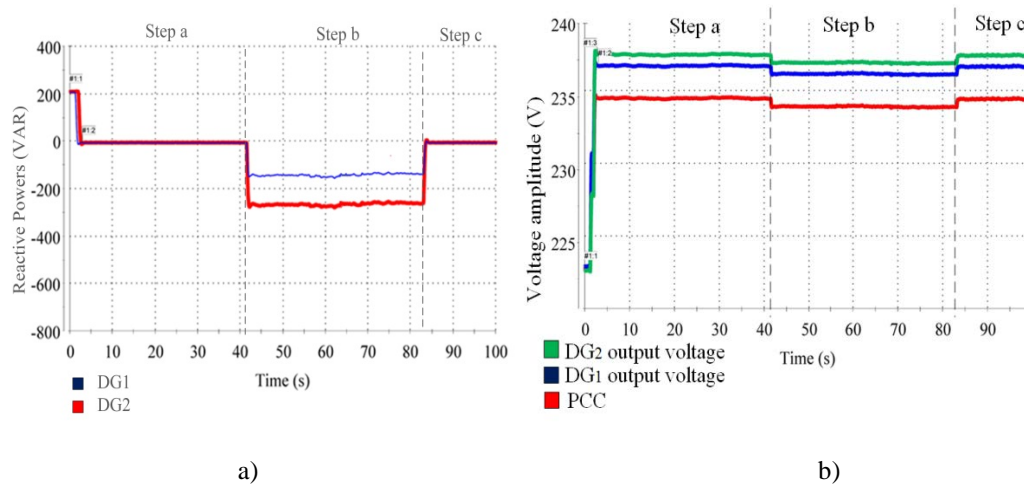

Fig. 16. Experimental results for third scenario a) Reactive power, b) Voltage amplitude

Fig. 16(a) shows the reactive power delivered by DG units while the RMS fundamental voltage of PCC and output voltage of DGs are depicted in Fig. 16(b). As can be seen in Fig. 16(a), when the local measurement is available (in Step b), the DG units contribute in

voltage rise mitigation by absorbing reactive power. The reactive power compensation is stopped in Step c where the remote measurement is used, because the measured voltage of PCC shows that the amplitude is lower than  $1.025 V_l$  (below the limit as defined in (2)) and thus, the voltage rise mitigation is not necessarily needed; whereas in Step b the local measurements have shown the necessity of compensation.

## **5. Conclusions**

In this paper, the contribution of DGs in voltage support and harmonic compensation in a grid-connected MG is investigated. Both of voltage support and harmonics compensation can be chosen by local or communication-based measurement and the limited capacity of the DG interfacing inverters is also considered in voltage support and harmonics compensation.

The proposed harmonic compensation is based on virtual admittance and has the flexibility in selecting local or remote measurement. The limited capacity of inverter and the effect of communication system delay have been investigated. Experimental and simulation results show that after harmonics compensation, the amounts of individual harmonics and THD are less than their allowed values according to IEEE 519 and EN 50160 standards. The study has also shown that compensation based on central (remote) measurement will be more effective than local-measurement-based compensation if the commutation system delay is low.

Furthermore, over/under voltage compensation by the DG units has been assessed. The voltage rise mitigation is achieved by active and/or reactive power curtailment with the flexibility for remote or local measurement. The active power curtailment is used when reactive power compensation is not sufficient for voltage rise control. Furthermore, the

under voltage compensation is achieved by injecting reactive power with considering the limited capacity of the inverter. The results showed that if only the local measurement is available and the PCC voltage quality improvement is considered as the main goal of compensation, unnecessary compensation can be avoided. The reliability of the system can be increased when a communication failure occurs.

## Reference:

1. T.C. Green, M. Prodanović, "Control of inverter-based micro-grids," *Electric Power Systems Research* Vol.77 pp.1204–1213, 2007.
2. Carvalho, Pedro MS, Pedro F. Correia, and Luís AFM Ferreira. "Distributed reactive power generation control for voltage rise mitigation in distribution networks." *IEEE transactions on Power Systems* 23.2 (2008): 766-772.
3. Demirok, Erhan, et al. "Local reactive power control methods for overvoltage prevention of distributed solar inverters in low-voltage grids." *IEEE Journal of Photovoltaics* 1.2 (2011): 174-182.
4. Ghasemi, Mohammad Amin, and Mostafa Parniani. "Prevention of distribution network overvoltage by adaptive droop-based active and reactive power control of PV systems." *Electric Power Systems Research* 133 (2016): 313-327
5. S. Alyami, W. Yang, W. Caisheng, Z. Junhui, Z. Bo, Adaptive real powercapping method for fair overvoltage regulation of distribution networkswith high penetration of PV systems, *IEEE Trans. Smart Grid* Vol.5 pp. 2729–2738, 2014.
6. Momeneh, Arash, et al. "Comparative study of reactive power control methods for photovoltaic inverters in low-voltage grids." *IET Renewable Power Generation* 10.3 (2016): 310-318.
7. Yang, Yongheng, et al. "Power control flexibilities for grid-connected multi-functional photovoltaic inverters." *IET Renewable Power Generation* 10.4 (2016): 504-513.
8. Bueno, Pedro G., Jesus C. Hernández, and Francisco J. Ruiz-Rodriguez. "Stability assessment for transmission systems with large utility-scale photovoltaic units." *IET Renewable Power Generation* 10.5 (2016): 584-597.
9. Hernandez, Jesus C.; Bueno, Pedro G.; Sanchez-Sutil, Francisco. Enhanced utility-scale photovoltaic units with frequency support functions and dynamic grid support for transmission systems. *IET Renewable Power Generation* Volume: 11 Issue: 3 Pages: 361-372 . 2017.
10. Li, Yun Wei, and Ching-Nan Kao. "An accurate power control strategy for power-electronics-interfaced distributed generation units operating in a low-voltage multibus microgrid." *IEEE Transactions on Power Electronics* 24.12 (2009): 2977-2988.
11. Vasquez, Juan C., et al. "Voltage support provided by a droop-controlled multifunctional inverter." *IEEE Transactions on Industrial Electronics* 56.11 (2009): 4510-4519.
12. Z. Zeng, H. Yang, S. Tang and R. Zhao, "Objective-Oriented Power Quality Compensation of Multifunctional Grid-Tied Inverters and Its Application in Microgrids," *IEEE Trans. Power Electron.*, vol. 30, no. 3, pp. 1255-1265, March 2015.
13. Savaghebi, M.; Jalilian, A.; Vasquez, J.C.; Guerrero, J.M., "Secondary Control for Voltage Quality Enhancement in Microgrids," *IEEE Trans Smart Grid*, vol.3, no.4, pp. 1893-1902, Dec. 2012.
14. M. Savaghebi, Q. Shafiee, J. C. Vasquez and J. M. Guerrero, "Adaptive virtual impedance scheme for selective compensation of voltage unbalance and harmonics in microgrids," *2015 IEEE Power & Energy Society General Meeting, Denver, CO, 2015*, pp. 1-5.
15. M. Savaghebi, J. C. Vasquez, A. Jalilian, Josep M. Guerrero and Tzung-Lin Lee " Selective compensation of voltage harmonics in grid-connected microgrids" *Mathematics and Computers in Simulation*, Vol.91, p.p 221-228, 2013.

16. C. Blanco, D. Reigosa, J. C. Vasquez, J. M. Guerrero and F. Briz, "Virtual Admittance Loop for Voltage Harmonic Compensation in Microgrids," *IEEE Trans.s Ind. Appl.*, vol. 52, no. 4, pp. 3348-3356, July-Aug. 2016.
17. Hashempour, Mohammad M., et al. "A control architecture to coordinate distributed generators and active power filters coexisting in a microgrid." *IEEE Transactions on Smart Grid* 7.5 (2016): 2325-2336.
18. X. Wang, F. Blaabjerg, and Z. Chen, "Synthesis of variable harmonic impedance in inverter-interfaced distributed generation unit for harmonic resonance damping throughout a distribution network," *IEEE Trans. Ind. Appl.*, vol. 48, no. 4, pp. 1407-1417, Jul./Aug. 2012.
19. Xiongfei Wang; Blaabjerg, F.; Zhe Chen, "Autonomous Control of Inverter-Interfaced Distributed Generation Units for Harmonic Current Filtering and Resonance Damping in an Islanded Microgrid," *IEEE Trans. Ind. Appl.*, vol. 50, no. 1, pp. 452,461, Jan.-Feb. 2014.
20. Hamzeh, Mohsen, Houshang Karimi, and Hossein Mokhtari. "Harmonic and negative-sequence current control in an islanded multi-bus MV microgrid." *IEEE Transactions on Smart Grid* 5.1 (2014): 167-176.
21. A. Micaleff; M. Apap; C. Spiteri-Staines; J. M. Guerrero, "Mitigation of Harmonics in Grid-Connected and Islanded Microgrids via Virtual Admittances and Impedances," *IEEE Trans. Smart Grid*, vol.PP, no.99, pp.1-11, Nov. 2015.
22. Zheng Zeng; Rongxiang Zhao; Huan Yang, "Coordinated control of multi-functional grid-tied inverters using conductance and susceptance limitation," *IET Power Electron*, vol.7, no.7, pp.1821-1831, July 2014.
23. Nguyen, Trung Nhan, An Luo, and Mingfei Li. "A simple and robust method for designing a multi-loop controller for three-phase VSI with an LCL-filter under uncertain system parameters." *Electric Power Systems Research* VOL.117, pp. 94-103, 2014.
24. Ch. Bao, X. Ruan, X. Wang, W. Li, D. Pan, and K.Weng. "Step-by-Step Controller Design for LCL-Type Grid-Connected Inverter with Capacitor-Current-Feedback Active-Damping" *IEEE Trans. Power Electron*, vol. 29, no. 3, March 2014.
25. R. Peña-Alzola, M. Liserre, F. Blaabjerg, R. Sebastián, J. Dannehl and F. W. Fuchs, "Analysis of the Passive Damping Losses in LCL-Filter-Based Grid Converters," *IEEE Trans. Power Electron.*, vol. 28, no. 6, pp. 2642-2646, June 2013.
26. Teodorescu, Remus, Marco Liserre, and Pedro Rodriguez. *Grid converters for photovoltaic and wind power systems*. Vol. 29. John Wiley & Sons, 2011.
27. IEEE 1547 "IEEE Standard for Interconnecting Distributed Resources with Electric Power Systems", 2004.
28. - IEEE SCC21 1547 Standards Development P1547a – Amendment 1 to IEEE Std1547 Working Group Meeting Minutes for June 13–14, 2013, Golden, CO, USA. Available from: <http://grouper.ieee.org/>.
29. IEC/TR 61850-90-7 "Communication Networks and Systems for Power Utility Automation—Part 90-7: Object Models for Power Converters in Distributed Energy Resources (DER) Systems", IEC: Geneva, Switzerland, 2013.
30. Kim, Yun-Su, et al. "New Requirements of the Voltage/VAR Function for Smart Inverter I Distributed Generation Control." *Energies* 9.11 (2016): 929.
31. "IEEE Recommended Practice for Monitoring Electric Power Quality", IEEE Std 1159-2009.
32. EN 50160 standard, "Voltage characteristics of electricity supplied by public distribution systems," 1999.
33. Wu, Dan, et al. "Autonomous active power control for islanded ac microgrids with photovoltaic generation and energy storage system." *IEEE Transactions on energy conversion* 29.4 (2014): 882-892.
34. IEEE Standard Definitions for the Measurement of Electric Power Quantities Under Sinusoidal, Nonsinusoidal, Balanced, or Unbalanced Conditions," *IEEE Std 1459-2010 (Revision of IEEE Std 1459-2000)*, pp.1-50, March 19 2010.
35. IEEE 519 Standard "IEEE Recommended Practice and Requirements for Harmonic Control in Electric Power Systems", 2014.