

**Keywords:** diagnostics; diesel fuel equipment; injector needle displacement; mathematical model; optical sensor

**Igor DANILOV\***, Aleksander MARUSIN, Mikhail MIKHLIK

Peoples' Friendship University of Russia  
6 Miklukho-Maklaya, Moscow, 117198, Russia

**Ivan USPENSKY**

Ryazan state agrotechnological University named after P. A. Kostychev  
1 Kostychev, Ryazan, 1390044, Russia

\*Corresponding author. E-mail: [danilov\\_ik@rudn.university](mailto:danilov_ik@rudn.university)

## DEVELOPMENT OF THE MATHEMATICAL MODEL OF FUEL EQUIPMENT AND JUSTIFICATION FOR DIAGNOSING DIESEL ENGINES BY INJECTOR NEEDLE DISPLACEMENT

**Summary.** This article discusses the proposed method for diagnosing diesel fuel equipment. An analysis of available methods for diagnosing fuel equipment has been carried out. The authors describe their method for diagnosing plunger pairs of a high-pressure fuel pump according to the parameter of displacement of the injector needle. The design of the diagnostic device for measuring the movement of the injector needle has been developed and patented. The dependence of the maximum displacement of the injector needle on the increase, due to wear, of the radial clearance of the plunger bushing at the minimum steady state of idling of the engine has been determined. The technique of diagnosing the technical condition of plunger pairs of a high-pressure fuel pump by injector needle displacement is considered in detail.

### 1. INTRODUCTION

At present, the internal combustion engine services market offers a wide range of diagnostic equipment and techniques [1]. In practice, effective instruments designed by research and development organizations have not come into common use; as a result, the production is limited to a small number of these instruments. This poses challenges in the selection of a single set of instruments and equipment needed for an integrated assessment of the technical condition of internal combustion engines (ICE) using standard structural parameters.

Analysis of commercial vehicle structure has shown that auto-tractor diesels make up most of it. The KAMAZ-740 motor-tractor diesel engine is the most common one in Russia and other countries with fuel equipment (FE) of a separate type with a multi-plunger high-pressure fuel pump (HPFP) with different control systems [1]. The FE of diesel engines is a complex high-tech engine assembly, the technical condition of which determines the environmental, economic and technological performance of the vehicle. Maintenance of an operational condition of elements of diesel engine FE in operation is achieved by carrying out a scheduled diagnostics and technical inspection of the fuel system. The most important node of the diesel engine FE, determining the work and its characteristics as a whole, is HPFP [2]. Analysis of faults of diesel engines FE showed that one of the most loaded components are plunger pairs [3] and their malfunctions (Fig. 1).

Currently, the market of services for diesel FE offers a wide range of diagnostic equipment and techniques [4]. At the same time, the widely used methods of diagnosing diesel FE are carried out with removing FE from the car and with partial disassembly. The use of modern diagnostic methods without disassembly of the engine for such diesel FE will help to reduce the complexity of work and improve

the quality of diagnostics [5]. Such diagnostic methods are based on the analysis of the output parameters of the diesel FE, which are functionally related to its structural parameters; however, they have been insufficiently investigated. The available work on the diagnostics of diesel FE can be divided into the following groups: diagnosis of the characteristics of the diesel FE; diagnostics by parameters of diesel FE; and diagnostics according to the performance of the engine [6].

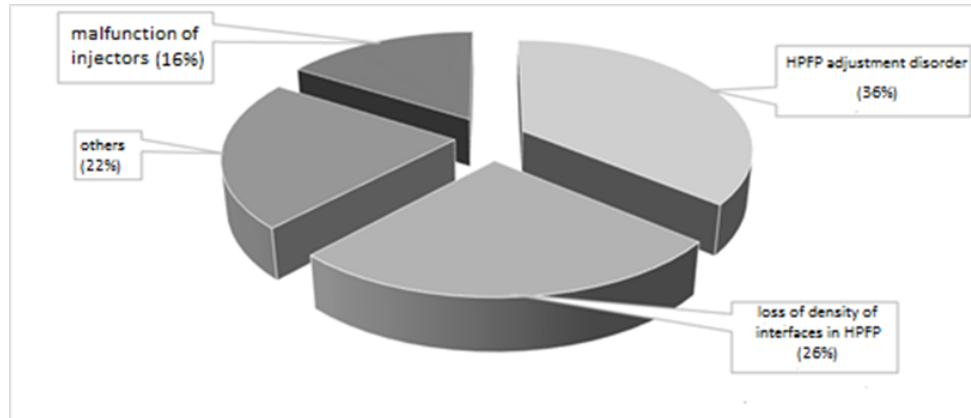

Fig. 1. Distribution of FE faults of a diesel with a separated injection system [6]

The methods of diagnosing diesel FE of the first group are not informative and largely depend on the experience and qualifications of the diagnostician. When applying the brakeless and partial methods of diagnostics, control of the state of the diesel FE elements is complicated by a number of factors that affect reduction of the power and economic parameters of diesel, but these methods enable estimation of the overall technical condition of the engine. The gas-analytical method for diagnosing diesel FE yields limited information due to tightening of the environmental standards for the content of harmful substances in exhaust gases. The diagnostic procedure for diesel FE operation parameters involves an assessment of the technical condition and quality of adjustment of the main elements of the diesel fuel supply system. The most common method is diagnosing the plunger pairs of the HPFP at the maximum injection pressure of fuel into a blind closed chamber or into the atmosphere, but it is not suitable for quantifying the hydraulic density of a plunger pair due to a small range of measured pressure (up to 50 MPa) and unavoidable fuel leakage through an injector needle. The most promising method, in our opinion, is that of diagnosing diesel FE at idle, without its dismantling and disassembly. That is, the use of expensive and bulky stands becomes no longer required.

## 2. METHODOLOGY AND RESEARCH RESULTS

To substantiate the method for diagnosing the diesel FE by the injector needle displacement, we developed an injector with an optical sensor (patent No. 152362) [7] and a diagnostic device for diesel fuel combustion equipment (patent application No. 20117123405). Diagnostic modes with parameters of maximum fuel injection pressure and needle nozzle displacement are investigated and justified. The regularities of their change from the radial clearance of the coupling of the plunger-bushing HPFP are obtained. Metrological characteristics of the device enabled measurements with an error of 0.11%, which is sufficient for the informative value of the diagnostic parameter. The test of the device on the engine confirmed the assumption about the effectiveness of this method of diagnosing diesel FE as a promising one.

When examining the mode of diagnosing diesel FE and choosing the optimum frequency of rotation of the crankshaft, it is necessary to determine the nature of the change in the movement of the injector needle and the fuel pressure in the cavity above the plunger of the HPFP, the injection pressure of fuel and the effect of the radial clearance "plunger-bushing" of the HPFP on the maximum fuel injection pressure and the injector needle displacement.

The calculation was carried out for the high-pressure line diesel FE of the operating diesel engine, in which a diagnostic injector was installed, capable of detecting the movement of its needle.

### 2.1. Development of a mathematical model of a high-pressure fuel pump for estimating the pressure and moving the injector needle

The mathematical model of the diesel engine FE, using any method of solving the wave equation, is functionally reduced to the Cauchy boundary value problem, which is based on the equation of the unsteady process of working fluid in the high-pressure line. The boundary conditions are the system of differential equations that characterize the processes occurring in the HPFP - on the left and at the injector - on the right, for the description of which, systems of equations of volumetric balance are used for different cavities of diesel FE and the equations of motion of the injector and pump valves.

The process of changing the pressure in the cavity above the plunger depends on the change in the compressibility of diesel fuel, the flow rate when flowing through the gap between the plunger and the bushing, and the channel of the corrective valve of the HPFP [8]. The technical characteristics of the diesel fuel used are shown in Table 1.

Table 1

Technical characteristics of the test fuel

Name of indicator	Value
Cetane number	52.0
Cetane index, not less than	46.2
Density at 15 °C, kg / m <sup>3</sup>	826.4
Mass fraction of polycyclic aromatic hydrocarbons,%	7.3
Mass fraction of sulfur, mg / kg, no more, for fuel:	8.7
Flash point determined in a closed crucible, ° C,	61
Coking property of a 10% distillation residue,% mass.,	0.21
Ash content,% of the mass.	0.007
Mass fraction of water, mg / kg	187
Total pollution, mg / kg	19
Lubricity: adjusted wear spot diameter (wsd 1.4) at 60 °C, μm	430
Kinematic viscosity at 40 °C, mm <sup>2</sup> / s	4.230

When calculating the compressibility coefficient  $\alpha$  (m<sup>2</sup> / N), we used the tabular experimental dependence of the true and average values of the compressibility coefficients of the diesel fuel [9] on the current pressure  $p$  (N / m<sup>2</sup>), which is shown in Fig. 2.

According to the tabular data, regression mathematical dependences on the current pressure over the plunger  $p$  are constructed:

- values of the average coefficient of compressibility of diesel fuel  $\alpha_{av}$  in the form of a polynomial of the fourth order:

$$\alpha_{av} = a_1 \cdot p^4 + a_2 \cdot p^3 + a_3 \cdot p^2 + a_4 \cdot p + a_5, \quad (1)$$

where: the regression coefficients  $a_1 = 5.1569 \cdot 10^{-6}$ ;  $a_2 = -8.3799 \cdot 10^{-4}$ ;  $a_3 = 0.0531$ ;  $a_4 = -1.9148$ ; and  $a_5 = 100$ .

- the values of the true coefficient of compressibility of diesel fuel  $\alpha_{true}$  in the form of a polynomial of the fifth order:

$$\alpha_{true} = a_1 \cdot p^5 + a_2 \cdot p^4 + a_3 \cdot p^3 + a_4 \cdot p^2 + a_5 \cdot p + a_6, \quad (2)$$

where: the regression coefficients  $a_1 = -7.5712 \cdot 10^{-8}$ ;  $a_2 = 1.4734 \cdot 10^{-5}$ ;  $a_3 = -0.0014$ ;  $a_4 = -2.9671$ ;  $a_5 = 0.0825$ ; and  $a_6 = 99.997$ .

When calculating the fuel supply process in the elements of diesel FE, the dependence of the values of the compressibility factor of diesel fuel was used. The leakage from the cavity above the plunger between the bushing and the plunger was taken into account; the equation of volume flow of has the following form [8]:

$$Q_{pH} = \frac{\pi \cdot \beta_e \cdot \Delta p^2 \cdot \delta_p^3 \cdot d_p \cdot \ln(c_\mu)}{12 p_0 \cdot \delta_p \cdot \mu_{tp0} \cdot l_p \cdot c_\mu} \mp \pi \cdot c_3 \cdot \frac{\delta_p}{2}, \quad (3)$$

where:  $\beta_e$  is the correction factor for the eccentricity of the coupling (from 1.15 to 1.4);  $\Delta p = p_p - p_0$  is the differential pressure in the gap, ( $\text{N} / \text{m}^2$ );  $\delta_p$  is the value of the annular gap, (m);  $c_\mu = 1.0025$  is a coefficient with a constant value;  $\mu_{tp0}$  is the dynamic viscosity of the fuel at atmospheric pressure  $p_0 = 0.1$  MPa ( $\text{kg} / (\text{s} \cdot \text{m})$ );  $d_p$  and  $l_p$ , respectively, are the diameter and length of the bush, (m); and  $c_p$  is the plunger speed of the injection pump (m/s).

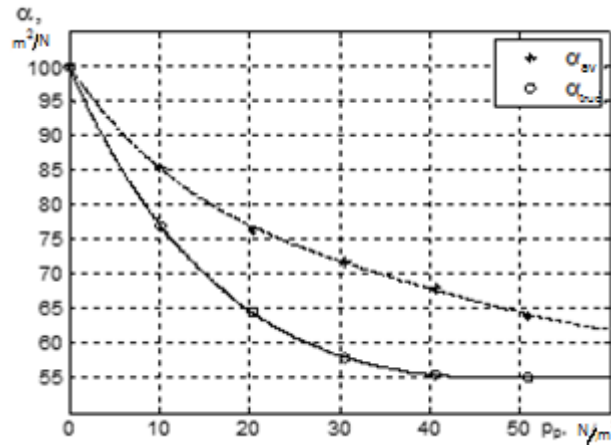

Fig. 2. Dependence of the compressibility coefficient  $\alpha$  of diesel fuel on the current pressure  $p$ :  $\alpha_{\text{true}}$  - the true coefficient of compressibility and  $\alpha_{\text{av}}$  - the average values of the compressibility factor

Formula (3) takes into account the change in the coefficient of dynamic viscosity  $\mu_t$  from the pressure  $p_p$  above the plunger of the HPFP.

$$\mu_t = \mu_{tp0} \cdot c_\mu^{p/p_0}, \quad (4)$$

The coefficients of dynamic  $\mu_t$  and kinematic  $\nu$  viscosity of diesel fuel are related to each other [9]:

$$\nu = \frac{\mu_t}{\rho_t}, \quad (5)$$

where:  $\rho_t$  is the density of diesel fuel ( $\text{kg} / \text{m}^3$ ).

The values of the dynamic viscosity  $\mu$  are usually calculated from the values of the kinematic viscosity  $\nu$  obtained experimentally.

According to the data from the table of experimental dependence of the kinematic viscosity of the fuel on temperature  $T_T$ , [8] a regression dependence is constructed, which has the following form:

$$\nu = a_1 + a_2 \cdot \log(T_T) + a_3 \cdot \log(T_T)^2, \quad (6)$$

where: the regression coefficients  $a_1 = 0.76149543$ ;  $a_2 = -0.36487040$ ; and  $a_3 = 0.043988593$ ;  $T_T$  is the temperature of diesel fuel ( $^{\circ}\text{C}$ ).

The regression dependence (6) of the kinematic viscosity  $\nu$  of diesel fuel on its temperature  $T_T$  in the form of a graph is shown in Fig. 3.

The volumetric flow rate of the fuel entering the fuel line to the injector through the slit of the discharge valve was determined by the following formula:

$$Q_o = \mu_i \cdot f_i \cdot \sqrt{2 \frac{|p_{i1} - p_{i2}|}{\rho_t}} \cdot \text{sign}(p_{i1} - p_{i2}), \quad (7)$$

where:  $\mu_i$  is the discharge coefficient of the discharge valve slit;  $f_i$  is the area of the slit of the discharge valve ( $\text{m}^2$ );  $p_{i1}$  is the pressure of the flow entering the slit ( $\text{N}/\text{m}^2$ );  $p_{i2}$  is the flow pressure at the output from the slit of the discharge valve ( $\text{N}/\text{m}^2$ ); and  $\rho_t$  is the density of diesel fuel ( $\text{kg}/\text{m}^3$ ).

The dependence of the discharge factor of the discharge valve slit in Eq. (7) was calculated by the regression dependence:

$$\mu_i = \sqrt{\frac{156}{Re_i^2} + 1} - \frac{12,5}{Re_i}, \quad (8)$$

$$Re_i = \frac{v_i \cdot d}{\nu}$$

where:  $Re_i$  is the Reynolds number,  $v_i$  is the fluid flow velocity and  $d$  is the hole diameter.

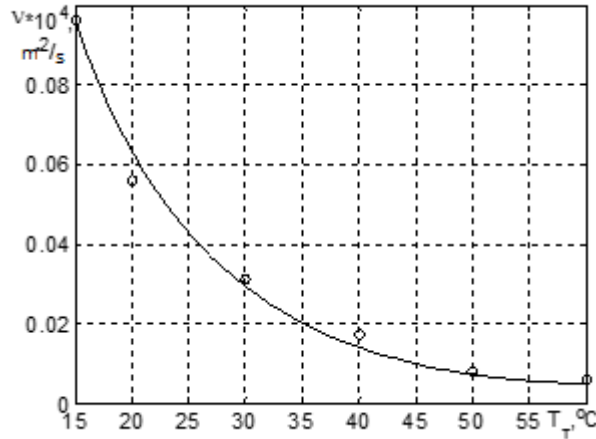

Fig. 3. Dependence of the kinematic viscosity  $\nu$  of diesel fuel on its temperature  $T_f$ : o - experimental data; — regression results

The equation for the change in the discharge factor of the cut-off hole of the plunger-bushing was adopted similar to equation (8), and the regression coefficients were taken in accordance with the ones given in [8].

These leakages characterize the volumetric flow of total fuel leaks from the cavity above the plunger and were taken into account in the mathematical model [10]:

$$\sum Q(p_p) = Q_{pH} + Q_f + Q_o(h_p), \quad (9)$$

where:  $Q_{pH}$  is the volumetric flow rate of fuel leakages along the gap between the bushing and the plunger ( $m^3/s$ );  $Q_f$  is the volumetric fuel flow to the injector ( $m^3/s$ ); and  $Q_o$  is the volumetric fuel consumption through the cut-off hole in the plunger-bushing ( $m^3/s$ ).

The mathematical model of the dynamics of the pressure variation in the cavity above the plunger, depending on the displacement of the injection pump plunger, is presented in the form of a nonlinear differential equation of the first order with ordinary derivatives and has the following form [11]:

$$\alpha_t p_p \cdot V h_p \cdot \frac{dp}{dt} = f_p \cdot c_p(\varphi) - \sum Q(p_p), \quad (10)$$

$$c_p(\varphi) = 0, \quad \text{if } 0 \geq h_p \geq h_{p(max)}$$

where:  $\alpha_t(p_p)$  is the coefficient of compressibility of the fuel ( $m^2/N$ );  $V(h_p)$  is the volume of the cavity above the plunger ( $m^3$ );  $f_p$  is the plunger area ( $m^2$ );  $\varphi$  is the angle of rotation of the camshaft of the injection pump;  $c_p(\varphi)$  is the plunger travel speed ( $m/s$ );  $\sum Q$  is the volumetric flow of total leakages from the cavity above the plunger ( $m^3/s$ );  $h_p = \int c_p(\varphi(t)) dt$  is the displacement of the plunger, (m);  $p_p$  is the pressure in the plunger pair ( $N/m^2$ );  $t$  is the time (s); and  $h_{p(max)}$  is the maximum displacement of the plunger of the HPFP (m).

To calculate the displacement of the injector needle, a model of the dynamics of the pressure variation in the cavity under the injector needle was used, depending on its displacement in the form of a nonlinear first-order differential equation with ordinary derivatives, which has the following form [8]:

$$\alpha_t p_p \cdot V(x_i) \cdot \frac{dp_f}{dt} = Q_f - \sum Q(p_f), \quad (11)$$

where:  $\alpha_t(p_p)$  is the coefficient of compressibility of the fuel ( $m^2/N$ );  $p_f$  is the pressure in the cavity under the needle of the injector ( $N/m^2$ );  $V(x_i)$  is the volume of the cavity under the needle ( $m^3$ );  $Q_f$  is the fuel consumption ( $m^3/s$ ), the fuel coming into the volume of the cavity under the injector needle is taken into account;  $\sum Q(p_f)$  is the total leakage from the cavity under the injector needle ( $m^3/s$ );  $x_i$  is the displacement of the injector needle, (m); and  $t$  is the time (s).

The total leakage of fuel from the cavity under the injector needle is described by the volume flow formula [12]:

$$\Sigma Q(p_f) = Q_f + q_{i2}, \quad (12)$$

where:  $Q_f$  is the volumetric fuel flow through the gap between the guide bushing and the injector needle ( $\text{m}^3/\text{s}$ ) and  $q_{i2}$  is the volumetric fuel consumption through the nozzles of the injector due to the pressure difference at the inlet and outlet of the nozzle openings ( $\text{m}^3/\text{s}$ ).

The leakage formula from the cavity under the injector needle between the guide bushing and the needle is as follows [8]:

$$Q_f = \frac{\pi \cdot \beta_e \cdot \Delta p^2 \cdot \delta_i^2 \cdot d_i \cdot \ln(c_\mu)}{12 p_0 \cdot \delta \cdot \mu_{tp0} \cdot l_i \cdot c_\mu} \mp \pi \cdot c_i \cdot d_i \cdot \frac{\delta_p}{2} \quad (13)$$

where:  $\beta_e$  is the eccentricity correction factor (from 1.15 to 1.4);  $\Delta p = p_f - p_0$  is the differential pressure in the gap ( $\text{N}/\text{m}^2$ );  $\delta_i$  is the annular gap (m);  $c_\mu = 1.0025$  is a coefficient with a constant value;  $\mu_{tp0}$  is the dynamic fuel viscosity at atmospheric pressure ( $\text{kg}/(\text{s} \cdot \text{m})$ );  $d_i$  and  $l_i$  are, respectively, the diameter and length of the gap between the guide bushing and the injector needle (m); and  $c_i$  is the injector needle speed (m/s).

The equation of the dependence of  $q_{i2}$  (volumetric flow of fuel through the injector spray holes) on the differential pressure is described similarly to equation (7), and the dependence of the coefficient of flow conical gap between the seat and the needle is described by regression dependence (8).

The model of the injector needle displacement dynamics in the form of a differential equation has the following form [13]:

$$m_i \cdot \frac{d^2 x_i}{dt^2} = F_{dvi}(t) - F_{Ti} - F_{Cpi} = A_i \cdot p_t(t) - k_{Ti} \cdot \frac{dx_i}{dt} - c_{pi} \cdot (x_i + x_{0i}), \quad (14)$$

$$\frac{dx_i}{dt} = 0, \text{ if } 0 \geq X_i \geq h_{i(max)}$$

where:  $F_{dvi}$  is the force acting on the needle from the pressure under the injector needle (N);  $F_{Ti}$  is the frictional force of the viscous resistance to the displacement of the injector needle (N);  $A_i$  is the working surface of the injector needle ( $\text{m}^2$ );  $p_t(t)$  is the pressure under the injector needle ( $\text{N}/\text{m}^2$ );  $F_{Cpi}$  is the restoring force of the needle spring of the injector (N);  $m_i$  is the mass of moving parts of the needle (kg);  $k_{Ti}$  is the coefficient of frictional force of the sealing part of the injector needle ( $\text{N} \cdot \text{s}/\text{m}$ );  $c_{pi}$  is the coefficient of spring stiffness of the injector needle (N/m);  $x_i$  is the injector needle displacement (m);  $x_{0i}$  is the preliminary deformation of the injector needle spring (m);  $t$  is the time, and  $h_{i(max)}$  is the maximum stroke of the injector needle (m).

Inequality describes the restrictions on the displacement of the injector needle when it is placed on the stops. To calculate the values of the fuel supply pressure by the plunger pair of the injection pump, when displacing the injector needle, the inverse modeling problem was used, which consisted of determining the time-varying values of the driving force  $F_{dvi}$  due to the pressure under the injector needle  $p_i$ , with known time-varying displacements of the injector needle mass  $m_i$  [12]. The inverse solution of the original differential equation (14) has the following form:

$$F_{dvi}(t) = A_i \cdot p_t(t) = m_i \cdot \frac{d^2 x_i}{dt^2} + k_{Ti} \cdot \frac{dx_i}{dt} + c_{pi} \cdot (x_i + x_{0i}); \quad (15)$$

then

$$p_t(t) = \frac{F_{dvi}(t)}{A_i},$$

The driving force  $F_{dv}(t)$  is nothing more than the fuel supply pressure per unit area of the injection pump plunger  $p_p$  without leakage  $Q_f$  through the coupling of the plunger-bushing, which causes a change in the technical condition of the plunger pair of the HPFP. To create a mathematical model, the leakage  $Q_f$  (13) was described by changing the fuel supply pressure along the plunger  $\Delta p_p$  in the empirical form:

$$\Delta p_p = \frac{\sqrt[3]{a_p (q_p - k_p) a_p^2 \ln b_p^2}}{a_p \ln b_p}, \quad (16)$$

where the variables  $a_p = \frac{\pi \cdot \beta_e \cdot \Delta p^2 \cdot \delta_p^3 \cdot d_p \cdot \ln(c_\mu)}{12 p_0 \cdot \delta_p \cdot l_p}$ ;  $b_p = c_\mu$ ;  $d_p = p_0$ ;  $k_p = \pi \cdot c_p \cdot d_p \cdot \frac{\delta_p}{2}$ ;  $q_p = Q_{pH}$ .

Then, the mathematical equation of the fuel supply pressure changes when the injector needle is displaced is as follows:

$$p_p = \frac{m_i \frac{d^2 x_i}{dt^2} + k_{tri} \frac{dx_i}{dt} + c_{pi} (x_i + x_{oi})}{A_i} + \Delta p_p, \quad (17)$$

$$p_p = p_t + \Delta p_p$$

Analysis of the structure of the differential equation (14) shows that the state of displacing the injector needle depends on the following factors: changes in the pressure of the diesel fuel under the working belt of the injector needle; viscosity of the fuel; the coefficient of rigidity of the injector needle spring; and preliminary tightening (deformation) of the needle spring, limiting the displacement of the needle and the radial clearance of the plunger-bushing of the HPFP. Therefore, to solve equation (17) of the inverse modeling problem and determine the dependence of the pressure change under the injector needle on the needle displacement, it is required to control the viscosity of the diesel fuel depending on its temperature.

The solution of this problem made it possible to confirm the possibility of applying the method of monitoring the technical state of the diesel engine FE elements by displacement of the injector needle and compare it with the maximum injection pressure control method. For this purpose, a mathematical model of fuel supply was used in the environment of visual graphic programming of Simulink (Matlab) on the basis of equations (1-14) with a diagnostic block based on equation (17). Due to the fact that the pressure wave of the fuel under the injector needle is shifted in time with respect to the pressure wave in the HPFP, a time displacement unit by the value  $t = \tau$  for the restored pressure value under the injector needle was introduced to compare the values.

Calculation of the lag time  $\tau$  of the pressure wave under the injector needle:

$$\tau = k_d \cdot \frac{L_{tr}}{a_v}, \quad (18)$$

where:  $L_{tr}$  is the length of the fuel line from the injection pump to the injector (m);  $a_v$  is the velocity of the pressure wave of fuel in the pipeline (m/s); and  $k_d$  is the wave deformation coefficient.

The parameters of the differential equations of mathematical models are chosen according to the technical characteristics of the KAMAZ-740.11 diesel engine [8]. Integration of the model of processes was carried out by the numerical method of computational mathematics – Runge–Kutta, 4, 5 orders with a variable integration step and an accuracy of 0.001, in the time interval 0 ... 0.04 s. The dependences of the changes in the instantaneous values of the pressure  $p_p$  in the HPFP and the pressure  $p_t$  in time  $t$  restored by the simulation are shown in Fig. 4.

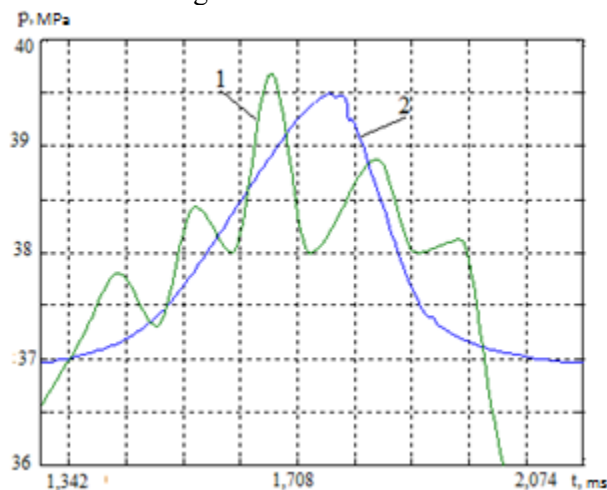

Fig. 4. Dependences of the time variation of pressure change in the HPFP and the pressure reconstructed by the simulation for the KAMAZ-740.11-240 diesel engine operating at a speed  $n = 600 \text{ min}^{-1}$  without load: (1) - mathematical interpolation data and (2) - simulation results

A comparative analysis of the dependencies of the time variation of the fuel supply pressure with the plunger pair of the HPFP (1) and the pressure reconstructed by simulation (2) (Fig. 4) showed that the restoration of the fuel supply pressure with the plunger pair, as the injector needle moves, cannot record

high-frequency pressure fluctuations due to the high mass of the latter. The difference in the maximum values of pressure is not more than 5%.

Thus, the conducted analytical studies show that the use of the diesel injector needle displacement as a diagnostic parameter will enable assessment of the technical condition of diesel fuel equipment.

## 2.2. Influence of the radial clearance "plunger-bushing" of the HPFP on the values of the maximum injection pressure of fuel and the displacement of the injector needle in the diagnostics

To assess the influence of the radial clearance of the plunger pair of the HPFP on the displacement of the injector needle and the maximum fuel supply pressure, we conducted laboratory studies of the KAMAZ-740.11-240 automotive tractor diesel engine at idle speed ( $n = 600 \text{ min}^{-1}$ ), the results of which are shown in the form of the dependencies in Fig. 5.

The KAMAZ-740.11-240 engine is a four-stroke 8-cylinder V-shaped unit with a capacity of 240 horsepower at 2,200 rpm, a compression ratio of 17 and a displacement of 10.86 liters, equipped with a divided fuel system with a multi-plunger high-pressure fuel pump.

To determine the displacement of the injector needle, a device shown in Fig.6 was used [7]. The injector design assumes that the displacement of the needle 12 is rigidly connected with the displacement of the injector arm with the rod 5. The rod of the injector arm, when the injector needle is raised, narrows the cross section of the beam emitter, proportionally reducing the amount of light flux to the receiver, which causes a voltage drop across the resistor of the electrical circuit of the needle displacement sensor. The values of voltage drop are measured with an oscilloscope.

The needle displacement sensor of the injector 12 is designed as an optical pair. As a receiver and a radiator, the photodiode BPW41N and the infrared LED BIR-BM1331 are used, respectively. The electrical circuit of the needle injector displacement sensor contains resistors R1, to limit the maximum current of the LED, and R2 to match the current of the oscilloscope channel.

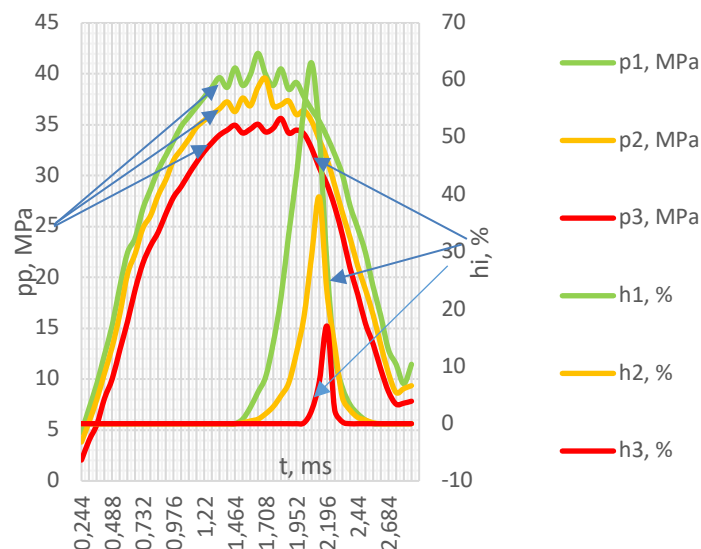

Fig. 5. Dependence of the injector needle displacement, the fuel supply pressure with the plunger pair in time on the radial clearance value of the plunger-bushing of the diesel engine HPFP KAMAZ-740.11-240: p1, h1 – respectively, the dependence of the change in the fuel supply pressure by the plunger pair of the HPFP in time with the value of the radial clearance plunger-bushing  $\Delta S = 4 \mu\text{m}$ ; p2, h2 – respectively, the dependence of the change in the fuel supply pressure by the plunger pair of the HPFP in time for the radial clearance of the plunger-bushing,  $\Delta S = 7 \mu\text{m}$ ; p3, h3 – respectively, the dependence of the pressure change of the fuel supply by the plunger pair of the HPFP in time, with the value of the radial clearance of the plunger-bushing  $\Delta S = 10 \mu\text{m}$



The pressure of the fuel supply by the plunger pair was determined at the stand. The displacement of the injector needle was evaluated by measuring the voltage at the photodiode resistance, which varied in proportion to the movement of the needle. For the convenience of the research, the displacement was presented in percent; 100% corresponds to the maximum stroke of 0.25 mm of needle displacement "with a setting at the stop".

An increase in the radial clearance of the plunger-bushing of the diesel engine HPFP  $\Delta S$  up to 10  $\mu\text{m}$  was found to lead to a decrease in the maximum fuel supply pressure by 6.52 MPa (15.5%) and a 43% decrease in the maximum displacement of the injector needle, which is indicative of the high information value of the diagnostic parameter. Also, an increase in the radial clearance of the plunger-bushing of the HPFP leads to a decrease in the speed of the injector needle displacement and the delay of its full opening by 0.122 ms.

On the curves of the fuel supply pressure variation (Fig. 5), there are high-frequency harmonic oscillations occurring due to the fuel throttling through the injector atomizer holes during the displacement of the injector needle. Their amplitude and period of oscillations change insignificantly with a gap of "plunger-bushing" no higher than 7-8  $\mu\text{m}$ . However, with an increase in the gap to 10  $\mu\text{m}$ , the pressure fluctuations decrease significantly, also showing a sharp decrease in the mobility of the injector needle. Also, the displacement of the injector needle reflects the duration of the fuel injection: the longer the needle moved, the more fuel came into the cylinder. An increase in the radial clearance of the plunger pair of the HPFP leads to a significant reduction in the cyclic fuel supply, which causes uneven operation of the engine cylinders and an increase in the dynamic loads on the engine parts.



a)

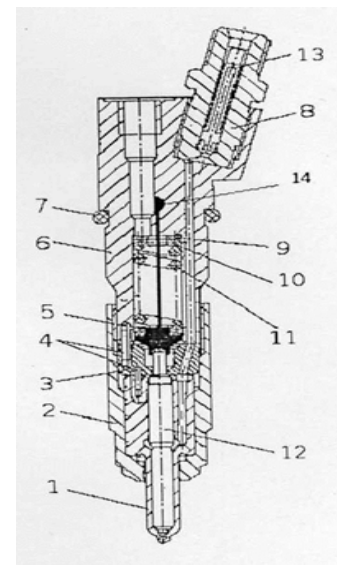

b)

Fig. 6. Device for diagnosing diesel fuel equipment: a - general view of the device; b - injector of a diesel internal combustion engine (RF patent No. 152362); 1 - the atomizer body of the injector; 2 - the atomizer nut; 3 - spacer; 4 - guide pins; 5 - the injector arm with a rod; 6 - the injector body; 7 - a sealing ring; 8 - injector connection; 9, 10 - adjusting washers; 11 - the atomizer spring; 12 - the needle of the nebulizer; 13 - slot filter; 14 - needle displacement sensor

The dependence of the displacement of the injector needle on the radial clearance of the plunger pair of the HPFP is linear (Fig. 7), which is characterized by a high correlation coefficient (0.9) of analytical and experimental studies.

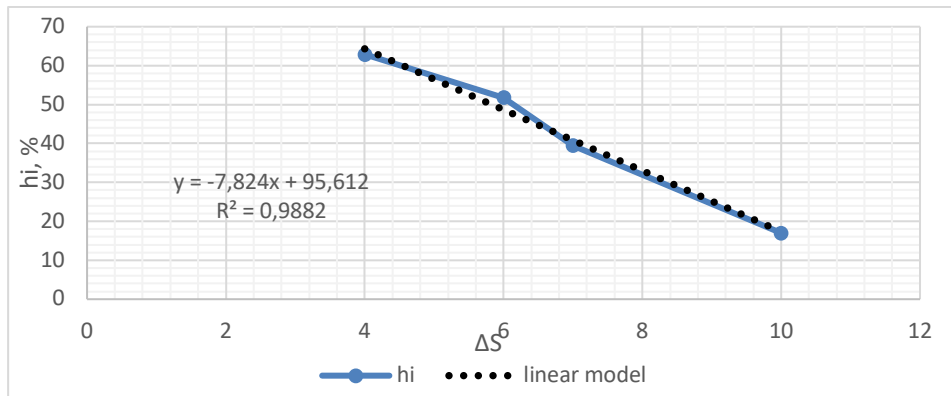

Fig. 7. Dependence of the diagnostic parameter  $h_i$  on the structural  $\Delta S$ :  $h_i$  – experimental data, linear [ $h_i$ ] – results of the linear regression

Operational studies of the injector needle displacement of the KAMAZ-740-11-240 diesel with a change in the fuel pressure and an increase in the radial clearance of the plunger pair of the HPFP are shown in Fig. 8.

That is, engine malfunction occurs when the value of the displacement of the injector needle is 32%, which corresponds to the maximum fuel-injection pressure of 38.1 MPa and maximum radial clearance of the plunger-bushing of the HPFP of 8  $\mu\text{m}$  when operating at idling speed.

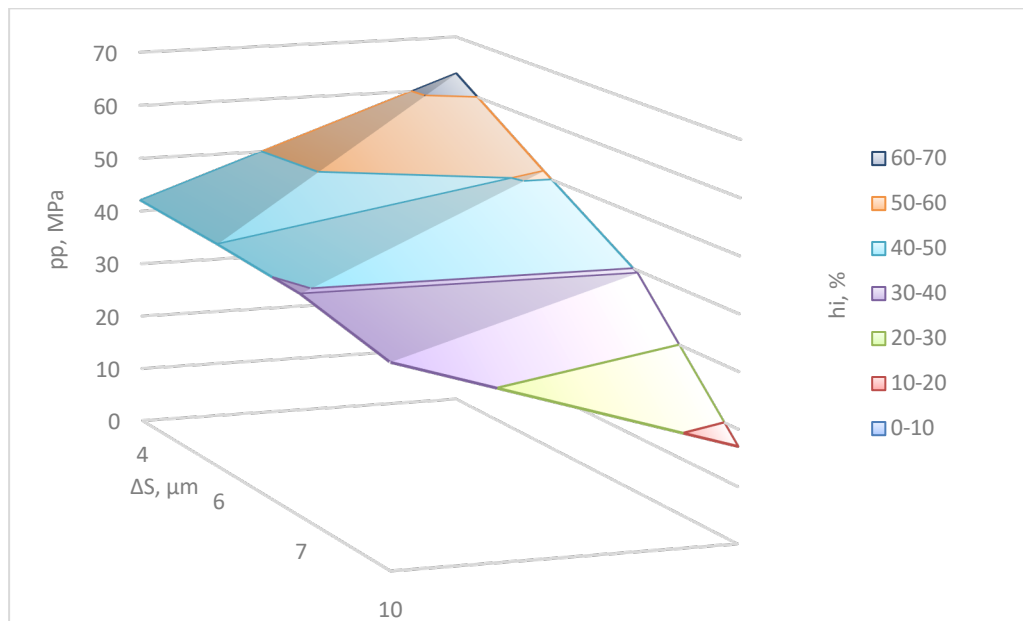

Fig. 8. Dependence of the maximum values of the injector needle displacement ( $h_i$ ) and the fuel supply pressure ( $pp$ ) on the radial clearance of the plunger-bushing of the HPFP ( $\Delta S$ )

### 3. CONCLUSIONS

Based on the analytical dependencies of mathematical models (10), (14), (17) and the resultant surface of interference of parameters (Fig. 7) as an example of the fuel equipment automotive diesel family KAMAZ 740.11-240 the following can be stated:

1. Increasing the radial clearance «plunger-bushing» of the HPFP of the KAMAZ ICE to 10  $\mu\text{m}$  reduces the maximum fuel injection pressure by 6.52 MPa (15.5%), and leads to a decrease in the maximum of injector needle displacement by 0.11 mm (43%) and a decrease in the speed of injector needle displacement and delay of its full opening by 0.122 ms.
2. The error in the value of the fuel supply by the plunger pair of the HPFP for the injector needle displacement at idling speed does not exceed 5%.
3. Improper operation of the diesel KAMAZ 740.11-240 occurs at a value of maximum injector needle displacement of 0.08 mm (32%), which corresponds to the maximum fuel injection pressure of 38.1 MPa and a maximum radial clearance plunger-bushing of the HPFP of 8  $\mu\text{m}$  when operating at minimum idling speed.

Thus, diagnosing auto-tractor diesel fuel equipment with multi-plunger HPFP by injector needle displacement is informative and can be used in the diagnostics, as well as the method of assessment of technical condition of the elements of diesel fuel equipment at the maximum injection pressure. Timely detection of engine failures will reduce operating costs.

### Acknowledgement

The publication was prepared with the support of the «RUDN University program 5-100».

### References

1. Агарков А.М. Общие вопросы диагностики двигателей. *Образование, наука, производство*. Белгород: Изд-во БГТУ, 2015. С. 910-914. [In Russian: Agarkov, A.M. General questions of diagnostics of engines. *Education, science, production*. Belgorod: Publishing House of the Baltic State Technical University. 2015. P. 910-914].
2. Грехов, Л.В. & Габитов, И.И. & Неговора, А.В. *Проектирование, расчет и техническое обслуживание систем подачи дизельного топлива*. Москва: Легион. 2013. 292 с. [In Russian: Grekhov, L.V. & Gabitov, I.I. & Negovora, A.V. *Design, calculation and technical service of fuel equipment of modern diesel engines: Textbook*. Moscow: Publishing House of the Legion. 2013. 292 p.]
3. Jaworski, A. & Kuszewski, H. & Lew, K. & Ustrzycki, A. Ocena przydatności paliw zastępczych do silników o ZS autobusów miejskich na podstawie wybranych parametrów wtrysku. *Systemy i Środki Transportu Samochodowego*. 2012. P. 143-148. [In Polish: Jaworski, A. & Kuszewski, H. & Lew, K. & Ustrzycki, A. Evaluation of the suitability of substitute fuels for engines with ZS of city buses on the basis of selected injection parameters. *Systems and means of transport of cars*. 2012. P. 143-148].
4. Gilles, T. *Automotive engines: Diagnosis, repair, rebuilding*. Sixth edition. Cengage Learning. 2010. 752 p.
5. Isermann, R. *Combustion engine diagnosis*. Springer Vieweg. 2017. 303 p.
6. James, D. *Advanced engine performance diagnosis*. Sixth edition. Paper. 2015. 432 p.
7. Данилов, И.К. & Марусин, А.В. & Марусин, А.В. Пат. РФ на ПИМ №152362, МПК F02M47/00. Форсунка дизельного двигателя внутреннего сгорания. Бил. №15, 2015. [In Russian: Danilov, I.K. & Marusin, A.V. & Marusin, A.V. Patent of the Russian Federation for utility model No. 152362, F02M47/00. Injection of a diesel engine of internal combustion. Bil. №15, 2015].
8. Грехов, Л.В. & Иващенко, Н.Ф. & Марков, В.Ф. *Топливные системы и дизельное управление*. Москва: Легион. 2005. 344 с. [In Russian: Grekhov, L.V. & Ivaschenko, N.F. & Markov, V.F. *Fuel systems and diesel control*. Moscow: Legion-Autodata. 2005. 344 p.]
9. Baratta, M. & Catania, A. & Ferrari, A. Hydraulic circuit design rules to remove the dependence of the injected fuel amount on dwell time in multijet CR systems. *ASME. J. Fluids Eng.* 2008. Vol. 130(12). P. 121104-121104-13. DOI:10.1115/1.2969443.

10. Sundarraman, P. & Baskaran, R. & Sunilkumar, V. & et al. Multibody dynamics modeling and experimental validation of fuel-injection pump. *ICORD 11: Proceedings of the 3rd International Conference on Research into Design Engineering*. Bangalore, India. 2011. P. 397-404.
11. Achleitner, E. & Bäcker, H. & Funaioli, A. Direct injection systems for Otto engines. *SAE Technical Paper*. 2007. No 2007-01-1416.
12. Catania, A.E. & Ferrari, A. & Manno, M. Development and application of a complete multijet common-rail injection-system mathematical model for hydrodynamic analysis and diagnostics. *ASME. J. Eng. Gas Turbines Power*. 2008. Vol. 130(6). P. 062809-1 - 062809-13. DOI: 10.1115/1.2925679.
13. Kouremenos, D.A. & Hountalas, D.T. & Kouremenos, A.D. Development and Validation of a Detailed Fuel Injection System Simulation Model for Diesel Engines. *SAE Technical Paper*. 1999. No 1999-01-0527.

Received 03.10.2018; accepted in revised form 06.03.2020