



UNIVERSIDADE DA BEIRA INTERIOR  
Ciências da Saúde

# Regucalcin regulation by extracellular calcium in prostate cells

Daniel Barreira Rodrigues

Master degree thesis in  
**Biomedical Sciences**  
(2<sup>nd</sup> cycle of studies)

Supervisor: Professor Cláudio Jorge Maia Baptista  
Co-supervisor: Professor Sílvia Cristina da Cruz Marques Socorro

Covilhã, June 2012



*"With the affairs of active human beings it is different. Here knowledge of truth alone does not suffice; on the contrary this knowledge must continually be renewed by ceaseless effort, if it is not to be lost. It resembles a statue of marble which stands in the desert and is continuously threatened with burial by the shifting sands. The hands of science must ever be at work in order that the marble column continue everlastingly to shine in the sun. To those serving hands mine also belong."*

Albert Einstein



## Acknowledgements

To begin I would like to thank my supervisors, Professors Cláudio Jorge Maia Baptista and Sílvia Cristina da Cruz Marques Socorro for their great scientific counseling, the guidance and help given when results simply refused to appear as well as their availability to provide answers to any of my questions or difficulties.

I am grateful to all my fellow colleagues and friends Carina Peres, Sara Correia, Luis Rato, Ricardo Marques, Inês Gomes and Margarida Gonçalves. Most special thanks are sent to Cátia Vaz who helped me overcome every difficulty that appeared over the time of this project and whose presence was vital for the outcome of this project.

I would also like to express my gratitude to our research group and to all present colleagues involved in the Health Sciences Research Center at the University of Beira Interior.

In last but not least I would like to thank my family and friends for the support provided over the last year and a special thanks to my housemates Tiago Ventura, Tiago Valente and Rui Soares for the good times spent. A most kind appreciation to my girlfriend for the patience revealed over time to bare my occasional bad moods and my endless conversions over my project.



## Abstract

Prostate cancer is one of the most diagnosed diseases in men at the present time. It is well known that changes in calcium ( $\text{Ca}^{2+}$ ) homeostasis are derived from modifications in  $\text{Ca}^{2+}$  regulating elements. Regucalcin (RGN) is a  $\text{Ca}^{2+}$ -binding protein which plays an important role in maintenance of intracellular  $\text{Ca}^{2+}$  homeostasis and regulation of apoptosis and proliferation. RGN is underexpressed in prostate cancer cells, suggesting that a loss of RGN expression may be associated with tumor development. In vivo studies have also shown that  $\text{Ca}^{2+}$  administration acts as a regulator of RGN expression in liver and kidney tissues. However, no studies on the characterization of RGN regulation by extracellular  $\text{Ca}^{2+}$  in prostate cells have been conducted. To attain this goal, prostate cells were stimulated with different doses of  $\text{CaCl}_2$  during several periods of time. To assess RGN mRNA and protein expression, Real Time PCR and Western Blot were carried out, respectively. Moreover, the cell viability in response to treatments was evaluated through MTS assays. Our results show that non-neoplastic PNT1A cells present higher levels of RGN when compared to neoplastic LNCaP or PC3 cells. We also verified that RGN expression in PNT1A cells is up-regulated by extracellular  $\text{Ca}^{2+}$  at 1,5h after stimuli, but its expression decreases after 3h of stimulation. We also showed that high doses of extracellular  $\text{Ca}^{2+}$  induce different effects on cell proliferation between PNT1A and LNCaP cells. This study led us to conclude that RGN appears to be regulated by extracellular  $\text{Ca}^{2+}$  levels in prostate cells and that an elevation of extracellular  $\text{Ca}^{2+}$  promotes high rates of cell proliferation in LNCaP cells, possibly due to the down-regulation in RGN expression in cancer cells.

## Keywords

Regucalcin, prostate, cancer, calcium, calcium sensing receptor





## Resumo

O cancro da próstata é de umas das doenças mais diagnosticadas em homens de países Ocidentais. É sabido que as alterações na homeostase do cálcio ( $\text{Ca}^{2+}$ ) derivam de modificações ao nível dos elementos reguladores do  $\text{Ca}^{2+}$ . A regucalcina (RGN) é uma proteína de ligação ao  $\text{Ca}^{2+}$  que desempenha um papel importante ao nível da manutenção da homeostase do  $\text{Ca}^{2+}$  intracelular, tal como na regulação da apoptose e da proliferação. A RGN é sub-expressa em células do cancro da próstata, sugerindo que a perda de expressão da RGN poderá estar associada com o desenvolvimento tumoral. Estudos *in vivo* mostram que a administração de  $\text{Ca}^{2+}$  actua como um regulador da expressão de RGN em fígado e de rim de rato. No entanto, ainda nenhum estudo acerca da caracterização da regulação da RGN pelo  $\text{Ca}^{2+}$  extracelular foi conduzido em células de próstata. Para atingir este objectivo, células da próstata foram estimuladas com diferentes doses de  $\text{CaCl}_2$  durante vários períodos de tempo. Para avaliar a expressão do mRNA e da proteína, estudos de Real Time PCR e de Western Blot foram efectuados, respectivamente. A viabilidade celular em resposta aos diferentes tratamentos foi avaliada através de ensaios de MTS. Os nossos resultados mostram que células não neoplásicas PNT1A apresentam níveis elevados de RGN quando comparados com células neoplásicas LNCaP e PC3. Também verificamos que a expressão de RGN em células PNT1A é regulada positivamente pelo  $\text{Ca}^{2+}$  extracelular às 1,5h de estímulo, sendo que a sua expressão começa a diminuir após as 3h. Mostramos ainda que elevadas doses de  $\text{Ca}^{2+}$  extracelular induzem diferentes efeitos ao nível da proliferação entre as células PNT1A e LNCaP. Este estudo levou-nos a concluir que a RGN aparenta ser regulada através do  $\text{Ca}^{2+}$  extracelular em células da próstata e que uma elevação nos níveis de  $\text{Ca}^{2+}$  extracelular poderá promover elevadas taxas de proliferação em células LNCaP, possivelmente devido a sub-expressão de RGN verificada em células tumorais.

## Palavras-chave

Regucalcina, próstata, cancro, cálcio, receptor sensível ao cálcio



## Resumo Alargado

O cancro da próstata encontra-se entre as doenças mais diagnosticadas em homens de países Ocidentais, sendo a sexta maior causa de morte em homens por cancro. Esta doença é caracterizada por um complexo processo multifásico que leva a mudança de uma célula normal para uma célula transformada, caracterizada pela diminuição do grau de diferenciação.

Diversos estudos demonstram que o cálcio ( $\text{Ca}^{2+}$ ) apresenta um papel importante na carcinogénese da próstata, com implicações na motilidade celular, vias de sinalização envolvidas na angiogénese, vias de resposta a danos no DNA, regulação celular, entre outros. Elevados níveis de  $\text{Ca}^{2+}$  apresentam um importante papel na indução da apoptose em células normais, mas em células cancerosas pode apresentar um efeito proliferativo. Estas alterações devem-se a uma desregulação na homeostase do  $\text{Ca}^{2+}$ , que poderá ser uma consequência de alterações dos elementos envolvidos na sua regulação. Várias proteínas encontram-se envolvidas na manutenção da homeostase do  $\text{Ca}^{2+}$ , tais como, canais e bombas de  $\text{Ca}^{2+}$  e ainda proteínas de ligação ao cálcio.

Este trabalho propõe estudar uma proteína de ligação ao  $\text{Ca}^{2+}$  com características um pouco diferentes das restantes, a regucalcina (RGN), pois esta não apresenta o domínio de ligação *EF-hand* característico deste tipo de proteínas. Esta proteína encontra-se sub-expressa em células cancerosas da próstata sugerindo que uma perda da expressão desta proteína poderá estar associada ao desenvolvimento tumoral. Esta proteína foi já associada a várias implicações em funções intracelulares tais como a regulação da apoptose e da proliferação celular. Estudos *in vivo* mostram que a administração de  $\text{Ca}^{2+}$  atua como um regulador da expressão da regucalcina no fígado e rim de rato. No entanto, ainda nenhum estudo acerca da caracterização da regulação da RGN pelo  $\text{Ca}^{2+}$  extracelular em células da próstata foi conduzido.

O objectivo deste projecto passa então por compreender o papel do  $\text{Ca}^{2+}$  extracelular na expressão da regucalcina em células não-neoplásicas e neoplásicas da próstata, assim como a sua correlação com os efeitos do  $\text{Ca}^{2+}$  na viabilidade celular. Para atingir estes objectivos uma série de tarefas foram delineadas. Numa fase inicial pretende-se caracterizar a expressão da RGN em diversas linhas celulares da próstata, e de seguida avaliar os efeitos do  $\text{Ca}^{2+}$  extracelular na expressão da regucalcina em células não-neoplásicas da próstata. Para além disso, os efeitos do  $\text{Ca}^{2+}$  extracelular na viabilidade celular assim como a expressão do receptor sensível ao cálcio (CaSR) foram determinados em células não-neoplásicas e neoplásicas da próstata. Para caracterizar a expressão da RGN em linhas celulares da próstata foram seleccionadas duas linhas não-neoplásicas (PNT1A e PNT2) e duas linhas neoplásicas (LNCaP e PC3). Os níveis de expressão da RGN foram avaliados por Real Time PCR e por Western Blot. Em seguida, procedeu-se a estimulação da linha não-neoplásica PNT1A com diferentes concentrações de cloreto de cálcio ( $\text{CaCl}_2$ ), nomeadamente 0mM, 1mM, 1,8mM e

3mM de  $\text{CaCl}_2$  ao longo de diferentes períodos de tempo (0h, 1.5h, 3h, 6h e 12h). Para avaliar a expressão da RGN utilizaram-se as técnicas de Real Time PCR e de Western Blot. Para avaliar os efeitos do  $\text{Ca}^{2+}$  extracelular na viabilidade de células não-neoplásicas e neoplásicas da próstata foram usadas duas linhas celulares diferentes, PNT1A e LNCaP, as quais foram submetidas a diferentes estímulos com  $\text{CaCl}_2$  (0mM, 1mM, 1,8mM, 3mM, 5mM e 10mM  $\text{CaCl}_2$ ) e durante diferentes intervalos de tempo (0h, 6h, 12h, 48h e 72h). Os níveis de viabilidade após estes estímulos foram determinados com recurso a ensaios de MTS. Por último caracterizou-se por PCR a expressão do receptor sensível ao cálcio (CaSR) nas linhas celulares PNT1A e LNCaP.

Os nossos resultados mostram que células não-neoplásicas PNT1A apresentam níveis elevados de RGN quando comparados com células neoplásicas LNCaP e PC3. Verificamos também que a expressão de RGN em células PNT1A é regulada positivamente pelo  $\text{Ca}^{2+}$  extracelular após 1,5h de estímulo, sendo que a sua expressão começa a diminuir após as 3h de estimulação. Estas diferenças de expressão foram identificados não só ao longo do tempo da experiência mas também em resposta às diferentes concentrações de  $\text{Ca}^{2+}$  extracelular, sendo que o pico máximo de expressão da RGN é obtido quando estimuladas com 3mM de  $\text{Ca}^{2+}$ . Mostramos ainda que elevadas doses de  $\text{Ca}^{2+}$  extracelular induzem diferentes efeitos ao nível da proliferação entre células PNT1A e LNCaP, e que apenas as células LNCaP expressam o CaSR.

Este estudo permite concluir que a expressão da RGN é regulada pelo  $\text{Ca}^{2+}$  extracelular em células da próstata. Concentrações elevadas de  $\text{Ca}^{2+}$  extracelular poderão promover maior taxa de proliferação nas células LNCaP, possivelmente devido reduzidos níveis de RGN nas células tumorais.



# Index

I.	General Introduction .....	1
1	Overview .....	1
2	Brief description of prostate anatomy and physiology .....	1
3	Androgens and Calcium in prostate carcinogenesis .....	4
4	Regucalcin .....	10
4.1	Gene/Protein Structure .....	11
4.2	Regulation of gene expression .....	12
4.3	Calcium homeostasis .....	13
4.4	Cell Cycle .....	15
4.5	Expression in cancer .....	17
II.	Objectives.....	18
III.	Materials and Methods .....	19
1	Cell Culture and treatment .....	19
2	Cell Viability assays .....	19
3	cDNA Synthesis .....	19
4	Real Time and RT- PCR .....	20
5	Protein extraction and Western Blot Analysis .....	21
6	Statistical Analysis.....	21
IV.	Results .....	22
1	Expression of regucalcin in human prostatic cell lines .....	22
2	Regucalcin is up-regulated in PNT1A cells by extracellular Ca <sup>2+</sup> .....	23
3	Effects of extracellular Ca <sup>2+</sup> in cell proliferation of prostate cell lines .....	25
4	Expression of CaSR in human prostatic cell lines .....	26
V.	Discussion .....	27
VI.	Future Perspectives .....	30
VII.	References .....	31



## List of Figures

<b>Figure 1:</b> Pelvic part of ureteres, urinary bladder, seminal glands, terminal parts of ductus deferens, and prostate .....	2
<b>Figure 2:</b> Anatomy of the human prostate gland .....	3
<b>Figure 3:</b> Prostate cancer evolution after androgen deprivation therapy. ....	5
<b>Figure 4:</b> Calcium-signaling dynamics and homeostasis .....	6
<b>Figure 5:</b> Ca <sup>2+</sup> channels, pumps and exchangers and important regulatory domains. ....	8
<b>Figure 6:</b> Extracellular calcium acts as a genuine first messenger by binding to the calcium-sensing receptor .....	10
<b>Figure 7:</b> Alignment of the exons for the rat regucalcin gene with the cDNA.....	11
<b>Figure 8:</b> The transcription activity of regucalcin gene is regulated through various cell signaling factors.....	12
<b>Figure 9:</b> Putative transcription factor binding sites in the promoter region of mouse SMP30 genomic locus. ....	13
<b>Figure 10:</b> Regucalcin has a pivotal role in keeping intracellular Ca <sup>2+</sup> homeostasis that is attenuated with various stimulating in cells.....	14
<b>Figure 11:</b> Regucalcin has a role as suppressor in cell death and apoptosis induced by various factors .....	16
<b>Figure 12:</b> Regucalcin mRNA expression in non-neoplastic (PNT1A and PNT2) and neoplastic (PC3 and LNCap) prostate cell lines determined by Real Time PCR .....	22
<b>Figure 13:</b> Regucalcin protein expression in non-neoplastic (PNT1A and PNT2) and neoplastic (PC3 and LnCaP) prostate cell lines determined by Western Blot .....	23
<b>Figure 14:</b> Effect of extracellular Ca <sup>2+</sup> on regucalcin mRNA expression in non-neoplastic (PNT1A) prostate cell line determined by Real Time PCR.....	24
<b>Figure 15:</b> Effect of extracellular Ca <sup>2+</sup> on regucalcin protein expression in non-neoplastic PNT1A prostate cell line determined by Western Blot .....	25
<b>Figure 16:</b> MTS cell viability of non-neoplastic PNT1A and neoplastic LNCap cell lines.....	26
<b>Figure 17:</b> CaSR mRNA is differentially expressed between neoplastic LNCaP and non-neoplastic PNT1A prostate cells.....	26





## List of Tables

Table 1: PCR primer sequences and amplicon size.....	20
--	----



## List of Abbreviations

$\text{Ca}^{2+}$	Calcium
PZ	Peripheral zone
CZ	Central zone
TZ	Transitional zone
PUZ	Periurethral zone
PAP	Prostatic acid phosphatase
PSA	Prostate specific antigen
ARs	Androgen receptors
DHT	Dihydrotestosterone
PC	Prostate Cancer
ER	Estrogen receptor
EGFR	Epidermal growth factor receptor
PIN	Prostatic intraepithelial neoplasia
ER	Endoplasmic reticulum
SR	Sarcoplasmic reticulum
IP3	Inositol-1,4,5-trisphosphate
cADPR	Cyclic ADP ribose
NAADP	Nicotinic acid adenine dinucleotide phosphate
S1P	Sphingosine-1-phosphate
$[\text{Ca}^{2+}]_o$	Extracellular calcium
CaSR	Extracellular calcium-sensing receptor
$[\text{Ca}^{2+}]_{cyt}$	Intracellular $\text{Ca}^{2+}$ levels
TRP	Transient receptor potential
SERCAs	Sarcoplasmic/endoplasmic reticulum $\text{Ca}^{2+}$ -ATPases
PMCA <sub>s</sub>	Plasmalemmal $\text{Ca}^{2+}$ -ATPases
PTP	Permeability transition pore
AIF	Apoptosis-inducing factor
CAM	Calmodulin
NFAT	Nuclear factor of activated T cells
VEGF	Vascular endothelial growth factor
DREAM	Downstream regulatory element antagonist modulator
GPCR	G-protein-coupled receptor
cAMP	Cyclic AMP
EGFR	Epidermal growth factor receptor
SMP30	Senescence marker protein-30
$\text{CaCl}_2$	Calcium chloride

<b>TNF-<math>\alpha</math></b>	Tumor necrosis factor
<b>ATPase</b>	Adenosine 5'-triphosphatase
<b>NO</b>	Nitric oxide
<b>TGF-<math>\beta</math>1</b>	Growth factor- $\beta$ 1



# I. General Introduction

## 1 Overview

Prostate cancer is one of the most diagnosed diseases in men at the present time, becoming the sixth leading cause of death by cancer in men (1). This disease is considered a complex multistep process that turns a normal cell into a transformed cell, characterized by the lack of differentiation and that may proliferate indefinitely (2).

It is well known that calcium ( $\text{Ca}^{2+}$ ) plays an important role in prostate cancer such as cellular motility (3, 4), signaling pathways involved in angiogenesis (5), DNA damage response pathways (6), transcription regulation (7) and others. High levels of  $\text{Ca}^{2+}$  play an important role in apoptosis induction in normal cells (8), but in cancer cells it has been shown a proliferative effect triggered by  $\text{Ca}^{2+}$  (9).

These changes in  $\text{Ca}^{2+}$  homeostasis are greatly given by modifications in  $\text{Ca}^{2+}$  regulating elements. Several proteins are involved in maintenance of  $\text{Ca}^{2+}$  homeostasis, such as  $\text{Ca}^{2+}$  channels, pumps, and calcium-binding proteins. We propose to study a quite different  $\text{Ca}^{2+}$  binding protein, regucalcin, which does not contain EF-hand motif of calcium-binding domains (10). This protein is down-regulated in prostate cancer cells, suggesting that a loss of regucalcin expression may in part be associated with tumor development (11). This protein was found to have implications in various intracellular functions such as regulating apoptosis and proliferation. *In vivo* studies have also shown that  $\text{Ca}^{2+}$  administration acts as a regulator of regucalcin expression in liver (12) and kidney tissues (13). Therefore, the aim of this study is to understand the role of extracellular calcium in regucalcin expression in normal and neoplastic prostate cells, as well as its correlation with the effects of  $\text{Ca}^{2+}$  on cellular viability.

## 2 Brief description of prostate anatomy and physiology

The prostate is an accessory organ of the male reproductive tract and is about 4 cm across and 3 cm thick, resembling the size and shape of a chestnut. It is considered the largest accessory gland of the male reproductive system and lies immediately below the urinary bladder, where it surrounds the beginning portion of the urethra (Figure 1). The glandular tissue makes up approximately two thirds of the prostate, and the other third is fibromuscular. The prostate is enclosed by a fibrous capsule which is dense and neurovascular, incorporating the prostatic plexus of veins and nerves. Its lobes are formed by the urethra and the ejaculatory ducts that extend through the gland. The ducts from the lobes open into the urethra (14).

This gland provides some of the constituents in the semen, producing a thin and milky-colored prostatic secretion which allows sperm cell motility. The alkalinity of prostatic

fluids helps to protect the sperm in their passage through the acidic environment of the female vagina. This secretion contains calcium, citrate and phosphate ions, a clotting enzyme and profibrinolysin. The prostate also secretes the enzyme prostatic acid phosphatase (PAP), which is often measured clinically to assess prostate function. The discharge from the prostate makes up about 30% of the volume of the semen (15-17). These secretions are carried out to the prostatic urethra through fifteen to thirty small prostatic ducts (18).

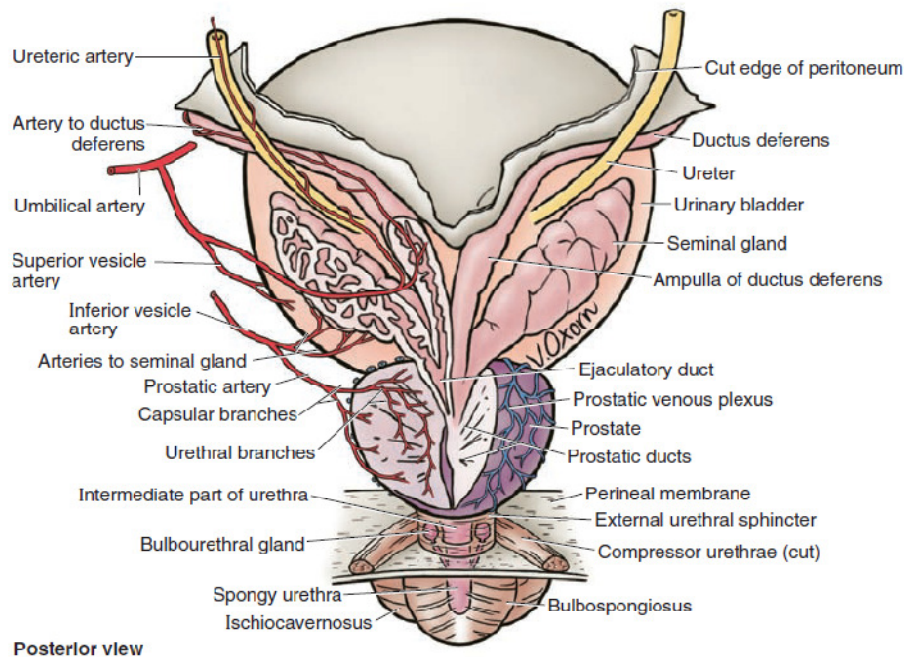

**Figure 1** Pelvic part of ureteres, urinary bladder, seminal glands, terminal parts of ductus deferens, and prostate (14).

A great number of models have been proposed over time to account for the clinical anatomy and pathology of the human prostate. According to the McNeal approach which divides the prostate into 4 distinct zones: the peripheral zone (PZ), a central zone (CZ), a transitional zone (TZ), and periurethral zone (PUZ) (19-21) (Figure 2). The PZ constitutes about 70% of the glandular part of the prostate and is the zone from where almost all carcinomas arise. The CZ is surrounded by the PZ in its distal part and comprises of 25% of the glandular prostate that surrounds the ejaculatory ducts. The TZ reveals a clinical importance because it grows with age and it is the commonest site where benign prostatic hypertrophy originates. Finally, the PUZ is within the TZ but presenting only a fraction of its size (19, 22).



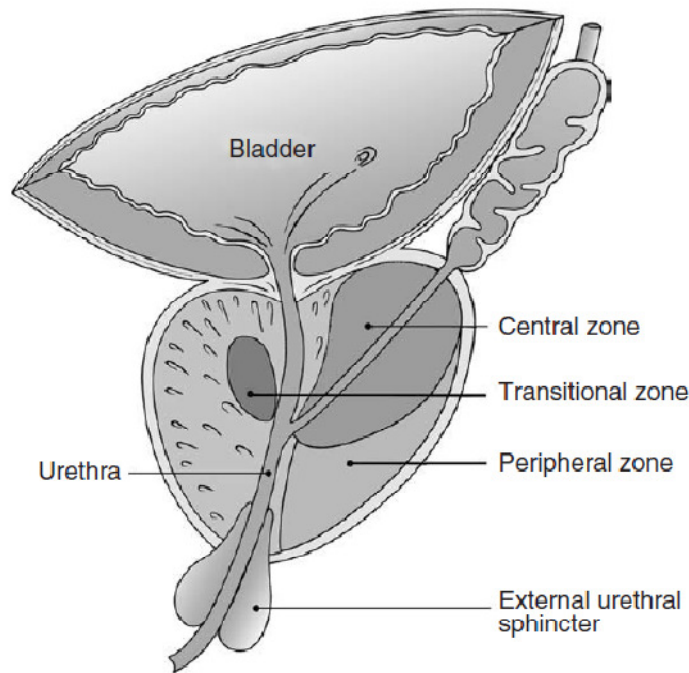

**Figure 2** Anatomy of the human prostate gland. The prostate gland is divided into zones, including the central zone, peripheral zone, and transitional zone (23).

Prostate epithelium is composed of three types of cells: the secretory epithelial cells, the basal cells, and a small number of neuroendocrine cells. The secretory cells include the exocrine compartment of the prostate epithelium, characterized as columnar luminal cells that synthesize and secrete proteins, including prostate-specific antigen (PSA) and PAP (15, 19, 20, 24, 25). Secretory cells express high levels of androgen receptors (ARs) and are androgen dependent, therefore requiring testosterone for their survival. Besides this androgen, secretory cells reveal being more responsive to the reduced metabolite dihydrotestosterone (DHT) for maintaining secretory activity (26). The basal cells lie beneath the secretory cells and appear as flattened, forming a continuous layer of cells abutting the basement membrane (19, 27). These cells are also identified by a lack of expression of the major prostatic secretory proteins, such as PSA and PAP (28). Unlike secretory epithelial cells, the basal cells are androgen independent, yet they are androgen responsive (29); in other words they are not reliant on androgens for maintenance and survival, but their growth and differentiation is stimulated by androgens. AR expression is low in basal cells compared with secretory epithelial cells, consistent with their ability to be androgen independent, but also androgen responsive (30, 31).

Androgens regulate several important functions within the epithelial compartment such as cellular proliferation, differentiation, as well as metabolic and secretory functions. The primarily role of AR is to maintain the differential secretory function of prostate epithelial cells (15, 32).

### 3 Androgens and Calcium in prostate carcinogenesis

Prostate cancer (PC) is the second most frequently diagnosed cancer in men which is equivalent to 913 000 new cases per year equivalent to 13.6% of the total cases occurred. It is the fifth most common cancer overall with an estimated 261 000 deaths in 2008, making PC the sixth leading cause of death from cancer in men (1). Nearly three-quarters of the registered cases occur in developed countries (644 000 cases), possibly due to the practice of PSA testing and subsequent biopsy (1).

Cancer is a complex multistep process that turns a normal cell into transformed cell, characterized by the lack of differentiation and that may proliferate indefinitely. From a clinical point of view, cancer is a large group of diseases that vary in their age of onset, rate of growth, state of cellular differentiation, invasiveness, metastatic potential, response to treatment, and prognosis. From a molecular point of view, cancer may be a relatively small number of diseases caused by similar molecular defects in cell function resulting from common types of alterations to a cell's genes (2)

Tumors cells are composed of multiple distinct cells types that participate in heterotypic interactions with one another (33). Six hallmarks of cancer comprise biological capabilities acquired during the multistep development of human tumors, namely sustained proliferative signaling, ability to evade growth suppression, resistance to death, immortality, angiogenesis induction, active invasion and metastasis. Beyond these hallmarks tumor microenvironment, they also revealed the ability to alter or reprogram cellular metabolism, as well as, evading immunological destruction. All these aspects lead to genomic instability and thus mutability and inflammation support for multiple hallmark capabilities (33). These changes may occur via gene mutation, translocation, amplification, deletion, loss of heterozygosity, or via a mechanism resulting from abnormal gene transcription or translation. The overall result is an imbalance between cell proliferation and cell death in a tumor cell population that leads to an expansion of tumor tissue (2).

Prostate physiology is highly dependent of androgens and  $\text{Ca}^{2+}$ . The deregulation of  $\text{Ca}^{2+}$  homeostasis may lead to the development and progression of PC cells. The mechanisms underlying the role of androgens and  $\text{Ca}^{2+}$  in prostate cells must be explored in order to better understand the process of prostate carcinogenesis.

The prostate gland is known for being an androgen-dependent tissue (34). The activation of AR by androgens is required for the growth and survival of malignant prostate cells. The great majority of PCs initially suffer regression when submitted to androgen ablation therapy, but basically all cases become hormone independent (35, 36) (Figure 3). This last is more aggressive and metastatic phenotype, reflecting in a resistance to hormonal therapy and ultimately causing death (37). In this stage of cancer, the AR remains strongly expressed and active, even in the absence of androgens (36, 38). It remains a critical factor for growth and survival of the majority of tumors (15, 39, 40).

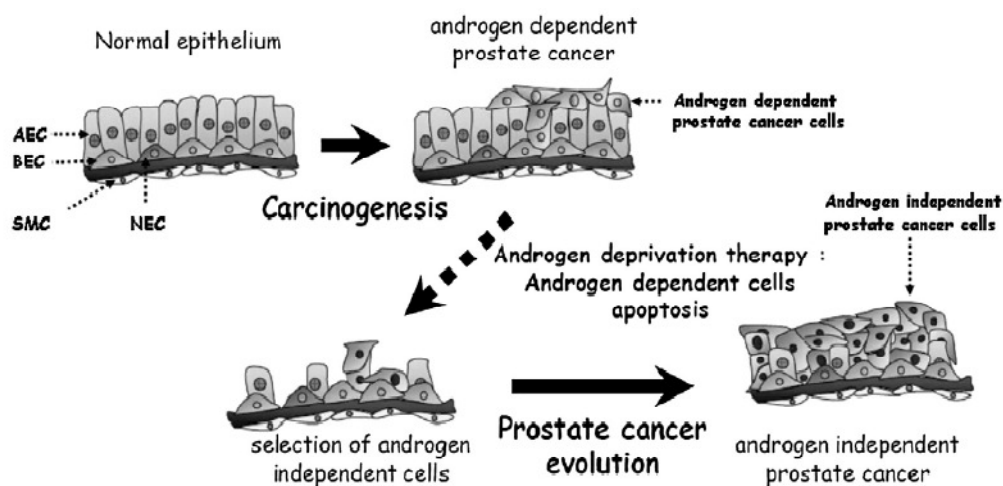

**Figure 3** Prostate cancer evolution after androgen deprivation therapy (AEC: apical epithelial cells, BEC: basal epithelial cells, SMC: smooth muscle cells, NEC: neuroendocrine cells) (41).

The activation of multiple signaling pathways such as AR, estrogen receptor (ER), epidermal growth factor receptor (EGFR), HER-2, hedgehog and Wnt/b-catenin, may confer the aggressive phenotypes that are observed in high prostatic intraepithelial neoplasia (PIN) (42). In this particular phenotype various changes are noted, such as AR gene amplification, altered expression and function of AR co-activators, and ligand-independent AR activation through stimulation of alternate signal transduction pathways (35, 43, 44), as well as local production of androgen within the castration resistant tumor (45, 46).

The AR can also acquire mutations to become either hypersensitive to androgens, facilitate AR function due to altered interactions with AR co-regulators, or expand AR ligand specificity when these mutations occur in the ligand-binding domain. This last ensures that the receptor can be promiscuously activated by a broad group of steroids, including estrogens, progestins, adrenal steroids, and even anti-androgens (47-49). These types of mutations appear to be more frequent on more advanced tumors or recurrent tumors rather than early stages of prostate cancer (50).

$\text{Ca}^{2+}$  acts as a ubiquitous intracellular signal responsible for controlling numerous cellular processes. It acts as second messenger for the common signal transduction in cells and plays a central role in the regulation of many aspects of cell physiology, with implications in processes such as cancer growth, cell cycle progression, cell migration, angiogenesis, apoptosis and proliferation (51-53).  $\text{Ca}^{2+}$  can play a direct role in controlling the transcriptional events that select out the types of  $\text{Ca}^{2+}$  signaling systems that are expressed in specific cell types (53). When deregulation of cell differentiation and proliferation are verified together with the suppression of apoptosis, conditions for abnormal tissue growth are provided (41, 54).

Every cell type expresses a unique set of components from the  $\text{Ca}^{2+}$ -signaling toolkit to create  $\text{Ca}^{2+}$ -signaling systems with different spatial and temporal properties.  $\text{Ca}^{2+}$  is regulated by a complex signaling toolkit, composed of various signaling components which

include receptors, transducers, channels,  $\text{Ca}^{2+}$  buffers,  $\text{Ca}^{2+}$  effectors, calcium-sensitive enzymes and processes as well as  $\text{Ca}^{2+}$  pumps and exchangers that when mixed and matched can create diverse arrays of signaling responses (55).

Almost all  $\text{Ca}^{2+}$ -signaling systems are based on the principle that they act through the generation of brief pulses of  $\text{Ca}^{2+}$ , called transients. These  $\text{Ca}^{2+}$  transients are created by variations of the basic on/off reactions, creating signals with widely different spatial and temporal profiles (53, 55) (Figure 4).  $\text{Ca}^{2+}$  signals are derived either from internal stores or from the external medium. When derived from external stores, there are many different plasma-membrane channels that control  $\text{Ca}^{2+}$  entry from the external medium in response to stimuli that include membrane depolarization, stretch, noxious stimuli, extracellular agonists, intracellular messengers and the depletion of intracellular stores. When the stimuli occurs from internal stores, the release of  $\text{Ca}^{2+}$  from the endoplasmic reticulum (ER) or its muscle equivalent, the sarcoplasmic reticulum (SR) is controlled by  $\text{Ca}^{2+}$  itself. This release can also be mediated by a group of messengers, such as inositol-1,4,5-trisphosphate (IP3), cyclic ADP ribose (cADPR), nicotinic acid adenine dinucleotide phosphate (NAADP) and sphingosine-1-phosphate (S1P), that either stimulate or modulate the channels activity on the internal stores (55).

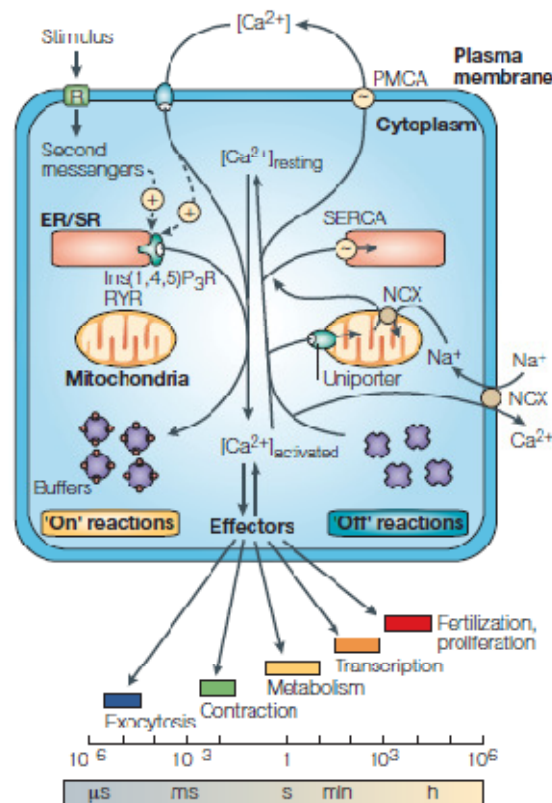
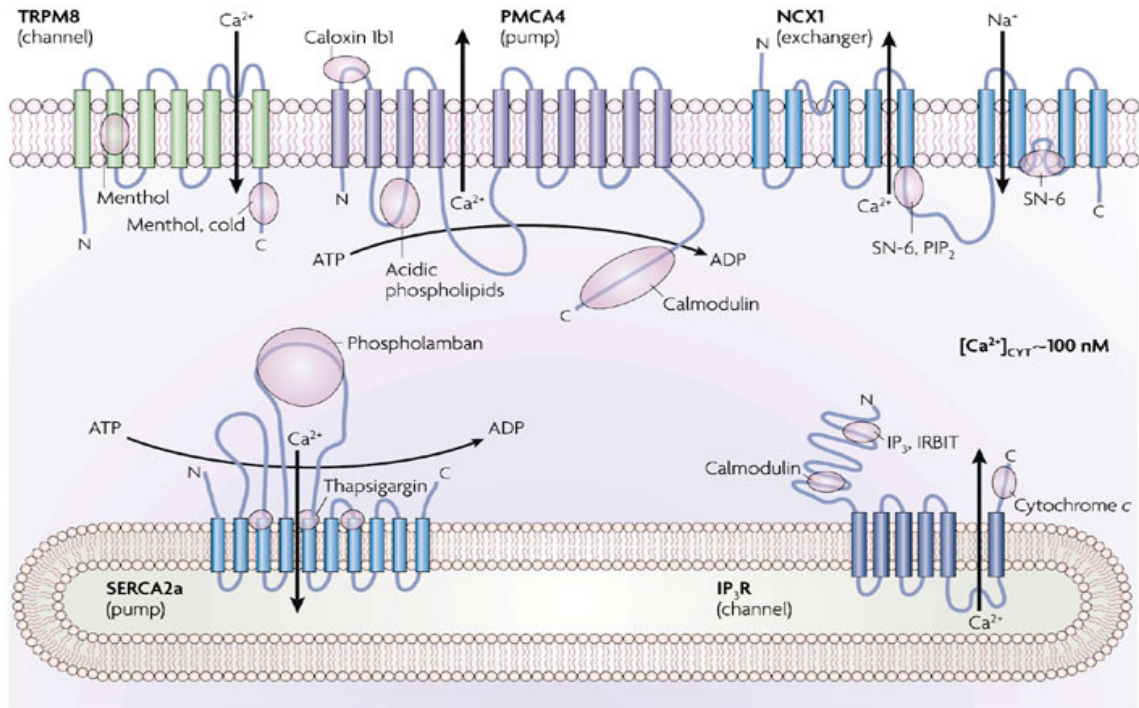

**Figure 4** Calcium-signaling dynamics and homeostasis. During the ‘on’ reactions, stimuli induce both the entry of external  $\text{Ca}^{2+}$  and the formation of second messengers that release internal  $\text{Ca}^{2+}$  that is stored within the endoplasmic/ sarcoplasmic reticulum (ER/SR). Most of this  $\text{Ca}^{2+}$  (shown as red circles) is bound to buffers, whereas a small proportion binds to the effectors that activate various cellular processes that operate over a wide temporal spectrum. During the ‘off’ reactions,  $\text{Ca}^{2+}$  leaves the effectors and buffers and is removed from the cell by various exchangers and pumps (55).

The  $\text{Ca}^{2+}$  signaling network can be divided into four major functional units. In a first phase, signaling is triggered by a stimulus that generates various  $\text{Ca}^{2+}$ -mobilizing signals, followed by an activation of the ON mechanisms that feed  $\text{Ca}^{2+}$  into the cytoplasm. Afterwards,  $\text{Ca}^{2+}$  acts as a second messenger to stimulate numerous  $\text{Ca}^{2+}$ -sensitive processes and finally, the OFF mechanisms, composed of pumps and exchangers, that remove  $\text{Ca}^{2+}$  from the cytoplasm to restore the resting state (53).

$\text{Ca}^{2+}$  homeostasis is highly regulated within cellular compartments to achieve the sensitive regulation of cell signaling pathways that can precisely respond to many stimuli. The levels of extracellular free calcium ( $[\text{Ca}^{2+}]_o$ ) is within a narrow range of about 1.1 to 1.3 mM (56, 57), ensuring that  $\text{Ca}^{2+}$  ions are available for their extracellular roles, including as a cofactor for various proteins, namely clotting factors and adhesion molecules (57).  $[\text{Ca}^{2+}]_o$  may act on cells functions mainly through the extracellular calcium-sensing receptor (CaSR), namely in regulation of cell proliferation, differentiation, and apoptosis (58). Intracellular  $\text{Ca}^{2+}$  levels ( $[\text{Ca}^{2+}]_{\text{CYT}}$ ) play an important role in the regulation of cellular processes such as muscular contraction, cellular motility, differentiation and proliferation, hormonal secretion and apoptosis.  $[\text{Ca}^{2+}]_{\text{CYT}}$  are maintained at low levels, about 100nM (59), when compared to the levels of ( $[\text{Ca}^{2+}]_o$ ) described previously.  $\text{Ca}^{2+}$  ions cross the plasma membrane through various types of ion channels and other transport systems (55).

There are three major classes of membrane-associated proteins that are directly involved in  $\text{Ca}^{2+}$  homeostasis: channels, ATPases (pumps) and exchangers (60, 61) (Figure 5).  $\text{Ca}^{2+}$  channels allow diffusion of  $\text{Ca}^{2+}$  down its concentration gradient, and provide the flow of  $\text{Ca}^{2+}$  out of the ER into the cell cytosol. Some of these channels include the IP3 receptor and ryanodine-activated  $\text{Ca}^{2+}$  channels. Plasma membrane channels, such as the voltage-gated  $\text{Ca}^{2+}$  and transient receptor potential (TRP) ion channels are also involved in the influx of  $\text{Ca}^{2+}$  across the plasma membrane into the cell.  $\text{Ca}^{2+}$  pumps are known to transport  $\text{Ca}^{2+}$  against a concentration gradient; some of these pumps include the sarcoplasmic/endoplasmic reticulum  $\text{Ca}^{2+}$ -ATPases (SERCAs) the plasmalemmal  $\text{Ca}^{2+}$ -ATPases (PMCAs). SERCAs pump  $\text{Ca}^{2+}$  into the ER while the PMCAs are responsible for the efflux of  $\text{Ca}^{2+}$  across the plasma membrane and out of the cell.  $\text{Ca}^{2+}$  exchangers, such as the plasmalemmal  $\text{Na}^+/\text{Ca}^{2+}$  exchanger make use of the existing  $\text{Na}^+$  gradient to transport  $\text{Ca}^{2+}$  (60, 61).



**Figure 5**  $\text{Ca}^{2+}$  channels, pumps and exchangers and important regulatory domains. Arrows show possible directions for  $\text{Ca}^{2+}$  transport (note that the  $\text{Na}^+/\text{Ca}^{2+}$  exchanger (NCX1) can transport  $\text{Ca}^{2+}$  in either direction depending on the concentration gradients for  $\text{K}^+$ ,  $\text{Na}^+$  and  $\text{Ca}^{2+}$  across the plasma membrane<sup>13</sup>). Pink shapes indicate binding sites of modulators. Depictions of  $\text{Ca}^{2+}$  transporters are schematic; some channels such as TRPM8 and IP<sub>3</sub> receptor are functional as multimers (6).

Apoptosis is an important cellular process in which  $\text{Ca}^{2+}$  takes part through  $\text{Ca}^{2+}$  dependent mechanisms. Although interrelated, these mechanisms may be subdivided in cytoplasmic, mitochondrial and ER-mediated.

Cellular  $\text{Ca}^{2+}$  overload may be provoked by various types of stimuli, leading to mitochondrial  $\text{Ca}^{2+}$  uptake. Apoptosis as well as necrosis are often linked to accumulation of excessive  $\text{Ca}^{2+}$  by the mitochondria and activation of mitochondrial membrane permeabilization (7, 8). This is partly mediated by the opening of permeability transition pore (PTP). PTP opening allows release of mitochondrial apoptosis-inducing factor (AIF) into the cytoplasm where it, in turn activates death-executing caspase cascade (54). Initial cytosolic overload can also induce cell death by a rather different mechanism, involving the activation of calcium/calmodulin (CAM)-dependent phosphatase, calcineurin. Calcineurin-catalyzed dephosphorylation promotes apoptosis by regulating the activity of a number of downstream targets, such as pro-apoptotic Bcl-2 family member Bad (62), transcription factors from the nuclear factor of activated T cells (NFAT) family (63), several DNA-degrading enzymes (64) and  $\text{Ca}^{2+}$ -activated cysteine proteases of calpain family. ER acts as a dynamic organelle providing the main storage place for  $[\text{Ca}^{2+}]_{\text{cyt}}$ . The so called ER stress may result from a disturbance in  $\text{Ca}^{2+}$  homeostasis or newly synthesized protein processing and is a critical determinant in apoptosis. It has been shown that ER stress activates specific ER-localized

capase-12 with in turn triggers a cascade of reactions leading to the activation of other caspases in a mitochondria and Cyt-c-independent manner. Reduction in the  $\text{Ca}^{2+}$  content of the lumen of the ER is known to be associated with resistance to apoptosis (8, 65).

As referred previously, high  $\text{Ca}^{2+}$  levels in normal cells leads to apoptosis. In cancer cells, an elevation in  $[\text{Ca}^{2+}]_o$  promotes the proliferation of PC cell line PC-3, but no effects were observed in the LNCaP cell line (9).

Beyond normal physiological processes,  $\text{Ca}^{2+}$  is also implicated in various processes related to carcinogenesis, such as cellular motility which is considered an important aspect of tumor invasion and metastasis (3, 4).  $\text{Ca}^{2+}$  is considered a key regulator of signaling pathways important in angiogenesis. Vascular endothelial growth factor (VEGF), known as an angiogenic stimulator, can increase  $[\text{Ca}^{2+}]_{\text{CYT}}$  by mobilizing  $\text{Ca}^{2+}$  release from internal stores (5). This ion can also modulate some aspects of DNA damage response pathways, influencing genomic stability and cell survival (6).  $\text{Ca}^{2+}$  levels are also implicated in transcription regulation (7). This regulation can occur indirectly through  $\text{Ca}^{2+}$  oscillations for the transcription of nuclear NFAT, or directly through the downstream regulatory element antagonist modulator (DREAM) (60). The  $\text{Ca}^{2+}$  effector S100A8 protein is known to inhibit the activity of telomerase, which is an enzyme that stabilizes telomeres and contributes to cell immortality (66). Cancer cells have the ability to dedifferentiate in the tumorigenic process, where  $\text{Ca}^{2+}$  signaling acts in the differentiation process either through the CaSR and/or through alterations in  $[\text{Ca}^{2+}]_{\text{CYT}}$  (67).  $\text{Ca}^{2+}$  acts as a key regulator of the cell cycle through various signaling pathways, including regulation of Ras activity (68).  $\text{Ca}^{2+}$  can also indirectly regulate the subcellular localization of key proteins associated with tumorigenesis (69). In addition,  $\text{Ca}^{2+}$  can also indirectly modulate cell-cycle regulators such as activating the transcription of immediate early genes important in the G0-G1 transition and for the phosphorylation of retinoblastoma protein in late G1 phase (70).

$[\text{Ca}^{2+}]_o$  mainly acts on cells through the CaSR. CaSR is a heterotrimeric G-protein-coupled receptor (GPCR), composed of at least 2  $G\alpha$  subunits involved in its transmembrane signaling,  $G\alpha_i$  and  $G\alpha_q$ . The activation of the CaSR, via either  $G\alpha_i$  or  $G\alpha_q$ , leads to the inhibition of adenylyl cyclase. Therefore, there is a decrease of cyclic AMP (cAMP) levels, and phospholipase C becomes active to produce IP3 (58, 71, 72) (Figure 6). Activated CaSR is also known to transactivate the epidermal growth factor receptor (EGFR) which is followed by ERK1/2 activation and PTHrP release (73).



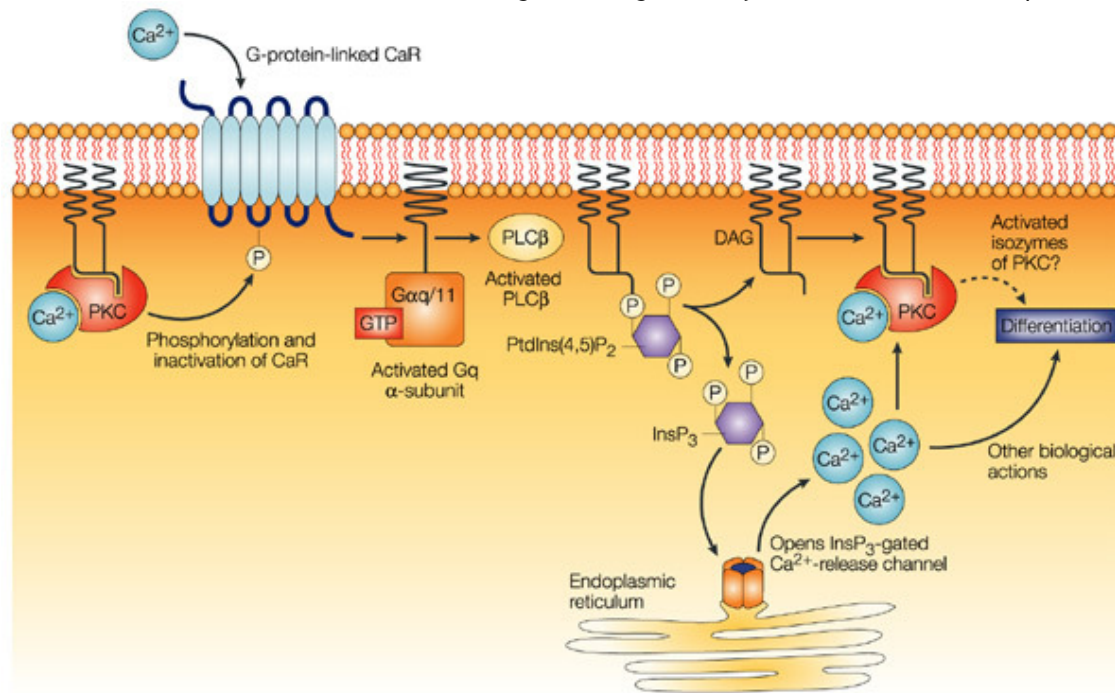

**Figure 6** Extracellular calcium acts as a genuine first messenger by binding to the calcium-sensing receptor (CaR). CaR is a guanine nucleotide G-protein-coupled receptor consisting of the typical seven hydrophobic  $\alpha$ -helices. The binding of calcium to CaR results in activation of phosphatidylinositol-specific phospholipase CB (PLCB) through recruitment of the G $\alpha$ q/11 protein. Activated PLCB hydrolyses membrane-bound phosphatidylinositol-4,5-bisphosphate (PtdIns(4,5)P<sub>2</sub>) to two important intracellular messengers, inositol-1,4,5-trisphosphate (IP<sub>3</sub>) and diacylglycerol (DAG). IP<sub>3</sub> diffuses to the cell cytosol and releases calcium stored in the endoplasmic reticulum (ER) by binding and opening IP<sub>3</sub>-gated tetramer calcium channels embedded in the ER membrane (74).

In human PC cell lines, the expression of CaSR mRNA and protein has been detected (75). Elevated  $[Ca^{2+}]_o$  was shown to lead to the activation of CaSR at the cell membrane. It has been demonstrated that CaSR expression is up-regulated by  $[Ca^{2+}]_o$  in PC3 cells, but not in LNCaP cells (9). CaSR expression in PC cells correlates with the proliferative effect of elevated  $[Ca^{2+}]_o$  and the cellular metastatic behavior (9), suggesting that the activation of CaSR may favor proliferation of prostate cancer cells (9).

As described previously, the calcium homeostasis is maintained through a complex signaling toolkit, composed of various signaling components. During the ON reactions, Ca<sup>2+</sup> flows into the cell and interacts with different Ca<sup>2+</sup>-binding proteins, of which there are ~200 encoded by the human genome that function either as Ca<sup>2+</sup> effectors or buffers (76). Next, we will focus on a rather different Ca<sup>2+</sup> binding protein, regucalcin.

## 4 Regucalcin

Regucalcin was identified in 1798 as a Ca<sup>2+</sup> binding protein that doesn't contain the EF-hand motif of a Ca<sup>2+</sup> binding domain. It is also known as senescence marker protein-30 (SMP30) due to its decreased expression with aging in liver and kidney (77-79).



#### 4.1 Gene/Protein Structure

The human regucalcin gene is localized on the human chromosome Xq11.3-11.2 (79), and the organization of the regucalcin gene consists of seven exons and six introns (78). The molecular weight of regucalcin is estimated to be around 33,388 kDa, and it presents 299 amino acids (80) (Figure 7). Beyond its expression in rat and human, the regucalcin gene is also present in mouse, cow, monkey, dog, rabbit, and chicken but not in yeast (81).

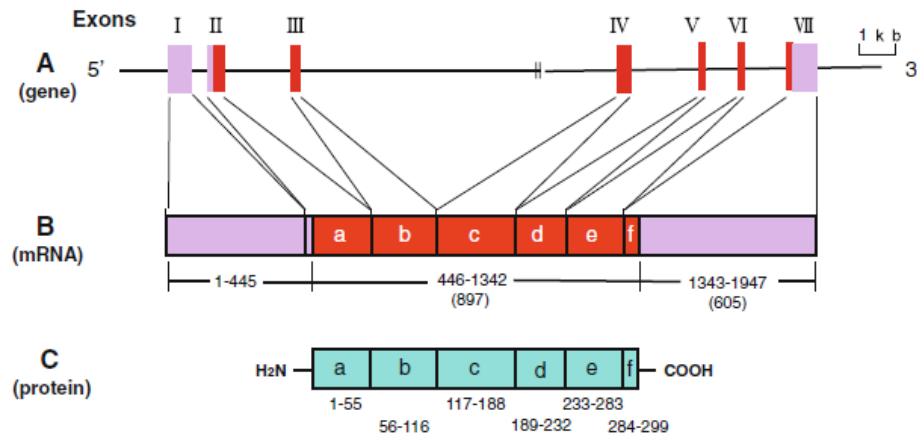

**Figure 7** Alignment of the exons for the rat regucalcin gene with the cDNA. The regucalcin gene is localized on the chromosome X. The organization of rat regucalcin gene consists of seven exons and six introns. Regucalcin is composed of 299 amino acid residues and its molecular weight is estimated to be 33,388 Da. (A) The genomic organization of rat regucalcin gene. The positions of exons, which are shown as boxes (I-VII), are indicated in the agreement with the protein coding regions. Introns are depicted by connecting lines. (B) A diagram of the regucalcin cDNA from rat liver. (C) The organization of amino acid residues of regucalcin (82).

Regucalcin mRNA is mainly present in the rat liver and kidney cortex (13, 83), and slightly less expressed in brain, heart, bone, breast, lung, prostate, and other tissues (11, 84-87). It has been demonstrated that the regulation of regucalcin mRNA expression is dependent of the  $\text{Ca}^{2+}$ /calmodulin complex, protein kinase C, and tyrosine kinase, suggesting that calcium signaling acts as an important role in regulation of regucalcin mRNA expression (88-90).

Transcript variants for human regucalcin gene were initially reported as identical in their coding region, differing only in 5'-untranslated regions (91). However, Maia *et al.* (2008) suggested the occurrence of alternative splicing of the regucalcin pre-mRNA. Regucalcin wild-type cDNA and two additional bands were found in both human prostate and breast non-neoplastic cell lines. The regucalcin wild-type cDNA was shown to be 897 bp in size, additional bands lacking exon 4 ( $\Delta 4$ ) and exon 4 and 5 ( $\Delta 4,5$ ) have respectively 681 and 549 bp.

## 4.2 Regulation of gene expression

There are many cell-signaling factors involved in regulation of regucalcin gene expression (Figure 8). The expression of regucalcin mRNA is mediated through a  $\text{Ca}^{2+}$ -dependent signaling mechanisms (92). The effect of  $\text{Ca}^{2+}$  administration on regucalcin mRNA in the liver of rats was demonstrated by Shimokawa and Yamaguchi (1992), where high doses of  $\text{Ca}^{2+}$  produced a rapid increase in the expression levels of mRNA encoding regucalcin in the liver. This increase was determined at 30min after the administration, reaching a maximum at 120min. After this period of time, the mRNA levels decrease implicating that there might be a regulating system that suppresses over-expression of the regucalcin gene in the liver (13). The role of  $\text{Ca}^{2+}$  in regucalcin expression was also shown in kidney cortex after a single intraperitoneal administration of calcium chloride ( $\text{CaCl}_2$ ) solution, where calcium administration increased the expression of regucalcin mRNA, this increase was considered remarkable at 60-120min after the administration (12). Induced hypercalcemia, after oral administration of calcium, has also induced an increase in calcium content and regucalcin mRNA levels in the liver of rats (93).

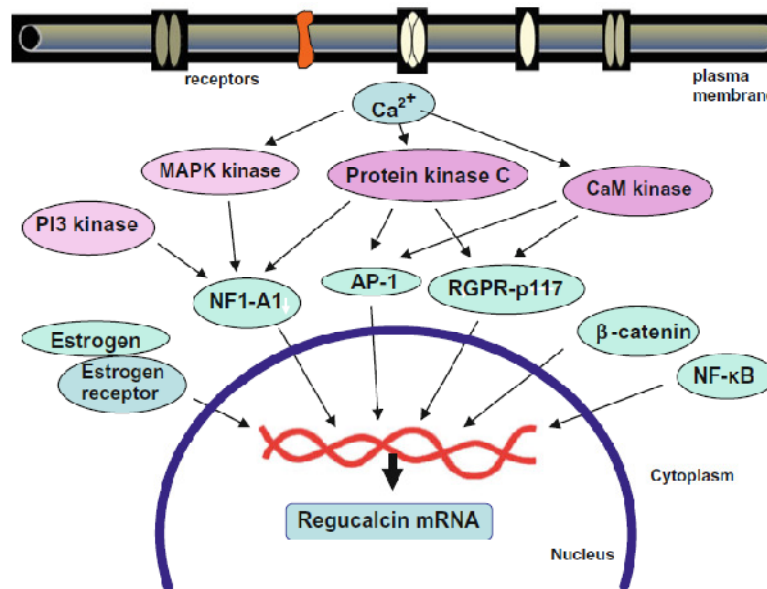
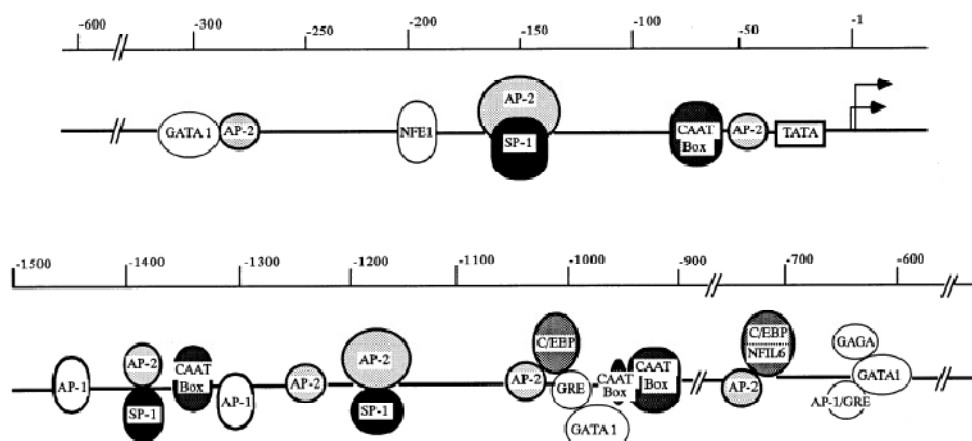

**Figure 8** The transcription activity of regucalcin gene is regulated through various cell signaling factors. AP-1, NF1-A1, and RGPR-p117 of transcription factor are translocated from the cytoplasm to the nucleus that is mediated through protein kinase C,  $\text{Ca}^{2+}$ -calmodulin-dependent protein kinase (CaM kinase), MAPK kinase, and PI3 kinase, which are activated by various hormones. These transcription factors enhance the promoter activity of regucalcin gene in the nucleus. Regucalcin gene expression may be also regulated through  $\beta$ -catenin, NF- $\kappa$ B, estrogen receptors, and other factors (82).

A decrease of hepatic regucalcin mRNA levels was verified after fasting of rats, suggesting that glucose may be a stimulatory factor in the expression of regucalcin mRNA in the liver (94). The administration of insulin lead to a remarkable elevation of regucalcin mRNA expression in the liver of fasted rats (94). The administration of 17 $\beta$ -estradiol, a steroid hormone related to nuclear receptor, caused a remarkable increase in regucalcin mRNA in the liver of rats. This enhancement after 17 $\beta$ -estradiol may be involved in an increase in the

estrogen response element promoter activity (95). Regucalcin was already shown to be present in rat prostate and mammary gland, where its expression decreases in response to 17 $\beta$ -estradiol (11, 87). This effect is similar to observed in kidney cortex (96) but different from what happened in liver tissues, where a enhancement in mRNA expression was verified (97). B-Catenin has also been shown to have a role in enhancing regucalcin gene expression (98), as well as the tumor necrosis factor (TNF- $\alpha$ ) which is shown to suppress regucalcin mRNA expression in osteoblastic MC3T3-E1 (99).

A series of transcription factor-binding sites for the regucalcin gene were already described, where some of these regions consist of the TATA-like sequence, a CAAT box, Sp-1 sites, binding sites for classes of C/EBP transcription factors in addition to AP-2, AP-1, GATA-1, and AP-1/GRE (100) (Figure 9). AP-1, NF1-A1, and RGPR-p117 are transcription factors which bind to the promoter region of the regucalcin gene and enhance its transcription activity, which is mediated through calcium and other signaling pathways (82).



**Figure 9** Putative transcription factor binding sites in the promoter region of mouse SMP30 genomic locus. Transcription initiation sites are indicated by arrows. The nucleotide sequence in the promoter region of mouse SMP30 genomic locus (DDBJ database under the accession number U32170) was searched for the transcription factor binding sites of nucleotide motif database. The representative putative transcription binding sites are illustrated in the scheme. A TATA-like sequence, a CAAT box, and Sp-1 sites are found at nt -29, -72 and -169, respectively. Binding sites for C:EBP, AP-2, AP-1, GATA-1 and AP-1:GRE sites are also found. Nucleotides (nt) is represented as minus bp from the transcription initiation site (proximal promoter region in upper panel and distal region in lower panel) (101).

### 4.3 Calcium homeostasis

It has been shown that regucalcin plays an important role in the maintenance of  $[Ca^{2+}]_{Cyt}$  by the regulation of  $Ca^{2+}$  transporting systems (77). In addition, it is also important in the inhibitory regulation of various  $Ca^{2+}$ -dependent protein kinases, tyrosine kinases, protein phosphatases, nitric oxide (NO) synthase, protein synthesis, nuclear DNA and RNA synthesis in many cell types (77, 78).

Intracellular  $Ca^{2+}$  homeostasis is regulated through a series of calcium channels and receptors, and it has been described that regucalcin regulate various  $Ca^{2+}$  transporting

systems, such as plasma membrane  $(\text{Ca}^{2+}\text{-Mg}^{2+})$ -adenosine 5'-triphosphatase (ATPase), microsomal  $\text{Ca}^{2+}$ -ATPase, mitochondrial  $\text{Ca}^{2+}$  uptake, as well as, nuclear  $\text{Ca}^{2+}$  transport in the cells (77) (Figure 10).

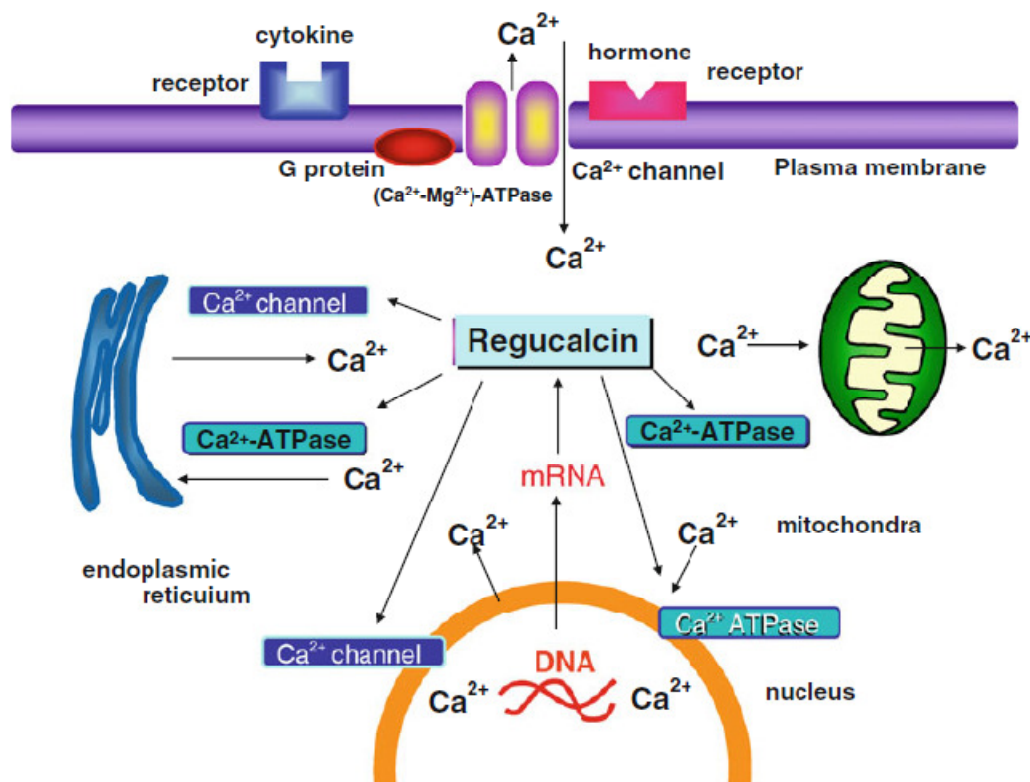

**Figure 10** Regucalcin has a pivotal role in keeping intracellular  $\text{Ca}^{2+}$  homeostasis that is attenuated with various stimulating in cells. Regucalcin increases plasma membrane  $(\text{Ca}^{2+}\text{-Mg}^{2+})$ -ATPase, mitochondrial  $\text{Ca}^{2+}$ -ATPase and microsomal  $\text{Ca}^{2+}$ -ATPase activities in cells. Regucalcin also stimulates  $\text{Ca}^{2+}$  release from the microsomes (endoplasmic reticulum). Regucalcin has an inhibitory effect on nuclear  $\text{Ca}^{2+}$ -ATPase and a stimulatory effect on  $\text{Ca}^{2+}$  release from the nucleus. Through thus mechanism, regucalcin plays a part in regulating the rise of cytosolic  $\text{Ca}^{2+}$  concentration and nuclear matrix  $\text{Ca}^{2+}$  levels in cells that suppresses  $\text{Ca}^{2+}$ -dependent cellular events (77).

In liver, regucalcin directly activates  $(\text{Ca}^{2+}\text{-Mg}^{2+})$ -ATPase independently of  $\text{Ca}^{2+}$ -stimulated phosphorylation of the enzyme (102, 103). It has also been shown that it may stimulate ATP-dependent  $\text{Ca}^{2+}$  transport across the plasma membrane vesicles of rat liver after addition of  $\text{Ca}^{2+}$  in *in vitro* conditions (104). Regucalcin also act as an activator of the ATP-dependent  $\text{Ca}^{2+}$  pumps in the basolateral membranes isolated from rat kidney cortex, suggesting that regucalcin may act on the SH groups of  $\text{Ca}^{2+}$ -ATPase (105). This calcium-binding protein has been found to possess an inhibitory effect on  $\text{Ca}^{2+}$ -ATPase activity in rat brain microsomes (106), but not in the mitochondria of rat brain tissue (107).

A great number of enzymes in cells are activated by  $\text{Ca}^{2+}$  and calmodulin systems. Many evidences have been shown that regucalcin has an inhibitory effect on enzyme activation by these same systems (108).  $\text{Ca}^{2+}$ /calmodulin-dependent enzymes are present in a various number of tissues and cells. Regucalcin has been spotted to play an important role in the regulation of these enzymes, namely in reversing the activity of many  $\text{Ca}^{2+}$ -activated enzymes (phosphorylase a, glucose-6-phosphatase, fructose-1,6-bisphosphatase, pyruvate kinase, protein kinase C,  $\text{Ca}^{2+}$ /calmodulin-dependent protein kinase, protein phosphatase, and  $\text{Ca}^{2+}$ /calmodulin-dependent cyclic AMP phosphodiesterase) and of  $\text{Ca}^{2+}$ -inhibited enzymes (5'-nucleotidase and dUTPase) (77).

The inhibition of the activity of these previously described enzymes leads to regucalcin having a physiological role in the intracellular control of the hormonal stimulation for phosphorylation and dephosphorylation of many proteins in various cell types.

Regucalcin also has a regulatory effect on the  $\text{Ca}^{2+}$  transport system in kidney cells. It has been demonstrated that regucalcin has a suppressive effects on the gene expression of L-type  $\text{Ca}^{2+}$  channel and CaSR, which regulate intracellular  $\text{Ca}^{2+}$  signaling (109).

#### 4.4 Cell Cycle

Regucalcin has been implicated in various processes involved cell cycle regulation, such as the regulation of tumor-related genes. The expression of mRNA of tumor stimulator genes, such as, c-myc, c-src, and H-ras are found to be suppressed in transfectants overexpression regucalcin (110, 111). On the other hand, the expression of mRNA of tumor suppressor genes, p53 and Rb was markedly enhanced in transfectants overexpressing regucalcin (111).

Regucalcin may have a suppressive effect on many signaling pathways that mediate cell death and apoptosis, as summarized in Figure 11. This protein has the ability to inhibit the nitric oxide (NO) synthase that is related to cell apoptosis (112), suggesting that regucalcin has a suppressive role in apoptosis (113). Overexpression of regucalcin was also found to have a suppressive effect on cell death induced by stimulation with higher concentrations of TNF- $\alpha$  (114), as well as, manifesting a suppressive effect on LPS-stimulated cell death and apoptosis (115). A various number of studies have shown that  $\text{Ca}^{2+}$  plays an important role in the regulation of nuclear functions. It has been demonstrated that  $\text{Ca}^{2+}$  stimulates *in vitro* DNA fragmentation in isolated rat liver nuclei, but this effect is inhibited in the presence of regucalcin (116). Studies suggest that this inhibitory effect may be partly based on binding of  $\text{Ca}^{2+}$  (117). Overexpression of regucalcin in hepatoma cells has being able to suppress DNA fragmentation induced by thapsigargin (118). Another apoptosis inducing factor is  $\text{Ca}^{2+}$ , its entry into cells is known to induce cell death (118, 119). Regucalcin may have a suppressive effect on  $\text{Ca}^{2+}$  entry-induced stimulation of apoptosis in hepatoma cells (118). In the kidney suppressive effects of regucalcin have also been verified, the

overexpression of regucalcin has a suppressive effect on apoptotic cell death induced by various factors such as TNF- $\alpha$ , LPS, Bay K 8644, or thapsigargin in kidney NRK52E cells (120).

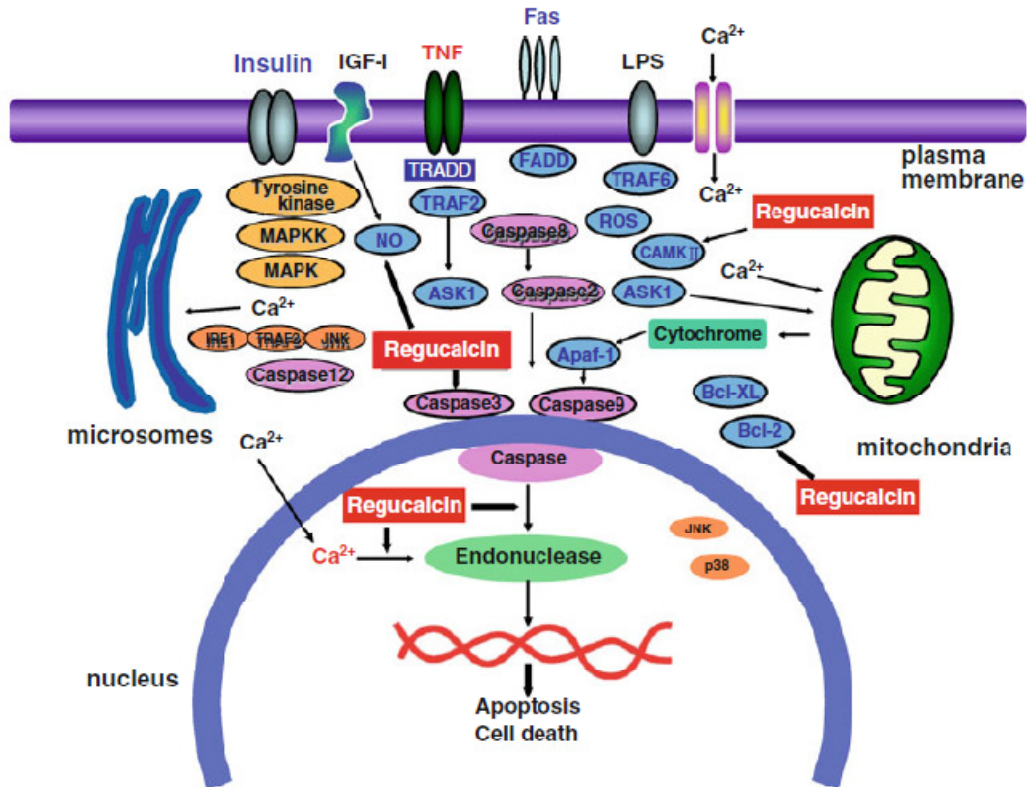

**Figure 11** Regucalcin has a role as suppressor in cell death and apoptosis induced by various factors. Regucalcin suppresses cell death induced by various factors (including TNF- $\alpha$ , insulin, IGF-I, LPS, PD98059, dibucaine, thapsigargin, Bay K 8644, or sulforaphane). The suppressive effect of regucalcin on cell death and apoptosis is mediated due to inhibiting the activities of NO synthase, caspase-3, and Ca<sup>2+</sup>-dependent endonuclease and activating Bcl-2 in the cell (77).

Regucalcin has been shown to have a role as suppressor in the enhancement of proliferation in *in vitro* of liver cells. Serum stimulation may lead to an increase in cell proliferation that is partly mediated through cascade for various protein kinases in H4-II-E cells. This effect was completely abolished after the addition of exogenous regucalcin, which has an inhibitory effect on the enzyme activity (121). Regucalcin when translocated to the nucleus it may play a suppressive role in the regulation of protein kinase and protein tyrosine phosphatase in liver nucleus (122). A suppressive effect on tyrosine kinase, protein kinase C, and Ca<sup>2+</sup>/calmodulin-dependent protein kinase in the cytoplasm and nucleus of regenerating rat liver is also verified (123-126). DNA synthesis activity in the nuclei of normal rat liver has been shown to be inhibited by regucalcin (127), suggesting a suppressive effect on nuclear DNA synthesis in regenerating rat liver. Regucalcin may also have a suppressive role in the enhancement of nuclear DNA synthesis in liver cell proliferation (128). In normal kidney cells, NRK52E (wild type), the enhancement of cell proliferation was suppressed in transfectants

overexpressing regucalcin (129). Overexpression of regucalcin has shown to have a preventive effect on Bay K 8644-induced inhibition of cell proliferation (129).

Overexpression of regucalcin has also a suppressive effect on cell responses that are mediated through signaling processes that are mediated by TNF- $\alpha$  or transforming growth factor-B1 (TGF-B1) in NRK52E cells (130). Overexpression of regucalcin has been found to suppress the inhibitory effect of various factors which induce cell cycle arrest in phases such as G1 and G2/M, in H4-II-E proliferative cells (131).

#### **4.5 Expression in cancer**

Expression of regucalcin in cancer tissue was first demonstrated by Makino and Yamaguchi, 1995 where they showed that regucalcin mRNA is clearly expressed in the transplantable Morris hepatoma cells (132). Regucalin has also been identified as a down-regulated gene in mouse (133) and human (134, 135) hepatocellular carcinomas. Other studies have demonstrated that regucalcin has a suppressive effect on the function of nucleus in the cloned rat hepatoma H4-II-E cells with proliferation. Endogenous regucalcin has an inhibitory effect on the enhancement of protein phosphatase activity (136) and protein kinase activity (137). Furthermore, RGN expression in hepatocellular carcinomas has been implicated in suppression of proliferation (131, 138), inhibited expression of oncogenes as well as the increased expression of tumor suppressor genes as described previously (110, 111).

Further studies also demonstrated the expression of regucalcin mRNA and protein in non-neoplastic human breast and prostate as well as in cancers of both tissues. Both breast and prostate non-neoplastic tissues seem to display stronger expression of regucalcin when compared with cancer cells. Moreover, it was also demonstrated that regucalcin is under-expressed in prostate tumors, and a significant negative association between regucalcin immunoreactivity and tumor cell differentiation was detected (11).

## II. Objectives

It is well known that changes in calcium ( $\text{Ca}^{2+}$ ) homeostasis are derived from modifications in  $\text{Ca}^{2+}$  regulating elements and that regucalcin plays an important role in maintenance of intracellular  $\text{Ca}^{2+}$  homeostasis and regulation of apoptosis and proliferation. It has been shown that regucalcin is under-expressed in prostate cancer cells, suggesting that a loss of RGN expression may be associated with tumor development. However, no studies on the characterization of RGN regulation by extracellular  $\text{Ca}^{2+}$  in prostate cells have been conducted; therefore we proposed to determine the role of extracellular  $\text{Ca}^{2+}$  on the expression of regucalcin in prostate cells. For this purpose the following tasks were defined:

- To characterize regucalcin expression in prostate cell-lines;
- To evaluate the effect of extracellular  $\text{Ca}^{2+}$  on regucalcin mRNA and protein expression in non-neoplastic prostate cells;
- To study the effect of extracellular  $\text{Ca}^{2+}$  on cell viability in non-neoplastic and neoplastic prostate cells.
- To characterize CaSR expression in prostate cell-lines;



## III. Materials and Methods

### 1 Cell Culture and treatment

Prostate cancer cell lines human immortalized normal prostate epithelial cell lines PNT1A and PNT2 and human prostate cancer cell line LNCaP and PC3 were purchased from the European Collection of Cell Cultures (ECACC, Salisbury, UK).

Cell lines were maintained in a incubator at 37°C in a 5% CO<sub>2</sub> atmosphere with RPMI 1640 phenol-red (Gibco, Paisley, UK) medium supplemented with 10% FBS (Biocrom, Berlin, Germany) and 1% penicillin/streptomycin (Gibco, Paisley, UK). PNT1A cells were then seeded in 6-well Multiwell Plates at a density of  $500 \times 10^3$  per well in 2ml of cell medium culture. When growth confluence of 60% was achieved, the medium was replaced by DMEM 21068 calcium free medium (Gibco, Paisley, UK), and cells were grown in this medium for 24h. Next, cells were exposed to different doses of CaCl<sub>2</sub> (0, 1, 1.8, 3, 5, and 10mM) during several periods of time (0, 1.5, 3, 6 and 12h).

### 2 Cell Viability assays

PNT1A and LNCaP cells were seeded into 96-well plates at a density of  $2 \times 10^3$  and  $1 \times 10^3$  cell per well respectively in 100µl of cell medium culture in triplicate. After a period of 24h, cells were treated for 24h with DMEM 21068 calcium free medium (Gibco, Paisley, UK). After this wash-out period, cells were exposed to different doses of calcium chloride, namely 0, 1, 1.8, 3, 5 and 10mM during several periods of time (0h, 6h, 12h, 24, 48 e 72h). Cell viability was determined by the colorimetric MTS using CellTiter 96 AQueous Assay System from Promega (Madison, WI, USA). In this assay, the quantity of formazan product formed is directly proportional to the number of viable cells in the cultures. The absorbance was detected at 490 nm with a Microplate Reader (Biocrom, Anthos 2020). All experiments were repeated at least three times, and each experiment was done in hexaplicated.

### 3 cDNA Synthesis

Total RNA from prostate cell lines were extracted using TRI reagent™ (Sigma, Saint Louis, Missouri, USA) according to the manufacturer's instructions. In order to access the quantity of total RNA, its optical density at 260 nm and 280 nm were determined (NanoPhotometer, Implen, Munich, Germany), and the integrity of RNA was verified through agarose gel electrophoresis.

cDNA was synthesized from 1 µg of total RNA which was denatured for 5 min at 70°C together with 1µl of random hexamer primers (Invitrogen, Karlsruhe LMA, Germany). Reverse transcription was carried out at 37°C for 60 min in a 20 µl reaction containing reverse

transcriptase buffer (provided with M-MLV Reverse Transcriptase), 1µl dNTP Mix (10 nM; Amersham, GE Healthcare, Uppsala, Sweden) and 0,8µl of M-MLV Reverse Transcriptase (Promega, Madison, WI, USA). The reaction was stopped at 75°C for 15 min and synthesized cDNA was stored at -20°C until further use.

#### 4 Real Time and RT- PCR

To evaluate the responsiveness of regucalcin to Ca<sup>2+</sup> in human prostate cells, regucalcin gene expression was analyzed by Real-time PCR (iCycler iQ5™ system, Biorad) in Ca<sup>2+</sup> stimulated cells. Specific primers to human regucalcin (Table 1) were used to amplify a fragment of 177 bp. Human GAPDH primers (Table 1) were used as internal controls to normalize regucalcin expression. PCR reactions were carried out using 1µg of cDNA synthesized prostate cell lines in a 20µl reaction containing 10µl of Maxima™ SYBR Green/Fluorescein qPCR Master Mix (Fermentas, EU) and 200nM of RGN primers or 300 nM GAPDH primers. Conditions and reagents concentrations were previously optimized. Reaction conditions comprise a 5min denaturation at 95°C, followed by 35 cycles at 95°C for 10 seconds, 60°C for 30 seconds and 72°C for 10 seconds. The reactions were heated from 55 to 95°C with 10 s holds at each temperature (0.05\_C/s) and then analyzed by melting curves. Fold differences were calculated following the mathematical model proposed by Pfaffl using the formula:  $2^{-\Delta\Delta Ct}$  (Pfaffl, 2001).

For the amplification of human CaSR, specific primers hCaSR (Table 1) were used to amplify a fragment of 491 bp. cDNA (1 µl) was amplified in a final volume of 25 µl containing 2,5µl NZYTaQ buffer with 2.5 mM MgCl<sub>2</sub> (supplied with NZYTach DNA polymerase), 0.1 µl of NZYTaQ DNA polymerase (NZYTech, Lisbon, Portugal), 10 mM each dNTP, and 1,2 µl each primer (StabVida, Oeiras, Portugal). Every set of PCR included a no-template control. RT-PCR reactions were carried out at a 5min denaturation at 95°C, followed by 45 cycles at 95°C for 50 seconds, 60°C for 50 seconds and 72°C for 1 minute.

Table 1 PCR primer sequences and amplicon size.

Gene and accession number	Primer	Sequence (5'-3')	Amplicon size
Human Regucalcin NM_004683.4	hRGN fw_234	GCA AGT ACA GCG AGT GAC C	177
	hRGN rv_410	TTC CCA TCA TTG AAG CGA TTG	
Human CaSR NM_001178065.1	hCaSR fw_1822	AAG CAC CTA CGG CAT CTA A	491
	hCaSR rv_2312	CGA TCC CAA AGG GCT C	
Human GAPDH NM_002046.4	hGAPDH fw_74	CGC CAG CCG AGC CAC ATC	76
	hGAPDH rv_149	CGC CCA ATA CGA CCA AAT CCG	

## 5 Protein extraction and Western Blot Analysis

Total protein from cells were extracted using RIPA Buffer (150 mM NaCl; 1% Nonidet-P40 substitute; 0,5% Na-deoxycholate; 0,1% SDS; 50 nM Tris ; 1mM EDTA)with 1% Protease inhibitor cocktail and 10% PMSF. Total proteins (supernatant) were recovered after a 12000g centrifugation for 20 min at 4°C. Quantification of total protein extracts were assessed using the *Bradford* method (Biorad Protein Assay, Hercules, USA).

Total proteins were resolved in a SDS-PAGE gel and electrotransferred to a PVDF membrane (Amersham) at 750mA for 50min. Membranes were first blocked for 1.5h in a 5% skimmed driedmilk (Regilait, France)-0.1% Tween 20 (Applichem, Darmstadt, Germany) in TBS solution and then probed overnight 4°C with a mouse monoclonal primary antibody anti-Human RGN (Abcam, ab67336, 1:1000, Cambridge, UK). The membranes were then washed with TBS-T and incubated with goat polyclonal antibody against mouse IgG (Abcam, ab7069, 1:20000, Cambridge, UK) for 1.5h. Finally, membranes are once more washed with TBS-T and then exposed to ECF substrate (Western Blotting Reagent Packs, Amersham) for 2min, and visualized on the Molecular Imager FX (Biorad).

## 6 Statistical Analysis

The statistical significance of differences in mRNA expression among experimental groups was assessed by ANOVA, followed by the Bonferroni post-test. Data analysis was performed using GraphPad Prism version 5.00 for Windows, GraphPad Software, San Diego California USA. Significant differences were considered when  $p < 0,05$ . All experimental data are shown as mean  $\pm$  SEM.

## IV. Results

### 1 Expression of regucalcin in human prostatic cell lines

Recently, our research group identified that regucalcin mRNA and protein is differentially expressed in PC (11). Therefore, the first goal of this study was to evaluate the expression of regucalcin in human non-neoplastic (PNT1A and PNT2) and neoplastic (LNCaP and PC3) prostate cell lines. The expression analysis of regucalcin mRNA and protein in prostate cells lines was carried out by Real Time PCR and Western Blot, respectively.

According to Real-time PCR analysis, amplification of regucalcin mRNA is observed in all prostate cell lines, but with different levels of expression. Regucalcin mRNA is highly expressed in PNT1A cells, followed by PNT2, PC3 and LNCaP (Figure 13).

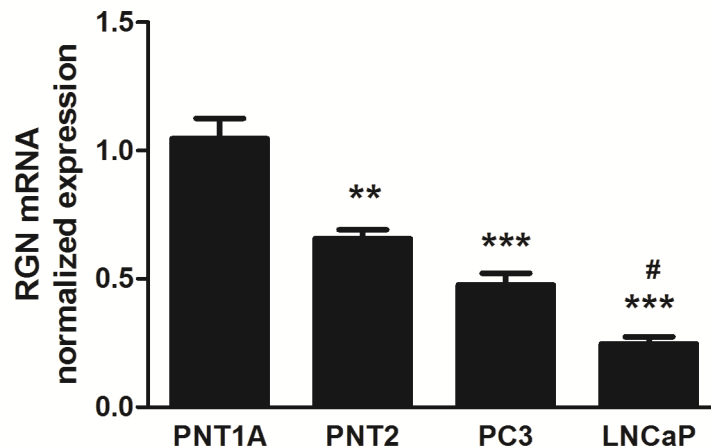

**Figure 12** Regucalcin mRNA expression in non-neoplastic (PNT1A and PNT2) and neoplastic (PC3 and LNCaP) prostate cell lines determined by Real Time PCR. Regucalcin expression was normalized with GAPDH as internal reference gene. N=3 in each experimental condition. Error bars represent S.E.M. \*P<0.05, \*\*P<0.01 and \*\*\*P<0.001 compared with PNT1A cell line. #P<0.05 compared with PC3 cell line.

In order to evaluate whether this differentially expression is also verified at protein level, western blot analysis was carried out using an anti-regucalcin antibody. The results showed an immunoreactive protein with approximately 35 KDa in all prostate cell lines, which corresponds to the regucalcin predicted size. This result is in accord as previously reported by Fujita (1992) (Figure 14 A). After normalization with  $\beta$ -actin protein, a higher expression of regucalcin was found in PNT1A cells, followed by PNT2, PC3 and LNCaP (Figure 14 B).

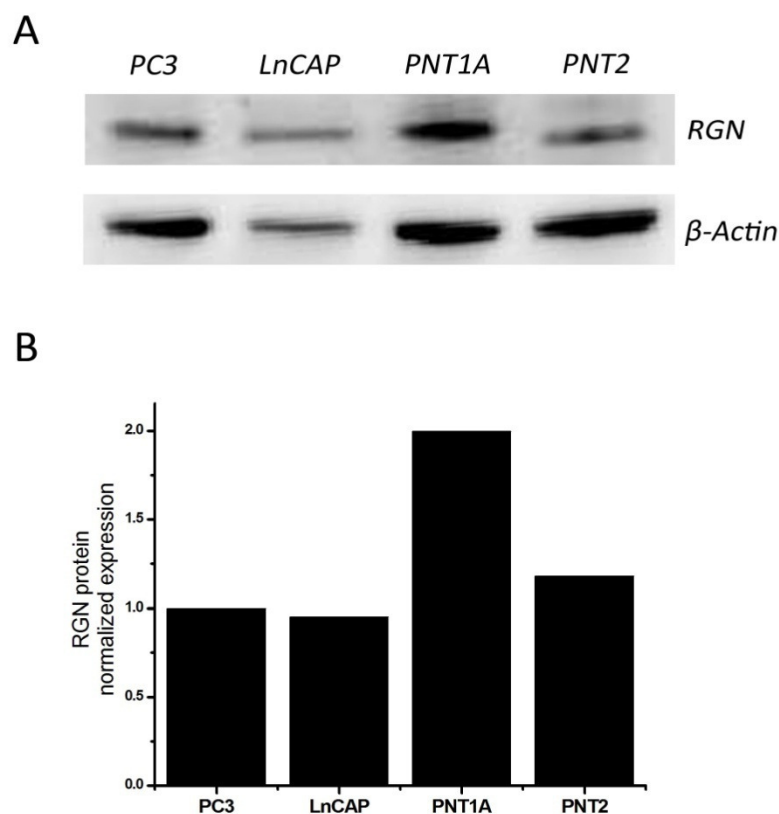
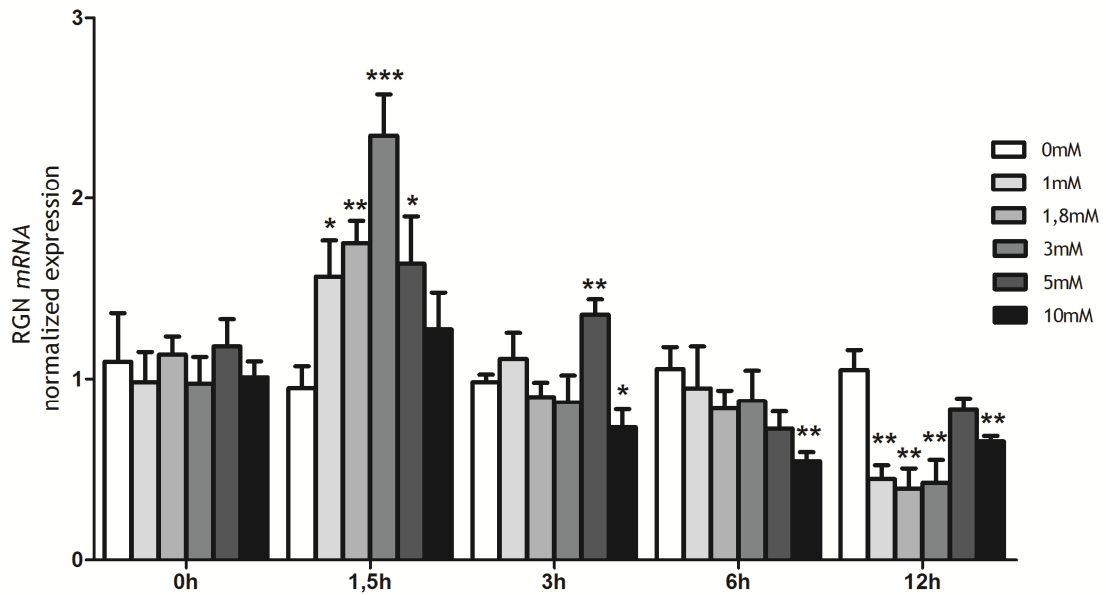

**Figure 13** Regucalcin protein expression in non-neoplastic (PNT1A and PNT2) and neoplastic (PC3 and LnCaP) prostate cell lines determined by Western Blot. A: Immunoblot of cell lines protein extracts using a mouse monoclonal anti- regucalcin antibody (Abcam, ab67336, 1:1000) B: regucalcin expression upon normalization of WB results with B-actin antibody (Sigma, A1978, 1:5000).

## 2 Regucalcin is up-regulated in PNT1A cells by extracellular $\text{Ca}^{2+}$

To analyze the effect of extracellular  $\text{Ca}^{2+}$  in regulation of regucalcin levels in prostate cells, we have chosen PNT1A cells because they present higher levels of regucalcin and they are non-neoplastic.

PNT1A cells were stimulated with different doses during several periods of time. Regucalcin mRNA and protein expression in response to stimulus were evaluated by Real Time PCR and western blot, respectively. According to Real-time PCR analysis, regucalcin mRNA expression was up-regulated at 1,5h of stimulation with 1, 1.8 and 3mM of extracellular  $\text{Ca}^{2+}$  (Figure 15). After up-regulation of regucalcin in response to extracellular  $\text{Ca}^{2+}$ , the levels of regucalcin become to diminish overtime, leading to a down-regulation of regucalcin mRNA at 12h of stimulation. Our results also show that the effect of extracellular seems to be dependent of dose. It is visible that the maximum levels of regucalcin are achieved when cells are stimulated with 3mM of extracellular  $\text{Ca}^{2+}$ . Doses of extracellular  $\text{Ca}^{2+}$  above 3mM seem to have a lesser effect on regucalcin expression.



**Figure 14** Effect of extracellular  $\text{Ca}^{2+}$  on regucalcin mRNA expression in non-neoplastic (PNT1A) prostate cell line determined by Real Time PCR. Regucalcin expression was normalized with GAPDH as internal reference genes. N=6 in each experimental condition. Error bars represent S.E.M. Time-course experiment in which PNT1A cells were cultured with different doses of  $\text{Ca}^{2+}$  chloride, namely 0, 1, 1.8, 3, 5 and 10mM  $[\text{Ca}^{2+}]_0$  for 0, 1.5, 3, 6 and 12 h. \* $P < 0.05$ , \*\* $P < 0.01$  and \*\*\* $P < 0.001$  compared with 0mM  $[\text{Ca}^{2+}]_0$ .

In order to assess whether regucalcin protein expression was also regulated by  $\text{Ca}^{2+}$ , western blot analysis was carried out using a human anti-regucalcin antibody. Due to an up-regulation of mRNA expression at the 1.5h and a down-regulation at the 12h of stimulation, we were to analyze the effect of extracellular  $\text{Ca}^{2+}$  at 1.5h and 12h of stimulation in regucalcin protein levels. After normalization with  $\beta$ -actin, our results demonstrate that regucalcin protein expression is also up-regulated at 1.5h of stimulation and down-regulated at 12h after stimulation. However, in opposition to observed at mRNA levels, it seems that lower  $\text{Ca}^{2+}$  levels led to higher levels of regucalcin protein expression (Figures 16 A and B).

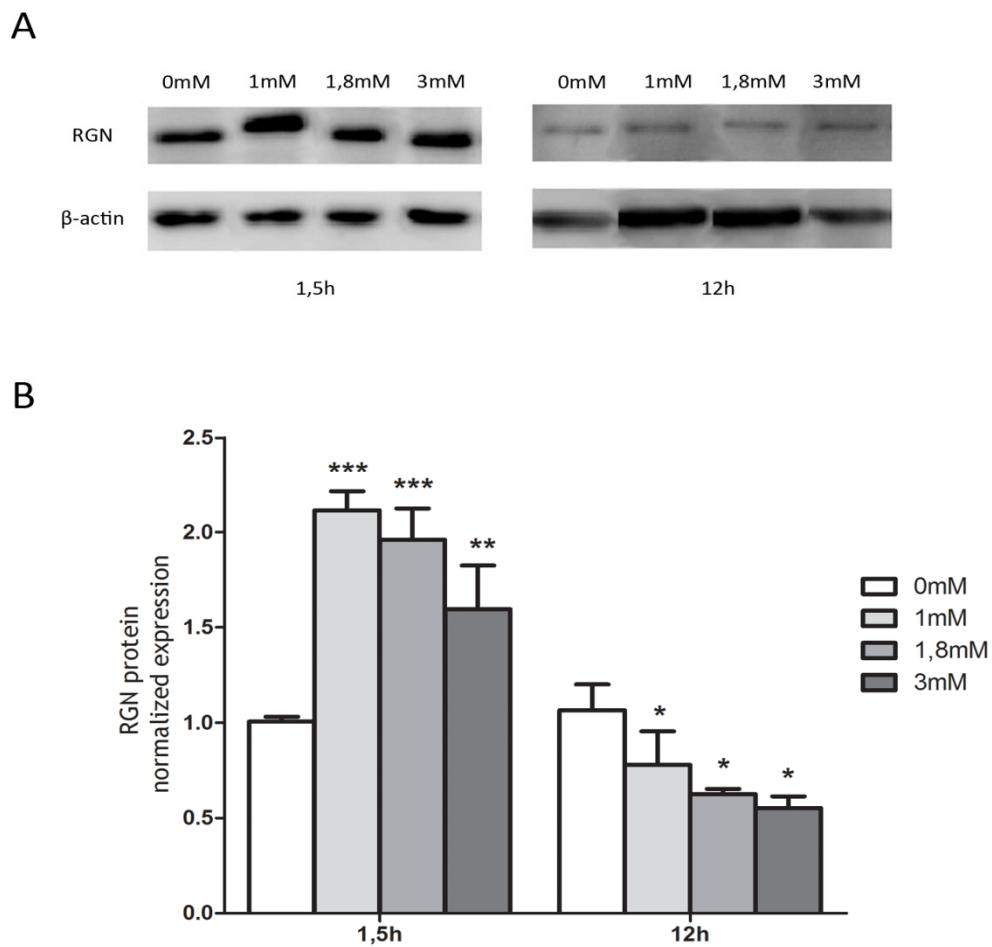

**Figure 15** Effect of extracellular  $\text{Ca}^{2+}$  on regucalcin protein expression in non-neoplastic PNT1A prostate cell line determined by Western Blot. A: Immunoblot of cell lines protein extracts using a mouse monoclonal anti-regucalcin antibody (Abcam, ab67336, 1:1000) B: regucalcin expression upon normalization of WB results with  $\beta$ -actin antibody (Sigma, A1978, 1:5000). N=6 in each experimental condition. Error bars represent S.E.M. \* $P < 0.05$ , \*\* $P < 0.01$  and \*\*\* $P < 0.001$  when compared to 0mM  $[\text{Ca}^{2+}]_o$ .

### 3 Effects of extracellular $\text{Ca}^{2+}$ in cell proliferation of prostate cell lines

The effect of  $[\text{Ca}^{2+}]_o$  in cell proliferation of PNT1A and LNCaP cells was investigated using MTS method. We observed in non-neoplastic PNT1A cells that high doses of  $[\text{Ca}^{2+}]_o$  lead to a lower percentage of cell proliferation when compared to control levels (0mM of  $\text{Ca}^{2+}$ ) or doses near of physiological levels (1mM and 1,8mM). On the other hand, the proliferation of neoplastic LNCaP cells are stimulated at higher doses of  $[\text{Ca}^{2+}]_o$  when compared to 0mM and 1mM of  $\text{Ca}^{2+}$  (Figure 17).

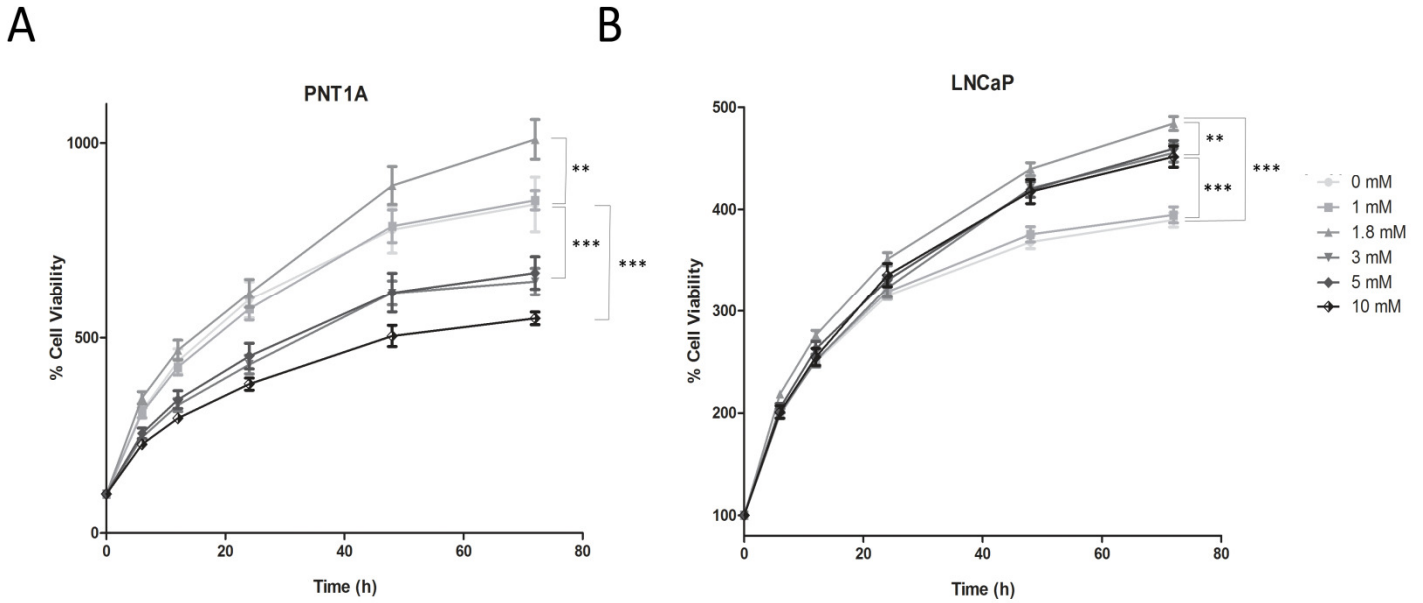

**Figure 16** MTS cell viability of non-neoplastic PNT1A and neoplastic LNCaP cell lines. N=6 in each experimental condition. Error bars represent S.E.M. \*P<0.05, \*\*P<0.01 and \*\*\*P<0.001 compared with 0mM  $[Ca^{2+}]_o$  at the same time point.

#### 4 Expression of CaSR in human prostatic cell lines

In order to better characterize the mechanisms underlying the effect of extracellular  $Ca^{2+}$  in proliferation of PNT1A and LNCaP cells, analysis of CaSR expression was explored because extracellular  $Ca^{2+}$  is mainly sensed by its cognate receptor, the CaSR (58). Our results show that CaSR mRNA is expressed in LNCaP cells, but no expression of CaSR was detected in PNT1A cells (Figure 18).

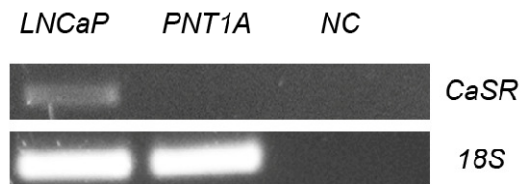

**Figure 17** CaSR mRNA is differentially expressed between neoplastic LNCaP and non-neoplastic PNT1A prostate cells. RT-PCR was carried out using CaSR specific primers; NC- negative control (without cDNA).



## V. Discussion

With this project we start to decipher the role of  $[Ca^{2+}]_o$  in regulation of RGN in prostate cells.

In a first approach we have demonstrated through Real Time PCR and western blot analysis that regucalcin is differentially expressed between non-neoplastic and neoplastic prostate cell lines. Regucalcin was highly expressed in human prostate PNT1A cells in comparison with PNT2, PC3 and LNCaP cells. Moreover, an apparent decreasing expression was observed: PNT1A > PNT2 > PC3 > LNCaP cells. These findings are predictable since our research group showed that RGN is under-expressed in human prostate cancer cases (11). Moreover, findings by other authors also have identified regucalcin as a down-regulated gene in human (134, 135) and mice (133) hepatocellular carcinomas.

As presented previously the activation of AR by androgens is required for the growth and survival of malignant prostate cells (37) and that with the progression of the disease the AR remains strongly expressed and active, even in the absence of androgens (36, 38) remaining a critical factor for growth and survival of the majority of tumors (15, 39, 40). These findings and the fact that DHT exerts a suppressive role in LNCaP regucalcin mRNA expression (11), might come to explain the differences in regucalcin between the non-neoplastic cells and the neoplastic cells. We observed that PC cell line LNCaP, which is androgen responsive, expressed lower levels of regucalcin mRNA when compared to PC cell line PC3, which is androgen independent. The differences in AR expression and activity during the progression of prostate cancer might be explicative of the differences in regucalcin expression between LNCaP and PC3 cell lines, suggesting that loss of RGN expression may be associated with tumor development.

After analyzing these results, we decided to choose non-neoplastic PNT1A cells to study the effect of  $[Ca^{2+}]_o$  on the regulation of regucalcin levels in prostate cells.

After performing different  $[Ca^{2+}]_o$  stimuli over time we verified a rapid up-regulation in RGN mRNA and protein expression at 1,5h of stimulation accompanied by a subsequent decreased expression after 3h of stimulation, resulting in a down-regulation of regucalcin mRNA at 12h of stimulation in PNT1A cells. This lead us to conclude that regucalcin expression is regulated by  $[Ca^{2+}]_o$  in normal prostate cells. These results have been reported previously in rat and mice liver, where regucalcin mRNA was markedly increased at an early time point (30 and 60 min) of  $Ca^{2+}$  intraperitoneal administration (13, 139). This stimulating effect was also verified in the kidney cortex of rats, where regucalcin expression was clearly increased by a single intraperitoneal administration of  $CaCl_2$  solution at 60-120 min after the administration (12). Our results, show that higher  $[Ca^{2+}]_o$  (5mM and 10mM) exerted slower and less intense response in regucalcin regulation when compared to the other concentrations. These results suggest that an up-regulation of regucalcin expression should activate mechanisms that suppress its overexpression in non-neoplastic PNT1A cells.

Taking into account the regulation of regucalcin by extracellular  $\text{Ca}^{2+}$  and it has been shown that  $\text{Ca}^{2+}$  affects cell proliferation and play an important role in PC, we have determined the effects of  $[\text{Ca}^{2+}]_o$  on cell viability in PNT1A and LNCaP cells (53). The effect of  $[\text{Ca}^{2+}]_o$  in cell proliferation of PNT1A and LNCaP cells was investigated using MTS method. High doses of  $[\text{Ca}^{2+}]_o$  lead to a lower percentage of non-neoplastic PNT1A cells proliferation when compared to control (0mM of  $\text{Ca}^{2+}$ ) or doses near physiological levels (1mM and 1,8mM). On the other hand, the proliferation of neoplastic LNCaP cells is stimulated at high doses of  $[\text{Ca}^{2+}]_o$ , when compared to the proliferation of the non-neoplastic cells PNT1A receiving the same stimuli. This suggests that high doses  $[\text{Ca}^{2+}]_o$  may stimulate prostate cancer cell growth. Liao and Schneider, 2006 have shown that no effect of  $[\text{Ca}^{2+}]_o$  is observed in cell proliferation of LNCaP cells. We also showed that  $[\text{Ca}^{2+}]_o$  in LNCaP cells took more time in exerting differences in cell growth between the different groups of stimuli, where in PNT1A cells the differences between groups could be visualized almost immediately leading to assume that non-neoplastic prostate cells respond faster to lower levels of  $[\text{Ca}^{2+}]_o$  when compared to neoplastic cells.

As mentioned previously, regucalcin seems to have a dual effect on suppression of cell proliferation and apoptosis stimulation. This suppressive effect of regucalcin on cell proliferation is related to its inhibitory effect on the activities of various protein kinases and protein phosphatases,  $\text{Ca}^{2+}$ - dependent signaling factors, nuclear DNA, RNA, and protein synthesis or IGF-I expression, and its activator effect on p21, an inhibitor of cell cycle-related protein kinases (110). The high  $[\text{Ca}^{2+}]_o$  promoted proliferation in the LNCaP cell line might be in part due to lower levels of regucalcin. However, further studies will be necessary to demonstrate this fact.

As mentioned previously,  $\text{Ca}^{2+}$  signals derive either from internal stores, or from the external medium. There are many different plasma membrane channels that control  $\text{Ca}^{2+}$  entry in basal conditions, or in response to stimuli such as extra- or intracellular agonists, or after the depletion of internal stores (41). Elevations in  $[\text{Ca}^{2+}]_o$  are mainly sensed by its cognate receptor, the CaSR (58). The CaSR has been documented to be over-expressed in a variety of tumors, such as breast cancer (140, 141), prostate cancer (9, 141), as well as in cancers originating from organs involved in  $[\text{Ca}^{2+}]_o$  homeostasis, including colorectal cancer (142, 143) and parathyroid adenomas and carcinomas (144, 145).

Our results show that CaSR gene is expressed in LNCaP cells, but not in non-neoplastic PNT1A cells. Expression of CaSR in LNCaP cells had been previously demonstrated in (75) and (9). Studies have shown that an overexpression of RGN possesses suppressive effects on the gene expression of CaSR (146). Elevated  $[\text{Ca}^{2+}]_o$  have also been shown to result in the activation of CaSR at the cell membrane (9), as well as others suggest that  $[\text{Ca}^{2+}]_o$  can act through the CaSR to prevent apoptosis, allowing the survival of cancer cells (147). In addition, CaSR has been reported to mediate cell proliferation in normal and malignant cell, including osteoblasts, fibroblasts, astrocytomas, multiple myeloma and testicular cancer (148-152). All these findings may suggest that the differences in proliferation between the non-neoplastic

and the neoplastic cell lines may be driven through the downregulation of regucalcin in LNCaP cells, which leads to increased levels of CaSR, and therefore, an increase in cell viability.

Due to the diverse functionality of the CaSR in various cancers (breast, prostate, parathyroid tumors and colon cancer) its functions must be better understood with further studies.

In summary we verified the expression of RGN mRNA and protein in non-neoplastic and neoplastic prostate cells lines, and that regucalcin is under-expressed in neoplastic LNCaP and PC3 prostate cells. We also showed that  $[Ca^{2+}]_o$  acts as a regulator of regucalcin expression, leading to its up-regulation in PNT1A cells. Moreover, We demonstrate that  $[Ca^{2+}]_o$  may stimulate PC cell growth and that CaSR mRNA is expressed in neoplastic cell line LNCaP, but not in non-neoplastic PNT1A cells.

## VI. Future Perspectives

Similarly to the study of the effects of  $[Ca^{2+}]_o$  on regucalcin expression in PNT1A cells, this should also be evaluated in LNCaP cells. This experiment will allow us to better understand the mechanisms underlying extracellular  $Ca^{2+}$  in PC cells.

The mechanisms by which  $[Ca^{2+}]_o$  acts on regucalcin expression are not yet clarified. Therefore, studies using agonists and antagonist of CaSR should be carried out in order clarify the role of CaSR in regulation of regucalcin in prostate cells.

To better understand the role of regucalcin in cell proliferation of PC cells, it would be of interest to restore the regucalcin levels in LNCaP cells.

## VII. References

1. Ferlay, J., Shin, H.-R., Bray, F., Forman, D., Mathers, C., and Parkin, D. M. (2010) Estimates of worldwide burden of cancer in 2008: GLOBOCAN 2008, *International Journal of Cancer* 127, 2893-2917.
2. Raymond W. Ruddon, M. D., Ph.D. (2007) *Cancer Biology*, 4 ed., Oxford University Press.
3. Huang, J. B., Kindzelskii, A. L., Clark, A. J., and Petty, H. R. (2004) Identification of Channels Promoting Calcium Spikes and Waves in HT1080 Tumor Cells, *Cancer research* 64, 2482.
4. Amuthan, G., Biswas, G., Ananadatheerthavarada, H. K., Vijayasathy, C., Shephard, H. M., and Avadhani, N. G. (2002) Mitochondrial stress-induced calcium signaling, phenotypic changes and invasive behavior in human lung carcinoma A549 cells, *Oncogene* 21, 7839.
5. Patton, A. M., Kassis, J., Doong, H., and Kohn, E. C. (2003) Calcium as a molecular target in angiogenesis, *Current pharmaceutical design* 9, 543-551.
6. Monteith, G. R., McAndrew, D., Faddy, H. M., and Roberts-Thomson, S. J. (2007) Calcium and cancer: targeting  $Ca^{2+}$  transport, *Nature Reviews Cancer* 7, 519-530.
7. Rizzuto, R., and Pozzan, T. (2006) Microdomains of intracellular  $Ca^{2+}$ : molecular determinants and functional consequences, *Physiological reviews* 86, 369-408.
8. Rizzuto, R., Pinton, P., Ferrari, D., Chami, M., Szabadkai, G., Magalhaes, P. J., Di Virgilio, F., and Pozzan, T. (2003) Calcium and apoptosis: facts and hypotheses, *Oncogene* 22, 8619-8627.
9. Liao, J., Schneider, A., Datta, N. S., and McCauley, L. K. (2006) Extracellular calcium as a candidate mediator of prostate cancer skeletal metastasis, *Cancer Res* 66, 9065-9073.
10. Yamaguchi, M., and Yamamoto, T. (1978) Purification of calcium binding substance from soluble fraction of normal rat liver, *Chemical & pharmaceutical bulletin* 26, 1915.
11. Maia, C., Santos, C., Schmitt, F., and Socorro, S. (2009) Regucalcin is under-expressed in human breast and prostate cancers: Effect of sex steroid hormones, *J Cell Biochem* 107, 667-676.
12. Yamaguchi, M., and Kurota, H. (1995) Expression of calcium-binding protein regucalcin mRNA in the kidney cortex of rats: The stimulation by calcium administration, *Molecular and cellular biochemistry* 146, 71-77.
13. Shimokawa, N., and Yamaguchi, M. (1992) Calcium administration stimulates the expression of calcium-binding protein regucalcin mRNA in rat liver, *FEBS letters* 305, 151-154.
14. Moore, K. L., Dalley, A. F., and Agur, A. M. R. (2009) *Clinically Oriented Anatomy*, Lippincott Williams & Wilkins.
15. Dehm, S. M., and Tindall, D. J. (2006) Molecular regulation of androgen action in prostate cancer, *Journal of cellular biochemistry* 99, 333-344.
16. Guyton, A. C., and Hall, J. E. (2006) *Textbook of Medical Physiology*, 11 ed., Elsevier Saunders.
17. Risbridger, G. P., and Taylor, R. A. (2006) Chapter 23 - Physiology of the Male Accessory Sex Structures: The Prostate Gland, Seminal Vesicles, and Bulbourethral Glands, In *Knobil and Neill's Physiology of Reproduction (Third Edition)* (Jimmy, D. N., Ph.D, Tony, M. P., Donald, W. P., John, R. G. C., D.Sc, F.R.S.C, David, M. d. K., M.D, A.O, JoAnne, S. R., and Paul M. Wassarman, P. D., Eds.), pp 1149-1172, Academic Press, St Louis.
18. Seeley, R. R., Tate, P., and Stephens, T. D. (2003) *Anatomia e Fisiologia*, 6 ed., Lusociência.
19. McNeal, J. E. (1988) Normal histology of the prostate, *The American journal of surgical pathology* 12, 619.
20. McNeal, J. E. (1981) The zonal anatomy of the prostate, *The Prostate* 2, 35-49.
21. Selman, S. H. (2011) The McNeal Prostate: A Review, *Urology*.

22. Allen, K. S., Kressel, H. Y., Arger, P. H., and Pollack, H. M. (1989) Age-related changes of the prostate: evaluation by MR imaging, *American Journal of Roentgenology* 152, 77-81.
23. Kirby, R. S. (2003) *An Atlas of Prostatic Diseases*, Parthenon Publishing Group.
24. Frick, J., and Aulitzky, W. (1991) Physiology of the prostate, *Infection* 19, 115-118.
25. McNeal, J. (1968) Regional morphology and pathology of the prostate, *American journal of clinical pathology* 49, 347.
26. Wright, A. S., Thomas, L. N., Douglas, R. C., Lazier, C. B., and Rittmaster, R. S. (1996) Relative potency of testosterone and dihydrotestosterone in preventing atrophy and apoptosis in the prostate of the castrated rat, *Journal of Clinical Investigation* 98, 2558.
27. Fawcett, J. W., and Keynes, R. J. (1986) Muscle basal lamina: a new graft material for peripheral nerve repair, *Journal of neurosurgery* 65, 354-363.
28. Epstein, J. I. (1993) PSA and PAP as immunohistochemical markers in prostate cancer, *The Urologic clinics of North America* 20, 757.
29. De Marzo, A. M., Meeker, A. K., Epstein, J. I., and Coffey, D. S. (1998) Prostate stem cell compartments: expression of the cell cycle inhibitor p27Kip1 in normal, hyperplastic, and neoplastic cells, *The American journal of pathology* 153, 911-919.
30. Bonkhoff, H., and Remberger, K. (1993) Widespread distribution of nuclear androgen receptors in the basal cell layer of the normal and hyperplastic human prostate, *Virchows Archiv* 422, 35-38.
31. Leav, I., McNeal, J. E., Kwan, P. W. L., Komminoth, P., and Merk, F. B. (1996) Androgen Receptor Expression in Prostatic Dysplasia (Prostatic Intraepithelial Neoplasia) in the Human Prostate: An Immunohistochemical and In Situ Hybridization Study, *The Prostate* 29, 137-145.
32. Kurita, T., Wang, Y., Donjacour, A., Zhao, C., Lydon, J., O'Malley, B., Isaacs, J., Dahiya, R., and Cunha, G. (2001) Paracrine regulation of apoptosis by steroid hormones in the male and female reproductive system, *Cell death and differentiation* 8, 192.
33. Hanahan, D., and Weinberg, R. A. (2011) Hallmarks of cancer: the next generation, *Cell* 144, 646-674.
34. Bosland, M. C. (2000) The role of steroid hormones in prostate carcinogenesis, *JNCI Monographs* 2000, 39-66.
35. Scher, H. I., and Sawyers, C. L. (2005) Biology of progressive, castration-resistant prostate cancer: directed therapies targeting the androgen-receptor signaling axis, *Journal of Clinical Oncology* 23, 8253-8261.
36. Yuan, X., and Balk, S. P. (2009) Mechanisms mediating androgen receptor reactivation after castration, pp 36-41, Elsevier.
37. Grossmann, M. E., Huang, H., and Tindall, D. J. (2001) Androgen Receptor Signaling in Androgen-Refractory Prostate Cancer, *Journal of the National Cancer Institute* 93, 1687-1697.
38. De Winter, J. A. R., Janssen, P., Sleddens, H., Verleun-Mooijman, M., Trapman, J., Brinkmann, A. O., Santerse, A. B., Schröder, F., and van der Kwast, T. H. (1994) Androgen receptor status in localized and locally progressive hormone refractory human prostate cancer, *The American journal of pathology* 144, 735.
39. Heinlein, C. A., and Chang, C. (2004) Androgen Receptor in Prostate Cancer, *Endocrine Reviews* 25, 276-308.
40. Feldman, B. J., and Feldman, D. (2001) The development of androgen-independent prostate cancer, *Nature Reviews Cancer* 1, 34-45.
41. Flourakis, M., and Prevarskaya, N. (2009) Insights into Ca<sup>2+</sup> homeostasis of advanced prostate cancer cells, *Biochim Biophys Acta* 1793, 1105-1109.
42. Mimeault, M., and Batra, S. K. (2005) Recent advances on multiple tumorigenic cascades involved in prostatic cancer progression and targeting therapies, *Carcinogenesis* 27, 1-22.
43. Cai, C., and Balk, S. P. (2011) Intratumoral androgen biosynthesis in prostate cancer pathogenesis and response to therapy, *Endocrine-related cancer* 18, R175-R182.
44. Knudsen, K. E., and Penning, T. M. (2010) Partners in crime: deregulation of AR activity and androgen synthesis in prostate cancer, *Trends in Endocrinology & Metabolism* 21, 315-324.

45. Locke, J. A., Guns, E. S., Lubik, A. A., Adomat, H. H., Hendy, S. C., Wood, C. A., Ettinger, S. L., Gleave, M. E., and Nelson, C. C. (2008) Androgen levels increase by intratumoral de novo steroidogenesis during progression of castration-resistant prostate cancer, *Cancer research* **68**, 6407.
46. Chang, K. H., Li, R., Papari-Zareei, M., Watumull, L., Zhao, Y. D., Auchus, R. J., and Sharifi, N. (2011) Dihydrotestosterone synthesis bypasses testosterone to drive castration-resistant prostate cancer, *Proceedings of the National Academy of Sciences* **108**, 13728-13733.
47. Buchanan, G., Greenberg, N. M., Scher, H. I., Harris, J. M., Marshall, V. R., and Tilley, W. D. (2001) Collocation of androgen receptor gene mutations in prostate cancer, *Clinical cancer research* **7**, 1273-1281.
48. Scher, H. I., Buchanan, G., Gerald, W., Butler, L. M., and Tilley, W. D. (2004) Targeting the androgen receptor: improving outcomes for castration-resistant prostate cancer, *Endocrine-related cancer* **11**, 459-476.
49. Tilley, W. D., Buchanan, G., Hickey, T. E., and Bentel, J. M. (1996) Mutations in the androgen receptor gene are associated with progression of human prostate cancer to androgen independence, *Clinical cancer research* **2**, 277-285.
50. Marcelli, M., Ittmann, M., Mariani, S., Sutherland, R., Nigam, R., Murthy, L., Zhao, Y., DiConcini, D., Puxeddu, E., and Esen, A. (2000) Androgen receptor mutations in prostate cancer, *Cancer research* **60**, 944.
51. Vanoverberghe, K., Mariot, P., Vanden Abeele, F., Delcourt, P., Parys, J. B., and Prevarskaya, N. (2003) Mechanisms of ATP-induced calcium signaling and growth arrest in human prostate cancer cells, *Cell Calcium* **34**, 75-85.
52. Fujita, T. (1999) Senescence Marker Protein-30 (SMP30): Structure and Biological Function\* 1,\* 2, *Biochemical and biophysical research communications* **254**, 1-4.
53. Berridge, M. J., Lipp, P., and Bootman, M. D. (2000) The versatility and universality of calcium signalling, *Nature Reviews Molecular Cell Biology* **1**, 11-21.
54. Prevarskaya, N., Skryma, R., and Shuba, Y. (2004) Ca<sup>2+</sup> homeostasis in apoptotic resistance of prostate cancer cells, *Biochem Biophys Res Commun* **322**, 1326-1335.
55. Berridge, M. J., Bootman, M. D., and Roderick, H. L. (2003) Calcium signalling: dynamics, homeostasis and remodelling, *Nature Reviews Molecular Cell Biology* **4**, 517-529.
56. Bringhurst, F., Demay, M., and Kronenberg, H. (1998) Hormones and disorders of mineral metabolism, *Williams textbook of endocrinology* **11**.
57. Brown, E. (1991) Extracellular Ca<sup>2+</sup> sensing, regulation of parathyroid cell function, and role of Ca<sup>2+</sup> and other ions as extracellular (first) messengers, *Physiological reviews* **71**, 371-411.
58. Brown, E. M., and MacLeod, R. J. (2001) Extracellular calcium sensing and extracellular calcium signaling, *Physiological reviews* **81**, 239-297.
59. Carafoli, E. (1987) Intracellular calcium homeostasis, *Annual review of biochemistry* **56**, 395-433.
60. Carafoli, E. (2002) Calcium signaling: a tale for all seasons, *Proceedings of the National Academy of Sciences* **99**, 1115.
61. Blaustein, M. P., and Lederer, W. J. (1999) Sodium/calcium exchange: its physiological implications, *Physiological reviews* **79**, 763-854.
62. Wang, H. G., Pathan, N., Ethell, I. M., Krajewski, S., Yamaguchi, Y., Shibasaki, F., McKeon, F., Bobo, T., Franke, T. F., and Reed, J. C. (1999) Ca<sup>2+</sup>-induced apoptosis through calcineurin dephosphorylation of BAD, *Science* **284**, 339-343.
63. Rao, A., Luo, C., and Hogan, P. G. (1997) Transcription factors of the NFAT family: regulation and function, *Annual review of immunology* **15**, 707-747.
64. Robertson, J. D., Orrenius, S., and Zhivotovsky, B. (2000) Review: nuclear events in apoptosis, *Journal of Structural Biology* **129**, 346-358.
65. Pinton, P., and Rizzuto, R. (2006) Bcl-2 and Ca<sup>2+</sup> homeostasis in the endoplasmic reticulum, *Cell Death Differ* **13**, 1409-1418.
66. Rosenberger, S., Thorey, I. S., Werner, S., and Boukamp, P. (2007) A novel regulator of telomerase S100A8 mediates differentiation-dependent and calcium-induced inhibition of telomerase activity in the human epidermal keratinocyte line HaCaT, *Journal of Biological Chemistry* **282**, 6126-6135.

67. Bikle, D., Oda, Y., and Xie, Z. (2004) Calcium and 1, 25 (OH) 2D: interacting drivers of epidermal differentiation, *The Journal of steroid biochemistry and molecular biology* 89, 355-360.
68. Cullen, P. J., and Lockyer, P. J. (2002) Integration of calcium and Ras signalling, *Nature Reviews Molecular Cell Biology* 3, 339-348.
69. Minaguchi, T., Waite, K. A., and Eng, C. (2006) Nuclear Localization of PTEN Is Regulated by Ca<sup>2+</sup> through a Tyrosyl Phosphorylation-Independent Conformational Modification in Major Vault Protein, *Cancer research* 66, 11677.
70. Cook, S. J., and Lockyer, P. J. (2006) Recent advances in Ca<sup>2+</sup>-dependent Ras regulation and cell proliferation, *Cell calcium* 39, 101-112.
71. Kifor, O., Diaz, R., Butters, R., and Brown, E. M. (1997) The Ca<sup>2+</sup>-Sensing Receptor (CaR) Activates Phospholipases C, A2, and D in Bovine Parathyroid and CaR-Transfected, Human Embryonic Kidney (HEK293) Cells, *Journal of Bone and Mineral Research* 12, 715-725.
72. HAWKINS, D., ENYEDI, P., and BROWN, E. (1989) The effects of high extracellular Ca<sup>2+</sup> and Mg<sup>2+</sup> concentrations on the levels of inositol 1, 3, 4, 5-tetrakisphosphate in bovine parathyroid cells, *Endocrinology* 124, 838-844.
73. Yano, S., Macleod, R. J., Chattopadhyay, N., Tfelt-Hansen, J., Kifor, O., Butters, R. R., and Brown, E. M. (2004) Calcium-sensing receptor activation stimulates parathyroid hormone-related protein secretion in prostate cancer cells: role of epidermal growth factor receptor transactivation, *Bone* 35, 664-672.
74. Lamprecht, S. A., and Lipkin, M. (2003) Chemoprevention of colon cancer by calcium, vitamin D and folate: molecular mechanisms, *Nature Reviews Cancer* 3, 601-614.
75. Sanders, J. L., Chattopadhyay, N., Kifor, O., Yamaguchi, T., and Brown, E. M. (2001) Ca<sup>2+</sup>-sensing receptor expression and PTHrP secretion in PC-3 human prostate cancer cells, *American Journal of Physiology-Endocrinology And Metabolism* 281, E1267-E1274.
76. Carafoli, E., Santella, L., Branca, D., and Brini, M. (2001) Generation, control, and processing of cellular calcium signals, *Critical reviews in biochemistry and molecular biology* 36, 107.
77. Yamaguchi, M. (2011) Regucalcin and cell regulation: role as a suppressor protein in signal transduction, *Molecular and Cellular Biochemistry*, 1-37.
78. Yamaguchi, M. (2000) Role of regucalcin in calcium signaling, *Life sciences* 66, 1769-1780.
79. Fujita, T., Mandel, J. L., Shirasawa, T., Hino, O., Shirai, T., and Maruyama, N. (1995) Isolation of cDNA clone encoding human homologue of senescence marker protein-30 (SMP30) and its location on the X chromosome, *Biochimica et Biophysica Acta (BBA)-Gene Structure and Expression* 1263, 249-252.
80. Fujita, T., Shirasawa, T., Uchida, K., and Maruyama, N. (1992) Isolation of cDNA clone encoding rat senescence marker protein-30 (SMP30) and its tissue distribution, *Biochimica et Biophysica Acta (BBA)-Gene Structure and Expression* 1132, 297-305.
81. Shimokawa, N., Isogai, M., and Yamaguchi, M. (1995) Specific species and tissue differences for the gene expression of calcium-binding protein regucalcin, *Molecular and cellular biochemistry* 143, 67-71.
82. Yamaguchi, M. (2011) The transcriptional regulation of regucalcin gene expression, *Mol Cell Biochem* 346, 147-171.
83. Yamaguchi, M., and Isogai, M. (1993) Tissue concentration of calcium-binding protein regucalcin in rats by enzyme-linked immunoadsorbent assay, *Mol Cell Biochem* 122, 65-68.
84. Yamaguchi, M., Hamano, T., and Misawa, H. (2000) Expression of Ca<sup>2+</sup>-binding protein regucalcin in rat brain neurons: inhibitory effect on protein phosphatase activity, *Brain research bulletin* 52, 343-348.
85. Yamaguchi, M., and Nakajima, R. (2002) Role of regucalcin as an activator of sarcoplasmic reticulum Ca<sup>2+</sup>-ATPase activity in rat heart muscle, *Journal of cellular biochemistry* 86, 184-193.
86. Yamaguchi, M., Misawa, H., Uchiyama, S., Morooka, Y., and Tsurusaki, Y. (2002) Role of endogenous regucalcin in bone metabolism: bone loss is induced in regucalcin transgenic rats, *International journal of molecular medicine* 10, 377.



87. Maia, C. J., Santos, C. R., Schmitt, F., and Socorro, S. (2008) Regucalcin is expressed in rat mammary gland and prostate and down-regulated by 17beta-estradiol, *Mol Cell Biochem* 311, 81-86.
88. Murata, T., Shinya, N., and Yamaguchi, M. (1997) Expression of calcium-binding protein regucalcin mRNA in the cloned human hepatoma cells (HegG2): Stimulation by insulin, *Molecular and cellular biochemistry* 175, 163-168.
89. Nakajima, M., Murata, T., and Yamaguchi, M. (1999) Expression of calcium-binding protein regucalcin mRNA in the cloned rat hepatoma cells (Hr-II-E) is stimulated through Ca<sup>2+</sup> signaling factors: Involvement of protein kinase C, *Molecular and cellular biochemistry* 198, 101-107.
90. Yamaguchi, M., and Nakajima, M. (1999) Involvement of intracellular signaling factors in the serum-enhanced Ca<sup>2+</sup>-binding protein regucalcin mRNA expression in the cloned rat hepatoma cells (H4-II-E), *Journal of cellular biochemistry* 74, 81-89.
91. Misawa, H., and Yamaguchi, M. (2000) Transcript heterogeneity of the human gene for Ca<sup>2+</sup>-binding protein regucalcin, *International journal of molecular medicine* 5, 283-287.
92. Yamaguchi, M., Takakura, Y., and Nakagawa, T. (2008) Regucalcin increases Ca<sup>2+</sup> ATPase activity in the mitochondria of brain tissues of normal and transgenic rats, *Journal of Cellular Biochemistry* 104, 795-804.
93. Yamaguchi, M., Kanayama, Y., and Shimokawa, N. (1994) Expression of calcium-binding protein regucalcin mRNA in rat liver is stimulated by calcitonin: the hormonal effect is mediated through calcium, *Molecular and cellular biochemistry* 136, 43-48.
94. Yamaguchi, M., Oishi, K., and Isogai, M. (1995) Expression of hepatic calcium-binding protein regucalcin mRNA is elevated by refeeding of fasted rats: Involvement of glucose, insulin and calcium as stimulating factors, *Molecular and cellular biochemistry* 142, 35-41.
95. Yamaguchi, M., and Oishi, K. (1995) 17β-estradiol stimulates the expression of hepatic calcium-binding protein regucalcin mRNA in rats, *Molecular and cellular biochemistry* 143, 137-141.
96. Kurota, H., and Yamaguchi, M. (1996) Steroid hormonal regulation of calcium-binding protein regucalcin mRNA expression in the kidney cortex of rats, *Molecular and cellular biochemistry* 155, 105-111.
97. Tsai, M.-J., and O'Malley, B. (1991) Mechanism of regulation of gene transcription by steroid receptors. In: Cohen P, Foulkes JG (eds) The hormonal control of gene transcription, *Elsevier, Amsterdam*, pp101-128.
98. Nejak-Bowen, K. N., Zeng, G., Tan, X., Cieply, B., and Monga, S. P. (2009) β-catenin regulates vitamin C biosynthesis and cell survival in murine liver, *Journal of Biological Chemistry* 284, 28115-28127.
99. Yamaguchi, M., Otomo, Y., Uchiyama, S., and Nakagawa, T. (2008) Hormonal regulation of regucalcin mRNA expression in osteoblastic MC3T3-E1 cells, *International journal of molecular medicine* 21, 771.
100. Fujita, T., Shirasawa, T., and Maruyama, N. (1996) Isolation and characterization of genomic and cDNA clones encoding mouse senescence marker protein-30 (SMP30), *Biochimica et Biophysica Acta (BBA) - Gene Structure and Expression* 1308, 49-57.
101. Fujita, T., Shirasawa, T., Inoue, H., Kitamura, T., and Maruyama, N. (1998) Hepatic and renal expression of senescence marker protein-30 and its biological significance, *J Gastroenterol Hepatol* 13 Suppl, S124-131.
102. Yamaguchi, M., Mori, S., and Kato, S. (1988) Calcium-binding protein regucalcin is an activator of (Ca<sup>2+</sup>-Mg<sup>2+</sup>)-adenosine triphosphatase in the plasma membranes of rat liver, *Chemical & pharmaceutical bulletin* 36, 3532.
103. Takahashi, H., and Yamaguchi, M. (1993) Regulatory effect of regucalcin on (Ca<sup>2+</sup>-Mg<sup>2+</sup>)-ATPase in rat liver plasma membranes: comparison with the activation by Mn<sup>2+</sup> and Co<sup>2+</sup>, *Molecular and cellular biochemistry* 124, 169-174.
104. Takahashi, H., and Yamaguchi, M. (1997) Stimulatory effect of regucalcin on ATP-dependent calcium transport in rat liver plasma membranes, *Molecular and cellular biochemistry* 168, 149-153.
105. Kurota, H., and Yamaguchi, M. (1997) Activatory effect of calcium-binding protein regucalcin on ATP-dependent calcium transport in the basolateral membranes of rat kidney cortex, *Molecular and cellular biochemistry* 169, 149-156.

106. Yamaguchi, M., Hanahisa, Y., and Murata, T. (1999) Expression of calcium-binding protein regucalcin and microsomal Ca<sup>2+</sup>-ATPase regulation in rat brain: Attenuation with increasing age, *Molecular and cellular biochemistry* 200, 43-49.
107. Yamaguchi, M., Takakura, Y., and Nakagawa, T. (2008) Regucalcin increases Ca<sup>2+</sup>-ATPase activity in the mitochondria of brain tissues of normal and transgenic rats, *Journal of cellular biochemistry* 104, 795-804.
108. Yamaguchi, M., and Yoshida, H. (1985) Regulatory effect of calcium-binding protein isolated from rat liver cytosol on activation of fructose 1, 6-diphosphatase by Ca<sup>2+</sup>-calmodulin, *Chemical & pharmaceutical bulletin* 33, 4489.
109. Nakagawa, T., and Yamaguchi, M. (2006) Overexpression of regucalcin enhances its nuclear localization and suppresses L-type Ca<sup>2+</sup> channel and calcium-sensing receptor mRNA expressions in cloned normal rat kidney proximal tubular epithelial NRK52E cells, *Journal of cellular biochemistry* 99, 1064-1077.
110. Tsurusaki, Y., and Yamaguchi, M. (2003) Overexpression of regucalcin modulates tumor-related gene expression in cloned rat hepatoma H4-II-E cells, *Journal of cellular biochemistry* 90, 619-626.
111. Tsurusaki, Y., and Yamaguchi, M. (2004) Role of regucalcin in liver nuclear function: binding of regucalcin to nuclear protein or DNA and modulation of tumor-related gene expression, *International journal of molecular medicine* 14, 277.
112. Izumi, T., Tsurusaki, Y., and Yamaguchi, M. (2003) Suppressive effect of endogenous regucalcin on nitric oxide synthase activity in cloned rat hepatoma H4-II-E cells overexpressing regucalcin, *Journal of cellular biochemistry* 89, 800-807.
113. Bellomo, G., Perotti, M., Taddei, F., Mirabelli, F., Finardi, G., Nicotera, P., and Orrenius, S. (1992) Tumor necrosis factor  $\alpha$  induces apoptosis in mammary adenocarcinoma cells by an increase in intranuclear free Ca<sup>2+</sup> concentration and DNA fragmentation, *Cancer research* 52, 1342.
114. Izumi, T., and Yamaguchi, M. (2004) Overexpression of regucalcin suppresses cell death in cloned rat hepatoma H4-II-E cells induced by tumor necrosis factor- $\alpha$  or thapsigargin, *Journal of cellular biochemistry* 92, 296-306.
115. Izumi, T., and Yamaguchi, M. (2004) Overexpression of regucalcin suppresses cell death and apoptosis in cloned rat hepatoma H4-II-E cells induced by lipopolysaccharide, PD 98059, dibucaine, or Bay K 8644, *Journal of cellular biochemistry* 93, 598-608.
116. Yamaguchi, M., and Sakurai, T. (1991) Inhibitory effect of calcium-binding protein regucalcin on Ca<sup>2+</sup>-activated DNA fragmentation in rat liver nuclei, *FEBS letters* 279, 281-284.
117. Yamaguchi, M. (1988) Physicochemical Properties of Calcium-Binding Protein Isolated from Rat Liver Cytosol: Ca<sup>2+</sup>-Induced Conformational Changes, *Chemical & pharmaceutical bulletin* 36, 286-290.
118. Zelivianski, S., Spellman, M., Kellerman, M., Kakitelashvilli, V., Zhou, X. W., Lugo, E., Lee, M. S., Taylor, R., Davis, T. L., and Hauke, R. (2003) ERK inhibitor PD98059 enhances docetaxel-induced apoptosis of androgen-independent human prostate cancer cells, *International journal of cancer* 107, 478-485.
119. Cano-Abad, M. F., Villarroya, M., García, A. G., Gabilan, N. H., and López, M. G. (2001) Calcium entry through L-type calcium channels causes mitochondrial disruption and chromaffin cell death, *Journal of Biological Chemistry* 276, 39695-39704.
120. Nakagawa, T., and Yamaguchi, M. (2005) Overexpression of regucalcin suppresses apoptotic cell death in cloned normal rat kidney proximal tubular epithelial NRK52E cells: Change in apoptosis-related gene expression, *Journal of cellular biochemistry* 96, 1274-1285.
121. Inagaki, S., and Yamaguchi, M. (2001) Suppressive role of endogenous regucalcin in the enhancement of protein kinase activity with proliferation of cloned rat hepatoma cells (H4-II-E), *Journal of cellular biochemistry* 81, 12-18.
122. Tsurusaki, Y., Misawa, H., and Yamaguchi, M. (2000) Translocation of regucalcin to rat liver nucleus: involvement of nuclear protein kinase and protein phosphatase regulation, *International journal of molecular medicine* 6, 655.
123. Yamaguchi, M., and Tai, H. (1991) Inhibitory effect of calcium-binding protein regucalcin on Ca<sup>2+</sup>/calmodulin-dependent cyclic nucleotide phosphodiesterase activity in rat liver cytosol, *Mol Cell Biochem* 106, 25-30.

124. Mori, S., and Yamaguchi, M. (1990) Hepatic calcium-binding protein regucalcin decreases Ca<sup>2+</sup>/calmodulin-dependent protein kinase activity in rat liver cytosol, *Chemical & pharmaceutical bulletin* 38, 2216.
125. Hamano, T., and Yamaguchi, M. (2001) Inhibitory role of regucalcin in the regulation of Ca<sup>2+</sup>-dependent protein kinases activity in rat brain neurons, *Journal of the neurological sciences* 183, 33-38.
126. Katsumata, T., and Yamaguchi, M. (1998) Inhibitory effect of calcium-binding protein regucalcin on protein kinase activity in the nuclei of regenerating rat liver, *Journal of cellular biochemistry* 71, 569-576.
127. Yamaguchi, M., and Kanayama, Y. (1996) Calcium-binding protein regucalcin inhibits deoxyribonucleic acid synthesis in the nuclei of regenerating rat liver, *Molecular and cellular biochemistry* 162, 121-126.
128. Tsurusaki, Y., and Yamaguchi, M. (2002) Role of endogenous regucalcin in nuclear regulation of regenerating rat liver: Suppression of the enhanced ribonucleic acid synthesis activity, *Journal of cellular biochemistry* 87, 450-457.
129. Nakagawa, T., Sawada, N., and Yamaguchi, M. (2005) Overexpression of regucalcin suppresses cell proliferation of cloned normal rat kidney proximal tubular epithelial NRK52E cells, *International journal of molecular medicine* 16, 637.
130. Nakagawa, T., and Yamaguchi, M. (2007) Overexpression of regucalcin suppresses cell response for tumor necrosis factor- $\alpha$  or transforming growth factor- $\beta$ 1 in cloned normal rat kidney proximal tubular epithelial NRK52E cells, *Journal of cellular biochemistry* 100, 1178-1190.
131. Yamaguchi, M., and Daimon, Y. (2005) Overexpression of regucalcin suppresses cell proliferation in cloned rat hepatoma H4-II-E cells: Involvement of intracellular signaling factors and cell cycle-related genes, *Journal of cellular biochemistry* 95, 1169-1177.
132. Makino, R., and Yamaguchi, M. (1996) Expression of calcium-binding protein regucalcin mRNA in hepatoma cells, *Molecular and cellular biochemistry* 155, 85-90.
133. Elchuri, S., Naeemuddin, M., Sharpe, O., Robinson, W. H., and Huang, T. T. (2007) Identification of biomarkers associated with the development of hepatocellular carcinoma in CuZn superoxide dismutase deficient mice, *Proteomics* 7, 2121-2129.
134. Kim, J., Kim, S. H., Lee, S. U., Ha, G. H., Kang, D. G., Ha, N. Y., Ahn, J. S., Cho, H. Y., Kang, S. J., and Lee, Y. J. (2002) Proteome analysis of human liver tumor tissue by two-dimensional gel electrophoresis and matrix-assisted laser desorption/ionization-mass spectrometry for identification of disease-related proteins, *Electrophoresis* 23, 4142-4156.
135. Kim, W., Lim, S. O., Kim, J. S., Ryu, Y. H., Byeon, J. Y., Kim, H. J., Kim, Y. I., Heo, J. S., Park, Y. M., and Jung, G. (2003) Comparison of proteome between hepatitis B virus- and hepatitis C virus-associated hepatocellular carcinoma, *Clinical cancer research* 9, 5493-5500.
136. Inagaki, S., and Yamaguchi, M. (2000) Enhancement of protein tyrosine phosphatase activity in the proliferation of cloned rat hepatoma H4-II-E cells: suppressive role of endogenous regucalcin, *International journal of molecular medicine* 6, 323.
137. Inagaki, S., and Yamaguchi, M. (2001) Regulatory role of endogenous regucalcin in the enhancement of nuclear deoxyribonucleic acid synthesis with proliferation of cloned rat hepatoma cells (H4-II-E), *Journal of cellular biochemistry* 82, 704-711.
138. Misawa, H., Inagaki, S., and Yamaguchi, M. (2002) Suppression of cell proliferation and deoxyribonucleic acid synthesis in the cloned rat hepatoma H4-II-E cells overexpressing regucalcin, *Journal of cellular biochemistry* 84, 143-149.
139. Murata, T., and Yamaguchi, M. (1997) Molecular cloning of the cDNA coding for regucalcin and its mRNA expression in mouse liver: the expression is stimulated by calcium administration, *Molecular and cellular biochemistry* 173, 127-133.
140. Cheng, I., Klingensmith, M. E., Chattopadhyay, N., Kifor, O., Butters, R. R., Soybel, D. I., and Brown, E. M. (1998) Identification and localization of the extracellular calcium-sensing receptor in human breast, *Journal of Clinical Endocrinology & Metabolism* 83, 703-707.
141. Sanders, J. L., Chattopadhyay, N., Kifor, O., Yamaguchi, T., Butters, R. R., and Brown, E. M. (2000) Extracellular calcium-sensing receptor expression and its potential role in regulating parathyroid hormone-related peptide secretion in human breast cancer cell lines, *Endocrinology* 141, 4357-4364.

142. Sheinin, Y., Kállay, E., Wrba, F., Kriwanek, S., Peterlik, M., and Cross, H. S. (2000) Immunocytochemical localization of the extracellular calcium-sensing receptor in normal and malignant human large intestinal mucosa, *Journal of Histochemistry & Cytochemistry* 48, 595.
143. Chakrabarty, S., Radjendirane, V., Appelman, H., and Varani, J. (2003) Extracellular Calcium and Calcium Sensing Receptor Function in Human Colon Carcinomas, *Cancer research* 63, 67.
144. Haven, C. J., van Puijenbroek, M., Karperien, M., Fleuren, G. J., and Morreau, H. (2004) Differential expression of the calcium sensing receptor and combined loss of chromosomes 1q and 11q in parathyroid carcinoma, *The Journal of pathology* 202, 86-94.
145. Gogusev, J., Duchambon, P., Hory, B., Giovannini, M., Goureau, Y., Sarfati, E., and Drüeke, T. B. (1997) Depressed expression of calcium receptor in parathyroid gland tissue of patients with hyperparathyroidism, *Kidney international* 51, 328-336.
146. Nakagawa, T., and Yamaguchi, M. (2006) Overexpression of regucalcin enhances its nuclear localization and suppresses L-type Ca<sup>2+</sup> channel and calcium-sensing receptor mRNA expressions in cloned normal rat kidney proximal tubular epithelial NRK52E cells, *Journal of cellular biochemistry* 99, 1064-1077.
147. Lin, K. I., Chattopadhyay, N., Bai, M., Alvarez, R., Dang, C. V., Baraban, J. M., Brown, E. M., and Ratan, R. R. (1998) Elevated extracellular calcium can prevent apoptosis via the calcium-sensing receptor, *Biochem Biophys Res Commun* 249, 325-331.
148. Chattopadhyay, N., Yano, S., Tfelt-Hansen, J., Rooney, P., Kanuparthi, D., Bandyopadhyay, S., Ren, X., Terwilliger, E., and Brown, E. M. (2004) Mitogenic action of calcium-sensing receptor on rat calvarial osteoblasts, *Endocrinology* 145, 3451-3462.
149. Tfelt-Hansen, J., Chattopadhyay, N., Yano, S., Kanuparthi, D., Rooney, P., Schwarz, P., and Brown, E. (2004) Calcium-sensing receptor induces proliferation through p38 mitogen-activated protein kinase and phosphatidylinositol 3-kinase but not extracellularly regulated kinase in a model of humoral hypercalcemia of malignancy, *Endocrinology* 145, 1211-1217.
150. Tomlins, S. A., Bollinger, N., Creim, J., and Rodland, K. D. (2005) Cross-talk between the calcium-sensing receptor and the epidermal growth factor receptor in Rat-1 fibroblasts, *Experimental Cell Research* 308, 439-445.
151. Yamaguchi, T., Yamauchi, M., Sugimoto, T., Chauhan, D., Anderson, K. C., Brown, E. M., and Chihara, K. (2002) The extracellular calcium (Ca<sup>2+</sup>)<sup>o</sup>-sensing receptor is expressed in myeloma cells and modulates cell proliferation, *Biochemical and Biophysical Research Communications* 299, 532-538.
152. Chattopadhyay, N., Ye, C. P., Yamaguchi, T., Kerner, R., Vassilev, P. M., and Brown, E. M. (1999) Extracellular calcium-sensing receptor induces cellular proliferation and activation of a nonselective cation channel in U373 human astrocytoma cells, *Brain research* 851, 116-124.

