

University of New Orleans

ScholarWorks@UNO

University of New Orleans Theses and
Dissertations

Dissertations and Theses

12-20-2009

Monitoring and Inverse Dispersion Modeling to Quantify VOCs from MSW Landfill

Sarit Kumar Das

University of New Orleans

Follow this and additional works at: <https://scholarworks.uno.edu/td>

Recommended Citation

Das, Sarit Kumar, "Monitoring and Inverse Dispersion Modeling to Quantify VOCs from MSW Landfill" (2009). *University of New Orleans Theses and Dissertations*. 1093.

<https://scholarworks.uno.edu/td/1093>

This Thesis is protected by copyright and/or related rights. It has been brought to you by ScholarWorks@UNO with permission from the rights-holder(s). You are free to use this Thesis in any way that is permitted by the copyright and related rights legislation that applies to your use. For other uses you need to obtain permission from the rights-holder(s) directly, unless additional rights are indicated by a Creative Commons license in the record and/or on the work itself.

This Thesis has been accepted for inclusion in University of New Orleans Theses and Dissertations by an authorized administrator of ScholarWorks@UNO. For more information, please contact scholarworks@uno.edu.

Monitoring and Inverse Dispersion Modeling to Quantify VOCs from MSW Landfill

A Thesis

Submitted to the Graduate Faculty of the
University of New Orleans
in partial fulfillment of the
requirements for the degree of

Master of Science
in
Environmental Engineering

by

Sarit K. Das

M.Tech., Indian Institute of Technology, Bombay, 2007

December, 2009

Acknowledgement

The author wishes to recognize several individuals for their help and contributions to the completion of this thesis.

First of all, my greatest gratitude to my beloved mother Late Rina Das who inspired me to remain positive in all circumstances in life.

I would like to express my gratitude to my advisor Dr. Bhaskar Kura for his generous, prompt, and patient guidance and instruction in the preparation of this document and the completion of my degree requirements. Dr. Kura has given me advice, support, and has provided me with a source of motivation over the last 2 years.

I would like to thank Dr. Enrique LaMotta for serving as a member of my Graduate Examining Committee. I would also thank Dr. Patricia Williams for serving on my Graduate Examining Committee and providing me an opportunity to work collaboratively.

Many thanks to the staff of the Civil and Environmental Engineering Department, especially to Juana, who were helpful in solving the problems I experienced from day to day.

Many thanks to friends in Dr. Kura's research group, Neveen, Amitdyuti, Goutham and especially Suruchi for all the help extended to me.

Thanks are also expressed to the staff at River Birch Landfill LLC site, especially Dr. Vic Culpepper for provide me data, ample advice and financial support towards my graduate assistantship.

Finally, I would like to thank my family, my father, Sanat Kumar Das and my fiancée Bishakha Ghosh whose love and confidence have given me the strength to obtain many goals in my life.

Table of Contents

	Page No.
List of Tables.....	iv
List of Figures.....	v
List of Abbreviations.....	vi
Abstract.....	vii
1. Introduction.....	1
2. Scope and Objectives.....	4
3. Literature Review.....	5
3.1 Landfill Gas Generation.....	5
3.2 Landfill Gas and Health Effect.....	9
3.3 Landfill Gas Management.....	10
3.4 Landfill Gas Monitoring.....	11
3.5 Landfill Gas Emission Modeling.....	13
3.6 MATLAB.....	16
4. Experimental Setup.....	17
4.1 Details of the Site.....	17
4.2 Inverse Gaussian Dispersion.....	19
4.3 Steps.....	22
4.4 Instruments Used.....	23
4.4.1 VOC Analyzer.....	23
4.4.2 GPS Receiver.....	26
4.4.3 Portable Weather Station.....	27
4.5 Grid Formation.....	28
4.6 Conversion of Geographic Coordinates.....	28
4.7 Conversion of PID Readings to FID Readings.....	31
4.8 Conversion from ppm to gm/m ³	33
5. Results and Discussion.....	34
5.1 Sensitivity Analysis.....	37
5.2 LandGEM Analysis.....	38
6. Conclusions.....	40
7. Recommendations.....	41
References.....	42
Appendix I.....	46
Vita.....	47

List of Tables

Tables	Page No.
Table 1. VOCs detected in a landfill cell	13
Table 2. Historical Data of Waste Deposition	18
Table 3. Calculation of combined correction factor for the possible mixture of VOCs	32
Table 4. Meteorological conditions during field data collection	34
Table 5. Comparison of emission rates for cases within the same grid on May 15 th and May 22 nd	37
Table 6. The major inputs and results of LandGEM model	38
Table 7. Comparison of results on total VOC emission in different studies	38

List of Figures

	Figures	Page No.
Figure 1.	Site map for River Birch Sub-title D Landfill	18
Figure 2.	Gaussian Dispersion Model	20
Figure 3.	Thermo® 580B OVM	24
Figure 4.	The PID Detector Assembly in Thermo® 580B OVM	25
Figure 5.	GARMIN GPSMAP 60cx	26
Figure 6.	Waypoints on GARMIN GPSMAP 60cx	27
Figure 7.	DAVIS® Weather Wizard III	27
Figure 8.	Demarcation of Grid with equidistant receptor locations using Placemark on Google Earth	28
Figure 9.	ECEF Coordinate Reference Frame	29
Figure 10.	Ellipsoid Parameters	30
Figure 11.	ECEF and Reference Ellipsoid	30
Figure 12.	Source and Receptor Locations in Earth-centered Earth-fixed Coordinates	35
Figure 13.	Emission Rates of NMVOCs at Different Source Locations	36
Figure 14.	3D Plot Emission Rates of NMVOCs at Different Source Locations	36

List of Abbreviation

ATSDR	American Toxic Substances and Disease Registry
CF	Correction Factor
CFR	Code of Federal Regulations
ECEF	Earth-centered Earth-fixed
FID	Flame-ionization detector
GHG	Green House Gas
GPS	Global Positioning System
LED	Light Emitting Diode
LFG	Landfill Gas
LLA	Latitude Longitude Altitude
MSW	Municipal Solid Waste
NESHAP	National Emission Standard for Hazardous Air Pollutants
NMOC	Non-methane Organic Compound
NMVOG	Non-methane volatile organic carbon
NSPS	New Source Performance Standard
OP-FTIR	Open-path Fourier Transform Infrared
ORS	Optical Remote Sensing
OVM	Organic Vapor Meter
PBLF	Purpose Built Landfill
PID	Photo-ionization detector
RCRA	Resource Conservation and Recovery Act
RSC	Reduced Sulfur Compounds
UNFCCC	United Nations Framework Convention on Climate Change
US EPA	United States Environment Protection Agency
USGS	United States Geological Survey
UTM	Universal Traverse Mercator
VOC	Volatile Organic Compounds
WGS84	World Geodetic System, 1984

Abstract

In USA, the Municipal Solid Waste (MSW) landfills accumulate about 130 million tons of solid waste every year. A significant amount of biodegradable solid waste is converted to landfill gas due to anaerobic stabilization by bacteria. These biochemical reactions produce volatile organic compounds (VOCs) like methane and others. Due to heterogeneity in refuse composition, unpredictable distribution of favorable environmental conditions for bacterial actions and highly uncertain pathway of gases, estimation of landfill gas emission for a particular landfill is complex. However, it is important to quantify landfill gases for health risk assessment and energy recovery purposes. This research is based on the monitoring and modeling methodology proposed by researchers at University of Central Florida is reported in this thesis. River Birch Sub-title D landfill, Westwego, LA was selected as the study area. The total emission calculated using the mathematical model ran on MATLAB is comparable with the result obtained from EPA LandGEM model, using historical waste deposition records.

Keywords: VOC, MSW, landfill, emission, estimation, modeling, assessment, MATLAB, LandGEM

1. Introduction

MSW landfills emit gases like methane (CH_4), carbon dioxide (CO_2), hydrogen sulfide (H_2S), and some non-methane volatile organic compounds (VOCs) such as benzene, toluene, xylene etc., due to decomposition of organic materials. Around 60% of the global methane emission is due to human activities. And about 34% of the methane emissions in USA are attributed to landfills (US Emissions Inventory, 2005). Methane is 21 times more potent than CO_2 in causing global warming (UNFCCC, 2008). The VOCs in landfill gas consists of 50% of methane and 1% of non-methane organic compounds (NMOC). However, the amount of biogas produced in landfills is a function of waste quantity, type, and age, landfill moisture content, temperature, and management practices at the site (Figueroa et al., 2008).

Low solubility and high vapor pressure cause the VOCs present within the landfill to move readily between aqueous and vapor phases in the unsaturated waste. VOCs are emitted from landfills either through volatilization of the liquid or sorption of the liquids on soil particles which later become airborne. Entrainment of particles can occur with high winds or with light winds combined with vehicle movement, earth movement, vegetation removal, and solid waste disposal activity (Bennett, 1987). Volatilization occurs as a result of a concentration gradient which causes molecules to diffuse from a bulk liquid phase, across a liquid/gas interface, to the bulk gas phase (Cooper *et al.*, 1992).

Liquid chromatography and gas chromatography with mass spectroscopy were used in many studies to characterize and quantify reduced sulfur compounds (RSCs) and VOCs in China, Korea, Turkey, USA, and others. In a case study for characterization of VOCs in landfill in south China, carbon adsorption tubes, called Carbontrap™ have been used for sample collection (Zou et al., 2003). In another case study on monitoring of odorous gases in a landfill in Turkey, mono-aromatics, halogenated, aldehydes, esters, ketones were measured among VOCs (Dincer et al., 2006). However, flux chamber method is most commonly used for collection of VOC samples from landfills (Cooper et al., 1992).

Monitoring of landfill gases can be categorized into five types viz. soil-gas monitoring, near surface gas monitoring, emissions monitoring, ambient air monitoring, and indoor air monitoring. In

near surface gas monitoring, concentration of gases are measured at a point not above 4 inches from ground surface. Typically methane is reported using this protocol. However, monitoring of VOCs in landfill can also use the same (ATSDR, 2008).

According to New Source Performance Standards (NSPS), 40 CFR 60 Subpart WWW and National Emission Standard for Hazardous Air Pollutants (NESHAP), 40 CFR 63 Subpart AAAA, for MSW landfills with potential of emitting more than 50 Mg/year of non-methane volatile compounds have to collect and combust landfill gas. As specified in 40 CFR 60.755 (c) and (d), and 40 CFR 60, Appendix A, Method 21, semi-yearly surface VOC monitoring is required to ensure that the landfill biogas collection systems are operating properly. Emission of VOCs as methane 500 ppm above background requires remedial action in the gas collection system (Figuroa et al., 2008 and Falgoust, 2009).

The Landfill Gas Emissions Model (LandGEM) is an automated estimation tool with a Microsoft Excel interface that can be used to estimate emission rates for total landfill gas, methane, carbon dioxide, non-methane organic compounds, and individual air pollutants from municipal solid waste landfills. The model contains two sets of default parameters, Clean Air Act (CAA) defaults and inventory defaults. The inventory defaults are based on emission factors in EPA's *Compilation of Air Pollutant Emission Factors (AP-42)* and can be used to generate emission estimates for use in emission inventories and air permits in the absence of site-specific test data (EPA, 2005). This is the most widely used landfill gas emission model in USA and other parts of the world.

MATLAB is a high-level technical computing language and interactive environment for algorithm development, data visualization, data analysis, and numeric computation. Using the MATLAB product, one can solve technical computing problems faster than with traditional programming languages, such as C, C++, and FORTRAN. MATLAB provides some key features those include high-level language for technical computing; development environment for managing code, files, and data; interactive tools for iterative exploration, design, and problem solving; Mathematical functions for linear algebra, statistics, Fourier analysis, filtering, optimization, and numerical integration; 2-D and 3-D graphics functions for visualizing data *etc.* (www.mathworks.com).

Due to the significance of methane emissions from landfills and potential opportunity to recovery energy and to reduce impact on climate change, there is a great need for quantifying methane gas emissions. Methane emissions depend on several factors such as, (a) composition of the waste deposited in the landfill, (b) waste deposition methods and landfill management practices, (c) age of the landfill, and (d) climatic conditions such as temperature, moisture content, and meteorological conditions. Though LandGEM provides a method to quantify methane quantities emitted, its approach is more generalized and better quantification methodology is required. Gaussian dispersion algorithm is generally used for estimating ambient concentration of any airborne pollutant at any receptor location around the source having known emission rate and meteorological conditions. Inverse Gaussian dispersion algorithm can predict emission rate at the source when concentration of any pollutant at receptor locations and meteorological conditions are known. This study aims at developing a landfill gas quantification methodology based on near-surface monitoring at multiple receptor locations and a mathematical model based on Inverse-Gaussian algorithm employed by Figueroa et al., 2008 in similar research.

2. Scope and Objectives

The main objective of this research is to develop a landfill gas emission monitoring and modeling methodology to improve existing landfill gas management system. Quantification of landfill gases, methane and non-methane are important for several reasons. For example, is important landfill gas with respect to energy recovery and as a green house gas (GHG) with high potential to cause climate change and non-methane VOCs (NMVOCs) are important due their toxic effects on humans and the environment. The specific objectives of this research include:

1. Design and execute a near surface gas monitoring plan using portable VOC analyzer for measuring concentration of NMVOCs and weather monitoring station for measuring meteorological parameters necessary for air quality modeling.
2. Develop a “MATLAB model” based on inverse Gaussian dispersion model for estimation of NMVOCs emitted from landfills that can use (a) measured NMVOCs surface concentrations and (b) meteorological parameters as input data.
3. Analyze the sensitivity of “MATLAB Inverse Gaussian Dispersion Model” with different number of receptors and meteorological conditions.
4. Calculate total emission rate for the landfill using EPA LandGEM model and historical waste deposition data.
5. Compare total NMVOCs emission rate calculated using “MATLAB Inverse Gaussian Dispersion Model” with the results of LandGEM model and the study of Figueroa et.al.

3. Literature Review

Approximately 64 percent of all municipal solid waste (MSW) generated in the United States is currently being disposed off in roughly 1,800 operational MSW landfills, as referenced in EPA's Inventory of U.S. Landfills are the second-largest single human source of methane emissions in the United States, accounting for nearly 23 percent of all methane sources. Uncontrolled MSW landfills also emit non-methane organic compounds (NMOC), which include volatile organic compounds (VOC) that contribute to ozone formation and are classified as hazardous air pollutants (HAP) that can affect human health when exposed. However, combustion of landfill gas significantly reduces emissions of methane and NMOC. More than 400 MSW landfills in the United States recover and combust landfill gas to generate heat or electricity, and more than 450 other MSW landfills flare the gas (USEPA, 2008). EPA's air quality requirements and advances in landfill gas energy technologies have encouraged the combustion of landfill gas to benefit human health, safety, and the environment, as well as provide economic opportunities. Several articles including journal papers were reviewed to collect background information and understand the scientific details on landfill operations, landfill gas generation as well as the significance of monitoring and modeling landfill gas emission. Important findings of the literature review are discussed in this section.

3.1 Landfill Gas Generation

According to state and local mandate, recycling and solid waste combustion will play increasingly important roles in future integrated waste management; however, projections show that dependence on landfilling for the disposal of significant fractions of MSW will continue long into the future. Once solid waste is placed in a landfill, a complex sequence of biologically, chemically, and physically mediated events occur, which results in gaseous and liquid landfill emissions. Landfill gas is produced during the predominantly anaerobic stabilization of solid waste organic fractions. It is estimated that approximately 80 percent of solid waste is biodegradable. Significant portions of the biodegradable solid waste fraction are ultimately converted to gaseous end products.

MSW landfills emit gases like methane (CH₄), carbon dioxide (CO₂), hydrogen sulfide (H₂S), and non-methane VOCs in significant amounts due to decomposition of organic materials. Around 60% of the global methane emission is due to human activities. And 34% of the methane emissions in USA are attributed to landfills (US EPA, 2007). Methane is 21 times more potent than CO₂ in causing global warming (UNFCCC, 1996). The VOCs in landfill gas comprises more than 80% as methane. However, the amount of biogas produced in landfills is a function of waste quantity, type, and age, landfill moisture content, temperature, and management practices at the site (Figueroa et al., 2008).

The processes that produce gases in landfills are those associated with the microbiological decomposition of organic matter in the landfill. Those processes into four phases: (1) aerobic; (2) anaerobic, non-methanogenic; (3) anaerobic, methanogenic, unsteady; and (4) anaerobic, methanogenic, steady (Farquhar, 1989). A short description of each phase, as applied to a single mass of MSW after placement at time zero, is presented in the following paragraphs.

In the aerobic phase, the landfill void spaces are filled initially with air (roughly 20% oxygen and 80% nitrogen). The oxygen present promotes aerobic bacterial decomposition, and inhibits anaerobe activity. As the oxygen is used up, CO₂ is produced at approximately equivalent rates so there is no net gas generation. However, the gas composition is changing (O₂ is being replaced with CO₂).

In Phase II, once the O₂ concentration is low enough, facultative and anaerobic processes begins. Initially, hydrolysis (an extracellular, enzymatic process) occurs to reduce particulate organic matter to soluble components. This process requires significant moisture content, as well as physical contact between microorganisms and the waste. The waste gets broken down with various enzymes as follows:

cellulose --- (cellulase) ---> glucose

protein --- (protease) ---> amino acids

starch --- (amylase) ---> glucose

fats --- (lipase) ---> fatty acids

During this hydrolysis stage there is no gas production. However, as soon as the sugars and organic acids are formed, they are used by the microbes through a variety of metabolic pathways to produce simpler organic acids, water, carbon dioxide, ammonia, and even hydrogen (H). During this acid fermentation stage, CO₂ production occurs very rapidly. Different investigators have reported gas compositions as high as 50-70% CO₂ after 11 to 23 days, or even 90% CO₂ after 40 days (Farquhar 1989). Methane (CH₄) production begins in the third phase; CO₂ rates decline and H₂ production ceases. The duration of Phase III has been reported as being from 180 to 500 days (Ramaswamy, 1970; Beluche, 1968), but those studies were at less than optimal conditions and so the duration of phase III could be much shorter (Farquhar 1989).

During Phase IV, the steady methane generation phase, gas of constant composition is produced at a steady rate. The composition has been reported as 50 percent CH₄ to 66 percent CH₄ with the balance being primarily CO₂. For illustrative purposes, stoichiometric equations for the above processes (using glucose as the "waste") can be written as follows:

i. Aerobic decomposition of glucose (no net gas produced):

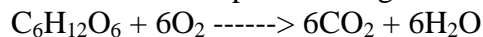

ii. Hydrolysis: No gas production

iiib. Anaerobic acid fermentation of glucose (CO₂ and H₂ gas produced):



And

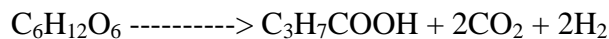

iii & iv. Methane fermentation of glucose (CO₂ and CH₄ produced):

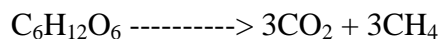

Transport of these gaseous end products is mediated by pressure and concentration gradients that develop within the landfill (advection and diffusion mechanisms, respectively). Gas production is a function of many system variables including refuse composition, precipitation, temperature, moisture content, particle size and compaction, nutrient availability, presence of toxins, and buffering capacity (Cooper *et. al.*, 1992). Reported production quantities range from 0.12 to

0.41 m³/kg dry waste (Pohland and Harper, 1985). Landfill gas is typically 40 to 60 percent methane, with the balance being mostly carbon dioxide. Various trace gases such as hydrogen sulfide, water vapor, ammonia, and non-methane organic compounds (NMOC) are also generally identified in LFG. Usually, gas production begins within a year of waste placement and may continue for as long as 50 years after landfill closure. The environmental fate of an organic compound placed in a municipal solid waste landfill is thus a function of the numerous transport/transformation phenomena that occur within the landfill.

Mechanisms of mobility and transformation include advection, dispersion, sorption, volatilization, biodegradation, and chemical reaction. Advection results in the movement of the compounds with the bulk flow of gases (up and laterally) and/or liquid (down and laterally) through the refuse pore spaces. Dispersion causes spreading of a contaminant pulse resulting in the dampening of concentration but not in mass reduction. Sorption can retard contaminant movement as the compound interacts with the solid refuse phase or soil layers. Biodegradation and chemical transformations can reduce the mass of one particular contaminant, however, a more toxic and/or mobile compound may be produced in addition to innocuous end products. In an active landfill, because of the sequential nature of landfilling, each cell will be in a different stage of decomposition and will be generating gas at a different rate. However, as more waste is added, the total gas production rate increases. In addition, gas generation rates will vary depending on the nature of the waste.

As a result of their low solubilities and high vapor pressure, volatile organic compounds (VOC) present within the landfill readily move between aqueous and vapor phases in the unsaturated waste. VOCs are emitted from landfills either through volatilization of the liquid or sorption of the liquids on soil particles which later become airborne. Entrainment of particles can occur with high winds or with light winds combined with vehicle movement, earth movement, vegetation removal, and solid waste disposal activity (Bennett, 1987). Volatilization occurs as a result of a concentration gradient which causes molecules to diffuse from a bulk liquid phase, across a liquid/gas interface, to the bulk gas phase. The VOC mass flux rate (mass flow rate per unit area) depends on many factors including the amount of VOC present, chemical characteristics (solubility, vapor pressure, diffusivity, tendency to absorb, persistence, and the magnitude of Henry's Law Constant), rate of

LFG, and landfill cover. Soil porosity appears to have greatest impact on the rate at which a chemical can pass through a soil cover (Shen, 1982; Thibodeaux et al., 1982). Soil organic content, water content, and the type of gas collection system also impact chemical movement through a soil cover.

The generation of methane and NMVOCs can be controlled using treated landfill leachate recirculation process. A research study was done at UNO by La Motta et.al. in 2004 using facultative lysimeters found that high concentrations of dissolved constituents in recirculated leachate can inhibit MSW decomposition and stabilization.

3.2 Landfill Gas and Health Effect

LFG emissions potentially impact environmental quality in several ways. NMOC emissions from US MSW landfills are estimated at 255,000 Mg/yr (US EPA 1991) and include several suspected or known carcinogens (for example, benzene and vinyl chloride). Non-carcinogenic health risks have been identified for other NMOCs in LFG. Photocatalyzed reactions between volatile organic compounds emitted from landfills and nitrogen oxides can increase tropospheric ozone levels, resulting in adverse health and vegetation effects. For older landfills, the implementation of measures to prevent release to the environment is less well defined with the result that aquifer contamination was far more common as were elevated localized VOCs (Reinhart, 1989).

Zou et al. (2003) identified up to 60 VOC species in one landfill, 16 compounds of which were US EPA priority pollutants including benzene and derivatives, and chlorinated hydrocarbons and aromatics. Specific compounds occurring at higher levels, although together rarely exceeding 1 % v/v, were naphthalene, chloroform, carbon tetrachloride, trichloro-ethane and chloro-benzene as well as benzene. The comprehensive sampling strategy reported by Parker et al. (2002) identified 557 trace components in landfill gas, 178 of which are inherently toxic. Monitoring and modeling methodology being developed in this study can be applied by future researchers to quantify various hazardous organic compounds to be able to understand the health risks to the exposed public.

3.3 Landfill Gas Management

Odor nuisances are common LFG impacts on local environments, while methane emissions have global impacts. MSW landfills worldwide are thought to contribute between 5 and 15 percent of total methane atmospheric emissions (Thorneloe and Peer, 1991). Methane is 20 to 25 times more effective on a molar basis than carbon dioxide at infrared energy absorption, contributing significantly to the greenhouse effect. In addition, methane indirectly increases levels of water vapor which may enhance warming effects (Cooper *et. al.*, 1992). Methane also represents a fire and explosion hazard due to accumulation in nearby structures. Recognizing the potential health and environmental risks associated with these releases, the US EPA has recently proposed regulations for large landfills (US EPA, 1991). The regulations would affect landfills with design capacity in excess of 100,000 Mg emitting more than 150 Mg/yr of NMOCs; and require the collection and destruction of these emissions. The regulations permit estimation of NMOC emissions using conservative default values or, alternatively, emission rates may be measured using active gas collection devices. These regulations are expected to be finalized in September, 1992. In addition, Subtitle D of the Resource Conservation and Recovery Act (RCRA) requires landfill gas monitoring to detect and control migration of methane. According to New Source Performance Standard (NSPS), 40 CFR 60 Subpart WWW and National Emission Standard for Hazardous Air Pollutants (NESHAP), 40 CFR 63 Subpart AAAA, for MSW landfills with potential of emitting more than 50 Mg/year of non-methane volatile compounds have to collect and combust landfill gas. As specified in 40 CFR 60.755 (c) and (d), and 40 CFR 60, Appendix A, Method 21, semi-yearly surface VOC monitoring is required to ensure that the landfill biogas collection systems are operating properly. Emission of VOCs as methane 500 ppm above background requires remedial action in the gas collection system (Figueroa et al., 2008 and Falgoust, 2009).

Interest in the collection of landfill gases has increased dramatically in recent years both from a regulatory and economic standpoint. The heating value of landfill gas can be as high as 18,600 kJ/m³, approximately one-half that of natural gas. Over 114 landfills across the nation are presently collecting gas for energy recovery purposes (Thorneloe, 1992). Gas can be sold directly to the user, scrubbed to pipeline quality, and/or used to generate power onsite. Collection of gas generally involves the installation of horizontal or vertical wells in the landfill which either vent naturally

(passive gas collection) or are connected to a gas compressor or blower to actively extract the gas (active gas collection). Estimation of landfill gas emission quantities, therefore, has great importance to scientists, regulatory agencies, landfill owners/operators and energy producers. Predicting emissions resulting from the decomposition (under variable environmental conditions) of a material which is difficult to characterize and which may vary widely in composition over time, poses significant technical challenge. Any technique utilized must not interfere with the advective and diffusive processes, must be field verifiable, economical, and must account for temporal and spatial variations. Estimates of offsite migration quantities are particularly difficult. However, depending on site characteristics, it is possible that migration results from long term diffusion and, while it may certainly represent a localized hazard, does not represent a significant emission source. At present, there is no single method for measuring landfill gas emissions which meets all criteria. The project life for economic landfill biogas production is typically 10 years, but residual production can be expected to last for more than 40 years (Hamer, 2003). For economic operation, landfill biogas must, from all but the very largest installations, have a captive market that does not require gas cleaning and purification. Examples of such markets are cement and brick kilns. For very large installations, where diverse uses for the gas produced are envisaged, both calorific value upgrading and purification procedures for moisture, carbon dioxide, hydrogen sulfide and halogenated hydrocarbon removal (Dembach and Henning, 1987) are essential ancillary facilities for the methane to realize its market price.

3.4 Landfill Gas Monitoring

Landfill gas is a mixture of 200 or more gases (Heguy and Bogner, 2004). Many landfill gas control and gas recovery systems have been tested in a variety of studies. Some of them are available commercially. Control measures for VOCs like Methyl Mercaptan, Benzene, Toluene, and Xylene are required to avoid health risks, and to meet permit obligations. Whereas, gas recovery systems are useful for captive power generation or gas supply.

Liquid chromatography and gas chromatography with mass spectroscopy were used in many studies to characterize and quantify reduced sulfur compounds (RSCs) and VOCs in China, Korea, Turkey, USA, and others. In a case study for characterization of VOCs in landfill in south China,

carbon adsorption tubes, called Carbontrap™ have been used for sample collection (Zou et al., 2003). In another case study on monitoring of odorous gases in a landfill in Turkey, mono-aromatics, halogenated, aldehydes, esters, ketones were measured among VOCs (Dincer et al., 2006). However, flux chamber method is most commonly used for collection of VOC samples from landfills (Cooper et al., 1992). Because of their high vapor pressures and low solubilities, many toxic VOCs are observed in landfill gas. In a report by the State of California Air Resources Board (Bennett, 1987), the average surface emission rate of hazardous chemicals was estimated to be 35 kg per million kg of refuse. The US EPA estimates that approximately 200,000 metric tons of NMOCs are released from MSW landfills each year, including both nuisance and hazardous pollutants (Federal Register, 1988). A recent US EPA analysis suggested that the risk of excess cancer incidents from exposure to uncontrolled MSW landfill gas emissions was 100 to 10,000 per million of exposed individuals (Minott, 1989). Numerous investigations have been conducted with the objective of characterizing landfill gas emissions. Significant variation in landfill gas composition has been observed. A representative list of VOCs identified in landfill gases analyzed by Cooper *et. al.*, (1992) and respective concentrations is provided in Table 1.

Monitoring of landfill gases can be categorized into five types viz. soil-gas monitoring, near surface gas monitoring, emissions monitoring, ambient air monitoring, and indoor air monitoring. In near surface gas monitoring, concentration of gases are measured at a point not above 4 inches from ground surface. Typically methane is reported using this protocol. However, monitoring of VOCs in landfill can also use the same (ATSDR, 2008).

Numerous techniques exist for the measurement of methane emissions from landfills. The most popular methane emissions techniques are the chamber techniques, either closed or open. Both chamber techniques have their own advantages and disadvantages. For example, the open or dynamic flux chamber simulates field conditions better than the closed flux chamber; however, the open chamber may create artificially high fluxes due to its sensitivity to pressure changes inside the chamber.

Table 1. NMVOCs detected in a landfill cell (Cooper *et. al.*, 1992)

Compound	Concentration (ppbv)
Acetone	3,541
Benzene	313
2-Butanone (MEK)	2,713
1,1-Dichloroethane	988
Total 1,2-Dichloroethylene	530
Ethylbenzene	461
Methylene Chloride	4,030
Styrene	235
Tetrachloroethene	251
Toluene	11,941
Trichloroethene	186
Trichlorofluoromethane	890
Total Xylene	1036

In contrast, the closed or static flux chamber is much easier to use and cheaper to operate than the open chamber; however, the closed chamber tends to underestimate the gas fluxes because of pressure buildup with time that distorts the gas flow pathways in the soil and decreases the flow into the chamber. Overall problems with a flux chamber include labor intensity, time consumption, point measurements, and highly variable results.

3.5 Landfill Gas Emission Modeling

Methane production rates can be estimated by any of several biogas production models. The Environmental Protection Agency (EPA) Landfill Gas Emissions Model (LandGEM) is an automated estimation tool used to estimate emission rates from municipal solid waste landfills. LandGEM is based on a first-order decomposition rate equation for quantifying emissions from the decomposition of biodegradable waste. LandGEM is used to estimate uncontrolled emission rates for total landfill gas, methane, carbon dioxide, non-methane organic compounds, and individual air pollutants from landfills. The Landfill Gas Emissions Model (LandGEM) is an automated estimation tool with a Microsoft Excel interface that can be used to estimate emission rates for total landfill gas, methane, carbon dioxide, non-methane organic compounds, and individual air pollutants from municipal solid waste landfills.

The model contains two sets of default parameters, Clean Air Act (CAA defaults and inventory defaults). The inventory defaults are based on emission factors in EPA's Compilation of Air Pollutant Emission Factors (AP-42) and can be used to generate emission estimates for use in emission inventories and air permits in the absence of site-specific test data (EPA, 2005). This is the most widely used landfill gas emission model in USA and other parts of the world.

Another biogas production model is MICROGEN-MGM. By simulating the basic biological and physicochemical processes that take place inside a landfill, MICROGEN can estimate the methane production rate for a landfill. MICROGEN utilizes Monod microbial growth based equations to describe the dynamics of the landfill ecosystem. LandGEM and MICROGEN, as well as other biogas production models, involve many assumptions and mathematical limitations. A few problems with biogas production models are that they are only theoretical, a good record of waste deposits is needed, and the models can not estimate the percentage of landfill gas captured versus that emitted (Figueroa *et. al.*, 2008).

The measurement of pollutant mass emissions from an entire area source can be calculated using a ground-based optical remote sensing (ORS) method. The ORS method uses open-path Fourier transform infrared (OP-FTIR) spectroscopy to obtain path-integrated pollution concentration information along multiple plane-configured optical paths. The source emissions can be determined after processing the pollutant concentration information and wind vector information with a plane-integrating computer algorithm. Problems with optical remote sensing methods are that they are expensive, time and labor intensive, depend on wind orientation, and produce only one integrated emission rate for the whole landfill (Figueroa *et. al.*, 2008).

Biogas from landfills mainly contains methane and carbon dioxide. Generally, methane constitutes more than 50% of landfill gas. So, calorific value of landfill gas could be more than 18000kJ/Nm³ (Desideri *et. al.*, 2003). According to statistics available in 2001, about 2.6 million tones of methane are captured annually in U.S. 70% of which is used to generate heat or electricity (Themelis and Ulloa, 2007). There are more than 350 commercial landfill gas recovery operations in U.S. (Heguy and Bogner, 2004). Biogas from landfills can also be used for fuelling urban transport buses (Kuwahara *et. al.*, 1999). Methane and other VOCs in landfill are generated due to anaerobic

biodegradation of the organic component of the waste. In practical, fermentation process in landfill is erratic and spatially heterogeneous. This process depends on favorable condition based on pressure, concentration, moisture content and temperature gradients. However, in order to implement control measures, a good knowledge about methane generation across the landfill is required. There are numerous attempts have been made to model the kinetics of methane generation. A mathematical model was developed by researchers in Stanford University. The model was calibrated and validated using the data obtained from field work in Mountain View Landfill Project, California. This was a combined CH₄ and CO₂ generation and transport model based on first principles. This model computes pressure profiles and gas compositions over time and space. The study concluded that, biokinetic constants do not have any significant effect on methane generation rate, hydrolysis rate constants and initial concentrations of acetic acid and aqueous carbon are the most sensitive parameters, and this model is useful for prediction of total methane production (El-Fadel *et. al.*, 1989).

The generation and transport of methane in landfill can also be modeled by TOUGH2-LGM as proposed by Nastev *et. al.* in 2001. TOUGH2-LGM is Transport of Unsaturated Groundwater and Heat-Landfill Gas Migration model. This stimulates migration of five components in partially saturated media. There are four fluid components *viz.* water, atmospheric air, methane and carbon dioxide and one energy component *i.e.* heat. For improved methane generation and control in tropical climate a new system, called Purpose Built Landfill (PBLF), was proposed by Yedla and Parikh in 2001. This system is based on multivariate functional models developed for control of methane and energy generating potential. The case study carried out in Mumbai, India found that the unit disposal cost of this system is almost 1/7 of same for the conventional waste management system in the city. This system can reduce emission of methane in the order of 70,000 tones/ annum and produce energy of value up to \$5.2 million/yr.

3.6. MATLAB

MATLAB is a high-level technical computing language and interactive environment for algorithm development, data visualization, data analysis, and numeric computation. Using the MATLAB product, one can solve technical computing problems faster than with traditional programming languages, such as C, C++, and FORTRAN.

MATLAB provides some key features those include high-level language for technical computing; development environment for managing code, files, and data; interactive tools for iterative exploration, design, and problem solving.; mathematical functions for linear algebra, statistics, Fourier analysis, filtering, optimization, and numerical integration; 2-D and 3-D graphics functions for visualizing data *etc.* (www.mathworks.com).

4. Experimental Setup

In this research study, near surface concentration of VOCs at site were collected following ATSDR's guideline on "Landfill Gas Monitoring" and using Thermo® 580B OVM Portable VOC analyzer and GARMIN GPSMAP® 60x handheld GPS receiver at predefined receptor locations. The receptor locations were predefined using Google Earth® software. Portable weather monitoring kit DAVIS® Weather Wizard III was for wind speed and wind direction records and cloud cover readings were collected from www.wunderground.com website.

PID sensor in Thermo VOC meter detects all volatile organic compounds in landfill gas except methane (Thermo, 2003). Again, Non-methane VOCs comprise approximately 10% of the total VOCs (EPA, 2008). So, near surface ambient concentrations measured were of non-methane VOCs (NMVOCs) which were expressed in ppm "equivalent of isobutylene." These NMVOCs concentrations were then converted from "ppm equivalent of isobutylene" to "gm/m³ equivalent of methane" using RAE Technical Note (2006) and ppm to gm/m³ conversion formula (Cooper and Alley, 2002). Using the near surface concentration of NMVOCs and the prevailing meteorological conditions, emission rates of NMVOCs in "gm/sec equivalent methane" were computed using the methodology developed in this research.

4.1 Details of the Site

The River Birch Sub-title D landfill owned by River Birch Landfill LLC, located at 2000 S Kenner Avenue, Westwego, Louisiana 70094, USA was used as the site for this research study. This MSW landfill, opened in 1999, is designed to receive 75,00,000 tones of non-hazardous solid waste over 50 years. The site map and historical data on waste deposition is presented in Figure 1 and Table 2.

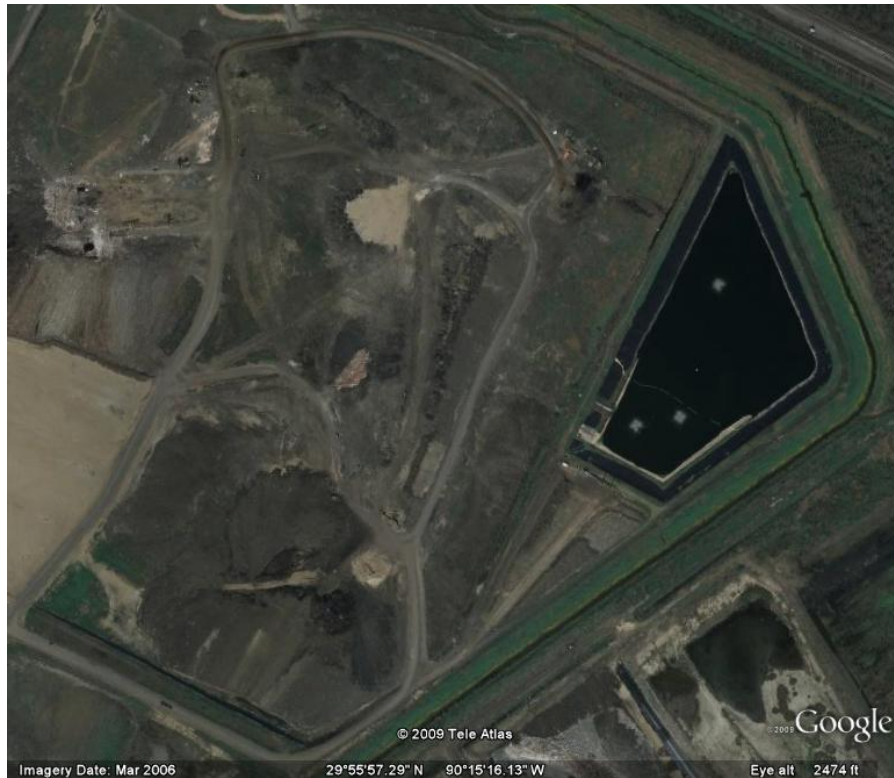

Figure 1. Site map for River Birch Sub-title D Landfill (Google Earth, 2009)

Table 2. Historical Data of Waste Deposition (Source: River Birch, 2009)

Reporting Years	Total Tons	% Increase/Decrease From Previous Year
1999-2000	578,965	---
2000-2001	891,440	54.0
2001-2002	901,378	1.1
2002-2003	923,746	2.5
2003-2004	944,684	2.3
2004-2005	1,078,298	14.1
2005-2006	1,136,825	5.4
2006-2007	1,466,246	29.0
2007-2008	1,454,424	-0.8
2008-2009	1,344,205	-7.6
Total	10,720,211	

The area used for near surface monitoring has an area of approximately 137 acres. The geographic coordinates ranges from Latitude 29°56'17.45"N in north to Latitude 29°55'46.24"N in south, and from Longitude 90°15'6.56"W to Longitude 90°15'43.00"W in the west. The average altitude of the location is 5 feet above mean sea level.

4.2 Inverse Gaussian Dispersion

The new mathematical model for landfill gas quantification followed in this research study is fundamentally similar to method developed by the University of Central Florida using an inverse dispersion calculation algorithm. Gaussian dispersion model based on assumption that pollutants emit from a single source point disperse vertically and horizontally along predominant wind direction following normal distribution. This is widely used as a basis of air dispersion models like AERMOD of USEPA, AUSPLUME of Australian EPA. The basic equation of Gaussian dispersion model and a graphical presentation of dispersion for a point source are given below.

$$C = \frac{Q}{2\pi u \sigma_y \sigma_z} \left(-\frac{y^2}{2\sigma_y^2} \right) \left\{ \exp \left(-\frac{(z-He)^2}{2\sigma_z^2} \right) + \exp \left(-\frac{(z+He)^2}{2\sigma_z^2} \right) \right\} \dots\dots\dots(1)$$

Where,

C= steady-state concentration at a receptor point (located at x, y, z), $\mu\text{g}/\text{m}^3$

Q= emission rate, $\mu\text{g}/\text{s}$

σ_y, σ_z = horizontal and vertical dispersion coefficients (in m) which are function of distance x and atmospheric stability

u= average wind speed at the physical stack height, m/s

y= horizontal distance from plume centerline, m

z= vertical distance from ground level, m

He= effective stack height [physical stack height (Hs) + plume rise (Δh)], m

Hs= actual height of the stack itself (physical stack height), m

Δh = rise of the plume above tip of the stack, m

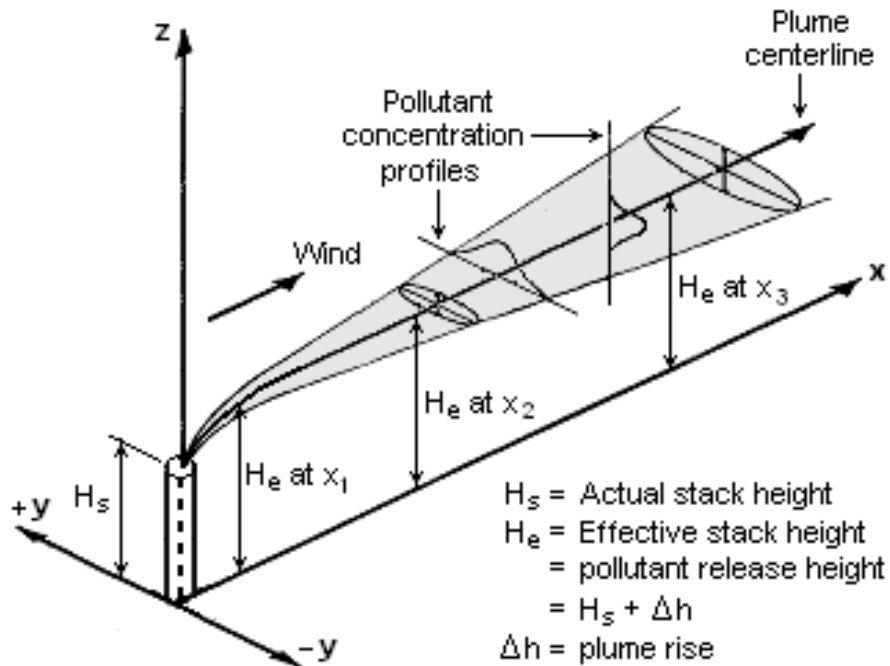

Figure 2. Gaussian Dispersion Model (www.ourairspace.org)

Since the sources (the crack and opening) in a landfill are very close to the ground level, 'He' is assumed as zero and as measurement of ambient concentration of VOCs are taken near to the landfill surface, 'z' is also zero; so the Equation (1) is converted into Equation (2).

Now in this research study, the modeling method involves measuring near-surface concentrations of gases at a number of predefined points, over the landfill, called as receptors [say "n" receptors] using a handheld gas monitor followed by longitude/latitude measurements by a portable GPS receiver. This data in combination with selective number of sources [say "(n-1)" sources] and site-specific meteorological data are used to calculate emissions at each of the identified source by using Gaussian dispersion equation (equations 2 through 5). Because of the large number of calculations ["n" number of receptors and "(n-1)" number of sources], use of MATLAB is essential for computing the emissions in a reasonable time. Sum of emissions from all sources gives the total emissions from the landfill (Figueroa et al., 2008).

$$C = \frac{Q}{\pi u \sigma_y \sigma_z} e^{-\left[\frac{1}{2\sigma_y^2}\right]} \dots\dots\dots (2)$$

$$C_{i,j} = f(x,y)_{i,j} \times Q_j \dots\dots\dots (3)$$

$C_{i,j}$ represents the modeled concentration at receptor i due to source j in ($\mu\text{g}/\text{m}^3$)

Q_j is the source j emission rate in ($\mu\text{g}/\text{sec}$)

$f(x,y)_{i,j}$ is the rest of equation (1) = F

$$\sigma_y = ax^b \dots\dots\dots (4)$$

$$\sigma_z = cx^d + f \dots\dots\dots (5)$$

The parameters a , b , c , d , and f are numerical curve-fit constants that are functions of downwind distance, x (in km), and atmospheric stability. Assuming the methane background concentration is zero, the total modeled concentration ($\mu\text{g}/\text{m}^3$), $C_{i,modeled}$, at each receptor is the sum of all the modeled concentrations at receptor i from each of the n sources as shown in equation (6).

$$C_{i,modeled} = \sum_{j=1}^n C_{i,j} \dots\dots\dots (6)$$

So, to estimate the best-fit methane emission rate, Q_j within a landfill involves assuming different trial sets of Q_j values, and then calculating the sum of squares of the residuals over all m receptors using equation (7). Trial and error is required to find the optimal set of Q_j to minimize R^2 .

A more efficient method for determining the optimal set involves writing equation (7) using equivalent matrix notation. Equation (8), represented in matrix notation, shows how to minimize the 2-norm of the residual; where $F \in \mathfrak{R}^{m \times n}$ is the (real) m by n matrix of values of the function $f(x,y)_{i,j}$, $Q \in \mathfrak{R}^n$ is the (real) n vector of sources and $C_{measured} \in \mathfrak{R}^m$ is the (real) m vector of measured receptor concentrations (where ‘ \in ’ signifies the element on left belongs to data set on right, \mathfrak{R} is the matrix of residuals).

$$\text{Minimize: } R^2 = \sum_{i=1}^m (C_{i,measured} - C_{i,modeled})^2 \dots\dots\dots (7)$$

$$\frac{Min}{Q} \|F \cdot Q - C_{measured}\|_2^2 \dots\dots\dots (8)$$

Equation (8) can be solved using linear least-squares regression theory when subject to the following constraints: 1) The number of sources must be less than or equal to the number of receptors, 2) Each Q_j must be greater than or equal to zero, and 3) If any downwind distance is negative F must be set to zero because the receptor is upwind from the source. The vector Q that minimizes equation (8) is unique if and only if F has full rank. If F has full rank, Q can be determined using the normal equations as equation (9), where the pseudoinverse F^+ is shown in equation (10).

$$Q = F^+ C_{measured} \dots \dots \dots (9)$$

$$F^+ = (F^T F)^{-1} F^T \dots \dots \dots (10)$$

However, this formulation does not guarantee that each Q_j is not negative. Therefore, a more general approach, equation (10), is necessary that requires the solution of the non-negative constrained least squares problem; where ‘I’ is the identity matrix. The non-negative least squares (NNLS) problem can be solved numerically using a variety of available transformation, active-set, or iterative algorithms. While developing the code for this algorithm in MATLAB, the equation (11) has been used to get non-negative values of emission rate (q) at different sources.

$$Q = \|F \cdot Q - C_{measured} \mid I \cdot q \geq 0\|_2 \dots \dots (11)$$

4.3 Steps

The steps followed in this monitoring and modeling plan are given below:

- i. Defining receptor points or grid formation using landfill map on Google map platform
- ii. Loading geographical coordinates of the receptor location in GPS receiver
- iii. Locating receptors with GPS receiver for in-situ measurement of near-surface gas concentration using VOC analyzer
- iv. Recording in-situ meteorological data using portable weather station
- v. Collecting data on cloud cover and altitude from reference websites

- vi. Developing a mathematical code based on inverse Gaussian dispersion algorithm using MATLAB
- vii. Converting geographic coordinates (latitude, longitude, and altitude) into Earth-centered Earth-fixed coordinates
- viii. Converting concentration readings obtained by VOC meter with PID sensor, which gives NMVOC results in “ppm isobutylene equivalent,” to NMVOC concentration in “ppm methane equivalent”
- ix. Converting NMVOC concentrations from “ppm” to “gm/m³” methane equivalent.
- x. Running MATLAB model using field data to calculate emission rates at various sources, defined based on receptor locations

4.4 Instruments Used

In this research study, VOC analyzer, GPS receiver, and Portable Weather Station were used to measure NMVOC concentration, find location in the field and record meteorological data respectively.

4.4.1 VOC Analyzer

The 580B is a portable Organic Vapor Meter (OVM) (Figure 3), which detects and quantifies most organic vapors with a highly sensitive photo-ionization detector (PID). The 580B has an operating range of 0-2000 parts per million (ppm) with a minimum detectable of 0.1 ppm. No support gases are required. The 580B is controlled by a microprocessor and completely portable, the 580B operates from internal batteries for eight hours in the field. It has LED display which shows the concentration of the incoming sample in the bottom line.



Figure 3. Thermo® 580B OVM

The detector is constructed of Teflon and stainless steel to eliminate chemical interaction with the surfaces that are encountered by the sample. To further reduce possible interaction with the surfaces, the flow rate thru the detector is high, 400 – 500 cc/min developing a very dynamic transport of the sample. As shown in Figure 4, the sample is drawn into the ionization chamber through the jet electrode where the UV radiation from the lamp ionizes the sample. A bias voltage of several hundred volts is applied to the jet to aid in the collection of ions. As a result of the ionization process and the impingement of the UV energy from the lamp on the sample, positively charged ions and free electrons are produced. The jet is negative relative to the collector where the electrons are collected (Thermo, 2003).

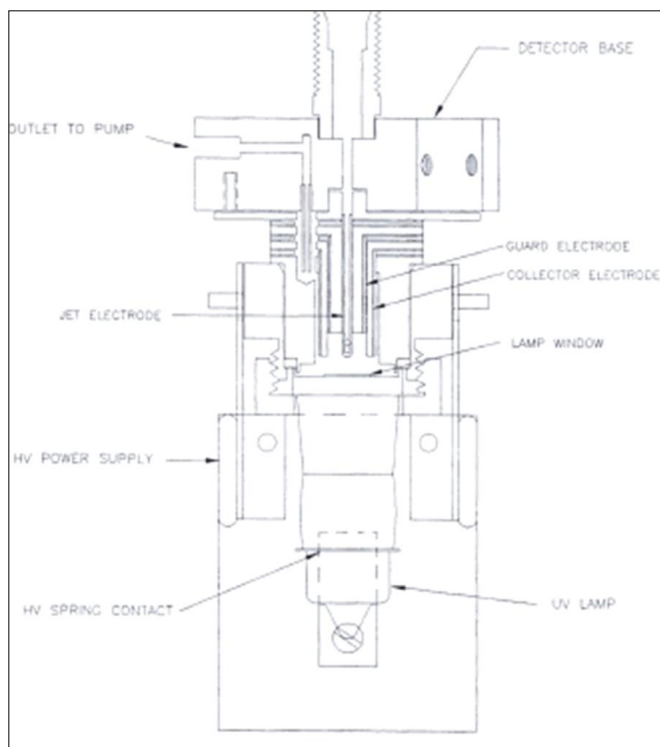

Figure 4. The PID Detector Assembly in Thermo® 580B OVM

Between the jet and the collector, separated on both sides by Teflon, is the guard electrode. Its function is to eliminate surface currents which could flow between the two active electrodes. When the Teflon surfaces become dirty during use, there can be the development of a conduction path on the Teflon, which increases in high humidity situations. The guard electrode eliminates this path. The collector electrode is connected to the electrometer which measures the ion current produced during the ionization process. The sample is moved through the detector by an external pump which is on the exit of the detector. This detector can analyze all most all volatile organic compounds except methane in the landfill. So, the concentration displayed by the analyzer is the total concentration of all non-methane organic compounds (NMOC) being emitted in a landfill (Thermo, 2003).

The two types of lamps used are the 10.0 eV and the 11.8 eV lamp. Whenever a new lamp is used the 580B must be calibrated. This is true even if the new lamp is the same type, e.g., the new and old lamps, both, are 10.0 eV. This is due to the fact that each lamp will have a slightly different sensitivity. It is important to note that the 11.8 eV lamp will in general be less sensitive than the 10.0

eV lamp. This is true despite the higher energy level of the 11.8 eV lamp. The 11.8 eV lamp will however "see" certain gases which the 10.0 eV lamp will not. The 580B is quite simple to calibrate. Sources of "zero air" and "span gas" are all that needed to calibrate the 580B. The zero air is introduced to the 580B in order to determine the "background" signal. The concentration of the span gas is then selected. The span gas is finally introduced to the 580B. The instrument makes all of the necessary calculations (including linearization) to arrive at a "calibration constant. When in the Run mode the signal is multiplied by the calibration constant in order to arrive at the current PPM.

$$\text{Calibration constant} = \frac{\text{Span ppm}}{\text{Span Signal} - \text{Zero Signal}} \dots\dots(12)$$

$$\text{ppm} = (\text{Span Signal} - \text{Zero Signal}) * \text{Calibration Constant} \dots(13)$$

The ppm is then multiplied by the Response Factor to get the final value of ambient concentration. A Zero air calibration gas cylinder was used for zeroing the instrument and an Isobutylene gas cylinder was used for spanning the same. The Response Factor of Isobutylene is 1 (one) (Thermo, 2003).

4.4.2 GPS Receiver

In this research study, handheld GPS receiver GARMIN® GPSMAP 60cx (Figure 5) was used for detection of latitude and longitude of receptor points predefined using Google Earth.



Figure 5. GARMIN GPSMAP 60cx (GARMIN, 2006)

It has accuracy of ± 2 degree with proper calibration. The feature ‘Waypoints’ (Figure 6) was used to store latitude and longitude of the receptor points as waypoints and detect the locations on the landfill by proximity search from any location for a particular point. The instrument can store up to 1000 points (GARMIN, 2006).



Figure 6. Waypoints on GARMIN GPSMAP 60cx (GARMIN, 2006)

4.4.3. Portable Weather Station

A portable weather station DAVIS® Weather Wizard III (Figure 7) was used for recording onsite wind speed and wind direction. It has a wind vane with an anemometer attached in the same mounting rod. It also has a probe for recording ambient temperature. The Weather Station console, included in the package, displays the real time wind speed, wind direction and temperature. Wind speed was recorded in m/s and wind direction in wind angle (degree) (DAVIS, 2009).



Figure 7. DAVIS® Weather Wizard III (DAVIS, 2009)

4.5 Grid Formation

In this research project, a grid of 60 equidistant receptor points (Figure 8) are created over the landfill, using ‘placemark’ Google Earth platform and then latitude and longitude of each point are recorded in the handheld GPS receiver. The length, width, and diagonal of the grid were 2400, 2500, and 3250 feet respectively. The total area covered under the grid was 137.6 acre. The average distance between two receptor locations is 300 feet.

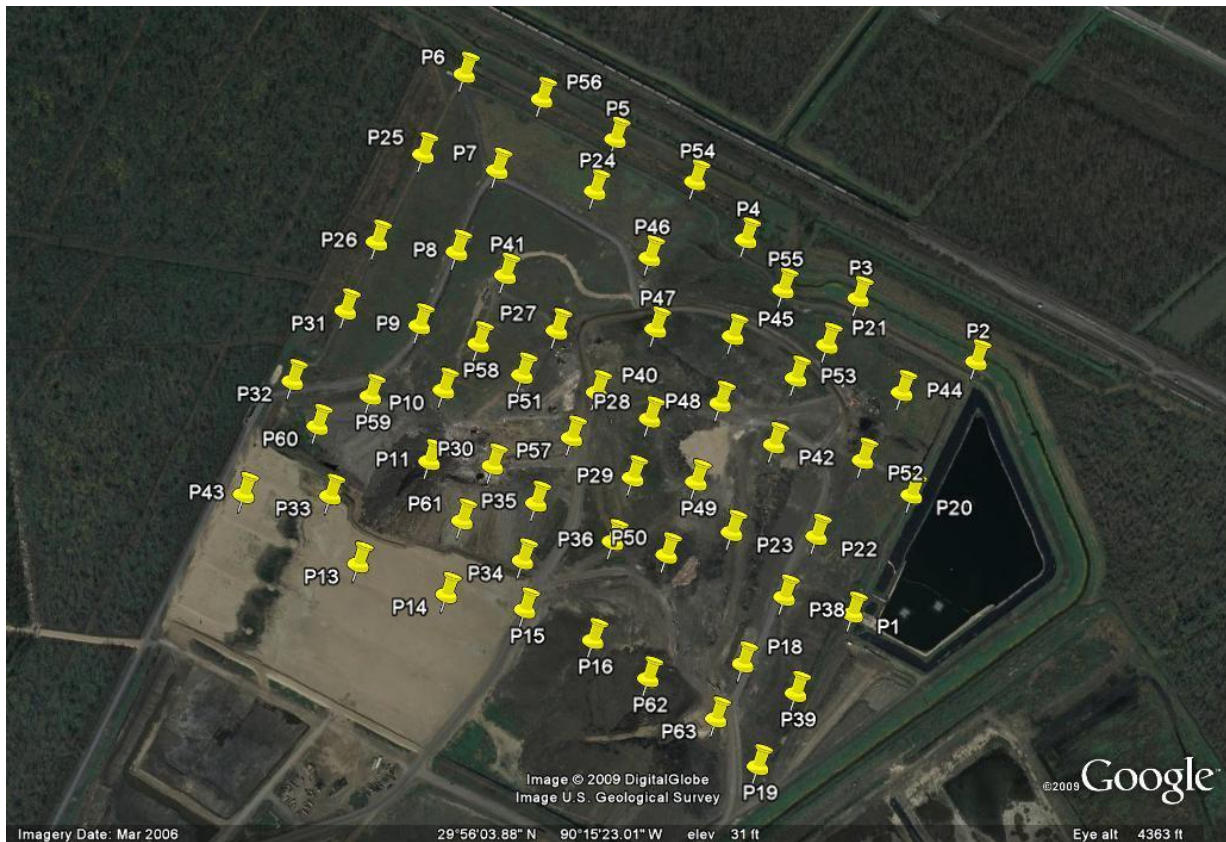

Figure 8. Demarcation of Grid with equidistant receptor locations using Placemark on Google Earth

4.6 Conversion of Geographic Coordinates

Since the coordinates of sources and receptors used in the mathematical model to estimate emission rates are Cartesian coordinates, there was a need to convert the geographic coordinates (latitude, longitude, altitude) into Earth-centered Earth-fixed (ECEF) coordinates which are compatible to other MATLAB functions.

ECEF uses three-dimensional XYZ coordinates (in meters) to describe the location of a GPS user or satellite. The term "Earth-Centered" comes from the fact that the origin of the axis (0,0,0) is located at the mass center of gravity (determined through years of tracking satellite trajectories). The term "Earth-Fixed" implies that the axes are fixed with respect to the earth (that is, they rotate with the earth). The Z-axis pierces the North Pole, and the XY-axis defines the equatorial plane (Figure 9) (μ -blox ag, 1999).

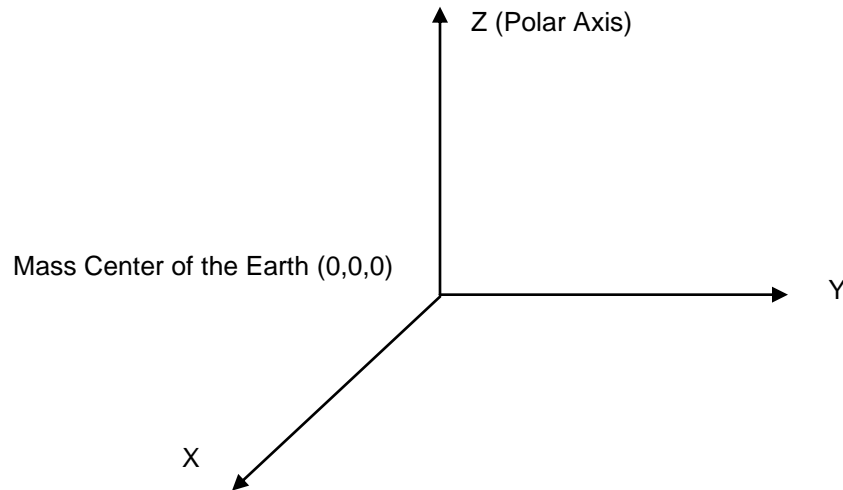

Figure 9: ECEF Coordinate Reference Frame (Source: μ -blox ag, 1999)

ECEF coordinates are expressed in a reference system that is related to mapping representations. Because the earth has a complex shape, a simple, yet accurate, method to approximate the earth's shape is required. The use of a reference ellipsoid allows for the conversion of the ECEF coordinates to the more commonly used geodetic-mapping coordinates of Latitude, Longitude, and Altitude (LLA). Geodetic coordinates can then be converted to a second map reference known as Mercator Projections, where smaller regions are projected onto a flat mapping surface, like Universal Transverse Mercator – UTM or the USGS Grid system (μ -blox ag, 1999). The most commonly used grid system is World Geodetic System, 1984 (WGS84). In this system the surface of the Earth is assumed as an ellipsoid. The reference ellipsoid can be described by a series of parameters that define its shape and which include a semi-major axis (a), a semi-minor axis (b) and its first eccentricity (e) and its second eccentricity (e') as shown in Figure 10. Depending on the formulation used, ellipsoid flattening (f) may be required.

WGS84 Parameters:

$$a = 6378137$$

$$b = a (1-f) \\ = 6356752.31424518$$

$$f = \frac{1}{298.257223563}$$

$$e = \sqrt{\frac{a^2 - b^2}{a^2}}$$

$$e' = \sqrt{\frac{a^2 - b^2}{b^2}}$$

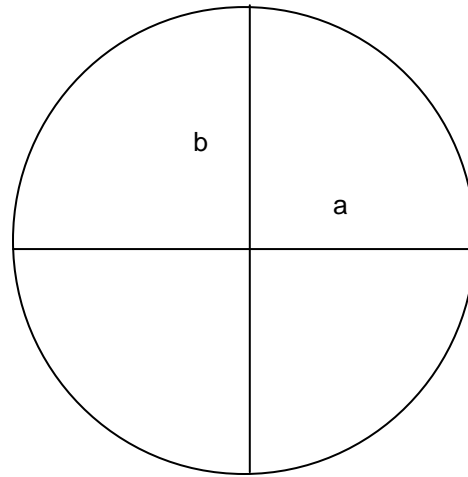

Figure 10: Ellipsoid Parameters (Source: μ -blox ag, 1999)

For global applications, the geodetic reference (datum) used for GPS is the World Geodetic System 1984 (WGS84). This ellipsoid has its origin coincident with the ECEF origin. The X-axis pierces the Greenwich meridian (where longitude = 0 degrees) and the XY plane make up the equatorial plane (latitude = 0 degrees). Altitude is described as the perpendicular distance above the ellipsoid surface.

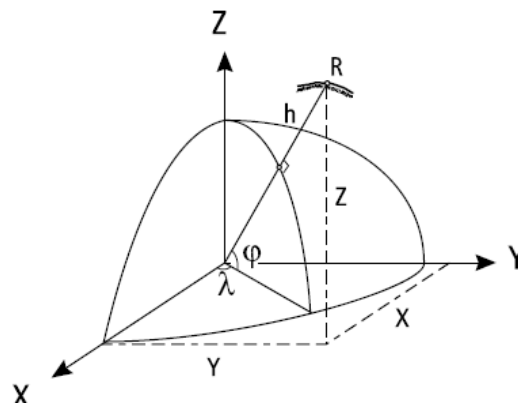

Figure 11: ECEF and Reference Ellipsoid (Source: μ -blox ag, 1999)

The conversion between the two reference coordinate systems can be performed using closed formulas. The conversion from LLA to ECEF (in meters) is shown below.

$$X = (N+h) \cos\varphi \cos\lambda \dots (14)$$

$$Y = (N+h) \cos\varphi \sin\lambda \dots (15)$$

$$Z = \left(\frac{b^2}{a^2} N+h \right) \sin\varphi \dots (16)$$

Where, φ = Latitude

λ = Longitude

h= Height above ellipsoid (meters)

N = radius of curvature (meters)

$$= \frac{a}{\sqrt{1-e^2 \sin^2 \varphi}}$$

4.7 Conversion of PID Readings to FID Readings

The Photo Ionization Detector in Thermo 580B OVM detects all volatile organic compounds, except methane in landfill gas (Thermo, 2003). And the instrument is generally calibrated with Isobutylene. So, the concentration of VOCs recorded represents Non-methane VOCs in equivalence of Isobutylene. But Non-methane VOCs generally comprise 10% of landfill gas; rest is methane (EPA, 2008). Therefore to make the readings taken in this study comparable to LandGEM results other studies like the study by Figueroa *et. al.*, all NMVOCs concentrations measured were converted to “as methane” values. For the same, a combined correction factor (CF) was calculated using individual correction factors (CF) and possible composition of VOCs reported in Table 1 in Literature Review chapter. The calculation procedure of estimating contribution ratio (CR) of each non-methane compound in a mixture of landfill gases, and combined correction factor (CF) are represented in Table 3. Then equivalent FID (as methane) reading= PID (as isobutylene) reading x combined correction factor (RAE, 2006).

Table 3. Calculation of combined correction factor for the possible mixture of VOCs (Source: RAE, 2006, Cooper *et. al.*, 1992)

Compounds comprises in landfill VOC	Ambient Concentration	Compounds detected by PID sensor	Ambient Concentration	Contribution ratio (CR)	Correction Factor (CF)	CR x CF
	ppbv		Ppbv			
Acetone	3,541	Acetone	3,541	0.20	1.1	0.22
Benzene	313	Benzene	313	0.02	0.53	0.01
2-Butanone (MEK)	2,713	2-Butanone (MEK)		0.00		0.00
1,1-Dichloroethane	988	1,1-Dichloroethane		0.00		0.00
Total 1,2-Dichloroethylene	530	Total 1,2-Dichloroethylene		0.00		0.00
Ethylbenzene	461	Ethyl benzene	461	0.03	0.52	0.01
Methylene Chloride	4,030	Methylene Chloride		0.00		0.00
Styrene	235	Styrene	235	0.01	0.4	0.01
Tetrachloroethene	251	Tetrachloroethene		0.00		0.00
Toluene	11,941	Toluene	11,941	0.68	0.5	0.34
Trichloroethene	186	Trichloroethene		0.00		0.00
Trichlorofluoromethane	890	Trichlorofluoromethane		0.00		0.00
Total Xylenes	1036	Total Xylenes	1036	0.06	0.5	0.03
Total			17,527			0.62
Combined CF =	(1/Σ(CR x CF))=	1.61				

4.8 Conversion from ppm to gm/m³

In MATLAB, the VOC concentration readings taken in ppm are converted to gm/m³ units to calculate emission rate values in gm/s unit. This conversion is done using Ideal Gas law, and the molecular weight of the compound in equivalence in the following equation (Cooper and Alley, 2002).

$$C_{\text{mass}} = \frac{10^{-3} C_{\text{ppm}} MW_p}{24.45} \dots (15)$$

Where,

C_{mass} = concentration in gm/m³

C_{ppm} = concentration in ppm

MW_p = molecular weight in gm/mol

(Note: 1 gram mole of any gaseous compound takes a volume of 24.45 liters at 25°C and 1 atm. pressure (STD))

5. Results and Discussion

Near surface concentrations of NMVOCs were measured using Thermo 580B OVM at 60 locations each for May 15th and May 22nd, 2009. Triplicates of each concentration were recorded and the average values were used for MATLAB analysis. Table 4 represents the meteorological conditions that were recorded for those two days. Wind speed were calculated three times during the monitoring work in each day, and average values are taken as model input. The directions of wind were recorded and wind direction of maximum wind speed were taken as the direction (predominant wind direction) for the average wind speed. Cloud cover data were collected from www.wunderground.com and average reading for the monitoring period on each day were considered for calculation of atmospheric stability conditions for each day using the classification presented by Cooper and Alley (2002). The horizontal and vertical dispersion coefficients (σ_y , σ_z) used in Gaussian dispersion algorithm (Equation 1) are derived based on of the atmospheric stability and distance between source-receptor by using Martin's equations (Equation 4 and 5). This derivation was done by using curve-fit constants table used by Cooper and Alley (2002) directly in the MATLAB code.

Table 4. Meteorological conditions during field data collection

Day	May 15	May 22
Average Wind Speed (m/s)	3.60	3.60
Predominant Wind Direction (°)	West (270°)	SE (135°)
Cloud Cover (%)	50	90
Stability Class	B	C

The MATLAB code developed for this research study converts geographical coordinates (latitude, longitude, altitude) to ECEF coordinates, and creates (n-1) sources inside the grid based on receptor locations (Figure 12). Sources are created at fixed distance (100 m) in the upwind direction of the receptor points. The emission rates of NMVOCs were calculated after converting ppm readings to gm/m^3 in methane equivalency (FID). The emission rates at different source points are plotted in Figure 13. The 3-dimensional plot of emission rates at various sources over the landfill (Figure 14) depicts that most of sources with high concentrations located towards interior of the landfill, not on the periphery.

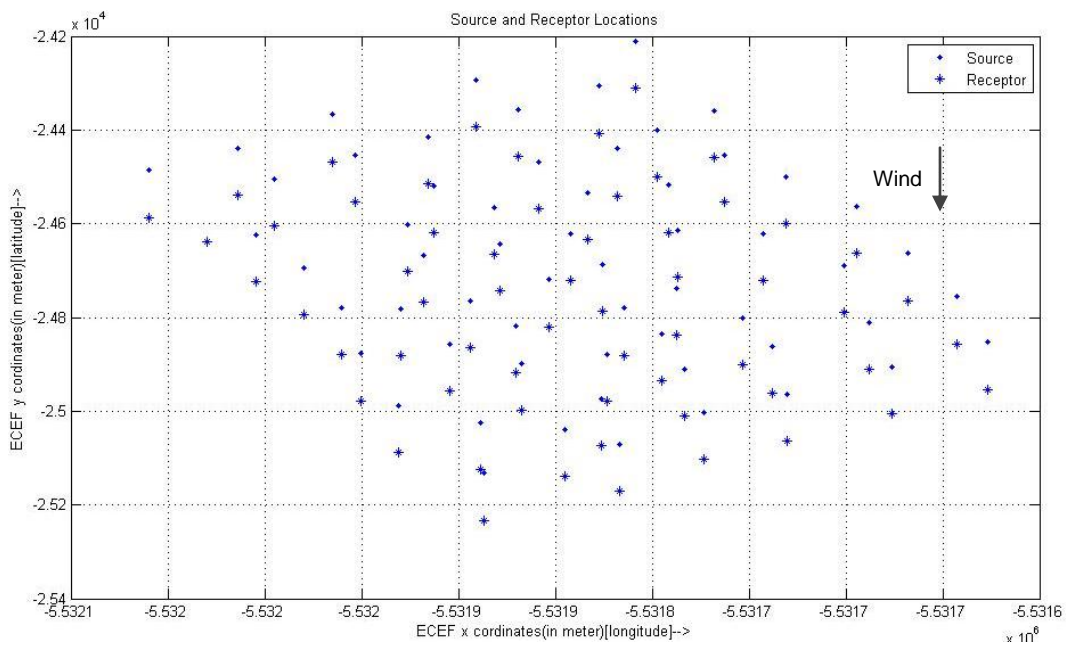

Figure 12. Source and Receptor Locations in Earth-centered Earth-fixed Coordinates (May 15th, 60 receptors)

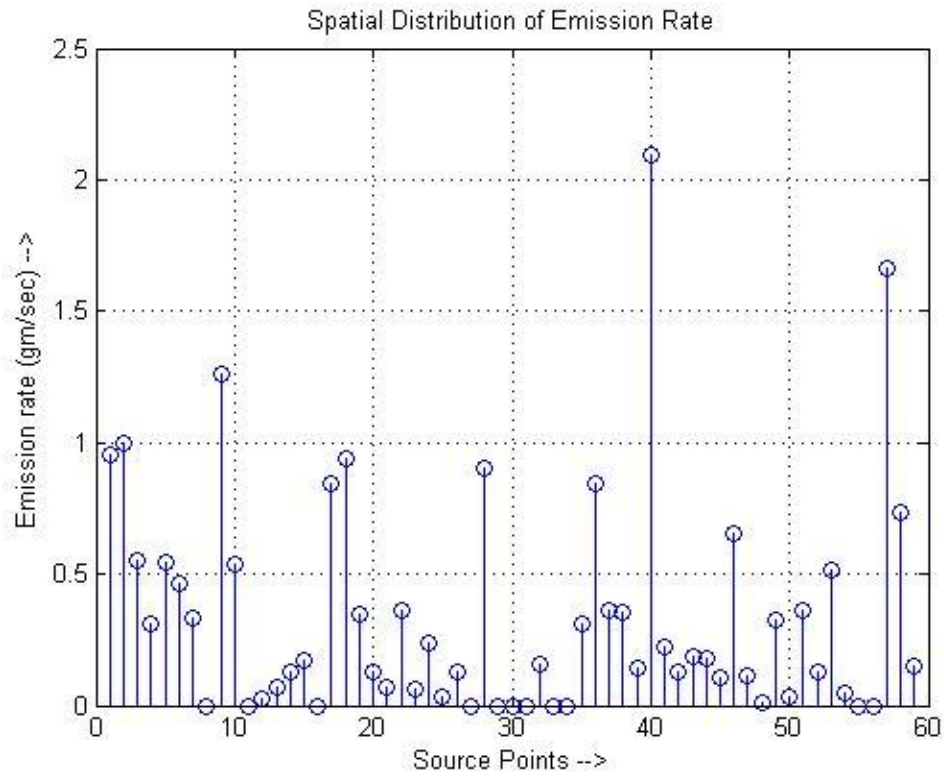

Figure13. Emission Rates of NMVOCs at Different Source Locations (May 15th, 48 sources)

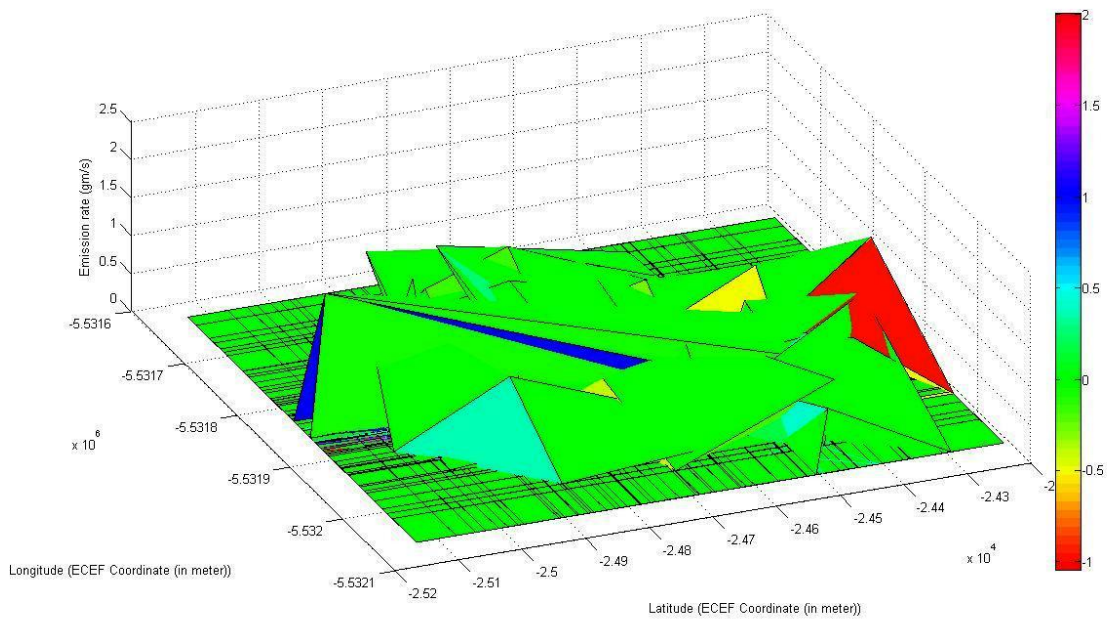

Figure14. 3D Plot of Emission Rates of NMVOCs at Different Source Locations

5.1 Sensitivity Analysis

A sensitivity analysis was carried out by creating 4 different grids of receptors within the same area by removing some of the receptor points. This operation was repeated for both May 15th and May 22nd readings. The results of this analysis are given below in Table 5.

Table 5. Comparison of emission rates for cases within the same grid on May 15th and May 22nd

5/15/2009	Case 1	Case 2	Case 3	Case 4	Case 5	Ave	SD
Number of Receptors	60	50	40	30	20		
Number of Original Sources	59	49	39	29	19		
Number of Sources after processing	48	42	36	27	18		
NMVOOC emission rate (gm/s)	20.22	18.6	16.97	17.13	14.1	17.40	2.27
Percentage variation from Case 1	0%	8.01%	16.07%	15.28%	30.27%		
5/22/2009	Case 1	Case 2	Case 3	Case 4	Case 5	Ave	SD
Number of Receptors	60	50	40	30	20		
Number of Original Sources	59	49	39	29	19		
Number of Sources after processing	46	36	30	27	19		
NMVOOC emission rate (gm/s)	15.82	15.05	9.15	15.14	11.45	13.32	2.89
Percentage variation from Case 1	0%	4.87%	42.16%	4.30%	27.62%		

The emission rates presented in Table 5 demonstrate that the result improve when changed from coarse receptor grid of 20 receptors to fine receptor grid of 50 receptors. The percentage variation among emission rates on May 15th or May 22nd may be attributed to meteorological conditions (Stability class of “B” on May 15th and “C” on May 22nd) as well as possible measurement/modeling errors between the two study days.

5.2 LandGEM Analysis

EPA's landfill emission model LandGEM was run using the historical waste deposition data for River Birch Sub-title D landfill (Table 2), and default values of methane generation rate, k (year^{-1}) and potential methane generation capacity, L_0 (m^3/ton). LandGEM was run with set of values for most wet condition and most arid condition of methane generation rate and potential methane generation capacity to get the highest and lowest total yearly emission rates for NMVOCs in the landfill for the year 2009. The major inputs and results are given below in Table 6.

Table 6. The major inputs and results of LandGEM model

Input / Result	Wet, Highest	Arid, Lowest
Methane generation rate constant, k (year^{-1})	0.7	0.02
Potential Methane Generation Capacity, L_0 (m^3/ton)	170	96
Yearly Total NMVOC emission rate (ton)	2327	74.8

The total emission of NMVOCs obtained from MATLAB code and LandGEM model for River Birch Sub-title D Landfill, LA and the same reported by Figueroa *et. al.* for Seminole County Landfill, FL are compared in Table 7.

Table 7. Comparison of results on total NMVOC emission in different studies

	Figueroa et.al.	LandGEM (Arid, lowest)	LandGEM (Wet, highest)	MATLAB Results; (This Study)
Landfill ----->	Seminole County, FL	River Birch, LA	River Birch, LA	River Birch, LA
Total NMVOC emission rate (gm/s)	20.0	-	-	15.1
Total NMVOC emission rate (ton/year)	630.7	74.8	2327.0	477.1
Area of the landfill (acre)	232	137.6	137.6	137.6
NMVOC emission rate (ton/year/acre)	2.7	0.5	16.9	3.5

(Note: value of total NMVOC emissions from methane reading in Figueroa *et. al.* study is calculated using a conversion factor of 0.02 obtained from USEPA, 2008)

The total NMVOC emission rate calculated in this research study using MATLAB code is within the ranges suggested by LandGEM and the value is 24.5% lesser than that reported in Figueroa *et. al.* However, NMVOC emission per unit area is 29.6% more as estimated by MATLAB code for River Birch Landfill compared to values reported by Figueroa et.al. for Seminole Couty Landfill.

6. Conclusions

From the results and discussion of this research work, the following conclusions can be derived:

- Sources located at periphery of the grid have lower emission rates compared to the sources inside the grid which confirms that there was least effect from the sources outside the landfill.
- The methodology developed in this research is sensitive to change in number of receptors; results improve with increase in number of receptors.
- Emissions from landfill vary considerably with changes in meteorological conditions.
- NMVOC emissions calculated using the “MATLAB Inverse Gaussian Dispersion Model” in this study falls within the range of highest and lowest NMVOC emission rates calculated using EPA LandGEM model.
- Total NMVOC emissions estimated for River Birch Landfill in this study is less than those for Seminole County Landfill reported by Figueroa et.al. which may depend on a number of reasons such as waste composition and other factors like meteorological conditions as rainfall, temperature etc.
- NMVOC emissions per unit area estimated for River Birch Landfill in this study is more than those for Seminole County Landfill reported by Figueroa et.al. which again depend on a number of factors such as the waste composition, age, environmental conditions, and others.

7. Recommendations

Based on the experience gained in this research, the following recommendations can be made to improve the results as well as the sampling and modeling methodology to estimate landfill emissions:

- As the number of receptors in a modeled grid can make a difference in results, a finer grid with increased number of receptors will provide more accurate emission results.
- More sophisticated and efficient instruments viz. VOC analyzer and GPS receivers that provide a speedier data collection capabilities should be utilized to collect near-surface concentrations at more locations in a single day to obtain more accurate results.
- The formation of the source-receptor grid can be modified based on active cells in the landfill area.

References

- ATSDR. (2008). "Chapter 4: Monitoring of Landfill Gas", Agency for Toxic substances and Disease Registry.
- Beluche, R. (1968), "Degradation of Solid Substrate in a Sanitary Landfill." Ph.D. Dissertation, University of Southern California, Los Angeles, 1968.
- Bennett G.F. (1987). "Air Quality Aspects of Hazardous Waste Landfills", *Journal of Hazardous Waste and Materials*, vol. 4, issue 2, pp 119.
- Chan C.Y., Chan L.Y., Ho K.F., Lee S.C., Wang X.M., Zhang Z.X. and Zou S.C. (2003). "Characterization of volatile organic compounds at a landfill site Guangzhou, South China", *Chemosphere*, vol. 51, pp 1015-1022.
- Cooper D.C. and Alley F.C., "Air Pollution Control: A Basic Design Approach", Waveland Press, 3rd edition, May, 2002, pp 32.
- Cooper D.C., Keely D., Reinhart D. R., Rash F. and Seligman D. (1992). "Landfill Gas Emissions", Florida Center for Solid and Hazardous Waste Management, Gainesville, FL.
- Cooper D.C., Eun S., Faour A., Reinhart D. R. and Townsend T.G. (2007). "Hydrogen sulfide flux measurements from construction and demolition debris (C&D) landfills", *Waste Management*, vol. 27, pp 220-227.
- Cooper D.C., Figueroa V. and Kevin R. Mackie. (2008). "Estimating Landfill Greenhouse Gas Emissions from Measured Ambient Methane Concentrations and Dispersion Modeling", AWMA annual conference, Portland, OR.
- DAVIS Instruments (2009), "DAVIS Weather Wizard III, Owner's Manual".
- Dernbach H., Henning K. D. (1987) "Purification steps for landfill gas utilization in cogeneration modules. *Resour Conserv*, vol. 14, pp 273-82.
- Desideri U., Maria, F. D., Leonardi, D., and Proietti, S., (2003) "Sanitary landfill energetic potential analysis: a real case study", *Energy Conversion and Management*, vol. 44 pp 1969–1981.
- Dincer F., Odabasi M. and Muezzinoglu A., (2006), "Chemical characterization of odorous gases at a landfill site by gas chromatography–mass spectrometry", *Journal of Chromatography A*, vol. 1122, pp 222-229.

El-Fadel M., Findikakis A.M. and Leckie J.O., (1989), "A Numerical Model for Methane Production in Managed Sanitary Landfills", *Waste Management and Research*, vol. 7, pp 31-42.

La Motta, E.J., McManis, K.L., Abreu, R.D., Cadenas C., Pulido M.E., and Peterson, M., (2004) "Removal of Leachate Contaminants and Stabilization of Municipal Solid Waste Using a Facultative Bioreactor System", University of New Orleans, June 30, 2004.

Falgoust R. (2009). "New Source Performance and Standard (NSPS) and National Emission Standards of Hazardous Air Pollutants (NESHAP) Reports", River Birch Landfill, Avondale, Louisiana.

Farquhar G.J. (1989) "Landfill Decomposition and Gas/Leachate Generation Processes", for presentation at the Sanitary Landfill Gas and Leachate Management Meeting. Orlando, Florida. March 1989.

Figuroa V.K., Cooper C.D., and Mackie K. R. (2008). "Estimating Landfill Greenhouse Gas Emissions from Measured Ambient Methane Concentrations and Dispersion Modeling", Annual Conference and Exhibition, 2008, Air and Waste Management Association. Paper # 327.

GARMIN, (2006), "GARMIN GPSMAP 60cx, Owner's Manual", GARMIN International Inc. 1200 East 151st Street, Olathe, Kansas 66062, USA.

Hamer G. (2003). "Solid waste treatment and disposal: effects on public health and environmental safety", *Biotechnology Advances*, vol. 22, pp 71-79.

Heguy D. and Bogner J. (2004), "Cost-Effective Hydrogen Sulfide Treatment Strategies for Commercial Landfill Gas Recovery: Role of Increasing C&D (Construction and Demolition) Waste", Gas Technology Products.

URL: <http://waste.environmental-expert.com>

Kuwahara N., Berni M.D., and Bajay S.V. (1999), "Energy Supply from Municipal Wastes: The Potential of Biogas Fuel Buses in Brazil", *Renewable Energy*, vol. 16, pp 1000-1003.

μ -blox ag (1999), "Datum Transformation of GPS Positions, Application Notes", July 05, 1999, μ -blox ag, Gloriastrasse 35, CH-8092 Zürich, Switzerland.

Minott, D.H., (1989), "Health Risks and the Alternatives of Resource Recovery versus Landfills for Municipal Solid Waste," Presented at the 82nd Annual Meeting and Exhibition of the Air and Waste Management Association, Anaheim, CA, June 25-30, (1989).

Nastev M., Therrien R., Lefebvre R., and Gelinas P., (2001), "Gas production and migration in landfills and geologic materials", *Journal of Contaminant Hydrology*, vol. 22, pp 187-211.

Parker, I., Dottridge, J., Kelly, S., (2002) "Investigation of the composition and emissions of trace components in landfill gas". R&D Technical Report PI-438|TR. Environment Agency, Bristol, pp 145.

Pohland, F.G. and S.R. Harper, (1985), "Critical Review and Summary of Leachate and Gas Production from Landfills", Georgia Institute of Technology, U.S. EPA Cooperative Agreement CR809997, SGEGIT-84-104, Atlanta, GA (1985).

RAE Systems Inc. (2006), "Technical Note: TN-158, Conversion of PID Readings to Methane Equivalent FID Response".

Ramaswamy, J.N. (1970), "Nutritional Effects on Acid and Gas Production in Sanitary Landfills." Ph.D. Thesis, Department of Civil Engineering, West Virginia University, Morgantown, WV (1970).

River Birch LLC (2009), "Personal communication with Vic Culpepper through email", October 15, 2009.

Reinhart, D.R., (1989) "Fate of Selected Organic Pollutants during Landfill Co-disposal with Municipal Refuse," Ph.D. Dissertation, Georgia Institute of Technology, Atlanta, Georgia.

Reinhart D. R. and Pohland F. G., (1991) "The assimilation of organic hazardous wastes by municipal solid waste landfills". J Ind Microbiol, vol. 8, pp 193-200.

Shen, T.T., (1982) "Air Quality Assessment for Land Disposal of Industrial Wastes", Environmental Management, vol. 6, issue 4, pp 297.

Themelis, N.J. and Ulloa, P.A., (2007), "Methane Generation in Landfills", Renewable Energy, vol. 32, pp 1243-1257.

Thermo Electron Corporation (2003), "Model 580B, Organic Vapor Meter (OVM), Datalogger, Instruction Manual", Environmental Instruments, 27 Forge Parkway, Franklin, MA, Dec 01, 2003.

Thibodeaux, L. J., (1981), "Estimating the Air Emissions of Chemicals from Hazardous Waste Landfills," J. Haz. Mat., vol. 4, pp 235.

Thorneloe, Susan A. and R. L. Peer, (1991), "EPA's Global Climate Change Program – Global Landfill Methane," Presented at the 84th Annual Meeting & Exhibition of the Air & Waste Management Association, Vancouver, Columbia (June 16 – 21, 1991).

UNFCCC (1996), "Climate Change 1995, The Science of Climate Change: Summary for Policymakers and Technical Summary of the Working Group", United Nations Framework Conventions on Climate Change, pp 22.

USEPA (1991), “Air Emissions from MSW Landfills – Background Information for Proposed Standards and Guidelines”. U.S. Environmental Protection Agency. Office of Air Quality Planning and Standards. Research Triangle Park, NC 27711, EPA-450/3-90-011a. March 1991.

USEPA (2005). “Landfill Gas Emissions Model (LandGEM), Version 3.02, User’s Guide”, US Environmental Protection Agency, Washington DC.

USEPA (2008). “Frequently Asked Questions Landfill Gas and How It Effects Public Health Safety and Environment”, Office of Air and Radiation, June 2008, US Environmental Protection Agency.

USEPA (2007), “US Emissions Inventory 2005: Inventory of U.S. Greenhouse Gas Emissions and Sinks: 1990-2003”. Landfill Methane Outreach Program. U.S. Environmental Protection Agency, Washington DC.

URL: <http://www.epa.gov/methane/sources.html>

Yedla S. and Parikh J.K. (2002), “Development of a purpose built landfill system for the control of methane emission from municipal solid waste”, Waste Management, vol. 22, pp 501-506.

Zou S. C., Lee S. C., Chan C. Y., Ho K. F., Wang X. M., and Chan L. Y., (2003)
“Characterization of ambient volatile organic compounds at a landfill site in Guangzhou, South China”. Chemosphere, vol. 51, pp 1015-22.

APPENDIX I

Permission Letter Enclosed

**Department of Civil and Environmental Engineering
University of New Orleans
2000 Lakeshore Drive
New Orleans, LA 70148**

November 5, 2009

Vic Culpepper, Sc. D.
Technical Director
River Birch Incorporated
2000 South Kenner Road
Avondale, LA 70094

Dear Dr. Culpepper,

This letter will confirm our communication through emails. I am completing a Master's Thesis at University of New Orleans entitled "Monitoring and Inverse Dispersion Modeling to Quantify VOCs in MSW Landfill". I would like to seek your permission to publish the "historical waste deposition data" received from you, "concentration of Non-methane VOCs" recorded, and the "emission rates of Non-methane VOCs" at River Birch Sub-title D landfill site.

The requested permission extends to any future revisions and editions of my Thesis, including non-exclusive world rights in all languages, and to the prospective publication of my Thesis by University of New Orleans. These rights will in no way restrict republication of the material in any other form by you or by others authorized by you. Your signing of this letter will also confirm that you own or River Birch Incorporated owns the copyright to the above-described materials.

If these arrangements meet with your approval, please sign this letter where indicated below and return it to me. Thank you very much.

Sincerely,

Sarit K. Das (Sarit K. Das)

PERMISSION GRANTED FOR USE REQUESTED ABOVE:

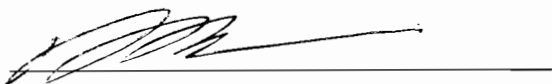

Vic Culpepper, Sc. D (November 6, 2009)

Vita

Sarit Kumar Das was born in Howrah, West Bengal, India and received his B.E. in Civil Engineering degree from Bengal Engineering and Science University (formerly known as Bengal Engineering College, Shibpur) in 2004. Then he worked for one year at M.N. Dastur and Co. as Assistant Engineer, got experience in structural design of industrial sheds. In 2005, he joined Indian Institute of Technology, Bombay (IITB), India for Masters in Environmental Science and Engineering. He successfully completed M.Tech. Degree there, in 2007. His M.Tech Thesis work focused on “Environment Management Issues related to Ship Breaking Industry in India”. During his academic program at IITB, he participated in Annual National Conference of Indian Environmental Association at Goa, India and presented a poster on “Status of Hazardous Waste Management in Ship Breaking Industry”. His work on environment management has been published as a conference paper in Annual Conference and Exhibition of Air and Waste Management Association in 2008. Spring, 2008, he joined the graduate program at the University of New Orleans in Civil and Environmental Engineering Department.