

CHRIS CHRISTIANSEN AND THE CHRIS CROSS

Wayne Orchiston

*Centre for Astronomy, James Cook University, Townsville,
Queensland 4811, Australia.*

E-mail: Wayne.Orchiston@jcu.edu.au

and

Don Mathewson

20 Beston Place, Queanbeyan, NSW 2620, Australia.

E-mail: Felix8@bigpond.com

Abstract: The Chris Cross was the world's first crossed-grating interferometer, and was the brainchild of one of Australia's foremost radio astronomers, W.N. (Chris) Christiansen, from the CSIRO's Division of Radiophysics in Sydney. Inspired by the innovative and highly-successful E-W and N-S solar grating arrays that he constructed at Potts Hill (Sydney) in the early 1950s, Christiansen sited the Chris Cross at the Division's Fleurs field station near Sydney, and from 1957 to 1988 it provided two-dimensional maps of solar radio emission at 1423 MHz.

In 1960 an 18m parabolic antenna was installed adjacent to the Chris Cross array, and when used with the Chris Cross formed the Southern Hemisphere's first high-resolution compound interferometer. A survey of discrete radio sources was carried out with this radio telescope.

The Division of Radiophysics handed the Fleurs field station over to the School of Engineering at the University of Sydney in 1963, and Christiansen and his colleagues from the Department of Electrical Engineering proceeded to develop the Chris Cross into the Fleurs Synthesis Telescope (FST) by adding six stand-alone 13.7m parabolic antennas. The FST was used for detailed studies of large radio galaxies, supernova remnants and emission nebulae.

The FST was closed down in 1988, and antennas in the original Chris Cross array quickly began to deteriorate. A number of individual antennas in the central part of the array received a new lease of life in 1991 when they were refurbished by staff and students from the Department of Electrical Engineering at the University of Western Sydney, but this only proved to be a temporary reprieve as even these aerials were bulldozed by the landowner in 2004, bringing to an untimely end one of the world's most remarkable radio telescopes.

Keywords: W.N. Christiansen, Chris Cross, cross-grating interferometer, Fleurs field station, 1420 MHz radio plages, Fleurs Compound Interferometer, Fleurs Synthesis Telescope.

1 INTRODUCTION

Wilbur Norman ('Chris') Christiansen (Figure 1) is one of the pioneers of Australian radio astronomy. After joining the CSIRO's Division of Radiophysics (RP) in 1948, he carried out observations of partial solar eclipses in 1948 (Christiansen, Yabsley and Mills, 1949a; 1949b) and 1949 (Wendt, Orchiston and Slee, 2008a), then briefly investigated the newly-discovered 21cm hydrogen line (Wendt, Orchiston and Slee, 2008c), before returning to solar radio astronomy and developing his E-W and N-S grating arrays at Potts Hill field station in 1952 and 1953 respectively (Christiansen and Warburton, 1953). These innovative radio telescopes provided valuable information on the one-dimensional and two-dimensional distribution of radio emission across the solar disk at 1420 MHz (for details see Wendt, Orchiston and Slee, 2008b).

As a result of contacts made during the 1952 URSI General Assembly in Sydney, Christiansen spent part of 1954 and 1955 in France, and during his 'sabbatical' he decided to build a new radio telescope in Sydney that would yield daily two-dimensional maps of the Sun at 1420 MHz. The inspiration for this came from his successful Potts Hill grating arrays (Christiansen, 1953) and Bernard Mills' development of the 'Mills Cross' (Mills and Little, 1953). Christiansen (1984: 122) was later to comment:

While visiting Potts Hill one morning in 1953, Mills asked me why we did not couple the two arrays to produce high resolving power in two dimensions. Dur-

ing the ensuing discussion it was agreed that for this to be effective the centres of the two arrays must not be separated (as they were in the Potts Hill antenna), and also that some means had to be devised to multiply the outputs of the array. By the next morning Mills had devised the Cross Antenna consisting of a pair of thin orthogonal antennas with their outputs multiplied to give a single narrow response.



Figure 1: W.N. Christiansen (far left) with Sir Edward Appleton (far right) and other URSI General Assembly delegates at Potts Hill in 1952 (courtesy ATNF Historic Photographic Archive: B2842-66).

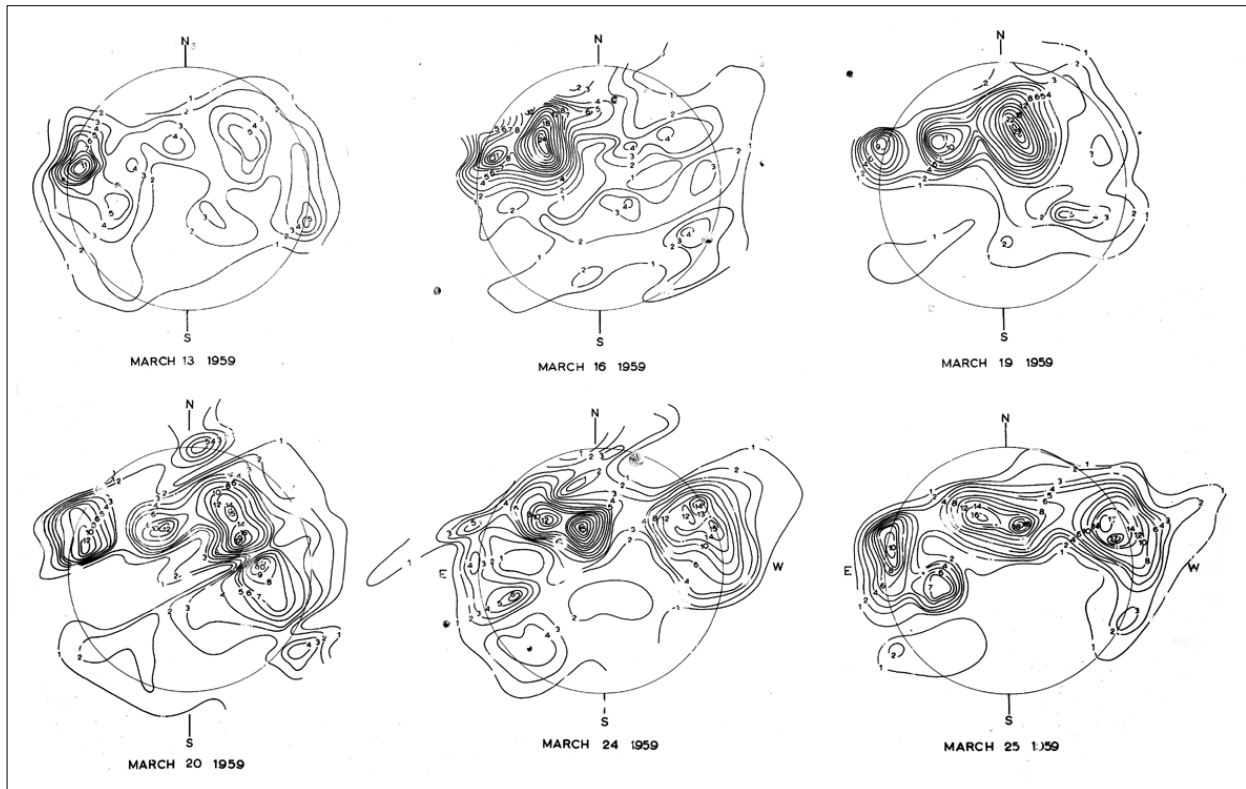

Figure 21: Six Chris Cross solar isophote maps for the period 13-25 March 1959. A notable feature is the prevalence of radio plages (courtesy ATNF Historic Photographic Archive: B6215-4).

When the Chris Cross became operational, Christiansen and Mathewson (1958: 131) were hopeful that the daily isophote maps would

... allow a study to be made of the development and decay of individual radio sources [= radio plages] on the sun and the general changes that these sources undergo during the solar cycle.

By the end of 1962 a large amount of data existed on the positions, sizes, temperatures and lifetimes of radio plages. Typically, they were found to be disk-like regions parallel to the photosphere with lateral dimensions of $\sim 25 \times 10^4$ km and brightness temperatures of $\sim 6 \times 10^5$ K (Christiansen and Mathewson, 1959: 110, 112). Meanwhile, the height of a radio plage was revealed by its rate of rotation across the solar disk. When this is plotted, as in Figure 22, the gradient of the line of best fit gives the height of the radio plage in the solar atmosphere. Such plots showed that radio plages are located between 2×10^4 and 10^5 km (with an error of $\pm 10^4$ km) above the photosphere, i.e. in the lower corona.

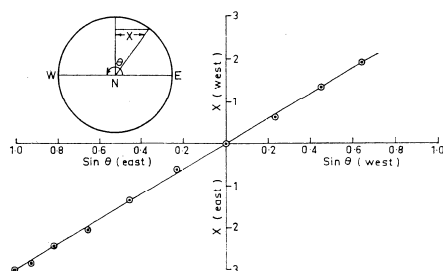

Figure 22: Plot of the displacement of a radio plage from the central meridian of the Sun against the sine of the angle of rotation of the Sun. The slope of the line gives the height of the radio plage in the solar atmosphere (after Christiansen and Mathewson, 1959: 110).

There was abundant evidence that radio plages were associated with chromospheric $H\alpha$ plages and with sunspots in the photosphere, and their magnetic fields. Typical radio plages have lifetimes of about three months, so it is not uncommon for an individual plage to be seen on three (or even more) successive solar rotations (Christiansen and Mathewson, 1959).

Christiansen and Richard F. Mullaly (1963: 171) describe the physical nature of radio plages:

It is believed ... [that they] consist of large clouds of gas (principally hydrogen) in the lower corona, much denser than the surrounding atmosphere. These clouds are prevented from dissipating presumably by magnetic fields ... The clouds are sufficiently dense to be opaque (optically thick) to decimetre radio waves; the gas of the surrounding corona at these heights is not. It is believed that the radio-frequency emission is thermal in origin, arising from collisions (without capture) between an electron and a proton ("free-free transitions").

At 1420 MHz, three basic types of solar radiation were recognised:

- 1) emission from the quiet Sun which remained constant for long periods, but may change in the course of the solar cycle;
- 2) a 'slowly-varying component' which varied from day to day; and
- 3) occasional intense bursts of emission.

Radio plages were responsible for the 'slowly-varying component'.

2.5 Associated Research Projects

In addition to monitoring the behaviour and duration of individual radio plages, the Chris Cross was used to

investigate emission from the quiet Sun (1 above), solar bursts (3), and other short-term phenomena.

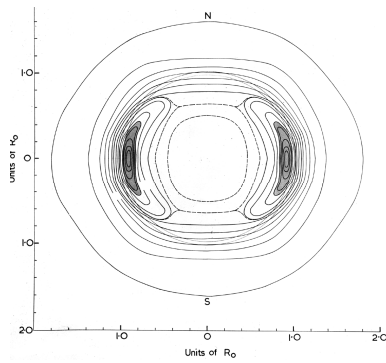

Figure 23: The two-dimensional distribution of radio brightness across the solar disk at 1420 MHz in 1952-1954 (after Christiansen and Warburton, 1955b).

As Christiansen and Mullaly (1963: 169) note,

Radio measurements of the quiet Sun are of importance, since they can provide information on temperatures and electron densities in layers of the solar atmosphere which are difficult to observe optically.

Observations carried out at Potts Hill with the two grating arrays showed that at 1420 MHz the Sun was non-symmetrical and exhibited distinct equatorial limb-brightening (see Figure 23), and that the central brightness temperature was 4.7×10^4 K (Christiansen and Warburton, 1955a: 482). However, this research was carried out near sunspot minimum, and any attempt to replicate it using the Chris Cross was fraught with difficulty given that the plethora of radio plages present near sunspot maximum tended to mask the quiet Sun radiation.

This, then, was Norman Labrum's challenge, and he responded admirably to it: first he used the Chris Cross between May and November 1958 to identify specific regions near the centre of the solar disk devoid of radio plages, and then he went on to determine the central brightness temperature of these (but only after making allowances for the effects of side lobes). The results are plotted in Figure 24, where a value of $10^5 \pm 10^4$ K accommodates all of the individual observations. This

equates to an apparent disk temperature of between 13×10^4 and 16×10^4 K.

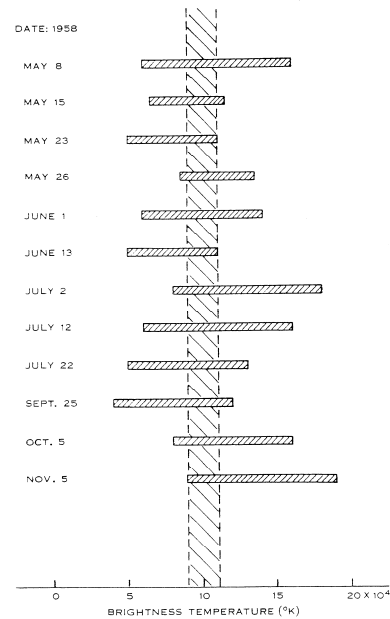

Figure 24: Twelve estimates of the central disk temperature of the quiet Sun in 1958, with the horizontal strips showing the limits of error of the individual records; the vertical band accommodates all of the individual observations (after Labrum, 1960: 703).

Labrum also tried another approach, one modelled on the procedure adopted previously by Christiansen and Warburton at Potts Hill. He took a set of twenty daily strip scans obtained with the N-S arm of the Chris Cross between September and November 1958, and tried to identify the lower (i.e. non-radio plage) envelope for each of these. All twenty scans are superimposed in Figure 25, where the confusion caused by radio plages is very apparent. After graphically estimating the mean value of the centre of the solar disk, Labrum derived the quiet Sun profile shown here in Figure 26, which produced a disk temperature of between 13×10^4 and 15×10^4 K. This agrees with the values obtained from the full Cross observations.

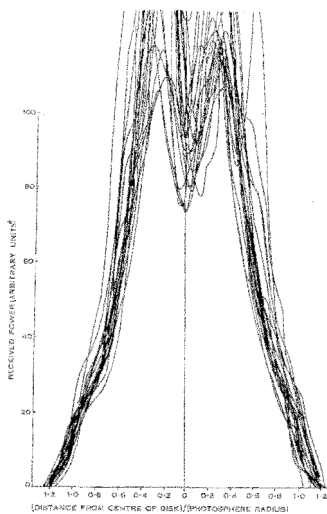

Figure 25: Twenty superimposed strip scans of the Sun obtained between September and November 1958 with the N-S arm of the Chris Cross (after Labrum, 1960: 707).

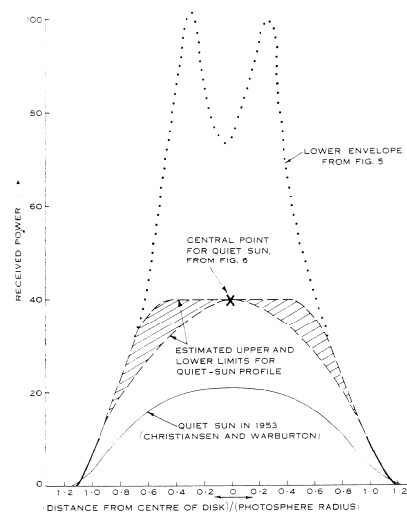

Figure 26: Profile of the quiet Sun derived from the scans in Figure 25. Christiansen and Warburton's 1955 profile is drawn on the same scale (after Labrum, 1960: 709).

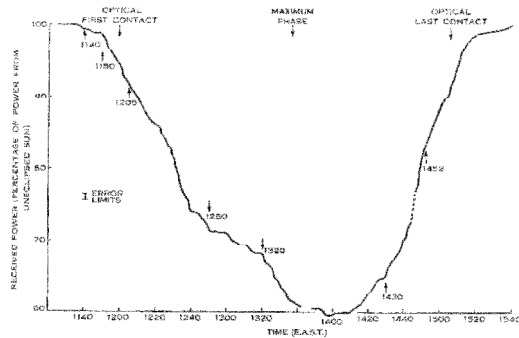

Figure 27: Eclipse curve obtained with the Potts Hill radiometer. The dashed region shows when calibrations were made (after Krishnan and Labrum, 1961: 408).

Back in 1953 Christiansen and Warburton (1955a) obtained an apparent disk temperature for the centre of the solar disk of 7×10^4 K, whereas a value $\sim 14 \times 10^4$ K applied in 1958, indicating that the temperature of the quiet Sun increased by a factor of two between sunspot minimum and sunspot maximum.

Because of the prevalence of radio plages in 1958 Labrum could not construct an isophote map like the one in Figure 23 but on the basis of the 1953 and 1958 profiles shown in Figure 26 he was able to conclude:

The two profiles are similar in shape; the ratio of corresponding ordinates in both equatorial and polar sections is approximately 2 : 1. It therefore seems likely that the brightness distribution is much the same at sunspot maximum and minimum. In particular, the pronounced limb darkening at the poles, which was detected from the earlier observations, was also present in 1958. (Labrum, 1960: 710).

On 8 April 1959 there was a partial solar eclipse that was visible from Sydney, and Labrum teamed with the visiting Indian radio astronomer, T. Krishnan, to observe this and carry out a further investigation of the distribution of radio brightness across the solar disk. The eclipse was observed with the Chris Cross and with the 16 x 18ft ex-WWII experimental radar antenna at Potts Hill. The latter radio telescope functioned as a total power radiometer, producing the eclipse curve shown above in Figure 27. The Chris Cross isophote plot showed six different radio plages on the Sun at the time, and these went some of the way towards explaining the nature of the eclipse curve. However, they did not tell the whole story.

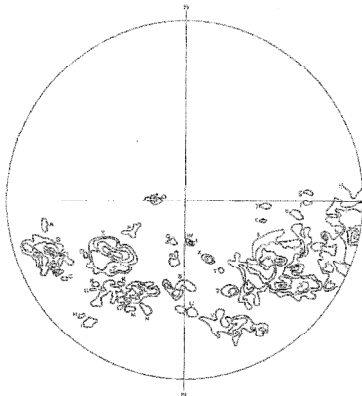

Figure 28: Photometric scan of calcium K line chromospheric plages visible on the northern half of the Sun (which alone was masked by the Moon) at the time of the eclipse; here south is at the top (after Krishnan and Labrum, 1961: 412).

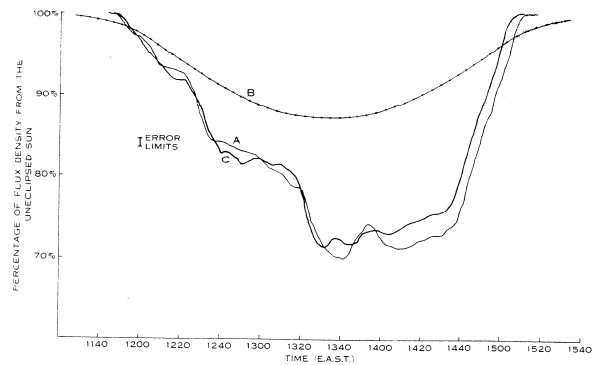

Figure 29: A is the eclipse curve for the optical plages; B is the curve obtained by using quiet Sun model number (4) discussed below; and C was obtained by subtracting curve B from the actual eclipse curve shown in Figure 27 (after Krishnan and Labrum, 1961: 415).

Given the association between optical plages and radio plages, Krishnan and Labrum proceeded to photometrically scan a photograph of calcium K line plages visible at the time of the eclipse (Figure 28), artificially eclipse this, adjust it so as to allow it to lie radially 7×10^3 km above the photosphere, and then compare this curve with the actual eclipse curve using four different models of the quiet Sun. The plot that gave the closest fit is reproduced here as Figure 29, and involved a Christiansen-Warburton type two-dimensional radio brightness distribution (as in Figure 23), but with the temperature gradient in the 'ear component' (alone) scaled up by a factor of 2 to allow for the solar maximum. The 'ear component' refers to the conspicuous equatorial limb-brightening shown in Figure 23. The four different models that Krishnan and Labrum investigated are shown in Figure 30, and the one labelled '(4)' was used in deriving Figure 29.

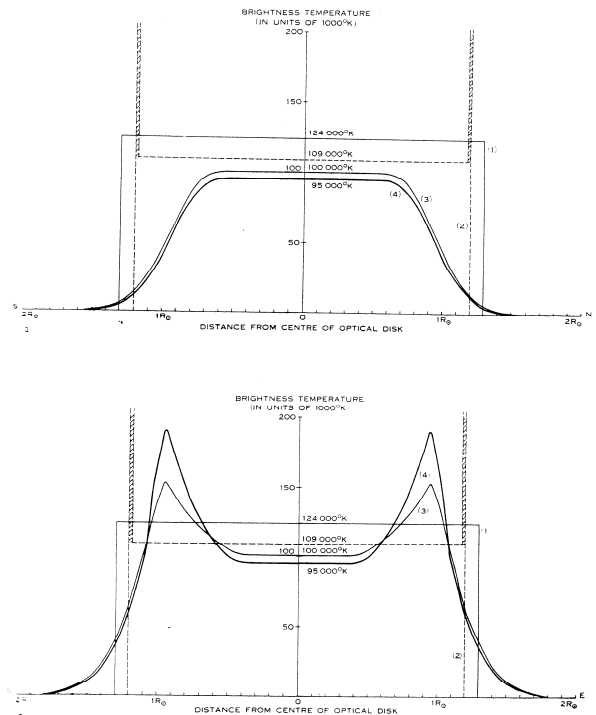

Figure 30: The four different quiet Sun models, (1)-(4), used in the analysis. Top: a plot of the distribution along the solar axis. Bottom: a plot along a line perpendicular to the solar axis and passing through the centre of the disk (after Krishnan and Labrum, 1961: 417).

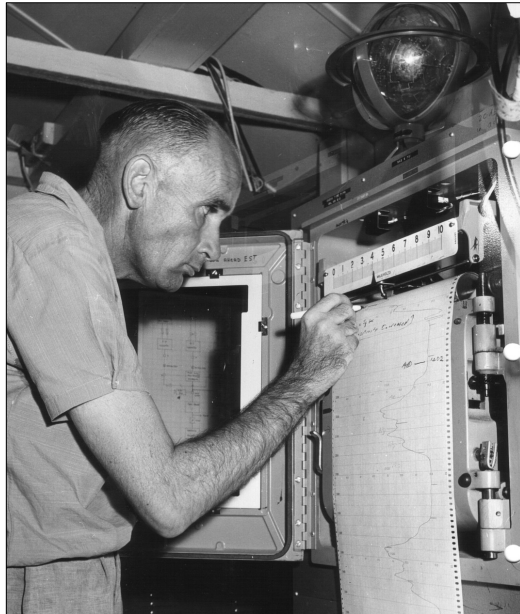

Figure 31: Dr Richard F. (Dick) Mullaly marking up a Chris Cross scan as it appears on the chart recorder (courtesy ATNF Historic Photographic Archive: B9097-4).

Krishnan and Labrum (1961: 418) conclude:

The quiet-Sun model that we have derived agrees with other observations in this laboratory (Labrum 1960) taken at sunspot maximum. While the method of analysis does not allow a very sensitive interpretation of the distribution of the quiet-Sun component, our result does seem to indicate limb brightening at the equator and the absence of limb brightening at the poles. The fact that the model with the gradient of the ear component stepped-up, fits best, indicates a limb-brightened model closer to those predicted theoretically than the Christiansen and Warburton (1955) model for sunspot minimum and brings out the advantages of higher resolution obtained at eclipse observations. It is interesting in this connexion to note that Tanaka and Kakinuma (1959) in the interpretation of their eclipse observations of April 1958 (near sunspot maximum) have also been led to suggest an ear component.

Although solar bursts were much more common at lower frequencies (see Stewart, 2009), they were occasionally recorded by the Chris Cross at 1423 MHz, and are the subject of three papers by Krishnan and Richard F. Mullaly. Figure 31 features Mullaly.



Figure 32: The longitude distribution of the 46 bursts observed with the Chris Cross (after Mullaly and Krishnan, 1963: 12).

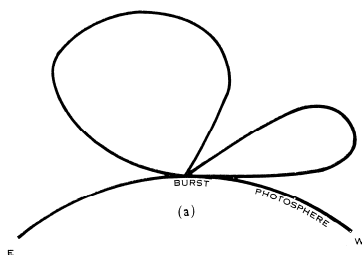

Figure 33: A possible double lobe burst polar diagram which accounts for the longitude distribution in Figure 32 (after Mullaly and Krishnan, 1963: 13).

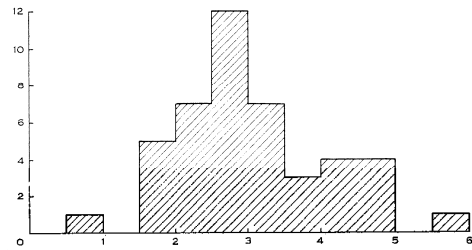

Figure 34: Plot of number of bursts versus angular size (in minutes of arc) (after Mullaly and Krishnan, 1963: 14).

In a paper titled “Solar decimetre radio bursts”, Mullaly and Krishnan (1963) discuss 46 bursts observed between 1958 and 1961 (inclusive). Their aim was primarily “... to determine typical physical characteristics of the decimetre burst sources: their sizes, positions, brightness temperatures, and movements.” (Mullaly and Krishnan, 1963: 9). Most observations were carried out with the E-W arm of the Chris Cross, which allowed successive scans of the Sun to be obtained every 4 minutes. All but one of the bursts were associated with individual radio plages, and when a burst occurred it was manifest by a sudden increase in the height of the radio plage. Sometimes when there were sudden intense bursts the chart recorder pen went off-scale, and the receiver gain had to be turned down.

When the heliocentric longitudes of the bursts were plotted they were found to be non-randomly distributed, with fewer bursts near the limbs than near the central meridian. There was also a suggestion of east-west asymmetry in the distribution, and there was a 30° region towards the eastern limb with no bursts whatsoever (see Figure 32). All this suggested to Mullaly and Krishnan (1963: 13) that these bursts “... typically have a polar diagram, with two lobes, asymmetrically disposed ...” as illustrated here in Figure 33.

The angular sizes of the burst sources were investigated, using the formula

$$S = (W^2 - b^2)^{1/2} \tag{2}$$

where S is the size in minutes of arc, W the half-power width of the burst and b the beamwidth of the fan beam. Values of S ranged between $<1'$ and $6'$ (Figure 34), with a mean of $3'$. When the angular sizes were plotted against the heliocentric longitudes of the bursts no significant differences were noted between the sizes of bursts near the central meridian and those near the limbs of the Sun (see Figure 35).

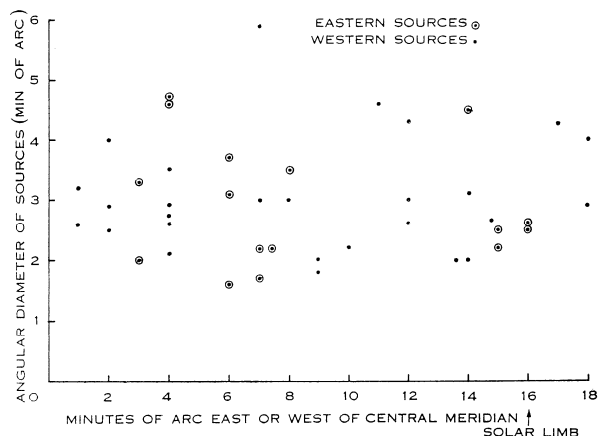

Figure 35: Plot of angular size of burst sources vs heliocentric longitude of the bursts (after Mullaly and Krishnan, 1963: 15).

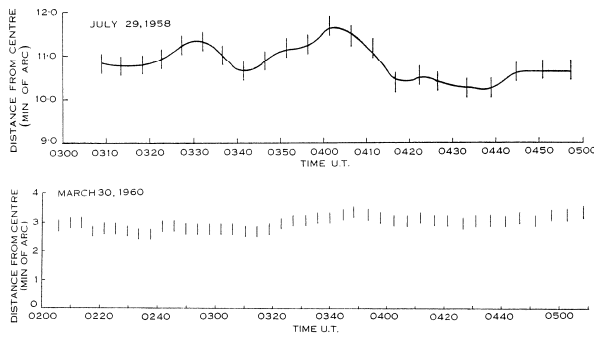

Figure 36: Two bursts showing apparent movement of the centroid of the emission sources through time. The vertical bars are running means for three successive scans (after Mullaly and Krishnan, 1963: 17).

In general, the angular sizes of the sources of Chris Cross bursts showed little or no change during the lifetimes of the bursts. The most notable exception occurred on 29 April 1960. In this case, the source systematically increased from $\sim 1.5'$ to $\sim 3.5'$ over the course of more than two hours, but during part of this interval (from 0300 to 0350 hrs UT) the source was inactive. On one or two occasions bursts were recorded which decreased in source size with the passage of time:

Thus a very intense burst on July 14, 1959 had an initial stage of very strong emission with an angular size of about $4'$ or $4.5'$ of arc, followed by a period of weaker emission during which the size appeared to be about $3'$. (Mullaly and Krishnan, 1963: 16).

While no large-scale changes in the positions of the sources were ever observed, sometimes bursts did exhibit small fluctuations in position of up to $\pm 1'$ over the course of tens of minutes to hours. Two of the most notable examples are shown here in Figure 36. Mullaly and Krishnan (1963: 17) suggested that such movements were perhaps due to "... the brightening or darkening of one part of the burst source relative to another, rather than a bodily movement in the source region as a whole."

The peak brightness temperature (T_b) of each burst was investigated, using the formula

$$T_b = F/1.88 \times 10^{-27}(S/32\lambda)^2 \quad (3)$$

where F is the flux density in $\text{W m}^{-2}(\text{c/s})^{-1}$, S is the size of the source in minutes of arc, and λ is the wavelength in metres. All of the bursts had peak brightness temperatures between 10^6 K and 2×10^9 K, with 84% between 10^6 and 10^8 K (Figure 37). Noting that there were no bursts with $T_b < 10^6$ K, Mullaly and Krishnan (1963: 18-19) concluded:

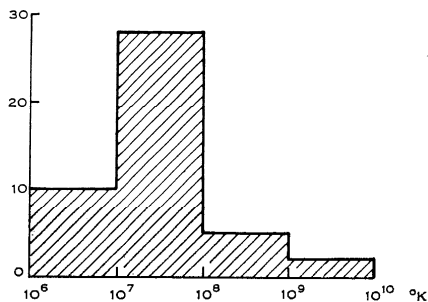

Figure 37: Histogram of the peak brightness temperatures of all bursts (after Mullaly and Krishnan, 1963: 19).

It seems then that there may be a cut-off and that bursts with peak brightness temperatures much below 10^6 °K do not occur or occur infrequently. On the other hand, such bursts may escape observation by being of very short duration or unusually small angular size. The question of a cut-off is of interest for the discussion of possible mechanisms of production of burst radiation.

Towards the end of their paper Mullaly and Krishnan (1963: 22) address this last-mentioned issue, pointing out that "It is difficult to account for temperatures of the order of 10^8 °K on the basis of thermal emission alone." They note that Takakura (1960) has suggested synchrotron radiation as a possible mechanism, while Hachenberg and Wallis (1961) advocate quasi-thermal emission, with bands of weak synchrotron radiation superimposed, but the Chris Cross data did not allow them to distinguish between the two mechanisms.

Mullaly and Krishnan also investigated the sizes of burst sources relative to their associated radio plages and found no direct correlation. Many sources were comparable in size to their parent plages, but some were smaller; "The striking feature, however, is that *none of the burst sources substantially exceed [sic.] their associated plages in size.*" (Mullaly and Krishnan, 1963: 20; their italics).

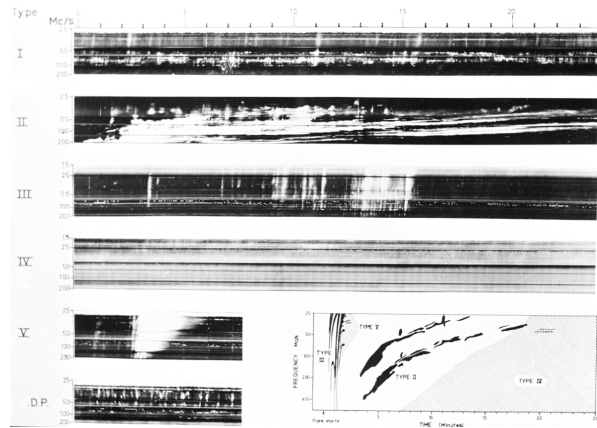

Figure 38: The different spectral types of solar bursts; time is in minutes. Type IV continuum emission (fourth strip from top) can last for days (courtesy ATNF Historic Photographic Archive: B6317).

The heights in the solar atmosphere of ten burst sources near the limb were examined and their displacement from the positions of their parent plages was measured. Six coincided in position; one was closer to the central meridian by $0.5 \pm 0.3'$, and three were further away from the central meridian by $\sim 0.7 \pm 0.3'$, indicating that most burst sources were situated within $\pm 2 \times 10^4$ km of their parent radio plages (Mullaly and Krishnan, 1963: 19-20).

Before writing their 1963 paper, Krishnan and Mullaly investigated Chris Cross bursts that were known to be associated with metre-wave continuum emission of spectral Type IV (see Figure 38). Eight different bursts were recorded between July 1958 and November 1960 (inclusive).

The heights of these burst sources in the solar atmosphere were calculated using the following formula (and on the assumption that they lay radially above the associated flares):

$$H = R_{\odot} Y/X \quad (4)$$

where H is the height radially above the $H\alpha$ flare in km, R_{\odot} is the radius of the Sun, and X and $X + Y$ respectively denote the perpendiculars from the centroid of the flare position (see Krishnan and Mullaly, 1962: 91, Figure 4). Values of H for the eight bursts were all $<3.5 \times 10^4$ km, except on one day when the source was close to the central meridian and this method was not applicable. Krishnan and Mullaly (1962: 91) conclude that "... the regions of origin of 1420 Mc/s bursts are situated in the lower solar atmosphere and not in the upper corona."

Angular sizes of the sources of the eight bursts were calculated using Equation (2) above and ranged from $<2.0'$ to $4.6'$ (see Krishnan and Mullaly, 1962: 90). No significant changes in source sizes were detected during the lifetimes of the bursts. Peak brightness temperatures of the bursts were also calculated, from Equation (3) above, with values ranging from 2×10^7 K up to 2×10^9 K (ibid.).

One of the features of metre wave Type IV events is that some of the sources of the continuum radiation show rapid movement away from the Sun, while other

source regions remain stationary (see Stewart, 2009). Krishnan and Mullaly were keen to see if the sources observed with the Chris Cross followed a similar pattern, but only three of their bursts were accompanied by Dapto interferometer records at 45-60 MHz. These three events are shown in Figure 39, where two of the three Type IV burst sources exhibit large-scale outward motion from the Sun, while the third burst (on 15 November 1960) shows significant oscillations in its position in the corona. In contrast, there were no changes in the positions of any of the Chris Cross sources. Krishnan and Mullaly (1962: 95) conclude that the Chris Cross emission and Type IV metre wave emission were generated simultaneously, but at widely different levels in the solar atmosphere, and "It is clear that the decimetre [i.e. Chris Cross] radiation, which is known to be broad-banded, cannot be described simply as an extension of the metre wavelength type IV continuum." We should note that one year earlier, Krishnan and Mullaly (1961) had summarized their principal findings in a short paper which was published in *Nature*.

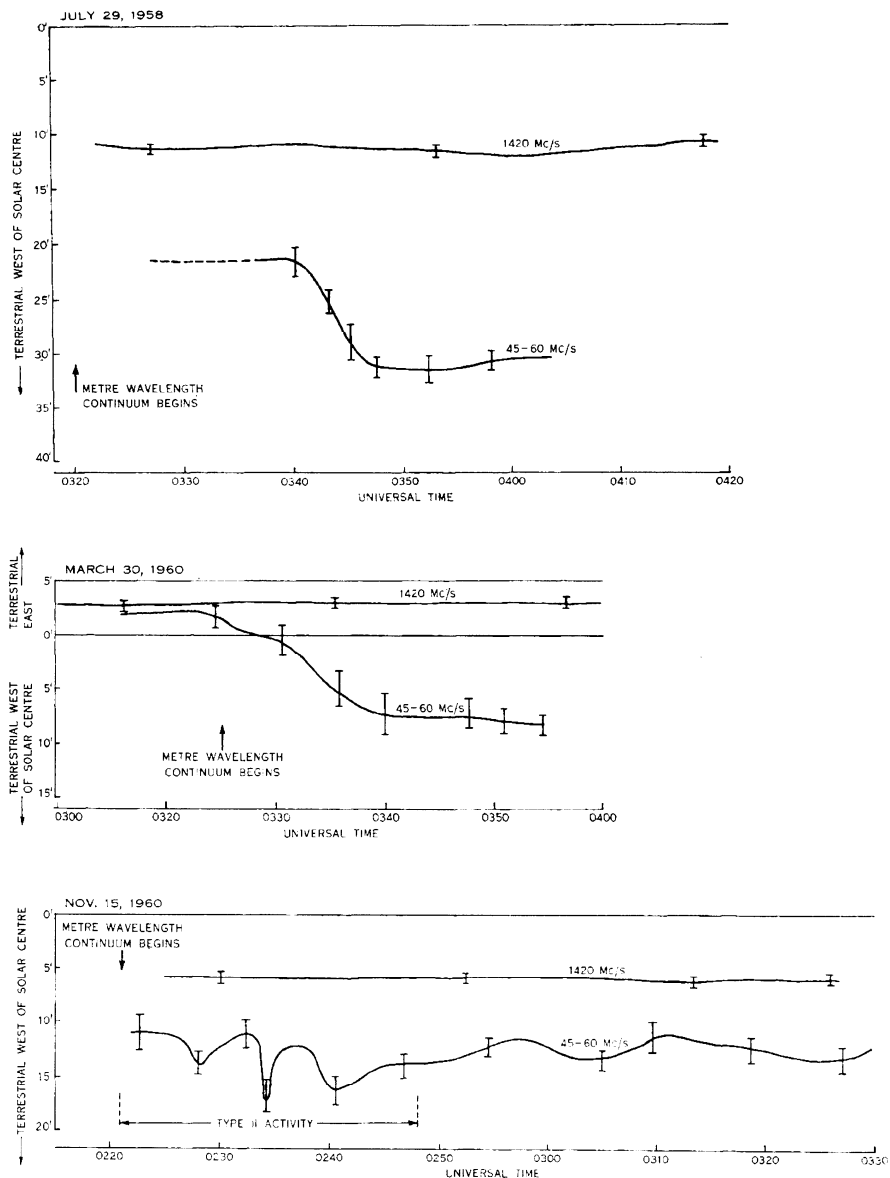

Figure 39: The E-W positions of three Chris Cross bursts at 1423 MHz and their corresponding Type IV bursts at 45-60 MHz. The bars at 45-60 MHz indicate that variations in position that occurred between 45 and 60 MHz (after Krishnan and Mullaly, 1962: 94).

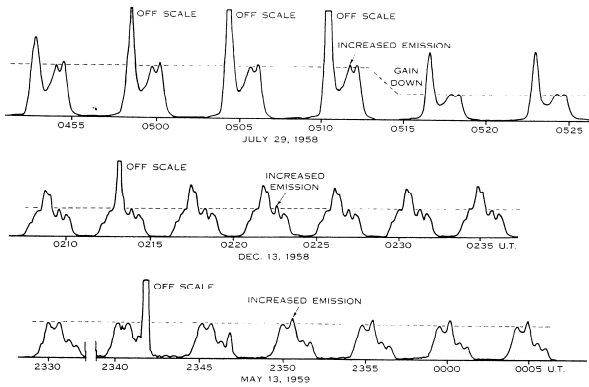

Figure 40: Three sets of Chris Cross E-W strip scans of the Sun showing in each case a burst followed about 10 minutes later by a small enhancement in the level of a quite different radio plage (after Mullaly, 1961: 541).

In 1961 Mullaly also published a short paper in which he reported three cases where a small 1423 MHz burst was followed within 8-9 minutes by a small-scale localised brightening of a distant radio plage (see Figure 40). Mullaly (1961: 541) explains these enhancements:

The immediate deduction from the observations is that the secondary increases are stimulated by something (e.g. a plasma cloud or a shock wave) propagated from the region of the main burst. The velocity of propagation appears in all cases to lie between 1000 and 2000 km/s ...

Two of the three events were possibly associated with optical surges and Mullaly (1961: 542) noted that Athay and Moreton (1961) recently reported optical observations of what they interpreted as plasma clouds travelling out from the regions of solar flares at velocities between 10^3 and 2.5×10^3 km/s. They also mentioned that on some such occasions sudden optical changes were observed in filaments located as far away as 7×10^5 km from the original flare site.

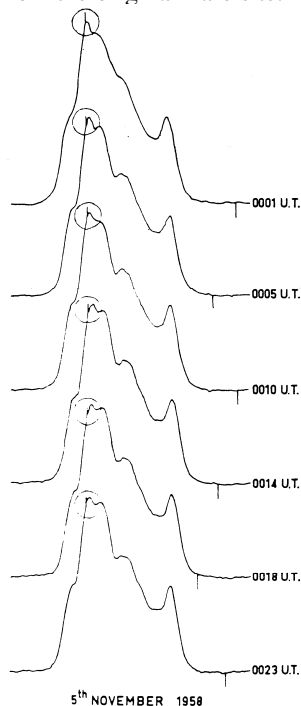

Figure 41: Examples of 'pips' (circled) recorded on successive E-W. Chris Cross scans on 5 November 1958 (after Christiansen and Mullaly, 1963: 173).

The final type of anomalous solar phenomenon discovered with the Chris Cross involved a project that was carried out jointly by Mullaly and the first author of this paper, up until the former suddenly left the CSIRO's Division of Radiophysics in 1962 and joined Christiansen at the University of Sydney. Our planned paper on "Solar Microwave Transients", or 'Pips' as we colloquially called them, never materialised, but they were discussed briefly by Christiansen and Mullaly in their 1963 review paper on the Chris Cross.



Figure 42: The 18m Kennedy Dish (courtesy ATNF Historic Photographic Archive: B6499-7).

They describe these pips:

On certain days when continued East-West strip scanning was being carried out it was found that the recorder pen repeatedly exhibited momentary deflections ("pips") when a particular radio plage region was in the aerial beam, but at no other time. (Christiansen and Mullaly, 1963: 172).

Figure 41 shows six successive E-W array scans, and a pip is present on every scan, near the peak of the most intense radio plage. Pips tended to occur in 'pip storms', when 60-100% of all scans showed pips, and always associated with the same radio plage. Some radio plages seemed prone to pips, which occurred repeatedly over a number of successive days.

Pips were always <1 second in duration (the resolving time of the receiver), and in intensity were typically 5-10% of that of the associated radio plage. As for the origin of pips, and the emitting sources:

Nothing is known of the dimensions of the sources of the transient emission, except that they are not larger than a typical radio plage region. Assuming an angular diameter of $2'$ of arc and a duration of 1 second, a typical pip must represent a momentary flash with a brightness temperature of at least 10^5 °K [sic.]. If the diameter is less (as *a priori* seems likely), or the dura-

tion shorter, the brightness temperature attained could well be much greater than this. (ibid.)

Christiansen and Mullaly (ibid.) note that pips were a feature of the solar maximum. Early in 1960 activity began to decline, and towards the end of that year pips had all but disappeared.

2.6 Non-Solar Astronomy

In 1958 three non-solar staff members from the Division of Radiophysics realised that a high-resolution instrument like the Chris Cross had the potential to contribute to galactic and extragalactic research, and they used the E-W arm of the Cross at 1427 MHz to investigate a number of discrete sources (see Twiss, Carter and Little, 1960; 1962).

Their one-dimensional brightness distribution for Centaurus-A confirmed earlier studies which showed a complex source with "... two bright regions, each of about $2\frac{1}{2}'$ arc between half-intensity points and separated by $5'$ arc." (Twiss et al., 1960: 156).



Figure 43: View looking east showing the Kennedy Dish and part of the E-W arm of the Chris Cross (courtesy ATNF Historic Photographic Archive: B6499).

Taurus-A proved to be a single source, with the brightness distribution indicating that nearly all the radiation at 1427 MHz derived from a region about $8'$ across. However, observations with the N-S arm of the Cross and also with NE-SW baselines revealed the source to be elliptical, with the major axis at position angle 135° (Twiss et al., 1960: 157). No polarisation was detected Twiss et al., 1962: 386).

A single source was also found to be associated with the Great Orion Nebula:

The radio source has a simple, approximately Gaussian, shape with a width of $3'$ between the points of half intensity. Nearly all the radiation appears to come from a region less than $12'$ across. There is some asymmetry and the edge of the source is brighter on the eastern than on the western side. (Twiss et al., 1960: 159).

Cygnus-A was the other discrete source observed with the Chris Cross, but its far northern declination created problems. In general, the results obtained tended to confirm the earlier findings of other researchers.

3 THE FLEURS COMPOUND INTERFEROMETER

In November 1960 the 'Kennedy Dish' (Figure 42), an 18.2m (60ft) American prefabricated steerable parabolic reflector on an altazimuth mounting, was installed at Fleurs 24.4m (80ft, or double the spacing of individual elements of the Chris Cross) beyond the eastern end of

the E-W arm of the Chris Cross (Figure 43).³ When used as a multiplying element with the E-W arm of the Cross it formed the Fleurs Compound Interferometer (FCI) (Figure 44), having a fan beam with a half-power beam width of $1.53'$ (see Labrum et al., 1963; 1964). As indicated in Figure 45, the uncorrected polar diagram showed unacceptably high side lobes, but by convolving the observed response with a correcting function these were reduced to $<4\%$ of the main response (i.e. curve (b) in Figure 45).

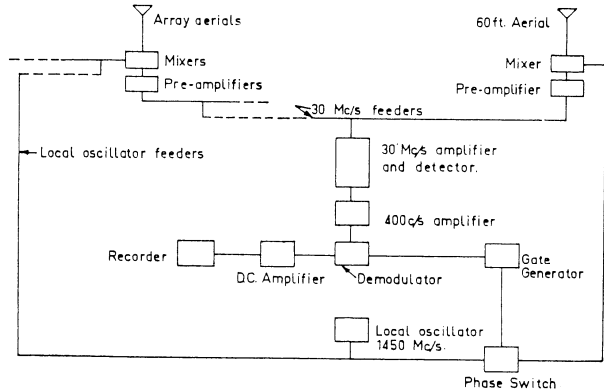

Figure 44: Block diagram of the Fleurs Compound Interferometer receiving system (after Labrum et al., 1963: 151).

From August 1961 until October 1962 (Aerials at "Fleurs" ..., 1964) the FCI was used to determine the right ascensions and angular sizes of eight well-known discrete sources.⁴ The observational procedure was outlined by Labrum et al. (1963: 151):

An improvement of $\sqrt{20}$ times in sensitivity was obtained by recording the passage of each source through 5 successive lobes of the interference pattern, and repeating the whole sequence on 4 nights, thus giving 20 observations which were subsequently integrated. On this basis, the intensity of the minimum detectable point source should be roughly $10 \times 10^{-26} \text{wm}^{-2} (\text{cs})^{-1}$.

The observations, in each case, were carried out over a period of about one week. The results are summarised in Table 1, and Figure 46 shows the observed E-W profiles of the various sources.

Table 1: Positions and corrected sizes of selected discrete sources observed with the Fleurs Compound Interferometer (adapted from Labrum et al., 1964: 326)

Source	Position (epoch 1960)			Size		
	Right Ascension			P.E.	E-W	P.E.
	h	m	s	(s)	(')	(')
Sagittarius-A	17	42	28.8	± 0.8	4.1	± 0.05
Taurus-A	05	31	27.3	± 0.7	3.6	± 0.05
Centaurus-A	13	22	16.4	± 0.9	2.1	± 0.10
	13	22	44.2	± 0.9	2.7	± 0.10
Omega Neb.	18	17	32.9	± 0.7	4.1	± 0.05
	18	17	51.3	± 1.5	2.5	± 0.15
Orion Nebula	05	32	48.9	± 0.7	3.4	± 0.10
Hydra-A	09	15	41.5	± 0.7	0.5	± 0.20
Virgo-A	12	28	17.0	± 0.7	1.25	± 0.15
Cygnus-A	19	57	44.4	± 1.0	---	---

Sagittarius-A was of considerable interest in that Drake (1959) had suggested that the position adopted for it by Gum and Pawsey (1960) when recalibrating the new galactic coordinate system was several seconds of arc too far to the east, and that "... the intense

main source is associated with a complex of weaker but more extended components." (Labrum et al., 1964: 327-328). The FCI observations (Figure 46a) confirmed these findings.

High-resolution studies of Centaurus-A by a number of researchers had shown this source to consist of two emitting regions, extending over several degrees in declination, with a bright central core which itself was a double source. The Fleurs observations (Figure 46c) confirmed this, showing the core sources were 5.1' apart and had E-W widths of 2.1' and 2.7'.

The E-W profile for the Omega Nebula (Figure 46d) exhibits conspicuous asymmetry which Labrum et al. (1964: 331) attribute to the presence of a weak secondary source about 18 seconds east of the main source. This is listed separately in Table 1.

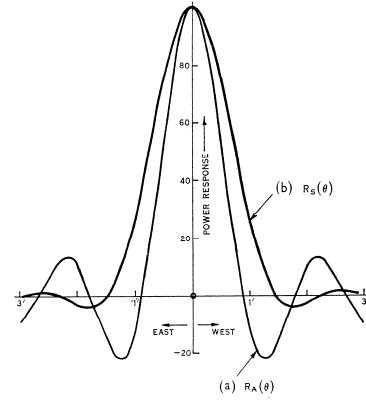
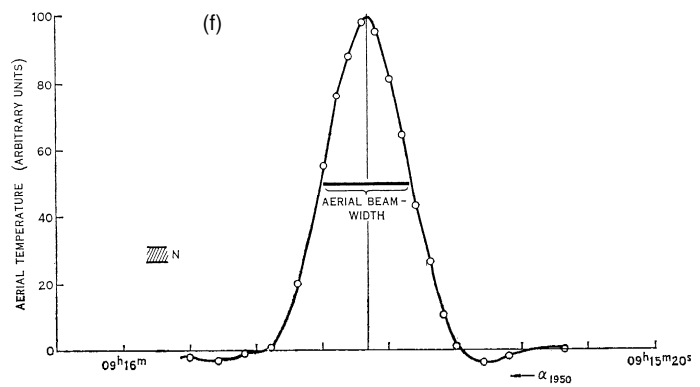
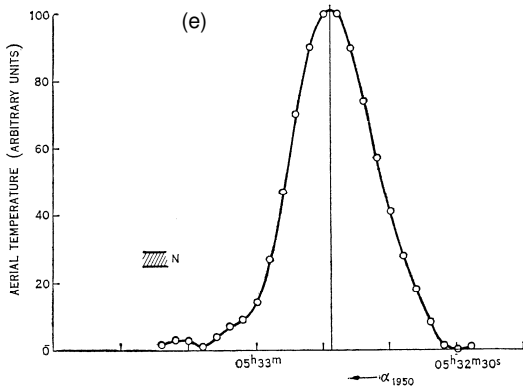
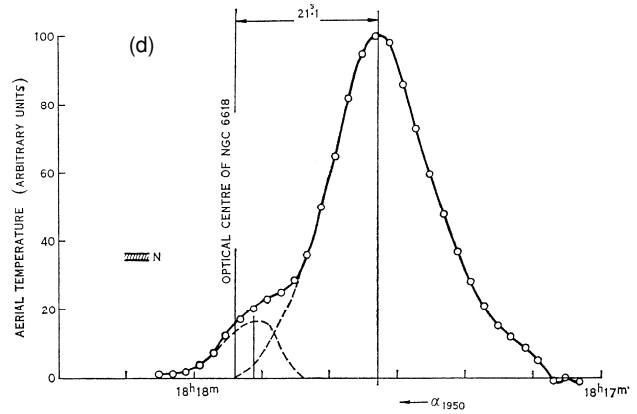
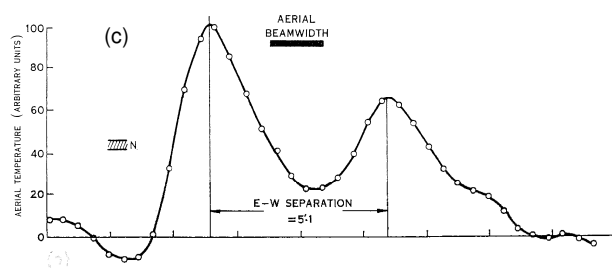
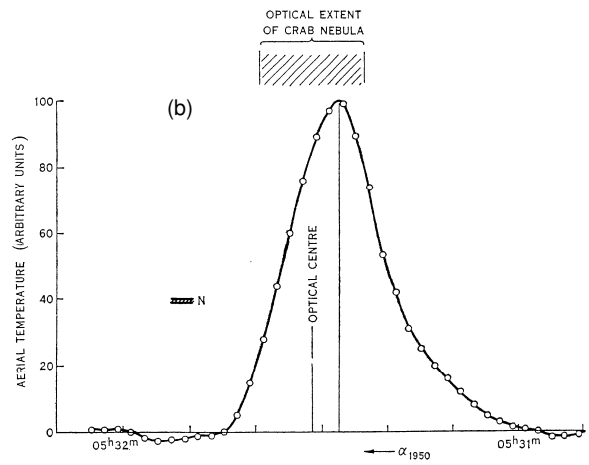
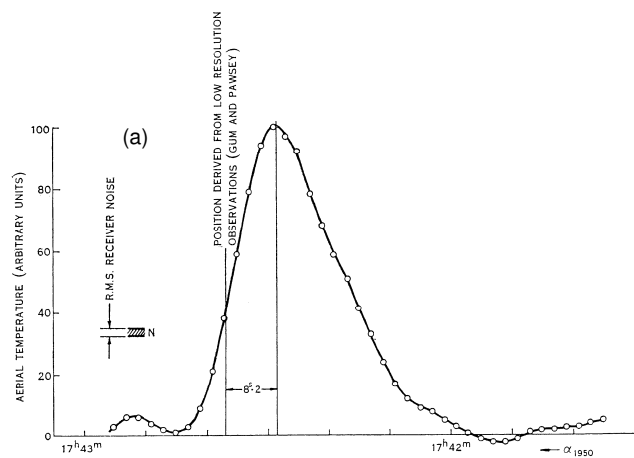

Figure 45: Polar diagrams of the Fleurs Compound Interferometer, showing the uncorrected (a) and corrected (b) curves (after Labrum et al., 1964: 325).



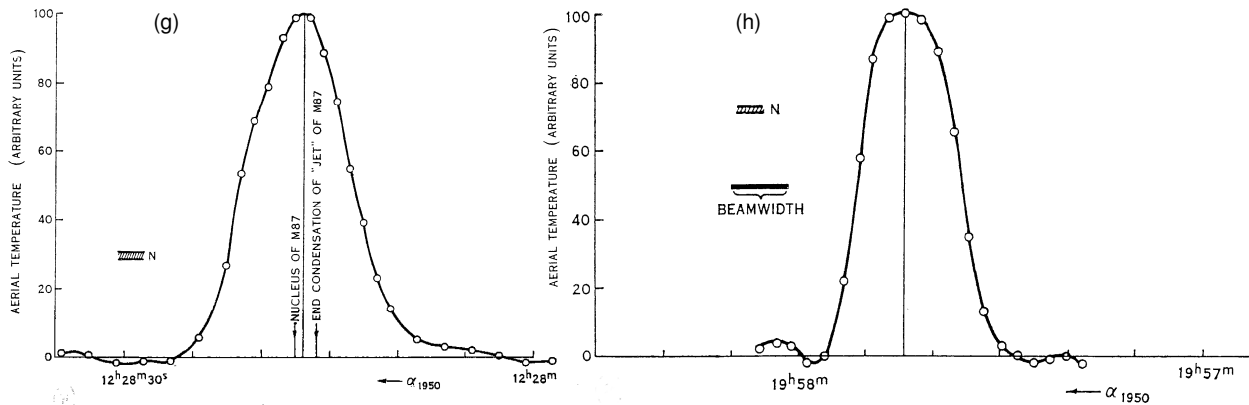

Figure 46: Fleurs Compound Interferometer E-W profiles for the following sources: (a) Sagittarius-A; (b) Taurus-A; (c) Centaurus-A; (d) Omega Nebula; (e) the Great Orion Nebula; (f) Hydra-A; (g) Virgo-A; and (h) Cygnus-A (after Labrum et al., 1964: 328-334).

Earlier reports suggested that the radio source associated with the Great Orion Nebula coincided with the position of θ^1 Orionis, and the FCI observations (Figure 46e) confirmed this.

Virgo-A was another source of particular interest to the FCI team in that

Shklovskii (1955) suggested that the radio emission from this source originates as synchrotron radiation from the "jet", a structure which extends some 20" westwards from the optical centre of M87. (Labrum et al., 1964: 332).

The Fleurs observations placed the centre of the radio source between the centre of the galaxy and the end of the jet (Figure 46g), and on the basis of this finding and results reported earlier by other radio astronomers Labrum et al. (1964: 333) supported Shklovskii's conclusion.

The enigmatic source Cygnus-A was also observed with the FCI, but under unfavourable conditions given its far northern declination. It only had an elevation of 15.5° at meridian transit. Consequently

Tropospheric refraction had an appreciable effect upon the apparent declination of the source, and so on the relative phases of the signals from the array and from the single-aerial element. It was in fact found that the phase changed slightly from night to night, and that it was necessary on each occasion to estimate the phase error from the appearance of a preliminary scan across the source. An empirical phase correction was then made before the beginning of the main part of the record. (Labrum et al., 1964: 333).

Reports by other observers showed the source to be double, with the space between the two components bridged by a broad weak source. The resolution of the FCI was not quite sufficient to show these structural details (see Figure 46h), but by using the *uncorrected* polar diagram and three different models of the source (see Figure 47), useful conclusions were reached:

... the source has two main components which are both too narrow in the east-west plane to be resolved by the interferometer ... [but] where an extended component is included in the model ... the east-west spacing of the doublet is found to be 99". This agrees very well with the work of Swarup ... (Labrum et al., 1964: 335).

The Kennedy Dish was relocated to Parkes in 1963 in order to be used in conjunction with the 64m Parkes Radio Telescope, so the Fleurs Compound Interferometer only had a short life. However, it had allowed

the Chris Cross to be used of an evening for further non-solar work, and it gave three members of the RP Solar Group (Labrum, Krishnan and Payten) a brief opportunity to dabble in non-solar radio astronomy. Although Christiansen was not personally involved in this work (having already transferred to the School of Electrical Engineering at the University of Sydney), he is acknowledged in both of the Labrum et al. papers (1963 and 1964) for his helpful advice, constant interest and encouragement. In their 1963 paper the authors also make the interesting point that it was Christiansen who initiated the Fleurs Compound Interferometer Project.⁵

4 THE FLEURS SYNTHESIS TELESCOPE

In 1963, after making important contributions to solar, galactic and extragalactic astronomy for twenty years (see Mills, 1984; Orchiston, 2004; Orchiston and Slee, 2002), the Fleurs field station became surplus to RP requirements and was closed down. This followed the relocation of the Kennedy Dish to Parkes and the consolidation of the Division's galactic and extragalactic research at Parkes.

The initial plan was to demolish the Mills Cross, Shain Cross and Chris Cross, but after representations from the University of Sydney a decision was made to simply transfer the site lease to the University. This officially occurred on 1 July 1963, when all of the equipment remaining at the site was also formally handed over to the University.

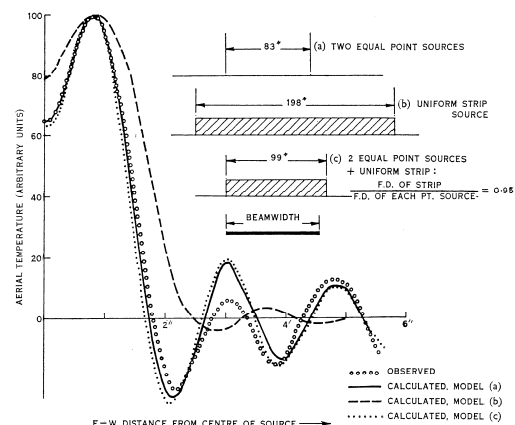

Figure 47: Fleurs Compound Interferometer observations of Cygnus-A (small circles) compared with three different source models (a), (b) and (c) (after Labrum et al., 1964: 335).

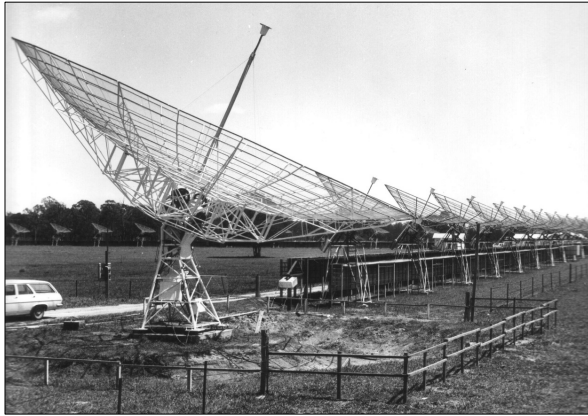

Figure 48: One of the Fleurs Synthesis Telescope's 13.7m antennas, located at the eastern end of the Chris Cross (courtesy ATNF Historic Photographic Archive: 9097-11).

This initiated a new era in the site's history, and although regular Chris Cross solar observations were continued (Christiansen, 1967)—but on a somewhat curtailed scale—Christiansen's main effort went into converting the Chris Cross into the Fleurs Synthesis Telescope (FST). This ambitious project would occupy staff from the School of Electrical Engineering and their graduate students for the next two decades and result in a radio telescope comprising the original Chris Cross and six stand-alone 13.7m parabolic antennas (Figure 48) with a 20 arc second beam (see *The Fleurs Synthesis Radio Telescope*, 1973). During the 1970s and 1980s the FST was used to study large radio galaxies, supernova remnants and emission nebulae.



Figure 49: A view looking south along the N-S arm of the decommissioned Chris Cross showing rusting antennas (courtesy John Leahy).

A detailed account of the FST and Christiansen's pivotal role in its planning, development and use will be presented by Miller Goss in a later issue of this journal.

5 THE DEMISE OF FLEURS

The Fleurs Synthesis Telescope was closed down in 1988, bringing to an end 34 years of research into solar, galactic and extra-galactic radio astronomy at Fleurs, and the site was transferred to the Engineering Faculty at the University of Western Sydney to serve as a teaching facility for undergraduate students. In the mean time, the Mills Cross and the Shain Cross rapidly deteriorated, and the Chris Cross dishes and larger antennas of the Fleurs Synthesis Telescope continued to rust (Figure 49).

In 1990 the University of Western Sydney recognised the historical importance of the Fleurs field station, and a decision was made to restore one of the 13.7m Fleurs Synthesis Telescope antennas and the twelve centrally-located Chris Cross antennas, but to remove all of the other Chris Cross antennas and superstructure from the site. It was also decided that a section of the Mills Cross should be reconstructed.

Staff and undergraduate students worked diligently on this project, and by 22 November 1991 all was ready for a ceremony to mark the refurbishment of these historic radio telescopes (Figure 50). It was only appropriate that one of the speakers on this occasion was Professor W.N. Christiansen (see Figure 51).

In 1998, the Fleurs field station again became surplus to requirements and was closed down by the University of Western Sydney. This brought into sharp focus the long-term future of the remaining elements of the Fleurs Synthesis Telescope, including the twelve refurbished Chris Cross antennas.

6 DISCUSSION

6.1 The Chris Cross in International Context

By mid-1957, when the Chris Cross became operational, a number of other nations were actively engaged in solar radio astronomy, but with instrumentation that was relatively less sophisticated than that used by the Division of Radiophysics in Australia.

Britain and Australia were the leading radio astronomy nations in the decade following World War II, and although some solar work was carried out in Britain using 2-element interferometers (see Smith, 2007), the main focus of research at Jodrell Bank and Cambridge was meteors, and galactic and extragalactic sources.

In contrast, Canada was one nation that specialised in solar radio astronomy, beginning in 1946. The following year the Goth Hill Radio Observatory was founded, which featured a small steerable dish and a slotted waveguide array. By January 1956 this array and an adjacent array had been developed as a compound interferometer with a 2.4' fan beam (see Covington, 1984).

Another nation to focus on solar radio astronomy was Japan. The earliest observations were carried out in 1949 with a steerable horn at Osaka University and a small broadside array at the Tokyo Astronomical Observatory at Mitaka. A 10-m dish was erected at Mitaka in 1953, and in this same year a 5-element grat-

ing array developed by Nagoya University was operational at Toyokawa. In 1954 this was extended to an 8-element array. However, Tanaka (1984: 340) stresses that the first grating array "...was planned and built quite independently of the one developed by Christiansen ..."

Solar radio astronomy was initially also the focus of the French radio astronomy teams at the École Normale Supérieure and the Institut d'Astrophysique in Paris. In 1954 the former team transferred to the Paris Observatory. Early observations were made mainly with small steerable dishes and recycled WWII Würzburg antennas (see Orchiston and Steinberg, 2007; Orchiston, et al., 2007; Orchiston, et al., 2009), but by 1957 two multi-element E-W grating arrays—inspired by Christiansen's efforts at Potts Hill—were operational at Nançay (see Denisse, 1984).

In post-war Netherlands, the main interest of the fledgling radio astronomy group was galactic and extra-galactic research, especially that associated with the 21cm hydrogen line (Van Woerden and Strom, 2006), but the Government's Post, Telephone and Telegraph department ran a multi-wavelength solar monitoring program using two ex-WWII Würzburg antennas, a 10-m dish, a corner reflector and a simple 2-element interferometer (see Strom, 2005).

One other nation to intensively research solar radio astronomy in the decade following WWII was the Soviet Union, commencing with solar eclipse observations in 1947. The following year radio astronomy began at the P.N. Lebedev Physical Institute, and by the mid-1950s a number of solar radio telescopes were operational. These comprised stand-alone dishes—including a Würzburg antenna (Dagkesamanskii, 2007)—and interferometers, some of novel design. One of these was the Big Pulkovo Radio Telescope, which began operations in 1956 under the auspices of the newly-formed Department of Radio Astronomy at the Main Astronomical Observatory in Pulkovo (Parijskij, 2007). Other institutes which ran solar radio astronomy research programs in the mid-1950s were the Byurakan Astrophysical Observatory in Armenia; the Crimean Astrophysical Observatory; the Institute of Terrestrial Magnetism, Ionosphere and Radio Wave Propagation in Moscow; and the Radiophysical Research Institute in Gorky (see Salomonovich, 1984).

This brief review reveals that by 1957 a number of nations had grating interferometers analogous to the Potts Hill arrays, but the first institution to develop a crossed-grating interferometer like the Chris Cross was Stanford University in the USA. This became operational in 1960, and is discussed in Bracewell and Swarup (1961) and Bracewell (2005).

6.2 Heritage Considerations

Between 1945 and 1965, at one time or another the CSIRO's Division of Radiophysics maintained radio astronomy field stations at Badgerys Creek, Bankstown Airport, Dover Heights, Fleurs, Georges Heights, Murraybank, Penrith, and Potts Hill in or near Sydney, and at Dapto near Wollongong, and a number of associated remote sites near Sydney and up and down the New South Wales coast (see Orchiston and Slee, 2005; Stewart, 2009; Wendt, 2008). In 2004, one of us (WO) wrote:

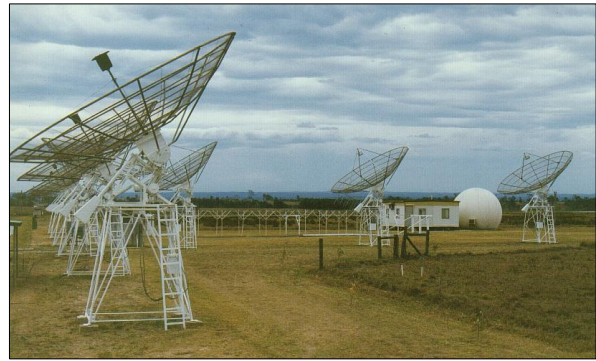

Figure 50: A view looking west showing nine of the twelve refurbished Chris Cross antennas (courtesy John Leahy).

Important radio telescopes, many of novel design, were sited at these field stations, and pioneering studies were undertaken in solar, galactic and extra-galactic radio astronomy. It is a sobering fact that of all of these radio telescopes, the only ones that have managed to survive through to the present day are the twelve central elements from the Chris Cross at Fleurs. (Orchiston, 2004: 161).

It is frightening to realise that later that very year the twelve restored Chris Cross antennas were bulldozed (Figure 52), highlighting the extreme vulnerability of our radio astronomical heritage. Most optical telescopes that have made important contributions to science are cherished and preserved for posterity, but the same sentiment rarely applies to radio telescopes. All too often, they are viewed merely as tools used to address specific research problems, and their importance as heritage instruments *per se* is ignored. If we are to make any progress in preserving our radio astronomical heritage we must urgently address and reverse this prevailing mind-set.

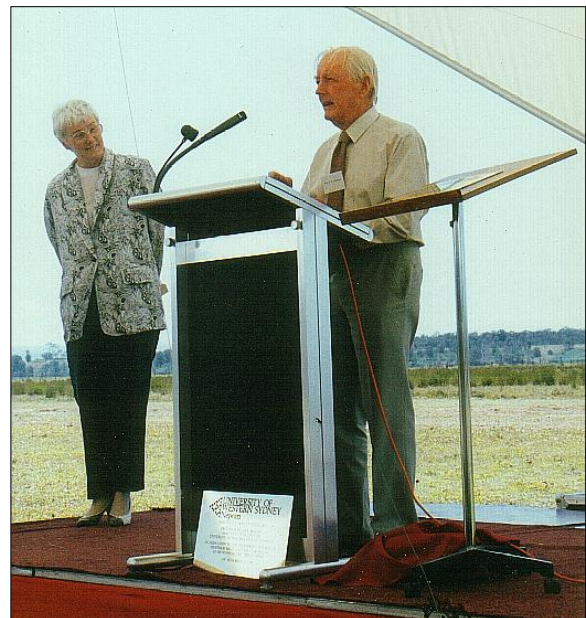

Figure 51: Professor Christiansen speaking at the 22 November 1991 ceremony at Fleurs (courtesy John Leahy).

The Chris Cross may have disappeared entirely from the Fleurs landscape, but by a strange twist of fate at least two of the aerials have survived in close to their original condition (see Figure 53). They were acquired from the University of Western Sydney by amateur astronomer and SETI enthusiast, Leon Darcy, and are

now located at Bungonia in the Southern Highlands of New South Wales where they are used for interferometry (D. Whiteman, pers. comm., 2004). In addition, the Astronomical Society of New South Wales has been restoring a Chris Cross antenna which is located at their Wiruna Dark Sky Site a 3hr drive west of Sydney (see www.asnsw.com/wiruna/rt.asp).



Figure 52: The bulldozed remains of some of the preserved Chris Cross aerials (courtesy John Leahy).

7 CONCLUDING REMARKS

The Chris Cross is a remarkable radio telescope with a memorable history. When constructed in 1957 it was the world's first cross-grating interferometer, and the first radio telescope to provide daily two-dimensional radio maps of the Sun. Its obvious research potential and innovative design subsequently inspired the construction of similar radio telescopes in other countries.

Despite this, with the benefit of hind-sight, Christiansen (1984: 124) had a rather modest perception of the significance of the solar investigations carried out with the Chris Cross:

They led to a better understanding of the Sun's outer atmosphere, but to no spectacular discoveries. Their real excitement was in the development of new instruments superior in resolving power to any in existence.

We think he was a tad too modest!



Figure 53: Leon Darcy's 2-element interferometer at Bungonia, which utilises two ex-Chris Cross antennas and mountings (courtesy Don Whiteman).

As a significant component of the Fleurs Compound Interferometer and, later, the Fleurs Synthesis Telescope, the Chris Cross also played a key role in international non-solar radio astronomy, providing new per-

spectives on discrete radio sources, but particularly large radio galaxies, supernova remnants and emission nebulae.

With the advent of The Australia Telescope in 1988 the FST was closed down as a research instrument, but it did serve for a time as a teaching instrument. However, the various antennas continued to rust, and in 1991 a decision was made by the then custodians of the array to restore and preserve the twelve antennas at the centre of the Chris Cross along with one of the six 13.7m FST antennas. Yet this only served as a temporary reprieve: the Fleurs field station was finally closed in 1998 and less than a decade later the landowner made a unilateral decision to bulldoze the restored Chris Cross antennas and their mountings, thereby bringing to a sudden and tragic end one of the world's most remarkable solar radio telescopes. Subsequent to this inglorious event, two of the 13.7m FST antennas were relocated to the Australia Telescope National Facility headquarters at Marsfield, Sydney (as part of SKA experimentation), and all that now remains at Fleurs to remind visitors of the invaluable contributions that the Chris Cross, Mills Cross and Shain Cross made to international radio astronomy (see Orchiston and Slee, 2002) are the four remaining rusting large dishes associated with the FST.

8 NOTES

1. In the past, both authors had close associations with the Chris Cross. Don Mathewson was involved in the construction and early operation of the Cross, while Wayne Orchiston used the Cross and produced the daily solar maps during the final year that this radio telescope was maintained by the CSIRO's Division of Radiophysics, before it was handed over to the University of Sydney.
2. "Taffy" was Dr E.G. (Taffy) Bowen, Chief of the Division of Radiophysics.
3. The original plan was to install the Kennedy Dish at the Murraybank field station, and use it for H-line research (see Wendt, 2008).
4. By the time routine Fleurs Compound Interferometer observations began, Christiansen had already left the Division of Radiophysics and accepted a Chair in the School of Electrical Engineering at the University of Sydney. For the background to this transfer see Sullivan (2005).
5. This is discussed in the letter reproduced here in the Appendix.

9 ACKNOWLEDGEMENTS

We are grateful to the Australia Telescope National Facility, Dr John Leahy (CSIRO Telecommunications and Industrial Physics) and Don Whiteman (Astronomical Society of New South Wales) for kindly supplying Figures 1, 3, 8-10, 12-14, 18-21, 31, 38, 42-43 and 48-56. We also wish to thank Professor Bruce Slee (Australia Telescope National Facility, and Centre for Astronomy, James Cook University), Ron Stewart (Centre for Astronomy, James Cook University), Professor Richard Strom (ASTRON, the Netherlands, and Centre for Astronomy, James Cook University) and Dr Harry Wendt (Centre for Astronomy, James Cook University) for reading and commenting on the manuscript.

10 REFERENCES

- Aerials at "Fleurs" Field Station (1964). National Archives of Australia (Sydney): A1/3/1.
- Athay, R.G., and Moreton, G.E., 1961. Impulsive phenomena of the solar atmosphere. I. Some optical events associated with flares showing explosive phase. *Astrophysical Journal*, 133, 935-945.
- Bracewell, R., 2005. Radio astronomy at Stanford. *Journal of Astronomical History and Heritage*, 8, 75-86.
- Bracewell, R.N., and Swarup, G., 1961. The Stanford microwave spectroheliograph antenna, a microsteradian pencil beam antenna. *IRE Transactions on Antennas Propagation*, AP-9, 22-30.
- Christiansen, W.N., 1953. A high-resolution aerial for radio astronomy. *Nature*, 171, 831-833.
- Christiansen, W.N., 1960. Letter to E.G. Bowen, dated 15 September. National Archives of Australia (Sydney): A1/3/1.
- Christiansen, W.N., 1967. Techniques for decimetre wavelength observations of radio plages and bursts. *Proceedings of the Astronomical Society of Australia*, 1, 55.
- Christiansen, W.N., 1984. The first decade of solar radio astronomy in Australia. In Sullivan, 113-131.
- Christiansen, W.N., and Mathewson, D.S., 1958. Scanning the Sun with a highly directional array. *Proceedings of the Institute of Radio Engineers*, 46, 127-131.
- Christiansen, W.N., and Mathewson, D.S., 1959. The origin of the slowly varying component. In Bracewell, R.N. (ed.). *Paris Symposium on Radio Astronomy*. Stanford, Stanford University Press. Pp. 108-117.
- Christiansen, W.N., and Mullaly, R.F., 1963. Solar observations at a wavelength of 20 cm with a crossed-grating interferometer. *Proceedings of the Institution of Radio Engineers, Australia*, 2, 165-173.
- Christiansen, W.N., and Warburton, J.A., 1953. The distribution of radio brightness over the solar disk at a wavelength of 21 cm. I. A new highly directional aerial system. *Australian Journal of Physics*, 6, 190-202.
- Christiansen, W.N., and Warburton, J.A., 1955a. The distribution of radio brightness over the solar disk at a wavelength of 21 cm. III. The quiet Sun—two-dimensional observations. *Australian Journal of Physics*, 8, 474-486.
- Christiansen, W.N., and Warburton, J.A., 1955b. The Sun in two-dimensions at 21cm. *The Observatory*, 75, 9-10.
- Christiansen, W.N., Mathewson, D.S., and Pawsey, J.L., 1957. Radio pictures of the Sun. *Nature*, 18, 944-946.
- Christiansen, W.N., Yabsley, D.E., and Mills, B.Y., 1949a. Eclipse observations of solar radiation at a wave-length of 50 cm. *Nature*, 164, 635-637.
- Christiansen, W.N., Yabsley, D.E., and Mills, B.Y., 1949b. Measurements of solar radiation at a wavelength of 50 centimetres during the eclipse of November 1, 1948. *Australian Journal of Scientific Research*, 2, 506-523.
- Christiansen, W.N., Labrum, N.R., McAlister, K.R., and Mathewson, D.S., 1961. The crossed-grating interferometer: a new high-resolution radio telescope. *Proceedings of the Institution of Electrical Engineers*, 108B, 48-58.
- Covington, A.E., 1984. Beginnings of solar radio astronomy in Canada. In Sullivan, 317-334.
- Dagkesamanskii, R.D., 2007. The Pushchino Radio Astronomy Observatory: origin and first decade's history. *Astronomische Nachrichten*, 328, 395-404.
- Denise, J.L., 1984. The early years of radio astronomy in France. In Sullivan, 303-315.
- Drake, F.D., 1959. *Annual Report of the National Radio Astronomy Observatory*. Greenbank, NRAO.
- Gum, C.S., and Pawsey, J.L., 1960. Radio data relevant to the choice of a galactic coordinate system. *Monthly Notices of the Royal Astronomical Society*, 121, 150-163.
- Hachenberg, O., and Wallis, G., 1961. Das Spektrum der Bursts der Radiofrequenzstrahlung der Sonne im cm-Wellenbereich. *Zeitschrift für Astrophysik*, 52, 42-72.
- Krishnan, T., and Labrum, N.R., 1961. The radio brightness distribution on the Sun at 21 cm from combined eclipse and pencil-beam observations. *Australian Journal of Physics*, 14, 403-419.
- Krishnan, T., and Mullaly, R.F., 1961. Decimetre radio bursts concurrent with solar Type IV radiation. *Nature*, 192, 58-59.
- Krishnan, T., and Mullaly, R.F., 1962. The decimetre wavelength radiation associated with Type IV solar radio bursts. *Australian Journal of Physics*, 15, 85-95.
- Labrum, N.R., 1960. The radio brightness of the quiet Sun at 21 cm wavelength near sunspot maximum. *Australian Journal of Physics*, 13, 700-711.
- Labrum, N.R., Harting, E., Krishnan, T., and Payten, W.J., 1963. A compound interferometer with a 1.5 minute of arc fan beam. *Proceedings of The Institution of Radio Engineers, Australia*, 2, 148-155.
- Labrum, N.R., Krishnan, T., Payten, W.J., and Harting, E., 1964. Fan-beam observations of radio sources at 21cm wavelength. *Australian Journal of Physics*, 17, 323-339.
- Mills, B.Y., 1984. Radio sources and the log N – log S controversy. In Sullivan, 147-165.
- Mills, B.Y., and Little, A.G., 1953. A high-resolution aerial system of a new type. *Australian Journal of Physics*, 6, 272-278.
- Mullaly, R.F., 1961. Evidence for the transfer of corpuscles to distant parts of the Sun following a solar radio burst. *Australian Journal of Physics*, 14, 540-543.
- Mullaly, R.F., and Krishnan, T., 1963. Solar decimetre radio bursts. *Australian Journal of Physics*, 16, 8-23.
- Orchiston, W., 2004. The rise and fall of the Chris Cross: a pioneering Australian radio telescope. In Orchiston, W., Stephenson, R., Débarbat, S., and Nha, I.-S. (eds.). *Astronomical Instruments and Archives From the Asia-Pacific Region*. Seoul, IAU Commission 41. Pp. 157-162.
- Orchiston, W. (ed.), 2005. *The New Astronomy: Opening the Electromagnetic Window and Expanding our View of Planet Earth*. Dordrecht, Springer.
- Orchiston, W., and Slee, B., 2002. The flowering of Fleurs: an interesting interlude in Australian radio astronomy. *ATNF News*, 47, 12-15.
- Orchiston, W., and Slee, B., 2005. The Radiophysics field stations and the early development of radio astronomy. In Orchiston, 119-168.
- Orchiston, W., and Steinberg, J.-L., 2007. Highlighting the history of French radio astronomy. 2: the solar eclipse observations of 1949-1954. *Journal of Astronomical History and Heritage*, 10, 11-19.
- Orchiston, W., Lequeux, J., Steinberg, J.-L., and Delannoy, J., 2007. Highlighting the history of French radio astronomy. 3: the Würzburg antennas at Marcoussis, Meudon and Nançay. *Journal of Astronomical History and Heritage*, 10, 221-245.
- Orchiston, W., Steinberg, J.-L., Blum, J.-E., Pick, M., and Boischot, A., 2009. Highlighting the history of French radio astronomy. 4: early solar research at the École Normale Supérieure, Marcoussis, and Nançay. *Journal of Astronomical History and Heritage*, 12, in press.
- Parijskij, Y.N., 2007. The Big Pulkovo Radio Telescope and Pulkovo radio astronomy. *Astronomische Nachrichten*, 328, 405-410.
- Salomonovich, A.E., 1984. The first steps of Soviet radio astronomy. In Sullivan, 268-288.
- Smith, F.G., 2007. Early Cambridge radio astronomy. *Astronomische Nachrichten*, 328, 426-431.
- Stewart, R.T., 2009. Contribution of the CSIRO Division of Radiophysics Penrith and Dapto Field Stations to International Solar Radio Astronomy. Ph.D. Thesis, Centre for Astronomy, James Cook University.
- Strom, R., 2005. Radio astronomy in Holland before 1960: just a bit more than HI. In Orchiston, 93-106.
- Sullivan III, W.T. (ed.), 1985. *The Early Years of Radio Astronomy. Reflections Fifty Years after Jansky's Discovery*. Cambridge, Cambridge University Press.

- Sullivan III, W.T., 2005. The beginnings of Australian radio astronomy. *Journal of Astronomical History and Heritage*, 8, 11-32.
- Takakura, T., 1960. Microwave bursts of solar radio emission. *Publications of the Astronomical Society of Japan*, 12, 55-62.
- Tanaka, H., 1984. Development of solar radio astronomy in Japan up until 1960. In Sullivan, 335-348.
- The Fleurs Synthesis Telescope. Special issue of the *Proceedings of the Institution of Radio and Electronic Engineers Australia*, 34(8), 301-355 (1973).
- Twiss, R.Q., Carter, A.W.L., and Little, A.G., 1960. Brightness distribution over some strong radio sources at 1427 Mc/s. *The Observatory*, 80, 153-159.
- Twiss, R.Q., Carter, A.W.L., and Little, A.G., 1962. Radio source interferometry at 1427 Mc/s. *Australian Journal of Physics*, 15, 378-386.
- Van Woerden, H., and Strom, R.G., 2006. The beginnings of radio astronomy in the Netherlands. *Journal of Astronomical History and Heritage*, 9, 3-20.
- Wendt, H., 2008. The Contribution of the CSIRO Division of Radiophysics Potts Hill and Murraybank Field Stations to International Radio Astronomy. Ph.D. Thesis, Centre for Astronomy, James Cook University.
- Wendt, H., Orchiston, W., and Slee, B., 2008a. The Australian solar eclipse expeditions and 1947 and 1949. *Journal of Astronomical History and Heritage*, 11, 71-78.
- Wendt, H., Orchiston, W., and Slee, B., 2008b. W.N. Christiansen and the development of the solar grating array. *Journal of Astronomical History and Heritage*, 11, 173-184.
- Wendt, H., Orchiston, W., and Slee, B., 2008c. W.N. Christiansen and the initial Australian investigation of the 21cm hydrogen line. *Journal of Astronomical History and Heritage*, 11, 185-193.

11 APPENDIX

The following letter, dated 15 September 1960, from Professor W.N. Christiansen to Dr E.G. Bowen, discusses the development of the Fleurs Compound Interferometer, and is reproduced here in full.

Dear Dr Bowen,

At your suggestion, and before I leave for Holland, I am setting down the arrangements which were made in connection with the new multi-aerial interferometer at Fleurs, on which I was working before I left the Division of Radiophysics. These arrangements were made at a meeting in May at which you and Dr. Pawsey and I discussed the possibility of co-operation in research between your Division and the School of Electrical Engineering at the University of Sydney. At this meeting we decided that I should have no responsibility for the solar work being conducted at Fleurs but should be available for advice if required.

We decided, also, that the new project, which involves a combination of a grating interferometer with a 60' paraboloid and the extensive use of preamplifiers to improve the sensitivity of the equipment, should be carried out jointly, under the direction of Dr. Pawsey, by your Division and the School of Electrical Engineering. The purpose of this work is to produce a system which has a single fan-beam of angular dimensions $\sim 1^\circ$ and adequate sensitivity (roughly equal to that of the two-aerial interferometer of the California Institute of Technology) for a detailed study of the shapes of radio sources.

The time-table which was suggested involved about one year's observations after the completion of the instrument. It was thought probable that, at the end of this time, the 60' paraboloid would be removed to Parkes.

I consulted the Vice-Chancellor of the University on this co-operative venture and obtained his approval. Subsequently I arranged for two people on the lecturing staff of the School, Murray and Docherty, to work on this project. So far they have spent what time was available to them on the aspects of the work which involve the measurement and adjustment of the relative phases of the different aerials of the system. In addition I have obtained the approval of the Vice-Chancellor to engage an electrical technician for a period of one year; the technician will spend all of his time on this project.

It appears that good progress has been made on the project, and I am confident that it will be successful. I hope that it will provide a pattern for future co-operative ventures of the Division of Radiophysics and the School of Electrical Engineering.

Yours sincerely

Dr Wayne Orchiston is a Reader in the Centre for Astronomy at James Cook University, and is particularly interested in the history of radio astronomy in Australia, France and New Zealand. He is editor of the book *The New Astronomy: Opening the Electromagnetic Window and Expanding our View of Planet Earth* (Springer, 2005) which contains various papers on the history of radio astronomy, and chairs the IAU Working Group on Historic Radio Astronomy.

Don Mathewson joined Chris Christiansen at Fleurs in 1955, and helped him build the Chris Cross. Don lived at Fleurs with the Division of Radiophysics construction team, comprising Charlie Chenhall, Sid Hucker, Bill and George Coulter and Charlie Turrell. One of the proudest moments in Don's life was when he was invited into St. Marys to join them for their after-work beers and later to share their evening meals in a gypsy-style caravan parked on site at Fleurs. Life was not exactly 'a bed of roses': ten-hour days were the norm; the tents were draughty; there was only rainwater on site; an overhead bucket with a tap served as a shower, although everybody mostly used a large wash basin on the tank stand; a chocolate wheel was our toilet; all meals were cooked on 'Elsie' an old woodstove sheltered from the elements by corrugated iron; and any differences were settled by fisticuffs, generally after dinner—all very gentlemanly (and all very Australian)!

Don left Fleurs in August 1958 and presented some of the Chris Cross results at the Paris Symposium on Radio Astronomy. Then he spent several years at Jodrell Bank using the newly-commissioned 250ft Dish. During this time he visited Bologna University three times as a consultant for the Italian Northern Cross antenna which was inspired by the Chris Cross.

Returning to Australia, Don went back to Fleurs with two physics students, John Healey and John Rome, and used the 60ft (Kennedy) Dish at the eastern end of the Chris Cross to survey the Milky Way at 20cm. Later this map was regularly used as a finding chart for the Parkes Dish.

After three years at Parkes, Don worked in the US and Holland and then joined Mount Stromlo and Siding Spring Observatories, which he directed from 1977 to 1986. In 1995 he was farewelled at the Heron Island Workshop on Large Scale Motions in the Local Universe, although he remained active in astronomy as a Vice President of the IAU.

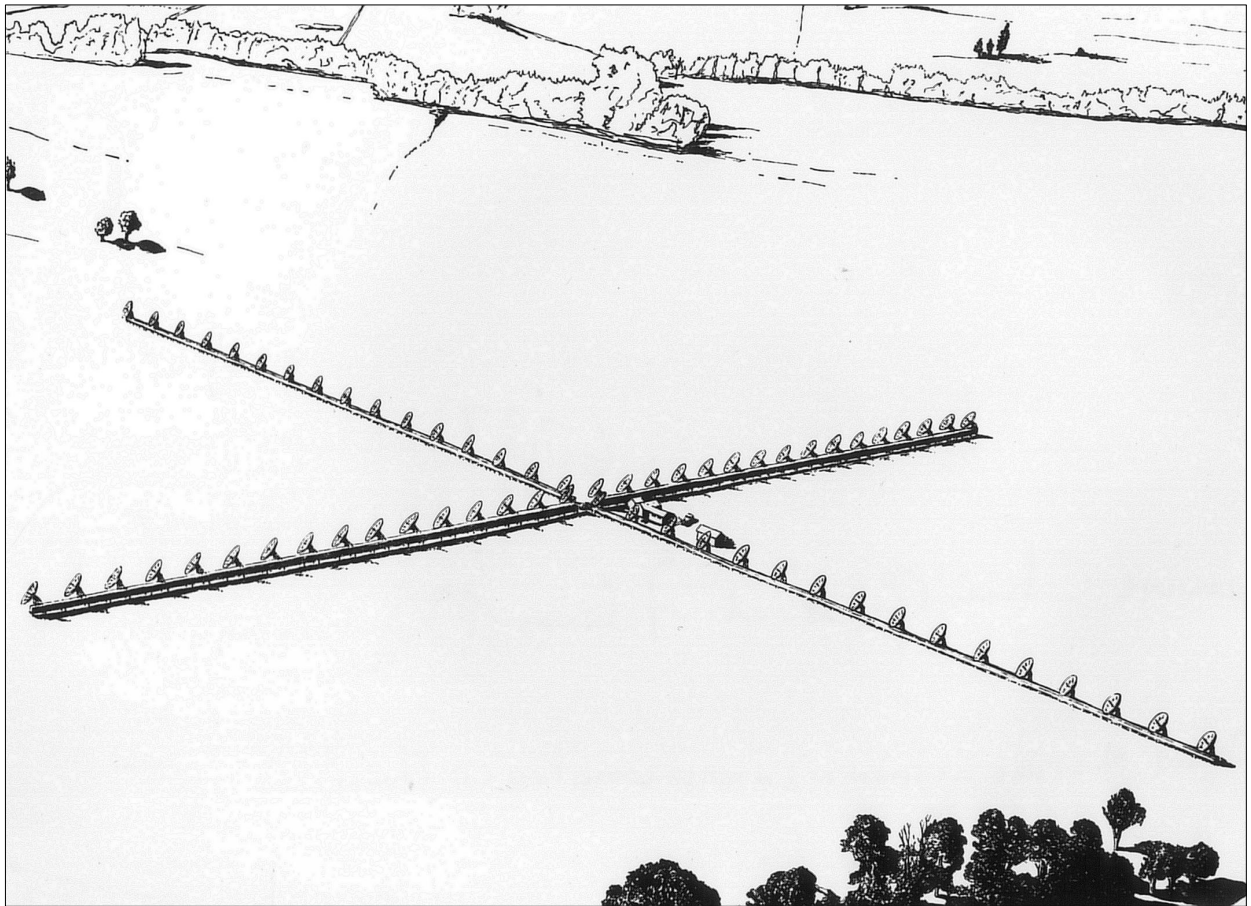

Figure 2: Schematic aerial view of the Chris Cross, looking north-east (after Christiansen et al., 1961: 49).

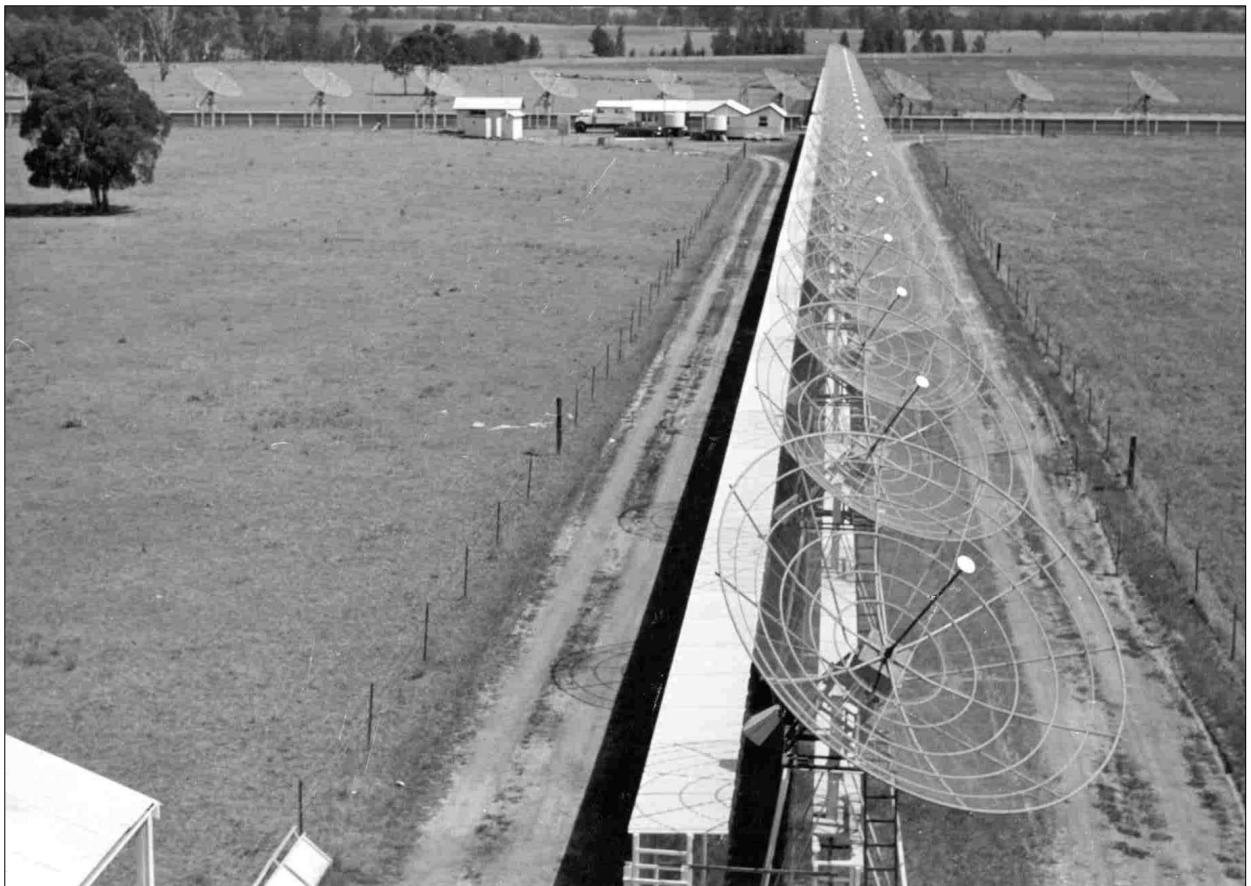

Figure 3: View from the eastern end of the E-W arm of the Chris Cross looking west towards the N-S arm and the receiver hut (courtesy ATNF Historic Photographic Archive).

The new radio telescope, affectionately known as the ‘Chris Cross’, was the world’s first crossed-grating interferometer, and was constructed at the Fleurs field station in 1957 (Orchiston, 2004). Christiansen et al. (1961: 48) described the Chris Cross as

...a novel solution to the problem of attaining high angular resolution at reasonable cost. Operating at a wavelength of 21 cm, it provides, for the first time sufficient discrimination in two dimensions to permit the production of ‘radio pictures’ of the sun, i.e. detailed maps of the radio-brightness distribution over the solar disk ...

In a short paper submitted to *Nature* announcing the completion of this new radio telescope, Christiansen, Don Mathewson and Joe Pawsey (1957) drew on optical analogues in calling the Chris Cross a “radioheliograph”.

In this paper we discuss its design, construction, observational programs and research outcomes, before briefly examining its subsequent development into the Fleurs Synthesis Telescope and the preservation and ultimate demise of this historic radio telescope.¹

2 THE CHRIS CROSS

2.1 The Concept

The Chris Cross consisted of 378 m long N-S and E-W arms, each containing 32 equatorially-mounted parabolic antennas 5.8m in diameter and spaced at 12.3m intervals (Figures 2 and 3). Antennas in the N-S arm produced a series of E-W fan beams, and antennas in the E-W arm a series of N-S fan beams. Combining the signals from the two arrays in phase and out of phase produced a network of pencil beams at the junction points of the fan beams. Each pencil beam was ~3 arc minutes in diameter, and was separated from its neighbours by 1°. Since the Sun has an angular diameter of 30 arc-minutes, it was only possible for one pencil beam to fall on the Sun at any one time (see Figure 4).

In an informative paper titled “The crossed grating interferometer: a new high-resolution radio telescope”, Christiansen et al. (1961: 51-52) assign almost a page to the “Choice of Equipment Parameters”. They explain that the array operated at 1423 MHz because radio plages are prominent at this frequency. The ability to resolve these radio plages dictated the size of the pencil beams, but an unfortunate feature of the crossed-array design is that the side lobes associated with individual pencil beams are up to 20% of the main response (see Figure 5a). In order to reduce this to acceptable levels (i.e. <3%), it is necessary to taper the currents in the N-S and E-W arrays from the centre of the Cross out to the end antennas in each arm (see Figure 5b). Meanwhile, the length of each of the arms of the Cross is dictated by the diameter of the pencil beams. However, this is an over-simplification:

For a beam width of 3', an aperture of $1\ 800\lambda$, or 380 m (about 1 200 ft) is required. In directions away from the zenith, the beam width is increased by the foreshortening of the arrays. This deterioration can be almost eliminated in the case of the east-west array by restricting the observations each day to a period within about two hours of transit; some broadening of the north-south array beams must, however, be accepted in the winter months. In the latitude of Sydney, the zenith

distance of the sun at transit is 56° at the winter solstice. The effective aperture of the north-south array in that direction is $1\ 030\lambda$, and the width of the pencil beam in the north-south plane is then $5.4'$. If the receiver bandwidth is excessive, a further loss of directivity occurs at large zenith distances ... a compromise ... value of 300 kc/s was adopted ... [and] this spreads the aerial beam by a further $1.1'$ at zenith distance 56° , so that, for mid-winter solstice observations, the pencil beam is $5.4'$ wide in the north-south plane. At mid-summer the corresponding beam width is $3.1'$. (Christiansen et al., 1961: 51).

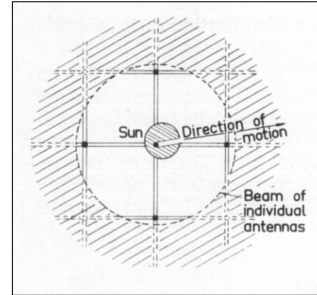

Figure 4: The network of pencil beams (after Christiansen et al., 1957: 945).

The 1° separation of the pencil beams, θ_1 , in Figure 4 determined the distance, d , between the individual antennas in the orthogonal arrays, according to the formula

$$\theta_1 = \frac{\lambda}{d \cos \theta} \quad (1)$$

where λ is the wavelength and θ is the angle between the normal to the system and the direction of the ray. Given the angular diameter of the Sun, the minimum value of θ_1 was set at 1° , which provided a spacing of $d = 58\lambda$, or 12.3m (i.e. 40ft).

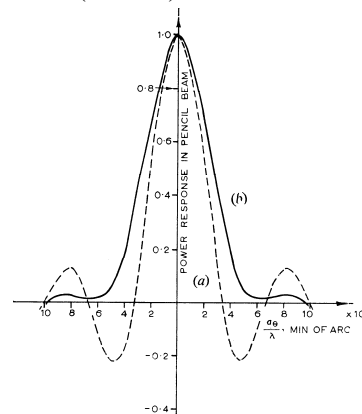

Figure 5: Polar diagrams showing the pencil beam responses at the zenith for (a) uniform arrays, and (b) arrays with tapered current distribution (after Christiansen et al., 1961: 51).

The ideal diameter of the parabolic aerials in the two orthogonal arrays was primarily determined by sensitivity considerations, on the basis that

... the overall sensitivity of the system should be such that the pencil-beam signal due to quiet sun radiation alone would give a receiver output equal to 15 times the r.m.s. noise fluctuations ... If the efficiency of [a dipole-fed parabolic reflector] ... is taken as 0.5 (a fairly low estimate), the required reflector diameter for the elements of the interferometer array is 5.8 m (19 ft). (Christiansen et al., 1961: 52).

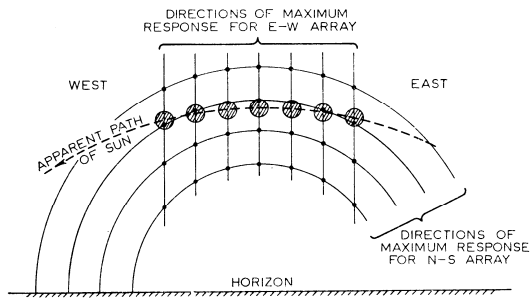

Figure 6: Movement of the Sun through the Chris Cross pencil beams (after Christiansen et al., 1961: 51).

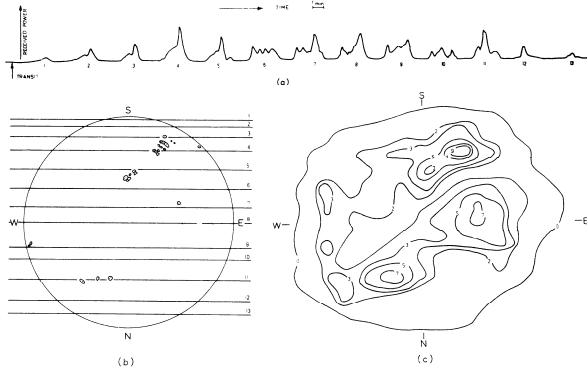

Figure 7: Diagram showing (a) a succession of 13 E-W scans, (b) their corresponding positions on the solar disk, and (c) the resulting isophote map (adapted from Christiansen and Mullaly, 1963: 170).

In principle, the basic operation of the Chris Cross was simple: as the Earth rotated, the network of pencil beams shown in Figure 6 moved together across the sky and different pencil beams scanned successive strips of the Sun, producing a series of E-W profiles (Figure 7). In reality, the scanning process was accelerated by shifting the pencil beams in declination, "... so as to maintain a space about equal to the beam width between adjacent scans." (Christiansen et al., 1961: 51). This was accomplished by using a phase-shifting mechanism on the N-S arm of the Cross so that it only took about half an hour for the whole Sun to be scanned. In this way, "The distribution of radio emissivity over the solar disk is thus determined in a direct, rapid and unambiguous fashion." (Christiansen et al., 1961: 49).



Figure 8: Loading the Chris Cross test antenna onto a truck at the RP Workshop, ready for its transfer to Potts Hill field station (courtesy ATNF Historic Photographic Archive: B3858-3).

2.2 The Prototype Antenna at Potts Hill

Apart from providing the inspiration for the Chris Cross, the Potts Hill field station had one other important link with this new radio telescope: it provided a suitable site where a prototype of the aerial could be erected and thoroughly tested. A 5.8m antenna was constructed in the Workshop at the Radiophysics headquarters in the grounds of the University of Sydney and on 25 November 1956 it was loaded onto a truck (Figure 8) and transported by road the 16km to Potts Hill where it was subsequently erected alongside the original N-S grating array (see Figure 9).

2.3 Construction of the Chris Cross

By 1956 the Potts Hill field station was starting to experience significant interference at 1420 MHz, and there was insufficient land there anyway, so another site had to be found for the new solar crossed-grating interferometer. Fleurs field station (Orchiston and Slee, 2002) was the obvious choice. It was a relatively radio-quiet location, accessible by car from Sydney, a suitable flat site, and already boasted two cross-type radio telescopes: the 85 MHz Mills Cross, constructed in 1954, and the much larger 19.7 MHz Shain Cross, which was erected in 1956 (Figure 10). The Chris Cross would be in good company!



Figure 9: The Chris Cross test antenna at Potts Hill (second from right), shown between elements in the N-S grating array (courtesy ATNF Historic Photographic Archive: B3881-2).

From the time of his return to Sydney in early 1955, Christiansen lobbied relentlessly for his new cross telescope, and although formal approval was granted, progress was painfully slow when it came to the actual construction. As one of the authors (DM) reminisces, Christiansen liked to get results and his eventual response was typical:

Late 1955 I joined Chris at RP helping him to build his Chris Cross at Fleurs. We worked at Potts Hill on the prototype, testing the various designs. But in 1956 although RP had funded the Cross, no construction work had started.

One day Chris said to me, "We're going to Fleurs to build the Cross." Joined by a secretary from the Office, we put a theodolite and sledgehammer in the back of a battered old RP truck, picked up from a nearby factory hundreds of starposts, and bumped and rattled our way out to Fleurs. Joined by Charlie Higgins, we spent the next four days hammering in the starposts to build the fence surrounding the Chris Cross.

At the end of the week, exhausted and covered in blisters, we sat in the back of the truck surveying our handiwork. Chris was dressed in khaki shorts and shirt with a battered old sunhat perched on the back of his head. As he rolled a cigarette, he drily remarked, "That's the straightest fence that's ever been built. On Monday I'll send Taffy² our wages bill for the week and how much it would cost if we continued to build the whole Cross." Next week six workman had been assigned to the task and construction of the Chris Cross started!

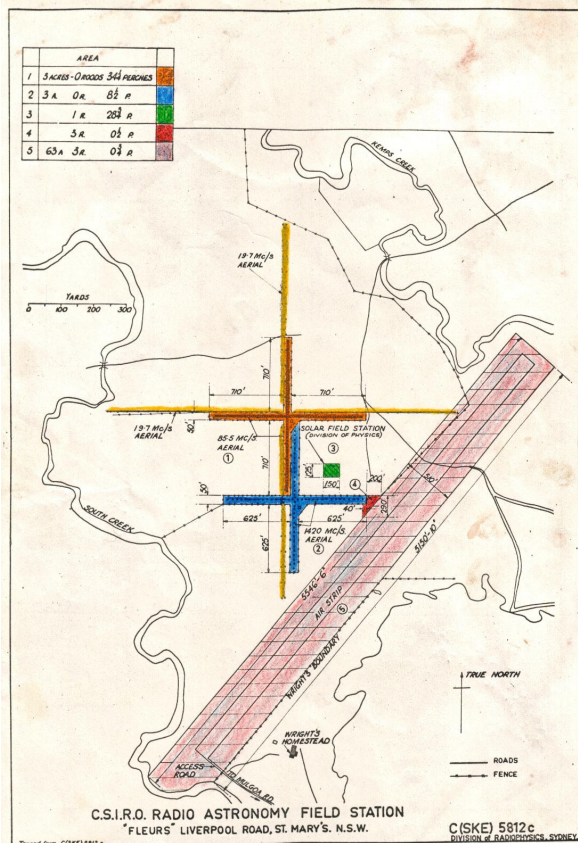

Figure 10: The Fleurs field station showing the disused WWII air strip (pink) extending from Kemps Creek in the east to South Creek in the west, and the positions of the Mills Cross (dark brown), Shain Cross (pale brown) and Chris Cross (blue) (courtesy ATNF Historic Photographic Archive).

Christiansen et al (1961: 52) emphasized that

In designing the aerials and the feeders, which together account for most of the cost of the instrument, it was important to aim at the cheapest possible construction consistent with the required performance and durability.

Just as he had done previously with the Potts Hill grating arrays and the Fleurs Mills Cross, RP's resident Engineer, Keith McAlister, responded brilliantly to this design challenge. Each 5.8m diameter aerial had a focal length of 1.9m (6ft 3in) and was composed of 12.7mm (half-inch) galvanised wire mesh on a tubular aluminium framework. The dipole and its reflector plate were at the end of a metal tube which was attached to the centre of the antenna. A twin-wire transmission line ran from the dipole down the inside of this metal tube. As Figures 11 and 12 reveal, each aerial was attached to an equatorial mounting which contained declination and hour angle scales to permit careful pointing of the aerial. The equatorial mounting

was attached to the top of a tubular steel frame-work which has four feet bolted to concrete blocks that were set in the ground.

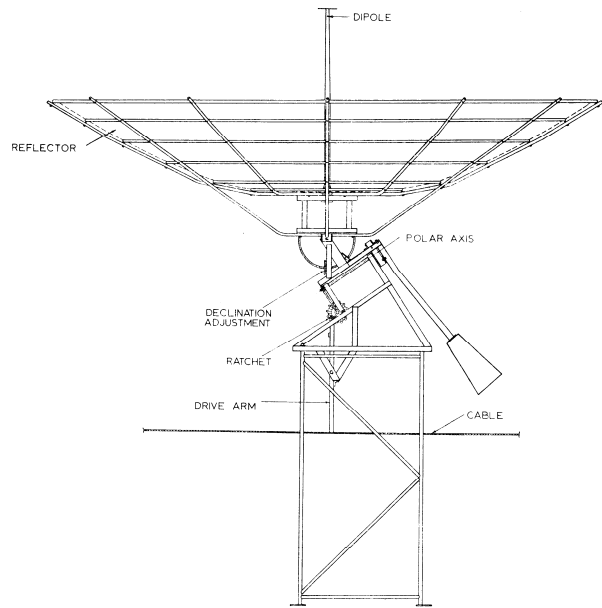

Figure 11: Engineering drawing of a Chris Cross antenna, equatorial mounting and supporting tower (after Christiansen et al., 1961: 53).

Construction of the Chris Cross took place on-site, with the parabolas fabricated on the ground (Figure 13) while at the same time their supporting towers and equatorial mountings were assembled and installed within "... the straightest fence that's ever been built". Each antenna was then moved to its designated mounting (Figure 14), and subsequently they were all hoisted into position.



Figure 12: Close-up of the equatorial mounting, showing the hour angle circle, the white declination sector and the ratchet wheel used to drive the aerial when observing the Sun (courtesy ATNF Historic Photographic Archive: B5804-4).



Figure 13: Aerial view showing huts, cylindrical frames and the antenna assembly area of the new Chris Cross, located very close to the central point of the Cross (courtesy ATNF Historic Photographic Archive: B5042-2).

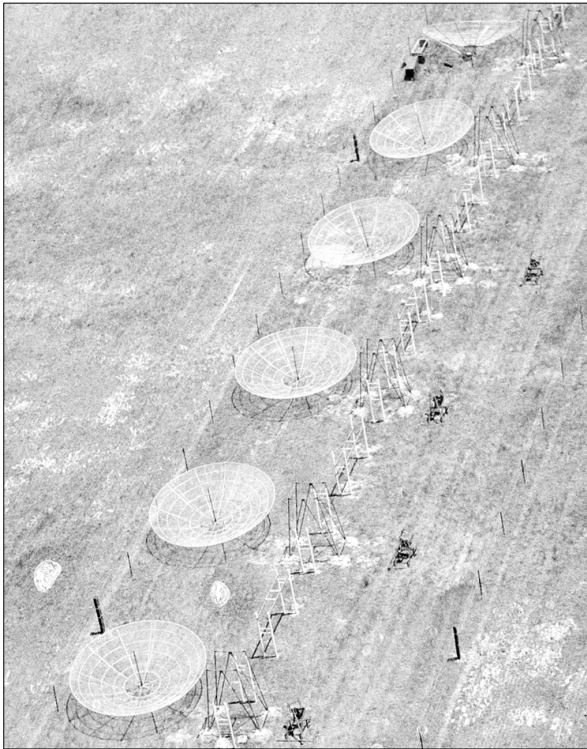

Figure 14: The assembled Chris Cross antennas alongside their partially-completed mounts (courtesy ATNF Historic Photographic Archive: B5042-4).

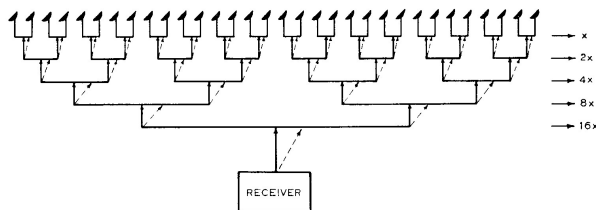

Figure 15: The branched feeder system of the N-S arm of the Chris Cross. The dashed arrows show the movements required in the T-junctions at each level in order to change the relative feeder lengths for adjacent aerials by an amount of $2x$ (after Christiansen et al., 1961: 53).

The transmission lines from the different aerials were connected to tensioned copper wire feeders supported by polythene insulators spaced at 5.5m (18ft) intervals. Christiansen et al. (1961: 53) noted that

Because of the great electrical length of the feeder lines (the outermost aerials in each array are over 900 wavelengths from the receiver), care must be taken to prevent phase shifts between the signals from the various elements due either to thermal expansion of the lines or to changes in atmospheric humidity. These effects are minimized by using a branching system of transmission lines with equal lengths of line between all the aerials and the receiver. Any change in the electrical length thus affects all the aerials equally.

Five twin feeder lines mounted one above the other were run the length of each array. The aerials were connected in pairs to sections of the top twin line, and each of these sections was then connected via a T-junction at its mid-point to the twin line below, and so on. A schematic view of this branched feeder system is shown in Figure 15.

The total length of twin-feeder line from each aerial to the central receiver was about 183m (i.e. 600ft), and included five different T-junctions. The design of these T-junctions is illustrated in Figure 16. Apart from allowing connections between the different sets of twin feeder lines, these T-junctions had two other functions:

They determined the current division between the various branches, to give the prescribed distribution along the array; and, in the north-south array, they are movable so that the position of the interference pattern can be adjusted by phase-changing. (Christiansen et al., 1961: 54).

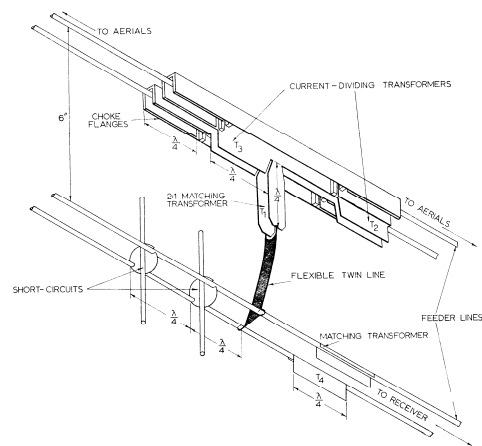

Figure 16: Design of the twin feeder line T-junction (after Christiansen et al., 1961: 54).

The phase-changing mechanism in the N-S arm used to adjust the interference pattern is shown in Figure 17. A progressive variable phase shift

... may be introduced between the aerials of the array ... by moving all the feeder junctions simultaneously ... [In Figure 15] if the movements are, from top to bottom line, x , $2x$, $4x$, $8x$ and $16x$, respectively, towards the north the length of feeder between a given aerial and the receiver is increased by $2x$ in relation to that for the next aerial to the north. A change of one wavelength between adjacent aerials shifts the interference pattern by an amount equal to the interval between successive maxima, i.e. about 1° . (Christiansen et al., 1961: 54).

Finally, the twin-wire feeder lines were linked via a balance-to-unbalance transformer and a coaxial-line phase switch to a superheterodyne receiver (in the centrally-located Receiver Hut). The receiver consisted of

... a crystal mixer, to which a 1.393 Gc/s heterodyne oscillator is also coupled. The intermediate-frequency amplifier is tuned to 30 Mc/s, with 300 kc/s bandwidth. The second detector has a square-law characteristic (this is necessary in order to make the 25 c/s output independent of the total 30 Mc/s input to the amplifier, which varies with the power received by the fan-beam systems as a whole).

The output is applied to a low-frequency amplifier and then to a phase-sensitive detector ... The signal is [then] applied to a pen recorder. (Christiansen, et al., 1961: 55).

Figure 18 shows the receiver and other equipment in the Receiver Hut.

Adjacent to the Receiver Hut was a smaller building which housed an hydraulic ram that was attached to a 9mm ($\frac{3}{8}$ in) steel cable that extended the full length of each array and was used to drive all of the aerials in hour angle as they observed the Sun. At each aerial, this cable

... is clamped to a pivoted drive arm which advances a ratchet wheel by one tooth for each to-and-fro movement of the cable. This drives the aerial about its polar axis. Each stroke changes the hour angle by $\frac{1}{8}^\circ$, which corresponds to the earth's rotation in 30 sec of time. (Christiansen, et al., 1961: 52).

This ratchet wheel is visible in Figures 11 and 12.

Construction of the Chris Cross was completed early in 1957 (Figure 19) and after mandatory 'debugging', regular solar observations began on 28 June (see Aerials at "Fleurs" ..., 1964). Subsequently, superstructure was installed along each arm of the Cross to protect the twin feeder lines from the elements (see Figure 20).

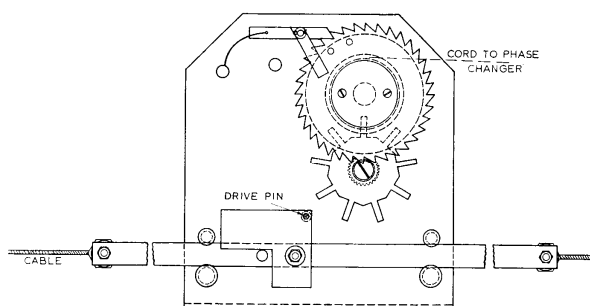

Figure 17: The phase-changing mechanism (after Christiansen et al., 1961: 55).

2.4 The Daily Solar Maps

As Figure 7 illustrates, by analysing strip scans taken on any day and measuring the relative amplitudes of different peaks, one could generate a radio map of the 1423 MHz solar emission, with isophotes indicating the relative flux levels of the different active regions. From July 1957 the Chris Cross was used to generate daily solar maps, and these were distributed to interested observatories worldwide and were published in the IAU's *Quarterly Bulletin on Solar Activity*.



Figure 18: View showing part of the interior of the Receiver Hut (courtesy ATNF Historic Photographic Archive).



Figure 19: View of the newly-completed Chris Cross, looking south along the N-S arm. Note the five vertically-stacked twin feeder lines, and the steel cable used to drive the array (courtesy ATNF Historic Photographic Archive: B5192-5).

A prominent feature of the daily isophote maps (see Figure 21) are the localised regions of enhanced emission, termed 'radio plages', which were located in the lower corona but—in most instances—were found to correlate with photospheric sunspots and chromospheric H α and calcium H and K plages visible on spectroheliograms (Christiansen and Mathewson, 1959).



Figure 20: View looking south along the N-S arm, near the centre of the Cross. Note the superstructure erected to protect the feeder lines from the elements (courtesy ATNF Historic Photographic Archive: B9097-12).

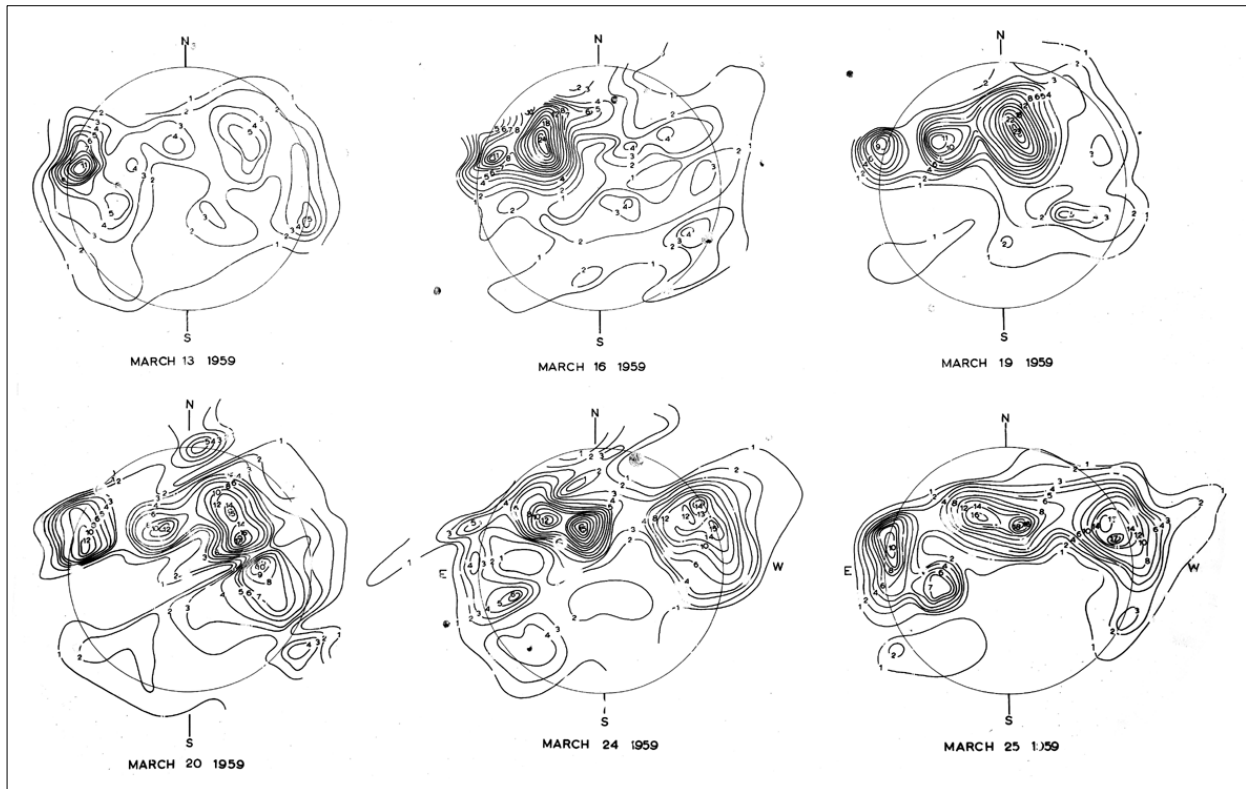

Figure 21: Six Chris Cross solar isophote maps for the period 13-25 March 1959. A notable feature is the prevalence of radio plages (courtesy ATNF Historic Photographic Archive: B6215-4).

When the Chris Cross became operational, Christiansen and Mathewson (1958: 131) were hopeful that the daily isophote maps would

... allow a study to be made of the development and decay of individual radio sources [= radio plages] on the sun and the general changes that these sources undergo during the solar cycle.

By the end of 1962 a large amount of data existed on the positions, sizes, temperatures and lifetimes of radio plages. Typically, they were found to be disk-like regions parallel to the photosphere with lateral dimensions of $\sim 25 \times 10^4$ km and brightness temperatures of $\sim 6 \times 10^5$ K (Christiansen and Mathewson, 1959: 110, 112). Meanwhile, the height of a radio plage was revealed by its rate of rotation across the solar disk. When this is plotted, as in Figure 22, the gradient of the line of best fit gives the height of the radio plage in the solar atmosphere. Such plots showed that radio plages are located between 2×10^4 and 10^5 km (with an error of $\pm 10^4$ km) above the photosphere, i.e. in the lower corona.

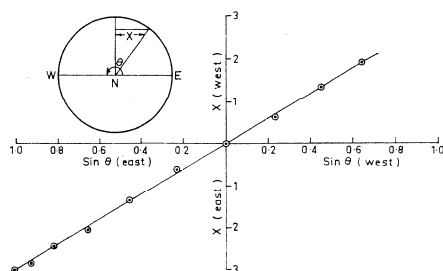

Figure 22: Plot of the displacement of a radio plage from the central meridian of the Sun against the sine of the angle of rotation of the Sun. The slope of the line gives the height of the radio plage in the solar atmosphere (after Christiansen and Mathewson, 1959: 110).

There was abundant evidence that radio plages were associated with chromospheric $H\alpha$ plages and with sunspots in the photosphere, and their magnetic fields. Typical radio plages have lifetimes of about three months, so it is not uncommon for an individual plage to be seen on three (or even more) successive solar rotations (Christiansen and Mathewson, 1959).

Christiansen and Richard F. Mullaly (1963: 171) describe the physical nature of radio plages:

It is believed ... [that they] consist of large clouds of gas (principally hydrogen) in the lower corona, much denser than the surrounding atmosphere. These clouds are prevented from dissipating presumably by magnetic fields ... The clouds are sufficiently dense to be opaque (optically thick) to decimetre radio waves; the gas of the surrounding corona at these heights is not. It is believed that the radio-frequency emission is thermal in origin, arising from collisions (without capture) between an electron and a proton ("free-free transitions").

At 1420 MHz, three basic types of solar radiation were recognised:

- 1) emission from the quiet Sun which remained constant for long periods, but may change in the course of the solar cycle;
- 2) a 'slowly-varying component' which varied from day to day; and
- 3) occasional intense bursts of emission.

Radio plages were responsible for the 'slowly-varying component'.

2.5 Associated Research Projects

In addition to monitoring the behaviour and duration of individual radio plages, the Chris Cross was used to

investigate emission from the quiet Sun (1 above), solar bursts (3), and other short-term phenomena.

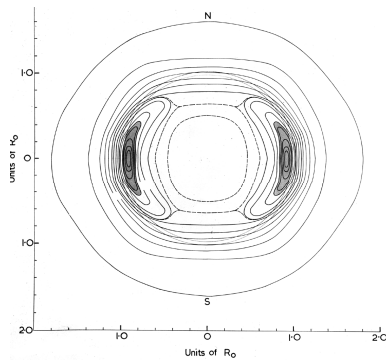

Figure 23: The two-dimensional distribution of radio brightness across the solar disk at 1420 MHz in 1952-1954 (after Christiansen and Warburton, 1955b).

As Christiansen and Mullaly (1963: 169) note,

Radio measurements of the quiet Sun are of importance, since they can provide information on temperatures and electron densities in layers of the solar atmosphere which are difficult to observe optically.

Observations carried out at Potts Hill with the two grating arrays showed that at 1420 MHz the Sun was non-symmetrical and exhibited distinct equatorial limb-brightening (see Figure 23), and that the central brightness temperature was 4.7×10^4 K (Christiansen and Warburton, 1955a: 482). However, this research was carried out near sunspot minimum, and any attempt to replicate it using the Chris Cross was fraught with difficulty given that the plethora of radio plages present near sunspot maximum tended to mask the quiet Sun radiation.

This, then, was Norman Labrum's challenge, and he responded admirably to it: first he used the Chris Cross between May and November 1958 to identify specific regions near the centre of the solar disk devoid of radio plages, and then he went on to determine the central brightness temperature of these (but only after making allowances for the effects of side lobes). The results are plotted in Figure 24, where a value of $10^5 \pm 10^4$ K accommodates all of the individual observations. This

equates to an apparent disk temperature of between 13×10^4 and 16×10^4 K.

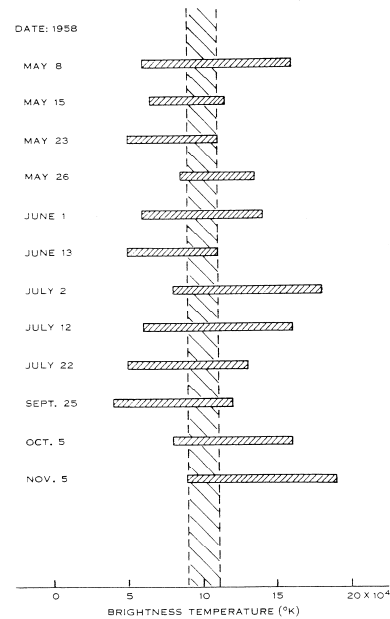

Figure 24: Twelve estimates of the central disk temperature of the quiet Sun in 1958, with the horizontal strips showing the limits of error of the individual records; the vertical band accommodates all of the individual observations (after Labrum, 1960: 703).

Labrum also tried another approach, one modelled on the procedure adopted previously by Christiansen and Warburton at Potts Hill. He took a set of twenty daily strip scans obtained with the N-S arm of the Chris Cross between September and November 1958, and tried to identify the lower (i.e. non-radio plage) envelope for each of these. All twenty scans are superimposed in Figure 25, where the confusion caused by radio plages is very apparent. After graphically estimating the mean value of the centre of the solar disk, Labrum derived the quiet Sun profile shown here in Figure 26, which produced a disk temperature of between 13×10^4 and 15×10^4 K. This agrees with the values obtained from the full Cross observations.

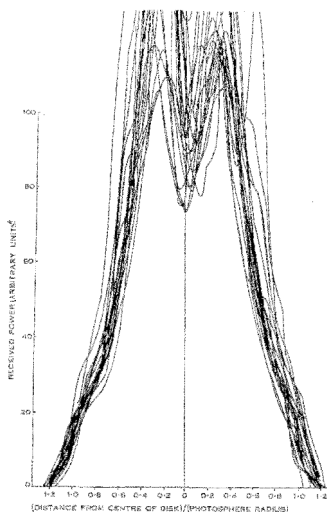

Figure 25: Twenty superimposed strip scans of the Sun obtained between September and November 1958 with the N-S arm of the Chris Cross (after Labrum, 1960: 707).

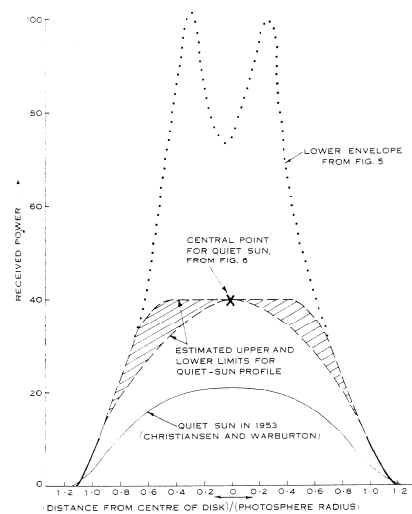

Figure 26: Profile of the quiet Sun derived from the scans in Figure 25. Christiansen and Warburton's 1955 profile is drawn on the same scale (after Labrum, 1960: 709).

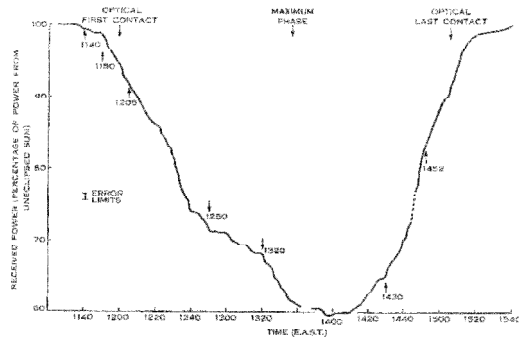

Figure 27: Eclipse curve obtained with the Potts Hill radiometer. The dashed region shows when calibrations were made (after Krishnan and Labrum, 1961: 408).

Back in 1953 Christiansen and Warburton (1955a) obtained an apparent disk temperature for the centre of the solar disk of 7×10^4 K, whereas a value $\sim 14 \times 10^4$ K applied in 1958, indicating that the temperature of the quiet Sun increased by a factor of two between sunspot minimum and sunspot maximum.

Because of the prevalence of radio plages in 1958 Labrum could not construct an isophote map like the one in Figure 23 but on the basis of the 1953 and 1958 profiles shown in Figure 26 he was able to conclude:

The two profiles are similar in shape; the ratio of corresponding ordinates in both equatorial and polar sections is approximately 2 : 1. It therefore seems likely that the brightness distribution is much the same at sunspot maximum and minimum. In particular, the pronounced limb darkening at the poles, which was detected from the earlier observations, was also present in 1958. (Labrum, 1960: 710).

On 8 April 1959 there was a partial solar eclipse that was visible from Sydney, and Labrum teamed with the visiting Indian radio astronomer, T. Krishnan, to observe this and carry out a further investigation of the distribution of radio brightness across the solar disk. The eclipse was observed with the Chris Cross and with the 16 x 18ft ex-WWII experimental radar antenna at Potts Hill. The latter radio telescope functioned as a total power radiometer, producing the eclipse curve shown above in Figure 27. The Chris Cross isophote plot showed six different radio plages on the Sun at the time, and these went some of the way towards explaining the nature of the eclipse curve. However, they did not tell the whole story.

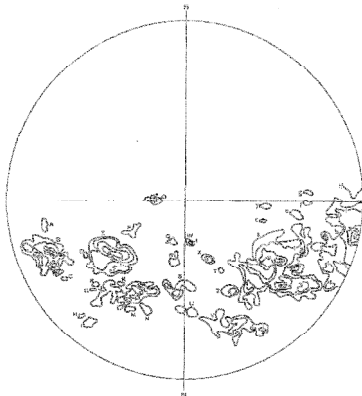

Figure 28: Photometric scan of calcium K line chromospheric plages visible on the northern half of the Sun (which alone was masked by the Moon) at the time of the eclipse; here south is at the top (after Krishnan and Labrum, 1961: 412).

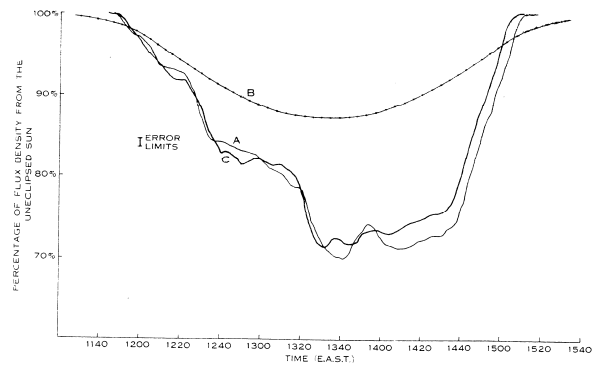

Figure 29: A is the eclipse curve for the optical plages; B is the curve obtained by using quiet Sun model number (4) discussed below; and C was obtained by subtracting curve B from the actual eclipse curve shown in Figure 27 (after Krishnan and Labrum, 1961: 415).

Given the association between optical plages and radio plages, Krishnan and Labrum proceeded to photometrically scan a photograph of calcium K line plages visible at the time of the eclipse (Figure 28), artificially eclipse this, adjust it so as to allow it to lie radially 7×10^3 km above the photosphere, and then compare this curve with the actual eclipse curve using four different models of the quiet Sun. The plot that gave the closest fit is reproduced here as Figure 29, and involved a Christiansen-Warburton type two-dimensional radio brightness distribution (as in Figure 23), but with the temperature gradient in the 'ear component' (alone) scaled up by a factor of 2 to allow for the solar maximum. The 'ear component' refers to the conspicuous equatorial limb-brightening shown in Figure 23. The four different models that Krishnan and Labrum investigated are shown in Figure 30, and the one labelled '(4)' was used in deriving Figure 29.

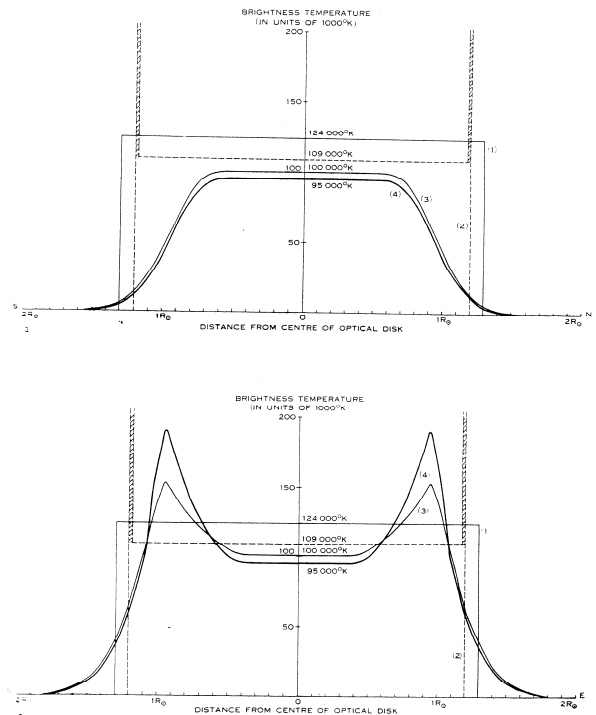

Figure 30: The four different quiet Sun models, (1)-(4), used in the analysis. Top: a plot of the distribution along the solar axis. Bottom: a plot along a line perpendicular to the solar axis and passing through the centre of the disk (after Krishnan and Labrum, 1961: 417).



Figure 31: Dr Richard F. (Dick) Mullaly marking up a Chris Cross scan as it appears on the chart recorder (courtesy ATNF Historic Photographic Archive: B9097-4).

Krishnan and Labrum (1961: 418) conclude:

The quiet-Sun model that we have derived agrees with other observations in this laboratory (Labrum 1960) taken at sunspot maximum. While the method of analysis does not allow a very sensitive interpretation of the distribution of the quiet-Sun component, our result does seem to indicate limb brightening at the equator and the absence of limb brightening at the poles. The fact that the model with the gradient of the ear component stepped-up, fits best, indicates a limb-brightened model closer to those predicted theoretically than the Christiansen and Warburton (1955) model for sunspot minimum and brings out the advantages of higher resolution obtained at eclipse observations. It is interesting in this connexion to note that Tanaka and Kakinuma (1959) in the interpretation of their eclipse observations of April 1958 (near sunspot maximum) have also been led to suggest an ear component.

Although solar bursts were much more common at lower frequencies (see Stewart, 2009), they were occasionally recorded by the Chris Cross at 1423 MHz, and are the subject of three papers by Krishnan and Richard F. Mullaly. Figure 31 features Mullaly.



Figure 32: The longitude distribution of the 46 bursts observed with the Chris Cross (after Mullaly and Krishnan, 1963: 12).

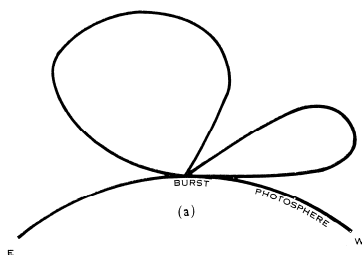

Figure 33: A possible double lobe burst polar diagram which accounts for the longitude distribution in Figure 32 (after Mullaly and Krishnan, 1963: 13).

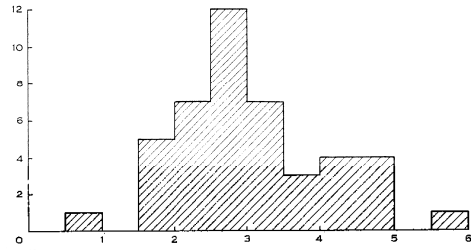

Figure 34: Plot of number of bursts versus angular size (in minutes of arc) (after Mullaly and Krishnan, 1963: 14).

In a paper titled “Solar decimetre radio bursts”, Mullaly and Krishnan (1963) discuss 46 bursts observed between 1958 and 1961 (inclusive). Their aim was primarily “... to determine typical physical characteristics of the decimetre burst sources: their sizes, positions, brightness temperatures, and movements.” (Mullaly and Krishnan, 1963: 9). Most observations were carried out with the E-W arm of the Chris Cross, which allowed successive scans of the Sun to be obtained every 4 minutes. All but one of the bursts were associated with individual radio plages, and when a burst occurred it was manifest by a sudden increase in the height of the radio plage. Sometimes when there were sudden intense bursts the chart recorder pen went off-scale, and the receiver gain had to be turned down.

When the heliocentric longitudes of the bursts were plotted they were found to be non-randomly distributed, with fewer bursts near the limbs than near the central meridian. There was also a suggestion of east-west asymmetry in the distribution, and there was a 30° region towards the eastern limb with no bursts whatsoever (see Figure 32). All this suggested to Mullaly and Krishnan (1963: 13) that these bursts “... typically have a polar diagram, with two lobes, asymmetrically disposed ...” as illustrated here in Figure 33.

The angular sizes of the burst sources were investigated, using the formula

$$S = (W^2 - b^2)^{1/2} \tag{2}$$

where S is the size in minutes of arc, W the half-power width of the burst and b the beamwidth of the fan beam. Values of S ranged between $<1'$ and $6'$ (Figure 34), with a mean of $3'$. When the angular sizes were plotted against the heliocentric longitudes of the bursts no significant differences were noted between the sizes of bursts near the central meridian and those near the limbs of the Sun (see Figure 35).

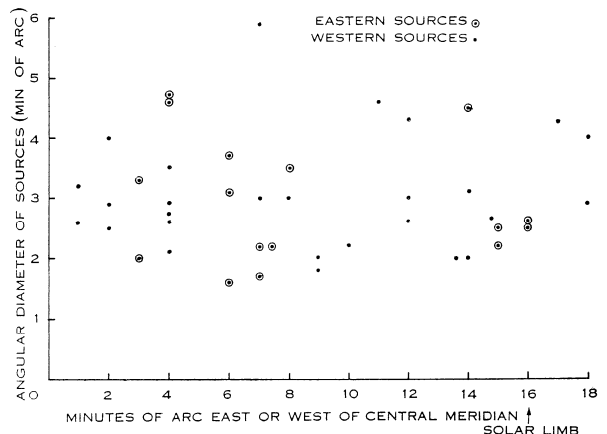

Figure 35: Plot of angular size of burst sources vs heliocentric longitude of the bursts (after Mullaly and Krishnan, 1963: 15).

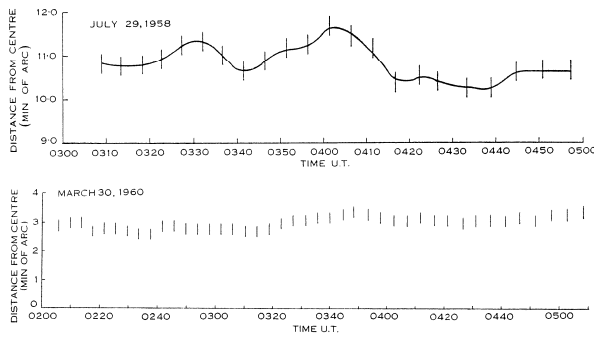

Figure 36: Two bursts showing apparent movement of the centroid of the emission sources through time. The vertical bars are running means for three successive scans (after Mullaly and Krishnan, 1963: 17).

In general, the angular sizes of the sources of Chris Cross bursts showed little or no change during the lifetimes of the bursts. The most notable exception occurred on 29 April 1960. In this case, the source systematically increased from $\sim 1.5'$ to $\sim 3.5'$ over the course of more than two hours, but during part of this interval (from 0300 to 0350 hrs UT) the source was inactive. On one or two occasions bursts were recorded which decreased in source size with the passage of time:

Thus a very intense burst on July 14, 1959 had an initial stage of very strong emission with an angular size of about $4'$ or $4.5'$ of arc, followed by a period of weaker emission during which the size appeared to be about $3'$. (Mullaly and Krishnan, 1963: 16).

While no large-scale changes in the positions of the sources were ever observed, sometimes bursts did exhibit small fluctuations in position of up to $\pm 1'$ over the course of tens of minutes to hours. Two of the most notable examples are shown here in Figure 36. Mullaly and Krishnan (1963: 17) suggested that such movements were perhaps due to "... the brightening or darkening of one part of the burst source relative to another, rather than a bodily movement in the source region as a whole."

The peak brightness temperature (T_b) of each burst was investigated, using the formula

$$T_b = F/1.88 \times 10^{-27} (S/32\lambda)^2 \quad (3)$$

where F is the flux density in $\text{W m}^{-2}(\text{c/s})^{-1}$, S is the size of the source in minutes of arc, and λ is the wavelength in metres. All of the bursts had peak brightness temperatures between 10^6 K and 2×10^9 K, with 84% between 10^6 and 10^8 K (Figure 37). Noting that there were no bursts with $T_b < 10^6$ K, Mullaly and Krishnan (1963: 18-19) concluded:

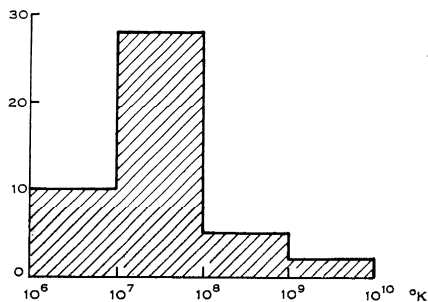

Figure 37: Histogram of the peak brightness temperatures of all bursts (after Mullaly and Krishnan, 1963: 19).

It seems then that there may be a cut-off and that bursts with peak brightness temperatures much below 10^6 °K do not occur or occur infrequently. On the other hand, such bursts may escape observation by being of very short duration or unusually small angular size. The question of a cut-off is of interest for the discussion of possible mechanisms of production of burst radiation.

Towards the end of their paper Mullaly and Krishnan (1963: 22) address this last-mentioned issue, pointing out that "It is difficult to account for temperatures of the order of 10^8 °K on the basis of thermal emission alone." They note that Takakura (1960) has suggested synchrotron radiation as a possible mechanism, while Hachenberg and Wallis (1961) advocate quasi-thermal emission, with bands of weak synchrotron radiation superimposed, but the Chris Cross data did not allow them to distinguish between the two mechanisms.

Mullaly and Krishnan also investigated the sizes of burst sources relative to their associated radio plages and found no direct correlation. Many sources were comparable in size to their parent plages, but some were smaller; "The striking feature, however, is that *none of the burst sources substantially exceed [sic.] their associated plages in size.*" (Mullaly and Krishnan, 1963: 20; their italics).

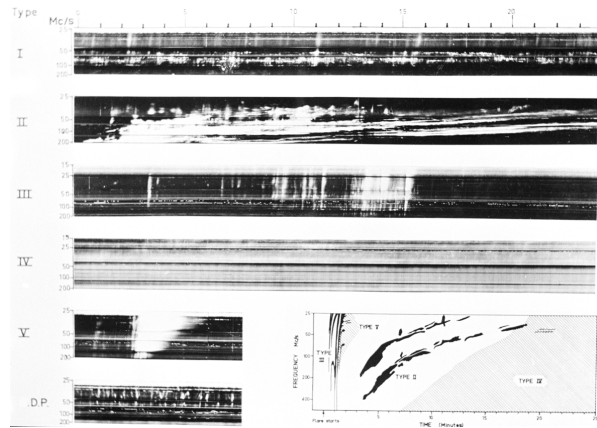

Figure 38: The different spectral types of solar bursts; time is in minutes. Type IV continuum emission (fourth strip from top) can last for days (courtesy ATNF Historic Photographic Archive: B6317).

The heights in the solar atmosphere of ten burst sources near the limb were examined and their displacement from the positions of their parent plages was measured. Six coincided in position; one was closer to the central meridian by $0.5 \pm 0.3'$, and three were further away from the central meridian by $\sim 0.7 \pm 0.3'$, indicating that most burst sources were situated within $\pm 2 \times 10^4$ km of their parent radio plages (Mullaly and Krishnan, 1963: 19-20).

Before writing their 1963 paper, Krishnan and Mullaly investigated Chris Cross bursts that were known to be associated with metre-wave continuum emission of spectral Type IV (see Figure 38). Eight different bursts were recorded between July 1958 and November 1960 (inclusive).

The heights of these burst sources in the solar atmosphere were calculated using the following formula (and on the assumption that they lay radially above the associated flares):

$$H = R_{\odot} Y/X \quad (4)$$

where H is the height radially above the $H\alpha$ flare in km, R_{\odot} is the radius of the Sun, and X and $X + Y$ respectively denote the perpendiculars from the centroid of the flare position (see Krishnan and Mullaly, 1962: 91, Figure 4). Values of H for the eight bursts were all $< 3.5 \times 10^4$ km, except on one day when the source was close to the central meridian and this method was not applicable. Krishnan and Mullaly (1962: 91) conclude that "... the regions of origin of 1420 Mc/s bursts are situated in the lower solar atmosphere and not in the upper corona."

Angular sizes of the sources of the eight bursts were calculated using Equation (2) above and ranged from $< 2.0'$ to $4.6'$ (see Krishnan and Mullaly, 1962: 90). No significant changes in source sizes were detected during the lifetimes of the bursts. Peak brightness temperatures of the bursts were also calculated, from Equation (3) above, with values ranging from 2×10^7 K up to 2×10^9 K (ibid.).

One of the features of metre wave Type IV events is that some of the sources of the continuum radiation show rapid movement away from the Sun, while other

source regions remain stationary (see Stewart, 2009). Krishnan and Mullaly were keen to see if the sources observed with the Chris Cross followed a similar pattern, but only three of their bursts were accompanied by Dapto interferometer records at 45-60 MHz. These three events are shown in Figure 39, where two of the three Type IV burst sources exhibit large-scale outward motion from the Sun, while the third burst (on 15 November 1960) shows significant oscillations in its position in the corona. In contrast, there were no changes in the positions of any of the Chris Cross sources. Krishnan and Mullaly (1962: 95) conclude that the Chris Cross emission and Type IV metre wave emission were generated simultaneously, but at widely different levels in the solar atmosphere, and "It is clear that the decimetre [i.e. Chris Cross] radiation, which is known to be broad-banded, cannot be described simply as an extension of the metre wavelength type IV continuum." We should note that one year earlier, Krishnan and Mullaly (1961) had summarized their principal findings in a short paper which was published in *Nature*.

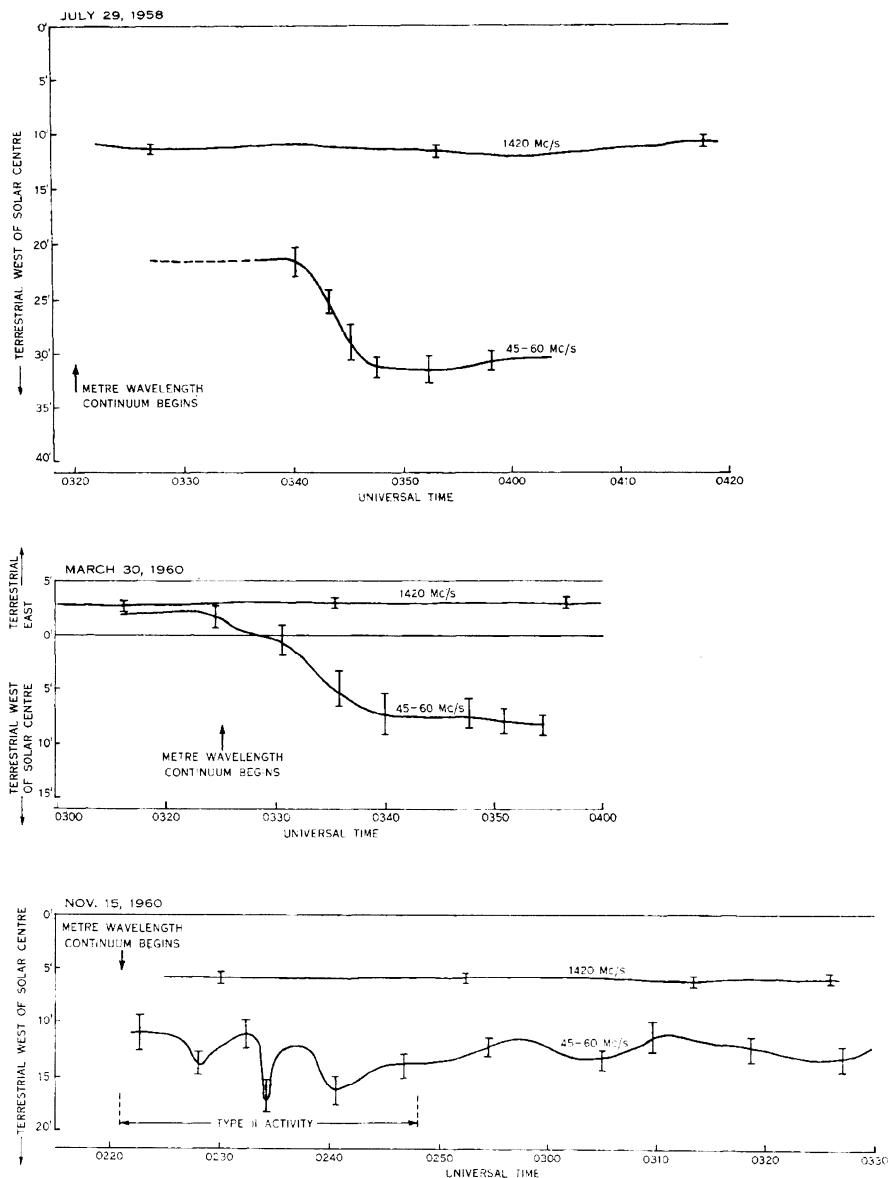

Figure 39: The E-W positions of three Chris Cross bursts at 1423 MHz and their corresponding Type IV bursts at 45-60 MHz. The bars at 45-60 MHz indicate that variations in position that occurred between 45 and 60 MHz (after Krishnan and Mullaly, 1962: 94).

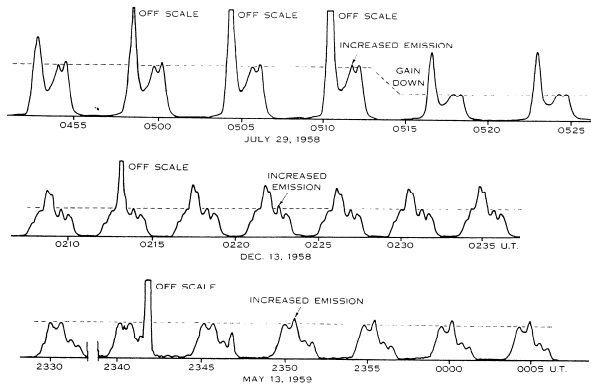

Figure 40: Three sets of Chris Cross E-W strip scans of the Sun showing in each case a burst followed about 10 minutes later by a small enhancement in the level of a quite different radio plage (after Mullaly, 1961: 541).

In 1961 Mullaly also published a short paper in which he reported three cases where a small 1423 MHz burst was followed within 8-9 minutes by a small-scale localised brightening of a distant radio plage (see Figure 40). Mullaly (1961: 541) explains these enhancements:

The immediate deduction from the observations is that the secondary increases are stimulated by something (e.g. a plasma cloud or a shock wave) propagated from the region of the main burst. The velocity of propagation appears in all cases to lie between 1000 and 2000 km/s ...

Two of the three events were possibly associated with optical surges and Mullaly (1961: 542) noted that Athay and Moreton (1961) recently reported optical observations of what they interpreted as plasma clouds travelling out from the regions of solar flares at velocities between 10^3 and 2.5×10^3 km/s. They also mentioned that on some such occasions sudden optical changes were observed in filaments located as far away as 7×10^5 km from the original flare site.

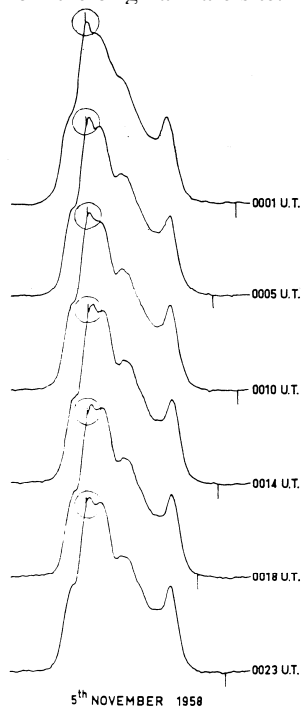

Figure 41: Examples of 'pips' (circled) recorded on successive E-W. Chris Cross scans on 5 November 1958 (after Christiansen and Mullaly, 1963: 173).

The final type of anomalous solar phenomenon discovered with the Chris Cross involved a project that was carried out jointly by Mullaly and the first author of this paper, up until the former suddenly left the CSIRO's Division of Radiophysics in 1962 and joined Christiansen at the University of Sydney. Our planned paper on "Solar Microwave Transients", or 'Pips' as we colloquially called them, never materialised, but they were discussed briefly by Christiansen and Mullaly in their 1963 review paper on the Chris Cross.



Figure 42: The 18m Kennedy Dish (courtesy ATNF Historic Photographic Archive: B6499-7).

They describe these pips:

On certain days when continued East-West strip scanning was being carried out it was found that the recorder pen repeatedly exhibited momentary deflections ("pips") when a particular radio plage region was in the aerial beam, but at no other time. (Christiansen and Mullaly, 1963: 172).

Figure 41 shows six successive E-W array scans, and a pip is present on every scan, near the peak of the most intense radio plage. Pips tended to occur in 'pip storms', when 60-100% of all scans showed pips, and always associated with the same radio plage. Some radio plages seemed prone to pips, which occurred repeatedly over a number of successive days.

Pips were always <1 second in duration (the resolving time of the receiver), and in intensity were typically 5-10% of that of the associated radio plage. As for the origin of pips, and the emitting sources:

Nothing is known of the dimensions of the sources of the transient emission, except that they are not larger than a typical radio plage region. Assuming an angular diameter of $2'$ of arc and a duration of 1 second, a typical pip must represent a momentary flash with a brightness temperature of at least 10^5 °K [sic.]. If the diameter is less (as *a priori* seems likely), or the dura-

tion shorter, the brightness temperature attained could well be much greater than this. (ibid.)

Christiansen and Mullaly (ibid.) note that pips were a feature of the solar maximum. Early in 1960 activity began to decline, and towards the end of that year pips had all but disappeared.

2.6 Non-Solar Astronomy

In 1958 three non-solar staff members from the Division of Radiophysics realised that a high-resolution instrument like the Chris Cross had the potential to contribute to galactic and extragalactic research, and they used the E-W arm of the Cross at 1427 MHz to investigate a number of discrete sources (see Twiss, Carter and Little, 1960; 1962).

Their one-dimensional brightness distribution for Centaurus-A confirmed earlier studies which showed a complex source with "... two bright regions, each of about $2\frac{1}{2}'$ arc between half-intensity points and separated by $5'$ arc." (Twiss et al., 1960: 156).



Figure 43: View looking east showing the Kennedy Dish and part of the E-W arm of the Chris Cross (courtesy ATNF Historic Photographic Archive: B6499).

Taurus-A proved to be a single source, with the brightness distribution indicating that nearly all the radiation at 1427 MHz derived from a region about $8'$ across. However, observations with the N-S arm of the Cross and also with NE-SW baselines revealed the source to be elliptical, with the major axis at position angle 135° (Twiss et al., 1960: 157). No polarisation was detected Twiss et al., 1962: 386).

A single source was also found to be associated with the Great Orion Nebula:

The radio source has a simple, approximately Gaussian, shape with a width of $3'$ between the points of half intensity. Nearly all the radiation appears to come from a region less than $12'$ across. There is some asymmetry and the edge of the source is brighter on the eastern than on the western side. (Twiss et al., 1960: 159).

Cygnus-A was the other discrete source observed with the Chris Cross, but its far northern declination created problems. In general, the results obtained tended to confirm the earlier findings of other researchers.

3 THE FLEURS COMPOUND INTERFEROMETER

In November 1960 the 'Kennedy Dish' (Figure 42), an 18.2m (60ft) American prefabricated steerable parabolic reflector on an altazimuth mounting, was installed at Fleurs 24.4m (80ft, or double the spacing of individual elements of the Chris Cross) beyond the eastern end of

the E-W arm of the Chris Cross (Figure 43).³ When used as a multiplying element with the E-W arm of the Cross it formed the Fleurs Compound Interferometer (FCI) (Figure 44), having a fan beam with a half-power beam width of $1.53'$ (see Labrum et al., 1963; 1964). As indicated in Figure 45, the uncorrected polar diagram showed unacceptably high side lobes, but by convolving the observed response with a correcting function these were reduced to $<4\%$ of the main response (i.e. curve (b) in Figure 45).

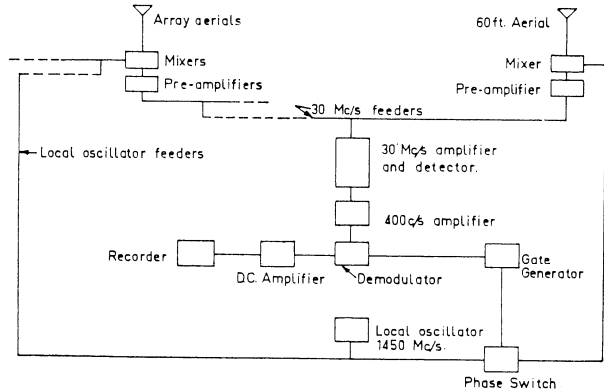

Figure 44: Block diagram of the Fleurs Compound Interferometer receiving system (after Labrum et al., 1963: 151).

From August 1961 until October 1962 (Aerials at "Fleurs" ..., 1964) the FCI was used to determine the right ascensions and angular sizes of eight well-known discrete sources.⁴ The observational procedure was outlined by Labrum et al. (1963: 151):

An improvement of $\sqrt{20}$ times in sensitivity was obtained by recording the passage of each source through 5 successive lobes of the interference pattern, and repeating the whole sequence on 4 nights, thus giving 20 observations which were subsequently integrated. On this basis, the intensity of the minimum detectable point source should be roughly $10 \times 10^{-26} \text{wm}^{-2} (\text{cs})^{-1}$.

The observations, in each case, were carried out over a period of about one week. The results are summarised in Table 1, and Figure 46 shows the observed E-W profiles of the various sources.

Table 1: Positions and corrected sizes of selected discrete sources observed with the Fleurs Compound Interferometer (adapted from Labrum et al., 1964: 326)

Source	Position (epoch 1960)			Size		
	Right Ascension			P.E.	E-W	P.E.
	h	m	s	(s)	(')	(')
Sagittarius-A	17	42	28.8	± 0.8	4.1	± 0.05
Taurus-A	05	31	27.3	± 0.7	3.6	± 0.05
Centaurus-A	13	22	16.4	± 0.9	2.1	± 0.10
	13	22	44.2	± 0.9	2.7	± 0.10
Omega Neb.	18	17	32.9	± 0.7	4.1	± 0.05
	18	17	51.3	± 1.5	2.5	± 0.15
Orion Nebula	05	32	48.9	± 0.7	3.4	± 0.10
Hydra-A	09	15	41.5	± 0.7	0.5	± 0.20
Virgo-A	12	28	17.0	± 0.7	1.25	± 0.15
Cygnus-A	19	57	44.4	± 1.0	---	---

Sagittarius-A was of considerable interest in that Drake (1959) had suggested that the position adopted for it by Gum and Pawsey (1960) when recalibrating the new galactic coordinate system was several seconds of arc too far to the east, and that "... the intense

main source is associated with a complex of weaker but more extended components." (Labrum et al., 1964: 327-328). The FCI observations (Figure 46a) confirmed these findings.

High-resolution studies of Centaurus-A by a number of researchers had shown this source to consist of two emitting regions, extending over several degrees in declination, with a bright central core which itself was a double source. The Fleurs observations (Figure 46c) confirmed this, showing the core sources were 5.1' apart and had E-W widths of 2.1' and 2.7'.

The E-W profile for the Omega Nebula (Figure 46d) exhibits conspicuous asymmetry which Labrum et al. (1964: 331) attribute to the presence of a weak secondary source about 18 seconds east of the main source. This is listed separately in Table 1.

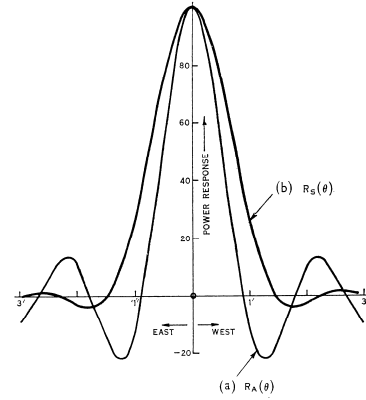
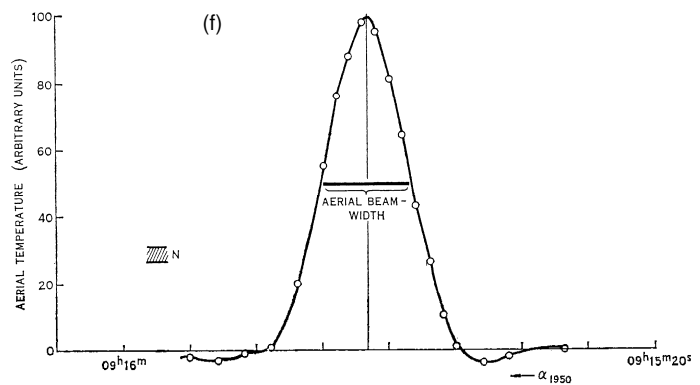
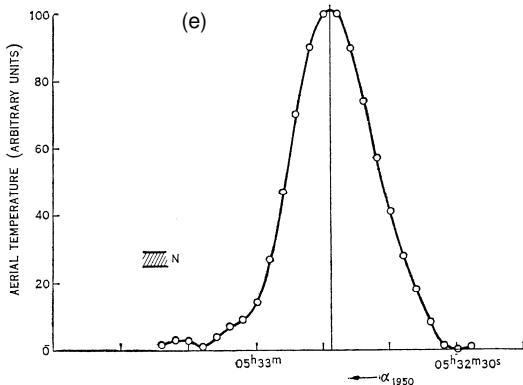
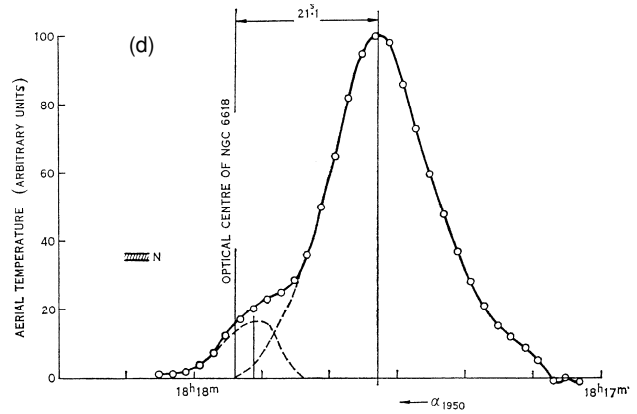
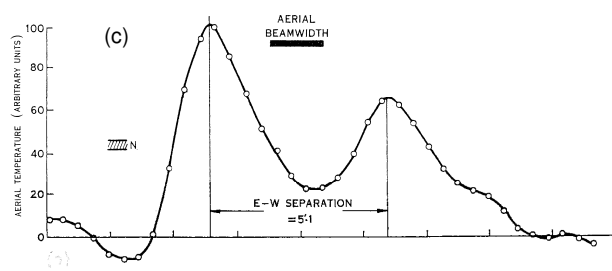
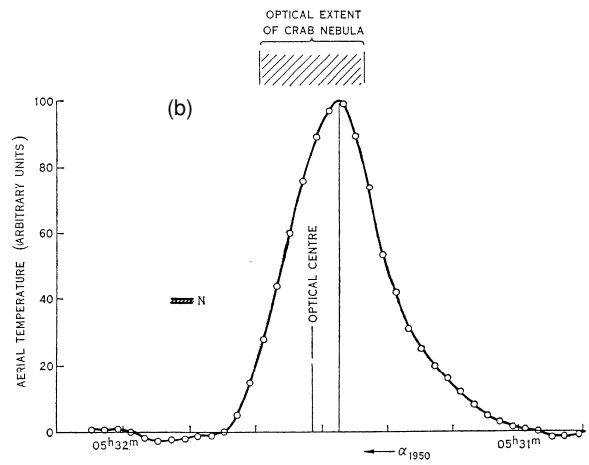
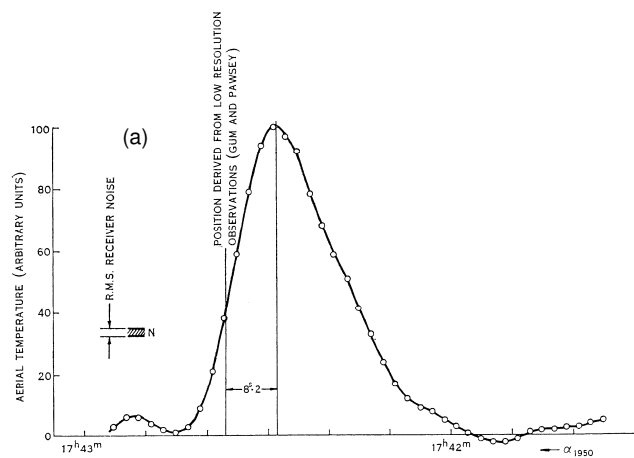

Figure 45: Polar diagrams of the Fleurs Compound Interferometer, showing the uncorrected (a) and corrected (b) curves (after Labrum et al., 1964: 325).



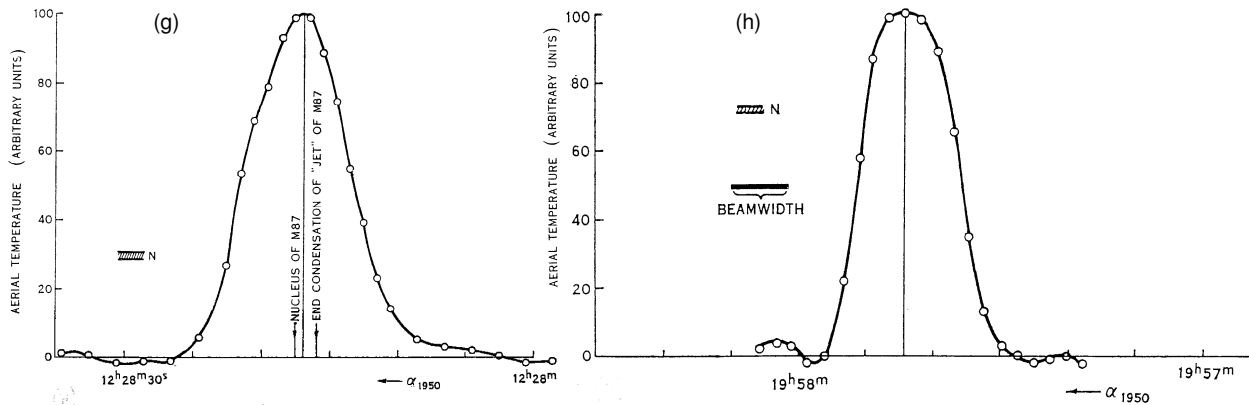

Figure 46: Fleurs Compound Interferometer E-W profiles for the following sources: (a) Sagittarius-A; (b) Taurus-A; (c) Centaurus-A; (d) Omega Nebula; (e) the Great Orion Nebula; (f) Hydra-A; (g) Virgo-A; and (h) Cygnus-A (after Labrum et al., 1964: 328-334).

Earlier reports suggested that the radio source associated with the Great Orion Nebula coincided with the position of θ^1 Orionis, and the FCI observations (Figure 46e) confirmed this.

Virgo-A was another source of particular interest to the FCI team in that

Shklovskii (1955) suggested that the radio emission from this source originates as synchrotron radiation from the "jet", a structure which extends some 20" westwards from the optical centre of M87. (Labrum et al., 1964: 332).

The Fleurs observations placed the centre of the radio source between the centre of the galaxy and the end of the jet (Figure 46g), and on the basis of this finding and results reported earlier by other radio astronomers Labrum et al. (1964: 333) supported Shklovskii's conclusion.

The enigmatic source Cygnus-A was also observed with the FCI, but under unfavourable conditions given its far northern declination. It only had an elevation of 15.5° at meridian transit. Consequently

Tropospheric refraction had an appreciable effect upon the apparent declination of the source, and so on the relative phases of the signals from the array and from the single-aerial element. It was in fact found that the phase changed slightly from night to night, and that it was necessary on each occasion to estimate the phase error from the appearance of a preliminary scan across the source. An empirical phase correction was then made before the beginning of the main part of the record. (Labrum et al., 1964: 333).

Reports by other observers showed the source to be double, with the space between the two components bridged by a broad weak source. The resolution of the FCI was not quite sufficient to show these structural details (see Figure 46h), but by using the *uncorrected* polar diagram and three different models of the source (see Figure 47), useful conclusions were reached:

... the source has two main components which are both too narrow in the east-west plane to be resolved by the interferometer ... [but] where an extended component is included in the model ... the east-west spacing of the doublet is found to be 99". This agrees very well with the work of Swarup ... (Labrum et al., 1964: 335).

The Kennedy Dish was relocated to Parkes in 1963 in order to be used in conjunction with the 64m Parkes Radio Telescope, so the Fleurs Compound Interferometer only had a short life. However, it had allowed

the Chris Cross to be used of an evening for further non-solar work, and it gave three members of the RP Solar Group (Labrum, Krishnan and Payten) a brief opportunity to dabble in non-solar radio astronomy. Although Christiansen was not personally involved in this work (having already transferred to the School of Electrical Engineering at the University of Sydney), he is acknowledged in both of the Labrum et al. papers (1963 and 1964) for his helpful advice, constant interest and encouragement. In their 1963 paper the authors also make the interesting point that it was Christiansen who initiated the Fleurs Compound Interferometer Project.⁵

4 THE FLEURS SYNTHESIS TELESCOPE

In 1963, after making important contributions to solar, galactic and extragalactic astronomy for twenty years (see Mills, 1984; Orchiston, 2004; Orchiston and Slee, 2002), the Fleurs field station became surplus to RP requirements and was closed down. This followed the relocation of the Kennedy Dish to Parkes and the consolidation of the Division's galactic and extragalactic research at Parkes.

The initial plan was to demolish the Mills Cross, Shain Cross and Chris Cross, but after representations from the University of Sydney a decision was made to simply transfer the site lease to the University. This officially occurred on 1 July 1963, when all of the equipment remaining at the site was also formally handed over to the University.

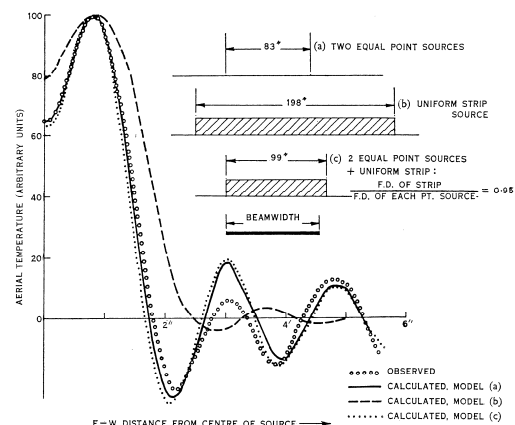

Figure 47: Fleurs Compound Interferometer observations of Cygnus-A (small circles) compared with three different source models (a), (b) and (c) (after Labrum et al., 1964: 335).

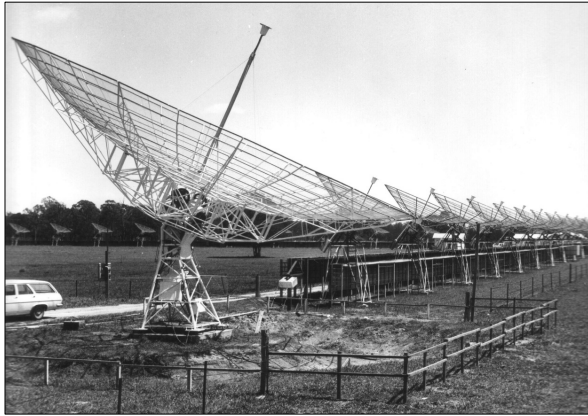

Figure 48: One of the Fleurs Synthesis Telescope's 13.7m antennas, located at the eastern end of the Chris Cross (courtesy ATNF Historic Photographic Archive: 9097-11).

This initiated a new era in the site's history, and although regular Chris Cross solar observations were continued (Christiansen, 1967)—but on a somewhat curtailed scale—Christiansen's main effort went into converting the Chris Cross into the Fleurs Synthesis Telescope (FST). This ambitious project would occupy staff from the School of Electrical Engineering and their graduate students for the next two decades and result in a radio telescope comprising the original Chris Cross and six stand-alone 13.7m parabolic antennas (Figure 48) with a 20 arc second beam (see *The Fleurs Synthesis Radio Telescope*, 1973). During the 1970s and 1980s the FST was used to study large radio galaxies, supernova remnants and emission nebulae.



Figure 49: A view looking south along the N-S arm of the decommissioned Chris Cross showing rusting antennas (courtesy John Leahy).

A detailed account of the FST and Christiansen's pivotal role in its planning, development and use will be presented by Miller Goss in a later issue of this journal.

5 THE DEMISE OF FLEURS

The Fleurs Synthesis Telescope was closed down in 1988, bringing to an end 34 years of research into solar, galactic and extra-galactic radio astronomy at Fleurs, and the site was transferred to the Engineering Faculty at the University of Western Sydney to serve as a teaching facility for undergraduate students. In the mean time, the Mills Cross and the Shain Cross rapidly deteriorated, and the Chris Cross dishes and larger antennas of the Fleurs Synthesis Telescope continued to rust (Figure 49).

In 1990 the University of Western Sydney recognised the historical importance of the Fleurs field station, and a decision was made to restore one of the 13.7m Fleurs Synthesis Telescope antennas and the twelve centrally-located Chris Cross antennas, but to remove all of the other Chris Cross antennas and superstructure from the site. It was also decided that a section of the Mills Cross should be reconstructed.

Staff and undergraduate students worked diligently on this project, and by 22 November 1991 all was ready for a ceremony to mark the refurbishment of these historic radio telescopes (Figure 50). It was only appropriate that one of the speakers on this occasion was Professor W.N. Christiansen (see Figure 51).

In 1998, the Fleurs field station again became surplus to requirements and was closed down by the University of Western Sydney. This brought into sharp focus the long-term future of the remaining elements of the Fleurs Synthesis Telescope, including the twelve refurbished Chris Cross antennas.

6 DISCUSSION

6.1 The Chris Cross in International Context

By mid-1957, when the Chris Cross became operational, a number of other nations were actively engaged in solar radio astronomy, but with instrumentation that was relatively less sophisticated than that used by the Division of Radiophysics in Australia.

Britain and Australia were the leading radio astronomy nations in the decade following World War II, and although some solar work was carried out in Britain using 2-element interferometers (see Smith, 2007), the main focus of research at Jodrell Bank and Cambridge was meteors, and galactic and extragalactic sources.

In contrast, Canada was one nation that specialised in solar radio astronomy, beginning in 1946. The following year the Goth Hill Radio Observatory was founded, which featured a small steerable dish and a slotted waveguide array. By January 1956 this array and an adjacent array had been developed as a compound interferometer with a 2.4' fan beam (see Covington, 1984).

Another nation to focus on solar radio astronomy was Japan. The earliest observations were carried out in 1949 with a steerable horn at Osaka University and a small broadside array at the Tokyo Astronomical Observatory at Mitaka. A 10-m dish was erected at Mitaka in 1953, and in this same year a 5-element grat-

ing array developed by Nagoya University was operational at Toyokawa. In 1954 this was extended to an 8-element array. However, Tanaka (1984: 340) stresses that the first grating array "...was planned and built quite independently of the one developed by Christiansen ..."

Solar radio astronomy was initially also the focus of the French radio astronomy teams at the École Normale Supérieure and the Institut d'Astrophysique in Paris. In 1954 the former team transferred to the Paris Observatory. Early observations were made mainly with small steerable dishes and recycled WWII Würzburg antennas (see Orchiston and Steinberg, 2007; Orchiston, et al., 2007; Orchiston, et al., 2009), but by 1957 two multi-element E-W grating arrays—inspired by Christiansen's efforts at Potts Hill—were operational at Nançay (see Denisse, 1984).

In post-war Netherlands, the main interest of the fledgling radio astronomy group was galactic and extra-galactic research, especially that associated with the 21cm hydrogen line (Van Woerden and Strom, 2006), but the Government's Post, Telephone and Telegraph department ran a multi-wavelength solar monitoring program using two ex-WWII Würzburg antennas, a 10-m dish, a corner reflector and a simple 2-element interferometer (see Strom, 2005).

One other nation to intensively research solar radio astronomy in the decade following WWII was the Soviet Union, commencing with solar eclipse observations in 1947. The following year radio astronomy began at the P.N. Lebedev Physical Institute, and by the mid-1950s a number of solar radio telescopes were operational. These comprised stand-alone dishes—including a Würzburg antenna (Dagkesamanskii, 2007)—and interferometers, some of novel design. One of these was the Big Pulkovo Radio Telescope, which began operations in 1956 under the auspices of the newly-formed Department of Radio Astronomy at the Main Astronomical Observatory in Pulkovo (Parijskij, 2007). Other institutes which ran solar radio astronomy research programs in the mid-1950s were the Byurakan Astrophysical Observatory in Armenia; the Crimean Astrophysical Observatory; the Institute of Terrestrial Magnetism, Ionosphere and Radio Wave Propagation in Moscow; and the Radiophysical Research Institute in Gorky (see Salomonovich, 1984).

This brief review reveals that by 1957 a number of nations had grating interferometers analogous to the Potts Hill arrays, but the first institution to develop a crossed-grating interferometer like the Chris Cross was Stanford University in the USA. This became operational in 1960, and is discussed in Bracewell and Swarup (1961) and Bracewell (2005).

6.2 Heritage Considerations

Between 1945 and 1965, at one time or another the CSIRO's Division of Radiophysics maintained radio astronomy field stations at Badgerys Creek, Bankstown Airport, Dover Heights, Fleurs, Georges Heights, Murraybank, Penrith, and Potts Hill in or near Sydney, and at Dapto near Wollongong, and a number of associated remote sites near Sydney and up and down the New South Wales coast (see Orchiston and Slee, 2005; Stewart, 2009; Wendt, 2008). In 2004, one of us (WO) wrote:

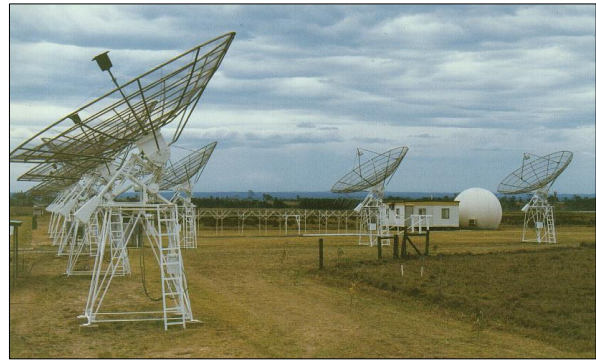

Figure 50: A view looking west showing nine of the twelve refurbished Chris Cross antennas (courtesy John Leahy).

Important radio telescopes, many of novel design, were sited at these field stations, and pioneering studies were undertaken in solar, galactic and extra-galactic radio astronomy. It is a sobering fact that of all of these radio telescopes, the only ones that have managed to survive through to the present day are the twelve central elements from the Chris Cross at Fleurs. (Orchiston, 2004: 161).

It is frightening to realise that later that very year the twelve restored Chris Cross antennas were bulldozed (Figure 52), highlighting the extreme vulnerability of our radio astronomical heritage. Most optical telescopes that have made important contributions to science are cherished and preserved for posterity, but the same sentiment rarely applies to radio telescopes. All too often, they are viewed merely as tools used to address specific research problems, and their importance as heritage instruments *per se* is ignored. If we are to make any progress in preserving our radio astronomical heritage we must urgently address and reverse this prevailing mind-set.

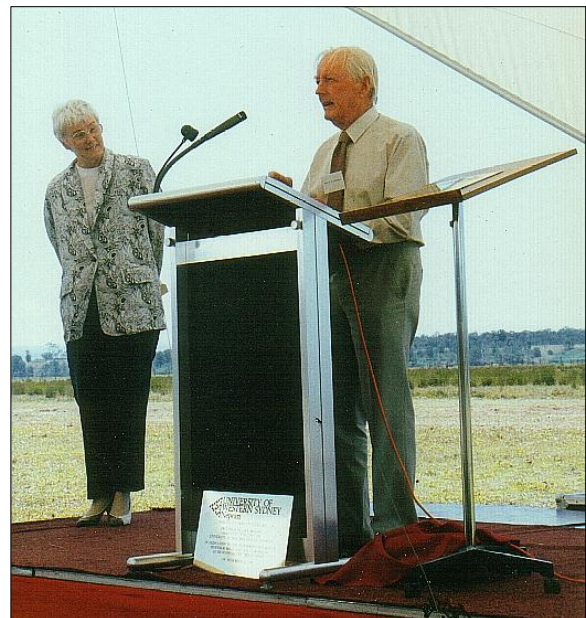

Figure 51: Professor Christiansen speaking at the 22 November 1991 ceremony at Fleurs (courtesy John Leahy).

The Chris Cross may have disappeared entirely from the Fleurs landscape, but by a strange twist of fate at least two of the aerials have survived in close to their original condition (see Figure 53). They were acquired from the University of Western Sydney by amateur astronomer and SETI enthusiast, Leon Darcy, and are

now located at Bungonia in the Southern Highlands of New South Wales where they are used for interferometry (D. Whiteman, pers. comm., 2004). In addition, the Astronomical Society of New South Wales has been restoring a Chris Cross antenna which is located at their Wiruna Dark Sky Site a 3hr drive west of Sydney (see www.asnsw.com/wiruna/rt.asp).



Figure 52: The bulldozed remains of some of the preserved Chris Cross aerials (courtesy John Leahy).

7 CONCLUDING REMARKS

The Chris Cross is a remarkable radio telescope with a memorable history. When constructed in 1957 it was the world's first cross-grating interferometer, and the first radio telescope to provide daily two-dimensional radio maps of the Sun. Its obvious research potential and innovative design subsequently inspired the construction of similar radio telescopes in other countries.

Despite this, with the benefit of hind-sight, Christiansen (1984: 124) had a rather modest perception of the significance of the solar investigations carried out with the Chris Cross:

They led to a better understanding of the Sun's outer atmosphere, but to no spectacular discoveries. Their real excitement was in the development of new instruments superior in resolving power to any in existence.

We think he was a tad too modest!



Figure 53: Leon Darcy's 2-element interferometer at Bungonia, which utilises two ex-Chris Cross antennas and mountings (courtesy Don Whiteman).

As a significant component of the Fleurs Compound Interferometer and, later, the Fleurs Synthesis Telescope, the Chris Cross also played a key role in international non-solar radio astronomy, providing new per-

spectives on discrete radio sources, but particularly large radio galaxies, supernova remnants and emission nebulae.

With the advent of The Australia Telescope in 1988 the FST was closed down as a research instrument, but it did serve for a time as a teaching instrument. However, the various antennas continued to rust, and in 1991 a decision was made by the then custodians of the array to restore and preserve the twelve antennas at the centre of the Chris Cross along with one of the six 13.7m FST antennas. Yet this only served as a temporary reprieve: the Fleurs field station was finally closed in 1998 and less than a decade later the landowner made a unilateral decision to bulldoze the restored Chris Cross antennas and their mountings, thereby bringing to a sudden and tragic end one of the world's most remarkable solar radio telescopes. Subsequent to this inglorious event, two of the 13.7m FST antennas were relocated to the Australia Telescope National Facility headquarters at Marsfield, Sydney (as part of SKA experimentation), and all that now remains at Fleurs to remind visitors of the invaluable contributions that the Chris Cross, Mills Cross and Shain Cross made to international radio astronomy (see Orchiston and Slee, 2002) are the four remaining rusting large dishes associated with the FST.

8 NOTES

1. In the past, both authors had close associations with the Chris Cross. Don Mathewson was involved in the construction and early operation of the Cross, while Wayne Orchiston used the Cross and produced the daily solar maps during the final year that this radio telescope was maintained by the CSIRO's Division of Radiophysics, before it was handed over to the University of Sydney.
2. "Taffy" was Dr E.G. (Taffy) Bowen, Chief of the Division of Radiophysics.
3. The original plan was to install the Kennedy Dish at the Murraybank field station, and use it for H-line research (see Wendt, 2008).
4. By the time routine Fleurs Compound Interferometer observations began, Christiansen had already left the Division of Radiophysics and accepted a Chair in the School of Electrical Engineering at the University of Sydney. For the background to this transfer see Sullivan (2005).
5. This is discussed in the letter reproduced here in the Appendix.

9 ACKNOWLEDGEMENTS

We are grateful to the Australia Telescope National Facility, Dr John Leahy (CSIRO Telecommunications and Industrial Physics) and Don Whiteman (Astronomical Society of New South Wales) for kindly supplying Figures 1, 3, 8-10, 12-14, 18-21, 31, 38, 42-43 and 48-56. We also wish to thank Professor Bruce Slee (Australia Telescope National Facility, and Centre for Astronomy, James Cook University), Ron Stewart (Centre for Astronomy, James Cook University), Professor Richard Strom (ASTRON, the Netherlands, and Centre for Astronomy, James Cook University) and Dr Harry Wendt (Centre for Astronomy, James Cook University) for reading and commenting on the manuscript.

10 REFERENCES

- Aerials at "Fleurs" Field Station (1964). National Archives of Australia (Sydney): A1/3/1.
- Athay, R.G., and Moreton, G.E., 1961. Impulsive phenomena of the solar atmosphere. I. Some optical events associated with flares showing explosive phase. *Astrophysical Journal*, 133, 935-945.
- Bracewell, R., 2005. Radio astronomy at Stanford. *Journal of Astronomical History and Heritage*, 8, 75-86.
- Bracewell, R.N., and Swarup, G., 1961. The Stanford microwave spectroheliograph antenna, a microsteradian pencil beam antenna. *IRE Transactions on Antennas Propagation*, AP-9, 22-30.
- Christiansen, W.N., 1953. A high-resolution aerial for radio astronomy. *Nature*, 171, 831-833.
- Christiansen, W.N., 1960. Letter to E.G. Bowen, dated 15 September. National Archives of Australia (Sydney): A1/3/1.
- Christiansen, W.N., 1967. Techniques for decimetre wavelength observations of radio plages and bursts. *Proceedings of the Astronomical Society of Australia*, 1, 55.
- Christiansen, W.N., 1984. The first decade of solar radio astronomy in Australia. In Sullivan, 113-131.
- Christiansen, W.N., and Mathewson, D.S., 1958. Scanning the Sun with a highly directional array. *Proceedings of the Institute of Radio Engineers*, 46, 127-131.
- Christiansen, W.N., and Mathewson, D.S., 1959. The origin of the slowly varying component. In Bracewell, R.N. (ed.). *Paris Symposium on Radio Astronomy*. Stanford, Stanford University Press. Pp. 108-117.
- Christiansen, W.N., and Mullaly, R.F., 1963. Solar observations at a wavelength of 20 cm with a crossed-grating interferometer. *Proceedings of the Institution of Radio Engineers, Australia*, 2, 165-173.
- Christiansen, W.N., and Warburton, J.A., 1953. The distribution of radio brightness over the solar disk at a wavelength of 21 cm. I. A new highly directional aerial system. *Australian Journal of Physics*, 6, 190-202.
- Christiansen, W.N., and Warburton, J.A., 1955a. The distribution of radio brightness over the solar disk at a wavelength of 21 cm. III. The quiet Sun—two-dimensional observations. *Australian Journal of Physics*, 8, 474-486.
- Christiansen, W.N., and Warburton, J.A., 1955b. The Sun in two-dimensions at 21cm. *The Observatory*, 75, 9-10.
- Christiansen, W.N., Mathewson, D.S., and Pawsey, J.L., 1957. Radio pictures of the Sun. *Nature*, 18, 944-946.
- Christiansen, W.N., Yabsley, D.E., and Mills, B.Y., 1949a. Eclipse observations of solar radiation at a wave-length of 50 cm. *Nature*, 164, 635-637.
- Christiansen, W.N., Yabsley, D.E., and Mills, B.Y., 1949b. Measurements of solar radiation at a wavelength of 50 centimetres during the eclipse of November 1, 1948. *Australian Journal of Scientific Research*, 2, 506-523.
- Christiansen, W.N., Labrum, N.R., McAlister, K.R., and Mathewson, D.S., 1961. The crossed-grating interferometer: a new high-resolution radio telescope. *Proceedings of the Institution of Electrical Engineers*, 108B, 48-58.
- Covington, A.E., 1984. Beginnings of solar radio astronomy in Canada. In Sullivan, 317-334.
- Dagkesamanskii, R.D., 2007. The Pushchino Radio Astronomy Observatory: origin and first decade's history. *Astronomische Nachrichten*, 328, 395-404.
- Denise, J.L., 1984. The early years of radio astronomy in France. In Sullivan, 303-315.
- Drake, F.D., 1959. *Annual Report of the National Radio Astronomy Observatory*. Greenbank, NRAO.
- Gum, C.S., and Pawsey, J.L., 1960. Radio data relevant to the choice of a galactic coordinate system. *Monthly Notices of the Royal Astronomical Society*, 121, 150-163.
- Hachenberg, O., and Wallis, G., 1961. Das Spektrum der Bursts der Radiofrequenzstrahlung der Sonne im cm-Wellenbereich. *Zeitschrift für Astrophysik*, 52, 42-72.
- Krishnan, T., and Labrum, N.R., 1961. The radio brightness distribution on the Sun at 21 cm from combined eclipse and pencil-beam observations. *Australian Journal of Physics*, 14, 403-419.
- Krishnan, T., and Mullaly, R.F., 1961. Decimetre radio bursts concurrent with solar Type IV radiation. *Nature*, 192, 58-59.
- Krishnan, T., and Mullaly, R.F., 1962. The decimetre wavelength radiation associated with Type IV solar radio bursts. *Australian Journal of Physics*, 15, 85-95.
- Labrum, N.R., 1960. The radio brightness of the quiet Sun at 21 cm wavelength near sunspot maximum. *Australian Journal of Physics*, 13, 700-711.
- Labrum, N.R., Harting, E., Krishnan, T., and Payten, W.J., 1963. A compound interferometer with a 1.5 minute of arc fan beam. *Proceedings of The Institution of Radio Engineers, Australia*, 2, 148-155.
- Labrum, N.R., Krishnan, T., Payten, W.J., and Harting, E., 1964. Fan-beam observations of radio sources at 21cm wavelength. *Australian Journal of Physics*, 17, 323-339.
- Mills, B.Y., 1984. Radio sources and the log N – log S controversy. In Sullivan, 147-165.
- Mills, B.Y., and Little, A.G., 1953. A high-resolution aerial system of a new type. *Australian Journal of Physics*, 6, 272-278.
- Mullaly, R.F., 1961. Evidence for the transfer of corpuscles to distant parts of the Sun following a solar radio burst. *Australian Journal of Physics*, 14, 540-543.
- Mullaly, R.F., and Krishnan, T., 1963. Solar decimetre radio bursts. *Australian Journal of Physics*, 16, 8-23.
- Orchiston, W., 2004. The rise and fall of the Chris Cross: a pioneering Australian radio telescope. In Orchiston, W., Stephenson, R., Débarbat, S., and Nha, I.-S. (eds.). *Astronomical Instruments and Archives From the Asia-Pacific Region*. Seoul, IAU Commission 41. Pp. 157-162.
- Orchiston, W. (ed.), 2005. *The New Astronomy: Opening the Electromagnetic Window and Expanding our View of Planet Earth*. Dordrecht, Springer.
- Orchiston, W., and Slee, B., 2002. The flowering of Fleurs: an interesting interlude in Australian radio astronomy. *ATNF News*, 47, 12-15.
- Orchiston, W., and Slee, B., 2005. The Radiophysics field stations and the early development of radio astronomy. In Orchiston, 119-168.
- Orchiston, W., and Steinberg, J.-L., 2007. Highlighting the history of French radio astronomy. 2: the solar eclipse observations of 1949-1954. *Journal of Astronomical History and Heritage*, 10, 11-19.
- Orchiston, W., Lequeux, J., Steinberg, J.-L., and Delannoy, J., 2007. Highlighting the history of French radio astronomy. 3: the Würzburg antennas at Marcoussis, Meudon and Nançay. *Journal of Astronomical History and Heritage*, 10, 221-245.
- Orchiston, W., Steinberg, J.-L., Blum, J.-E., Pick, M., and Boischot, A., 2009. Highlighting the history of French radio astronomy. 4: early solar research at the École Normale Supérieure, Marcoussis, and Nançay. *Journal of Astronomical History and Heritage*, 12, in press.
- Parijskij, Y.N., 2007. The Big Pulkovo Radio Telescope and Pulkovo radio astronomy. *Astronomische Nachrichten*, 328, 405-410.
- Salomonovich, A.E., 1984. The first steps of Soviet radio astronomy. In Sullivan, 268-288.
- Smith, F.G., 2007. Early Cambridge radio astronomy. *Astronomische Nachrichten*, 328, 426-431.
- Stewart, R.T., 2009. Contribution of the CSIRO Division of Radiophysics Penrith and Dapto Field Stations to International Solar Radio Astronomy. Ph.D. Thesis, Centre for Astronomy, James Cook University.
- Strom, R., 2005. Radio astronomy in Holland before 1960: just a bit more than HI. In Orchiston, 93-106.
- Sullivan III, W.T. (ed.), 1985. *The Early Years of Radio Astronomy. Reflections Fifty Years after Jansky's Discovery*. Cambridge, Cambridge University Press.

- Sullivan III, W.T., 2005. The beginnings of Australian radio astronomy. *Journal of Astronomical History and Heritage*, 8, 11-32.
- Takakura, T., 1960. Microwave bursts of solar radio emission. *Publications of the Astronomical Society of Japan*, 12, 55-62.
- Tanaka, H., 1984. Development of solar radio astronomy in Japan up until 1960. In Sullivan, 335-348.
- The Fleurs Synthesis Telescope. Special issue of the *Proceedings of the Institution of Radio and Electronic Engineers Australia*, 34(8), 301-355 (1973).
- Twiss, R.Q., Carter, A.W.L., and Little, A.G., 1960. Brightness distribution over some strong radio sources at 1427 Mc/s. *The Observatory*, 80, 153-159.
- Twiss, R.Q., Carter, A.W.L., and Little, A.G., 1962. Radio source interferometry at 1427 Mc/s. *Australian Journal of Physics*, 15, 378-386.
- Van Woerden, H., and Strom, R.G., 2006. The beginnings of radio astronomy in the Netherlands. *Journal of Astronomical History and Heritage*, 9, 3-20.
- Wendt, H., 2008. The Contribution of the CSIRO Division of Radiophysics Potts Hill and Murraybank Field Stations to International Radio Astronomy. Ph.D. Thesis, Centre for Astronomy, James Cook University.
- Wendt, H., Orchiston, W., and Slee, B., 2008a. The Australian solar eclipse expeditions and 1947 and 1949. *Journal of Astronomical History and Heritage*, 11, 71-78.
- Wendt, H., Orchiston, W., and Slee, B., 2008b. W.N. Christiansen and the development of the solar grating array. *Journal of Astronomical History and Heritage*, 11, 173-184.
- Wendt, H., Orchiston, W., and Slee, B., 2008c. W.N. Christiansen and the initial Australian investigation of the 21cm hydrogen line. *Journal of Astronomical History and Heritage*, 11, 185-193.

11 APPENDIX

The following letter, dated 15 September 1960, from Professor W.N. Christiansen to Dr E.G. Bowen, discusses the development of the Fleurs Compound Interferometer, and is reproduced here in full.

Dear Dr Bowen,

At your suggestion, and before I leave for Holland, I am setting down the arrangements which were made in connection with the new multi-aerial interferometer at Fleurs, on which I was working before I left the Division of Radiophysics. These arrangements were made at a meeting in May at which you and Dr. Pawsey and I discussed the possibility of co-operation in research between your Division and the School of Electrical Engineering at the University of Sydney. At this meeting we decided that I should have no responsibility for the solar work being conducted at Fleurs but should be available for advice if required.

We decided, also, that the new project, which involves a combination of a grating interferometer with a 60' paraboloid and the extensive use of preamplifiers to improve the sensitivity of the equipment, should be carried out jointly, under the direction of Dr. Pawsey, by your Division and the School of Electrical Engineering. The purpose of this work is to produce a system which has a single fan-beam of angular dimensions $\times 1^\circ$ and adequate sensitivity (roughly equal to that of the two-aerial interferometer of the California Institute of Technology) for a detailed study of the shapes of radio sources.

The time-table which was suggested involved about one year's observations after the completion of the instrument. It was thought probable that, at the end of this time, the 60' paraboloid would be removed to Parkes.

I consulted the Vice-Chancellor of the University on this co-operative venture and obtained his approval. Subsequently I arranged for two people on the lecturing staff of the School, Murray and Docherty, to work on this project. So far they have spent what time was available to them on the aspects of the work which involve the measurement and adjustment of the relative phases of the different aerials of the system. In addition I have obtained the approval of the Vice-Chancellor to engage an electrical technician for a period of one year; the technician will spend all of his time on this project.

It appears that good progress has been made on the project, and I am confident that it will be successful. I hope that it will provide a pattern for future co-operative ventures of the Division of Radiophysics and the School of Electrical Engineering.

Yours sincerely

Dr Wayne Orchiston is a Reader in the Centre for Astronomy at James Cook University, and is particularly interested in the history of radio astronomy in Australia, France and New Zealand. He is editor of the book *The New Astronomy: Opening the Electromagnetic Window and Expanding our View of Planet Earth* (Springer, 2005) which contains various papers on the history of radio astronomy, and chairs the IAU Working Group on Historic Radio Astronomy.

Don Mathewson joined Chris Christiansen at Fleurs in 1955, and helped him build the Chris Cross. Don lived at Fleurs with the Division of Radiophysics construction team, comprising Charlie Chenhall, Sid Hucker, Bill and George Coulter and Charlie Turrell. One of the proudest moments in Don's life was when he was invited into St. Marys to join them for their after-work beers and later to share their evening meals in a gypsy-style caravan parked on site at Fleurs. Life was not exactly 'a bed of roses': ten-hour days were the norm; the tents were draughty; there was only rainwater on site; an overhead bucket with a tap served as a shower, although everybody mostly used a large wash basin on the tank stand; a chocolate wheel was our toilet; all meals were cooked on 'Elsie' an old woodstove sheltered from the elements by corrugated iron; and any differences were settled by fisticuffs, generally after dinner—all very gentlemanly (and all very Australian)!

Don left Fleurs in August 1958 and presented some of the Chris Cross results at the Paris Symposium on Radio Astronomy. Then he spent several years at Jodrell Bank using the newly-commissioned 250ft Dish. During this time he visited Bologna University three times as a consultant for the Italian Northern Cross antenna which was inspired by the Chris Cross.

Returning to Australia, Don went back to Fleurs with two physics students, John Healey and John Rome, and used the 60ft (Kennedy) Dish at the eastern end of the Chris Cross to survey the Milky Way at 20cm. Later this map was regularly used as a finding chart for the Parkes Dish.

After three years at Parkes, Don worked in the US and Holland and then joined Mount Stromlo and Siding Spring Observatories, which he directed from 1977 to 1986. In 1995 he was farewelled at the Heron Island Workshop on Large Scale Motions in the Local Universe, although he remained active in astronomy as a Vice President of the IAU.