



UNIVERSITY OF LEEDS

This is a repository copy of *An Instrumented Walking-Aid to Assess and Retrain Gait*.

White Rose Research Online URL for this paper:
<http://eprints.whiterose.ac.uk/88038/>

Version: Accepted Version

Article:

Culmer, PR, Brooks, PC, Strauss, DN et al. (4 more authors) (2014) An Instrumented Walking-Aid to Assess and Retrain Gait. *IEEE Transactions on Mechatronics*, 19 (1). 141 - 148. ISSN 1083-4435

<https://doi.org/10.1109/TMECH.2012.2223227>

Reuse

Unless indicated otherwise, fulltext items are protected by copyright with all rights reserved. The copyright exception in section 29 of the Copyright, Designs and Patents Act 1988 allows the making of a single copy solely for the purpose of non-commercial research or private study within the limits of fair dealing. The publisher or other rights-holder may allow further reproduction and re-use of this version - refer to the White Rose Research Online record for this item. Where records identify the publisher as the copyright holder, users can verify any specific terms of use on the publisher's website.

Takedown

If you consider content in White Rose Research Online to be in breach of UK law, please notify us by emailing eprints@whiterose.ac.uk including the URL of the record and the reason for the withdrawal request.



eprints@whiterose.ac.uk
<https://eprints.whiterose.ac.uk/>

An Instrumented Walking-Aid to Assess and Retrain Gait

Peter R. Culmer, Peter C. Brooks, Daniella N. Strauss, Denise H. Ross, Martin C. Levesley,
Rory J. O'Connor, Bipin B. Bhakta

Abstract— An instrumented walking-aid, the iWA system, has been developed to measure kinematic and kinetic properties of walking aid (WA) use and deliver feedback to improve gait. The clinical requirements, technical specification and design of the system are developed through clinical collaboration. The development of the system is described, including hardware components and data analysis used to process the measured data for assessment. The system measurements are validated under controlled laboratory conditions. The iWA system is evaluated in a typical UK clinical environment by a participant in a rehabilitation session. The resultant data successfully capture the quality of the participant's walking aid use and agree with clinical opinion, supporting the efficacy of this approach.

Index Terms— Biomedical telemetry, Medical information systems, Rehabilitation robotics

I. INTRODUCTION

Walking is a fundamental human activity. When this ability is affected by illness or injury, people prioritise it as a goal of treatment [1]. Up to 10% of adults suffer from reduced mobility or balance as a result of conditions such as stroke, osteoarthritis or limb loss which affect balance and gait. In Europe and North America walking aids¹ (e.g. a stick or crutch) are the most commonly prescribed intervention to improve balance and mobility in this population [2].

Using a WA serves two key functions; it allows the user to better support their weight (by reducing the magnitude of the load borne by their legs) and to improve their balance (by increasing the body's base of support) [3]. A user's requirement of these WA functions varies due to factors including

morbidity, age and size. Individuals typically receive training in WA use during rehabilitation sessions within a hospital environment and will participate in prescribed exercises until their next clinical assessment. Clinicians guide WA usage according to their function and recovery; for example, asking a user to progressively decrease WA loading as they become more accustomed to a new prosthesis.

Assessing WA use is critical, firstly to ensure the user meets their rehabilitation objectives and secondly to avoid the user developing conditions associated with overuse of the upper limbs (e.g. carpal tunnel syndrome). Clinical assessment of WA use focuses on its key functions to support weight and enhance balance. Currently, due to the lack of clinically appropriate measurement equipment these assessments are subjective and qualitative. The availability of objective, quantitative data on WA use has the potential to lead to improved WA designs and improve rehabilitation treatment for the user [3,4].

Several groups have addressed this clinical need by using instrumentation to record WA movement and/or load. In early work Klenermen et al [5] attached a load cell to a WA to record force during use. A similar approach was adopted in [6], however both systems were tethered and WA movement was not monitored. This was addressed in works using optical motion-tracking systems to measure WA movement [4,7,8] but such methods are limited to laboratory environments due to their size and complexity. The introduction of MEMs sensors and wireless telemetry technology has catalysed advancements in this area. The 'Smart Cane' records data from load and orientation sensors in a custom WA and broadcasts it to a remote computer for storage and analysis [9]. A similar approach by Merret et al used low-cost sensing hardware [10]. Instrumented shoes have also been developed for walking assessment using this technology [11,12] which complement instrumented WAs but targeted at people who do not require a WA. For those with more severe impairment a 'cane-robot' system has been developed to monitor and actively assist walking [13]. However, despite recent advancements there are a dearth of systems that have been evaluated with typical WA users in clinical environments.

There is a clear clinical need to develop an instrumented WA that can quantitatively measure, store and assess its use. The information would benefit clinicians and WA users by informing rehabilitation and helping WA manufacturers improve existing systems. We approached this challenge by working closely with a WA user group (consisting of WA users

Manuscript received April 16, 2012. This publication presents independent research commissioned by the National Institute for Health Research (NIHR) under the Invention for Innovation (i4i) programme. The views expressed in this publication are those of the authors and not necessarily those of the NHS, the NIHR or the Department of Health.

P. R. Culmer, P. C. Brooks and M. C. Levesley are with the School of Mechanical Engineering, University of Leeds, U.K. (e-mail: p.r.culmer@leeds.ac.uk; p.c.brooks@leeds.ac.uk; m.c.levesley@leeds.ac.uk)

D. N. Strauss is with the School of Sports and Exercise Science, University of Leeds, UK (email: D.N.Strauss@leeds.ac.uk)

D. H. Ross is with the Physiotherapy Department, Leeds Teaching Hospitals National Health Service Trust, Leeds, UK (email: denise.ross@leedsth.nhs.uk)

R. J. O'Connor and B. B. Bhakta are with the Academic Department of Rehabilitation Medicine, Leeds Institute for Molecular Medicine, University of Leeds, UK and also the Leeds Teaching Hospitals National Health Service Trust, Leeds, UK (email: r.j.o'connor@leeds.ac.uk; B. B. Bhakta@leeds.ac.uk)

¹ The term 'walking aid' encompasses a range of assistive devices including crutches and walkers; however here we use the acronym WA to specifically refer to the walking stick/cane.

and clinicians) to develop a prototype system for evaluation which is acceptable to users and clinically appropriate.

II. SYSTEM DESCRIPTION

A. Clinical Requirements

The aim is to develop an instrumented walking aid (iWA) that captures data on WA use to inform gait rehabilitation and provide automated and timely user feedback on performance.

An expert user-group, composed of rehabilitation clinicians and therapists from the UK National Health Service (NHS) and WA users, were consulted to develop clinical requirements for iWA. These state that iWA should:

- capture objective, clinically relevant data on WA use
- feedback information to the user and therapist on:
 - the amount of WA use (time and/or distance)
 - the mode of WA use (movement and load)
- permit free, unrestricted movement
- record WA use over time to inform future rehabilitation

B. Technical Specification

A technical specification for iWA was developed from the clinical requirements. The principle need is to characterise how the WA is used. To achieve this it was considered necessary to measure kinetic (WA load) and kinematic (WA orientation) aspects of WA use and relate these to the walking cycle. The WA load force is directly related to the support provided to the user. The WA orientation is informative because it provides information on how the stick is positioned for balance and support when it is loaded.

Use of iWA is divided into WA ‘activities’, pre-defined by the expert user-group, to provide context to collected data, for example ‘short walk’ or ‘walk up stairs’. The activity type is selected by the user from a menu on the PDA (see Fig. 2b). During each activity the WA measurements must be continuously recorded by a portable data acquisition device that does not impede the user (e.g. alter or restrict their gait). To capture the transient signal content of human gait and WA movement requires a sample rate of 150Hz or above [14]. The data capture system must also feedback performance data to the user during the activity.

C. System Overview

iWA is based on an unmodified WA, as used within the UK NHS, augmented with custom instrumentation, as shown in

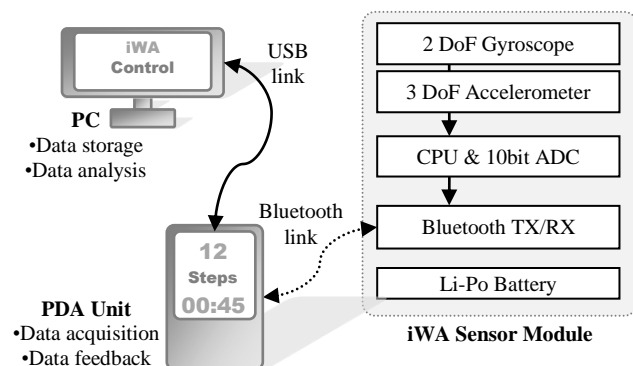

Fig. 1. A schematic illustrating key components of the iWA system.

Fig. 1. A load cell assembly is located near the foot of the WA to measure axial load. The iWA sensor module contains the remaining components in a custom housing located near the WA’s handle. The sensor module has a compact footprint which aims to minimise any impact on the user’s gait. An electronic Inertial Measurement Unit (IMU) is used to determine the orientation of the WA. The IMU is integrated with a data acquisition system and Bluetooth® communications module. This transmits sensor data wirelessly to a portable digital assistant (PDA) which acts as a data storage/feedback device and is carried by the user. The PDA uses custom software to process the data stream from the sensors, record it to a storage card and provide real-time visual feedback to the user. A PC is used to provide more computationally intensive data analysis and feedback functions. The PC connects to the PDA via a USB cable to transfer recorded data and configure user specific information (e.g. feedback configuration)

1) iWA Sensor Module

A commercially available IMU was selected for iWA to provide a cost-effective sensor module with integrated Bluetooth® functionality in a compact package (Sparkfun Electronics, SEN-08454). The IMU is composed of a 2 degree of freedom (DoF) gyroscope (InvenSense Inc., IDG-500) which measures angular velocity and a 3 axis accelerometer (Freescale Semiconductor Inc., MMA7260Q) which measures linear acceleration. The IMU also includes a 3 DoF magnetometer module which is not used in this application because the changing magnetic fields around medical environments would compromise its measurements. The gyroscope and accelerometer data of the IMU provide the inputs to a Kalman filter that calculates the orientation of iWA with respect to gravity, as described in Section IID.

Data acquisition functions on the IMU are conducted using an embedded microcontroller (NXP Semiconductors, LPC2138 with 10bit ADCs). The microprocessor performs 3 key functions in iWA; it digitises the sensor signals, broadcasts data packets via a serial Bluetooth® transceiver and provides an interface for adjusting data acquisition parameters such as sampling frequency and sensor gain. The Bluetooth® transceiver provides the two-way wireless communication interface between the IMU and the PDA. The data acquisition system is configured to acquire, transmit and store data from the IMU sensors at 150Hz. This rate ensures that movement data can be appropriately filtered to remove noise and aliasing

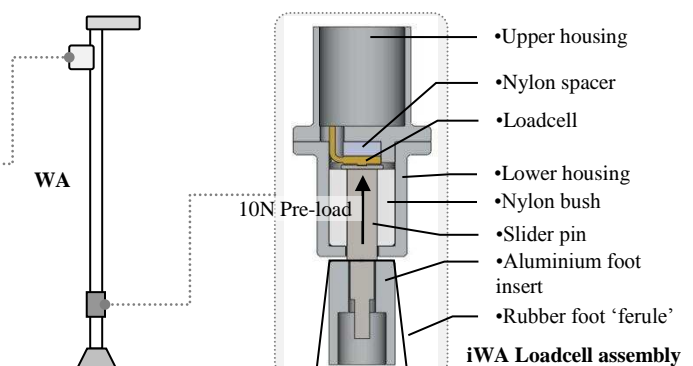

artefacts to obtain a high fidelity representation of walking-aid use

A lithium polymer battery provides a light-weight (22g) and compact (53 x 33 x 5.7 mm) power source for iWA. The battery provides 8.2V nominal with a capacity of 1100mAh which enables iWA to run for up to 12 hours of continuous active use before being charged through a socket integrated into the IMU casing.

A nylon housing is used to protect and mount the sensor unit on the iWA. The housing has an integral clamp to hold the unit securely on an unmodified walking-aid shaft, a power switch and a charging connector. LEDs are embedded into the structure to indicate power and data connectivity states.

2) Loadcell Assembly

A custom load cell assembly (Fig. 1.) was designed and manufactured to house the load cell at the foot of iWA and meet two requirements:

- to freely transfer axial load to a load cell for measurement
- to isolate the load cell from off-axis loads/torques

These requirements are necessary to prevent damage to the load cell and ensure that it measures an accurate representation of the axial load placed through iWA. This was achieved using a stainless steel slider pin that is constrained to move axially within the assembly by a low-friction polymer bushing that has low wear characteristics (DuPont, Delrin®). A compressive 1 DoF load cell (RDP Electronics Ltd., SLC13/0250. 0.5% FS linearity, 1.1KN max) was selected for its compact footprint (12.7mm dia x 3.8mm height) to measure the axial force. A 10N pre-load is applied to the load cell during assembly to maintain the load cell in compression (as recommended by the manufacturer) and ensure that the assembly acts as a rigid body. A single-chip instrumentation amplifier (Texas Instruments Inc., INA125) provides a precision regulated 5V power supply to the load cell and amplifies the output signal for digitisation. A gain factor of 465 is used to provide an output voltage of 0-3.3V over a load range of 0-800N. The amplified load cell output signal is digitised by an ADC channel on the IMU.

3) PDA Unit

A PDA (Hewlett-Packard, iPAQ 214) was selected in accordance with the technical specification to provide a portable data storage and feedback unit which can be worn with minimum inconvenience to the user (dimensions 75 x 18 x 134 mm, mass 190 g, storage 4 Gb). The PDA includes Bluetooth® functionality and a large high-clarity screen (dimensions 101 x 76 mm, resolution 640 x 480), for clearly presenting visual feedback to the user.

The PDA runs custom software written using the LabVIEW Development Environment (National Instruments Corp.). The software has a user-interface (UI) that enables the user to control the iWA system; WA activities can be selected, started and then stopped via touch-sensitive controls on the screen, shown in Fig. 2. When the user starts an activity a Bluetooth® connection is opened between the PDA and iWA sensor unit and the sensors are placed into an active powered state. The PDA transmits configuration information to the sensor unit and the data acquisition process is initiated accordingly. The data

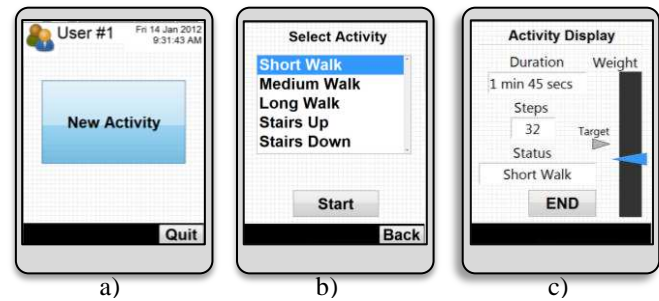

Fig. 2. The iWA PDA user interface allowing the user to initiate a new activity (a), log its type (b), see their current progress and end the activity (c).

acquisition then begins and a serial stream of time-stamped sensor data is transmitted to the PDA from the iWA sensor unit. The data is parsed into discrete samples and written to the SD memory card on the PDA. In parallel it is analysed to drive a visual feedback display that consists of the elapsed time and steps taken since the activity began. The step-detection algorithm is discussed in Section 2D. When the user stops the activity on the PDA the Bluetooth® connection is closed and the IMU places the sensors in a low power state.

D. Data Analysis

The technical specification in Section II B requires information on the WA's axial load and orientation. These data should be measured relative to the walking cycle to segment the time series and allow specific inspection of loading phases that provide the user with support. These elements are obtained through analysis of the IMU and loadcell sensor signals.

1) WA Axial Load

The axial load through the WA is directly measured through the loadcell assembly. The load signal is then filtered using a 2nd order low-pass Butterworth filter to attenuate high-frequency noise. A cut-off frequency of 10Hz is appropriate for human movement applications [14].

2) Walking Cycle Phase

The walking cycle is considered as comprising two phases; loading and positioning. The loading phase begins with the WA foot in front of the user with the handle leaning towards them. The user then takes two steps, loading the WA for support and balance, to move forward. The positioning phase follows as the user relocates the WA's foot for the next loading phase. An algorithm was developed to detect and count loading phases from the axial load data. A peak counting method delineates the positioning phase (where there is zero load) and loading phases when the load exceeds both magnitude (F_{load}) and duration (T_{load}) thresholds. This algorithm was implemented on the PDA to provide real-time feedback to the user on the total steps taken (where 1 loading phase = 2 steps), as shown in Fig. 2C.

3) WA Orientation

The WA orientation is calculated from the accelerometer and gyroscope components of the IMU using Kalman methods to reconstruct absolute position from the input sensor data.

WA orientation is expressed relative to a global Cartesian coordinate system; the gravitational acceleration vector defines the Z axis and the XY ground plane is assumed to be level and perpendicular (e.g. the user is on flat ground). This assumption was discussed with the WA user group and deemed appropriate

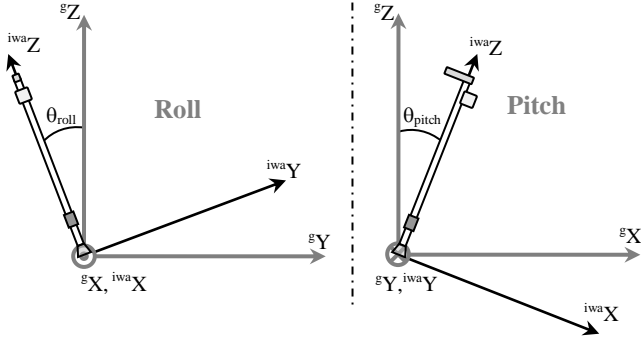

Fig. 3. The iWA coordinate system. Superscript ‘g’ and ‘iwa’ denote the global ground and local iWA frames respectively.

for the clinical environments in which iWA will be deployed.

The spherical coordinates θ_{roll} and θ_{pitch} are used to define the orientation of iWA relative to the global reference frame as shown in Fig. 3. In quasi-static conditions the acceleration measured by the iWA IMU is due only to gravity and the coordinates θ_{roll} and θ_{pitch} can be expressed simply as:

$$\theta_{roll} = \tan^{-1} \frac{a_y}{a_z}, \theta_{pitch} = \tan^{-1} \frac{a_x}{a_z} \quad (1)$$

In dynamic conditions iWA will experience and measure additional accelerations due to translational movement and centripetal forces induced as it is rotated. During human movement, the magnitude of dynamic components would invalidate the quasi-static assumption and thus orientation determined in (1) [15]. Kalman filter techniques are widely used to combine a range of sensor measurements and optimally predict the state of a modelled system [16,17]. In this context, they provide an effective means to determine an improved estimate of orientation under dynamic human movement conditions by using both accelerometer and gyroscope readings [18]. A model of the system being observed underpins the Kalman method. In this approach the roll and pitch orientations are considered to be decoupled and are thus treated independently. The iWA system is then described by the following linear state-space equations:

$$x_{k+1} = A \cdot x_k + B \cdot u_k = \begin{bmatrix} 1 & -\delta t \\ 0 & 1 \end{bmatrix} \cdot \begin{bmatrix} \theta_k \\ \rho_k \end{bmatrix} + \begin{bmatrix} 1 \\ 0 \end{bmatrix} \cdot \omega_k \quad (2)$$

$$y_k = \hat{\theta}_k = C \cdot x_k = \begin{bmatrix} 1 & 0 \end{bmatrix} \cdot \begin{bmatrix} \theta_k \\ \rho_k \end{bmatrix} \quad (3)$$

This model of the system estimates the angle in each axis ($\hat{\theta}$) by integrating the angular velocity (ω) and removing a bias (ρ) to account for drift errors in the gyroscope measurements. A discrete time Kalman filter was implemented through a series of iterative equations that estimate the angle and bias with reference to the directly measured (quasi-static) orientation (θ_m) derived from the accelerometers in (1). The Kalman equations partition into predictive and corrective stages, denoted by (-) and (+) superscripts respectively:

$$x_k^{(-)} = A \cdot x_{k-1}^{(+)} + B \cdot u_{k-1} \quad (4)$$

$$P_k^{(-)} = A \cdot P_{k-1}^{(+)} \cdot A^T + Q \quad (5)$$

$$S_k = C \cdot P_k^{(-)} \cdot C^T + R \quad (6)$$

$$K_k = P_k^{(-)} \cdot C^T \cdot S_k^{-1} \quad (7)$$

$$x_k^{(+)} = x_k^{(-)} + K_k \cdot (y_k - C \cdot x_k^{(-)}) \quad (8)$$

$$P_k^{(+)} = P_k^{(-)} - K_k \cdot C \cdot P_k^{(-)} \quad (9)$$

where P is the estimation error covariance, K the Kalman gain, Q the process noise covariance, S the estimation covariance and R the measurement error covariance. The parameters Q and R define the behaviour of the Kalman filter, biasing the filter to rely upon the most reliable information available at the current time.

The orientation estimations for $\hat{\theta}$ can be further improved because the entire data set is available (since it is being post-processed) by extending the Kalman filter with Rauch-Tung-Striebel (RTS) equations [19]. These update the Kalman estimate with a subsequent backward pass of the data. The RTS equations are defined as:

$$x_k^S = x_{k+1}^{(+)} + D_k \cdot (x_{k+1}^S - x_{k+1}^{(-)}) \quad (10)$$

$$D_k = P_k^{(+)} \cdot A^T \cdot P_{k+1}^{(-)}^{-1} \quad (11)$$

The Kalman filter must be initialised with an estimate of the model’s initial state. Although the RTS Kalman filter is more robust to poor initialisation it is desirable to provide the best possible estimate because the system will converge to a minimum error state more rapidly [19]. For iWA the initial state is measured using the on-board sensors to maintain a portable system. The most reliable direct measurement of system state is obtained when the system is closest to static conditions such that equation (1) applies. Inspection of a broad range of iWA data showed that this occurs at the beginning of each loading cycle and is well defined through the WA load cycle analysis. During post-processing the Kalman filter is initialised using the first such occasion that occurs in that set of data. The initial conditions are then defined as:

$$\begin{bmatrix} \theta_0 \\ \rho_0 \end{bmatrix} = \begin{bmatrix} \theta_{quasi-static} \\ 0 \end{bmatrix}; P_0 = Q \quad (12)$$

where $\theta_{quasi-static}$ is calculated from (1).

The orientation calculations described here were implemented on a PC for post-hoc processing. A real-time implementation of these methods on the PDA was deemed unnecessary because the resultant orientation data is intended for use by clinical staff (rather than the user) after each exercise has been completed.

E. System Validation

Tests were conducted to evaluate the kinematic and kinetic measurements made by the iWA system. It is crucial that the orientation and axial load data recorded by iWA are sufficiently accurate to provide clinically useful assessment.

1) Kinematic Validation

A 3D motion capture system (Northern Digital Inc., Optotrak Certus) was used to calibrate and validate the WA orientation measured by iWA. The system is widely used in human movement analysis and has excellent accuracy characteristics in rotational (0.04°) and linear (0.03mm) motion [20]. The iWA sensor housing was instrumented with four active Infra-red (IRED) markers which were used to identify the iWA as a rigid body using calibration routines supplied with the motion capture software. The coordinate system of the rigid body was defined to correspond with that of iWA, shown in Fig. 3. A second rigid body was used to define the coordinate system of the ground plane. The measurements made by iWA and the motion capture system were temporally synchronised at a

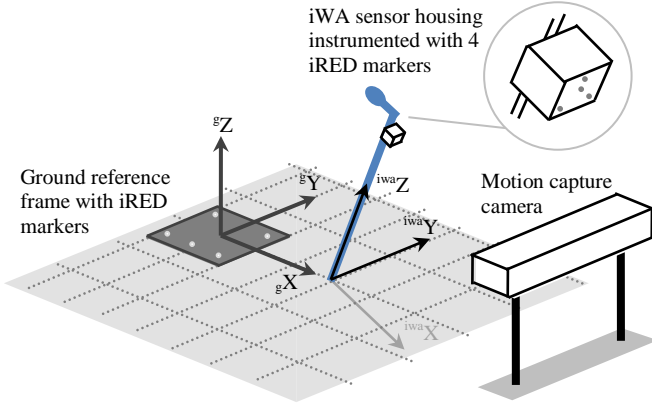

Fig. 4. The experimental configuration used to validate the iWA orientation measurements. Superscripts are used to denote coordinate frames sample rate of 150Hz using a common trigger signal connected to iWA via a wired tether. The experimental setup is summarised in Fig. 4.

The accuracy of the orientations calculated by iWA is dependent on the performance of the Kalman filter which must be tuned to represent the system. This entails identifying appropriate values for the measurement and process noise gains Q and R . The gains were determined by optimising the Kalman filter gains to minimise orientation error with respect to reference data from the motion tracking system. The Nelder-Mead non-linear optimisation algorithm was selected for this task because of its ability to find global minima in the parameter space [21]. Identical gains were used in roll and pitch and correspondingly the cost function of the optimisation was defined as the sum of the RMS roll and pitch errors.

To obtain representative validation data a research therapist used iWA in a series of 5 walking sequences. The range of the motion capture system restricted each sequence to 2-3 steps, dependent on stride length. The physiotherapist was asked to vary their speed and stride to emulate a range of WA conditions. A combined data set was generated by collating the first two steps of each trial. The orientation angles calculated by the iWA data processing routines were compared to the angles reported by the motion tracking system to determine error. Fig. 5 shows a typical example. It is apparent that error is far more significant for roll, rather than pitch, due to the lower range of movement in that axis. A summary of the results is presented in Table I which shows that the absolute errors in each orientation are similar and compare favourably to other methods used to measure and characterise human motion [15, 18].

2) Axial Load Validation

The load cell assembly was validated against a universal testing system (Hounsfield, Type W) that was configured to apply clinically representative compressive loading; the WA was placed in a vertical orientation (with respect to gravity) and load was applied at the handle mid-point (50mm from the longitudinal axis). A sine wave profile (150 N amplitude) at three frequencies (0.25, 0.5 and 1Hz) was used to reflect the temporal characteristics of typical WA use. Fig. 5 shows a representative example of the response. Peak errors occur at the onset of loading, likely due to mechanical stiction effects in the loadcell assembly. At zero load there is evidence of a small degree of steady-state error. The error characteristics

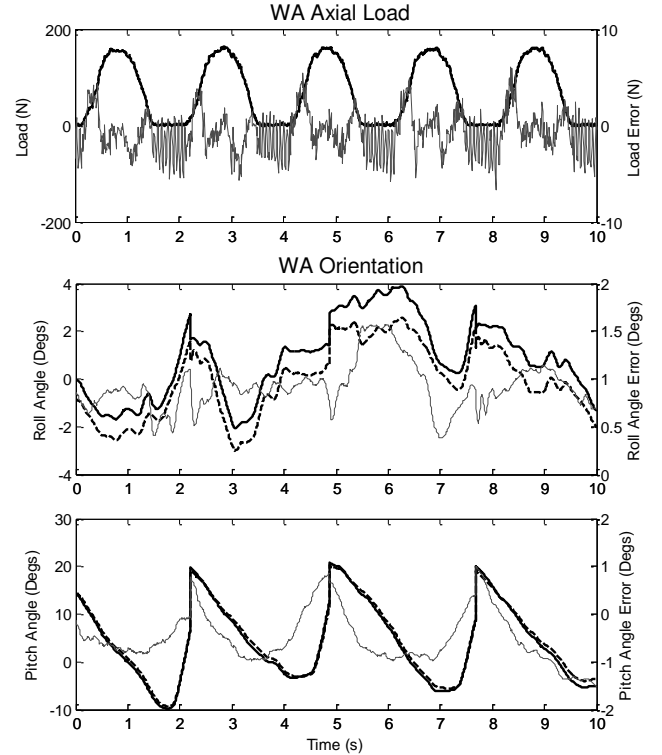

Fig. 5. Validation of iWA measurements; axial load with off-axis loading at 0.25Hz (top), roll angle (middle), pitch angle (bottom).

KEY: Reference (dashed black), Measured (solid black), Error (grey, scale: right-hand axis)

were analysed across 10 load cycles for each frequency and the results are presented in Table I. The results demonstrate that the RMS percentage error is $\sim 1.5\%$ of the applied load with a consistent response across the operating frequencies. This response is close to the performance of the loadcell in isolation (error = 0.5% FS) demonstrating that the loadcell assembly is effective in rejecting off-axis loading and incurs relatively minor mechanical losses during operation.

III. CLINICAL EVALUATION

An experimental evaluation of iWA was conducted to assess the efficacy of using iWA with a typical user in a clinical rehabilitation setting. This entails addressing the clinical requirements in Section IIA, with an emphasis on the collection of primary WA movement data and using these to derive a clinically relevant assessment of performance.

A. Method

The data reported here involves a single participant, used as a representative case study, who gave written informed consent to take part in the evaluation. The participant is a 43 year old

TABLE I
KINEMATIC AND KINEMATIC ACCURACY OF THE IWA SYSTEM

	Error RMS	Error Std	Error Max
θ_{roll} (Degs)	0.95	0.25	2.10
θ_{pitch} (Degs)	0.73	0.54	2.70
Load @ 0.25 Hz (N)	2.38	2.13	6.94
Load @ 0.5 Hz (N)	2.25	2.13	6.68
Load @ 1.0 Hz (N)	2.21	2.27	6.74

Root mean square (RMS), Standard Deviation (Std)

female (height 1.7 m, weight 88 kg) with multiple sclerosis who uses a WA on her right side to aid mobility. No significant visual impairment or other co-morbidities were present. The participant used iWA in a clinical Functional Electrical Stimulation (FES) treatment session. The FES treatment was applied to help compensate against the effects of MS by applying small electrical impulses to stimulate affected leg muscles and thus improve gait [22]. The evaluation was approved by the University of Leeds and Leeds Teaching Hospitals NHS Trust Ethics Committees and clinically supervised throughout.

iWA was used to provide comparative data of the participant's WA use with and without FES applied. The participant was asked to complete two repetitions of a standardised 10m walk [23] along a level linoleum floor at a pace with which she felt comfortable. In each exercise data were recorded and analysed as described in Section IID to determine WA orientation, load and walking cycle phase. The walking cycle peak detection parameters were $F_{load} = 10$ N and $T_{load} = 0.5$ s, selected to avoid false triggering due to loadcell errors (see Table I) while remaining sensitive to 'light' WA loading. Summary metrics were calculated from these data to provide performance measures that capture quality of WA use for evaluation by the supervising physiotherapist. These metrics were designed, in conjunction with clinicians, to provide an objective measure of physical characteristics that would otherwise be judged subjectively in subject case notes:

- **Load:** the axial force through the WA during use (defined as RMS load as a percentage of body weight)
- **Movement:** movement of the WA during use (defined as the angular range in roll and pitch axes during loading)
- **Headway:** the effectiveness of the subject's assisted gait (defined as the number of load phases and total time).

B. Results

The participant completed the two sets of 10m walks with no

TABLE II
PERFORMANCE METRICS FROM THE IWA CLINICAL EVALUATION

	FES Off	FES On
Number of load phases	13	10
Therapist reported steps	26	20
Elapsed time (s)	27	20
RMS Load (% Body weight)	5.76 (2.29)	4.12 (0.65)
Pitch range (degs)	14.1 (4.4)	17.5 (4.7)
Roll range (degs)	4.0 (2.6)	4.9 (3.6)

Data pairs show: Mean (Standard Deviation)

report of discomfort or difficulties in using the iWA. Fig. 6 shows the time series data for each case (FES On vs FES Off). Shaded regions denote the loading phase of the WA cycle as determined by the step-counting algorithm. The pattern and magnitude of WA orientations are similar between cases and it is evident that WA pitch is the dominant characteristic. During the loading phase the WA roll remains near zero (the WA is upright) while WA pitch moves in a linear fashion from below zero (leaning toward the user) to plateau at a positive peak (leaning away from the user) at the phase mid-point. This corresponds to the axial load peak, indicating that the WA is being used to both push forward and support the user's weight. Comparing both cases reveals that load reaches higher peaks and is more variable with FES Off.

The summary metrics of these data are presented in Table II. The therapist supervising this study observed that with FES On the participant walked better and with less reliance on her WA. This clinical judgement shows strong agreement with the iWA metrics. The therapist documented the number of steps taken by the patient which corresponds to the load phases detected by the iWA (2 steps per load phase). The lower RMS Load magnitude indicates that the WA is relied on less for support and the variability suggests a more consistent walking cycle. The roll orientation is less revealing but the pitch metric shows an increased range of movement during the load phase, consistent with the user completing the task faster and with fewer load phases.

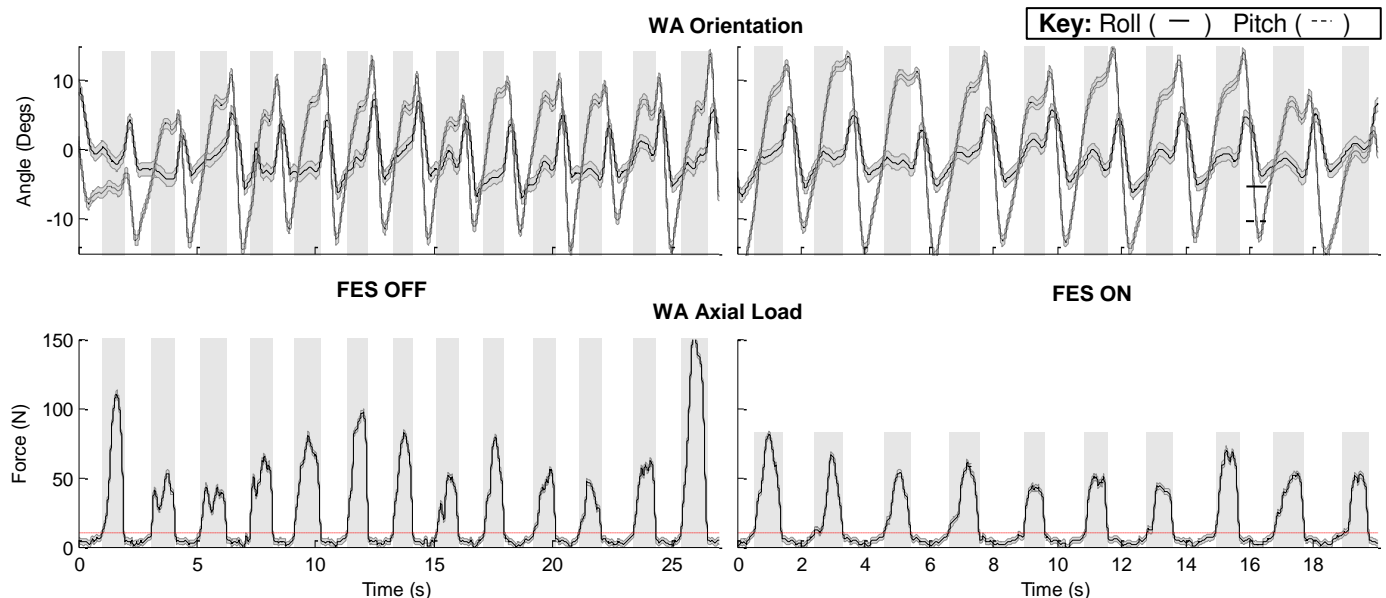

Fig. 6. WA orientation and load for a 10m walk with FES Off (left) and FES On (right). Vertical grey regions denote loading phases. RMS error (Table I) is plotted about each data series in light grey.

IV. DISCUSSION

The development of this first prototype iWA system placed an emphasis on producing a system that could capture clinically meaningful information to characterise WA use. The system validation in Section III demonstrates that the load and orientation data measured by iWA has errors which are appropriate for this application and similar in magnitude to comparable work in human movement analysis.

The system was successfully evaluated in clinical settings with the support of physiotherapists in the UK National Health Service. These outcomes were only possible through close collaboration between engineers, clinicians and WA users, underpinned by a clear set of clinical requirements. The study presents exemplar data from a single subject and should not be generalised. However, these preliminary data do reveal a number of insights to help guide future research in this area:

- Measurement of WA load provides a robust means to derive the WA phase
- WA movement is predominantly in the pitch axis
- Coupling WA orientation and load can reveal how the WA is used (e.g. showing that the user pushes forwards at the end of the loading phase)

The clinical team in this study were enthusiastic about the potential to use the iWA system for objective assessment of WA users. However, they also commented that it is crucial to present the resultant information in a concise and clear manner. This may necessitate forming compound measures from existing metrics to provide ‘high-level’ summary scores, e.g. ‘movement quality’ or ‘support level’. It is evident that further studies with a wider range of participants are required to comprehensively investigate these aspects and understand how to best compute clinically relevant outcomes.

V. CONCLUSIONS AND FUTURE WORK

An instrumented walking-aid, the iWA system, was developed from a series of clinical requirements. The system specification and design was informed in collaboration with expert clinicians and WA users. It consists of a walking-aid with an IMU and load cell assembly, together with a PDA which records data and controls the system. A Kalman filter is employed to determine orientation from the IMU data.

The iWA measurements of orientation and load were validated under laboratory conditions with motion-tracking and universal testing equipment respectively. The system was evaluated with a participant in a rehabilitation clinic, functioning as intended and successfully capturing data on WA use. The resultant performance metrics showed differences in the quality of WA use that agreed with the expert opinion of the supervising physiotherapist. These outcomes are encouraging and underline the efficacy of using an instrumented system such as iWA to objectively assess rehabilitation treatment.

Further development of iWA will be informed by conducting additional clinical evaluation of the system with a wide range of participants. This will be used to refine the iWA system (e.g. simplification of hardware) and its clinical use (e.g. improved performance scores for assessment and goal setting).

VI. ACKNOWLEDGEMENTS

The authors would like to thank the iWA user group and study participant for their enthusiasm and input to this work.

VII. REFERENCES

- [1] R.C. Holliday, C. Ballinger, and E.D. Playford, “Goal setting in neurological rehabilitation: patients’ perspectives,” *Disability and Rehabilitation*, vol. 29, 2007, pp. 389-394.
- [2] L.I. Iezzoni, E.P. McCarthy, R.B. Davis, and H. Siebens, “Mobility impairments and use of screening and preventive services,” *American Journal of Public Health*, vol. 90, 2000, pp. 955-961.
- [3] H. Bateni and B.E. Maki, “Assistive devices for balance and mobility: benefits, demands, and adverse consequences,” *Archives of Physical Medicine and Rehabilitation*, vol. 86, 2005, pp. 134-145.
- [4] A. Liggins, D. Coiro, G. Lange, T. Johnston, B. Smith, and J. McCarthy, “The case for using instrumented crutches during gait analysis”, *Proceedings of the IEEE Bioengineering Conference*, 2002, pp. 15-16.
- [5] L. Klenerman and W.C. Hutton, “A quantitative investigation of the forces applied to walking-sticks and crutches”, *Rheumatology and Rehabilitation*, vol. 12, 1973, pp. 152-158.
- [6] J. Engel, A. Amir, E. Messer, and I. Caspi, “Walking cane designed to assist partial weight bearing,” *Archives of Physical Medicine and Rehabilitation*, vol. 64, 1983, pp. 386-388.
- [7] C. Chen, H. Chen, M. Wong, F. Tang, and R. Chen, “Temporal stride and force analysis of cane-assisted gait in people with hemiplegic stroke”, *Archives of Physical Medicine and Rehabilitation*, vol. 82, 2001, pp. 43-48.
- [8] P.S. Requejo, D.P. Wahl, E.L. Bontrager, C.J. Newsam, J.K. Gronley, S.J. Mulroy, and J. Perry, “Upper extremity kinetics during Lofstrand crutch-assisted gait”, *Medical Engineering & Physics*, vol. 27, 2005, pp. 19-29.
- [9] W. Wu, L. Au, B. Jordan, T. Stathopoulos, M. Batalin, W. Kaiser, A. Vahdatpour, M. Sarrafzadeh, M. Fang, and J. Chodosh, “The SmartCane system: an assistive device for geriatrics”, *Proceedings of the ICST 3rd International Conference on Body Area Networks*, 2008, pp. 1-4.
- [10] G. Merrett, M. Ettabib, C. Peters, G. Hallett, and N. White, “Augmenting forearm crutches with wireless sensors for lower limb rehabilitation”, *Measurement Science and Technology*, vol. 21(12), 2010, pp 5-8.
- [11] K. Kyoungchul, M. Tomizuka, “A gait monitoring system based on air pressure sensors embedded in a shoe”, *IEEE/ASME Transactions on Mechatronics*, vol. 14(3), 2009, pp. 358-370.
- [12] C.B. Redd, S.J.M. Bamberg, “A wireless sensory feedback device for real-time gait feedback and training”, *IEEE/ASME Transactions on Mechatronics*, vol. 17(3), 2012, pp. 425-433.
- [13] K. Wakita, J. Huang, P. Di, K. Sekiyama, and T. Fukuda, “Human-Walking-Intention-Based Motion Control of an Omnidirectional-Type Cane Robot,” *IEEE/ASME Transactions on Mechatronics*, In Press, 2011, pp. 1 –12.
- [14] E.K. Antonsson and R.W. Mann, “The frequency content of gait”, *Journal of Biomechanics*, vol. 18(1), 1985, pp. 39-47.
- [15] A. Godwin, M. Agnew, and J. Stevenson, “Accuracy of inertial motion sensors in static, quasi-static, and complex dynamic motion” *Journal of Biomechanical Engineering*, vol. 131(11), 2009, pp. 114-19.
- [16] G. Welch and G. Bishop, “An Introduction to the Kalman Filter”, *University of North Carolina at Chapel Hill*, 1995.
- [17] R.G. Brown and P.Y.C. Hwang, “Introduction to Random Signals and Applied Kalman Filtering”, 3rd Ed. Wiley, 1996.
- [18] H.J. Luinge and P.H. Velthuis, “Measuring orientation of human body segments using miniature gyroscopes and accelerometers,” *Medical & Biological Engineering & Computing*, vol. 43(2), 2005, pp. 273-282
- [19] H.E. Rauch, F. Tung, C.T. Striebel, “Maximum Likelihood Estimates of Linear Dynamic Systems”, vol. 3(8), 1965, pp. 1445-50
- [20] X.L. Maletsky, J. Sun and N. Morton, “Accuracy of an optical active-marker system to track the relative motion of rigid bodies,” *Journal of Biomechanics*, vol. 40(3), 2007, pp. 682-685.
- [21] J.C. Lagarias, C. Jeffrey, J.A. Reeds, M.H. Wright and P.E. Wright, “Convergence Properties of the Nelder-Mead Simplex Method in Low Dimensions.” *SIAM Journal on Optimization*, vol. 9(1), 1998, pp. 112-47.
- [22] D.N. Rushton, “Functional electrical stimulation”, *Physiological Measurement*, vol. 18(4), 1997, pp. 241-75.
- [23] M.J. Watson, “Refining the Ten-metre Walking Test for Use with Neurologically Impaired People”, *Physiotherapy*, vol. 88(7), 2002, pp. 386-97.