

## Clara Silvia Roero

Dipartimento di Matematica  
"G. Peano"  
Università di Torino  
Via Carlo Alberto, 10  
10123 Torino ITALY  
[clarasilvia.roero@unito.it](mailto:clarasilvia.roero@unito.it)

Keywords: history of  
mathematics, Guarino  
Guarini, Pierre Hérigone,  
Gaspar Schott, Claude-  
François Milliet Dechaes,  
Christopher Clavius,  
Bonaventura Cavalieri,  
Grégoire Saint Vincent

## Research

### *Guarino Guarini and Universal Mathematics*

**Abstract.** Guarini considered the mathematical studies to be of fundamental importance for all artists and scholars. His own knowledge of mathematics was vast and profound. The aim of this present paper is to show, through an analysis of the most substantial of his mathematical works, *Euclides adauctus*, along with the *Appendix* to this printed a few months later, the role that philosophical and mathematical studies had on his cultural formation, on the new and original research that he conducted, and on his teaching activities, while looking for traces of the mathematical sources that he consulted and cited that indicate which authors and works exerted the greatest influence on him.

### *Introduction*

Guarino Guarini, in the dedication to Charles Immanuel II of Savoy of his most important scientific treatise, *Euclides adauctus et methodicus mathematicaque universalis*, printed in Torino in 1671, underlines the miraculous power that mathematics exerts on architecture, declaring that it is possible to draw on mathematics' most sublime ideas, a science that he sought to enrich with the fruits of his labour:

...but above all it is architecture that shines thanks to the distinguished and truly regal Thaumaturgy of the miracles of mathematics. ... Hereby receive, your Royal Highness, with benign visage and serene clemency, that which several times with the breadth of its ingeniousness in conceiving the most sublime ideas has fostered mathematics and all of the efforts of my work in adorning it.<sup>1</sup>

Guarini's predilection for mathematics over all other disciplines of learning is expressed more than once. It manifests itself concretely in his artistic creations, which make visible the beauty and harmony of forms born from his love of plane and solid geometry (cf. [Roero 2001]).

In his first work of a philosophical-scientific nature, *Placita Philosophica* (fig. 1), published in Paris in 1665, he upholds the importance of the knowledge of mathematics for all artists and scholars:

All the arts depend on either mathematics, philosophy or medicine, all sciences that examine similitude, proportion or the fittingness of things ... Thus, the more profound the artist's knowledge is regarding the things relative to his art, of the means and manners of applying them, the more excellent will he be judged, and the more perfect his works will be considered. In fact, when the artist sets himself to his task, he does well to choose the most suitable material, to have a perfect knowledge of his instruments, and the ties with all the things relative to the art, and finally to eliminate the devices used to create each thing. And since in the most difficult situations neither imagination nor intellect is sufficient, the devices drawn from these models can be applied most perfectly to the idea to be demonstrated and performed in that particular circumstance.<sup>2</sup>



Fig. 1. Frontispiece of Guarini's *Placita Philosophica*, 1665

In his final work, *Architettura Civile*, published posthumously in 1737 under the direction of Bernardo Vittone, Guarini explicitly states architecture's dependence on mathematics:

Of the, we might say, infinite operations that mathematician perform with explicit demonstrations, we will select some of those of prime importance that are necessary to Architecture, without however providing the proofs, because this is proper to Mathematics, of which Architecture professes to be a disciple.<sup>3</sup>

In order to arrive at a better understanding of the elements that inspired Guarini's architectural constructions, it seems opportune to look at the extent and depth of his knowledge of mathematics and how this influenced his artistic activities. In spite of the fact that Guarini has been studied by historians in various fields of culture, and that these have shed light on the legacy he received from other architects both earlier and contemporary, until now few have undertaken an analogous study in terms of his mathematical learning and the relationships between his knowledge of geometry and his works, both written and built. The aim of this present paper is to show, through an analysis of the most substantial of his mathematical works, *Euclides adauctus*, along with the *Appendix* to this printed a few months later, the role that philosophical and mathematical studies had on his cultural formation, on the new and original research that he conducted, and on his teaching activities, looking for traces of the mathematical sources that he consulted and cited in order to identify the authors and works which exerted the greatest influence on him. We will illustrate the structure, characteristics and

aim of this treatise, note the elements that are new, and its limits with respects to similar contemporary works. Finally, we will consider the diffusion of the work, and its legacy in scientific and pedagogical terms.

### ***Guarini and the Euclides adauctus***

A cosmopolitan artist, born in Modena on 17 January 1624, after his formative years in the colleges of the Theatines in Modena and Rome, where he studied theology, philosophy, mathematics and architecture, Guarini had the good fortune to come into contact with various societies and cultures during his travels to Rome, Vicenza, Prague, Parma, Guastalla, Messina, Lisbon, Paris, Nice, Torino and Milan. His cultural baggage was immensely enriched by encounters with scholars, artists, teachers, librarians and rulers in various countries. The fruit of these exchanges ripened during Guarini's period in Torino, from 1666 until his death on 6 March 1683. These years were undoubtedly the most fertile and rich in initiatives, during which he realised, in addition to admirable works of architecture, no fewer than six printed works [Guarini 1671, 1674, 1675, 1676, 1678, 1683] on topics of mathematics, stereotomy, geodesy, gnomonics (the study of sundials) and astronomy, as well as two works on architecture, which were published posthumously in 1686 and 1737. The majority of these publications reflect Guarini's remarkable mathematical gifts, recognised early on by Charles Immanuel II of Savoy, who in May 1668 named him Royal Engineer and Mathematician.

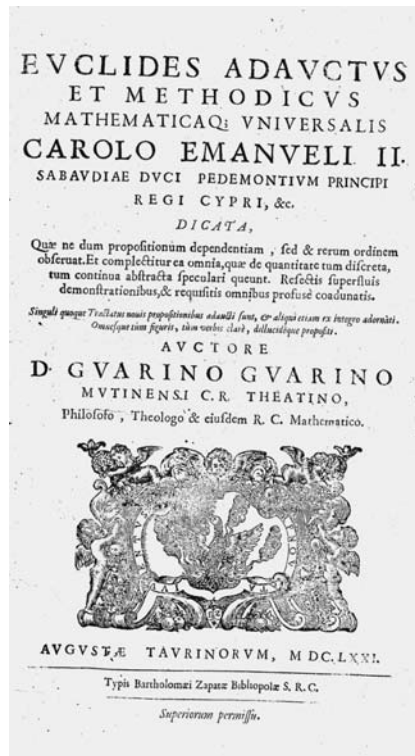

Fig. 2. Frontispiece of Guarini's *Euclides Adauctus*, 1671

*Euclides adauctus* (fig. 2) is on a much higher level than other treatises of geometry and practical arithmetic assembled in the Renaissance for artists and artisans by authors of note such as Leon Battista Alberti, Francesco di Giorgio Martini, Leonardo da Vinci and Albrecht Dürer, although in a certain sense it shares with them, as we shall see, a similar purpose.<sup>4</sup> Despite its title, it also differs clearly from the various editions of Euclid's *Elements*, whose aims were of a philological and critical nature, and which were quite widespread in Italy in the sixteenth century.

Guarini's work is encyclopaedic in nature and is in some way comparable to Luca Pacioli's *Summa de arithmetica, geometria, proportioni et proportionalitate* [1494] and to Niccolò Tartaglia's *General Trattato di numeri e misure* (4 vols., 1556-1560), especially with regards to the readership it was aimed at. As Guarini himself stated explicitly several times – in the *Euclides*, in the *Modo di misurar le fabriche* and in *Architettura civile* – his aim was to make known the results achieved in classical geometry as found in the works of Euclid, Archimedes, Apollonius and Pappus, and of more recent mathematics regarding, for example, curves, solids of rotation, indivisibles and logarithms. His works were destined for a readership that was learned and exigent, but not one specialised in subtle and complex mathematical proofs. His public comprised intellectuals and practitioners desirous of understanding the fundamentals of geometry and arithmetic in order to apply them, for example, in fields such as architecture, geodesy, military architecture, gnomonics and astronomy. It was for this reason that in the introduction to chapters addressing a specific topic, he often made mention of possible applications for the particular theory [Guarini 1671: 26]. For example, he mentions the use of regular polygons to construct fortifications [Guarini 1671: 83]; he says that the conics can be used to fabricate burning glasses and sundials, and to study the motions of the planets [Guarini 1671: 422]; he notes that projections are used in gnomonics and architecture, in building sundials and mathematical instruments such as the astrolabe and the quadrant, and in cosmography [Guarini 1671: 444]. Further, Guarini conceived new curves, new surfaces and new solids which could be used in the construction of buildings, churches, noble palaces, gardens, staircases, columns, vaults, lunettes, and more. He also mentions applications of mathematics to geodesy [Guarini 1671: 503].

From the very beginning of the *Euclides adauctus*, indeed on the frontispiece, Guarini states the work's nature and contents:

Euclid amplified and set out methodically, and universal mathematics dedicated to the Duke of Savoy, Prince of Piedmont, King of Cyprus, etc., Charles Immanuel II, which not only observes the dependence of the propositions, but also the order of things. This work is even complete with all of those properties that can be observed with regards to both discrete quantities and abstract continuous ones. Superfluous demonstrations have been neglected and all the important ones included; further, the individual treatises have been amplified with new propositions and some parts have been entirely rewritten. All is illustrated clearly and precisely with figures and with words.<sup>5</sup>

In the preface to his 'gentle readers', Guarini uses a beautiful metaphorical image of the reasons why he was led to compile the treatise, that is, that his own personal experience had confirmed "the value and usefulness that this kind of work can have to *irradiate with mathematical light and make evident all things with a single luminous source*".<sup>6</sup>

The inspiration for this came to him from the encyclopaedic collections called *Cursus Mathematicus* published in France and Belgium, such as that of Pierre Hérigone (1580-1643), in five volumes, printed in Paris [1634-1637],<sup>7</sup> and that of Gaspar Schott (1608-1666), in twenty-eight books, published in Würzburg (in Latin, *Herbipoli Franconiae*) [1661].<sup>8</sup> Guarini most likely came to learn of Hérigone's work during his travels in France, in Paris, where Hérigone was much appreciated as a teacher. Guarini may have had direct contact with Schott, a Jesuit, in Sicily, because Schott taught at the Gymnasium of the Jesuit College in Palermo. Schott later transferred to Würzburg, where he published, in addition to his *Cursus Mathematicus sive absoluta omnium mathematicarum disciplinarum encyclopaedia*, the volumes entitled *Mathesis Caesarea* [1662a] and *Physica curiosa sive mirabilia naturae et artis* [1662b], which shows his delight in writing treatises of a practical-applicative nature aimed at a curious public whose vast interests included the "mathematical magic and instruments" of Athanasius Kirker; compasses and other equipment used for measuring in geodesy and polygraphy, that is, in geometry applied to military architecture; the firing of projectiles; problems of military tactics; optics; currency exchanges; chronology and the calculation of the date of Easter; mechanics; meteorology; astronomy and civil architecture.

In the first edition of *Euclides adauctus*, in 1671, Guarini did not yet know of the celebrated *Cursus seu Mundus Mathematicus* by the French Jesuit Claude-François Milliet Dechaies (1621-1678), which was published in three volumes in 1674. But this important work was cited by Guarini in *Architettura civile* [Guarini 1737: 1].<sup>9</sup> In all likelihood Guarini and Dechaies met in Torino in 1674, when Dechaies gave a scholarly lecture in the *aula magna* of the Jesuit College, which four years later was also the site of a solemn memorial service for Dechaies, with a funerary oration that was published in Torino.<sup>10</sup>

Guarini proudly underlines that he had avoided the disadvantage of spreading the notions over many costly volumes, and that he had collected the concepts and properties in an orderly way and in succession in a single work, especially for "those who are not able to translate the most difficult knowledge into their own language". He mentions the difficulty that the ordinary reader, that is, one who is not a professional mathematician, would face if they were to take on the works of Apollonius of Perga, Archimedes and Pappus directly. In his treatment, although he had consulted many texts, he did away with what was superfluous, which he judged to be useless, and did not include all the discussions of the ancients; he sometimes broadened the scope of that mathematics, by inserting proofs that were missing; he often improved on proofs, and he always marked the innovations and changes that were his own with an asterisk in the left margin, since these were the fruits of his personal reckoning and reflection. In this volume Guarini reveals his excellent gifts as a teacher, stating that he himself had learned the way to explain mathematics from Euclid and Proclus:

Thus the ones who are most guilty of violating the laws of mathematics, as we learn from the Lion's claw [i.e., Proclus] are those who, while proving a proposition, insert, or even only state, other observations and propositions that are out of place there, and that have not already been proven, and in so doing they confuse the students' minds and cause them problems.<sup>11</sup>

The style of the work in fact shows a remarkable sensitivity for didactics, originality and depth in the explanations, and singular skills in expression, with great attention paid to how the properties can be visualised, which derives from Guarini's extraordinary experience in artistic fields.

The topics addressed are subdivided into thirty-five books or treatises (*tractatus*), which are in their turn subdivided into chapters (*expensio*), and which include definitions, postulates, principles, theorems, corollaries, problems and, occasionally, “assumptions” (*praecassumptum*) and conclusions (*conclusio*). Each treatise opens with a foreword in which Guarini mentions that particular topic’s possible practical uses by engineers, artisans, instrument makers, military architects, geodesists, musicians, and so forth. The way the subject is set out is closer to that of Euclid’s *Elements* than it is to the works of Archimedes and Apollonius, which were addressed to readers who were highly cultured experts. The proofs are clear and detailed. Guarini numbers in order, sometimes excessively so, the steps to be taken.

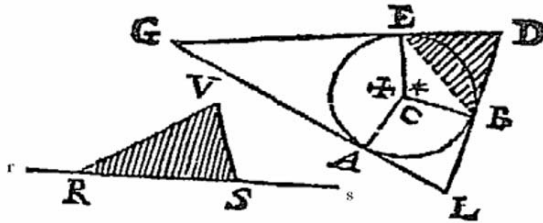

Fig. 3. Guarini 1671, Tract. VII, Probl. II Prop. III, p. 85

He also makes use of efficacious graphic aids in order to better visualise the elements under consideration. These include the insertion of asterisks or crosses in angles (fig. 3); the hatching of angles, faces, planes or surfaces, which are then referred to in the text as “black angle” or “black rectangle” (fig. 4), etc.; the intersection of planes to which a thickness is given (fig. 5), the drawing of parallel circles or rings on spherical surfaces (fig. 6); the edges of regular polyhedra (fig. 7), imitating the *poliedri vacui* drawn by Leonardo da Vinci for Luca Pacioli’s *De divina proportione*; perspective projections. The illustrations are perfectly drawn down to the smallest detail.

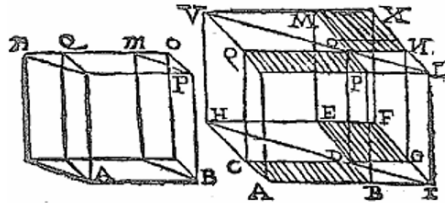

Fig. 4. Guarini 1671, Tract. XXXIV, Th. V, Prop. VI, p. 611

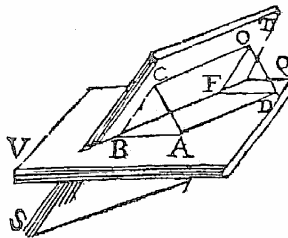

Fig. 5. Guarini 1671, Tract. XXII, Def. IV, p. 347

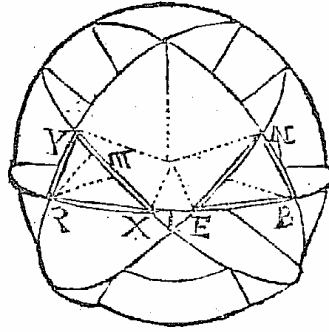

Fig. 6. Guarini 1671, Tract. XXIII, Exp. IV, Th. I, Prop. XI, p. 363

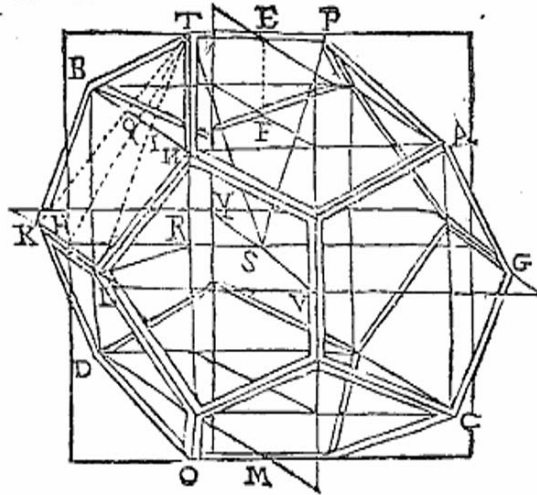

Fig. 7. Guarini 1671, Tract. XXXII, Exp. VI, Probl. I, Prop. IX, p. 603

The first three treatises of the *Euclides adauctus* reintroduce arguments of a philosophical nature already addressed in the *Placita Philosophica* regarding the existence of continuous quantities, discrete quantities, indivisibles, the infinite, and the characteristics of mathematics.<sup>12</sup> Before taking on the mathematical theory of proportions, Guarini, following Aristotle's theories in *Physica* and *Metaphysica*, studies actual and potential, illustrating their metaphysical properties and distinguishing between six kinds or species of quantity: mass, number, time, motion, virtue and weight. In this work Guarini only takes into consideration quantities that are continuous – the object of geometry, points, lines, surfaces – and discrete – the object of arithmetic, numbers.

Here Guarini spends a great deal of time discussing the existence of divisible or indivisible points in quantities and in the theory of atomism. He addresses the form of atomism that maintains that the various bodies are composed of indivisible atoms that are separate and contiguous, such that between any two there are no other intervening atoms. He refutes this kind of concept by citing some considerations already made in the *Tractatus de continuo* by Thomas Bradwardine of Merton College in Oxford regarding concentric circumferences and the side and diagonal of a square, arguing that if biunique correspondence between the points of these entities were established, then in the case of

concentric circumferences, the lengths would be equal, while in the second case the magnitudes would not be incommensurable, since the side and diagonal of the square would have the same number of indivisible atoms.

The various arguments reflect Guarini's knowledge of medieval and Renaissance debates regarding the continuous, the polemic between Jacques Pelletier and Christopher Clavius concerning the angle of contact between circumference and tangent,<sup>13</sup> the use of indivisibles in mathematics reasoning, with examples drawn from Galileo's *Dialogo sopra i due massimi sistemi del mondo*, Luca Valerio's volume on the hemisphere *De centro gravitatis solidorum* [1661], Vincenzo Viviani's *De maximis et minimis* [1659] and Bonaventura Cavalieri's *Geometria indivisibilibus continuorum* [1645].

The treatment of the infinite is quite detailed from the point of view of both mathematics and physics. Like Aristotle, Guarini refutes actual infinity, maintaining that it is not possible to identify the last part of such an infinity, because it is an infinity that cannot be exhausted.<sup>14</sup> By means of well-chosen examples from the best literature of the day, Guarini shows why actual infinity cannot be admitted. In addition to Galileo's reflection on the paradoxes of infinity, Guarini also includes those of St. Augustine on the fact that it is not possible to assign an infinite number, and that only God knows infinity, can see all infinite points, and is capable of selecting and separating them. For Guarini it is possible to conceive parts of quantities that exist in infinity, as long as such quantities are conceived of "mathematically", that is, in the abstract. Incommensurable magnitudes are divisible at infinity, and there is no common unit, thus there is no minimum magnitude; this proves the existence of potential infinitesimal magnitudes. That is to say, there are infinities and infinitesimals that can be conceived in the mind. For example, a sheaf of parallel lines intersected by transversals lead to obtaining various degrees of magnitude of increasingly smaller dimension, to infinity; the angle of contact can be divided infinitely; in the quadratrix of Dinostratus it is possible to successively divide the angle, but the final point of the curve will never be obtained. Guarini then asks if the physical point is divisible infinitely, and provides an answer of a philosophical and theological nature. Finally, he indicates what the mathematical indivisibles are: point, line, surface. He gives a particularly interesting definition of a point: *cujus pars nulla* ("that whose part is zero"), a notion that would be picked up by Deshaies in his *Cursus seu Mundus Mathematicus*. The treatise concludes with the chapter discussing "if indivisibles can be the object of mathematics", in which Guarini comments on the work of Cavalieri (1598-1647), praising his intellect and his doctrine of indivisibles:

Bonaventura Cavalieri dedicated himself to furthering mathematics by examining indivisibles with intelligence and acumen in a book dedicated to this purpose and to finding equalities and proportions in regard to indivisible points that exist in quantities.<sup>15</sup>

Here he cites both the objections to the method of indivisibles used by Mario Bettini in the *Epilogus Planimetricus*<sup>16</sup> and that of Paul Guldin in *De centro gravitatis solidorum* [1642: \*\*-\*], as well as the authors who appreciated the mathematical proofs, such as Ismaël Bullialdus in *De lineis spiralibus*<sup>17</sup> and Vincenzo Viviani in *De maximis et minimis* [Viviani 1659: Lib. I, Theor. IX, Prop. XVII, Monitum, 35]. Guarini's conclusion is articulated in nine points and ends with the judgment that Cavalieri did not provide an actual and evident proof because in his method he goes from one species to another: the indivisible segments (of the first species) form a surface (of the second



species) and this kind of proportion between figures of different species is not permitted in geometry.

Considerations of a philosophical nature, drawn from Aristotle and from his medieval and contemporary commentators, are also present in the second treatise regarding the nature of discrete quantities, the number one, and whether or not an infinite number exists [Guarini 1671: 13-20]. Here Guarini displays a profound knowledge of Aristotle's *Metaphysica* and contests some of the statements of the Persian Avicenna (Ibn Sina, ?-1037) and the Jesuits Pedro De Fonseca (?-1599), Francisco Suarez (?-1617) and José Maria Suarez (?-1677), whom he may have met during his travels in Spain.

In treatise III Guarini addresses the properties of the discipline of mathematics, and gives special attention to its philological aspect and to the terminology used by the ancients (Pappus, Proclus) and the moderns (Clavius, Pierre de la Ramée, Girolamo Vitali) to indicate the elements, definitions, principles, postulates, theorems, problems, lemmas, and so forth. He also discusses the importance of teaching mathematics in education.<sup>18</sup>

After having noted that “the name Mathematics derives from the Greek and means doctrine or discipline in Latin”, he explains that,

...it teaches only by means of demonstration (*per ostensionem*) and declares to be proven only what is evident and deduced from the principles. Mathematics is a *ostensive science* whose object is all that is measurable [Guarini 1671: 22].

Guarini distinguishes between three types of mathematics – universal, cosmic and microcosmic – and declares his intention in this work to deal with only the first of these, universal mathematics, which is its turn subdivided into arithmetic and geometry, since these open the doors to all the others.<sup>19</sup> In treatises IV-XII Guarini presents and proves the propositions set forth by Euclid in books I-VII and X of the *Elements*. In treatises XXII and XXXIII he considers solid geometry, the intersection of planes and the inscription of the five regular polyhedra in the sphere, a theme addressed by Euclid in his books XI, XII and XIII.

For book V of the *Elements*, dedicated to the theory of proportions, Guarini reserves his treatises VIII and IX, in which he addresses the arithmetic operations and the proportions of segments. The particular types of proportions that Euclid considered in his books VI and VII are dealt with by Guarini in his treatises X and XI. In his treatise XII he then addresses the incommensurable magnitudes and irrational numbers, which Euclid set out in his book X. Instead, the operations involving fractions and the rules commonly used to solve some problems of arithmetic, such as the golden rule, the simple rule of three, the composite rule of three, and so forth, and the algorithm for extracting the square root and cube root are examined in treatise XIII. Finally, particular kinds of means and progressions – the arithmetic, geometric, harmonic and so forth – are addressed in treatises XIV, XV, XVI and XVII.

The sources that Guarini consulted in compiling all of these treatises were the classic editions of Euclid's *Elements* in Latin edited by Christopher Clavius<sup>20</sup> and Francesco Commandino,<sup>21</sup> and those in Italian by Commandino [1575] and by Niccolò Tartaglia,<sup>22</sup> but also the texts on spherical trigonometry by Theodosius, Ptolemy, Menelaus, Copernicus and Regiomontanus (cf. [Guarini 1671: 347, 360]). However, he also read and cited authors of manuals of arithmetic and practical geometry, such as



evident for the constructions of the proportioning curve [Clavius 1612: vol. 2, Lib. 6, prop. 15, 160-161; Guarini 1671: 249], the quadratrix of Dinostratus<sup>28</sup>, and the oval.<sup>29</sup> On the other hand, relative to the construction of the ellipse (fig. 9) Guarini goes back to the works on gnomonics, published by Clavius in Rome,<sup>30</sup> François d'Aguillon in Belgium [D'Aguillon 1613: 465-475], Claude Mydorge in France [1639: 201] and Benedetti in Torino (fig. 10).<sup>31</sup>

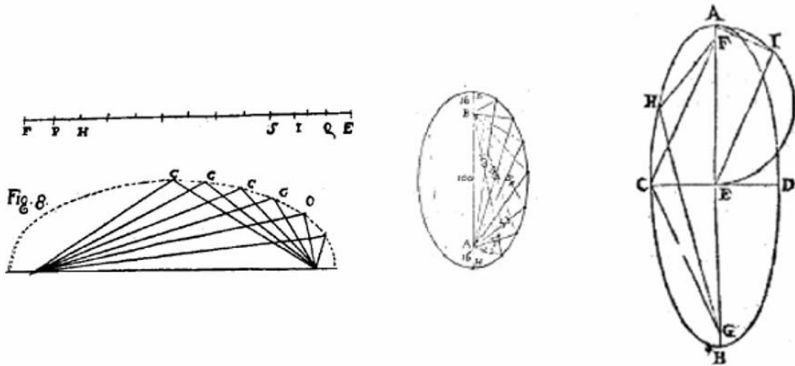

Fig. 9. Constructions of ellipses in Clavius and Guarini

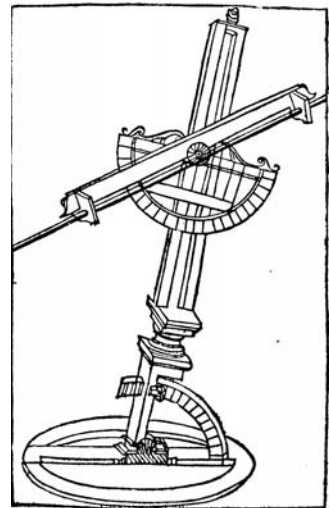
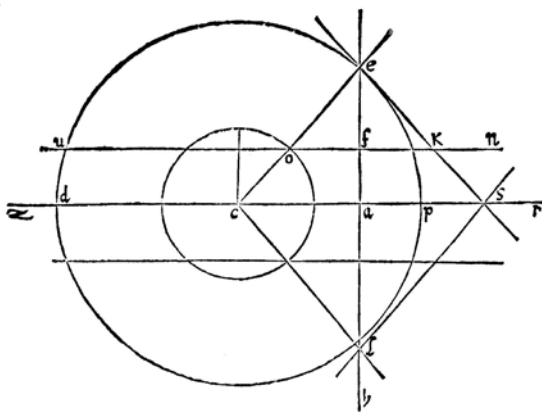

Fig. 10. Benedetti, *De gnomonum ...* 1574, p. 117v

Chapter VII, *De linea conchili*, deals with the conchoid of Nicomedes, which Guarini indicates with the terminology used by Clavius in *Geometria Practica* [Clavius 1612: vol. 2, 162-163]. After noting that this curve was used in the solution of the problem of trisecting the angle (cf. [Guarini 1671: 302-303]), Guarini says that it can be used in architecture for determining the entasis of a column, as suggested by Jacopo Barozzi da Vignola [Guarini 1671, p. 298]. Finally, in chapter VIII, *De lineae ciclicae descriptione*, he mentions the construction of the cyclical line, that is, the cycloid, but does not, however, cite any of the well-known mathematicians, his contemporaries, who studied it, such as Gilles Personne de Roberval, Evangelista Torricelli, Christiaan Huygens and Blaise Pascal.

The treatment of the conics, which are dealt with in treatises XXIV and XXV, is thorough and deep, and follows the classic theory of Apollonius, with the definitions, theorems, properties of tangents, asymptotes, and the famous results of Archimedes regarding the parabola and solids of rotation, and those of Gregorius Saint Vincent in *Opus geometricum quadraturae circuli et sectionum conici*, published in Antwerp in 1647. Oddly enough, Saint Vincent is always referred to as Ambrosius a S. Vincentio,<sup>32</sup> perhaps because Guarini did not have Saint Vincent's work at his disposal, but only those of his student, d'Aguillon.

In the area of solid geometry, Guarini studies the intersections of plane surfaces with bodies generated by the rotation of triangles (obtaining the classic right circular cone), ellipses, parabolas, hyperboloids, and hyperbolic conoids [Guarini 1671: XXV, *De sectionibus sphaericorum*, 436-443]. Guarini also considers a particular coniform solid having a circular genetrix, which instead of terminating in a vertex, terminates in a line segment [Guarini 1671: 438-439]. The practical uses of this kind of geometry are found in sundials, instruments for cosmography, astronomy and above all in architecture, where it is necessary to construct projections. Guarini dedicates treatise XXVI to this theme, which is subdivided into two parts, *De orthographia* and *De stereographia* [Guarini 1671: 444-452, 452-462]. After having addressed the properties of plane and spherical trigonometry in treatise XXVII [Guarini 1671: 463-494], Guarini examines the geometric series relative to surfaces [Guarini 1671: XXVIII, 495-502], the geometric problems of geodesy and the properties of isoperimetric figures [Guarini 1671: 503-526].

The determination of the areas of figures with curved perimeters, compared with others whose perimeters are straight lines, is the object of treatise XXX, in which Guarini mentions the history of the problem of squaring the circle and the results proposed by the ancient philosophers (Antiphon, Bryson of Heraclea, Hippocrates of Chios and Archimedes), as well as by the moderns (Oronce Finé, Nicolaus Cusanus, Saint Vincent, Leotaud and Xavier Franciscus Ayscon) [Guarini 1671: 527-549]. To determine the area of an unknown figure he illustrates the classic method of exhaustion, which consists in the inscription and circumscription of rectangles in the figure such that the difference between the sum of the circumscribed rectangles and the area of the figure is less than any given quantity. Guarini then proves Archimedes' result regarding the measurement of the circle and the approximation for  $\pi$  (that is, the relation between the circumference and the diameter). He then obtains the surface of a circular ring, the area of a lune, the triangle of maximum area inscribed in the ellipse, the area of a segment of parabola found by Archimedes, the area of the Archimedean spiral at its first revolution, an approximation of the area of a segment of hyperboloid. In treatises XXXI and XXXII Guarini deals with the surfaces and volumes of prisms, cylinders, circular groins, cones, truncated cones, elliptical spheroids, spheres [Guarini 1671: 550-571] and their projection on the plane [Guarini 1671: 572-596].

The inscription and circumscription of regular polyhedra in the sphere are addressed in treatise XXXIII [Guarini 1671: 597-608], where Guarini does not settle for merely setting out Euclid's theory, but also extends it in certain points. For example, while in proposition XI.26 Euclid examines the construction of a solid angle equal to a given angle, taking into consideration only the case of a solid angle with three vertices, Guarini states that it is possible to extend the problem to angles of more than three vertices, since these can always be decomposed in solid angles of three vertices [Guarini 1671: 598-599]. After having shown the relation between the sphere and the sides and diameters of each regular polyhedron, Guarini offers a simple and immediate proof of the uniqueness

of the five regular solids, based on the initial proposition that in order to construct a solid angle the plane angles that meet at its vertex must necessarily be less than four right angles. He then proceeds to the determination of the volumes of these solids and to the relation that they have with that of the sphere, derived from the work of Archimedes.

The most innovative results are contained in treatises XXXIV and XXXV regarding the surfaces and volumes of bodies not addressed by other mathematicians, and in the twelve-page *Appendix*, added to the work shortly after 1671, described thus:

Appendix to the *Euclides adauctus* by Guarino Guarini clerk regular of the Theatines. Because following the printing of the book I was able to arrive at many results regarding the determination of the volumes of solid bodies which no one had yet discovered and examined and these were not only useful but almost required, and above all in practical stereotomy there were no square shells of any kind, nor vaults comprising several bodies, which I had inserted in this work in the part about solids, I added these to those in order that there would be no body bounded within a given surface that was not subject to the measure of solid bodies nor that whose measurement was not determined exactly with mathematical certitude.<sup>33</sup>

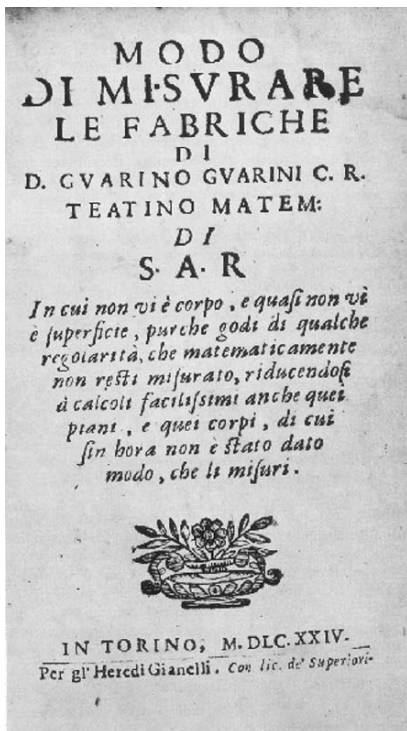

Guarini often refers to this appendix in his next work, the book *Modo di misurar le fabbriche* [1674] (fig. 11), where in the third chapter of the second part he proudly reports the theorems of surfaces and volumes of solids that are particularly useful in architecture, for example, “on cloister vaults and lunettes”, writing:

The rules that we will give in this and the chapter that follows regarding the measurement of Vaults based on squares or other figures, with the exception of circles, are all of my own invention, and for which no rules have yet been given [Guarini 1674, p. 101].

Fig. 11. Frontispiece of Guarini’s *Modo di misurar le fabbriche*, 1674

In the final two treatises of the *Euclides adauctus* and in the *Appendix* Guarini deals with the volumes of bodies contained by plane surfaces, such as pyramids and prisms, and by curved surfaces. Among the curved surfaces he distinguishes three different types: those enclosed by curved surfaces but whose bases are planes with linear boundaries, such as the square fornix; those whose bases are planes with curved boundaries, such as the cone, cylinders and the so-called rhomboid-solid (fig. 12),<sup>34</sup> and those that originate from

a surface which is completely curved, such as the sphere, parabolic conoid (fig. 13), hyperboloid, spheroid, and solid rings. In their turn, solid rings can have a base that is square or polygonal; this holds true for the conoids as well.

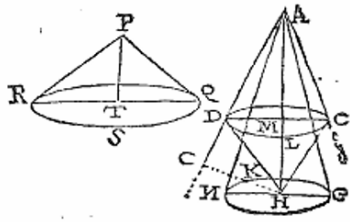

Fig. 12. Guarini 1671, Tract. XXXIV, Exp. II, Th. II, Prop. XV, p. 627

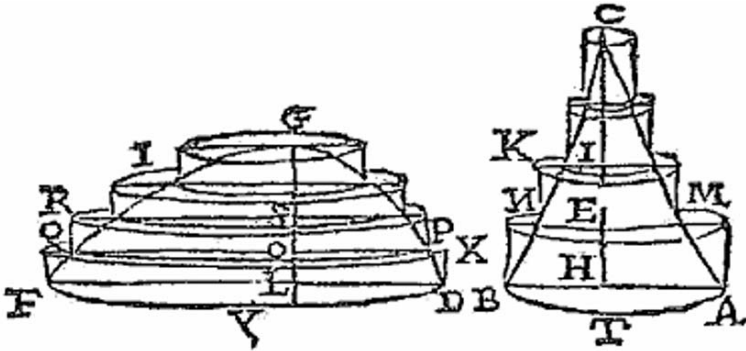

Fig. 13. Guarini 1671, Tract. XXXIV, Exp. IV, Th. V, Prop. XXIX, p. 633

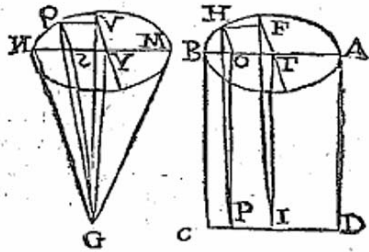

Fig. 14 Guarini 1671, Tract. XXXIV, Exp. IV, Th. I, Prop. XXVI, p. 631

In addition to the right and oblique circular cones, Guarini also examines cones that terminate in a line segment (fig. 14), cones with elliptical bases and coniform solids (fig. 15). The volumes of all these solids are deduced by applying the method of exhaustion illustrated at the end of the preceding treatise (fig. 16).

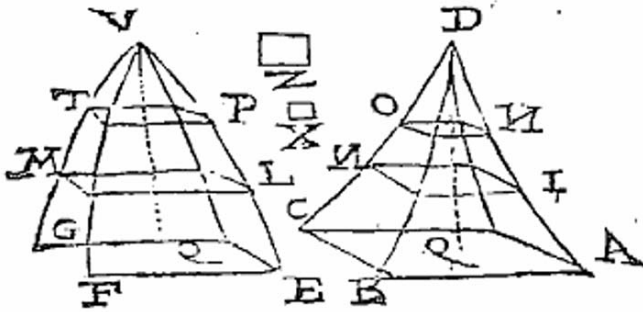

Fig. 15. Guarini 1671, Tract. XXXIV, Exp. IV, Th. III, Prop. XXVIII, p. 632

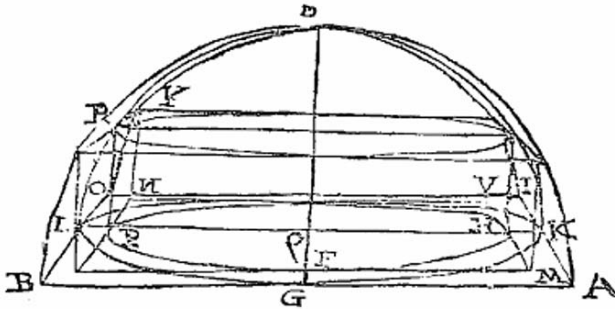

Fig. 16. Guarini 1671, Tract. XXXIV, Exp. IV, Th. III, Prop. XXVIII, p. 632, Guarini 1671, p. 647-648

Guarini then considers surfaces and volumes of semi-spheres with square bases (fig. 16) and conoids or semi-spheroids with square bases (fig. 17), the perimeters of these solids with respect to a circumscribed cylinder (fig. 18), the solids derived from other solids, such as the lunette (fig. 19), the half-quadriforms, spiral-form bodies (fig. 20), and their relationships among them (treatise XXXV and Appendix).

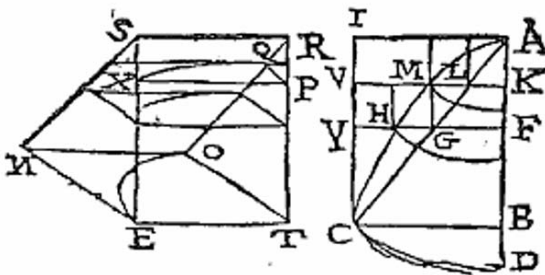

Fig. 17. Guarini 1671, Tract. XXXIV, Th. VII, Prop. LV, p. 652

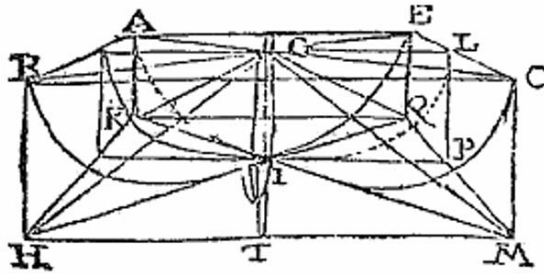

Fig. 18. Guarini 1671, Tract. XXXIV, Th. IV, Prop. LI, p. 649

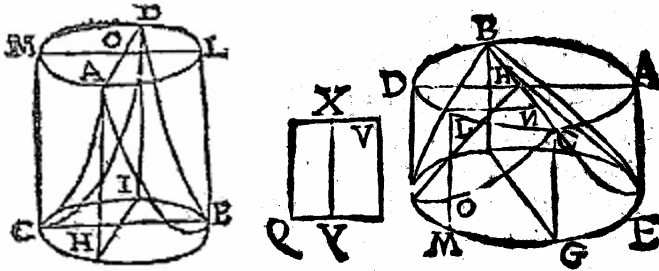

Fig. 19. Guarini 1671, Tract. XXXIV, Exp.XI, Probl. I, Prop. LII, p. 650; Guarini 1674, p. 38

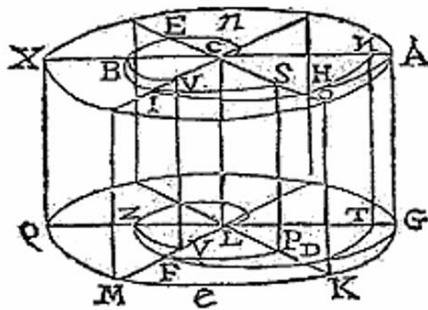

Fig. 20 Guarini 1671, Exp. IX *De corporibus spiralibus*, p. 654; Guarini 1674, p. 191

### Conclusion

Given the wealth of new results rigorously deduced by Guarini in these final chapters of the *Euclides adauctus* and in the *Appendix*, in keeping with the style of Euclid, Archimedes, Grégoire Saint Vincent, Luca Valerio, Cavalieri and Viviani, it is striking to note Guarini's mathematical skills applied to figures pertinent to architecture and art. It is precisely in this melding of passion for mathematics and sensitivity to mathematics teaching that the originality of this great mathematical artist is found. From sources both ancient and contemporary he was adept at selecting, collecting and systematizing the principle results, proving them in a rigorous fashion, some adding his own personal



observations relative to the generalization of the properties and the theories set out by other authors. Even though his intended readership was not composed of mathematicians, and comprised students at religious colleges or universities, engineers and architects, draftsmen and artisans, and instrument makers, Guarini did not limit himself to stating theorems or problems, or to describing properties in a superficial way, as did some of his contemporaries (for example, [Magini 1592; Bruni 1967; Bettini 1647-48; Caramuel 1670]) but rather, skillful teacher that he was, he chose to satisfy the demands of the most capable, the most impassioned and the most curious.

Neither Dechaes nor Tricomi were capable of identifying the innovative elements that Guarini introduced into the mathematical treatises of the epoch.<sup>35</sup> Dechaes limited himself to underlining the order and the arrangement of the propositions with respect to Euclid's text, while Tricomi [1970] based his judgement on modern mathematics. If the *Euclides adauctus* is compared to its *Appendix* and the work which followed, *Modo di misurar le fabbriche*, it can be seen how different a treatment there is between an in-depth work of geometry and a manual aimed at instructing a less cultured readership.

As far as originality is concerned, and the consequences of the results obtained by Guarini in the field of mathematics, while it is true that we find only one proof that is somewhat simplified, or alternate ways of proving an assertion, or again generalizations, exemplifications and exercises regarding new solids, but no genuine revolution, we must in any case recognize the exceptional depth and originality in the fact that Guarini was able to insert an extraordinary variety of geometrical shapes in his artistic creations. Mathematics is made visual in the plans of his churches and palaces, in the shape of the stairs, in the interior and exterior decorative forms, in pavements, windows, the shapes of domes, and in hundreds of architectural details, such as curves and polygons, stars, tilings, vaults, friezes and more. Thanks to this artistic wealth and sensitivity, as well as attention to teaching, we are well justified in defining Guarini as the artist-mathematician of the seventeenth century.

*Translation from the Italian by Kim Williams*

***Appendix I: Index of Euclides adauctus et methodicus mathematicaque universalis*** (Torino 1671)

*Regalis Celsitudo*

*Benevolo Lectori*

*Imprimatur*

*Index*

Tractatus I Praeliminaris. *De essentia quantitatis continuae* : 1-12.

Tractatus II Praeliminaris. *De essentia quantitatis discretae* : 13-20.

Tractatus III. *De Mathematica eiusque Affectionibus* : 21-32.

Tractatus IV. *In primum Librum Elementorum* : 33-52.

Tractatus V. *In secundum Librum Euclidis de aequipotentia linearum* : 53-62.

Tractatus VI. *In Euclidis Librum tertium de Circulis* : 63-82.

Tractatus VII. *In Librum quartum Elementorum, De inscriptione & circumscriptione figurarum in circulo* : 83-91.

Tractatus VIII. *Arithmetica simplex et generalis integrorum numerorum* : 92-105.

Tractatus IX. *In V Librum Euclidis, Pars prima De Proportionum Notione* : 106-118. *In V Librum Euclidis, Pars secunda De Proportionibus in genere* : 118-131.

Tractatus X. *In VI Librum Euclidis, De proportione quantitatis continuae* : 132-153.

- Tractatus XI. *In VII Librum Euclidis, Pars prima De Proportionum Numerorum in genere* : 154-166; *In VIII Librum Euclidis, Pars secunda De speciali Numerorum proportione*:166-176; *In IX Librum Euclidis, Pars tertia De Planorum, Solidorumque generatione, & inventione* : 176-181.
- Tractatus XII. *In X Librum Euclidis, De Lineis irrationalibus* : 182-206)
- Tractatus XIII. *In numeris proportionalibus Pars prima De Numerorum Ratione* : 207-216; *Pars secunda De Numeris proportionalibus inveniendis* : 216-229.
- Tractatus XIV. *In Proportiones Numericas Pars prima De Proportione Geometrica continua* : 230-237; *Pars secunda De Proportione Arithmetica* : 237-242; *Pars tertia De Proportione Harmonica* : 242-247.
- Tractatus XV. *De Linearum, Segmentorumque proportionibus* : 248-255.
- Tractatus XVI. *De progressionem proportionalem Pars prima De Linearum Progressione Geometrica* : 256-262; *Pars secunda De Linearum Progressionibus Harmonicis* : 263-270.
- Tractatus XVII. *De Proportionalitatibus Rationum* : 271-285.
- Tractatus XVIII. *De Flexis* : 286-299.
- Tractatus XIX. *De Angulis* : 300-306.
- Tractatus XX. *De Lineis circulo circumpositis* : 307-323.
- Tractatus XXI. *De Logarithmis* : 324-346.
- Tractatus XXII. *De Intersectionibus Planorum* : 347-353.
- Tractatus XXIII. *Sphaericorum Pars prima De Sphaerae contactibus & sectionibus in genere* : 354-360; *Pars secunda De intersectionibus maximorum circularum invicem* : 360-372; *Pars tertia De maximorum circularum in sphaera minorumque intersectionibus, contactibusque mutuis* : 373-389.
- Tractatus XXIV. *De Sectionibus Conicis* : 390-435.
- Tractatus XXV. *De Sectionibus corporum sphaericorum per planas superficies* : 436-443.
- Tractatus XXVI. *De proiecturis Pars prima De Orthographia* : 444-452; *Pars secunda De Stereographia* : 453-462.
- Tractatus XXVII. *Trigonometriae Pars prima. De Trianguli plani cruribus dimetiendis* : 463-471; *Pars secunda. De Triangulis Sphaericis solvendis* : 471-494.
- Tractatus XXVIII. *De Progressionibus superficierum* : 495-502.
- Tractatus XXIX. *De Geodaesia Rectilineorum Planorum* : 503-526.
- Tractatus XXX. *De Transformatione Curvilinearum* : 527-549.
- Tractatus XXXI. *De Transformatione superficierum corpora circumvestientium* : 550-571.
- Tractatus XXXII. *De superficiebus corporum in planum redigendis* : 572-596.
- Tractatus XXXIII. *De inscriptione et circumscriptione Solidorum* : 597-608.
- Tractatus XXXIV. *De Solidis Pars prima De solidis planis superficiebus contentis* : 609-619; *Pars secunda. De soliditate corporum curvorum* : 620-659.
- Tractatus XXXV. *De Corporum comparatione* : 660-686.
- Amice Lector Errores aliqui .... Benignius corriges*  
*Usus Tabulae sequentis Sinuum, Tangentium et Logarithmorum*  
*Tabula Logarithmica eiusque usus explicatus*  
*Tabula Sinuum, atque Tangentium Logarithmis Neperianis exornata diligenter emendata*  
*quae omni, tum geometricae, tum arithmeticae supputationi apprime deservit*  
*Index Propositionum totius Operis*  
*Index Trigonometricus*

**Appendix II: Index of the Appendix ad Euclidem adauctum** (Torino 1671; 1-24 non-numbered pages)

*Expensio I. De quibusdam, quae Libri tractatibus subnecti queunt* (Theor. I Prop. I, Theor. II Prop. II, Theor. III Prop. III, Theor. IV Prop. IV, Theor. V Prop. V, Theor. VI Prop. VI): 1-3.

*Expensio II. Exp. 2 Eucl. adauc. corpus 8 Tr. 34 quod non dum cubationi subactum est nempe Sphaeram quadriformem cubavimus quod quidem corpus in fornicibus omnibus in usu est, proptereaque eius mensurae erant Sterometriae admodum necessariae. Verum quia animadverti fornices ne dum super basim quadratam, sed etiam rectangulam & rhomboidalem, ut ellipticam, & ne dum circumum sed & ellipticam etiam obliquam aliquando consequi, nixus sum omnia haec corpora talibus basibus efformata ad cubationem redigere; quae libro subnecto utpote summopere utilia.* (Theor. I Prop. VII, Coroll., Theor. II Prop. VIII, Coroll., Theor. III Prop. IX, Coroll. I-II, Theor. IV Prop. X, Coroll. I-III, Theor. V Prop. XI, Coroll. I-IV, Theor. VI Prop. XII, Coroll., Theor. VII Prop. XIII, Coroll. I-III, Theor. VIII Prop. XIV, Coroll. I-II, Theor. IX Prop. XV, Theor. X Prop. XVI, Theor. XI Prop. XVII, Theor. XII Prop. XVIII): 3-12.

*Expensio III. De Conoidibus Parabolicis oblongae basis* (Theor. I Prop. XIX, Coroll. I-II, Definitio *Cylindrus parabolicus*, Theor. II Prop. XIX, Theor. III Prop. XX, Theor. IV Prop. XXI, Coroll. I-II, Theor. V Prop. XXII, Theor. VI Prop. XXIII, Coroll.): 12-16.

*Expensio III. De Conoidibus Hyperbolicis oblongae et quadrangulae basis* (Theor. I Prop. XXIV, Definitio *Cylindrus hyperbolicus*, *Sectio in hoc cylindro*, Theor. II Prop. XXV, Theor. III Prop. XXVI, Theor. IV Prop. XXVII, Theor. V Prop. XXVIII): 16-18.

*Expensio IV. De Annulis* (Theor. I Prop. XXIX, Coroll. I, Theor. II Prop. XXX, Theor. III Prop. XXXI, Theor. IV Prop. XXXII, Coroll. I-V, Theor. V Prop. XXXIII, Theor. VI Prop. XXXIV, Theor. VII Prop. XXXV, Coroll.): 18-24.

**Appendix II: Index of the Modo di misurar le fabbriche** (Torino 1674)

*All'Illustrissimo Signor e Padrone mio Colendissimo il Signor Giovanni Andrea Ferrari Conte di Bagnuolo, Presidente e Generaledi finanze di S.A.R., 22 Luglio 1674: 3-6*  
*A Benigni Lettori: 7-8*

*Preludio All'Arte di misurare le fabbriche: 9*

*Capitolo 1 Del modo di esercitare le prime cinque regole d'Aritmetica* (Prop. 1-6): 9-19

*Capitolo 2 Della regola delle proportioni* (Prop. 7): 19-20

*Capitolo 3 Modo di cavar la radice quadra* (Prop. 8-10): 20-25

*Capitolo 4 Modo di quadrare e cubicare secondo alcuni paesi* (Prop. 11-12): 25-33

*Capitolo 5 Propositioni che servono di fundamento ad alcune regole di misurare* (Prop. 13-20): 33-49

**Parte prima Delle misure delle superfici piane: 49-87**

*Capitolo 1 Delle misure di diversi paesi: 50-51*

*Capitolo 2 Del misurare le superfici rettilinee e piane* (Prop. 1-6): 51-61

*Capitolo 3 Di misurare le superfici circolari e piane* (Prop. 7-18): 61-87

**Parte seconda Delle misure superficiali de corpi: 87-135**

*Capitolo 1 Delle superfici piane de corpi* (Prop. 1-6): 88-96

*Capitolo 2 Delle superficie de cono* (Prop. 7-9): 96-101

Capitolo 3 *Del misurar le Volte a Padiglione e Lunette* (Prop. 10-16): 101-110

Capitolo 4 *Delle superficij delle Sfere e Sferoidi e sue parti, e delle Sferoidi quadrate* (Prop. 17-26): 110-126

Capitolo 5 *Della superficie delli anelli e corpi spirali e nelle spirali* (Prop. 27-36): 126-135

**Parte terza** *Delle dimensioni de corpi*: 135-208

Capitolo 1 *Per misurare ogni corpo contenuto da superficij piane* (Prop. 1-7): 136-144

Capitolo 2 *Del misurare ogni sorte di Cilindro o Cono* (Prop. 8-14): 144-151

Capitolo 3 *Della dimensione delle sfere e sferoidi quadrate, delle volte e loro parti* (Prop. 15-23): 151-165

Capitolo 4 *Delle conoidi rettangole, paraboliche o iperboliche* (Prop. 24-26): 165-171

Capitolo 5 *Delle sfere e sferoidi tonde, e ellittiche* (Prop. 27-30): 171-180

Capitolo 6 *Delle cubationi delle Conoidi paraboliche e iperboliche* (Prop. 31-34): 180-184

Capitolo 7 *Della corpolenza delli anelli* (Prop. 35-36): 185-190

Capitolo 8 *Delle sodezze de corpi spirali* (Prop. 37-39): 190-195

Capitolo 9 *Delle mete concave e globose* (Prop. 40-42): 195-200

Capitolo 10 *Del misurare tutti i corpi vacui di dentro, o di serie infiniti* (Prop. 43-45): 200-204

Appendice 1. *Di ridurre le superfici piane a varie sodezze*: 205-208

Appendice 2: 208

Indice.

## Notes

1. ...sed insuper Thaumaturga Mathematicorum miraculorum insigni, vereque Regali architectura coruscat. ... Excipiat itaque R.V.C. pacatu vultu, serenaque clementia illam, quam toties in concipiendis sublimibus idaeis vasto ingenij sui sinu fovit mathesim, et in ea adornanda exanthlatos laboris mei conatus [Guarini 1671: Regalis Celsitudo, p. 2 (not numbered)].
2. ...omnes artes vel a Mathematica, vel a Philosophia, vel a Medicina dependent, quae omnes scientiae vel rerum similitudinem, vel proportionem, vel convenientiam considerant. Nam quanto magis artifex abundat in rerum cognitione ad artem suam spectantium, convenientiaeque earum, noverit omnes modos, et multimodum earum applicationem, tanto magis excellens dicitur et perfectius operatur. Nam cum artifex vult operari, oportet ut seligat materiam aptam, instrumenta noverit, connexionem rerum ad artificium spectantium et tandem illud artificium unde quaeque decreverit. Et quia nec imaginatio, nec intellectus in difficultibus aliquando sufficiunt, hinc est quod modulos parvos artifices conficiant, ad ideam perfectius in ipsa re probandam et perficiendam [Guarini 1665: 213].
3. *Delle operazioni per così dire infinite che i matematici vanno esercitando con evidenti dimostrazioni, ne sceglieremo alcune le più principali, che sono necessarie all'Architettura, senza però arrecare le prove, perchè questo si è proprio ufficio della Matematica, di cui l'Architettura si professa discepolo* [Guarini 1736: 18].
4. L. B. Alberti, *De re aedificatoria*, Florentiae 1485; F. di Giorgio Martini, *Trattato di architettura civile e militare*, 1482-92; A. Dürer, *Unterweisung der Messung mit dem Zirckel und Richtscheit...*, Nurnberg 1525.
5. *Euclides adauctus et methodicus mathematicaque universalis Caroli Emanuelli II Sabaudiae duci Pedemontium Principi Regi Cyprì etc. dicata, quae ne dum propositionum dependentiam, sed et rerum ordinem observat. Et complectitur ea omnia, quae de quantitate tum discreta, tum continua abstracta speculari queunt. Resectis superfluis demonstrationibus, et requisitis omnibus profuse coadunatis. Singuli quoque Tractatus novis propositionibus*

*adaucti sunt, et aliqui etiam exintegro adornati. Omnesque tum figuris, tum verbis clare, dilucideque propositi.*

6. *Siquidem ex meo labori didici, cuius pretij, cuius utilitatis id operis emergat, quod ea omnia quae Mathematicas luces et evidentias in unicum lucis fontem adeoque solem ne dum tumultuaria collectione aglomeret, sed etiam ordinato agmine disponat in seriesque suas naturali consecutione distinguat praecipue illis qui nullo Mercurio tramitis indice aut duce audent se huic studio consignare et admodum difficilem provinciam in suam sarcinam traducere* [Guarini 1671: *Benevolo Lectori*, p. 1 (not numbered)] (emphasis mine).
7. The first volume of Hérigone's work (1634) contained Euclid's Elements and Data, an appendix on plane geometry, the books of Apollonius on loci and the doctrine on the division of angles; the second (1634), practical arithmetic and algebra; the third (1634), practical geometry, fortifications, mechanics and tables of sines and logarithms; the fourth (1634), geography and navigation; and the fifth (1637), the sciences relative to optics, perspective, Theodosius's spherical trigonometry, the theory of planets, gnomonics and music. As the title notes, the entire encyclopaedia was written in two languages, Latin and French.
8. As the title implies, the corpus of the work, divided into twenty-eight books, is organised in order that even beginners, without an instructor and through their own efforts, can learn all of mathematics starting with the fundamental elements.
9. Reprinted in 1690 with the addition of a new volume that included all of Dechales's handwritten notes made from the publication of the first edition to the time of his death, the work opened with a historic overview regarding progress made in mathematics and presented the most valuable books over the course of thirty-one scientific sections: Euclidean geometry, Theodosius's spherical geometry, the conics, arithmetic, trigonometry, practical geometry, mechanics, statics, geography, magnetism, civil architecture, the art of building in wood, stonemasonry, military architecture, hydrostatics, hydrodynamics, hydraulic machines, navigation, optics, perspective, catoptrics, dioptrics, music, pyrotechnics, the astrolabe, the theory and use of sundials, astronomy, theory of planets, meteors, and the calendar.
10. *Oratio habita in funere Reverendi Patris Claudii Francisci Milliet Dechales Societati Iesu, in Collegio Taurinensi eiusdem Societatis die 28 Martij 1678*, Taurini, Typis B. Zapatae, 1678.
11. *Unde in iura Mathematica maxime illi peccant, qui, ut ex ungue discamus Leonem, dum unam propositionem probant, alias quae illius loci non sunt, praxes propositionesque ex aliis non cognitis ostensas, aut tantummodo assertas adferunt et sic mentes discentium tenebris offundunt et in ambages urgent* [Guarini 1671: *De Mathematica instructione*, 25].
12. [Guarini 1671: *De quantitate continua*, 1-12; *De quantitate discreta*, 13-20; *De Mathematica ejusque affectionibus*, 21-32]. See also [Guarini 1665: *De quantitate*, 118-120; *De continui compositione*, 249-266].
13. This discussion also regarded infinitesimal magnitudes for which the theory of proportions did not hold.
14. Cf. [Guarini 1671: Exp. iv, pp. 5-7, *Puncta infinita in quantitate, an admitti debeant* ("if infinite points must be admitted in quantities")].
15. *Bonaventura Cavalieri per indivisibilia libro ad id conscriptum non sine ingenio et subtilitate Mathematicam se promovere proficitur et ex contemplatione punctorum indivisibilium in quantis existentium aequalitates et proportiones Mathematicorum corporum invenire* [Guarini 1671: 11].
16. Mario Bettini (1582-1657), a Jesuit from Bologna, taught mathematical philosophy and moral philosophy at the Gymnasium in Parma. Here Guarini is referring to vol. 2 of his *Aerarium Philosophiae Mathematicae*, published in 1648, in which he confutes the doctrine of indivisibles in the *Epilogus Planimetricus*, Pars II, § XX-XXII, [Bettini 1647-48: vol. 2, Pars II, 24-37].
17. [Bullialdus 1657 : Prop. XLII, Nota II, 66-67]. Guarini probably consulted the work of Ismaël Bullialdus (1605-1694) during his sojourn in France. In his essay on spirals, Bullialdus praises Cavalieri, although he does mention the criticisms of his contemporaries regarding indivisibles.
18. Cf. [Guarini 1671: 21-32]. G. Vitali's *Lexicon Mathematicum* [1668] is referred to in the definitions of sine (*sinus rectus*), cone, the object of geodesy, and the history of the problem of squaring the circle; cf. [Guarini 1671: 307, 390, 503, 527].

19. *Mathematica in tres partes dividi potest in Mathematicam Universalem, Cosmicam et Microcosmicam. Prima est duplex, nam alia est quae agit de quantitate discreta, alia de continua. Secunda quoque duplex est, alia agit de coelo, altera agit de terra, terrenisque omnibus quae mensuris subsunt. Tertia quoque duplex est. Alia enim pertinet ad naturam hominis, ut visus circa quem versatur Optica. Alia spectat ad artem, ut Mechanica et huiusmodi. Hoc autem libro tradimus Mathematicam Universalem, quae de omni quantitate in communi peragit et omnibus aliis mathematicis partibus aditum aperit* (Mathematics can be divided into three parts: universal, which in its turn is divided into two parts, one dealing with discrete quantity and the other with continuous; cosmic which deals with the world, that is, with the heavens, earth, and all earthly things subject to measure; microcosmic which deals with human nature and its natural activities such as optics or those relative to the applied arts, such as mechanics, etc. In this work however we will deal with universal mathematics that generally regards all quantities and opens the way to all of the other parts of mathematics) [Guarini 1671:23].
20. [Clavius 1574], cited in [Guarini 1671: 3, 25, 46, 67, 78, 91, 131, 145, 176].
21. [Commandino 1572], cited in [Guarini 1671: 54, 133].
22. [Tartaglia 1565], cited in [Guarini 1671: 35].
23. From the book *Tabula tetragonica, seu quadratorum numerorum* by Paduan mathematician G. A. Magini, who taught at Bologna, Guarini took the representation of the plane numbers designed with little stars; cf. [Magini 1592: 1] and [Guarini 1671: 219, 222].
24. [Bettini 1647-48: 183-210] cited in [Guarini 1671: 249].
25. [Clavius 1603] cited in [Guarini 1671: 222, 293].
26. [Benedetti 1563] cited in [Guarini 1671: 85].
27. [Guarini 1671: *In Librum quartum Elementorum De inscriptione et circumscriptione figurarum in circulo*, 83-91]. This is how he underlines the importance of this topic for artists and artisans: “the fourth book [of Euclid’s *Elements*] deals with the construction of figures with respect to the circle, however, it is more convenient, with the other polygons, to execute the construction with the inscription or circumscription of the circumference. The use of this book is absolutely required for artisans and artists, both for the solids which have to be inscribed in the sphere or must circumscribe this, as well as for determining the relationship between an outer solid polyhedron and an inner one. We recall that with a procedure of this kind Archimedes found the volume of the sphere. Such constructions are also useful for determining the lines and chords of arches, and also for laying out the drawings of military fortresses” [Guarini 1671: 83].
28. Cf. [Clavius 1612: vol. 1 (*Euclidis Elementa*), Lib. 6, 296-300; vol. 2 (*Geometria practica*), Lib. 7, Appendix, 189-192] and [Guarini 1671, Exp. IV *De linea quadratrice*, pp. 293-296]. In addition to the construction by Clavius, he includes the one given by the Jesuit Vincent Leotaud in his *Cyclomantia seu de multiplici circuli contemplatione libri 3* (Lyon, 1663), which is also cited in *Architettura civile* [Guarini 1968: tratt. I, Cap. X, Oss. VI, 59].
29. [Clavius 1612: vol. 2, Lib. 8, prop. 47, 218-219] and [Guarini 1671: *De circuli segmentis in figuram circularem coaptandis*, 289; Probl. 2, Prop. 7, *Lineam ovalem proprie dictam efformare*, 290]. Here Guarini uses the construction of the mean proportional, already described in treatise XV [Guarini 1671: 248-249], that is, the proportional compass that is already found at the beginning of René Descartes’s *Géométrie*. The construction recalls that given by Teofilo Bruno, a mathematician from Verona in [Bruno 1627: 2-4], and [Bruno 1631: 72-73]. For more on this, see [Ulivi 1990].
30. [Clavius 1612, vol. 4 (*Gnomonices*), 28-30, 75-78]; [Guarini 1671: XVIII, Exp. VI *De linea ellipsi*, 297]. Guarini defines the ellipse kinematically: the motion of a point that goes further away from one focus as it goes nearer to the other. He then states that it is also obtained as a section of a cone and presents the classical gardener’s construction.
31. [Benedetti 1574: 39]. Cf. also [Benedetti 1585: 348-351] on the instrument he conceived for tracing the curve.
32. *Ambrosium Vincentium virum in Mathematicis admirabilem, in quo quaedam etiam desumemus in sequentibus* (Ambrosio Vincenzo, admirable expert in mathematics, from whose

work we have gathered some of the results which follow) [Guarini 1671: 419]; cf. also [Guarini 1671: 420, 495].

33. *Appendix ad Euclidem adauctum Guarini Guarinii c.r. Theatini. Quoniam multa, quae ad cubationem corporum faciunt, quae a nemine tacta; et animadversa sunt, mihi post impressionem libri occurrerunt, quae ne dum erant utilia, sed pene necessaria, & stereometria practica deficiebant maxime concamerationum quadratarum cuiuscunque generis, voluisti plurimum corporibus, quae cubationi subiecti in nostro hoc opere, haec omnino illis subnectere, ut iam nullum sit corpus sub aliqua certa superficie comprehensum quod corporum cuborum mensuris non sit subactum, & mathematica certitudine illius mensura poenitus non innotescant.* In the copy of Guarini's *Euclides adauctus* conserved in the Biblioteca Nazionale Universitaria in Torino, indexed as Cav. 60, this *Appendix* has been bound at the end of the volume.
34. Rhomboid-solids are bodies made of two right cones which have bases that are equal and adjacent. When the rhomboid solid is cut with a plane passing through the axis and perpendicular to the bases of the cones, the result is a plane rhombus. In this treatise reference is sometimes made to a rhomboid solid by simply using the term "rhombus."
35. After having cited the contents of the thirty-five treatises of Guarini's *Euclides adauctus*, Dechales writes: *quamvis in hoc opere multa sint optima, methodus tamen, et ordo non aridet, multa item non satis clare explicat. Unde melius scripsisset si Euclidem in suo ordine reliquisset peculiaribusque tractatibus caeteras materias explicuisset. Hic enim ordo confusionem patit* (although there are many excellent things in this work, however the method and the order are not pleasing, and many things are not clearly explained. It would be better if he had left Euclid in his order and had set forth the remaining material in specific treatises) [Dechales 1674: t. I, 27].

### **Bibliography**

- ALSTED, J. 1620. *Tractatus de architectura*. Herborn.
- ARNHEIM, R. 1977. *The Dynamics of Architectural Form*. Berkeley: University of California Press.
- BENEDETTI, G. 1553. *Resolutio omnium Euclidis problematum una tantummodo circini data apertura*. Venice: Apud B. Caesatum.
- . 1574. *De gnomonum umbrarumque ....* Torino.
- BERNARDI, M. 1963. *Tre palazzi a Torino*. Torino: Istituto Bancario S. Paolo.
- BETTINI, M. 1647-48. *Aerarium Philosophiae Mathematicae*, 2 vols. Bononiae: J. B. Feroni.
- BOULEAU, C. 1963. *The Painter's Secret Geometry: A Study of Composition in Art*. New York: Harcourt & Brace.
- BRUNO, T. 1627. *De naturali et vero corpore ovato atque eius sectione et formatione*. Vicenza: F. Grossum.
- . 1631. *Dell'Armonia astronomica et geometrica, parte seconda*. Vicenza: Grossi.
- BULLIALDUS, I. 1657. *De lineis spiralibus*. Paris: Apud Sebastianum et Gabrielem Cramoisy.
- CARAMUEL, J. 1670. *Mathesis biceps vetus et nova*. Campaniae: Officina Episcopale.
- CAVALIERI, B. 1632. *Lo specchio ustorio*. Bologna: C. Ferroni. Rpt. 2001, E. Giusti, ed.
- . 1645. *Geometria indivisibilibus continuorum nova quadam ratione promota*. Bononiae.
- CERRI, M. G. 1985. *Architetture tra storia e progetto. Interventi di recupero in Piemonte 1972-1985*. Torino: Allemandi.
- . 1990. *Palazzo Carignano. Tre secoli di idee, progetti e realizzazioni*. Torino: Allemandi.
- CERRI, M. G., TURCHI E., CARENA L. 1997. *Un simbolo del Barocco a Torino. La Cappella della Sindone 1610-1997*. Torino: Unesco.
- CLAVIUS, C. 1574. *Euclidis Elementorum libri XV*. Rome: Apud V. Accoltum. (Rpt. Rome 1589, Köln 1591, Rome 1603, Köln 1607, Rome 1629, Frankfurt 1654.)
- . 1606. *Geometria practica*. Rome.
- . 1612. *Opera Mathematica*, 5 vols. Moguntiae: R. Eltz.
- COMMANDINO, F. 1572. *Euclidis Elementorum libri XV*. Pesaro.
- . 1575. *Degli Elementi d'Euclide Libri quindici con gli Scholii antichi tradotti prima in lingua latina ... e con commentarii illustrati, et hora d'ordine dell'istesso trasportati nella nostra vulgare et da lui riveduti*. Urbino: D. Frisolino.

- . 1588. *Pappi Mathematicae Collectiones ....* Pesaro.
- COXETER, H. S. M. 1961. *Introduction to geometry*. New York: John Wiley & Sons.
- . 1963. *Regular polytopes*. New York: Macmillan.
- D'AGUILLON, F. 1613. *Opticorum libri sex Philosophis iuxta ac Mathematicis utiles*. Antwerp: Ex of. Plantiniana.
- DECHALES, C. F. M. 1674. *Cursus seu Mundus Mathematicus*. Lyon.
- DI MACCO, M., G. ROMANO. 1989. *Diana trionfatrice. L'arte di corte nel Piemonte del Seicento*. Torino: Allemandi.
- GUARINI, G. 1665. *Placita Philosophica*. Paris: Dionysium Thierry.
- . 1671. *Euclides adauctus et methodicus*. Torino: Typis Bartholomaei Zapatae.
- . 1674. *Modo di misurare le fabbriche*. Torino: Per gl'Heredi Gianelli.
- . 1675. *Compendio della sfera celeste*. Torino: Giorgio Colonna.
- . 1676. *Trattato di fortificazione*. Torino: Appresso gl'heredi di Carlo Gianelli.
- . 1678. *Leges temporum et planetarum*. Torino: Ex typ. haeredum Caroli Ianelli.
- . 1683. *Coelestis mathematicae*. Milan: Ex typ. Ludovici Montiate.
- . 1686. *I disegni d'architettura civile et ecclesiastica*. Rpt. 1966, D. De Bernardi Ferrero, ed. Torino: Bottega d'Erasmus.
- . 1737. *Architettura civile*. Torino: G. Mairesseo. Rpt. 1968, Milan: Il Polifilo.
- GULDIN, P. 1642. *De centro gravitatis ...* Viennae: Formis Mattaei Cosmerovij, 4 vols., 1635 - 1641.
- HÉRIGONE P. 1634-37. *Cursus Mathematicus, nova, brevi, et clara methodo demonstratus, per Notas reales et universales, citra usum cujuscunque idiomatis, intellectu faciles. Cours mathématique, démontré d'une nouvelle, briefue et claire methode, par Notes reelles et universelles, qui peuvent estre entenduës facilement sans l'usage d'aucune langue*, 5 vols. Paris: H. le Gras.
- KLAIBER, S. E. 1993. Guarino Guarini's Theatine Architecture. Ph.D. thesis, Columbia University.
- LEOTAUD, V. 1663. *Cyclomantia seu de multiplici circuli contemplatione libri 3*. Lyon.
- MAGINI, G. A. 1592. *Tabula tetragonica, seu quadratorum numerorum*. Venice: Ciotti.
- MILLON, H. A. 1999. *I trionfi del Barocco. Architettura in Europa 1600-1750*. Milan: Bompiani.
- MYDORGE, C. 1639. *Prodromi catoptrorum et dioptrorum sive conicorum operis ad abdita radii reflexi et refracti*, 2nd ed. Paris: Ex typ. Dedin. (1st ed. 1631, Paris).
- PACIOLI, L. 1494 *Summa de Arithmetica, Geometria Proportioni et Proportionalità*. Vinegia: P. de Paganini.
- . 1509 *Divina proportione*, Venetiis: P. Paganinus.
- PASSANTI, M. 1941. *La real cappella della S. Sindone in Torino*. Torino: Accame.
- . 1963. *Nel mondo magico di Guarino Guarini*, Torino: Toso.
- [Proceedings 1970]. *Guarino Guarini e l'internazionalità del Barocco*. Atti del Convegno Internazionale Accademia delle Scienze di Torino, 1968. 2 vols. Torino: Accademia delle Scienze.
- ROBISON, E. C. 1985. Guarino Guarini's Church of San Lorenzo in Turin. Ph.D. thesis, Cornell University.
- . 1991. Optics and Mathematics in the Domed Churches of Guarino Guarini. *Journal of the Society Architectural Historians* 50, 4 (December 1991): 384-401.
- ROERO, C. S. 1999. Mean, Proportion and Symmetry in Greek and Renaissance Art. *Symmetry: Culture and Science, The Quarterly of the International Society for the Interdisciplinary Study of Symmetry (ISIS-Symmetry)*, Special Issue: *Chapters from the History of Symmetry edited by György Darvas* 9, 1-2: 17-47.
- . 2000. Media, proporzione e simmetria nella matematica e nell'arte da Policletto a Dürer. Pp. 40-59 in *Conferenze e seminari 1999-2000*, E. Gallo, L. Giacardi, C. S. Roero, eds. Torino: Associazione Subalpina Mathesis.
- . 2005. *Les symétries admirables de Guarino Guarini*. Pp. 425-442 in *Symétries, Contribution au séminaire de Han-sur-Lesse, septembre 2002*, P. Radelet de Grave, ed. *Réminiscences* 7. Turnhout: Brepols.



- . 2006. La geometria del compasso fisso nella matematica e nell'arte. Pp. 247-274 in *Matematica Arte e Tecnica nella Storia*, L. Giacardi, C. S. Roero, eds. Torino: Kim Williams Books.
- ROMANO, G., ed. 1999. *Torino 1675-1699. Strategie e conflitti del Barocco*. Torino: Cassa di Risparmio di Torino.
- SAINT VINCENT, Grégoire. 1647. *Opus geometricum quadraturae circuli et sectionum conii*. 2 vols. Antwerp.
- SBACCHI, M. 2001. Euclidism and Theory of Architecture, *Nexus Network Journal* **3**, 2: 25-38.
- SCHOTT, C. 1661. *Cursus Mathematicus sive Absoluta omnium Mathematicarum Disciplinarum Encyclopaedia, in Libros XXVIII digesta, eoque ordine disposita, ut quivis, vel mediocri praeditus ingenio, totam Mathesin a primis fundamentis proprio Marte addiscere possit. Opus desideratum diu, promissum a multis, a non paucis tentatum, a nullo numeris omnibus absolutum*. Herbipolis (Würzburg): Jobus Hertz.
- . 1662a. *Mathesis Caesarea*, Herbipolis (Würzburg): Schonwetter, 1662.
- . 1662b. *Physica curiosa sive mirabilia naturae et artis*. Herbipolis (Würzburg): Jobus Hertz.
- TARTAGLIA, N. 1565. *Euclide Megarense philosopho, solo introduttore delle scienze matematiche diligentemente rassettato et alla integrità ridotto*. Venice: Appresso Curtio Troiano.
- TORRETTA, G. 1968. *Un'analisi della cappella di S. Lorenzo di Guarino Guarini*. Torino: Edizioni Quaderni di studio.
- TRICOMI, F. G. 1970. Guarini matematico. Pp. 551-557 in vol. II of *Guarino Guarini e l'internazionalità del Barocco*. Atti del Convegno Internazionale Accademia delle Scienze di Torino, 1968. Torino: Accademia delle Scienze
- ULIVI, E. 1990. Il tracciamento delle curve prima di Descartes. Pp. 517-541 in *Descartes: il metodo e i saggi*, G. Belgioioso, ed. Rome: Istituto della Enciclopedia Italiana.
- VALERIO, L. 1661. *De centro gravitatis solidorum libri tres*. Bononiae: Ex. typ. Haeredum de Duccijs.
- VITALI, G. 1668. *Lexicon mathematicum, astronomicum, geometricum*. 1st ed. Paris: Ex Officina Ludovic Billaine. 2nd ed. Romae, 1690.
- VIVIANI, V. 1659. *De maximis et minimis geometrica diuinatio in quantum Conicorum Apollonii Pergaei adhuc desideratum ... liber primus[-secundus]*. Florentiae: apud Ioseph Cocchini.
- WILLIAMS, K., ed. 1996. *Nexus: Architecture and mathematics*. Fucecchio: Edizioni dell'Erba.

### ***About the author***

Clara Silvia Roero is full professor of History of Mathematics at the University of Torino. She is a member of the editorial board of several journals, including *Bollettino di Storia delle Scienze Matematiche*, *Revue d'histoire des mathématiques*, *Lettera Matematica Pristem*, and *Il Maurolico*. She is on the Scientific Committee for the collected scientific papers of the mathematicians and physicists of the Bernoulli family, for the National Edition of the R. G. Boscovich's works, and for the papers of M. G. Agnesi. She was President of the Italian Society of History of Mathematics (SISM) from 2000 to 2008, and a member of the International Commission of History of Mathematics. She is currently Director of the Torino Research Group on History of Mathematics. She was been visiting professor at the Utrecht University Department of Mathematics (1995) and at the Institut de Physique théorique, Université de Louvain-la-Neuve. She has been an invited speaker in several International and National Conferences, including Nexus 2006 in Genova. She is the author of several articles and books on the history of mathematics. Her research topics include: mathematics and art in Greece and the Renaissance; Egyptian mathematics, Zeno's paradoxes, Islamic algebra, G. Benedetti, the history of probability theory, the history of the Leibnizian infinitesimal calculus, Lagrange, eighteenth- and nineteenth-century mathematics at the University of Torino, and the works of G. Peano and his disciples.