



**Conférence Européenne
des Directeurs des Routes**

**Conference of European
Directors of Roads**

Forgiving roadsides design guide



November 2012

Authors:

This report was drawn up by the **IRDES ERA-NET** 'Safety at the Heart of Road Design' Team:

Author: Francesca La Torre, UNIFI, Italy (Representing ANAS in CEDR TG Road Safety)

Contributors:

| | |
|--|--------------------------------|
| Lorenzo Domenichini, UNIFI, Italy | Matthias Helfert, AIT, Austria |
| Alessandro Mercaldo, UNIFI, Italy | Philippe Nitsche, AIT, Austria |
| Helen Fagerlind, CHALMERS, Sweden | Yann Goyat, IFSTTAR, France |
| Jan Martinsson, CHALMERS, Sweden | Eleonora Cesolini, ANAS, Italy |
| Dennis Book, CHALMERS, Sweden | Raffaella Grecco, ANAS, Italy |
| Peter Saleh, AIT, Austria (Main author of Annex A) | Federica Bianchin, ANAS, Italy |

**With editorial input from the following members
of CEDR Technical Group Road Safety:**

| | | | |
|---------------------|------------------|--------------------|----------------|
| Harry Cullen | Ireland (Chair) | Francesca LA TORRE | Italy |
| Forbes VIGORS | Ireland (Sec) | Barbara RUBINO | Italy |
| Eva EICHINGER-VILL | Austria | Paul MANGEN | Luxembourg |
| Didier ANTOINE | Belgium-Wallonia | Herman MONING | Netherlands |
| Photis MATSIS | Cyprus | Arild ENGBRETSSEN | Norway |
| Reigo UDE | Estonia | Arild RAGNOY | Norway |
| Auli FORSBERG | Finland | Leszek KANIA | Poland |
| Gerard VUILLEMIN | France | Zvonko ZAVASNIK | Slovenia |
| Stefan MATENA | Germany | Roberto LLAMAS | Spain |
| Christina PANAGOLIA | Greece | Jose M. PARDILLO | Spain |
| Tibor MOCSÁRI | Hungary | Lena RYDEN | Sweden |
| Audur ARNADOTTIR | Iceland | Christoph JAHN | Switzerland |
| Giovanni MAGARO | Italy | Sandra BROWN | United Kingdom |

*This document expresses solely the current view of CEDR. Readers should not regard these views as a statement of the official position of CEDR's member states.
Equally this document is considered as a guide; it is not a legally binding document.*

Approved and amended by: CEDR's EXECUTIVE BOARD on 7 March 2013

Addressed to: CEDR's GOVERNING BOARD on 15 May 2013

Edited and published by: CEDR's Secretariat General

ISBN : 979-10-93321-01-1

Foreword

CEDR Technical Group Road Safety (TGRS) is very proud to have delivered one of the most significant documents in recent years on the subject of forgiving roadsides.

CEDR has identified the design of forgiving roads as one of the top priorities within its Strategic Plan 2009–2013. For this reason, a specific team dealing with forgiving roadsides was established within CEDR TGRS, led by Francesca La Torre representing ANAS in Italy.

This CEDR TGRS report effectively reflects the work done by the ERANET 'IRDES' project. Ms La Torre was one of the members of the group and she is the main author of this report.

TGRS was fortunate that a number of the members of CEDR TGRS sat on the ERANET Programme Executive Board (PEB) and were able to monitor and guide the project through its development. Moreover, the other members of CEDR TGRS were involved via webinars and in discussions on the subject with the project team during TGRS's regular meetings. In this way, the document has clearly defined recommendations for (national) road administrations in Europe.

The roadside features for which the Forgiving Roadsides Design Guide has been developed are barrier terminals, shoulder rumble strips, forgiving support structures for road equipment, and shoulder width. Each feature is analysed in a separate section of the guide.

On behalf of CEDR TGRS, I would urge all practitioners working in the area road safety to study this document with a view to taking on board the best practice suggestions contained within.

Further information on forgiving roadsides is available at <http://www.irdes-eranet.eu>. Additional roadside features have been analysed in the state of the art report and in the effectiveness evaluation studies.

CEDR Technical Group Road Safety

Executive summary

Analyses of fatal road accidents in the European Union show that 45% are single-vehicle accidents. These accidents are primarily classified as run-off-road accidents, where the vehicle leaves the road and enters the roadside.

A roadside is called unforgiving if hazardous objects such as trees are placed at an inappropriate distance from the road so that the risk of severe accidents is increased. The purpose of the 'forgiving roadside' concept is to avoid crashes of errant vehicles with potential hazards or to minimise crash consequences.

CEDR has identified the design of forgiving roads as one of the top priorities in its Strategic Plan 2009–2013. For this reason, a specific team dealing with forgiving roadsides was established within CEDR's Technical Group Road Safety (TGRS).

In recent years, several projects have been conducted with a view to producing guidelines to design forgiving roadsides worldwide, and several national standards have been produced. However, different approaches are often proposed. The final results of trans-national research projects, aimed at identifying harmonised solutions, are often extremely scientific but not practical and result in a lack of applicability.

Based on the results of a detailed state of the art review and a study on the evaluation tools related to roadside features and an additional literature review, this activity produced a practical guide that can be applied in practice in road safety design projects thanks to interaction with road administrations and operators (through the webinars that have been organised and through the synergy with the CEDR TG Road Safety). The different interventions proposed are linked to the potential effectiveness estimated and defined in the effectiveness study and in other relevant literature in order to allow the user to perform a cost-effectiveness evaluation before planning a specific treatment.

One issue has been the harmonisation of different existing standards or the identification of underlying reasons for different existing solutions for the same treatments in order to allow the user to select the optimum treatment and to properly assess its effectiveness.

The roadside features for which the Forgiving roadsides design guide has been developed are:

- barrier terminals,
- shoulder rumble strips,
- forgiving support structures for road equipment, and
- shoulder width.

Each feature is analysed in a separate section of the guide providing:

- an introduction,
- design criteria,
- assessment of effectiveness,
- case studies/examples, and
- key references.

This Forgiving roadsides design guide is a harmonised collection of best practice treatments to make roadsides forgiving. CEDR TG Road Safety recommends this guide to all practitioners working in road safety.

As a complement to the core part of the guide providing guidance to the designers, Annex A provides a comprehensive overview of the state of the art in the field of forgiving roadsides and a detailed description of studies conducted as part of this project in order to evaluate the effectiveness of different roadside safety treatments.

Table of contents

| | |
|--|----|
| Foreword | 3 |
| Executive summary | 4 |
| Abbreviations | 6 |
| 1 Introduction to the Forging roadsides design guide | 7 |
| 1.1 Motivation and goals | 7 |
| 1.2 Methodology | 7 |
| 1.3 Definition of roadside | 8 |
| 1.4 The Forging Roadsides Guide within the framework of ERANET SRO1 Projects. | 8 |
| 2 Barrier terminals | 9 |
| 2.1 Introduction | 9 |
| 2.2 Design criteria | 10 |
| 2.3 Assessment of effectiveness | 23 |
| 2.4 Case studies/examples | 23 |
| 2.5 References | 24 |
| 3 Shoulder rumble strips | 26 |
| 3.1 Introduction | 26 |
| 3.2 Design criteria | 27 |
| 3.3 Assessment of effectiveness | 36 |
| 3.4 Case studies/examples | 39 |
| 3.5 References | 41 |
| 4 Forging support structures for road equipment | 41 |
| 4.1 Introduction | 41 |
| 4.2 Design criteria | 43 |
| 4.3 Assessment of effectiveness | 50 |
| 4.4 Case studies/examples | 52 |
| 4.5 References | 52 |
| 5 Shoulder width | 52 |
| 5.1 Introduction | 52 |
| 5.2 Design criteria | 53 |
| 5.3 Assessment of effectiveness | 55 |
| 5.4 Case studies/examples | 58 |
| 6 Conclusion and recommendations | 59 |

| | | |
|-----|--|-----|
| 7 | Foreword to Annex A | 69 |
| 8 | Roadside hazards | 69 |
| 8.1 | Single fixed obstacles | 71 |
| 8.2 | Continuous hazards | 76 |
| 8.3 | Dynamic roadside hazards..... | 79 |
| 9 | Treatments to make roadsides forgiving | 79 |
| 9.1 | Removal and relocation of obstacles..... | 80 |
| 9.2 | Modifying roadside elements..... | 91 |
| 9.3 | Shielding obstacles | 97 |
| 10 | Identification of further research needs | 104 |
| | ANNEX A - References..... | 105 |
| | ANNEX B: Glossary | 109 |

Abbreviations

| Abbreviation | Definition |
|--------------|---|
| AADT | Annual average daily traffic |
| AASHTO | American Association of State and Highway Transportation Officials |
| CEDR | Conference of European Directors of Roads or Conférence Européenne des Directeurs des Routes |
| ERA-NET | European Research Area Network |
| IRDES | Improving Roadside Design to Forgive Human Errors |
| HSM | Highway Safety Manual |
| NCHRP | National Cooperative Highway Research Programme |
| PTW | Powered two-wheeler |
| RISER | Roadside Infrastructure for Safer European Roads |
| ROR | Run-off-road |
| RVS | Richtlinien und Vorschriften für das Straßenwesen (Austrian Standards) |
| SVA | Single-vehicle accident |
| TG | technical group |
| TRB | Transportation Research Board |

1 Introduction to the Forging roadsides design guide

CEDR has identified the design of forgiving roads as one of the top priorities in its Strategic Plan 2009–2013. For this reason, a specific team dealing with forgiving roadsides was established within CEDR's Technical Group on Road Safety (TGRS).

The aim of this document is to collect and harmonise common standards and guidelines for roadside treatments. This report introduces typical roadside hazards, which are the basis for appropriate counter-measures. The main part of this report comprises results and findings from relevant literature, guidelines, and standards dealing with roadside treatments.

1.1 *Motivation and goals*

Each year, 43,000 people are fatally injured in Europe as a result of road accidents. The RISER project has shown that even though 10% of all accidents are single-vehicle accidents (typically run-off-road (ROR) accidents), the rate of these events increases to 45% when only fatal accidents are considered [1]. One of the key issues of this high ROR fatality rate is to be found in the design of roadsides, which are often 'unforgiving'.

A number of different studies have been conducted in recent years with a view to designing roadsides that forgive human errors, but there is still a need for:

- a practical and uniform guide that allows the road designer to improve the forgivingness of the roadside;
- a practical tool for assessing (in a quantitative manner) the effectiveness of applying a given roadside treatment.

The goal of this document is to summarise state-of-the-art treatments to make roadsides forgiving and to harmonise currently applied standards and guidelines.

1.2 *Methodology*

Based on the results of the ERANET IRDES project, and with editorial input from CEDR TGRS, a design guide has been developed to assist the user in designing a properly selected roadside treatment and evaluating its effectiveness in terms of potential crash reductions. The roadside features for which the Forging roadsides design guide has been developed are:

- barrier terminals,
- shoulder rumble strips,
- forgiving support structures for road equipment, and
- shoulder width.

Each feature will be analysed in a separate section of the guide.

Additional roadside features have been analysed in the state of the art report (Annex A) and in the effectiveness evaluation studies [2]. In the latter, the potential safety effects of applying different treatments (hard shoulders, soft shoulders, crash barriers) in sharp bends have been analysed and a procedure to perform effectiveness evaluations on specific applications has been proposed.

1.3 Definition of roadside

According to the RISER project [1], a roadside is defined as the area beyond the edge line of the carriageway. Views in the literature differ as to which road elements are part of the roadside and which are not. In this guide, the median is considered to be part of the roadside, since it defines the area between a divided road-way. Therefore, all elements located on the median are also considered to be roadside elements. Figure 1 depicts a roadway cross-section (cut and embankment section) including some roadside elements. In this specific figure, the roadside can be seen as the area beyond the traffic lanes (or carriageway). The shoulders are thus part of the roadside, since the lane markings define the boundaries. The slopes, the clear zones (which are also known as 'safety zones'), or the tree are examples of roadside features that are discussed in detail in Annex A.

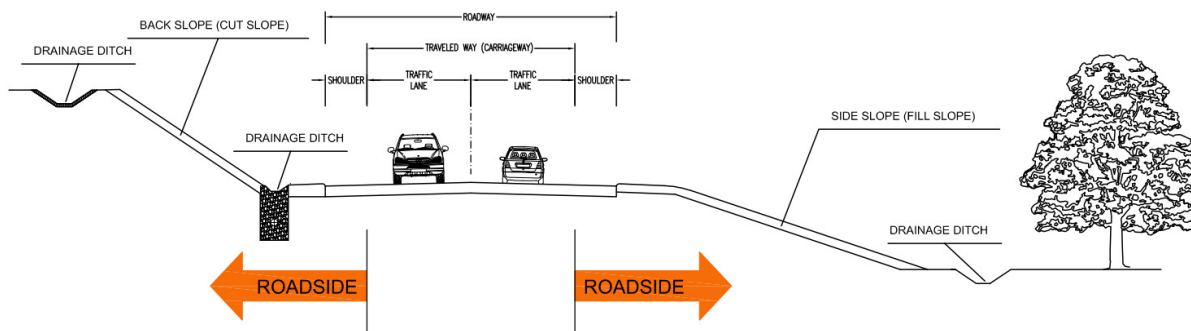

Figure 1: Roadway cross-section with examples of roadside elements

1.4 The Forging Roadside's Guide within the framework of ERANET SRO1 Projects.

This project is one of the five projects funded within the ENR SRO1 programme 'Safety at the Heart of Road Design' aimed at improving road safety by increasing the awareness and acceptance of implementing joint road safety solutions in accordance with the concepts of **self-explaining roads** and **forgiving roadsides**, taking human factors and human tolerance into consideration.

The results of this project should therefore be seen in combination with the results of the other four projects in order to define integrated safety programmes that aim to have both self-explaining and forgiving roads and to make sure the interrelation between self-explaining roads and forgiving roadsides is considered in the design process.

More detailed information on the ERANET SRO1 programme can be found at http://www.eranetroad.org/index.php?option=com_content&view=article&id=74&Itemid=74.

1.4.1 Forgiving vs. self-explaining

Forgiving and self-explaining roads are two different concepts of road design that seek to reduce the number of accidents on the whole road network. This report only deals with forgiving roadsides. However, the term 'self-explaining' needs to be defined in order to differentiate it from the term 'forgiving'.

According to [4], self-explaining roads are based on the idea that appropriate speed or driving behaviour can be induced by the road layout itself. This therefore reduces the need for speed limits or warning signs. It is generally known that multiple road signs in complex traffic situations can lead to an information overload and an increased risk of driving errors. Herrstedt [5] writes that a safe infrastructure depends on a road-user-adapted design of different road elements such as markings, signs, geometry, equipment, lighting, road surface, traffic and speed management, traffic laws, etc. The idea behind self-explaining roads is to design the road according to an optimal combination of these road elements.

In short: **self-explaining roads seek to prevent driving errors, while forgiving roads minimise their consequences.** The first priority of forgiving roadsides is to reduce the consequences of an accident caused by driving errors, vehicle malfunctions, or poor roadway conditions. It must focus on treatments that bring errant vehicles back into the lane to reduce injury or fatal run-off-road accidents. If the vehicle still hits a road element, the second priority is to reduce the severity of the crash. In other words, the roadside should forgive the driver his/her error by reducing the severity of run-off-road accidents.

Forgiving roads depend on how the roadside is designed and equipped. However, the roadside is also a component of the driver's field of view, which governs the driver's behaviour. According to PIARC Human Factors Guidelines [6], a well-designed field of view helps enhance road safety.

Therefore, well designed roadsides help achieve both self-explaining and forgiving roads.

The requirements for the design of forgiving roadsides, which will be given in this document, have to be combined with the requirements for the design of self-explaining roads. A comprehensive compatibility analysis is therefore necessary prior to the finalisation of the design of the roadsides.

2 Barrier terminals

2.1 Introduction

Safety barriers are forgiving roadside treatments that are designed to shield hazardous obstacles and/or to prevent vehicles from running off the roadway. However, the ends or transitions between two different types of barriers can result in hazardous roadside objects. Safety barrier ends are considered hazardous when the termination is not properly anchored or ramped down in the ground, or when it does not flare away from the carriageway [7]. The RISER database contains 41 accidents where barriers were the only obstacles involved. In 14 cases (i.e. 34.1%), the end of the barrier was hit. Crashes with 'unforgiving' safety barrier ends often result in a penetration of the passenger compartment.

This section of the Forgiving roadsides design guide seeks to provide practical guidelines on how to properly design a barrier terminal and how to evaluate the effectiveness of replacing unprotected terminals with crashworthy terminals.

2.2 *Design criteria*

2.2.1 Unprotected vs. crashworthy terminals

An unprotected terminal (also called an 'exposed' terminal) is a barrier end termination that is aligned parallel (or close to parallel) to the travelled lane that is within the roadside clear zone (Figure 2) and that, in case of head-on impact, can stop the vehicle abruptly with barrier elements that can penetrate the vehicle itself or can cause the vehicle to roll over after impacting against the terminal (Figure 3). Crashworthy terminals are barrier end treatments that seek to either redirect the vehicle onto the carriageway or safely decelerate the vehicle after the head-on impact with the terminal's nose.



Figure 2: Unprotected (or 'exposed') terminals



Figure 3: Head on collision with an unprotected terminal [8]

2.2.2 Energy-absorbing vs. non-energy-absorbing terminals

Crashworthy terminals can be designed in such a way as to redirect vehicles back onto the carriageway or to stop them immediately, so that they cannot pass through the barrier. The first type of terminal is called a 'flared' terminal, as the alignment of the terminal diverges from the alignment of the roadway edge (Figure 4). The second type is called a 'tangent' terminal, as the alignment of the terminal is parallel to the roadway edge (Figure 5). Tangent terminals aim to stop the vehicle; they have to be treated as energy-absorbing devices that have to be tested in accordance with ENV 1317-4 (which will be superseded by the EN 1317-7 standard, as detailed in chapter 2.5.1). Flared terminals are not usually designed to dissipate significant amounts of kinetic energy in a head-on crash and are therefore considered non-energy-absorbing devices, even though there are a limited number of products (mainly on the US market) that are flared and energy-absorbing.



Figure 4: A flared terminal [9]



Figure 5: A tangent terminal [1]

Tangent terminals may be installed with a 0.3-m to 0.6-m offset from the barrier alignment (over the entire terminal length) to minimise hits against the nose. Flared terminals generally require a 1.2-m offset, although some designs have been successfully tested with offsets less than 0.9 m. Because the flared terminal is located further away from the travelled way, head-on impacts are less likely and the vehicle is more likely to be redirected back onto the carriageway without sudden decelerations.

On the other hand, in crash tests involving non-energy-absorbing terminals, un-braked vehicles have travelled more than 75 m behind and parallel to the guardrail installation or along the top of the barrier when struck head-on at high speeds.

Energy-absorbing terminals have demonstrated their ability to stop impacting vehicles within relatively short distances (usually 15 m or less, depending on the type of terminal) in high-speed head-on impacts on the terminal nose. If they are tangent, however, the probability of hitting the nose is higher than if the terminal is flared, and the impact severity on the occupants can be extremely high if the vehicle hits the nose while sliding with a considerable yaw angle.

The decision to use either an energy-absorbing terminal or a non-energy-absorbing terminal should therefore be based on the likelihood of a near end-on impact and the nature of the recovery area immediately behind and beyond the terminal. If the barrier Length of Need (see chapter 2.2.5) is properly defined and guaranteed and the terminal is therefore placed in an area where there is no need for safety barrier protection, it is unlikely that a vehicle will reach the primary shielded object after an end-on impact regardless of the terminal type selected. Therefore if the terrain beyond the terminal and immediately behind the barrier is safely traversable, a flared terminal is preferable.

If, because of local constraints, the proper Length of Need cannot be guaranteed or if the terrain beyond the terminal and immediately behind the barrier is not safely traversable, an energy-absorbing terminal is recommended.

Flared non-energy-absorbing terminals

The advantage of using flared non-energy-absorbing terminals is that there are usually non-proprietary terminals that can essentially be installed as a termination on any W-beam steel barrier. The most commonly flared non-energy-absorbing terminals are the Eccentric Loader Terminal (ELT) and the Modified Eccentric Loader Terminal (MELT).

The ELT is a non-proprietary system that has a flared design with the end consisting of a fabricated steel lever nose inside a section of corrugated steel pipe (Figure 6).

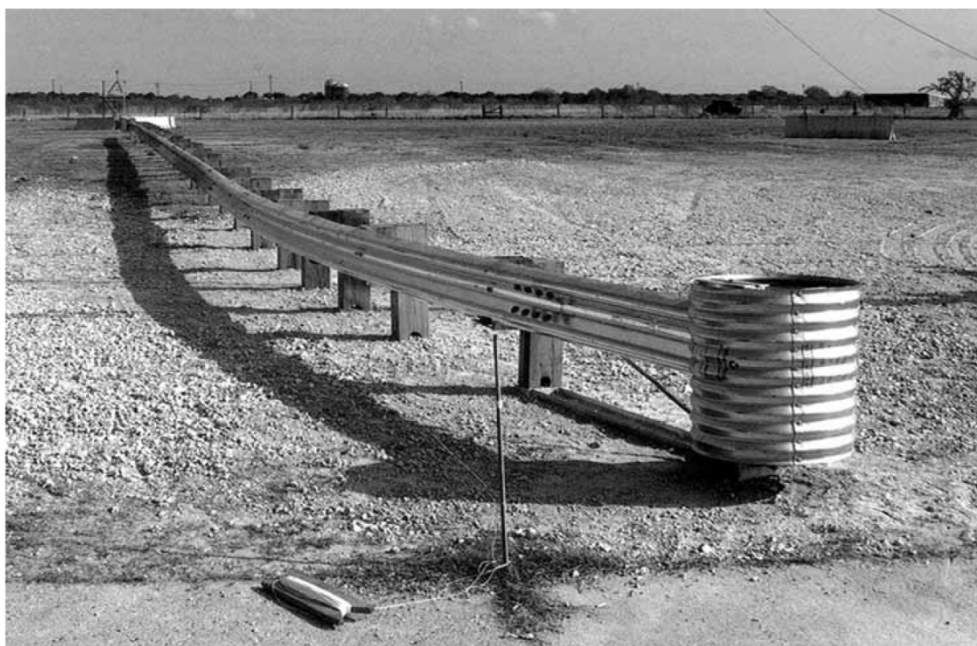

Figure 6: A non-proprietary Eccentric Loader Terminal (ELT) [10]

The ELT is 11.4 m long and is designed with a curved flare that provides a 1.2-m offset in the end post. This curvature is critical for proper impact performance. The rail elements should be field-bent, while all posts should be wooden. The Length of Need point, which is the point after which an errant vehicle should not gate the terminal (see chapter 2.2.5), is located 3.81 m from the end of the terminal.

The MELT is a modified version of the ELT. Several design configurations are available worldwide with the name MELT or WAMELT or similar. The version described in the AASHTO Roadside Design Guide (Figure 7, [10]) has been tested to NCHRP Report 350 TL-2 for use on lower-speed roadways. This terminal is 11.4 m long and is designed with a parabolic flare that provides a 1.2-m offset to the end post and the Length of Need point is located at 3.8 m from the end of the terminal.

Several other MELT terminals, such as the MELT used in Oregon, USA [11], and the WAMELT used in Australia (Figure 8, [12]) are tested in NCHRP Report 350 class TL-3 at a test speed of 100 km/h and can therefore be considered equivalent to a P3 terminal in accordance with ENV 1317-4 (see chapter 2.5.1) even though technically not tested according to the CEN standards.



Figure 7: A non-proprietary Modified Eccentric Loader Terminal (MELT) for level TL-2 [10]

Drawing:

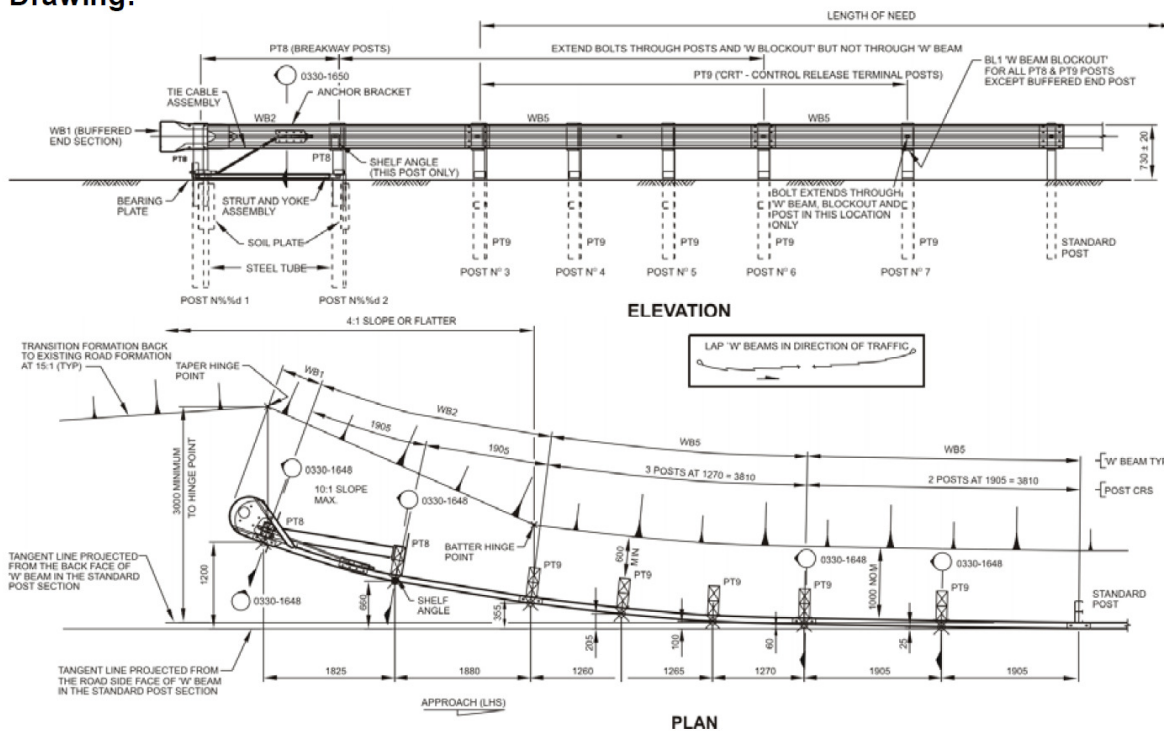

Figure 8: Australian non-proprietary Modified Eccentric Loader Terminal (WAMELT) for level TL-3 [12]

In several countries, flared non-energy-absorbing terminals are accepted based on design criteria with no crash test requirements (as is the case in the current draft of prEN 1317-7). However, they are essentially based on a very similar approach to the MELT terminals, as shown in Figure 9, which is often applied to new barrier designs for Italian motorways. In other countries (such as in Germany), only devices tested in accordance with ENV 1317-4 are allowed.

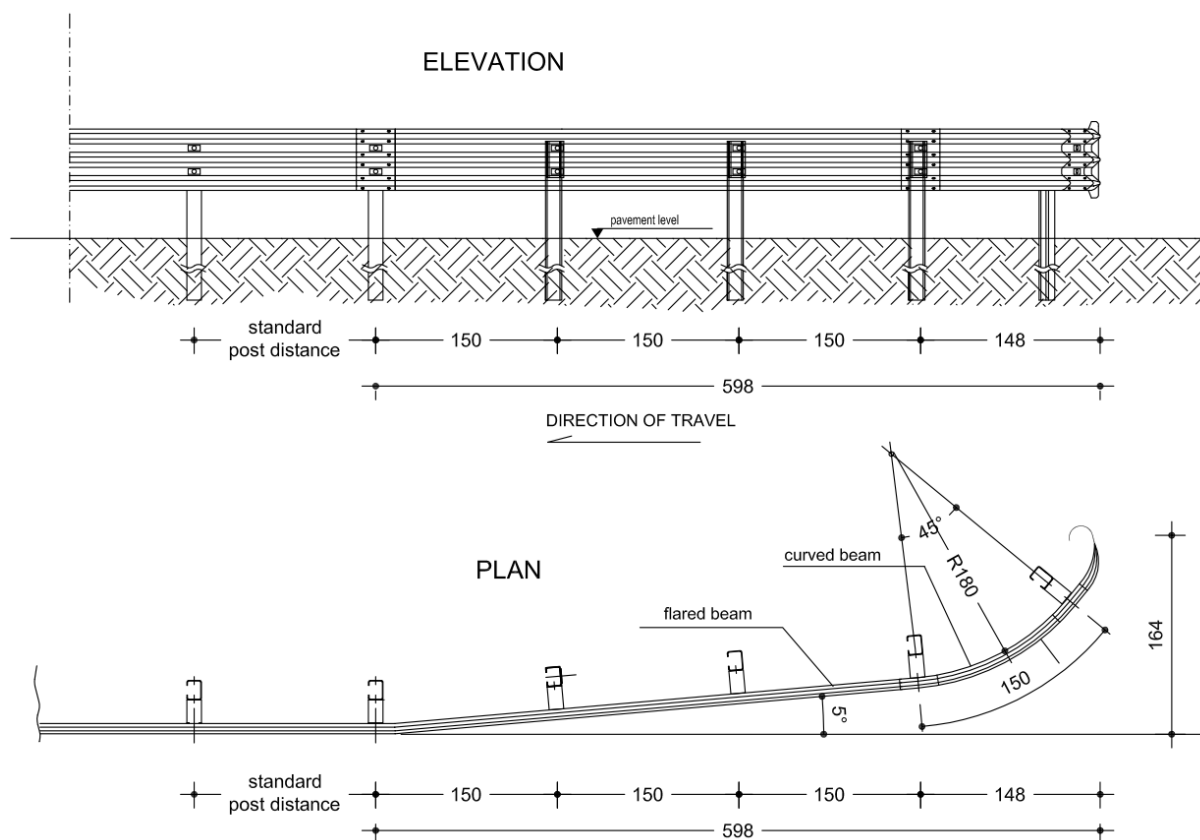

Figure 9: A flared terminal in use in most of the new installations on Italian motorways

To evaluate the effectiveness of this type of terminal, crashworthiness could be assessed using either a set of full scale crash tests or numerical simulations.

Turn-down terminals (Figure 10, *left*) or flared-degraded terminals (Figure 10, *right*), which have been widely used in several counties in the past, are now often being replaced in new designs by flared terminals with no degradation because the longitudinal slide that arises from the degradation to the ground can lead to an overriding of the barrier and this type of terminals are forbidden in several countries (as in the UK for roads with speed limits 80 km/h or above). It should be noted, on the other hand, that some studies conducted on in-service terminals in some countries (as in Germany), did not confirm such effect. In Germany, simply degraded terminals (not flared) are allowed on single-direction two-lane roads and have been tested in accordance with ENV 1317-2 in class P2U (12-m *Regelabsenkung*). Flared-degraded terminals, if used, can only work properly if the degraded end buried in the ground is very far from the travelled lane.

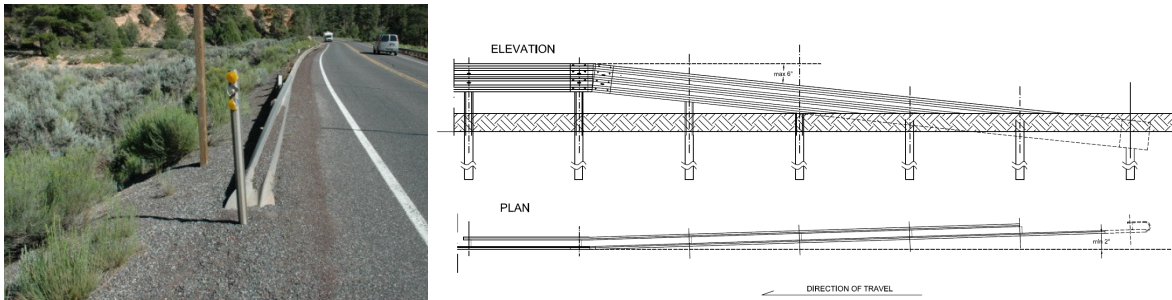

Figure 10: Turn-down terminal (*left*) and flared-degraded terminal (*right*)

On two-lane roads, terminals at both ends of the barrier should be crashworthy as head-on impacts can occur at both ends. On one-way roads, the downstream terminal of the barrier can be terminated with a simply degraded terminal (not flared) or can even be left unprotected.

Tangent energy-absorbing terminals

Most energy-absorbing terminals are proprietary devices. In order to be used in the EU, they have to be tested in accordance with ENV 1317-4 [13] (currently applicable) and EN 1317-7 (when it is officially released and published by CEN (see chapter 2.5.1)). One of the very few non-proprietary energy-absorbing terminals is the Midwest Guardrail System (MGS) Terminal (Figure 11). This has been tested in the USA in accordance with the NCHRP350 standard; to be used in the EU, it would have to be tested in accordance with ENV 1317-4.



Figure 11: A Midwest non-proprietary energy-absorption terminal

As indicated in chapter 2.5.1, when using an energy-absorbing terminal in the EU, a performance class should be defined in accordance with ENV 1317-4. Some national standards provide indications of the minimum performance class to be applied as a function of the posted speed limit.

Table 1 shows the minimum performance classes required by the Italian Standard on Safety Barriers [14]. Where no national requirements are given, these requirements could be used as a guideline.

Table 1: Energy-absorbing terminals: minimum performance classes in accordance with ENV 1317-4 required by the Italian Standard [14]

| Posted speed limit (V) | Minimum performance class |
|---|---------------------------|
| $V \geq 130 \text{ km/h}$ | P3 |
| $90 \text{ km/h} \leq V < 130 \text{ km/h}$ | P2 |
| $V < 90 \text{ km/h}$ | P1 |

The German standard [15] requires that all upstream (start) and downstream (end) terminals be tested in accordance with ENV 1317-4 in class P2, specifying also that:

- for single-carriageway bi-directional two-lane roads (one lane per direction), P2A devices must be used (with the 'start' and 'end' terminal acting in both directions of travel);
- for mono-directional two-lane roads, P2U devices must be used (with the 'start' and 'end' terminal acting only in the direction of travel).

When using an energy-absorbing terminal, it is essential to check that the terminal being considered is compatible with the barrier system. The terminals are tested in accordance with ENV 1317-4 and are connected to a specific longitudinal barrier, which can affect the overall behaviour of the terminal. When using the terminal with a different barrier, the designer must check its compatibility in order to ensure the same on-site performance of the system.

2.2.3 Buried-in-backslope terminals

If the barrier termination is located in a section in cut, a buried-in-backslope terminal could be adopted (Figure 12).

According to the AASHTO Roadside Design Guide [10], this system provides full shielding of the identified hazard, eliminates the possibility of any end-on impact with the terminal, and minimises the likelihood of the vehicle passing behind the rail if designed according to the following criteria:

- The steepness of the slope that covers the end of the barrier should be nearly vertical, such as 1V:2H, in which the slope effectively becomes an extension of the barrier face and motorists cannot physically get behind the terminal. The Length of Need begins at the point where the installation crosses the ditch bottom.
- If there is a foreslope between the carriageway and the backslope, the buried-in-backslope design can still be applied if the foreslope is lower than 1V:4H. In these cases, the height of the W-beam rail should be held constant in relation to the roadway shoulder elevation until the barrier crosses the ditch bottom. When the distance from the ground to the bottom of the W-beam exceeds approximately 460 mm, a rail should be added below the W-beam to minimise the potential for wheel snag on the support posts.

When these conditions are not met, a crashworthy terminal—either energy-absorbing or non-energy-absorbing—should be installed.



Figure 12: A buried-in-backslope terminal [1]

2.2.4 Medians

Barrier terminations in medians are always extremely critical and should be avoided as much as possible by using, for instance, removable barriers in median getaways. If a barrier termination is needed (for instance where a single carriageway road is split in a dual carriageway with a barrier in the median) this should always be a tangent energy-absorbing terminal. It must, however, be designed specifically for medians and tested also for impacts in the rear side (position 5 kg B) in accordance with ENV 1317-4 [13]. This means that the device has to be classified for use in location 'A' (ALL: to be hit both upstream and downstream) in accordance with ENV 1317-4. Terminals tested only for location 'U' or 'D' (see chapter 2.5.1) cannot be applied in medians. If possible, the terminal should be symmetrical as lateral hits can occur on both sides.

In addition, the terminal behaviour during the crash should not result in having loose ends in the carriageway opposite to the direction of travel of the errant vehicle.

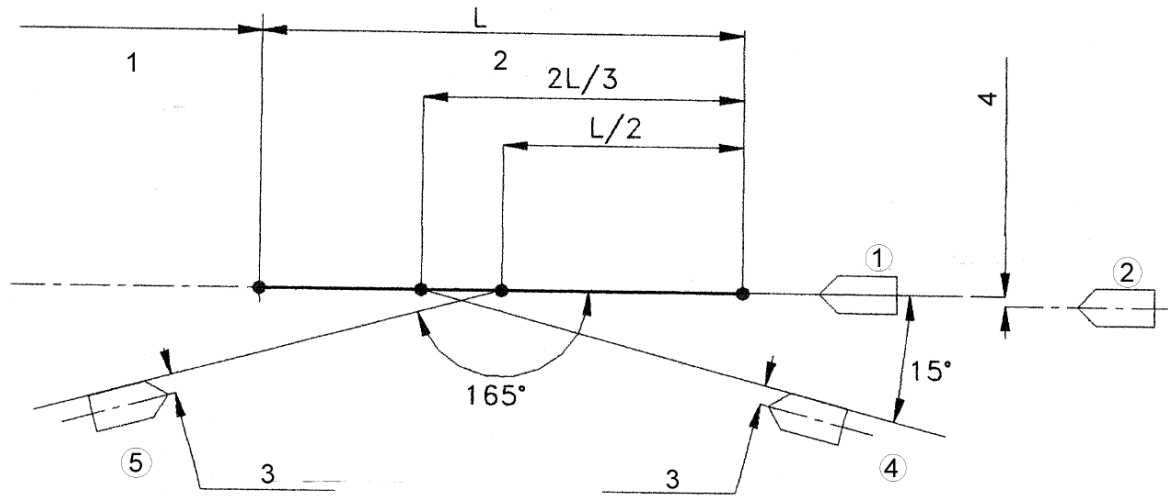

Figure 13: The test position for tangent terminals in accordance with ENV 1317-4 [13]

2.2.5 Length of Need

For angled impacts of 15 degrees or higher at the first post, all W-beam terminals perform about the same, and impacting vehicles will gate or pass through the terminal and travel behind and beyond it until they are stopped safely (Figure 14).



Figure 14: Result of an impact involving the first few posts of a terminal [1]

Manufacturers have to provide, for each terminal, the 'Length of Need' point, which means the point after which the longitudinal barrier to which the terminal is connected can be considered capable of offering the full resistance observed in the EN 1317-2 crash test.

It should be noted that if the terminal is not designed to also provide 'anchorage' for the barrier, the Length of Need point could be downstream from the end of the terminal.

The location of the 'Length of Need' point with respect to the first section that needs the barrier's protection (either an obstacle or the beginning of a bridge or any other hazardous location) is a key issue in roadside design.

According to the AASHTO Roadside Design Guide, the Length of Need can be determined as a function of the roadway design speed and of the average daily traffic (Fig. 15). According to the RISER Guidelines, the Length of Need can be defined with reference to a vehicle running off the road with an angle $\alpha=5^\circ$ (Fig. 16). This assumption leads to values similar to those of the AASHTO Roadside Design Guide for almost any obstacle offset for low-speed (50–60 km/h) low-volume roads (up to 5,000 vehicles/day). For highly trafficked or high-speed roads, the 5° angle could lead to an underestimation of the proper Length of Need. In such cases, a site-specific evaluation is recommended.

The Length of Need as defined above aims only to avoid the impact of passenger cars against the obstacle and might not be sufficient to provide the proper anchorage for the barrier when hit by a heavy vehicle.

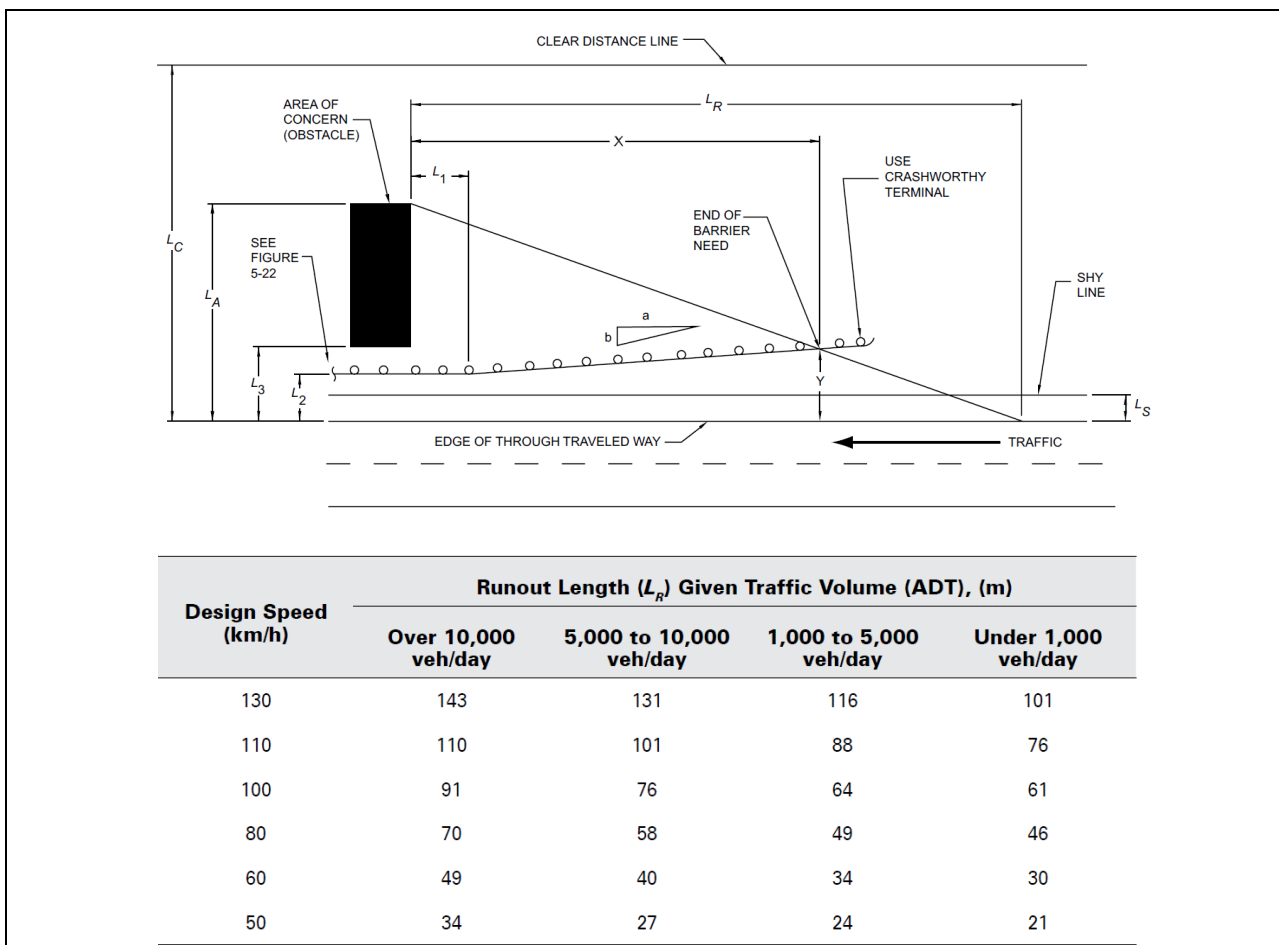

Figure 15: Definition of the Length of Need (X) in accordance with the AASHTO Roadside Design Guide [10]

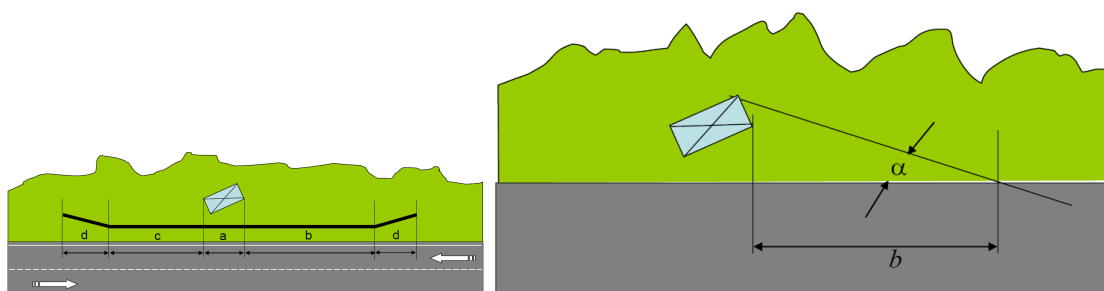

Figure 16: Definition of the Length of Need (b) in accordance with the RISER Guidelines [1]

2.2.6 Design of terminals in proximity to driveways

When a barrier termination is located in proximity to a driveway, the usual terminal configuration might not be applicable and specific solutions may have to be designed. The German standard 'Guidelines for passive protection on roads by vehicle restraint systems (RPS), 2009 Edition' proposes a set of solutions for different driveway configurations. The type of terminal (AEK) to be adopted will differ depending on whether an offset can be obtained (flared terminal) or not (tangent terminal) and depending on whether the terminal is on the main roadway or on the driveway.

If the barrier requires a lateral offset, this should be achieved with a flare rate of 1:20 – up to 1:2 in exceptional cases. The barrier should then run at least 15 m parallel to the roadway prior to the start of the hazardous area for two-lane roads and at least 10 m for single-lane roads.

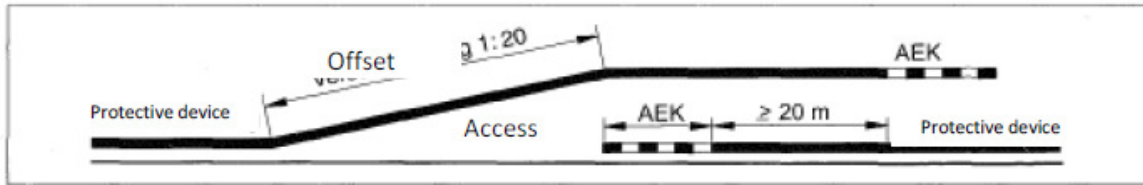

Fig. 10: Discontinuities of protective equipment for approaches

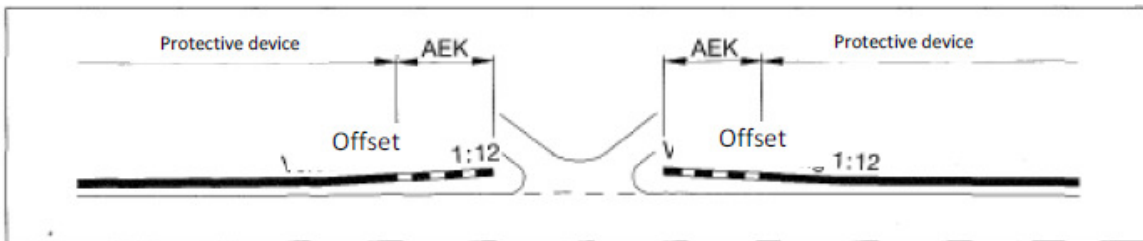

Fig. 11 a: Interruption of protective devices with start and end construction and with offsets

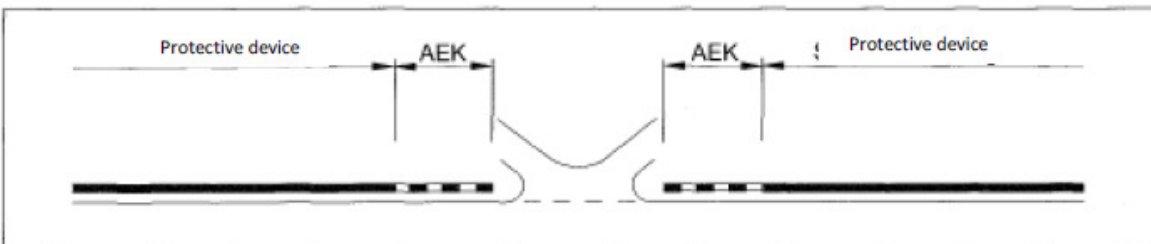

Fig. 11 b: Interruption of protective equipment with start and end construction in alignment of the protective device

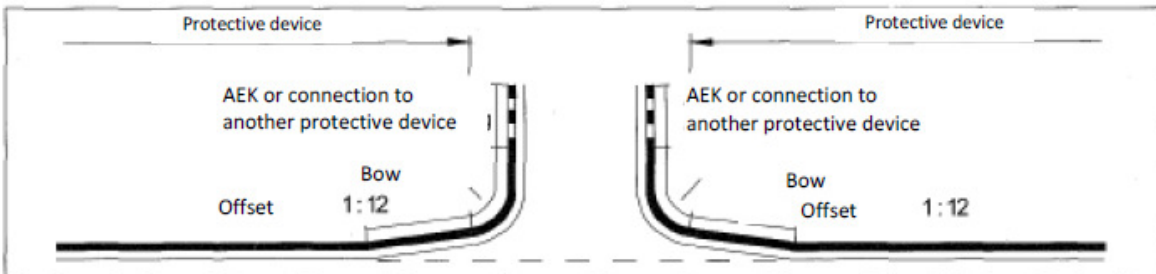

Fig. 11 c: Interruption of the protective equipment with curvature and offset

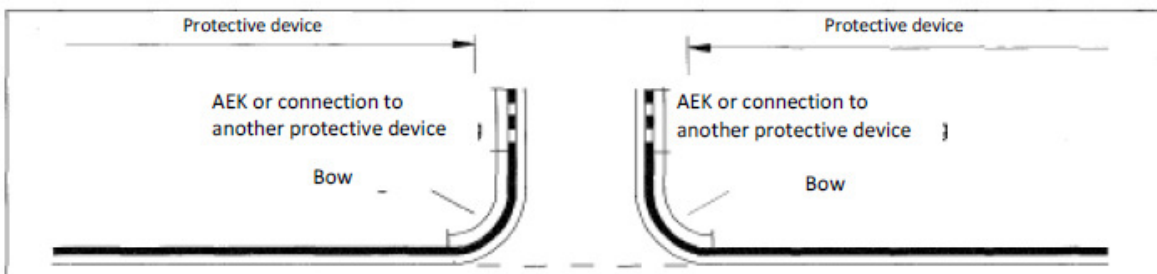

Fig. 11 d: Interruption of protective equipment with curvature, but without offset

Figure 17: Terminal configuration in proximity to driveways in accordance with the German guidelines [15]

2.3 *Assessment of effectiveness*

Even though road barrier terminations are commonly recognised as an important roadside safety hazard, there is currently no way of quantitatively estimating the safety effects of removing them.

The NCHRP Report 490 'In-service performance of safety barriers' analyses several studies concerning barrier terminals. However, it concluded that they are essentially devoted to understanding how a specific terminal works rather than quantifying the effect of modifying the terminal configuration [17].

In the recently published 'Highway Safety Manual', the Roadside Hazard Rating doesn't take account of terminal configuration [18].

One of the reasons for this is that crashes against terminals are rare; typical 'before/after' analysis cannot be performed in these cases.

In [2], a procedure for the determination of a CMF (Crash Modification Factor) for the number of unprotected (or 'exposed') terminals has been developed and a CMF has been derived from the data collected on part of the secondary rural network of the Arezzo Province. The statistical analysis conducted on a typical secondary rural network in Italy showed a significant reduction of the number of fatal and injury crashes when the number of unprotected terminals was reduced. A Crash Modification Factor was also derived as a function of the reduction in the number of unprotected terminals.

The formula relating the CMF to the number of unprotected terminals per km (UT) is given as:

$$CMF = e^{0.02381 \times UT}$$

The effect of changing the type of terminal from an unprotected to a flared or energy-absorbing terminal could not be established as this type of terminal has not yet been installed on the analysed network.

It should be noted, however, that the extensive in-service performance evaluation conducted in the USA [17] led to the conclusion that flared non-energy-absorbing terminals (in this specific case the MELT and the Breakaway Cable Terminal, BCT, which is similar to the MELT but with an added cable) perform well on site if installed correctly. Improper installation (inadequate offset, incorrect flare, or other installation flaws) or lack of maintenance was found to be the primary reason for unsatisfactory results in some applications.

2.4 *Case studies/examples*

Barrier terminals—both energy-absorbing and non-energy-absorbing—are now standard practice and not an experimental application. The NCHRP Report 490 'In-service performance of traffic barriers', published in 2003 [17], provides a very interesting overview of the in-service performance of most of the devices available at that time.

The AASHTO Roadside Design Guide Ed. 2010 [10] provides an extensive review of the terminals available in the US. However, it should be noted that these terminals are not necessarily compliant with ENV 1317-4, which has to be applied on the EU market. A similar inventory for the EU market is not available at the present time.

2.5 References

2.5.1 Standards

CEN standards

In November 2001, a European 'pre-standard' was published by CEN as ENV 1317-4, which deals with both terminals and transitions (Road restraint systems - Part 4: Performance classes, impact test acceptance criteria and test methods for terminals and transitions of safety barriers). This European Pre-standard (ENV) was approved by CEN on 30 September 2001 as a prospective standard for provisional application. The period of validity of this ENV was initially limited to three years. After two years, the members of CEN were requested to submit their comments, particularly on the question as to whether the ENV could be converted into a European Standard.

Even though many national standards make reference to ENV 1317-4 for the use of terminals in public roads, this 'pre-standard' was never converted into a European Standard and has been removed from the list of published standards in the CEN catalogue.

Two new work items have been established to deal separately with transitions and with terminals, leading to the new draft standards prEN 1317-4 (Road restraint systems - Part 4: Performance classes, impact test acceptance criteria and test methods for transitions of safety barriers and Removable Barrier Section) and prEN 1317-7 (Road restraint systems - Part 7: Performance classes, impact test acceptance criteria and test methods for terminals of safety barriers).

Due to the fact that ENV 1317-4 has never been published as a European Standard, it was not incorporated into the EN 1317-5 standard, which is the basis for the CE marking of road restraint systems. For this reason, terminals cannot be given the CE marking. However, several countries require energy-absorbing terminals installed on public roads to meet ENV 1317-4 requirements.

ENV 1317-4 defines the tests required to classify a terminal in a given 'performance class' (P1 to P4, as shown in Figure 18). However, as mentioned earlier, it also defines different types of tests, depending on whether the terminal is supposed to be installed:

- U (upstream), which is the typical application,
- D (downstream), or
- A (all), which means that the terminal could be hit in both directions, which is typical of medians.

| Performance class | Location | | Tests | | | | | | | | | | | | |
|---|----------|-------------------|-------------------------------------|--------------------|-------------------|-----------------|-------------------------|-----------|----------|----------|------------|------------------|----------|-------------------|--------------|
| | | | Approach | Approach reference | Vehicle mass (kg) | Velocity (km/h) | Test code ¹⁾ | | | | | | | | |
| P1 | A | | head on nose 1/4 offset to roadside | 2 | 900 | 80 | TT 2.1.80 | | | | | | | | |
| P2 | A | U | head on nose 1/4 offset to roadside | 2 | 900 | 80 | TT 2.1.80 | | | | | | | | |
| | | | side, 15° 2/3 L | 4 | 1 300 | 80 | TT 4.2.80 | | | | | | | | |
| P3 | A | U | head on nose 1/4 offset to roadside | 2 | 900 | 100 | TT 2.1.100 | | | | | | | | |
| | | | head-on centre | 1 | 1 300 | 100 | TT 1.2.100 | | | | | | | | |
| | | | side, 15° 2/3 L | 4 | 1 300 | 100 | TT 4.2.100 | | | | | | | | |
| | | D | side, 165° 1/2 L | 5 | 900 | 100 | TT 5.1.100 | | | | | | | | |
| P4 | A | U | head on nose 1/4 offset to roadside | 2 | 900 | 100 | TT 2.1.100 | | | | | | | | |
| | | | head-on centre | 1 | 1 500 | 110 | TT 1.3.110 | | | | | | | | |
| | | | side, 15° 2/3 L | 4 | 1 500 | 110 | TT 4.3.110 | | | | | | | | |
| | | D | side, 165° 1/2 L | 5 | 900 | 100 | TT 5.1.100 | | | | | | | | |
| ¹⁾ Test code notation is as follows: | | | | | | | | | | | | | | | |
| <table style="width: 100%; border: none;"> <tr> <td style="text-align: center;">TT</td> <td style="text-align: center;">1</td> <td style="text-align: center;">2</td> <td style="text-align: center;">100</td> </tr> <tr> <td style="text-align: center;">Test of Terminal</td> <td style="text-align: center;">Approach</td> <td style="text-align: center;">Test vehicle mass</td> <td style="text-align: center;">Impact speed</td> </tr> </table> | | | | | | | | TT | 1 | 2 | 100 | Test of Terminal | Approach | Test vehicle mass | Impact speed |
| TT | 1 | 2 | 100 | | | | | | | | | | | | |
| Test of Terminal | Approach | Test vehicle mass | Impact speed | | | | | | | | | | | | |
| <p>NOTE 1 To avoid ambiguity, the numbering of the approach path in Table 1 and in Figure 3 is the same as in EN 1317-3; approach 3 is present in EN 1317-3 as test 3 for crash cushions, but it is not required for Terminals.</p> <p>NOTE 2 The test with approach 5 is not run for a flared terminal when, at the relevant impact point, the angle (α) of the vehicle path to the traffic face of the terminal is less than 5 °.</p> | | | | | | | | | | | | | | | |

Figure 18: Terminals: vehicle impact test criteria and performance classes according to ENV 1317-4 [13]

Some national standards include provisions for terminals. These standards include:

- Italian Standard [14]: D.M. 2367/2004 containing the 'istruzioni tecniche per la progettazione, l'omologazione e l'impiego dei dispositivi di ritenuta nelle costruzioni stradali' (in Italian)
- German Standard Guidelines for passive protection on roads by vehicle restraint systems – RPS R1 [15]: (in English)
- Austrian Guidelines, RVS 05.02.31; Traffic control, traffic guidance facilities, vehicle restraint systems, requirements and installation [16] (in German).

2.5.2 Design guidelines

Several guidelines are available for safety barriers and their terminations, including, among others:

- AASHTO Roadside Design Guide, Ed 2011, USA [10]
- Department of Infrastructure Energy and Resources: ROAD SAFETY BARRIERS DESIGN GUIDE Part B, Tasmania - Australia [9]

In addition, several states around the world provide drawings of non-proprietary flared terminals:

- Oregon Department of Transportation (USA) [11];
- Missouri Department of Transportation (USA) [19];
- Mainroads West Australia [12].

3 Shoulder rumble strips

3.1 Introduction

Rumble strips are road safety features used to alert road users straying off the road or drifting into the opposing lane of traffic by causing both a vibro-tactile and an audible warning. They are intended to reduce road accidents caused by drowsy or inattentive motorists and can be distinguished in shoulder, centreline, or transverse rumble strips [20]. This report will be dealing with shoulder rumble strips only.

A shoulder rumble strip is a longitudinal design feature installed on a paved roadway shoulder near the outside edge of the travel lane (Figure 19). It is made of a series of indented or raised elements intended to alert inattentive drivers through vibration and sound that their vehicles have left the travel lane [21]. On divided highways, shoulder rumble strips are typically installed on the median side of the roadway as well as on the outside (*right*) shoulder.

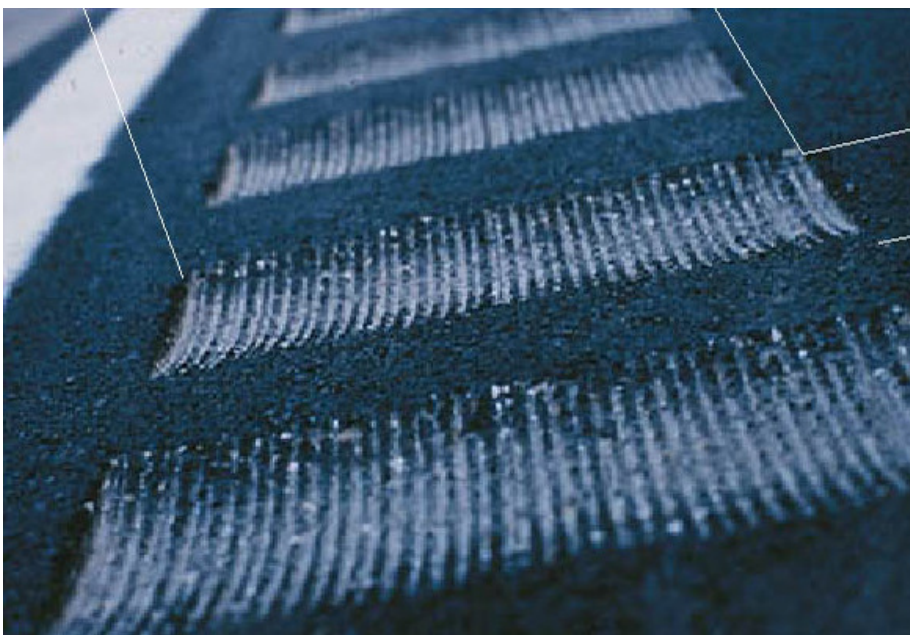

Figure 19: Shoulder rumble strips [24]

Even though the use of rumble strips has been proven to be a low-cost and extremely cost-effective treatment, use of this type of safety feature is still limited, probably due to a lack of practical guidelines and to the perception of potential counter effects such as noise issues, bicycle and motorcycle riding, and maintenance issues. This section of the Forging roadsides design guide seeks to provide practical guidelines on how to properly design shoulder rumble strips to avoid such counter effects and how to evaluate the effectiveness of implementing such an intervention to reduce run-off-road accidents.

3.2 Design criteria

3.2.1 Shoulder rumble strip configuration

In terms of construction techniques, four different types of rumble strip are commonly used: milled-in, rolled-in, formed, and raised. A short description of each rumble strip type is provided hereafter [25]:

- Milled-in (or 'milled'): this design is made by cutting (or grinding) the pavement surface with carbide teeth.
- Rolled-in (or 'rolled'): the rolled-in design is generally installed using a steel wheel roller to which half sections of metal pipe or solid steel bars are welded. The compaction operation presses the shape of the pipe or bar into the hot asphalt shoulder surface.
- Formed: the formed rumble strip is added to a fresh concrete shoulder with a corrugated form, which is pressed onto the surface just after the concrete placement and finishing operations.
- Raised: raised rumble strip designs can be made from a wide variety of products and installed using several methods. The elements may consist of raised pavement markers, a marking tape affixed to the pavement surface, an extruded pavement marking material with raised portions throughout its length or an asphalt material placed as raised bars on the shoulder surface.

The most common shoulder rumble strip types are the milled and rolled types. The difference between the two types is not only the construction method used but also the resulting cross-section and, therefore, the effects on vehicle vibrations, as shown in Figure 20.

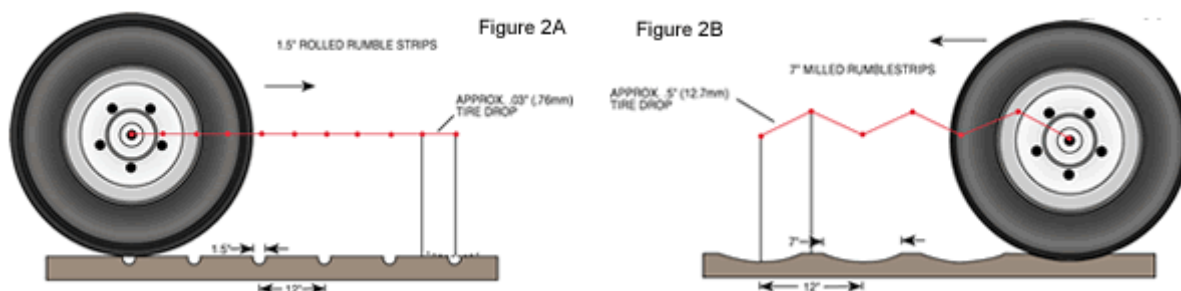

Figure 20: Difference between rolled (*left*) and milled (*right*) shoulder rumble strip cross-sections [24]

The key parameters in the layout design of a shoulder rumble strip are:

- A offset
- B length
- C width
- D depth
- E spacing
- F bicycle gap

as shown in Figure 21.

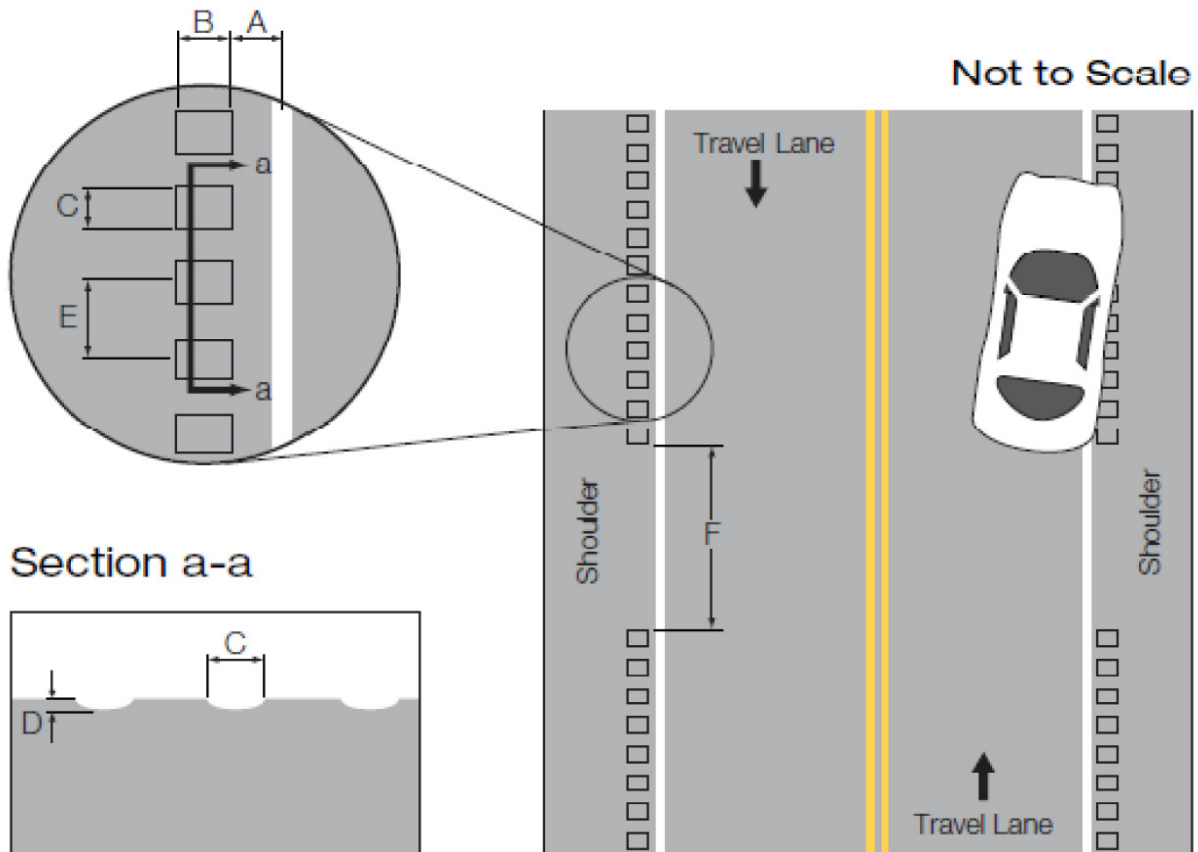

Figure 21: Design parameters for shoulder rumble strips [21]

Table 1 contains the values for 'typical' rumble strip configurations.

Table 1: Typical milled and rolled rumble strip configurations ([21], [22], [23])

| | PARAMETER | MILLED RUMBLE STRIPS | ROLLED RUMBLE STRIPS |
|---|------------------|-----------------------------|-----------------------------|
| A | offset | 0–760 mm | 0–760 mm |
| B | length | 400 mm | 400 mm |
| C | width | 180 mm | 40 mm |
| D | depth | 13 mm | 32 mm |
| E | spacing | 305 mm | 170 mm |

The issue of bicycle gaps will be specifically addressed in chapter 3.2.2.

This same standard for milled rumble strips is adopted as a standard design for motorways in Germany [43] with no gaps except for the acceleration and exit lanes.

NCHRP Report 641 [22] contains conclusive evidence that on rural freeways, rumble strips placed closer to the edge line are more effective in reducing severe single-vehicle run-off-road crashes (fatal and injury crashes). Although similar results have not been found for other roadway types, the best location is still as close as possible to the edge line (unless other constraints require the strips to be moved further into the shoulder) as it widens the recovery zone beyond the strips and provides greater width of the remaining shoulder for bicycle travel.

Although this type of design is extremely effective, it is also quite 'aggressive' because it leads to high noise and vibration inside—and potentially outside—the vehicle and causes considerable disturbance to cyclists.

NCHRP Report 641 contains a different, 'less aggressive' configuration design that reduces the incremental noise generated inside the vehicle from the 10–15 dBA associated with the 'typical' configuration to 6–12 dBA and causes less disturbance to cyclists (Table 2).

Table 2: Milled rumble strip configuration that was designed to be less aggressive ([22])

| | PARAMETER | LESS AGGRESSIVE MILLED RUMBLE STRIPS |
|---|------------------|---|
| A | offset | 0–760 mm |
| B | length | 152 mm |
| C | width | 127 mm |
| D | depth | 10 mm |
| E | spacing | 280–305 mm |

Smaller spacing (280 mm) is recommended for non-freeway facilities with lower operating speeds, close to 72 km/h, while greater spacing (305 mm) is recommended for non-freeway facilities with higher operating speeds, close to 88 km/h [42].

Due to the fact that this solution leads to a reduction in internal noise, a reduction in external noise is also likely. This configuration could therefore be preferable for roads in close proximity to residential areas.

3.2.2 Shoulder rumble strips and cycling

One of the major disadvantages of shoulder rumble strips is the negative effect that they can have on cycling. This issue has been addressed by Moeur [41] and Torbic [42] leading to proposals for designing 'bicycle-friendly' rumble strips.

Moeur focused on the 'bicycle gap' (F in Figure 21) in milled rumble strips. In this type of rumble strip, the bicycle wheel completely drops into the grooves, having a considerable effect on both comfort and handling. Changing the design configuration of the strips has little or no effect. Reducing the groove depth to 10 mm has an effect, albeit a rather limited one that does not allow cyclists to travel over the strips. Moeur suggested therefore that rumble strips on 'non-controlled-access' highways should include periodic gaps of 3.7 m in length and that these gaps should be placed at periodic intervals at a recommended spacing of 12.2 m or 18.3 m. This recommended spacing is not affected by the width of the strips for widths up to 300 mm. Including gaps in the rumble strip pattern would satisfy cyclists' need to cross the rumble strip pattern without causing them to enter the grooved area. In addition, these gaps are long enough to permit a typical cyclist to cross without entering the grooved area, but not long enough to permit a vehicle tyre at a typical run-off-road angle of departure to cross the gap without entering the grooved area.

It should be noted that, according to Moeur, rolled rumble strips do not affect cyclist handling as the wheel doesn't drop into them (Figure 23). However, on the other hand, this solution is much less effective in terms of alerting errant drivers. This solution could, therefore, be considered in areas where considerable bicycle traffic is expected and shoulders are not wide enough to allow for the passage of bicycles between the strips and the pavement edge.



Figure 22: Cycling on 'typical' milled shoulder rumble strips [41]

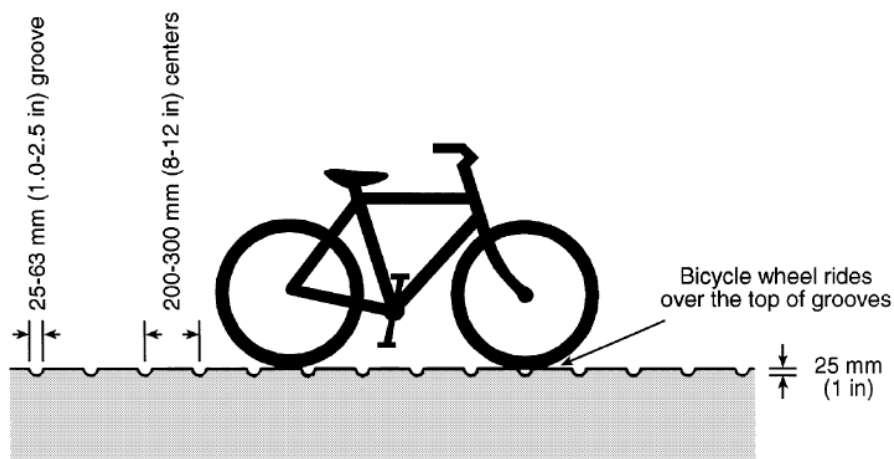

Figure 23: Cycling on rolled shoulder rumble strips [41]

Torbic [42] focused on the geometric parameters of the rumble strips (C, D, E in Figure 21), analysing different patterns by means of numerical simulation (Figure 24) and testing the most promising ones on site. This study led to the definition of the 'less-aggressive' configuration discussed in chapter 3.2.1 and shown in Table 2.

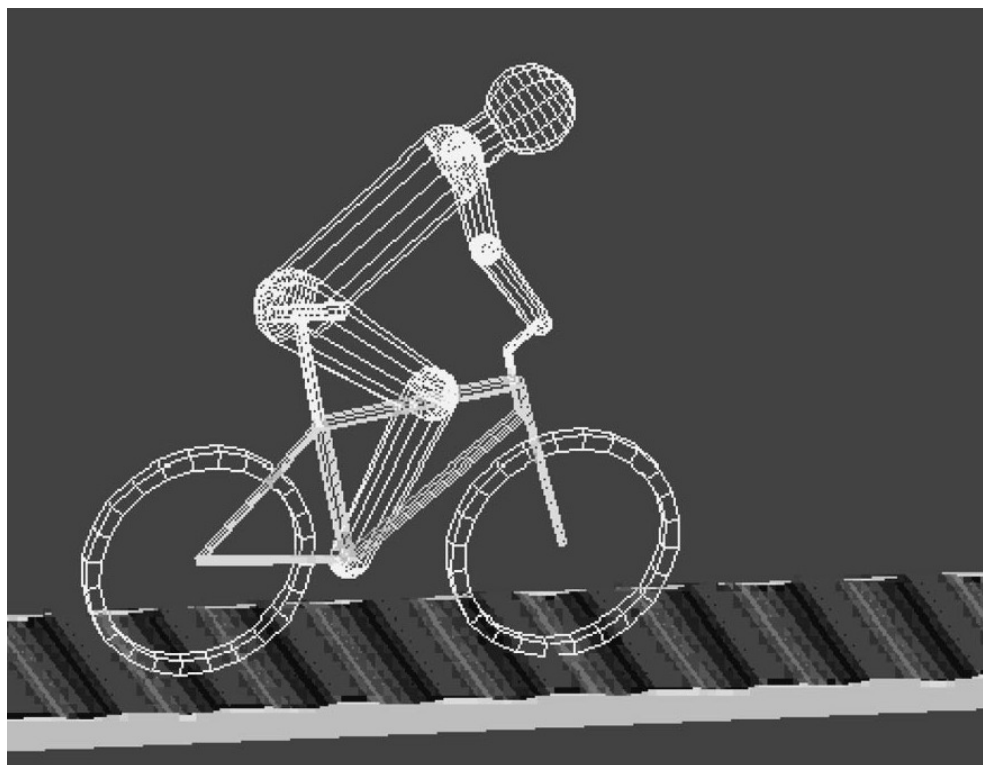

Figure 24: Simulation of a bicycle passing over milled shoulder rumble strips [42]

The US Federal Highway Administration (FHWA) [21] recommends considering possible 'mitigations' to reduce the effect on cycling if the strips are placed along bicycle routes or those with heavy bicycle traffic where less than 1.2 m pavement exists beyond the rumble strip. Mitigation measures include:

- a. use of edge line rumble strips rather than shoulder rumble strips, where it will allow additional shoulder area beyond the rumble strip that is usable to a cyclist;
- b. periodic gaps of 0.9 to 1.1 m between groups of the milled-in elements, spaced at 3.7 to 5.5 m, throughout the length of the shoulder rumble strip;
- c. minor adjustments in design dimensions that have been shown to produce rumble strip designs that are more acceptable to cyclists. The principal adjustments to the milled-in strip elements studied are decreased length transverse to the roadway (B), increased centre-to-centre spacing (E), reduced depth (D), and reduced width longitudinal to the roadway (C).

Mitigation measures 'b' and 'c' are the solutions proposed respectively by Moeur and Torbic, as described above.

3.2.3 Shoulder rumble strips and motorcycling

Even though motorcycling is not permitted on the shoulder, a concern raised when dealing with milled rumble strips is the possible hazard for motorcyclists.

In 2008, a specific study was conducted in Minnesota [44], where centreline rumble strips (which are much more likely to affect the motorcyclists' safety than shoulder rumble strips) have been installed on rural highways since 1999, to look for possible detrimental effects on two- and three-wheeled motorcycles. There were 29 motorcycle accidents on rural highways with centreline rumble strips; rumble strips were not a concurrent factor in any of them.

In addition to the analysis of the accidents, 40 hours of on-site observations were made. The study concluded that there were no visible indications of motorcyclist correction or overcorrection, nor were there any obstacles to passing due to the rumble strips in the centreline. Controlled conditions on a closed circuit supported this observation through 32 motorcyclists on all types of motorcycles and experience levels ranging from 0 to 41 years of motorcycling on streets. Interviews confirmed that the riders had no difficulty or concern with the rumble strips.

In Alaska [45], the depth of the centreline rumble strips has been reduced to 3/8" (approximately 10 mm) in order to reduce the impact on motorcyclists and other users, while still providing a warning to drivers. This type of configuration is consistent with the 'less aggressive' design described in chapter 3.2.1, suggesting that this configuration is preferable in areas where high motorcycle traffic is expected.

3.2.4 Noise issues

The noise disturbance for nearby residents is often considered a limiting factor for the practical applicability of rumble strips. Even though shoulder rumble strips should only be traversed when a driver leaves the roadway, rumble strip installations may still produce noise complaints where there are nearby residences, depending on the type of vehicles, lane width and curvature, and the type of manoeuvres that occur on the road ([21]).

Mitigation measures may include:

- increasing the offset (A), particularly through curves where off-tracking is prevalent or in corridors with high volumes of truck traffic;
- removal of the rumble strips in the vicinity of turn lanes or in spot locations such as a single house along a segment of roadway. The need to discontinue the use of rumbles in spot locations should not necessarily prevent their use along a segment or corridor.

According to Torbic [22], shoulder rumble strips should be interrupted 200 m before the road passes a residential area. In close proximity to residential areas or where the reduction of generated noise is an issue, the 'less aggressive' design configuration (see chapter 3.2.1) could be used, as this results in less disturbance.

Kragh [26] analysed the effects of the shape of the strip on noise and concluded that rumble strips of a sinusoidal shape lead to an increase of only 0.5–1 dB compared with old stone mastic asphalt (at 25 m from the road). The typical rumble strip with 'cylinder-segment' indentations results in an increase of 2–3 dB. Rectangular indentations generate significantly higher noise levels than both rumble strips with a sinusoidal profile (3–7 dB higher) and 'cylinder segment' strip (2–5 dB higher).

3.2.5 Maintenance of shoulder rumble strips

The CEDR Report 'Best Practice for Cost-Effective Road Safety Infrastructure Investments' [20] states that rumble strips are characterised by low installation costs and require little or no maintenance. There is no noticeable degradation of the pavement as a result of rumble strips. Moreover, they are effective in snow and icy conditions and may act as a guide for truck drivers in inclement weather.

The 2011 Technical Advisory released by the FHWA [21] confirmed that concerns relating to accelerated pavement deterioration due to the installation of rumble strips appear to be unfounded. To reduce pavement deterioration due to traffic travelling over them, it is suggested that the rumble strips be located at least a few inches from joints. In those cases where there are deterioration concerns, an asphalt fog seal can be placed over milled-in strips to preserve them from oxidation and moisture.

Recent experience in Michigan has shown that shoulder preventative maintenance treatments, such as chip seal on top of an existing rumble strip, have been shown to retain the basic shape of the strips, although losing some cross-section. However, stones from the chip seal enhance the noise and vibratory properties of the rumble strip. Micro-surface and ultra-thin hot-mix asphalt overlays fill in existing lines of rumble strips, but a fresh line of rumble strips can be cut into the overlay at the same location without significant delaminating caused by the underlying filled-in rumbles.

If an overlay has to be placed over a shoulder where rumbles strips have been either milled or rolled, the surface has to be prepared prior to overlaying the shoulder. Based on an observational study, it is recommended that areas with rumble strips be prepared prior to overlaying either by:

- milling, inlaying, and overlaying or
- simply milling and overlaying.

Other preparation approaches such as shim and overlay or simply overlay will likely result in some degree of reflection in the area of the former rumble strips ([22]).

3.2.6 Selection of sites where shoulder strips should be installed

According to the FHWA Technical Memorandum – ACTION: Consideration and implementation of proven safety countermeasures [36]: 'Rumble Strips or Rumble Stripes should be provided on all new rural freeways and on all new rural two-lane highways with travel speeds of 50 mph or greater. In addition, State 3R (Resurfacing, Restoration, Rehabilitation) and 4R (Resurfacing, Restoration, Rehabilitation, Reconstruction) policies should consider installation of continuous shoulder rumble strips on all rural freeways and on all rural two-lane highways with travel speeds of 50 mph or above (or as agreed to by the Division and the State) and/or a history of roadway departure crashes, where the remaining shoulder width beyond the rumble strip will be 4 feet or greater, paved or unpaved. Federal and local agencies and tribal governments administering highway projects using Federal funds should also be encouraged to adopt similar policies for providing rumble strips or rumble strips'.

NCHRP Report 641 [22] provides a detailed set of guidelines for establishing where shoulder rumble strips can effectively be placed:

- *Shoulder width*: minimum shoulder widths for rumble strip application range from 2 to 10 ft (0.6 to 3.0 m), with 4 ft (1.2 m) being the most common value. Minimum shoulder widths may differ according to roadway type.
- *Lateral clearance*: minimum lateral clearances range from 2 to 7 ft (0.6 to 2.1 m), with 4 ft (1.2 m) and 6 ft (1.8 m) being the most common values. Some agencies may prefer to define the lateral clearance to be the distance from the outside (i.e. right-hand) edge of the rumble strip to the outside edge of the shoulder, while others may measure the clearance to the nearest roadside object rather than the outside edge of the shoulder.

- *ADT (Average Daily Traffic)*: Minimum ADTs for rumble strip application range from 400 to 3,000 vehicles, but in most cases fall between 1,500 and 3,000 vehicles.
- *Bicycles*: agencies address bicycle considerations in several ways, including: (a) not installing rumble strips on roads with significant bicycle traffic or if the roadway is a designated bicycle route, (b) adjusting the dimensions of the rumble strips, (c) adjusting the placement of the rumble strips, (d) adjusting the minimum shoulder width and/or lateral clearance requirements, and/or (e) providing gaps in periodic cycles. Guidance provided in the AASHTO Guide for the Development of Bicycle Facilities should also be considered.
- *Pavement type*: some agencies only install shoulder rumble strips on asphalt surfaces. The use on non-conventional asphalt pavements (such as porous wearing courses) should be investigated by means of trial sections.
- *Pavement depth*: minimum pavement depths range from 1 to 6 in. (25 to 152 mm).
- *Area type*: some agencies only install shoulder rumble strips in rural areas, primarily due to potential noise disturbance. The recommended distance from the residential area where rumble strips should be terminated is 200 m.
- *Speed limit*: minimum speed limits used by agencies ranged from 45 to 50 mph (72 to 80 km/h). Some agencies also adjust the rumble strip dimensions depending upon the speed limit.
- *Crash frequencies/rates*: some agencies establish a threshold value, such as the state-wide average for the given roadway type.

Shoulder rumble strips are typically interrupted in the following locations:

- intersections, driveways, and turn lanes;
- entrance and exit ramps;
- structures (i.e. bridges);
- areas where the lateral clearance drops below a specified value and/or areas where the lateral clearance is limited due to adjacent guardrail, curb, or other obstacles;
- residential areas;
- catch basins and drainage grates;
- pavement joints;
- median crossings.

In British Columbia (Canada, [27]) too, it is recommended not to use shoulder rumble strips in 'urban areas'. A good indication of an urban highway section is defined as follows:

- speed zone of 70 km/h or less in the vicinity of a settlement;
- highway section with curb-and-gutter or a sidewalk;
- the spacing between driveways and intersections is less than 150 metres.

3.3 Assessment of effectiveness

The first effectiveness evaluation studies on shoulder rumble strips date back to the early 1990s. All these studies concluded that this treatment is extremely cost effective in reducing single-vehicle run-off-road accidents on freeways (dual carriageway highways with no at grade intersections).

- In 1994, Wood [28] reported a 70% reduction in single-vehicle run-off-road accidents by implementing milled-in rumble strips on the Pennsylvania Turnpike.
- In 1997, Hickey [29] updated Wood's results on the effects of shoulder rumble strips on the Pennsylvania Turnpike, still confirming a reduction in single-vehicle run-off-road accidents by 60% over 53 test segments;
- In 1998, Perillo [30] reported a reduction in single-vehicle run-off-road accidents of up to 88% after the installation of milled-in shoulder rumble strips on the New York Thruway.

It should be noted, however, that the above-mentioned studies are all very simple and straightforward comparisons between the accidents that occurred before and after the rumble strip installation without a sound statistical interpretation of the data (so-called 'naïve' before/after studies).

In 1999, Griffith conducted a more rigorous study on rolled-in rumble strips ([31], [32]) associated to a 'medium-high' level of predictive certainty according to the NCHRP Project 17-25 classification [33], where the potential reduction in single-vehicle run-off-road accidents was estimated at 14% considering all freeways (rural and urban) and 21% considering only rural freeways. Even though these expected reductions in accidents are much smaller than the ones estimated in the late 1990s, they are still extremely valid, considering the limited cost of the intervention. As noted in [33], these results are not applicable to other road classes (two-lane or multi-lane rural highways). Similar results were obtained—once again for freeway segments—by Carrasco [34], showing that the late 1990s indications on the effectiveness of shoulder rumble strips on accident reduction were overestimated, still having an actual reduction of single-vehicle run-off-road accidents of 22%.

More recently, Patel et al. [35] analysed the effect of this treatment on two-lane rural roads and found out that there is still a considerable safety effect with a reduction in single-vehicle run-off-road accident of 13%, when all accidents are considered and 18% when considering only injury accidents. It was noted, however, that not all sites experience a crash reduction and the resulting standard deviation of the expected crash reduction is 8% for total accidents and 12% for injury accidents. This means that, considering a 95% confidence interval, the effectiveness in terms of crash reduction can range from 13-13.2% and 13+13.2% for all accidents and 18-19.6% and 18+19.6% for injury accidents.¹

¹ In the cited paper by Patel et al, the confidence interval is actually different and not consistent with the standard deviation given in the same paper. This seems to be a typing mistake.

As shown, a 'negative crash reduction' (which means a crash increase) can occur within the 95% confidence interval. According to Patel et al., an in-depth study with a larger database should be conducted to find out the explanatory variables that lead to such a different performance in different sites (e.g. road geometry, different type of accidents, etc.).

In 2008, the FHWA issued the 'Memorandum' – ACTION: Consideration and implementation of proven safety countermeasures [36], stating that continuous shoulder rumble strips (CSRS) can be applied on many miles of rural roads in a cost-effective manner and that studies have documented the following crash reduction benefits:

- overall crash reduction of 13% and injury reduction of 18% on rural two-lane highways;
- overall crash reduction of 16% and injury reduction of 17% on rural multi-lane divided highways.
- reduction in run-off-road crashes of 38% on freeways.

Combining the results from different studies (including [32] and [35]) in a manner consistent with the procedures for combining study results for incorporation in the Highway Safety Manual [37], Torbic et al. [38] have recently recommended a set of CMF (named AMF in the study according to the previously used acronym) to be applied to single-vehicle run-off-road crashes (SVROR) to account for shoulder rumble strips on rural freeways and rural two-lane roads, shown in

Figure 25. A different CMF is given for total SVROR accidents and for fatal and injury crashes only (SVROR FI).

| Treatment | Roadway Type | Accident Type and Severity | AMF ^a | SE ^b |
|-------------------------------------|----------------------|----------------------------|------------------|-----------------|
| Shoulder rumble strips ^c | Rural freeways | SVROR | 0.89 | 0.1 |
| | | SVROR FI | 0.84 | 0.1 |
| Shoulder rumble strips ^d | Rural two-lane roads | SVROR | 0.85 | 0.1 |
| | | SVROR FI | 0.71 | 0.1 |

^aAMF = accident modification factor.

^bSE = standard error of estimate.

^cAMF and SE based on combined results for rolled SRS from Griffith (4) and for milled SRS from this research.

^dAMF and SE based on combined results from Patel et al. (5) and this research.

Figure 25: Crash Modification Factors (AMF/CMF) for shoulder rumble strips recommended for inclusion in the Highway Safety Manual by Torbic et al. [38]

These values are statistically more reliable than the ones given in the FHWA memorandum ([36]), which seem overestimated. The values proposed by Torbic are, therefore, recommended for the evaluation of the effectiveness of shoulder rumble strips on rural freeways and rural two-lane roads.

For urban freeways and multi-lane divided highways, the analysis conducted by Torbic et al. proved to be statistically non-significant as in previous studies. For multi-lane divided highways, the values proposed by Carrasco [34] can be used as a best estimate of the effects of milled shoulder rumble strips: Carrasco expects that SVROR crashes would be reduced by 22% and SVROR FI crashes by 51%, but more statistically sound research is needed.

The RISER Guidelines [1] point out that according to a number of reports based on in-depth investigations of accidents, the human factor (mainly alcohol, fatigue, and distraction) prevails in accidents where the vehicle left the road at a low run-off angle but was still controllable. RISER's detailed data shows that inappropriate speed or speeding is not the main factor involved in accidents. A considerable number of accidents (56 cases out of 189) were accidents that could be positively affected by having shoulder rumble strips installed (heavy workload, panic, internal or external distraction, and above all fatigue).

Another important effect of shoulder rumble strips is the reduction in crash severity. The 2011 FHWA Technical Advisory [21] indicated that, in a study of 1,800 run-off-road freeway crashes, one state found that drift-off-road crashes (due to inattentive driving) resulted in death or serious injury at a rate three to five times that of other categories of run-off-road crashes.

In 2005, an extensive driving simulator study was conducted in Sweden [39] in order to investigate the effects on fatigued drivers of shoulder and centreline rumble strips on narrow roads (≤ 9 m). This study showed that all the different types of rumble strips considered and all the different placements were effective in alerting drivers and also induced the correct averting action. Based on the responses of the drivers, no risk was associated with more 'aggressive' rumble strips.

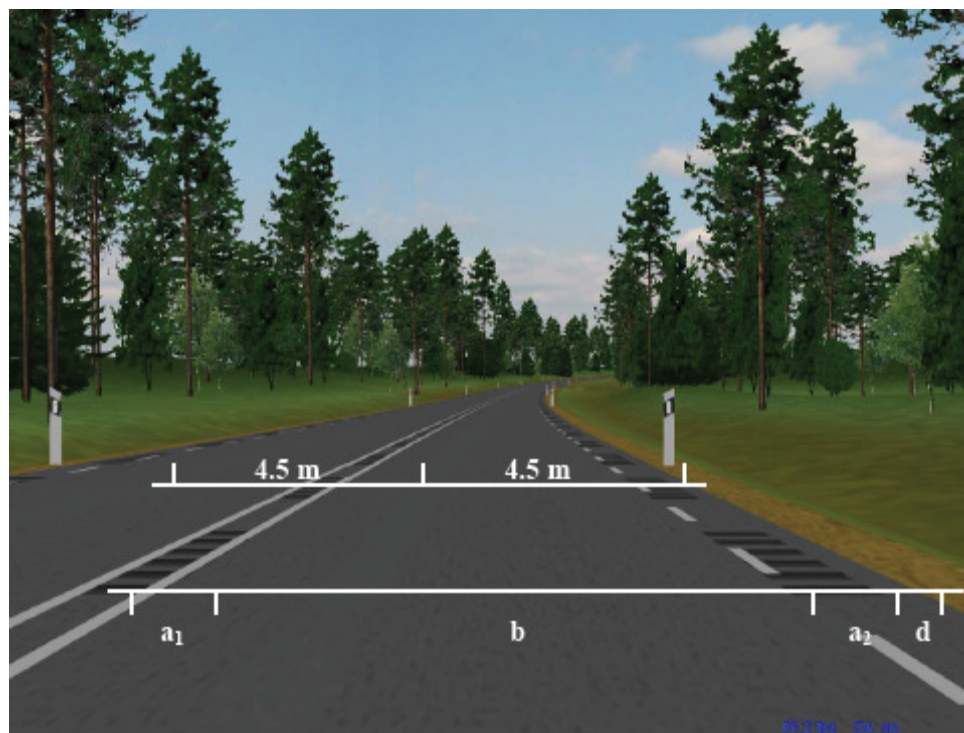

Figure 26: Layout used for the simulator evaluation in [39]

Rumble strips are also identified as a potential safety intervention for single-vehicle accidents by the PIARC Road Safety Manual [40] even though there is no specific quantification of the potential accident reduction that could be expected.

3.4 Case studies/examples

Shoulder rumble strips represent a widely used technique worldwide even though the applications in Europe are still limited compared with the US and Australia.

Sweden is one of the countries in Europe where milled shoulder rumble strips (also called 'grooved' rumble strips) are extensively used on freeways. This is why a specific study was conducted to evaluate the effectiveness of such treatments (see [2] for a detailed description of the study). The configuration of the rumble strips is essentially the 'typical' one described in chapter 3.2.1 with a bicycle gap of 2,870 mm (Figure 27).

The results of the analyses conducted on 200 km of treated sections confirm that this type of intervention definitely reduces crashes by an estimated 27.3%. Within a 95% confidence interval, the potential effect was estimated at being between 8.6% and 45.7%, which is still quite a large spread, meaning that the analysis should be enlarged to a wider dataset. However, on the other hand, no 'essential reversal effect' was found, which means that within a 95% confidence interval, the treatment will not have a negative effect (increase) on crashes.

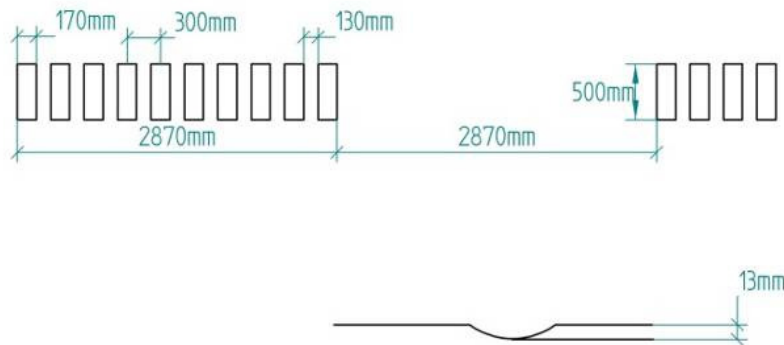

Figure 27. Configuration of the milled shoulder rumble strips in Sweden

An extensive case study on the use of rumble strips on motorways has been conducted in Germany [43], showing that shoulder rumble strips have a positive effect on fatal crashes and crashes with severe personal injury (-15%) while injuries with light injuries or property damage only crashes increase (+6%). The conclusion of this study was that the primary effect of the rumble strips is not the reduction in the total number of crashes (which was essentially stable with a -1% variation) but the reduction in crash severity.

Another interesting result was that SVROR accidents leaving the right-hand edge of the road were reduced by a considerable 43% (-18% to -60% in a 95% confidence interval). However, it also noted an increase in crashes where the vehicle leaves the carriageway to the left due to overcorrection.

On the Rome Beltway in Italy, raised rumble strips have recently been installed in combination with coloured surfacing to prevent the use of the extra widening of the left-hand shoulder that has been left for sight distance issues.



Figure 28: Raised rumble strips used in the left-hand shoulder on the Rome Beltway.

3.5 References

The Federal Highway Administration (FHWA) has set up a dedicated website (http://safety.fhwa.dot.gov/roadway_dept/pavement/rumble_strips) where several good references on shoulder rumble strips can be found.

There is no one national design standard that can be considered as a reference. It should be mentioned, however, that the Austrian standard RVS 09.01.25 (tunnel safety in Austria) refers to rumble strips on edge marking as a treatment to improve safety beginning 100 m ahead of the tunnel entrance.

4 Forging support structures for road equipment

4.1 Introduction

Single or point objects placed within the clear zone can represent a hazard for a vehicle that is out of control and leaves the carriageway. As part of the RISER project [1], several studies were reviewed. This review showed that collisions with point objects represent a considerable percentage of crashes (e.g. 24% of fatal accidents in Finland, 31% of fatal accidents in France, and 42% of road deaths in Germany). These point objects can be either natural or artificial, human-made structures made of different materials. This section of the report will provide guidance on designing safer support structures for road equipment, including utility poles and sign and lighting posts support. Protection of natural obstacles such as trees is not addressed in this guide.

The results of an extensive literature review of the studies dealing with the evaluation of the potential effects on the safety of obstacles are presented in Annex A. The RISER project showed that trees are the most dangerous roadside objects. Around 17% of all tree accidents recorded were fatal [1]. In the case studies in this investigation, where speed data was known, all fatal accidents involved impact speeds of 70 km/h or more. Structures such as signs, concrete walls, fences, etc. are hit in 11% of all fatal single-vehicle accidents (SVA). According to the RISER accident analysis, safety barriers appear to be the most frequently impacted object in SVAs. However, safety barrier SVAs generally resulted in minor injuries. It should be noted, however, that safety barriers themselves can pose a hazard if not properly designed and installed.

The study in [46] is based on the U.S. Department of Transportation's Fatality Analysis Reporting System (FARS). It shows the results of an analysis of fatal accidents caused by striking fixed objects. In total, 8,623 fatalities were analysed. Figure 29 shows the distribution of fixed object crash deaths in 2008. It clearly shows the high percentage of tree-related accident deaths (48%). Utility poles and traffic barriers were the next most frequent objects struck with impacts against utility poles responsible for 12% of fatalities.

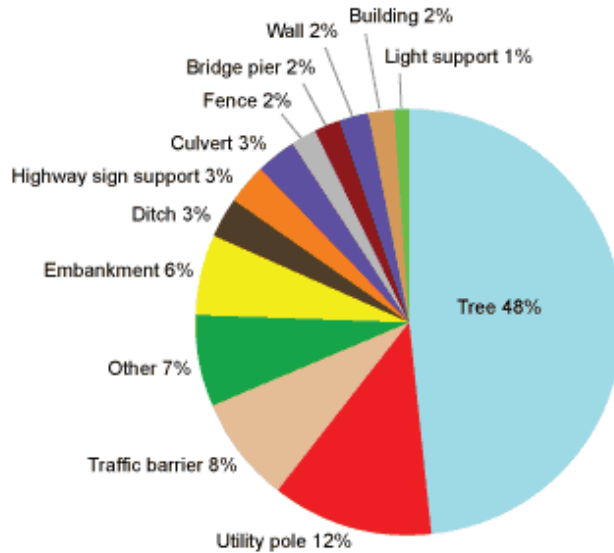

Figure 29: Percentage distribution of fixed object crash deaths, based on 8,623 fatalities, 2008 [46]

In many crashes, the vehicle hit more than one roadside object. A study published by the Roads and Traffic Authority of New South Wales in Australia [47] examined the specific types of roadside objects that were hit by vehicles in second impacts. The analysis only contained fatal accidents and indicates once again that trees are the most frequently struck roadside objects, followed by utility poles and embankments. Trees and utility poles were the most frequently hit objects hit in both first and second impacts (see Figure 30).

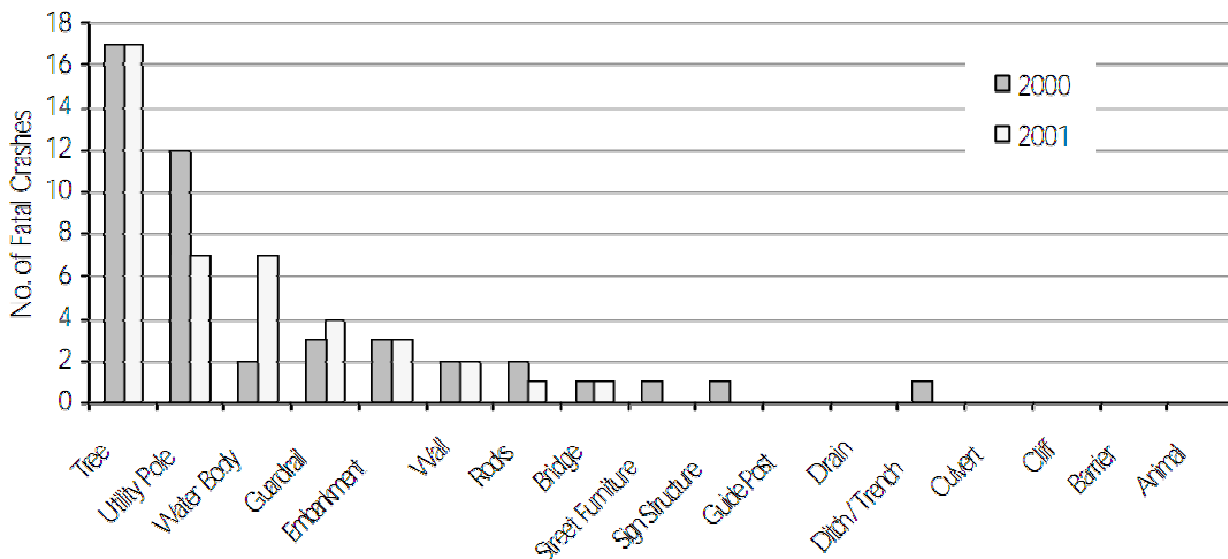

Figure 30: Roadside objects hit in second impact, based on 1,029 fatal accidents, NSW 2000 & 2001 [47]

Because of the structural strength of the utility poles and other support structures, combined with the small contact area between the vehicle and these structures, these crashes tend to be severe (Figure 31) as shown also in Figure 32, where almost 40% of the collisions with poles were fatal or involved some level of injury [49].



Figure 31: Collision with a lighting column: 2 fatalities [48]

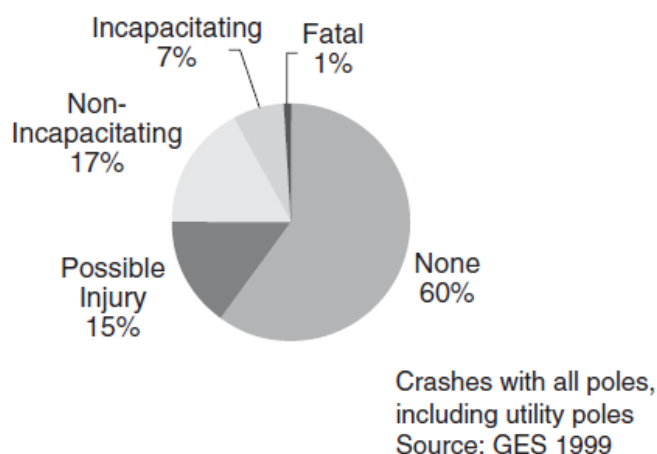

Figure 32: Severity distribution of accidents involving collisions with poles [49]

4.2 Design criteria

Designers and road managers frequently say that obstacles on the roadside *need* to be protected with safety barriers. This is a simplistic approach that should be overcome to reach a forgiving roadsides design approach, because placing a barrier (with its Length of Need and its terminals) is not necessarily the most 'forgiving' solution.

What's more, it can be extremely costly in relation to the benefits achieved. As shown in the RISER project [1], the selection of the proper protection to be considered when an obstacle is located in the vicinity of the roadway is a complete process where the placement of a safety barrier (hazard protection) is only the very last option (Figure 33).

Once the specific obstacle is identified as a potential problem, the distance between the obstacle and the carriageway has to be compared with the clear zone (called a 'safety zone' in Figure 33) required for the specific road configuration, design speed, and traffic. If the obstacle is outside the clear zone, it is not considered a hazard. The criteria for defining the clear zone are addressed in Annex A.

If the object is located within the clear zone, it could be a hazard. Whether it is a hazard or not depends on several factors.

Generally speaking, an object in the clear zone can be considered a hazard if one or more of the following events occur [3]:

- the vehicle is abruptly stopped,
- the passenger compartment is penetrated by an external object, or
- the vehicle becomes unstable due to roadside elements.

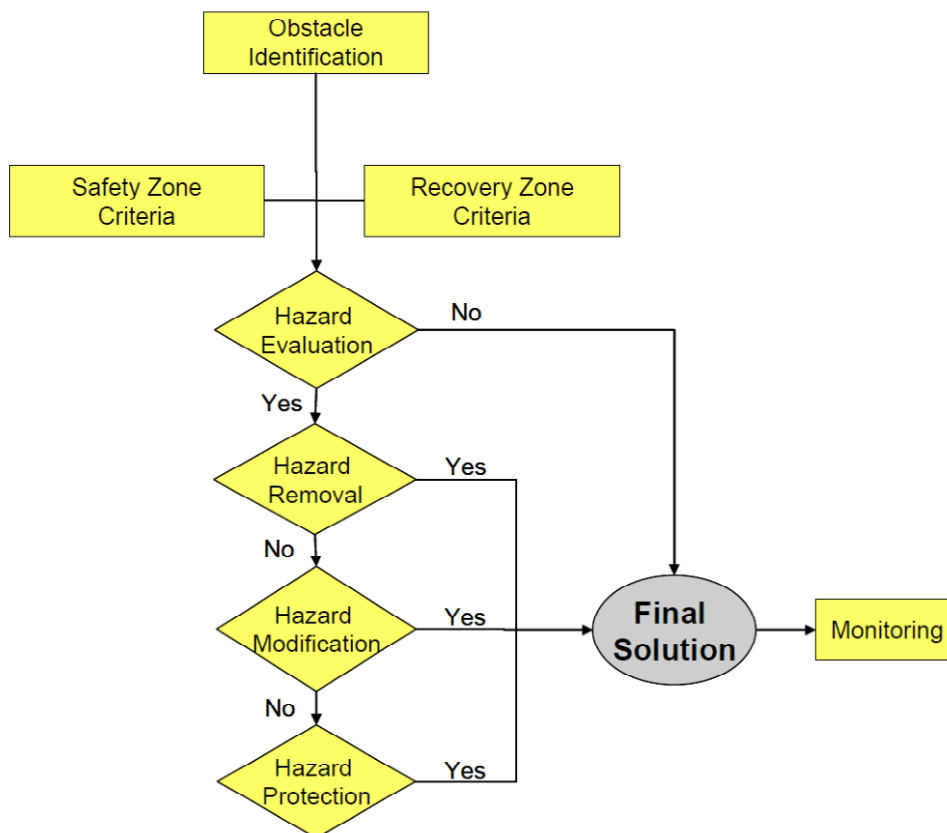

Figure 33: Procedure for handling lateral obstacles in accordance with [49]

According to both the RISER [1] and SETRA [48] Guidelines, an obstacle is not to be considered a hazard if it has been positively tested in accordance with the EN 12767 standard 'Passive safety of support structures for road equipment – Requirements, classification and test methods' [50].

For all other obstacles, the following criteria can be found in the literature:

- according to [52], an obstacle is to be considered a hazard if it has a diameter or thickness greater than 100 mm;
- according to the RISER Guidelines [1], obstacles are considered a hazard or not depending on the combination of diameter and impact speed, as shown in Figure 34;
- according to the SETRA Guidelines [48], obstacles are considered a hazard if the resistant moment at the base exceeds 5.7 kN*m.

According to all European guidelines and standards on handling lateral obstacles (including the RISER and SETRA guidelines and the Danish Standards [53], and almost all of the national standards that have adopted EN 12767²), the support is not considered a 'hazard' if it has been positively tested in accordance with the EN 12767 standard. It should be noted, however, that the EN 12767 standard considers three categories of passive safety support structures:

- high-energy-absorbing (HE);
- low-energy-absorbing (LE);
- non-energy-absorbing (NE).

² It should be noted that some EU countries, such as Italy, have not yet adopted EN12767 as a mandatory standard for acceptance of road equipment support structures.

| Hazard | Diameter [m] | Dangerous impact speed [km/h] | Additional comments |
|---|--------------|-------------------------------|---|
| Trees and tree stumps | >0.2 | 40 | Typically >0.1 in many national guidelines |
| The following poles/posts ² | | | |
| - Utility poles - Standard lighting poles (wood, metal and concrete) | >0.2 | 40 | |
| - Posts of roadside signs | >0.1 | 40 | |
| - Gantry/large traffic signs - Supports/CCTV masts/High mast lighting columns - Supports/other high mast posts/poles. | >0.1 | 40 | |
| Rocks and boulders | - | - | |
| Bridge piers/pillars/abutments | | 50 | |
| Culvert ends/ headwalls/drainage pipes | | - | |
| Underpasses and other point hazards (rivers, railway) | | - | Including those at the foot of an embankment |
| Safety barrier terminations | | - | Blunt barrier terminations and ramped ends which do not bend towards the roadside (see Chapter 4) |

¹ Does not include 'passively safe' posts and poles.

Figure 34: Definition of hazards for single point obstacles in the clear zone according to [49]

Energy-absorbing support structures slow down the vehicle considerably, thereby reducing the risk of secondary accidents with structures, trees, pedestrians, and other road users. Non-energy-absorbing support structures permit the vehicle to continue after the impact with a limited reduction in speed. Non-energy-absorbing support structures may provide a lower primary injury risk than energy-absorbing support structures.

In addition, EN 12767 defines four levels of occupant safety based on the values of Acceleration Severity Index (ASI) and Theoretical Head Impact Velocity (THIV) calculated for tests at different speeds. Levels 1, 2, and 3 provide increasing levels of safety in that order by reducing impact severity. For these levels, two tests are required:

- a test at 35 km/h to ensure satisfactory functioning of the support structure at low speed;
- a test at the class impact speed (50, 70, and 100 km/h) as given in the table shown in Figure 35.

Level 4 comprises very safe support structures classified by means of a simplified test at the class impact speed.

To control road user or vehicle occupant risk, the test item or detached elements, fragments, or other major debris from the test item must not penetrate the occupant compartment. The windscreen may be fractured, but may not be penetrated. The vehicle must remain upright for no less than 12 m beyond the impact point with a roll angle less than 45 ° and a pitch angle less than 45 °.

All the tests use a light vehicle to verify that impact severity levels have been satisfactorily attained and are compatible with safety for occupants of a light vehicle.

| Energy absorption categories | Occupant safety level | Speeds | | | |
|------------------------------|-----------------------|---|----------------|--|-----------|
| | | Mandatory low speed impact test 35 km/h | | Speed class impact tests 50 km/h, 70 km/h and 100 km/h | |
| | | Maximum values | | Maximum values | |
| | | ASI | THIV km/h | ASI | THIV km/h |
| HE | 1 | 1,0 | 27 | 1,4 | 44 |
| HE | 2 | 1,0 | 27 | 1,2 | 33 |
| HE | 3 | 1,0 | 27 | 1,0 | 27 |
| LE | 1 | 1,0 | 27 | 1,4 | 44 |
| LE | 2 | 1,0 | 27 | 1,2 | 33 |
| LE | 3 | 1,0 | 27 | 1,0 | 27 |
| NE | 1 | 1,0 | 27 | 1,2 | 33 |
| NE | 2 | 1,0 | 27 | 1,0 | 27 |
| NE | 3 | 0,6 | 11 | 0,6 | 11 |
| NE | 4 | No requirement | No requirement | See 5.6 | |

Figure 35: Passively safe support structures performance classes according to EN 12767 [50]

This means that the structures tested in accordance with EN 12767 are not all equivalent and that criteria need to be provided for the selection of the proper performance class.

EN 12767 itself states that different occupant safety levels and energy absorption categories will enable national and local road authorities to specify the performance level of an item of road equipment support structures in terms of the effect on occupants of a vehicle impacting with the structure. Factors to be taken into consideration include:

- the perceived injury accident risk and probable cost benefit;
- the type of road and its geometrical layout;
- typical vehicle speeds at the location;
- the presence of other structures, trees, and pedestrians;
- the presence of vehicle restraint systems.

Guidelines for selecting the most appropriate performance class of support structures in accordance with EN 12767 are given mostly in northern European countries (Norway, Finland [54], [55]) where this type of roadside support has been in place for several years.

In the UK, a specific National Annex to EN 12767 [51] has recently been issued to provide guidelines for the implementation of 'passively safe' support structures in the UK. A synthesis of this National Annex is provided in a very comprehensive technical report issued by TRL in 2008 [56]. The guidelines for the selection of the most appropriate performance class according to EN 12767 in different situations are given in

Figure 36.

| Situation | Location | Type of support structure | | |
|---|--|--------------------------------|------------------------|--------------------------------|
| | | Lighting column | Sign or signal support | Non-harmful support structures |
| Non-built up all-purpose roads and motorways with speed limits > 40 mph | Generally in verges of motorways, dual carriageways and single carriageway roads | 100:NE:1-3 | 100:NE:1-3 | 100:NE:4 |
| | With significant volume of non-motorised users | 100:LE:1-3 or 100:HE:1-3 | 100:LE:1-3 | 100:NE:4 |
| | Where major risk of items falling on other carriageways | 100:LE:1-3 or 100:HE:1-3 | 100:LE:1-3 | 100:NE:4 or 70:NE:4 |
| Built up roads and other roads with speed limits ≤40 mph | All locations | 70:LE:1-3 or 70:HE:1-3 | 70:LE:1-3 | 100:NE:4 or 70:NE:4 |

Figure 36: Guidance for the selection of passively safe support structures performance classes according to EN 12767 given by UK National Annex [56]

The UK National Annex also gives advice regarding:

- roof deformation,
- structural requirements,
- traffic signpost spacing and recommendations,
- sign plate recommendations,
- gantry sign supports,
- foundations, and
- underground electrical connections.

In terms of construction techniques, there are several strategies to make poles or posts 'forgiving' and compliant with EN 12767 (see Annex A):

- *Material use*: the most obvious way to increase energy absorbance is to use materials with low stiffness. Wooden poles or posts should, therefore, be avoided. A good compromise between energy absorbance and safety are poles made of fibreglass that absorb the energy over its entire length. The pole cracks without having a predetermined breaking point.
- *Splicing*: if the predetermined breaking points are not correctly located in the pole or post this can result in vehicle snagging and flying parts. In order to achieve a safe breakaway, splices should be kept close to the ground. According to [3], multiple splices should be avoided. An example is given in Figure 37.



Figure 37: Breakaway/spliced pole (*left*) and slip base (*right*) [57]

- *Slip-base poles*: A characteristic of slip base poles is that when impacted at normal operating traffic speeds, they are generally dislodged from their original position (see Figure 38). It enables the pole to slip at the base and fall if a collision occurs.

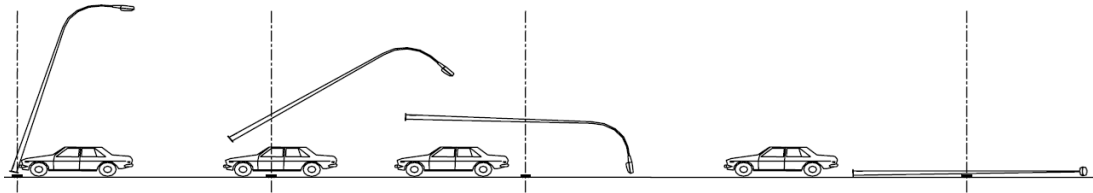

Figure 38: A vehicle impacting on a slip base pole [57]

- **Breakaway transformer base:** a transformer base, commonly made of cast aluminium, is bolted to a concrete foundation. The bottom flange of the pole is bolted to the top of the transformer base. The aluminium is heat-treated to make it 'frangible', so that the pole can break away from the base when struck by a vehicle.
- **Breakaway connectors:** when breakaway poles are used, the electrical conductors must also be breakaway. This is accomplished by using special pull-apart fuse holders (breakaway connectors). In the case of breakaway poles, the neutral must also have this breakaway connector but should be unfused. Breakaway connectors are fused or unfused connectors in the base of poles.

4.3 Assessment of effectiveness

Even though this type of structure has been in place for several years in several countries, including most of the northern European counties (Norway, Finland, Sweden, and Iceland), sound statistical analyses of the effectiveness of using 'passively safe' support structures in reducing the severity of crashes were not found.

The website of one passive safety support manufacturer ([58]) refers to 170 accidents involving EN 12767-tested structures, but provides no details of the consequences of such events. The pictures shown on the website (Figure 39) highlight the performance of the support structures when hit by a passenger car. The structure remains stable with the passenger car going through it, potentially with minor damage.



Figure 39: A 'passively safe' sign support after being hit by a passenger car [58]

According to [49], field data from Massachusetts (five crashes) indicate that in the limited number of applications that exist, there have been no serious injuries from crashes involving a specific type of passively safe utility pole. Texas reported one crash involving this type of utility pole. This crash did not involve a serious injury, although erosion did reduce the pole's effectiveness.

A risk assessment of the potential effect of using passively safe lighting columns and signposts has been performed in [56] by combining the likelihood of occurrence of different events that can lead to passenger injuries.

Figure 40 shows the results obtained in terms of risk assessment for different lighting column options on rural single lane carriageway roads where the conventional solution is compared with the traditional solution of protecting the column with safety barriers and with the option of using a 'passively safe' column. The risk associated with the use of 'passively safe' or 'forgiving' lighting columns resulted in a risk almost eight times lower than that associated with conventional unprotected columns. The risk associated with the solution of protecting the column with a safety barrier is still two times higher than that associated with 'passively safe' columns. Similar conclusions were reached for lighting columns on rural dual carriageways and for signposts on both single-carriageway and dual-carriageway rural roads.

It should be noted, on the other hand, that the use of passively safe structures might lead to an increase in maintenance costs when compared with the cost of erecting safety barriers. The final selection of the best treatment should, therefore, be based on a cost-benefit analysis.

| Option | Risk (number of equivalent fatalities per year) on rural single carriageway | | | | | |
|--|---|-----------------------|----------------------------------|-----------------|-----------------------|----------------|
| | Errant vehicle occupants | Other road users | | | | All road users |
| | | Hit by falling column | Run into fallen column or debris | Shunt collision | Lane change collision | |
| Unprotected conventional lighting column 2.5m from edge of carriageway | 0.0146 | - | - | - | - | 0.0243 |
| Conventional column 2.5m from edge of carriageway with safety barrier protection | 0.0036 | - | - | - | - | 0.0058 |
| Passively safe column 2.5m from edge of carriageway | 0.0017 | 0.000087 | 0.00013 | 0.000075 | 0.00017 | 0.0032 |

Figure 40: Risk assessment of different lighting column options on rural single-lane carriageway roads [56]

4.4 Case studies/examples

Forgiving or 'passively safe' support structures are widely used across Europe and around the world. Consequently, several different applications exist.

The website <http://www.ukroads.org/passivesafety/> provides a selection of 'crash-friendly' products in use in the UK.

4.5 References

4.5.1 Design guidelines and standards

When dealing with the issue of lighting, signs, and support structures on roadsides, the following guidelines could be considered as a reference:

- See Annex A for the possible criteria to identify the clear zones
- SETRA 'Guidelines – Handling lateral obstacles on main roads in open country' [48]
- The UK national Annex to EN 12767 [51];
- Texas Department of Transportation highway illumination manual [59];
- The AASHTO Roadside Design Guide [10].

Any 'passively safe' or 'forgiving' support to be installed in Europe should be tested in accordance with EN 12767 standard [50], even in those countries where this standard has not yet been adopted as mandatory for the approval of road equipment supports.

5 Shoulder width

5.1 Introduction

The width of the outer shoulder (the right-hand shoulder in most European countries) is commonly recognised as an important roadside safety feature as it increases the recovery zone that allows an errant driver to correct the trajectory of his/her vehicle without running off the road.

According to the PIARC Road Safety Manual [60], the shoulders on rural roads should be clear of obstacles and stabilised in order to facilitate recovery of encroaching vehicles.

According to the SafetyNet report on Roads [61], the implementation of a shoulder (especially paved) or an emergency lane, helps improve road safety on rural roads.

On the other hand, if shoulders are too wide, effects can be limited and counter-effects that lead to an increase in accidents can occur. The SafetyNet report indicates that this could happen when emergency lanes are wider than 3.00 m.

5.2 *Design criteria*

5.2.1 Outer shoulder width

Each country has its own design criteria for defining the proper outer shoulder width for different road types. It is therefore inappropriate to define 'recommended' design criteria as this might result in conflict with national standards that typically outline additional requirements. For example, the minimum outer shoulder widths required for different types of newly constructed rural roads in Austria, France, Italy, and Sweden are shown in Table 3. Very similar requirements are given for motorways with speed limits of 130 km/h (2.5–3.00 m). For secondary roads with speed limits of 80 to km/h there is much more variability: widths range from 1.5–2.0 m for conventional rural secondary roads in Austria, France, and Italy; 0.5 m for rural roads with no bicycles in Sweden; 0.75–1.5 m for mountain roads in France; and 1.0 m for local roads in Italy.

Table 3: Outer shoulder width requirements in Austria, France, Italy, and Sweden

| | Road type | Speed Limit (km/h) | Standard outer shoulder width (m) | Shoulder type |
|---------------------|---|---------------------------|--|---|
| Austria [62] | Motorway | 130 | 2.50–3.00 | Paved |
| | Motorway (special cases) | 130 | 3.50–4.00 | Paved |
| | Rural road | 100 | 1.50–2.00 | Paved |
| France [48] | Motorway – normal traffic | 130 (110) | 2.50–3.00 | Paved |
| | Motorway – moderate traffic | 130 (110) | 2.00 | Shoulder coated over 1 m min. |
| | Expressway | 90 | 2.00–2.50 | Shoulder coated |
| | Multifunctional road – interurban main | 90 (110) | 2.00 | Shoulder stabilised and preferably coated |
| | Multifunctional road – single carriageway 2 lanes | 90 | 2.00 (1.75) | Shoulder stabilised and preferably coated |
| | Multifunctional road – mountain roads | 90 | 0.75–1.50 | Shoulder stabilised and preferably coated |
| Italy [63] | Motorway | 130 | 2.50–3.00 | Paved |
| | Divided highway | 110 | 1.75 | Paved |
| | Secondary rural road | 90 | 1.25–1.50 | Paved |
| | Local rural road | 90 | 1.00 | Paved |
| Sweden [64] | Motorway | 110 | 2.00 | Paved |
| | Divided single carriageway (2+1) [No cyclists] | 100 | 0.50–0.75 | Paved |
| | Divided single carriageway (2+1) [With cyclists] | 100 | 0.75–1.00 | Paved |
| | Single carriageway [No cyclists] | 80 | 0.5 | Paved |
| | Single carriageway [With Cyclists] | 80 | 0.75 | Paved |

5.2.2 Paved versus unpaved

Generally speaking, paved shoulders are preferable to unpaved shoulders as these allow for a better control of an errant vehicle. According to Zegeer ([65], quoted in [60]), paving shoulders can lead to a 5% reduction in accidents. The results of the evaluation conducted on high risk curves (see [2]) lead to the same conclusion, namely that paved shoulders are a more effective treatment than non-paved shoulders.

In addition, most of the national standards require paved outer shoulders for new roads.

On the other hand, it should be taken into account that wide paved shoulders can lead to bad driving behaviour, such as speeding due to the perception of a reduced risk and use of the shoulders as travel or passing lanes. One option would be to have wide paved shoulders that limit the negative visual effects by adopting a different colour for the outer part of the shoulder (Figure 41 and Figure 28, the latter referred to median shoulders).

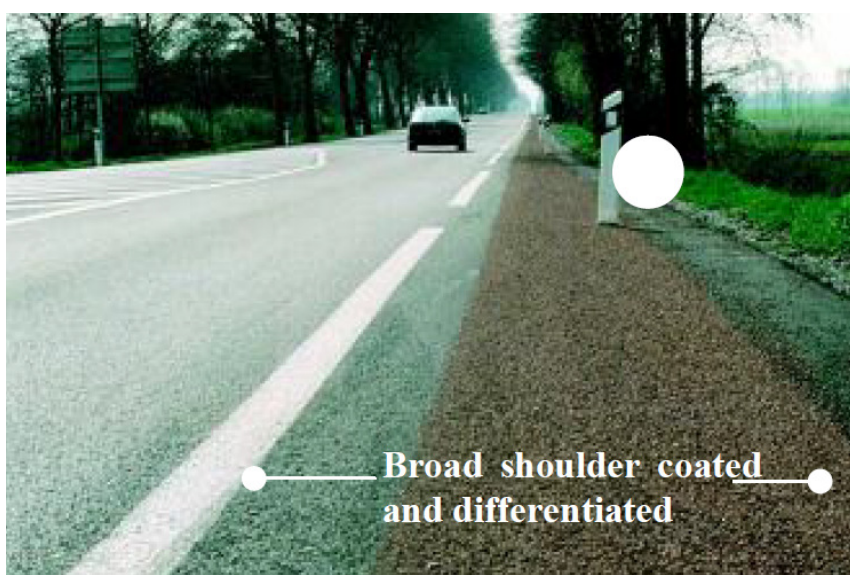

Figure 41: Use of different colours to reduce the driver's safety perception linked to wide shoulders [48]

5.3 Assessment of effectiveness

Several studies have shown that the outer shoulder width is a very important parameter in rural roads crash estimation for secondary rural roads and highways.

In the RIPCORDER-ISEREST Project [66], a summary of the findings on the effects of shoulder width on secondary rural roads (single carriageway) can be found. Although the effects of widening the shoulders can vary considerably from one study to another, all of them are consistent in the indication that there is a positive effect for shoulder widths up to 3.00 m. In the same report, several Safety Performance Functions are given, and almost all of them include shoulder width as a variable in the model.

Since the publication of the Highway Safety Manual [18] in 2010, this has been considered the key reference for the definition of outer shoulder width on rural single carriageway two-lane roads and multi-lane rural highways. The Crash Modification Factor (CMF) for shoulder width on rural two-lane single carriageway roads is given in Figure 42. This CMF applies only to a subset of the total crashes (single-vehicle run-off-road crashes, multiple-vehicle head-on, opposite direction sideswipe, same direction sideswipe).

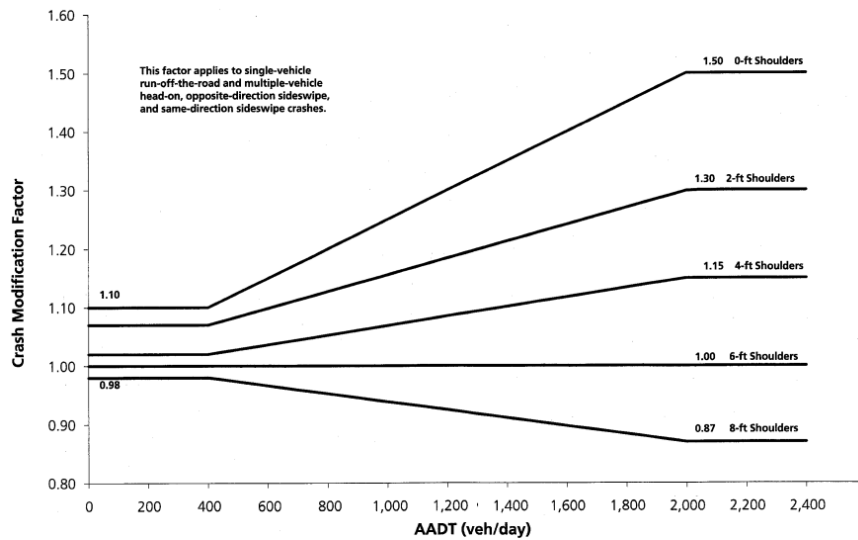

Figure 42: CMF for shoulder width effect on rural two-lane single carriageway roads according to the HSM [18]

The effect of outer shoulder width in multi-lane undivided and divided highways is shown in Figure 43 and Figure 44.

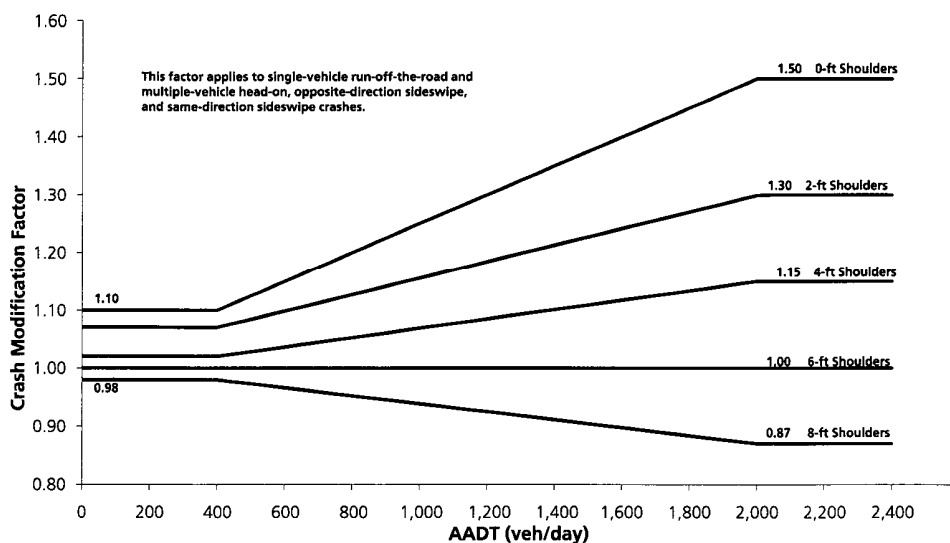

Figure 43: CMF for shoulder width effect on rural multi-lane undivided highways according to the HSM [18]

| Average Shoulder Width (ft) | | | | |
|-----------------------------|------|------|------|-----------|
| 0 | 2 | 4 | 6 | 8 or more |
| 1.18 | 1.13 | 1.09 | 1.04 | 1.00 |

Note: This CMF applies to paved shoulders only.

Figure 44: CMF for shoulder width effect on rural multi-lane divided highways according to the HSM [18]

For motorways, which are not included in the current edition of the HSM, there are currently no consolidated CMF models to account for a variation in shoulder width. The effect of this factor should therefore be derived from the application of Safety Performance Functions, where the shoulder width is one of the independent variables.

Two different studies have been selected for this type of road:

- For open air (non-tunnel) sections, the work recently published by Park [67] contains a summary of the most recent models developed for motorways. Out of the four models shown, only one includes the outer shoulder width as an independent variable for rural lane models. The results of the analysis conducted by Park on the Texas database confirmed that outer shoulder width is not a key variable for this type of road. However, it should be noted that in 228 out of 256 pairs considered for the analysis, the outer shoulder width was above 3.00 m. This result confirms that for shoulder widths larger than 3.00 m, no significant benefit is achieved.
- In tunnels, shoulders are often narrower than 3.00 m. The confined environment can affect the driver's behaviour. For this reason, the effect of outer shoulders could be more relevant. The Swiss Council for Accident Prevention [68] proposed the following model specifically for tunnels:

-

$$N = e^{[-19.81 + [0.77 \cdot \ln(A)] + [-0.59 \cdot B] + [1.61 \cdot \ln(C)] + [0.12 \cdot \ln(D)] + [-0.82 \cdot \ln(E)]}$$

where:

N is the number of expected accidents;

A is the tunnel length;

B is the number of tubes (2 or 1);

C is the ADT (Average Daily Traffic);

D is the percentage of heavy goods vehicles;

E is the shoulder + sidewalk width (in metres).

A recent study conducted in Italy has shown that this model can also be applied very well to tunnels other than the ones used for the model development with a calibration coefficient of 0.93 required for application of the model on the Italian network [69].

As indicated earlier, the effect of enlarging the outer shoulder width in rural roads is clearly positive for narrow shoulders, while for larger shoulders, it can be more questionable or even negative. It is therefore recommended that the CMF and predictive function given above be used for estimating the effects of having shoulder width below the national standards. If enlarging the shoulders above the national standard, a specific risk assessment should be conducted and additional interventions to prevent the use of the extra width of the shoulder should be considered (such as using different colours as shown above).

5.4 Case studies/examples

Within the IRDES Project, three case studies that relate directly or indirectly to the evaluation of the effectiveness of changing the shoulder width and the type of shoulder (paved/unpaved) were conducted.

In the experiment conducted in France (see [2]), the combined effect of lane width and shoulder width was investigated (

Figure 45). At the time of completion of the IRDES project, the results of the experiment were not available and conclusions cannot be drawn. Nevertheless, this is a very important topic as section enlargement is often not possible on existing roads, and defining the optimal combination of lane width and shoulder width could lead to a safer road section. This same issue was recently addressed in a FHWA-funded study that focused specifically on the safety evaluation of lane and shoulder width combinations [70].

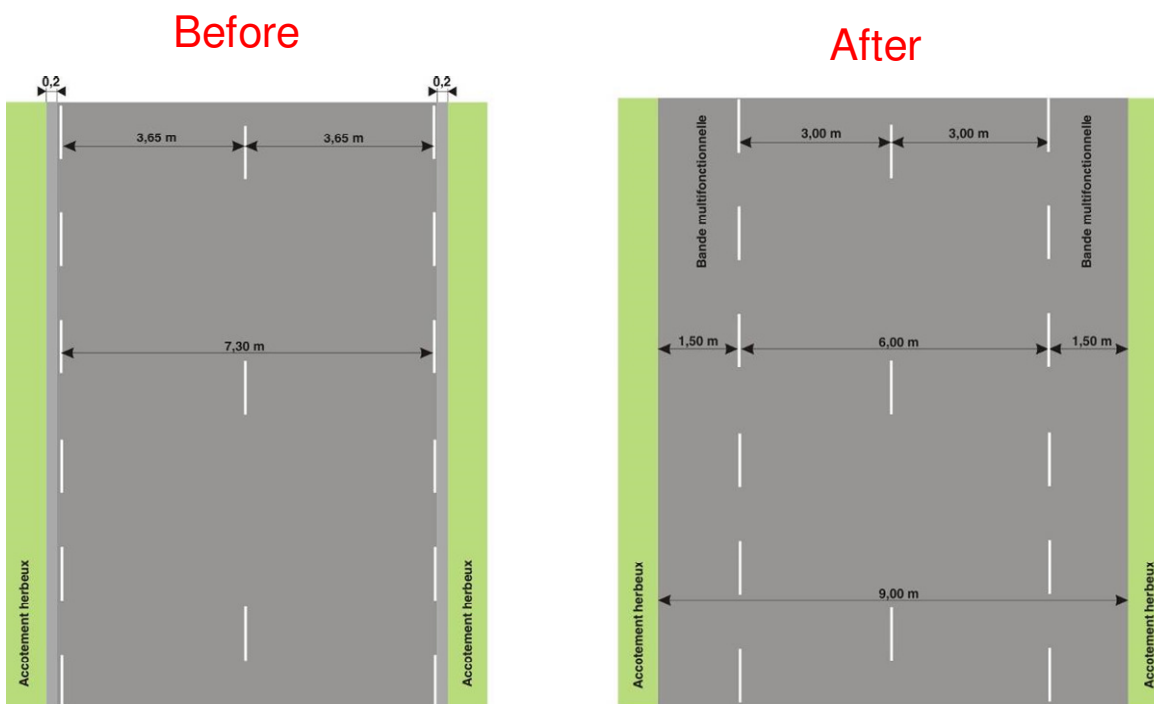
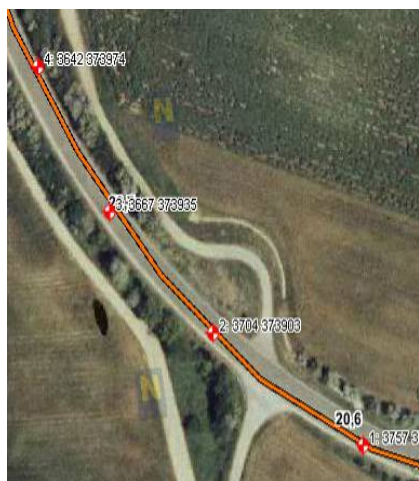

Figure 45: Before/after configuration for the analysis of the combined effect of shoulder and lane width

The experiment conducted in Austria (see [2]) sought to identify the potential effectiveness of different types of treatment (including increasing the length of the shoulder, either paved or unpaved) in high risk bends. The example in Figure 46 shows that having a hard shoulder in the outer shoulder is the most effective treatment in terms of reducing the MAIS (Maximum Abbreviated Injury Scale) and that this is also more effective than erecting a safety barrier.



| Scenario (Number) | MAIS | Effectiveness |
|---------------------------|------|---------------|
| No forgiving roadside (1) | 6 | 0% |
| Soft shoulder (2) | 2 | 70% |
| Hard shoulder (3,4,5) | 0 | 100% |
| Tree (6) | 6 | 0% |
| Safety barrier (7) | 1 | 90% |

Figure 46: Example of results from the analysis of the effectiveness of having soft (unpaved) and hard (paved) shoulders in high risk bends

In the accident analysis conducted in Italy (see [2]), a safety performance function was developed for the rural single-carriageway two-lane roads. Shoulder width turned out to be one of the most significant parameters affecting crash estimates.

6 Conclusion and recommendations

This guide provided practical guidance for the use of:

- barrier terminals
- shoulder rumble strips
- forgiving support structures for road equipment
- shoulder width

and the criteria for assessing the effectiveness of these types of intervention on different types of roads.

The key issues can be summarised as follows:

Barriers terminals

Safety barrier ends are considered hazardous when the termination is not properly anchored or ramped down in the ground, or when it does not flare away from the carriageway. Crashes involving 'unforgiving' safety barrier ends often result in a penetration of the passenger compartment and severe consequences.

Crashworthy terminals can be either flared or parallel, energy-absorbing or non-energy-absorbing. However, in the case of the latter, they have to be properly designed and flared to avoid front hits on the nose of the terminal. In some countries, only devices tested in accordance with ENV 1317-4 are permitted.

The decision to use either an energy-absorbing terminal or a non-energy-absorbing terminal should, therefore, be based on the likelihood of a near end-on impact and the nature of the recovery area immediately behind and beyond the terminal. When the barrier Length of Need (see chapter 2.2.5) is properly defined and guaranteed and the terminal is placed in an area where there is no need for safety barrier protection, it is unlikely that a vehicle will reach the primary shielded object after an end-on impact regardless of the terminal type selected. If, therefore, the terrain beyond the terminal and immediately behind the barrier is safely traversable, a flared terminal is preferable.

If, because of local constraints, the proper Length of Need cannot be guaranteed or if the terrain beyond the terminal and immediately behind the barrier is not safely traversable, an energy-absorbing terminal is recommended.

Turn-down terminals or flared-degraded terminals, which have been commonly used in several countries in recent years, are often being replaced in several countries in new designs by flared terminals with no degradation because the longitudinal slide that arises from the degradation to the ground can cause a vehicle to pass over the barrier.

Additional issues to be considered in terminal design (see chapter 2) are:

- the definition of the Length of Need;
- the configuration of terminals in backslopes;
- the configuration of terminals in medians;
- the configuration of terminals adjacent to driveways.

In terms of effectiveness, no before/after studies are available. However, in WP2 of the IRDES projects, a CMF has been developed to estimate the effect of the number of unprotected terminals and could be used as a reference.

Shoulder rumble strips

Shoulder rumble strips have been proven to be a low-cost, extremely effective treatment in reducing single-vehicle run-off-road (SVROR) crashes and their severity.

Combining different studies, the Crash Modification Factor (CMF) for the use of milled rumble strips on rural freeways (dual carriageway highways) has been estimated as:

- 0.89 (which means a potential reduction in crashes of 11%) for SVROR crashes, with a standard error of 0.1;
- 0.84 (which means a potential reduction in crashes of 16%) for SVROR fatal and injury crashes, with a standard error of 0.1.

Combining different studies, the Crash Modification Factor (CMF) for the use of milled rumble strips on rural two-lane roads has been estimated as:

- 0.85 (which means a potential reduction in crashes of 15%) for SVROR crashes, with a standard error of 0.1;
- 0.71 (which means a potential reduction in crashes of 29%) for SVROR fatal and injury crashes, with a standard error of 0.1.

Given these values of the standard errors, these results can definitely be considered positive in estimating the potential effect of milled shoulder rumble strips on these types of road. The predicted effect is never above 1 within a 95% confidence interval.

For urban freeways and multi-lane divided highways, the analysis data available does not yet allow for a statistically sound evaluation of effectiveness. However, a best estimate of the effects of rolled shoulder rumble strips and milled shoulder rumble strips is given below:

- Rolled shoulder rumble strips on urban freeways are expected to reduce SVROR crashes by 18% and SVROR fatal and injury crashes by 13%;
- Milled shoulder rumble strips on rural multi-lane divided highways are expected to reduce SVROR crashes by 22% and SVROR fatal and injury crashes by 51%.

Different design configurations have been proposed for milled rumble strips:

- a 'more aggressive' (and more effective) configuration that can cause greater disturbance for bicycle drivers and residents in the vicinity. This type of configuration is recommended when there are no residents in the vicinity of the road and when either a 1.2-m remaining shoulder is available or very limited or no bicycle traffic is expected;
- a 'less aggressive' configuration that is more 'bicycle friendly' and reduces noise disturbance in the surrounding area.

Rumble strips on 'non-controlled access' highways should include periodic gaps of 3.7 m in length placed at periodic intervals of 12.2 m or 18.3 m to satisfy cyclists' need to cross the rumble strip pattern without causing them to enter the grooved area. This recommended length is sufficiently long as to permit a typical cyclist to cross without entering the grooved area, but not so long as to permit a vehicle tyre at a typical run-off-road angle of departure to cross the gap without entering the grooved area.

Shoulder rumble strips should not be placed closer than 200 m to an urban area where, if needed, rolled rumble strips could be considered. The reason being that these produce less noise and do not affect bicycle handling.

Forgiving support structures for road equipment

This section of the guide addressed the issue of identifying potential hazards on the roadside and defining the most appropriate solutions for making the hazard caused by support structures more forgiving. Designers and road managers often say that obstacles on the roadside *need* to be protected with safety barriers. This is a simplistic approach that must be overcome if we are to reach a forgiving roadside design approach. The reason being that erection of a barrier (with its Length of Need and its terminals) is not necessarily the most 'forgiving' solution and can be extremely costly when compared with the benefits achieved.

In this guide, the procedure developed in the RISER project has been proposed and implemented to identify whether the obstacle has to be considered a hazard, which means whether it is situated within the clear zone and if it has structural characteristics that could lead to injuries to an errant vehicle impacting against the obstacle. Criteria for identifying potential hazards are given in chapter 4.2.

Support structures that have been tested in accordance with the EN 12767 standard are considered to be passively safe. However, the standard identifies different performance classes, and guidelines for selecting the most appropriate performance class in different situations are given in chapter 4.2.

Even though this type of structure has been in use for several years in several countries including most of the northern European countries (Norway, Finland, Sweden, and Iceland), sound statistical analyses of the effectiveness of using 'passively safe' support structures in reducing the severity of crashes were not found. On the other hand, there are several studies that indicate that crashes against these type of structures rarely lead to severe consequences.

A risk assessment of the potential effect of using passively safe lighting columns and signposts has been performed in the UK by combining the likelihood of the occurrence of different events that can lead to passenger injuries. The risk associated with the use of 'passively safe' or 'forgiving' lighting columns resulted in a risk that is almost eight times lower than that associated with conventional unprotected columns. The risk associated with the solution of protecting the column with a safety barrier is still two times higher than that associated with 'passively safe' columns.

Shoulder width

The width of the outer shoulder (the right-hand shoulder in most European countries) is commonly recognised as an important roadside safety feature as it increases the recovery zone that allows an errant driver to correct the trajectory of his/her vehicle without running off the road. However, the effect of enlarging the outer shoulder width in rural roads is clearly positive for narrow shoulders; for wider shoulders it can be more questionable or even negative. It is therefore recommended that the CMF and predictive functions given in chapter 4.3 are used for estimating the effects of having shoulder widths below the national standards.

If enlarging shoulders above the national standards, a specific risk assessment should be conducted and additional interventions to prevent the use of the extra width of the shoulder should be considered (such as the use of different colours).

For rural single-carriageway two-lane roads and for multi-lane divided and undivided highways, consolidated CMF functions are given in the recently published Highway Safety Manual. For motorways in the open air (outside of tunnels), the effect of the shoulder width is often negligible as these road types usually have an outer shoulder width of 2.50–3.0 m, which has been shown to be the value above which there is no effect in crash reduction. For motorways in tunnels, where shoulders are often narrower and the confined environment affects the drivers behaviour, a specific Safety Performance Function is given to estimate the effect of having a reduced shoulder width.

Given the fact that national standards usually set the criteria for defining the minimum or standard outer shoulder width, a 'uniform' value was not proposed. However, the requirements given for rural roads in Austria, France, Italy, and Sweden were compared, showing that although they are very similar for motorways with speed limits of 130 km/h (2.50–3.00 m), they vary more considerably for roads on the secondary road network with speed limits of 80 to 100 km/h.

References

- [1] RISER consortium. 'D06: European Best Practice for Roadside Design: Guidelines for Roadside Infrastructure on New and Existing Roads'. RISER deliverable, February 2006
- [2] Fagerlind, H., Martinsson, J., Nitsche, P., Saleh, P., Goyat, Y., La Torre, F., Grossi, A. 'Guide for the Assessment of Treatment Effectiveness'. ENR SRO1 – ERANET Project IRDES – Deliverable N. 2, 2011, <http://www.irdes-eranet.eu> (last consultation on 16/07/2012).
- [3] U.S. Department of Transportation. 'Roadside improvements for local roads and streets'. Federal highway administration, USA, October 1986
- [4] S. Matena et al. 'Road Design and Environment – Best practice on Self-explaining and Forgiving Roads'. RIPCORD-ISEREST deliverable D3, 2005
- [5] L. Herrstedt. 'Self-explaining and Forgiving Roads – Speed management in rural areas'. Paper presented at the ARRB Conference, October 2006;
- [6] PIARC, 'Human Factors Guideline for Safer Road Infrastructure', 2008R18, www.piarc.org
- [7] RISER consortium. 'D05: Summary of European Design Guidelines for roadside infrastructure'. RISER deliverable, February 2005
- [8] D. Vangi 'L'urto contro le barriere di sicurezza: dalla teoria alla pratica' Slides of the COPEBARR course, University of Florence Italy, 2010 (in Italian);
- [9] Tasmania Department of Infrastructure, Energy and Resource. 'Road Hazard Management Guide', 2004
- [10] AASHTO 'Roadside Design Guide', American Association of Highway Transportation Officials, Washington 2011, ISBN 1-56051-509-8;
- [11] http://egov.oregon.gov/ODOT/HWY/ENGSERVICES/roadway_drawings.shtml (last accessed 16.07.2012)
- [12] <http://www2.mainroads.wa.gov.au/NR/mrwa/frames/Standards> (last accessed 16.07.2012)
- [13] ENV 1317-4, 'Road Restrain Systems: performance classes, impact test acceptance criteria and test methods for terminals and transitions of safety barriers', CEN – European Standardization Organization, 2001 (discontinued)
- [14] D.M. 2367/2004 containing the 'Istruzioni tecniche per la progettazione, l'omologazione e l'impiego dei dispositivi di ritenuta nelle costruzioni stradali', Italian Ministry for Infrastructure and Transportation, 21.6.2004 (in Italian);
- [15] FGSV 'Guidelines for passive protection on roads by vehicle restraint systems – RPS R1', Issue 2009 (in English);
- [16] Austrian Association for Research on Road-Rail-Transport (FSV), RVS 05.02.31; Traffic control, Traffic guidance facilities, Vehicle restraint systems, Requirements and installation (in German);
- [17] M. H. Ray, J. Weir and J. Hopp 'In-Service Performance of Traffic Barriers' NCHRP Report 490, Transportation Research Board Washington, 2003

-
- [18] AASHTO 'Highway Safety Manual', American Association of Highway Transportation Officials, Washington 2010, ISBN 9781560514770;
- [19] http://www.modot.org/business/standards_and_specs/endterminals.htm (last accessed 2.11.2011);
- [20] CEDR 'Best Practice for Cost-Effective Road Safety Infrastructure Investments', Full Report – April 2008;
- [21] FHWA 'Technical Advisory - shoulder and edge line rumble strips' T5040.39, April 22, 2011;
- [22] D. J. Torbic, J. M. Hutton, C. D. Bokenkroger, K. M. Bauer, D. W. Harwood, D. K. Gilmore, J. M. Dunn, J. J. Ronchetto, E. T. Donnell, H. J. Sommer III, P. Garvey, B. Persaud, C. Lyon 'Guidance for the Design and Application of Shoulder and Centerline Rumble Strips', NCHRP Report 641, 2009;
- [23] FHWA 'Synthesis of Shoulder Rumble Strip Practices and Policies' http://safety.fhwa.dot.gov/roadway_dept/research/exec_summary.htm (last accessed November 2011);
- [24] <http://www.rumblestrips.com> (last accessed November 2011);
- [25] F. La Torre, 'Influence of Roadway Surface Discontinuities on Safety - State of the Art Report – Chapter Positive Effects of Road Surface Discontinuities', Transportation Research Circular E-C134 - ISSN 0097-8515, TRB, National Research Council, Washington, D.C., 2008 pp. 25–31;
- [26] J. Kragh, B. Andersen, S. N. Thomsen 'Low noise rumble strips on roads – a pilot study' INTER-NOISE 2007, 28–31 August 2007, ISTANBUL, TURKEY
- [27] British Columbia Engineering Branch Standards Section 'Shoulder Rumble Strip Guidelines on Rural Highways', doc. 14300.00\RSTRIP, April 25, 2000
- [28] N. E. Wood 'Shoulder rumble strips: a method to alert "drifting" drivers' Presented at the 73rd TRB Annual Meeting, Washington, January 1994;
- [29] J.J. Hickey Jr. 'Shoulder rumble strip effectiveness: Drift-off-road accident reductions on the Pennsylvania Turnpike' Transportation Research Record 1573, TRB, National Research Council, Washington, D.C., 1997 pp. 105–109;
- [30] K. Perillo, 'The Effectiveness and Use of Continuous Shoulder Rumble Strips', August 1998, FHWA web site http://safety.fhwa.dot.gov/roadway_dept/rumble/;
- [31] M. S. Griffith 'Safety evaluation of rolled-in continuous shoulder rumble strips installed on freeways' HSIS Summary report - FHWA-RD-00-032, December 1999;
- [32] M. S. Griffith, 'Safety Evaluation of Rolled-In Continuous Shoulder Rumble Strips Installed on Freeways'. Transportation Research Record: Journal of the Transportation Research Board, No. 1665, TRB, National Research Council, Washington, D.C., 1999, pp. 28–34.
- [33] NCHRP 'Crash reduction factors for traffic engineering and intelligent transportation system (ITS) improvements: state-of-knowledge report' Research Results Digest 299, November 2005;
- [34] O. Carrasco, J. McFadden, P. Chandhok, R. Patel 'Evaluation of Effectiveness of Shoulder Rumble Strips on Rural Multilane Highways in Minnesota' Transportation Research Board Annual Meeting 2004 Paper #04-4012;
-

-
- [35] R.B. Patel, F.M. Council, M.S. Griffith, 'Estimating Safety Benefits of Shoulder Rumble Strips on Two-Lane Rural Highways in Minnesota: Empirical Bayes Observational Before-and-After Study' Transportation Research Board Annual Meeting 2007 Paper #07-1924;
 - [36] J. A. Lindley 'Memorandum ACTION: Consideration and implementation of proven safety countermeasures', FHWA, 10 July 2008
 - [37] G. J. Bahar, M. P. Parkhill, E. Tan, C. Philp, N. Morris, S. Naylor, T. White, E. Hauer, F. M. Council, B. Persaud, C. Zegeer, R. Elvik, A. Smiley, and B. Scott. 'NCHRP Report 17–27: Development of Parts I and II of a Highway Safety Manual, Inclusion Process and Literature Review Procedure for Part II', June 2007;
 - [38] D. J. Torbic, J. M. Hutton, C. D. Bokenkroger, K. M. Bauer, E. T. Donnell, C. Lyon, B. Persaud 'Guidance on Design and Application of Rumble Strips' Transportation Research Record: Journal of the Transportation Research Board, No. 2149, Transportation Research Board of the National Academies, Washington, D.C., 2010, pp. 59–69;
 - [39] A. Anund. M. Hjalmdahl, H. Sehammar, G. Palmqvist, B. Thorslund 'Placement and design of milled rumble strips on centre line and shoulder - A driving simulator study', VTI rapport 523A, 2005 (ISSN 0347-6030);
 - [40] PIARC 'Road Safety Manual' PIARC Publication #103.03.B, Paris 2003;
 - [41] R.C. Moeur 'Analysis of gap patterns in Longitudinal Rumble Strips to accommodate bicycle travel', Transportation Research Record: Journal of the Transportation Research Board, No. 1705, Transportation Research Board of the National Academies, Washington, D.C., 2000;
 - [42] D. Torbic, L. Elefteriadou, M. El-Gindy 'Development of Rumble Strip Configurations That Are More Bicycle Friendly', Transportation Research Record: Journal of the Transportation Research Board, No. 1773, Transportation Research Board of the National Academies, Washington, D.C., 2001;
 - [43] A. Hegewald 'Safety effects and cost benefit of milled shoulder rumble strips', European Transport Conference 2009: Seminars, Leeuwenhorst, The Netherlands, 05/10/2009 – 07/10/2009;
 - [44] K. W. Miller 'Effects of Center-Line Rumble Strips on Non-Conventional Vehicles', Minnesota Department of Transportation, Report MN/RC 2008-07, January 2008;
 - [45] State of Alaska, Department of Transportation, Office of Traffic and Safety http://www.dot.state.ak.us/stwddes/dcstraffic/rumble/rumble_fags.shtml#rumble_question7 (last accessed 25/11/2011);
 - [46] Insurance Institute for Highway Safety. Fatality Facts 2008, Roadside hazards. Taken from http://www.iihs.org/research/fatality_facts_2008/roadsidehazards.html, visited on 25/02/2010;
 - [47] Roads and Traffic Authority NSW. Fatal Roadside Object Study in *Road Environment Safety Update 20*. New South Wales, Australia, March 2004;
 - [48] SETRA 'Guidelines – Handling lateral obstacles on main roads in open country', November 2002, translated August 2007, France 2007;

-
- [49] K. Lacy, R. Srinivasan, C. V. Zegeer, R. Pfefer, T. R. Neuman, K. L. Slack, K. K. Hardy, NCHRP REPORT 500 – 'Safety and Human Performance Guidance for Implementation of the AASHTO Strategic Highway Safety Plan Volume 8: A Guide for Reducing Collisions Involving Utility Poles';
- [50] EN 12767 'Passive safety of support structures for road equipment – Requirements, classification and test methods', CEN – European Standardization Organization, 2007
- [51] BSI-EN 12767 'Passive safety of support structures for road equipment – Requirements, classification and test methods', National Annex BSI – British Standards Institution, 2007
- [52] Alberta Ministry of Infrastructure and Transportation. *Roadside Design Guide*. Alberta, Canada, November 2007;
- [53] The Danish Road Directorate 'Use of passive support structures on the state roads' (<http://www.vejdirektoratet.dk/dokument.asp?page=document&objno=262678>, last accessed 24.11.2011);
- [54] FINNRA 'Break-Away Lighting Columns in Finland, Year 2005' Engineering News No 9E Published by the Finnish Road Administration, Technical services 27 January 2005;
- [55] FINNRA 'Vertical Sign Support With Passive Safety, Year 2005' Engineering News No 12B Published by Finnish Road Administration, Technical Services, 27 January 2005;
- [56] G. L. Williams, J. V. Kennedy, J. A. Carroll, R. Beesley 'The use of passively safe signposts and lighting columns' Published by TRL, UK, August 2008 – ISSN 0968-4093;
- [57] CSP Pacific. Taken from www.csppacific.co.nz, visited on 21/07/2010;
- [58] http://www.lattix.net/index.php/site/press_full/potentially_lives_saved/ (last accessed 25/11/2011);
- [59] Texas Department of Transportation. *Highway Illumination Manual*. Taken from http://onlinemanuals.txdot.gov/txdotmanuals/hwi/manual_notice.htm, visited on 21/07/10;
- [60] PIARC 'Road Safety Manual' Version 1.0, 2003 Published by PIARC – World Road Association, Paris – France;
- [61] SafetyNet 'Roads', 2009. Retrieved from http://ec.europa.eu/transport/road_safety/specialist/knowledge/road/index.htm on 27/11/2011;
- [62] Austrian Association for Research on Road-Rail-Transport (FSV), RVS 03.03.31 'Road planning, Cross-sections, cross-section elements of rural roads; envelopes of clearance' (in German);
- [63] Italian Ministry of Infrastructures and Transportation 'Norme funzionali e geometriche per la costruzione delle strade', D.M. 6792 dated 5.11.2001 (in Italian);
- [64] Vägar och gators utformning, VV Publikation 2004:80, ISSN 1401-9612 (in Swedish);
- [65] C.V. Zegeer, J.M. Twomey, M.L. Heckman, J.C. Hayward 'Safety effectiveness of highway design features: Volume II, Alignment' FHWA-RD-91-045, Federal Highway Administration, Washington, DC, 1992;
- [66] G. Gatti, C. Polidori, I. Galvez, K. Mallschützke, R. Jorna, M. Van de Leur, M. Dietze, D. Ebersbach, C. Lippold, B. Schlag, G. Weller, A. Wyczynski, F. Iman, C. Aydin 'Safety Handbook for Secondary Rural Roads', RIPCARD-ISEREST Project Deliverable D13, 01 January 2005;

- [67] B.-J. Park, K. Fitzpatrick, D. Lord 'Evaluating the Effects of Freeway Design Elements on Safety' Transportation Research Record: Journal of the Transportation Research Board, No. 2195, Transportation Research Board of the National Academies, Washington, D.C., 2010, pp. 58–69;
- [68] U. Salvisberg, R. Allenbach, M. Hubacher, M. Cavegn, S. Siegrist, 'Verkehrssicherheit in Autobahn- und Autostrassentunneln des National-strassennetzes', BFU Report n. 51, UPI - Bern 2004;
- [69] L. Domenichini, F. La Torre, F. J. Caputo, F. Fanfani 'Il modello previsionale di incidentalità in gallerie autostradali', Rivista Strade & Autostrade 01-2012 pp. 148–156 [in Italian];
- [70] F. Gross, P. P. Jovanis, K. Eccles, and Ko-Yu Chen 'Safety evaluation of lane and shoulder width combinations on rural, two-lane, undivided roads' FHWA Report HRT-09-031, June 2009.

ANNEX A: The state of the art

7 Foreword to Annex A

The goal of the work in Annex A is to collect and harmonise common standards and guidelines for roadside treatments. Initially, this annex introduces typical roadside hazards, which are the basis for appropriate counter-measures. The main part of this report comprises results and findings drawn from relevant literature, guidelines, and standards that deal with roadside treatments.

Summarising the literature, three categories of treatments are proposed:

1. the removing or relocation of potentially dangerous roadside objects,
2. the modification of roadside objects or design, and
3. the shielding of roadside objects.

These three categories determine the main structure of the annex. The first category mainly comprises recommendations for clear zones. These are obstacle-free areas beyond the travel lane that allow the drivers to regain control of the vehicle avoiding collisions with obstacles. Additionally, these zones allow drivers to perform easy recovery manoeuvres. The possibility of providing an appropriate clear zone should always be investigated in the design phase, especially during the preliminary planning stage.

If hazardous obstacles cannot be removed or relocated, they need to be modified. Crashworthy structures or breakaway devices are common examples of modifications. Moreover, the design of slopes and ditches are relevant road safety factors.

In many cases, removing or modifying hazardous objects is not possible or economically advisable. Isolating or shielding the drivers from the respective objects helps to minimise the severity of a crash. Safety barriers and attenuators at bridge abutments are good examples of this kind of treatment.

8 Roadside hazards

The forgiving roadside concept emerged in the mid-1960s to account for the fact that vehicles can run off the roadway. The reasons why vehicles leave the roadway have been divided into the following groups [A.19]:

- driver behaviour such as inattention, fatigue, the influence of alcohol or drugs, evasion manoeuvres, excessive speed, etc.;
- roadway conditions such as poor alignment, poor visibility, reduced pavement friction, inadequate drainage, substandard signing, marking or delineation, etc.;
- vehicle malfunctions such as steering and braking failures, tyre blowouts, etc.

The main factors that affect the severity of a run-off-road accident are the layout and type of objects on the roadside. A main objective of designing forgiving roadsides is to provide clear zones, which is not always possible. Some roadsides have potential hazards for the drivers close to the carriageway. In many cases, the placement of certain objects—such as lighting poles, traffic signs, or bridge barriers—cannot be avoided. Other objects such as embankments, slopes, or ditches affect roadside safety and should be treated in an effective manner. As stated in [A.35], a roadside object is considered hazardous when one or more of the following events occur:

- the vehicle is abruptly stopped;
- the passenger compartment is penetrated by some external object;
- the vehicle becomes unstable due to roadside elements.

In [52], a roadside hazard is defined as any non-breakaway or non-traversable roadside feature that is greater than 100 mm in diameter or thickness. The RISER project showed that trees are the most dangerous roadside objects. Around 17% of all tree accidents recorded were fatal [A.2]. In the case studies of this investigation, where speed data was known, all fatal accidents involved impact speeds of 70 km/h or more. Structures such as signs, concrete walls, fences, etc. are hit in 11% of all fatal single-vehicle accidents (SVA). According to the RISER accident analysis, safety barriers appear to be the object that is most frequently impacted in SVAs. However, safety barrier SVAs generally resulted in minor injuries. It should be noted, however, that safety barriers themselves can pose a hazard if not properly designed and installed.

The study in [A.48] is based on the U.S. Department of Transportation's Fatality Analysis Reporting System (FARS) and shows the results of an analysis of fatal accidents caused by impacting fixed objects. In total, 8,623 fatalities were analysed. Analysing the distribution of fixed object crash deaths in 2008, the high percentage of tree accident deaths (48%) was striking. Utility poles and safety barriers were the next most frequently impacted objects.

In many crashes, the vehicle hits more than one roadside object. A study published by the Roads and Traffic Authority of New South Wales in Australia [A.7] examined the specific types of roadside objects that were hit by vehicles in second impacts. The analysis only contained fatal accidents and indicates again that trees are the most frequently struck roadside objects, followed by utility poles and embankments. Trees and utility poles have the highest percentage of objects hit in first as well as second impact (see Figure 47).

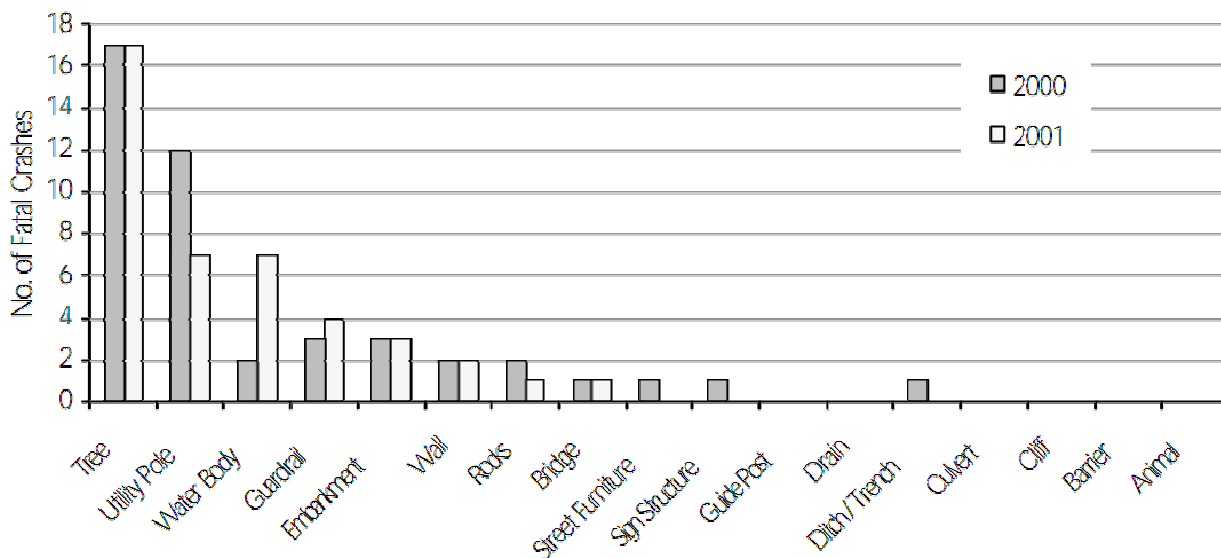

Figure 47: Roadside objects hit in second impacts, based on 1,029 fatal accidents, NSW 2000 & 2001 [A.7]

This chapter deals with roadside hazards and gives an overview of a high number of exemplary objects. Treatments to improve hazardous roadside elements are presented in Chapter 9. [A.35] and [A.2] present similar categorisations of hazardous obstacles. In this report, they are grouped as follows:

1. single fixed obstacles
2. continuous obstacles
3. dynamic roadside hazards

8.1 *Single fixed obstacles*

According to several studies, single or point objects make up the highest number of potential hazards along the roadside. According to [A.23], point hazards are defined as permanent installations of limited length. They can be natural or artificial, human-made structures made of different materials. Of course, large rigid structures such as bridge abutments cause the most severe accidents because they do not provide sufficient energy absorbance. On the pages that follow, different examples of single obstacles as well as their degree of hazardousness are explained.

8.1.1 Trees and other vegetation

Accident analyses in [A.7] and [A.48] have proven that tree collisions claim a high number of lives. Compared with other roadside obstacles, trees, or other rigid vegetation seem to be most hazardous. According to the RISER project, trees become particularly dangerous when the diameter exceeds 20 cm (see [A.2]) – in France it is 10 cm). The impact speed is considered dangerous if higher than 40 km/h. According to a study in [A.8], the injury severity for tree collisions is much higher than in all accidents recorded (see Figure 48).

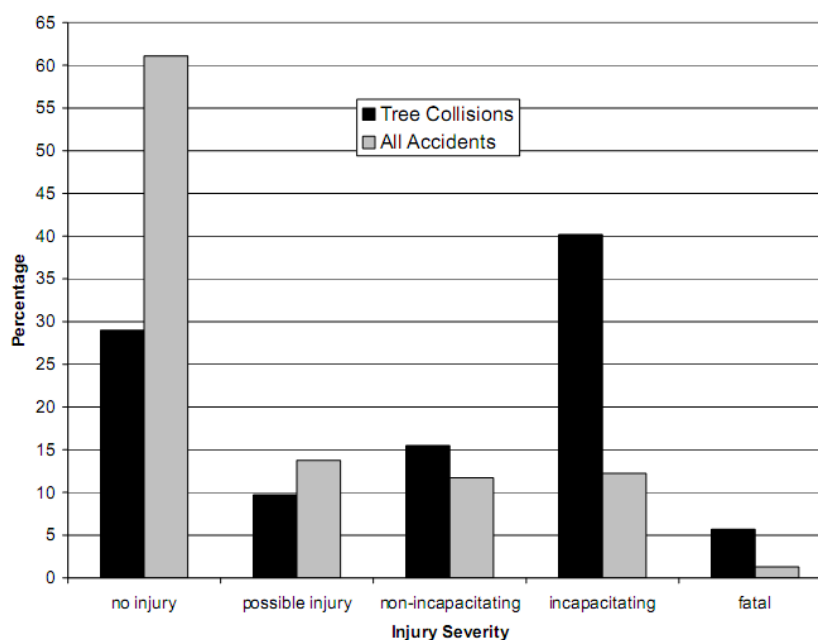

Figure 48: Relative frequency of injury severity for tree collisions and all accidents (in %), based on 1,830 tree accidents [A.8]

A guide from the NCHRP [A.21] contains an interesting analysis of the relation between the average distance of trees to the travel lane and tree accidents. It shows that shorter distances result in more accidents. The example pictured in Figure 49 show trees that are located too close to the road without delineation or shielding. In the right-hand picture, the tree was the second object to be impacted after the vehicle hit the kerb.



Figure 49: Examples of hazardous trees located on the roadside (Source: [A.24], [A.53])

However, one should also consider a tree as an aesthetic roadside design element, as Bratton and Wolf do in [A.8]. Removing trees can be an emotional community issue. There are research gaps on how trees can be effectively incorporated into a safe roadside design in a way that promotes community values and aesthetics/environmental requirements. Guidelines for a safe and aesthetic design of urban roadside treatments have been worked out in [A.22].

8.1.2 Utility poles

Utility poles typically carry power or telephone overhead cables. The poles are often made of rigid wood or concrete and can therefore be called 'unforgiving', since the energy absorbance ability is minimal. Two examples of hazardous utility poles located on the roadside are depicted in Figure 50. In both pictures, the poles are located within one meter of the road and are not shielded.



Figure 50: Two examples of hazardous utility poles (Source: [A.51])

Utility poles are the second most hazardous roadside obstacles in terms of fatal accidents. One primary finding of a study by Mak and Mason [A.9] was that pole accidents are mostly urban problems with approximately 37 pole accidents per 100 miles of highway (~161 km) compared with 5.2 for rural roads. They also found that pole accidents in rural areas have higher impact severities than urban pole accidents. Of course, the impact severity depends on the driving speed, which is generally higher on rural roads.

8.1.3 Sign and lighting posts and supports

Other than utility poles, the structures described here carry lights or traffic and warning signs. They generally have to be located close to the roadway and cannot be removed or relocated. They are hazardous if they are non-breakaway during impacts. The results in [A.48] show that sign and light supports are responsible for 4% of fixed object crash fatalities. The literature on in-depth analyses of crashes involving facilities is limited.

In the RISER project, guidelines from across Europe were collected. These guidelines define a minimum diameter of different types of posts and supports above which they are no longer considered safe. Further information can be found in [A.3]. Figure 51 shows two examples of hazardous poles on the roadside.



Figure 51: Examples of hazardous sign-posts (Source: [A.3])

8.1.4 Abutments and tunnel entrances

Abutments, overpasses, bridge piers, and walls at tunnel entrances are mostly made of rigid concrete and are considered extremely hazardous. According to RISER [A.3], such objects are dangerous if the diameter of a pier is greater than 1 metre, if they are too close to the roadway, or if they are unshielded. Often, the entrance to a tunnel is constructed in a way that does not allow a vehicle to slide along the structure. However, walls and bridge piers have a relatively small percentage of crash fatalities compared with other fixed objects. Examples of a hazardous bridge abutment as well as an overpass are depicted in Figure 52.



Figure 52: Examples of a hazardous bridge abutment (*left*) and overpass (*right*) (Source: [A.2])

8.1.5 Safety barrier terminals and transitions

Safety barriers are forgiving roadside treatments that are used to shield hazardous obstacles and/or to prevent vehicles from running off the roadway. However, the ends or transitions between two different types of rails can be hazardous roadside objects. Safety barrier ends are considered hazardous when the termination is not properly anchored or ramped down in the ground, or when it does not flare away from the carriageway [A.3]. The RISER database contains 41 accidents where barriers were the only obstacles involved. In 14 cases (i.e. 34.1%), the termination of the barrier was hit. Crashes with 'unforgiving' safety barrier ends often result in penetration of the passenger compartment.

The most common transition section occurs between bridge rail ends and approach barriers. In these cases in particular, the transitions may cause high deceleration and are, therefore, 'unforgiving'. Figure 53 depicts two examples of dangerous safety barrier terminations. In the right-hand picture, a transition between bridge rail and roadway guardrail is missing. Both ends have no proper end treatment.



Figure 53: Examples of hazardous safety barrier terminations

8.1.6 Rocks and boulders

Single rocks and boulders are dangerous obstacles when located too close to the roadway. Exposed outcrops mainly occur on roads constructed in a rocky environment, where the provision of a clear zone is expensive. A further hazard resulting from rock cuts on the roadside are fragments that can fall down from steep slopes onto the roadway. See Figure 54 for examples of such roadside hazards.



Figure 54: Examples of hazardous boulders (*left*) and rocks (*right*) on the roadside (Source: [A.2] and [A.3])

8.1.7 Drainage features

In cases where a vehicle runs off the road, drainage features like culverts or culvert ends are hazardous roadside obstacles. They are commonly used to channel a water course and are made of concrete, steel, or plastic. According to [A.48], 3% of all fixed object crash deaths are caused by culverts. The examples in Figure 55 depict hazardous drainage structures. As seen in the left-hand picture, these features are often made of rigid material, which cannot absorb the impact energy.



Figure 55: Examples of hazardous drainage features (Source: [A.2])

8.1.8 Other single fixed obstacles

Besides the obstacles mentioned above, other roadside objects may be hazardous for drivers. Single rigid structures such as masonry road markings, hydrants, unshielded houses, artwork, etc. are common roadside features that must be treated in an effective manner. In the past decade, many roundabouts have been artistically redesigned to make the centre of the roundabout more attractive. Some of these artworks are extremely hazardous due to their 'unforgiving' structure and protruding parts. Motorcyclists in particular can be seriously injured or killed when hitting such artwork.

8.2 Continuous hazards

Continuous hazards are distributed objects that are of considerable length, making it unpractical to remove or relocate them. On the following pages, several examples of continuous hazards and their impact on roadside safety are presented.

8.2.1 Embankments and slopes

An embankment is a man-made ridge of earth or stone that carries a road or railway. The term comprises all kinds of sloping roadsides including cut and fill slopes (see Figure 56). A cut slope is the face of an excavated bank required to lower the natural ground line to the desired road profile. In contrast to that, a fill slope is the face of an embankment required to raise the desired road profile above the natural ground line.³ How hazardous a slope is depends on its height or depth, its steepness, and its distance to the roadway. A detailed analysis of standards in different countries defining the thresholds for those parameters was performed in the RISER project [A.3].



Figure 56: Examples of hazardous cut (*left*) and fill slopes (*right*) (Source: [A.2])

³ Definitions taken from the Ministry of Forests of Government of British Columbia

According to [A.48], embankments are hit in 6% of all fixed object crash deaths. The risk of a vehicle rollover is high when hitting an embankment, especially when it is a steep slope. The study also showed that nearly a third of all fatal embankment accidents are caused by rollover. This is the highest percentage of all objects included in the analysis.

8.2.2 Ditches

Ditches are defined as drainage features that are created to channel water. They generally run parallel to the roadway. They are formed by the side slope and backslope planes. Roadside designers must ensure that ditches are wide enough to provide adequate drainage and snow storage capacity. According to [A.20], a ditch deeper than 1 metre and with a side slope steeper than 4:1 is considered hazardous and should be treated in an effective manner.



Figure 57: Examples of hazardous roadside ditches (Source: [A.26])

According to [A.48], 3% of all fixed object crash fatalities are caused by run-offs in ditches. The literature on injury severity caused by ditch accidents is limited.

8.2.3 Road restraint systems

After trees and utility poles, road restraint systems (e.g. steel safety barriers, cable barriers, etc.) are the third most dangerous roadside obstacles [A.48]. Although barrier terminations are most frequently hit, the rails themselves can also be considered roadside hazards. The purpose of a barrier is to prevent a vehicle from running off the road and to protect vulnerable road users from traffic. Median barriers are commonly used to separate traffic travelling in different directions and at high differential speeds.

Safety barriers should be constructed in a way that smoothly redirects impacting vehicles at a low departure angle [A.20]. However, accident studies have shown that redirected vehicles often interact with other vehicles, which results in severe accidents. Furthermore, some barriers are made of rigid or semi-rigid material to prevent run-offs at bridges or other dangerous roadsides. Some countries consider cable barriers a hazardous roadside obstacle, especially for motorcyclists.

Much research has been carried out in this area, and there is little or no evidence that cable barriers/wire rope safety barriers are any more dangerous for motorcyclists than the normal metal Armco barriers. It is the poles that hold up the wire rope safety barrier and the Armco barrier that are the problem for motorcyclists. When motorcyclists fall off their bikes, they are usually sent sliding along the road, in which case poles are their main concern. On the contrary, wire rope safety barriers are a lot more forgiving than either concrete barriers or metal Armco barriers because they deflect and absorb the energy of the impact, while still containing the vehicle. As such, they should not be considered any more of a hazard than any other safety barriers (see Figure 58).

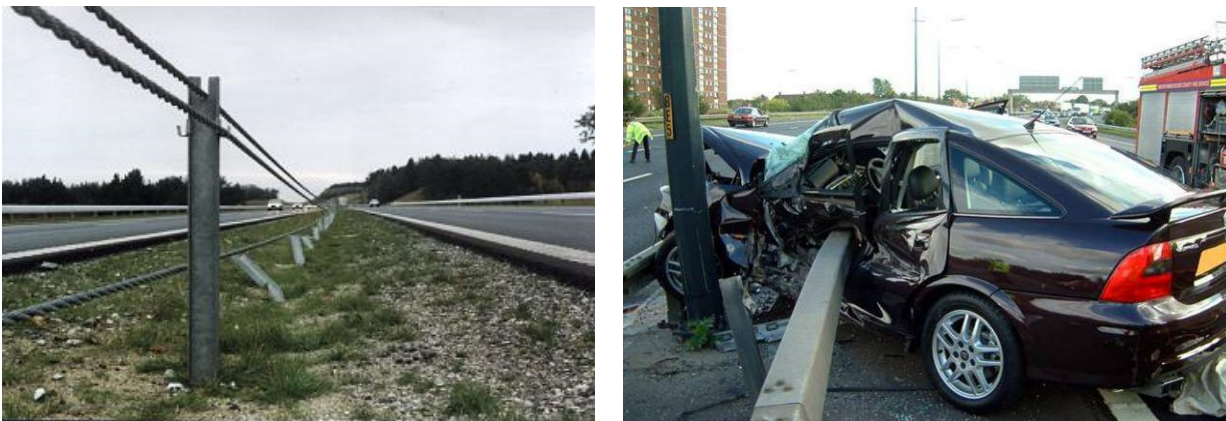

Figure 58: Examples of collisions with safety barriers (Source: [A.10], [A.49])

8.2.4 Kerbs

In many urban environments, roadway shoulders are not practicable as a roadside treatment. Instead, kerbs are commonly used to prevent run-off-accidents. A kerb is typically the edge between a footpath and a roadway and consists of concrete, asphalt, or a line of kerbstones. One purpose is to prevent motorists from driving onto the roadside, while the other purpose is to ensure an efficient drainage of the roadway. It should be noted that kerbs—like road restraint systems—are a treatment to improve roadside safety, but can simultaneously prove a hazard for motorists. A summary of studied safety aspects of kerbs in [A.22] includes the finding that kerbs do not have the ability to redirect vehicles upon impact. The most significant factor influencing a vehicle's trajectory is kerb height. Improper kerb design may lead to an impact with a second obstacle such as other vehicles or can cause vaulting of the vehicle.

8.2.5 Permanent water bodies

The term 'permanent water body' describes rivers, lakes, canals, or small ponds that are located on the roadside. When a vehicle enters the water body, the main hazard, which is the risk of drowning, arises.

8.2.6 Other continuous obstacles

During the drafting of this report, a discussion arose as to whether forests should be included as continuous obstacles or not. The RISER guidelines distinguish between trees and a line of trees, since the treatments to improve them may differ. A whole line of trees, often planted for aesthetic reasons, is not as practical to remove or relocate as a single tree. Thus, they must be shielded using safety barriers.

Other distributed hazards could be unshielded pipelines or rigid structures such as continuous walls. Rock outcrops may be considered continuous as well.

8.3 Dynamic roadside hazards

In [A.22], the term 'dynamic roadside features' is used. This covers:

- bicycle facilities,
- pedestrian facilities and
- parking

In contrast to the hazards presented in Chapter 8.1 and 8.2, dynamic hazards are not fixed but moving. Dynamic roadside features are more prevalent in urban environments, which are generally more complex than rural roadsides. The literature regarding the relationship between dynamic roadside elements and roadside safety is limited. On the one hand, bicycle lanes or footpaths provide an additional clear zone for drivers. On the other hand, bicycle hardware such as racks may be a potential hazard for drivers. However, the risk concerns the pedestrians using the footpath rather than the drivers of vehicles. This leads to a different approach to roadside treatments, since the persons moving along the roadside must be protected. A study conducted by Stutts and Hunter for the FHWA [A.11] determined that 11% of all pedestrian-vehicle crashes recorded occurred at roadside locations such as footpaths or car parks.

In many urban environments, on-street parking is necessary and takes up approximately 2.4 metres space along the roadside. This results in a reduction of the travel lane width as well as limited possibilities for clear zones. The risk of accidents caused by vehicles attempting to pull in or out of a parking space may rise, and sight distances are shortened. There is a need for treatments to ensure proper sight distances and safe separation of the travel lane and parking lots.

9 Treatments to make roadsides forgiving

In the previous chapter, a large number of potential hazards that affect roadside safety were described. This chapter deals with treatments for those hazards, considering three types of strategies to improve roadside safety:

1. the removal and relocation of obstacles (see Chapter 9.1),
2. the modification of roadside elements (see Chapter 9.2), and
3. the shielding of obstacles (see Chapter 3.3).

In literature, delineation is often mentioned as a treatment if all of the three above-mentioned measures are unfeasible. Delineation can help a driver to avoid hitting roadside hazards. However, this measure is not included as a separate chapter because it is a strategy for self-explaining roads, not for forgiving roads.

Based on the proposed four steps for the treatment of roadside hazards outlined in [A.23], the following procedure was developed for this report:

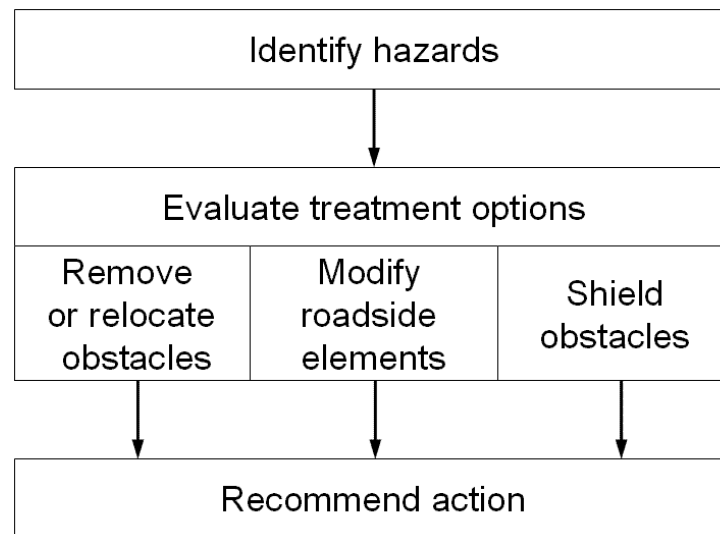

Figure 59: Procedure for forgiving roadside treatments

The three steps in Figure 59 can be applied either on existing roads or in the planning phase for new roads. Potential hazards must also be considered during planning. The treatment may primarily be to provide a clear zone (often called safety zone) on the roadside. On existing roads, hazards can be identified using road safety inspections or accident histories. Moreover, hazards are identified by considering traffic volumes and speeds, road geometry, surface properties, and the expected severity of crashes.

Another approach presented in [A.20] includes an additional step before hazard identification: the determination of the desirable clear zone. Based on data such as design speed, slope information, curvature, topography, or non-removable road furniture, clear zone requirements are identified. The desirable clear zone width is the basis for the removal or relocation of obstacles. In this report, the step in which the clear zone requirements are determined is included in the first category of treatments and will be explained in Chapter 9.1.1.

Several treatment options, which are the main concern of this report, are typically evaluated in a quantitative and qualitative assessment procedure. The assessment of treatments and their effectiveness will be dealt with in work package 2 of the IRDES project and are not described in this deliverable. The evaluation phase may result in a number of options, from which a treatment can be chosen. The outcome is one or more recommended actions, based on a prioritisation of the treatments.

9.1 **Removal and relocation of obstacles**

9.1.1 **The clear zone (safety zone) concept**

The most obvious roadside improvement can be accomplished by providing a clear zone, i.e. providing an obstacle-free area with flat and gently graded ground. In the diagram below, the clear zone is referred to as a 'safety zone'. Removing hazardous roadside features provides motorists with sufficient space and the right conditions to regain control over their vehicles in case of a run-off. Objects that cannot be eliminated should be relocated outside the clear zone. The clear zone can be divided into two areas: the recovery zone (shoulders) and the limited severity zone (see Figure 60).

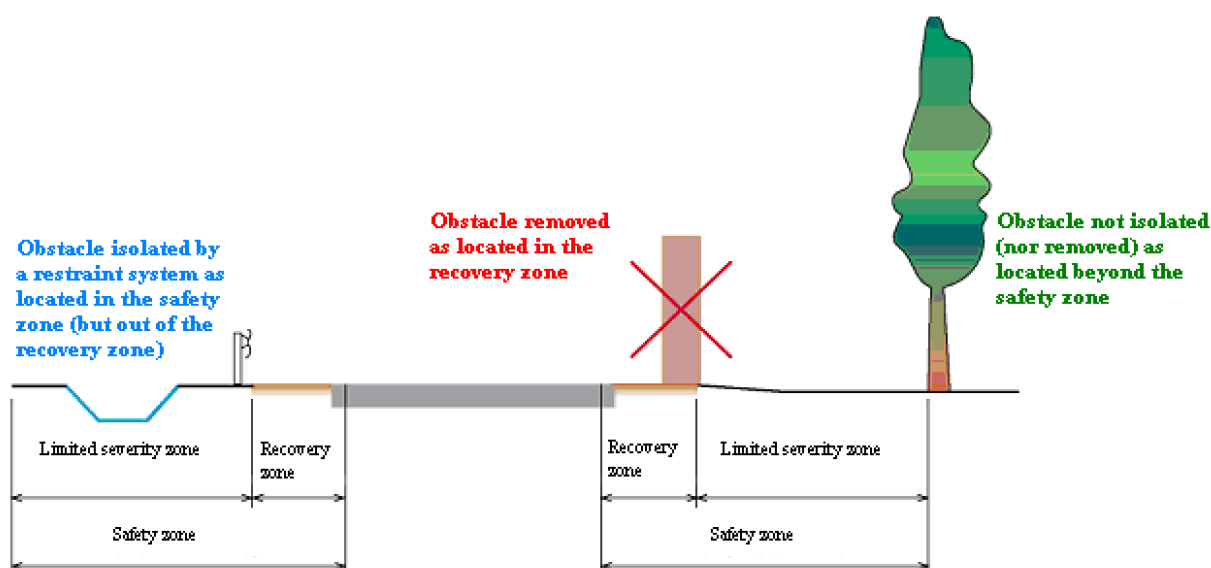

Figure 60: Clear zone definition, as depicted in [A.27]

Many national definitions do not distinguish between these two types of zones, only mentioning the need for a clear zone that may consist of a shoulder, a recoverable slope, a non-recoverable slope, as well as a clear run-off area. However, the two concepts are handled in separate chapters in this report.

The width of clear zones varies throughout the world depending on the underlying policy and practicability. Within the RISER project, the national dimensions for a clear zone of seven different European countries have been determined. Common criteria for dimensioning are:

- design speed
- side slope gradients
- road type
- traffic flow/volume
- horizontal alignment (straight or curved roads)
- driving lane width
- percentage of heavy-vehicles
- evaluation of personal and third party risks

A detailed table of the dimensions in relation to the different parameters can be found in [A.3]. Generally speaking, the higher the design speed, the wider the clear zone should be. The same relation is valid for curve radii. According to [A.23], clear zones also depend on traffic volumes. The widths dependent on speed limits, as defined in five different countries, are depicted in the diagram in Figure 61. In Sweden [A.34], a 'good' clear zone is between 3 m and 14 m wide, depending on curve radius and design speed. The width for clear zones on inner curves is generally lower than on outer curves. A study from Australia indicates that the desirable clear zone width for straight high-trafficked roads with 100 km/h zones is 9 m [A.23].

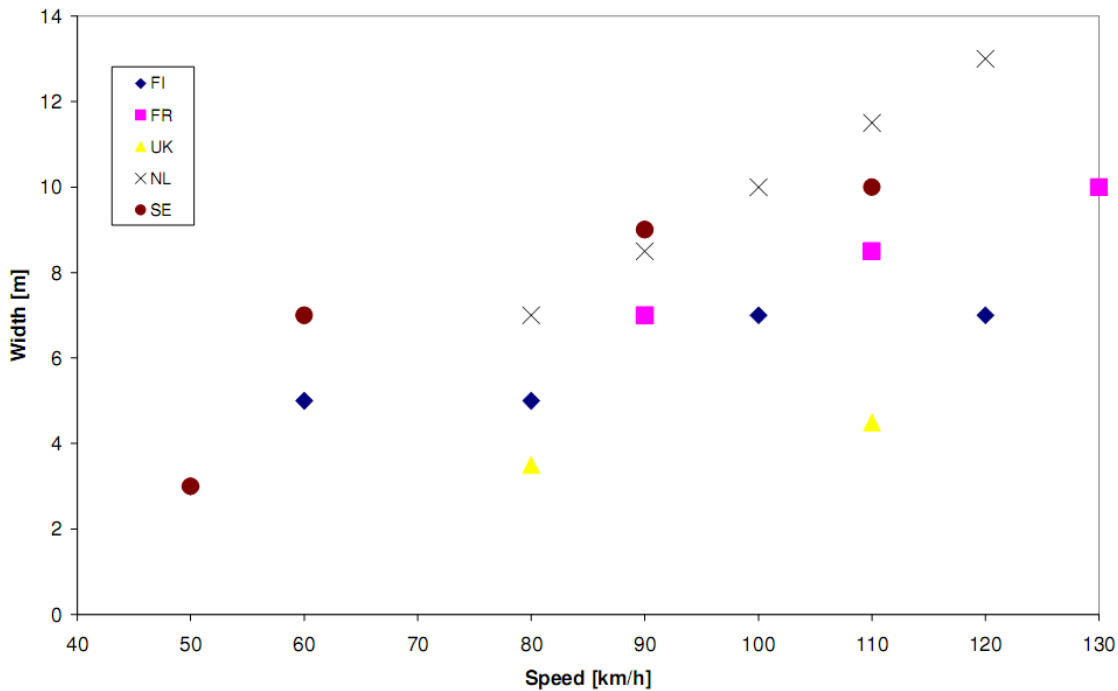

Figure 61: Clear zone widths as a function of speed limit for different countries [A.3]

The calculation method for clear zone widths given in the AASHTO Roadside Design Guide is the most frequently used calculation method worldwide. It is a function of the posted speed, side slope, and traffic volume. For further information see [A.19].

The government of Western Australia proposes a method whereby the width of an appropriate clear zone (safety zone) is determined in three steps [A.23]:

1. Determine the desirable clear zone width (CZ) for a straight road based on the 85th percentile speed and the one-way traffic volume (see Figure 62). In general, the higher the speed and the AADT, the greater the zone width.
2. Multiply the CZ by an adjustment factor F_c , which is a function of operating speed and curve radius (see Figure 63). This factor increases with higher speeds and lower curve radii.
3. Compute a value called effective clear zone width (ECZ) that depends on the roadside slope gradients (see Figure 64). W_B is the width of the sloped side of the section, W_1 is the width from the edge of the traffic lane to the beginning of the slope and W_2 is the width from the toe of the batter.

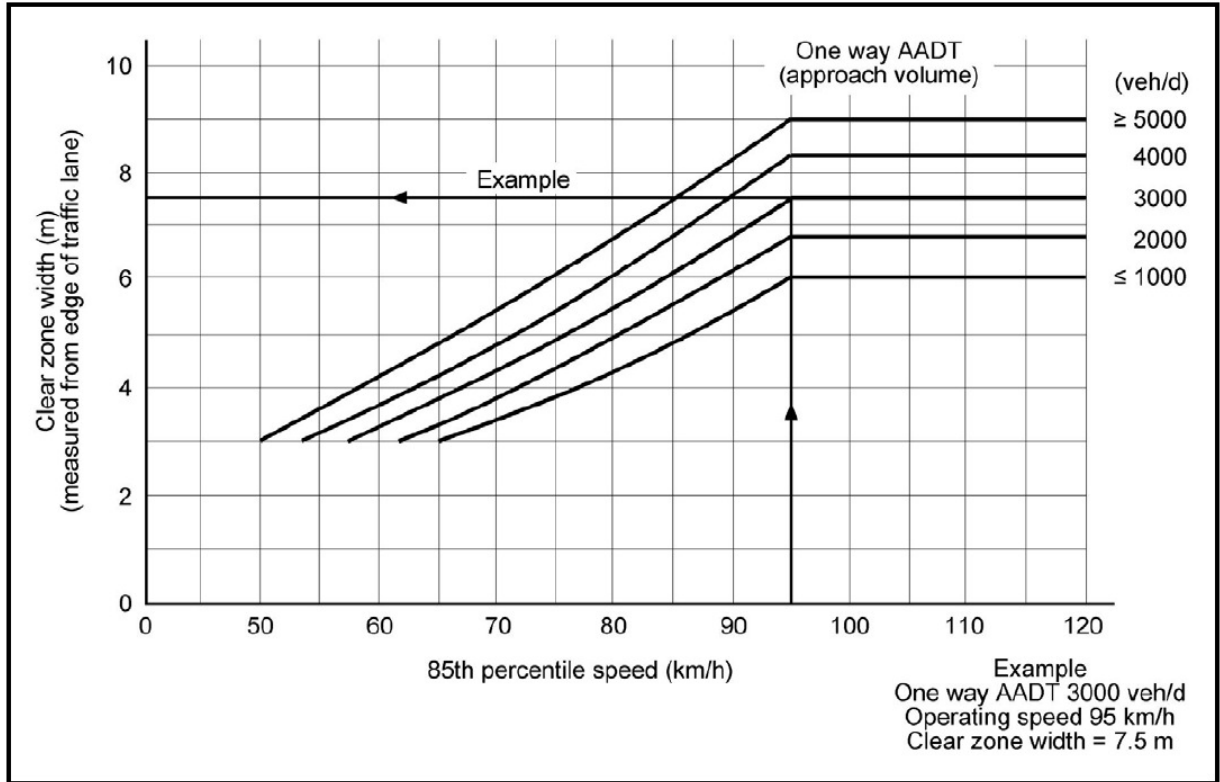

Figure 62: Clear zone distances based on 85th percentile speed and AADT [A.23]

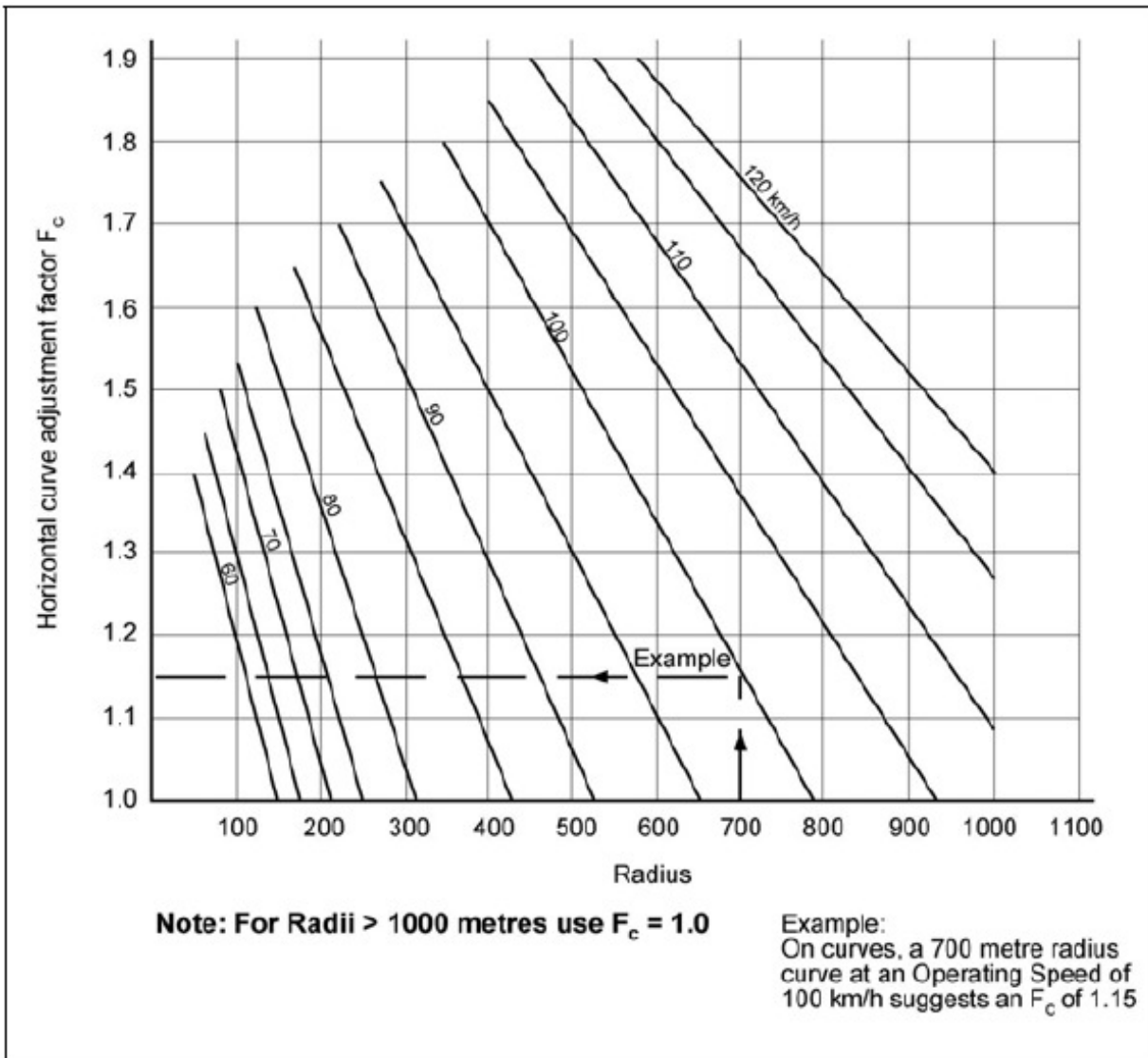

Figure 63: Curve adjustment factors to multiply with the clear zone width [A.23]

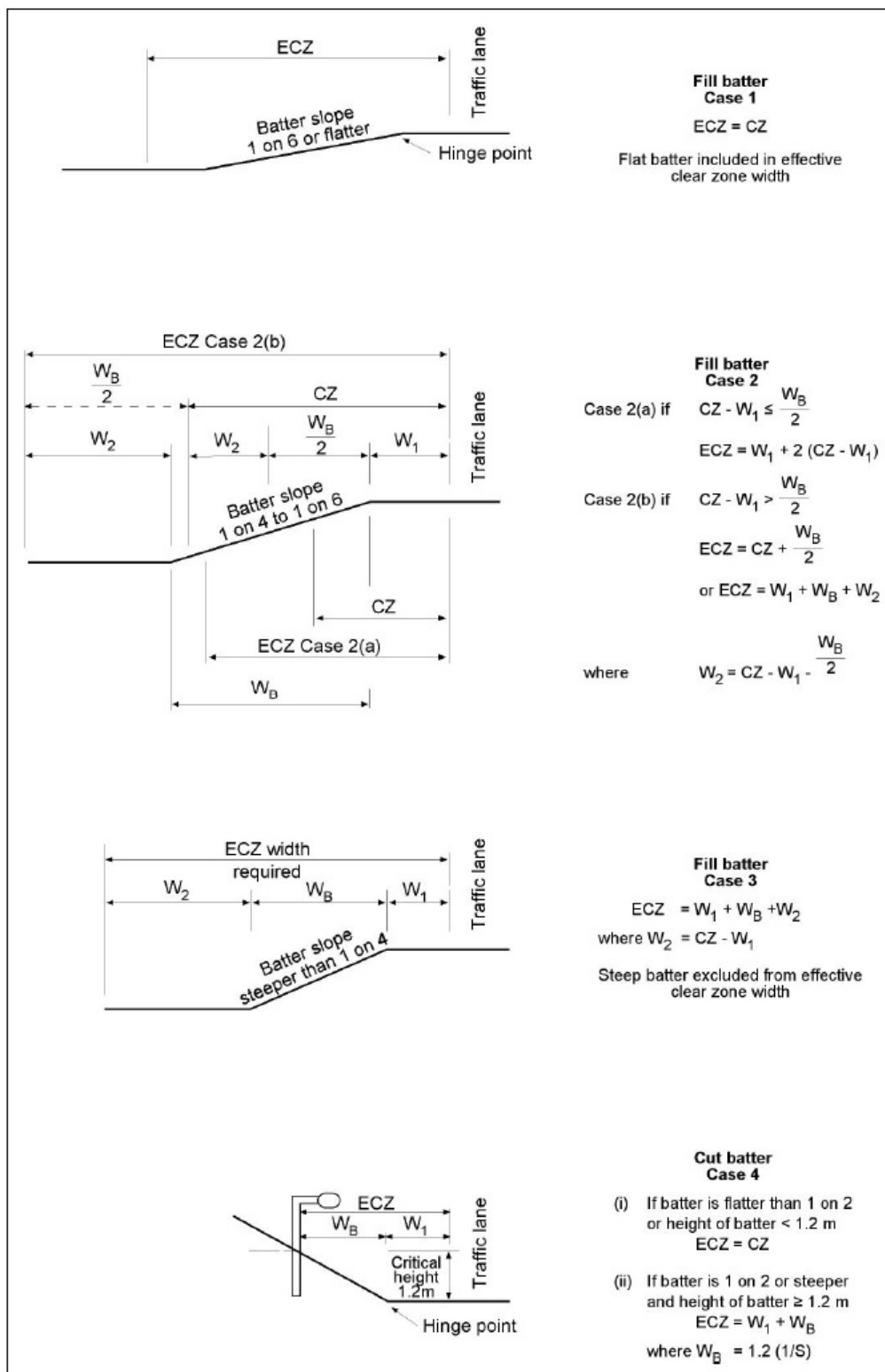

Figure 64: Calculation of the ECZ based on roadside slope [A.23]

Recovery area

According to [A.27], a recovery area is a side strip next to the pavement and is available for road users to perform easy recovery manoeuvres. It must be free of any obstacles so that drivers can return to the travel lane or can stop if necessary. The recovery zone is commonly defined as a hard or soft shoulder lane located immediately beyond the carriageway edge line. In Germany, the recovery zone is defined as a roadside shoulder area for emergency rescue services [A.3]. However, it is not generally considered as a separate issue, but included in the total clear zone. Providing a recovery zone can comprise the following treatments:

- hard shoulder construction
- soft shoulder construction
- enhancement of existing shoulders
- median shoulders

A hard shoulder is a paved surface immediately beyond the carriageway edge line. The skid resistance of the surface should be as good as the carriageway surface in order to avoid skidding accidents. Hard shoulders are commonly used to provide emergency lanes, parking lanes, and bicycle or pedestrian lanes. Several studies have proven the positive effect of hard shoulders on road safety. According to studies conducted by Elvik and Vaa [A.12], rural roads with hard shoulders have an accident rate reduction of about 5 to 10% compared with rural roads without shoulders. An additional advantage of shoulders is the improved sight distances in curves.

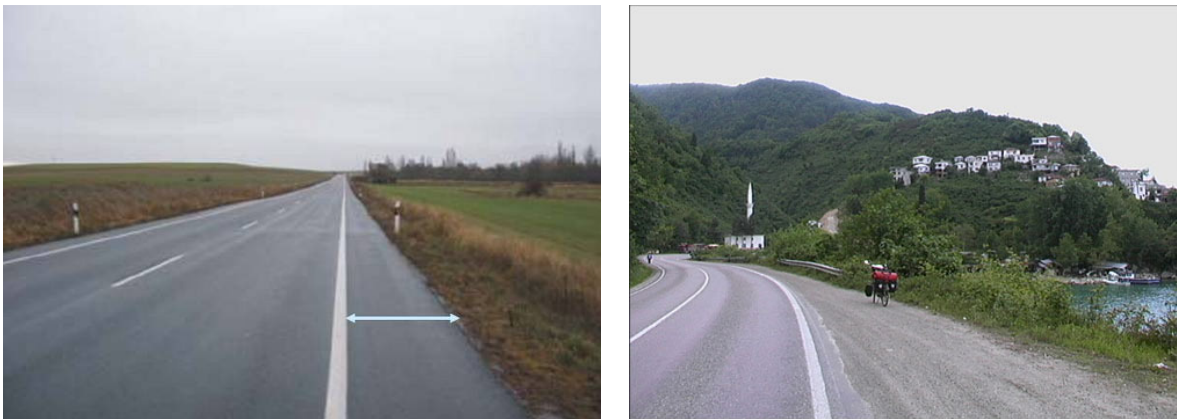

Figure 65: Examples of a hard (*left*) and soft shoulder (*right*) (Source: [A.4])

Examples of hard and soft shoulders are given in Figure 65. In contrast to hard shoulders, soft shoulders are unpaved areas beyond the paved carriageway. In Austria [A.39], for example, the width of unpaved shoulders depends on the travel lane width and varies between 0.25 and 0.5 metres. High drop-offs from paved to unpaved surfaces should be avoided, since they can be a hazard in the event of a run-off. However, this approach is not valid for roads with a high level of traffic, where unpaved shoulders are not allowed. Other elements must be considered such as road geometry, available space, shoulder dimensions, traffic composition, etc.

The dimensions of shoulders have been discussed in great detail by road engineers and safety experts. Instead of solely considering shoulder width as a safety aspect, the interdependencies between number of lanes and lane width need to be analysed. Wider shoulders may encourage higher driving speeds. For countries where the recovery zone is clearly stated as a separate issue, the widths vary between 0.25 and 4 metres, depending on the road type, travel lane width, or design speed. Generally, the higher the design speed of the road, the wider the recovery zone. Based on the intended usage of the recovery zone, widths of between 1 and 1.5 metres are recommended for the recovery of errant vehicles and 3 to 4 metres for emergency lanes.

Limited severity zone

Some guidelines distinguish between the recovery area and the rest of the clear zone. The purpose of the so-called 'limited severity zone' is not to attempt to prevent vehicles from leaving the road, but to minimise the severity of the accident in the event of a run-off. It is defined as the area beyond the recovery zone that is still part of the clear zone.



Figure 66: A broad limited severity zone, but a narrow recovery area [A.27]

Any hazardous obstacle should be removed from this zone. This includes the removal of any single hazards such as poles, light supports, or trees, as well as continuous hazards such as walls. Since the limited severity zone is not explicitly mentioned in most guidelines and standards, dimensions are not always provided. In some countries, the side slope gradient is taken into account in the zone width.

Median shoulders

The median, also called central reserve, separates travel lanes for traffic travelling in opposite directions. In most documents, the median is not considered part of the roadside, but a separate element. Nevertheless, it has been included in this report because a median can reduce run-off-road accidents or minimise their severity. An additional benefit of medians includes the provision of recovery areas for errant vehicles and emergency stopping. In urban areas, medians are commonly used for pedestrian refuge and traffic control device placement. They can also be planted to improve the visual environment. Past research studies have found three safety trends regarding medians [A.14]:

1. Crashes between vehicles travelling in opposite directions are reduced by medians.
2. Median-related crashes decrease as the median width increases beyond 30 feet (9.1 metres). Up to 30 feet, the crashes increase as the median width increases.
3. The effect of median widths on total crashes is questionable.

The recommended widths vary from country to country because they depend on both the available space and the intended use of the median. According to a Swedish Standard [A.34], medians can be divided into several types:

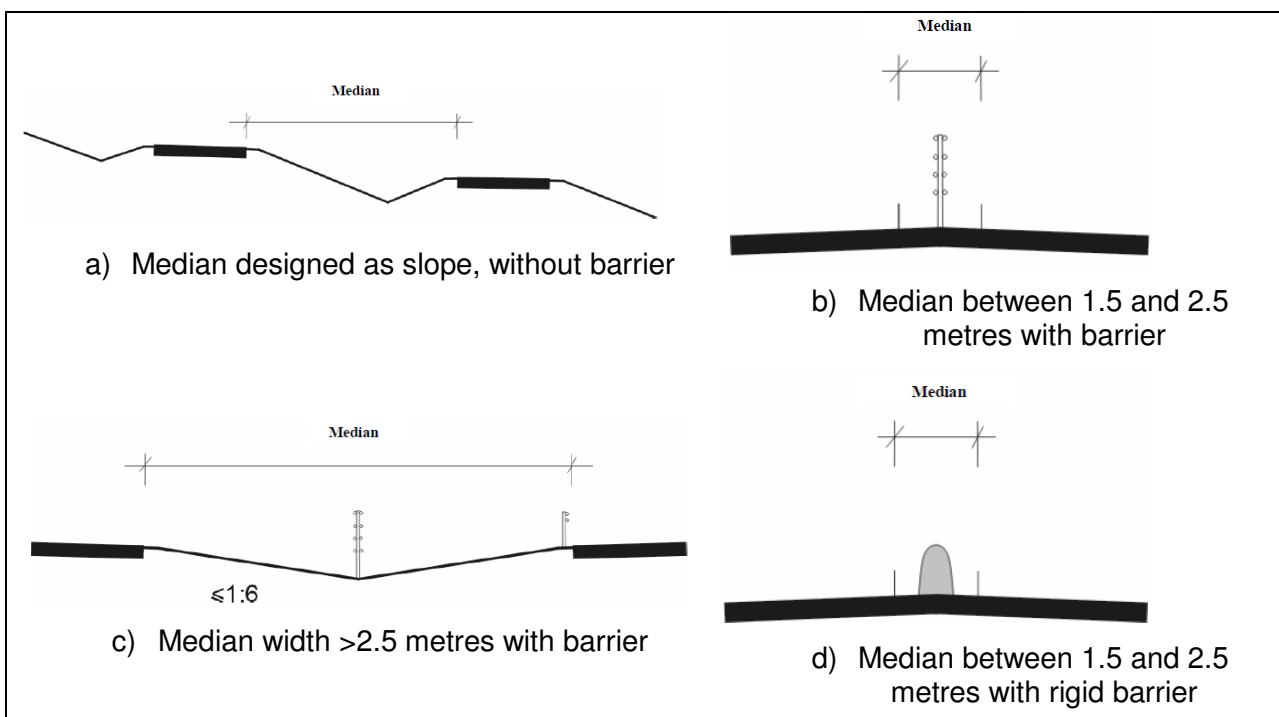

Figure 67: Different types of medians [A.34]

When the median is designed as a slope (upper left-hand picture, Figure 67a), the width can vary, but should be wide enough to separate both carriageways horizontally and in profile. A clear zone should be considered or barriers installed in order to prevent collisions with obstacles.

Figure 67b and Figure 67d depict medians with barriers between 1.5 and 2.5 metres. The two roadways have a common alignment, and the median between is typically paved.

Figure 67c shows a median greater than 2.5 metres with a barrier. The surface can be soft or paved; the slope gradient should not be steeper than 1:4.

A special type of median is a tunnel wall that separates two carriageways. The tunnel wall needs to fulfil the requirements for clear zones and barriers.

9.1.2 Arrester beds in lane diverge areas and emergency escape ramps

Arrester beds in lane diverge areas are treatments for vehicles that have lost their braking ability. They are able to slow down and stop a vehicle going off the road without an impact against a crash cushion and are often used on roads with long downgrades e.g. in mountainous areas. They can also serve as emergency escape ramps or runaway truck lanes when they are designed to accommodate large trucks to prevent roadside accidents. The principal factor for the need of an arrester bed is determined by runaway accident experience. The ramps are often built before a critical change in the curvature of the road, or before a place that may require the vehicle to stop, such as an intersection in a populated area. The surface of the arrester bed is made of a specific material that increases rolling resistance and allows the vehicle to decelerate. Common arrester beds and emergency escape ramps are composed of a layer of granular material of suitable aggregate size and of a shape specifically designed to favour the sinking of vehicle wheels. Examples are given in Figure 68.



Figure 68: Examples of emergency escape ramps [A.50] and arrester beds

There is a lack of specific guidelines dealing with the design of or requirements for arrester beds and emergency escape ramps. Typically, accident statistics, the relation between operation speed and road gradients, or curvature are relevant for the construction of the ramp. To design an arrester bed, a detailed analysis is needed. Length will vary depending on speed and grade. The AASHTO has developed a policy on the geometric design of highways and streets, including design principles for escape ramps [A.42]. The length required by the ramp can be calculated using the equations in Figure 69.

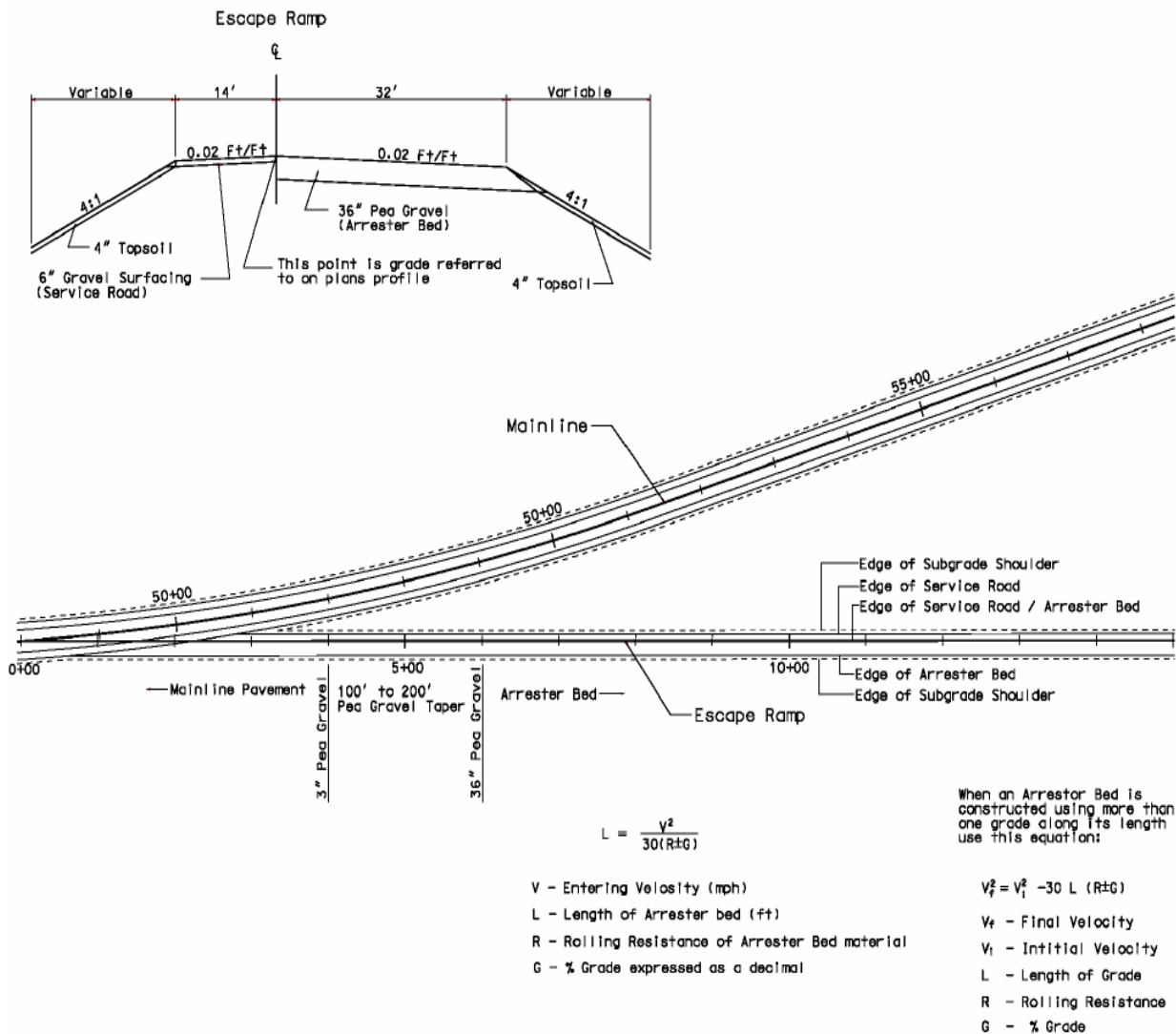

Figure 69: Escape ramp layout [A.42]

9.1.3 Safe plantation

In accordance with the principle of clear zones, hazardous plants or trees should be removed from the specified roadside area. Grass, weeds, brush, and tree limbs can obscure or limit a driver's view of traffic control devices, approaching vehicles, wildlife, livestock, pedestrians, and cyclists. Even if hazardous plants have been removed from the roadside, the growth of plants and mature trees can lead to new roadside obstacles. Controlling vegetation therefore helps to reduce crashes and injuries. Road operators are encouraged to develop roadside vegetation management programmes to eliminate or minimise vegetation. The FHWA of the US Department of Transportation has published a guideline for vegetation control, which includes several treatments such as regular mowing, cutting, or the use of herbicides (see [A.24]). The NCHRP published a guide to eliminate tree collisions or to reduce the harm that results from a collision [A.21]. One major objective of this guideline is to prevent trees from growing in hazardous locations.

9.2 *Modifying roadside elements*

In some cases, hazardous obstacles cannot be removed from the roadside clear zone. In such cases, single and continuous hazards need to be modified in order to minimise injury or property damage in the event of a crash. They must be improved by making them breakaway or crashworthy. The following sections show different treatments for making non-removable objects more forgiving.

9.2.1 **Breakaway devices**

Since the 1980s, road authorities have installed collapsible lighting columns in order to increase roadside safety. The advantage of these columns is the lower likelihood of impact damage and injury; the disadvantage is the fact that the falling pole can be a hazard to surrounding traffic, pedestrians, or property. Non-breakaway poles are still used in cases where pedestrian traffic is high, overhead electric lines are close, or if the pole is mounted on top of a concrete traffic barrier. Nevertheless, breakaway poles are preferred in most roadside areas. There are several strategies to make poles or posts 'forgiving'. This can be achieved by the following modifications:

- *Material use*: the most obvious way to increase energy-absorbance is to use materials with low stiffness. Wooden poles or posts should therefore be avoided. Poles made of fibreglass that absorb energy over their entire length are a good compromise between energy-absorbance and safety. The poles crack without having a predetermined breaking point.
- *Splicing*: if the predetermined breaking points are not correctly located in the pole or post this can result in vehicle snagging and flying parts. In order to achieve a safe breakaway, splices should be kept close to the ground. According to [A.35], multiple splices should be avoided.
- *Slip-base poles*: a characteristic of slip base poles is that when impacted at normal operating traffic speeds, they are generally dislodged from their original position. This enables the pole to slip at the base and fall if a collision occurs.
- *Breakaway transformer base*: a transformer base, commonly made of cast aluminium, is bolted to a concrete foundation. The bottom flange of the pole is bolted to the top of the transformer base. The aluminium is heat-treated to make it 'frangible', so that the pole can break away from the base when struck by a vehicle.
- *Breakaway connectors*: when breakaway poles are used, the electrical conductors must also be breakaway. This is accomplished by using special pull-apart fuse holders (breakaway connectors). In the case of breakaway poles, the neutral must also have this breakaway connector but should be unfused. Breakaway connectors are fused or unfused connectors in the base of poles.

The Texas Department of Transportation has published a highway illumination manual (see [A.52]) that includes specific guidelines for the placement and use of breakaway devices. According to the manual, the falling area must be considered in the placement of breakaway poles. To prevent secondary accidents due to falling poles, they should be placed so that a sufficient falling area is ensured.

9.2.2 Ditch and slope treatments

Ditches are used as drainage features on roadsides. They usually consist of a foreslope, a ditch bottom with or without drainage features, and a backslope. If ditches are considered hazardous, they need to be modified to increase safety. Based on the shape of the ditch, there are several state-of-the-art treatments:

- *Buried drainage*: Usually, drainage is necessary and thus cannot be removed. An effective treatment is to fill the ditch with draining materials after fitting a collector. This eliminates any hazardous side slopes from the clear zone.
- *Modify slope ratio*: if a ditch cannot be removed, the slopes should be kept as shallow as possible. In general, the steeper the foreslope or backslope, the higher the risk for drivers of errant vehicles. So-called recoverable side slopes permit the driver to regain control over the vehicle. Recoverable slopes have a slope ratio of 4:1 or flatter. For higher traffic volumes, side slopes should be designed with a 6:1 ratio. Although the influence of backslopes is generally less than that of foreslopes, a ratio of 3:1 or flatter is recommended [52]. Examples of safe ditches are depicted in Figure 70.
- *Bottom modifications*: ditch bottoms can either be sloped or flat. Thomson and Valtonen [A.17] investigated the behaviour of errant vehicles in V-shaped ditches. They proved that rounding the bottom prevents vehicles from rolling over. As a conclusion, they recommend a round-bottomed ditch with a foreslope of 4:1 and backslope 2:1. Ditches must be designed wide enough to provide adequate drainage and snow storage capacity. For reasons of safety, the width of the bottom should be at least 1 metre. In [A.20], a minimum width of 1.2 metres is preferred. Very shallow and wide ditch bottoms may require additional buried drainage.
- *Cover ditches*: another common treatment is to cover the ditch with gutters or any other drainage system. This is particularly recommended at roadsides where a deep ditch is needed. Examples are given in Figure 71.
- *Modify masonry structures in ditches*: ditches often include drainage features such as culverts, kerbs, or control dams, which are made of rigid, non-energy-absorbent material. These structures need to be made crashworthy by modifying their shape.
- *Isolate the most dangerous ditches*: isolating ditches means shielding them from errant vehicles. The space required for an adequate road restraint system must be taken into account. This type of treatment is discussed in Chapter 9.3.
- *False cutting*: this is a shape of road embankment that is able to create a ground division between road section and external environment so that the roadside appears to drivers like a cutting, such as a linear artificial hill. This kind of artificial hill can also provide a beneficial shielding effect for the neighbouring inhabitants.

In 2009, a Finnish report on full-scale crash tests and simulations of ditches and slopes was published. [A.18]

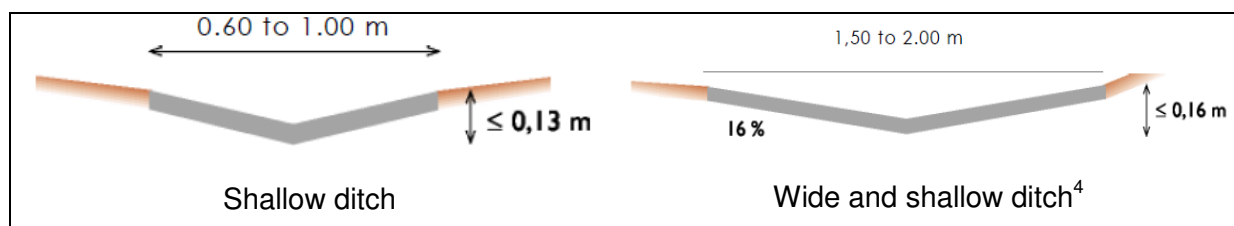

Figure 70: Examples of safe ditch design [A.27]

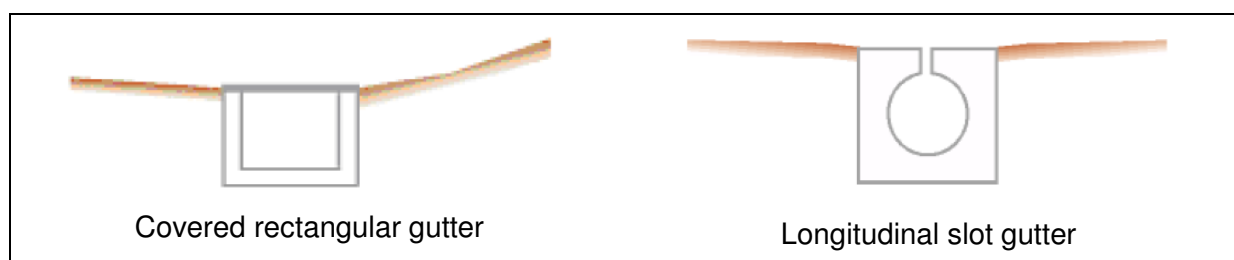

Figure 71: Examples of covered ditches [A.27]

9.2.3 Crashworthy masonry structures

Masonry structures such as parapets, culverts, or kerbs can often be found on roadsides, especially at ditches or bridges. They generally demonstrate minimal energy-absorbance and are, therefore, very hazardous obstacles for errant vehicles. If they cannot be removed from the clear zone, these structure need to be modified in an appropriate manner. Other masonry structures such as bridge piers, walls, or buildings that cannot be removed or relocated, should be shielded with a road restraint system. Isolating or shielding the obstacles—which is the most appropriate strategy—is addressed in Chapter 9.3. This chapter deals with treatments to modify masonry structures in order to make them crashworthy.

If a vehicle runs off the road into a ditch, culvert ends can be hazardous obstacles. If they cannot be removed, safer designs need to be considered. A common treatment for culvert ends is bevelling (see Figure 72).

⁴ In literature, the slope gradient is specified in different ways. Either ratios (e.g. 4:1, 1:4) or percentages are common.



Figure 72: A bevelled culvert end (*left*) and a chamfered parapet (*right*) (Sources: [A.2], [A.27])

Short parapets, mostly found at bridges to protect errant vehicles from running off the slope, are hazardous due to their rigidity. If possible, they should be removed or replaced by a lighter barrier. However, in some cases modifying the structure of the parapets is a cheap and easy treatment. When the parapet is too short to protect errant vehicles, it should be extended to an adequate length. The ends of a parapet can be chamfered to minimise the aggressiveness in the event of a collision (see Figure 72). Ideally, the ends have an offset to the outside. This kind of treatment can be applied to any other masonry structure that cannot be removed from the clear zone.

In this report, kerbs are also categorised as masonry structures. They serve as drainage control, pavement edge, or walkway delineation. As mentioned in [A.27], kerbs are not considered obstacles if their height does not exceed 20 cm. However, hitting a vertical kerb may cause an errant vehicle to mount or launch. Therefore, special design treatments of kerbs increase roadside safety. The Transportation Research Board has published guidelines dealing with kerb and kerb-barrier installations [A.46]. When kerbs have to be used on high-speed roads, the shortest possible kerb height and flattest slope should be used to minimise the risk of tripping the vehicle in a non-tracking collision. The shape of the kerb is a safety-relevant feature that depends on the operating speed of the roadway. Vertical kerbs should be used on low-speed roads, since they may cause vehicle roll-overs at high impact speeds. Sloping kerbs are configured such that a vehicle can safely ride over the kerb. They prevent vehicles from being redirected back into the traffic stream and are, therefore, the recommended option on highways and high-speed roads.



Figure 73: A vertical kerb (*left*) and a sloping kerb (*right*)

Often, kerbs are used in combination with road restraint systems. Kerb–barrier combinations have also been researched within the scope of this report. The state of the art is presented in Chapter 9.3.6.

9.2.4 Shoulder modifications

Shoulder treatments that promote safe recovery include shoulder widening, shoulder paving, and the reduction of pavement edge drops. Shoulders may not always be flush with the roadway surface. Such shoulder edge drops can be caused by soil erosion next to the pavement, rutting by frequent tyre wear, or repaving, where material is added to the lane but not to the adjacent shoulder. This hazard needs to be treated by bevelling the edges or by levelling the pavements. It is common to slope the edge at an angle of 45 degrees [A.22].

If the skid resistance of a paved shoulder is insufficient, treatments to increase surface friction should be applied. Moreover, any other hazardous surface damages such as potholes or cracks need to be eliminated from the shoulder.

9.2.5 Modification of retaining walls and rock cuts

According to [A.27], a wall is acceptable in the clear zone if it meets the following conditions:

- longitudinal to the road or almost longitudinal (flare rate < 1/40th);
- no protrusion or edge is likely to block a vehicle, or even better: smooth;
- heights of over 70 cm;
- sturdy enough to withstand an impact.

If a hazardous wall or continuous rock cannot be removed from the clear zone, its extremities need to be treated or isolated if possible. Rough walls or rocks must let the vehicle slide in case of an impact. Therefore, its surface is typically smoothed and cavities between protrusions are filled with masonry. Examples of wall treatments are depicted in Figure 74.

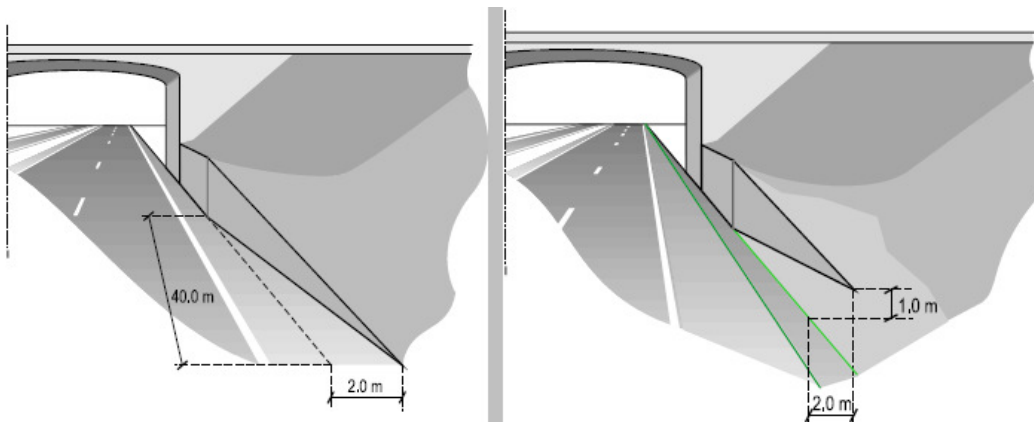

Figure 74: Example of the end design of a retaining wall close to the carriageway [A.34]

9.2.6 Safety barrier terminals

Safety barriers belong to the group of road restraint systems and are explained in more detail in Chapter 3.3, which deals with shielding measures for hazardous objects and locations. In some cases, the modification of existing safety barrier terminals is necessary. First of all, two different types of terminals exist; both differ in their purpose. Terminals can be used to redirect vehicles back onto their original path or to stop them immediately so that they cannot pass through the barrier [A.2]. Depending on the situation, one or the other type can be useful. If the terminals seek to stop the vehicle, they have to be treated as energy-absorbing devices and have to be tested in accordance with ENV 1317-4 (which will be superseded by the new EN 1317-7 standard).

As explained in Chapter 3.3, countermeasures are necessary in those cases where terminals appear as hazards. For rigid barriers (see Chapter 9.3.1), the most probable way to modify the terminal is to make it semi-rigid (see Chapter 9.3.2). This causes the vehicle to crash into a deformable barrier first, which guides the vehicle onto the rigid one. The problem with this installation is the transition between the two barrier types, which will be handled in Chapter 9.2.7. The second option is to use breakaway terminals, so that the terminal breaks and swings back behind the barrier in the event of an impact [A.40]. Also a deflection from the traffic lane towards the roadside is an appropriate measure.

Another possible way of handling hazardous safety barrier terminals is to shield them separately using crash cushions (see Chapter 9.3.6).

9.2.7 Safety barrier transitions

The transition between two safety barriers has to ensure that vehicles slide along the barrier in a smooth way, without any interruption. All necessary information about safety barriers and the various different types can be found in Chapter 3.3.

The transition between semi-rigid (see Chapter 9.3.2) and rigid barriers (see Chapter 9.3.1) in particular has to be stiff enough to avoid a local bending of the more deformable barrier in the junction between the two devices, as shown in Figure 75 [A.40].



Figure 75: Transition between semi-rigid and rigid barrier [A.40]

The transition between a flexible barrier (see Chapter 9.3.3) and a semi-rigid barrier is commonly constructed by overlapping the flexible barrier in front of the semi-rigid barrier. This leads vehicles to slide onto the semi-rigid barrier in a smooth way. The same installation can be used when flexible and rigid barriers are connected.

9.3 Shielding obstacles

In many cases, it is neither possible nor economically advisable to remove or modify hazardous objects. To prevent collisions between vehicles and these objects, the third option is to shield them using road restraint systems (RRS, also called Vehicle Restrain Systems, VRS). With these systems, the hazardous object is fully protected; deviating vehicles crash into the RRS, which alleviates the consequences of the impact. These systems can themselves be hazardous objects, but the severity of the accidents should still be less than if no RRS was used. Road restraint systems are divided into vehicle-restraint and pedestrian-restraint systems as depicted in Figure 76.

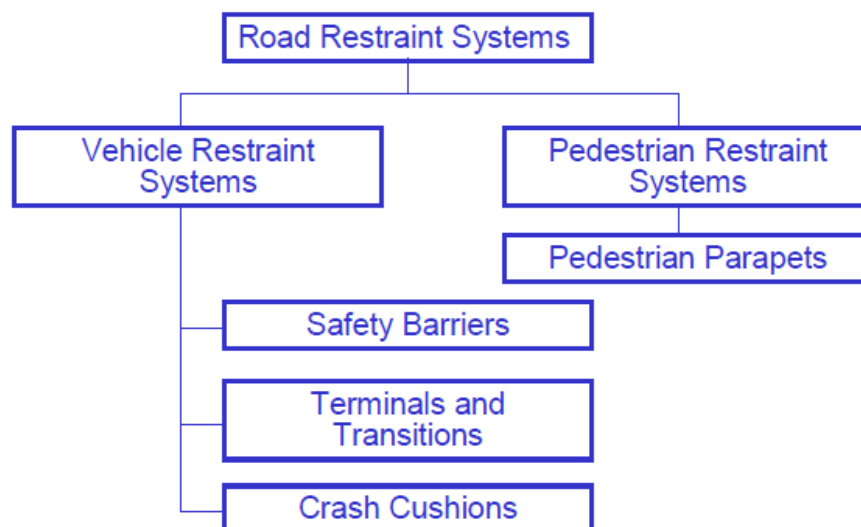

Figure 76: Classification of road restraint systems [A.13]

The most important type of RRS are safety barriers. They prevent errant vehicles from leaving the traffic lane and therefore minimise the probability of collision with a hazardous object. They can be installed either at the roadside or at the median. The purpose of an RRS is to protect drivers and passengers of errant vehicles and to prevent collision with opposing traffic. Moreover, they prevent pedestrians and cyclists from getting onto the road or falling off a dip or into water. In addition to their restraint function, they also redirect vehicles back onto their original path so that they can more easily continue their movement. The effectiveness of an RRS is evaluated on the basis of the following criteria:

- the containment level of the RRS
- impact severity
- deformation or working width

The purpose of safety barriers is to prevent vehicles from passing through (i.e. over or under the barrier) and to reduce the severity of crashes. This can be achieved by making the barrier deformable or moveable. For this reason, safety barriers are divided up into three main groups according to their deflection level (these groups will be addressed later on in greater detail):

- rigid
- semi- rigid
- flexible

The deformation criteria state that traffic barriers should remain intact after an impact and that any possible debris should not cause damage to vehicle occupants.

Detailed requirements relating to RRSs are regulated in the European standards of the series EN 1317. These are subdivided into following eight parts:

- Part 1: Terminology and general criteria for test methods [A.29]
- Part 2: Performance classes, impact test acceptance criteria and test methods for safety barriers [A.30]
- Part 3: Performance classes, impact test acceptance criteria and test methods for crash cushions [A.37]
- Part 4: Performance classes, impact test acceptance criteria and test methods for transitions of safety barriers (draft) – *part of the 'old' Part 4* [A.31]
- Part 5: Product requirements and evaluation of conformity for vehicle restraint systems [A.32]
- Part 6: Pedestrian restraint system – Pedestrian Parapet [A.41]
- Part 7: Performance classes, impact test acceptance criteria and test methods for terminals of safety barriers (draft) – *part of the 'old' Part 4* [A.33]
- Part 8: Motorcycle road restraint systems which reduce the impact severity of motorcyclist collision with safety barriers (draft) [A.36]

The EN 1317 standards are tools that support road designers by providing them with standardised comparisons of various RRSs. It does not give advice on which RRS to use in specific situations. This is handled in guidelines such as the RISER document [A.2] even though there is currently a lack of a uniform European guidelines for the selection of the appropriate road restraint system; the use of safety barriers and other restraint systems is usually subject to national regulations and standards with which the designer must comply.

9.3.1 Rigid barriers

Rigid barriers are commonly made out of concrete. They retain their shape and position when hit by a vehicle, leading to heavy impacts. They provide a high containment level without any deflection under impact. On the other hand, the advantage of rigid barriers is the small space consumption, since they do not deflect at all. This is of particular interest for median installations where the barrier is close to the traffic lane, as Figure 77 (*left*) shows.



Figure 77: Examples of rigid median barriers [A.40]

Typical applications for rigid barriers are high-speed motorways, where total restraint is required. They perform best in the field of containment, but have the disadvantage of a higher injury risk.

9.3.2 Semi-rigid barriers

Semi-rigid barriers are the most common alternative to rigid barriers, since they usually cause less severe accidents. They are typically made out of steel. Semi-rigid barriers have two main functions. On the one hand, they prevent errant vehicles from passing through. On the other, they absorb the energy of the impact by deformation. This leads to less severe accidents and a better performance in terms of redirection. However, subsequent collisions with other vehicles or obstacles may occur due to redirection. The most commonly used type of semi-rigid barrier is the W-beam, which can be seen in Figure 78. Concrete modular barriers which can be deformed when hit by a vehicle are also considered to be semi-rigid barriers.



Figure 78: A typical median W-beam installation [A.40]

9.3.3 Flexible barriers

Typical examples of flexible barriers are cable barriers and safety fences. Flexible barriers cause the least damage to vehicles and pose the smallest risk of injury to vehicle occupants compared with all other barrier types. The main disadvantage of flexible barriers is that they require more space behind them, since they can deflect by up to three metres. Moreover, the slope in the area of deflection should be flat enough to ensure secure redirection performance. Like semi-rigid barriers, flexible barriers may cause crashes where a vehicle is deflected from a barrier and subsequently collides with another vehicle or obstacle.

9.3.4 Temporary safety barriers

Temporary barriers are mainly used to shield construction sites from traffic and therefore have a limited lifetime. They are made out of steel, concrete, and nowadays frequently plastic polymers. One of the main differences between temporary and permanent barriers is the anchorage. Temporary barriers have to be placed individually, since working sites are restricted in terms of both their space and duration. For this reason, they cannot be integrated into the road infrastructure as permanent barriers, which leads to the second difference between temporary and permanent barriers, namely that they do not offer the same level of protection. However, safety at working sites is mainly determined by other factors. Firstly, the speed at these locations is lower (e.g. as a result of imposed speed limits), so that the impacts on barriers are initially lower. Secondly, one or more lanes are usually closed, which leads to more careful driving behaviour.



Figure 79: Common temporary safety barriers (Sources: [A.40], [A.54])

9.3.5 Under-riders

Steel safety barriers increase the likelihood of motorcyclists being injured or even killed. The problem is that motorcycles have no crush zone to reduce the impact of the vehicle on the barrier and the motorcyclist usually falls off the bike during the accident. Typically, collisions with the posts of barriers are a main injury factor, when the rider slides into the restraint system. Other risk sources are the upper and lower edges, as well as too low a mounting height.

Another problem is that motorcyclists can slide through the barrier and crash into a hazardous object behind (e.g. tree or steep slope). Safety treatments are so-called 'under-riders', which are mounted at the bottom of the barrier and prevent the motorcyclist from passing through the barrier, as well as being a shield against posts and edges [A.38].



Figure 80: Examples of under-riders leading to a continuous shape (Source: [A.38])

Any under-rider applied to a safety barrier will modify its behaviour. Under special circumstances, they could decrease the overall safety outcome of the protection system. Any barrier with an under-rider will, therefore, have to be tested in accordance with EN 1317-8 (when available) or with a national standard (as in Italy, Spain, etc.).

9.3.6 Kerb–barrier combinations

Guidelines for the use of kerbs in conjunction with barriers as well as research papers dealing with safety of kerb–barrier combinations have been investigated within the scope of this report. Generally, it is not desirable to use barriers in conjunction with kerbs. Instead of installing barriers, clear zones free of any roadside obstacles are recommended. Inadequate design of the kerb–barrier combination can result in vehicles passing over or under barriers. The following properties as well as their interdependencies need to be considered for improving roadside safety:

- kerb height
- kerb shape or slope
- offset distance from kerb to barrier
- barrier type
- barrier height

According to [A.46], the roadside designer should consider a maximal kerb height of 100 mm when using barriers alongside. The kerb slope should be 1:3 (vertical:horizontal) or flatter. Barriers installed behind kerbs should not be located closer than 2.5 metres from the kerb if the road operating speed is greater than 60 km/h. This minimal distance is needed to allow the vehicle suspension to return to its pre-departure state, where impacts with the barrier should proceed successfully without vaulting it. However, in some European countries (e.g. Austria), it is common to place the kerb under the barrier, i.e. the kerb is flush with the face of the barrier. Figure 81 depicts a design chart for kerb–barrier combinations. Most roadside design guidelines do not recommend using rigid barriers in combination with kerbs.

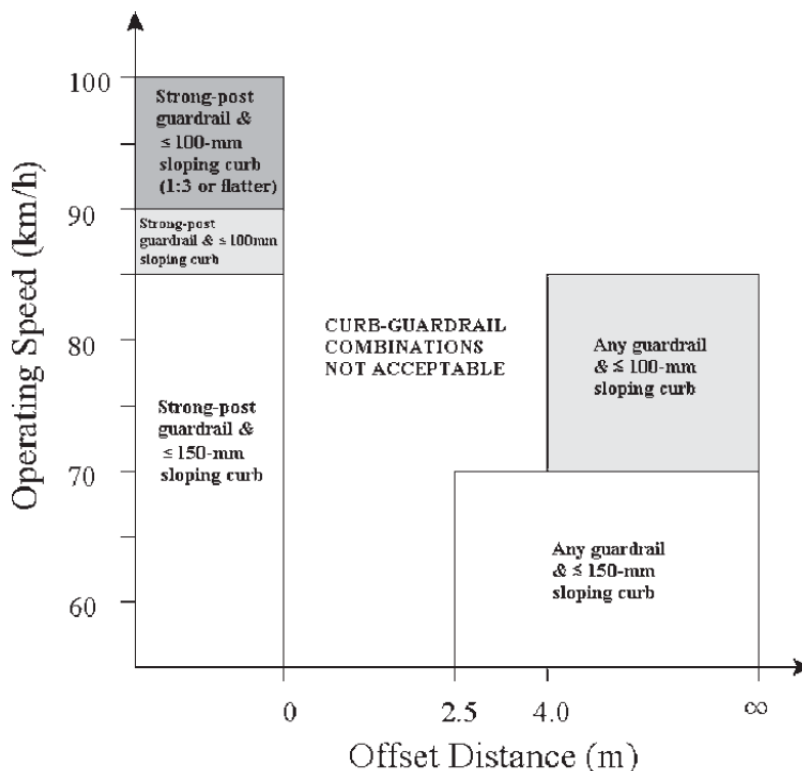

Figure 81: Kerb–barrier combinations by operating speed and offset distance [A.46]

9.3.7 Impact attenuators

Impact attenuators or crash cushions are restraint systems that are used to reduce the consequences of crashes with point obstacles. The protection of terminals and transitions can also be treated using this measure. They are typically protected in all directions, so that they can be better customised than barriers. In any case, they should only be used if safety barriers are not possible at all or an appropriate installation cannot be reached.

Crash cushions can be distinguished by the absorption method used as follows:

- multiple plastic boxes, made heavier by internal bags filled with salt, water or foam and connected with steel cables;
- sack devices, made from synthetic fibre sacks containing cylindrical sink elements, filled with expanded clay, linked together and leaning against lightened steel cusp;
- valved tubes, protected by sliding steel blades and connected with steel cables.

Examples of common impact attenuators are depicted in Figure 82.



Figure 82: Examples of crash cushions (Sources: [A.2] and [A.51])

Several factors should be considered when positioning impact attenuators. The attenuator should be placed on a level surface or on a slope no greater than 5%. The surface should be paved, bituminous, or concrete without any kerbs in the vicinity of the attenuator. The orientation angle depends on the design speed or the alignment of the road.

10 Identification of further research needs

In most countries, the primary strategy for providing a clear zone (also known as a 'safety zone') of a certain width that allows drivers to regain control over their errant vehicles and return to the lane or stop is the removal of obstacles. Clear zones should be considered during the planning phase for a new road in particular. They should be free of obstacles and have a flat and gently graded ground.

Road operators are also encouraged to develop roadside vegetation management programmes to eliminate or minimise vegetation.

It is recommended that the clear zone width be considered as a function of the posted speed, side slope, and traffic volume. However, some guidelines also include curve radii in their calculations. The AASHTO Roadside Design Guide introduced a calculation method for defining the clear zone widths. This is the most widely used calculation method worldwide. The clear zone includes the shoulder width, but there are several national standards regarding shoulder widths and their surface properties. There is a lack of standards concerning the so-called limited severity zone (the area beyond the shoulder).

To prevent vehicles from colliding with obstacles, the final option is to shield these obstacles using road restraint systems (RSS). Detailed requirements for RRSs are included in the European standard (EN) 1317. However, this standard does not give advice on which RRS to use in specific situations. This is addressed in specific guidelines such as the RISER documents. However, there is currently a lack of a uniform European guideline for the selection of the appropriate road restraint systems. The use of safety barriers and other restraint systems is usually subject to national regulations and standards with which the designer must comply.

Future uniform European guidelines should also include recommendations for kerb–barrier combinations as well as safe motorcycle restraint systems. Standards concerning these topics are currently under development.

The large number of possible treatments to make a road forgiving shows the great potential of these systems for increasing road safety. Harmonisation helps road operators and authorities in their decisions to plan safe roads. Common road planning procedures together with Road Safety Audits or Road Safety Inspections on existing roads must include the specific view on forgiving roadsides.

ANNEX A - References

Scientific reports and research papers

- [A.1] P. Waugh. *Forgiving Roadsides – A Way Forward*. Paper presented in *Road Safety: Gearing up for the future*. Perth, WA, August 2001
- [A.2] RISER consortium. *D06: European Best Practice for Roadside Design: Guidelines for Roadside Infrastructure on New and Existing Roads*. RISER deliverable, February 2006
- [A.3] RISER consortium. *D05: Summary of European Design Guidelines for roadside infrastructure*. RISER deliverable, February 2005
- [A.4] G. Dupre and O. Bisson. *Recovery zone*. RISER Seminar on Safer Roadside Engineering. Budapest, Hungary, 30 November 2005
- [A.5] S. Matena et al. *Road Design and Environment – Best practice on Self-explaining and Forgiving Roads*. RIPCORD-ISEREST deliverable D3, 2005
- [A.6] L. Herrstedt. *Self-explaining and Forgiving Roads – Speed management in rural areas*. Paper presented at the ARRB Conference, October 2006
- [A.7] Roads and Traffic Authority NSW. *Fatal Roadside Object Study in Road Environment Safety Update 20*. New South Wales, Australia, March 2004
- [A.8] N.J. Bratton and K.L. Wolf. *Trees and Roadside Safety in U.S. Urban Settings*. In *Proceedings of the 84th Annual Meeting of the Transportation Research Board*. Washington D.C., USA, January 2005
- [A.9] K.K. Mak and R.L. Mason. *Accident Analysis – Breakaway and Non-Breakaway Poles Including Sign and Light Standards Along Highways*. FHWA, August 1980
- [A.10] FEMA. *Final report of the Motorcyclists & Crash Barriers Project*. Belgium
- [A.11] J.C. Stutts and W.W. Hunter. *Injuries to Pedestrians and Bicyclists: An Analysis Based on Hospital Emergency Department Data*. FHWA, Washington D.C., USA, 1999
- [A.12] R. Elvik and T. Vaa. *The Handbook of Road Safety Measures*. Emerald Group Pub Norway, 2004
- [A.13] L. Rens. *Brief Overview and Latest Developments concerning EN Standards on Road Restraint Systems*. Technical seminar on concrete safety barriers in Brussels, June 2009
- [A.14] N. Stamatiadis, J. Pigman. *Impact of Shoulder Width and Median Width on Safety*. In *NCHRP Report 633*. Washington D.C., USA, 2009
- [A.15] G. Camomilla. *Una rivoluzione necessaria: la trasformazione dei bordi laterali stradali 'Le Strade' Magazine 7-8-2008*

- [A.16] AITEC. *Cemento e sicurezza; impieghi stradali* CD. December 2006
- [A.17] R. Thomson, J. Valtonen. Vehicle Impacts in V Ditches. In *Transportation Research Record 1797*. Pages 82–88. 2002
- [A.18] Marko Kelkka. Safety of roadside area. Analysis of full-scale crash tests and simulations. Finnish Road Administration, Central Administration. Finnra reports 10/2009, 161 p. +app. 5 p. ISSN 1459-1553, ISBN 978-952-221-142-2, TIEH 3201124E-v, Helsinki 2009

Standards and guidelines

- [A.19] AASHTO. Roadside Design Guide. 3rd edition, March 2002
- [A.20] Alberta Ministry of Infrastructure and Transportation. Roadside Design Guide. Alberta, Canada, November 2007
- [A.21] T.R. Neuman et al. Volume 3: A Guide for Addressing Collisions with Trees in Hazardous locations. NCHRP Report 500. Washington D.C., USA, 2003
- [A.22] Transportation Research Board. Safe and Aesthetic Design of Urban Roadside Treatments. In NCHRP Report 612. Washington D.C., USA, 2008
- [A.23] Government of Western Australia. Main Roads Western Australia Assessment Of Roadside Hazards. Technology and Environment Directorate. Western Australia, May 2007
- [A.24] R.W. Eck and H.W. McGee. Vegetation Control for Safety, A Guide for Local Highway and Street Maintenance Personnel. Federal Highway Administration (FHWA). U.S. Department of Transportation, August 2008
- [A.25] W.J. Fitzgerald. W-Beam Guardrail Repair: A Guide for Highway and Street Maintenance Personnel. Federal Highway Administration (FHWA). U.S. Department of Transportation, November 2008
- [A.26] H.W. McGee and D. Nabors and T. Baughman. Maintenance of Drainage Features for Safety, A Guide for Local Street and Highway Maintenance Personnel. U.S. Department of Transportation, July 2009
- [A.27] L. Patte et al. Handling lateral obstacles on main roads in open country. Sétra Guidelines. November 2002. Translated August 2007
- [A.28] EN 12767, Passive Safety of support structures for road equipment – Requirements and test methods
- [A.29] EN 1317-1, Road restraint systems - Part 1: Terminology and general criteria for test methods
- [A.30] EN 1317-2, Road restraint systems - Part 2: Performance classes, impact test acceptance criteria and test methods for safety barriers including vehicle parapets

-
- [A.31] ENV 1317-4, Road restraint systems — Part 4: Performance classes, impact test acceptance criteria and test methods for terminals and transitions of safety barriers; prEN 1317-4, Road restraint systems – Part 4: Performance classes, impact test acceptance criteria and test methods for transitions of safety barriers (under preparation: this document will supersede ENV 1317-4 for the clauses concerning transitions)
 - [A.32] EN 1317-5, Road restraint systems – Part 5: Product requirements and evaluation of conformity for vehicle restraint systems
 - [A.33] EN 1317-7, Road restraint systems – Part 7: Performance classes, impact test acceptance criteria and test methods for terminals of safety barriers (under preparation: this document will supersede ENV 1317-4 for the clauses concerning terminals)
 - [A.34] Väggar och Gators Utformning (VGU). Road and Street Design. 2004
 - [A.35] U.S. Department of Transportation. Roadside improvements for local roads and streets. Federal highway administration, USA, October 1986
 - [A.36] EN 1317-8, Road restraint systems - Part 8: Motorcycle road restraint systems which reduce the impact severity of motorcyclist collisions with safety barriers (under preparation)
 - [A.37] EN 1317-3, Road restraint systems - Part 3: Performance classes, impact test acceptance criteria and test methods for crash cushions
 - [A.38] FGSV. Merkblatt zur Verbesserung der Verkehrssicherheit auf Motorradstrecken (MVMot) R2. Ausgabe 2007, Germany
 - [A.39] RVS 03.03.31 Querschnittselemente Freilandstraßen, 2005, Austria
 - [A.40] Tasmania Department of Infrastructure, Energy and Resource. Road Hazard Management Guide, 2004
 - [A.41] EN 1317-6, Road restraint systems – Pedestrian restraint systems — Part 6: Pedestrian Parapet (under preparation)
 - [A.42] AASHTO. A Policy on Geometric Design of Highways and Streets (5th Edition). 2004
 - [A.43] Belgian median barrier on National Roads
 - [A.44] ANAS - Linee guida per le protezioni di sicurezza passiva Ed. 2010
 - [A.45] B.A.S.T. Road Safety Equipment and Steel Barrier Systems
 - [A.46] Transportation Research Board. Recommended Guidelines for Curb and Curb-Barrier Installations. In NCHRP Report 537. Washington D.C., USA, 2005
 - [A.47] UNI TR 11370 'Dispositivi stradali di sicurezza per motociclisti - Classi di prestazioni, modalità di prova e criteri di accettazione'

Web references

- [A.48] Insurance Institute for Highway Safety. Fatality Facts 2008, Roadside hazards. Taken from http://www.iihs.org/research/fatality_facts_2008/roadsidehazards.html, visited on 25/02/2010
- [A.49] <http://www.car-accidents.com/guardrail-accidents.htm>, visited on 03/03/2010
- [A.50] Wikipedia. Runaway truck ramp. Taken from http://en.wikipedia.org/wiki/Runaway_truck_ramp, visited on 19/07/2010
- [A.51] CSP Pacific. Taken from www.csppacific.co.nz, visited on 21/07/2010
- [A.52] Texas Department of Transportation. Highway Illumination Manual. Taken from http://onlinemanuals.txdot.gov/txdotmanuals/hwi/manual_notice.htm, visited on 21/07/10
- [A.53] Metropolitan Forestry Consultants, Inc. <http://www.metroforestry.com/resources/RoadsideTrees1.jpg>, visited on 09/08/2010
- [A.54] http://intermountain.construction.com/images/2009/07_indNews_PlasticBarriers.jpg, visited on 09/08/2010

ANNEX B: Glossary

Abutment

The end support of a bridge deck or tunnel, usually retaining an embankment.

Arrester bed

An area of land adjacent to the roadway filled with a particular material to decelerate and stop errant vehicles; generally located on long steep descending gradients.

Backslope (see ditch)

A slope associated with a ditch, located opposite the roadway edge, beyond the bottom of the ditch.

Boulder

A large, rounded mass of rock lying on the surface of the ground or embedded in the soil in the roadside, normally detached from its place of origin.

Breakaway support

A sign, traffic signal, or luminaire support designed to yield or break when struck by a vehicle.

Carriageway

The definition of the 'carriageway' differs slightly from country to country. The edge of the carriageway is delineated by either the 'edge line' or, if no edge line is present, the edge of the paved area.

CCTV masts

A mast on which a closed circuit television camera is mounted for the purpose of traffic surveillance.

Central reserve

An area separating the carriageways of a dual carriageway road.

Clearance

The unobstructed horizontal dimension between the front side of safety barrier (the closest edge to road) and the side of the object facing the road.

Clear zone/safety zone

The area, starting at the edge of the carriageway, that is clear of hazards. This area may consist of none or any combination of the following: a 'hard strip', a 'shoulder', a recoverable slope, a non-recoverable slope, and/or a clear run-off (also called run-out) area. The desired width is dependent upon the traffic volumes, speeds, and on the roadside geometry.

Contained vehicle

A vehicle that comes in contact with a road restraint system and does not pass beyond the limits of the safety system.

Containment level

The description of the standard of protection offered to vehicles by a road restraint system. In other words, the Containment Performance Class Requirement that the object has been manufactured and tested according to EN 1317 standards.

Crash cushion

A road vehicle energy absorption device (road restraint system) installed in front of a rigid object to contain and redirect an impacting vehicle ('redirective crash cushion') or to contain and capture it ('non-redirective crash cushion').

Culvert

A structure used to channel a water course. It can be made of concrete, steel, or plastic.

Culvert end

The end of the channel or conduit, normally a concrete, steel, or plastic structure.

Cut slope

The earth embankment created when a road is excavated through a hill, which slopes upwards from the level of the roadway.

Design speed

The speed which determines the layout of a new road in plan, being the speed for which the road is designed, taking into account anticipated vehicle speed on the road.

Distributed hazards

Also known as 'continuous obstacles', distributed hazards are hazards which extend along a length of the roadside, such as embankments, slopes, ditches, rock face cuttings, retaining walls, safety barriers not meeting current standard, forests, and closely spaced trees.

Ditch

Ditches are drainage features that run parallel to the road. Excavated ditches are distinguished by a foreslope (between the road and the ditch bottom) and a backslope (beyond the ditch bottom and extending above the ditch bottom).

Divided roadway

A roadway where the traffic is physically divided by a central reserve and/or road restraint system. The number of travel lanes in each direction is not taken into account. See also 'dual carriageway'.

Drainage gully

A structure used to collect water running off the roadway.

Drop-off

The vertical thickness of the asphalt protruding above the ground level at the edge of the paved surface.

Dual carriageway

A divided roadway with two or more travel lanes in each direction, where traffic is physically divided by a central reserve and/or road restraint system. See also 'divided roadway'.

Edge line

Road markings that can be positioned either on the carriageway surface itself at the edge of the carriageway, or on the 'hard strip' (if present) next to the carriageway.

Embankment

A general term for all sloping roadsides, including cut (upward) slopes and fill (downward) slopes (see 'cut slope' and 'fill slope').

Encroachment

A term used to describe the situation when a vehicle leaves the carriageway and enters the roadside area.

Energy-absorbing structures

Any type of structure which, when impacted by a vehicle, absorbs energy to reduce the speed of the vehicle and the severity of the impact.

Fill slope

An earth embankment created when extra material is packed to create the road bed, typically sloping downwards from the roadway.

Foreslope (see ditch)

The foreslope is a part of the ditch, and refers to the slope beside the roadway, before the ditch bottom.

Forgiving roadside

A forgiving roadside mitigates the consequences of 'run-off' type accidents and seeks to reduce the number of fatalities and serious injuries resulting from these events.

Frangible

A structure that is readily or easily broken upon impact (see also 'breakaway support').

Guardrail

A guardrail is another name for a metal post and rail safety barrier.

Hard/paved shoulder

An asphalt or concrete surface on the nearside of the carriageway. If a 'hard strip' is present, the hard shoulder is immediately adjacent to it. Otherwise, the shoulder is immediately adjacent to the carriageway. Shoulder pavement surfaces, conditions, and friction properties should be as good as those on the carriageway.

Hard strip

A strip, usually not more than 1 metre wide, immediately adjacent to and abutting the nearside of the outer travel lanes of a roadway. It is constructed using the same material as the carriageway itself, and its main purposes are to provide a surface for the edge lines and to provide lateral support for the structure of the travel lanes.

Highway

A highway is a road for long-distance traffic. It can, therefore, refer to either a motorway or a rural road.

Horizontal alignment

The projection of a road—particularly its centre line—on a horizontal plane.

Impact angle

For a longitudinal safety barrier, the impact angle is the angle between a tangent to the face of the barrier and a tangent to the vehicle's longitudinal axis at impact. For a crash cushion, it is the angle between the axis of symmetry of the crash cushion and a tangent to the vehicle's longitudinal axis at impact.

Impact attenuators

A roadside (passive safety) device which helps to reduce the severity of a vehicle impact with a fixed object. Impact attenuators decelerate a vehicle both by absorbing energy and by transferring energy to another medium. Impact attenuators include crash cushions and arrester beds.

Kerb (US: curb)

A unit intended to separate areas of different surfacings and to provide physical delineation or containment.

Lane line

On carriageways with more than one travel lane, the road marking between the travel lanes is called the 'lane line'.

Length of need

The total length of a longitudinal safety barrier needed to shield an area of concern.

Limited severity zone

An area beyond the recovery zone that is free of obstacles in order to minimise severity in case of a vehicle run-off.

Median

See 'central reserve'.

Motorways

A dual carriageway road intended solely for motorised vehicles that provides no access to any buildings or properties. On motorways, only grade separated junctions are allowed at entrances and exits.

Nearside

A term used when discussing right- and left-hand traffic infrastructure. The side of the roadway closest to the vehicle's travelled way (not median).

Non-paved surface

A surface type that is not asphalt, surface dressing, or concrete (e.g. grass, gravel, soil, etc).

Offside

A term used when discussing right- and left-hand traffic infrastructure. The side of the roadway closest to opposing traffic or a median.

Overpass

A structure including its approaches which allows one road to pass above another road (or an obstacle).

Paved shoulder

See 'hard shoulder'.

Pedestrian restraint system

A system installed to provide guidance for pedestrians, and classified as a group of restraint systems under 'road restraint systems'.

Pier

An intermediate support for a bridge.

Point hazard

A narrow item on the roadside that could be struck in a collision, including trees, bridge piers, lighting poles, utility poles, and sign-posts.

Recovery zone

A zone beside the travel lanes that allows avoidance and recovery manoeuvres for errant vehicles.

Rebounded vehicle

A vehicle that has struck a road restraint system and then returns to the main carriageway.

Retaining wall

A wall that is built to resist lateral pressure, particularly a wall built to support or prevent the advance of a mass of earth.

Road restraint system (RRS)

The general name for all vehicle and pedestrian restraint systems used on the road (EN 1317).

Road equipment

The general name for structures related to the operation of the road and located on the roadside.

Road furniture

See 'road equipment'.

Roadside

The area beyond the roadway.

Roadside hazards

Roadside hazards are fixed objects or structures endangering an errant vehicle leaving its normal path. They can be continuous or punctual, natural or artificial. The risks associated with these hazards include the possibility of having high decelerations on the vehicle occupants or vehicle rollovers.

Roadway

The roadway includes the carriageway and, if present, hard strips and shoulders.

Rock face cuttings

A rock face cutting is created for roads constructed through hard, rocky outcrops or hills.

Rumble strip (shoulder rumble strips)

A thermoplastic or milled transverse marking with a low vertical profile, designed to provide an audible and/or tactile warning to the road user. Rumble strips are normally located on hard shoulders and the nearside travel lanes of the carriageway. They are intended to reduce the consequences of—or to prevent—run-off road events.

Rural roads

All roads located outside urban areas, not including motorways.

Safety barrier

A road vehicle restraint system installed alongside or on the central reserve of roads.

Safety zone

See 'clear zone'.

Self-explaining road

Roads designed in accordance with the design concept of self-explaining roads. The concept is based on the idea that roads with certain design elements or equipment can be easily interpreted and understood by road users. This delivers a safety benefit as road users have a clear understanding of the nature of the road they are travelling on, and will therefore expect certain road and traffic conditions and can adapt their driving behaviour accordingly. (Ripcord-Iserest, Report D3, 2008).

Set-back

Lateral distance between the roadway and an object in the roadside.

Shoulder

The part of the roadway between the carriageway (or the hard strip, if present) and the verge. Shoulders can be paved (see 'hard shoulder') or unpaved (see 'soft shoulder'). Note: the shoulder may be used for emergency stops in some countries; in these countries it comprises the hard shoulder for emergency use in the case of a road with separate carriageways.

Single carriageway

See 'undivided roadway'.

Slope

A general term used for embankments. It can also be used as a measure of the relative steepness of the terrain expressed as a ratio or percentage. Slopes may be categorised as negative (foreslopes) or positive (backslopes) and as parallel or cross slopes in relation to the direction of traffic.

Soft strip

A narrow strip of gravel surface located in the roadside, beyond the roadway (normally beyond a hard strip/shoulder).

Soft/unpaved shoulder

A soft shoulder is defined as being a gravel surface immediately adjacent to the carriageway or hard strip (if present). In some countries it is used as an alternative for hard shoulders.

Termination (barrier)

The end treatment for a safety barrier, also known as a terminal. It can be energy-absorbing structure or designed to protect the vehicle from going behind the barrier.

Transition

A vehicle restraint system that connects two safety barriers of different designs and/or performance levels.

Travel/traffic lane

The part of the roadway/carriageway that is travelled on by vehicles.

Treatment

A specific strategy to improve the safety of a roadside feature or hazard.

Underpass

A structure (including its approaches) which allows a road or footpath to pass under another road (or an obstacle).

Under-rider

A motorcyclist protection system installed on a road restraint system, with the purpose of reducing the severity of a powered two-wheeler (PTW) rider impact against the road restraint system.

Undivided roadway

A roadway with no physical separation, also known as single carriageway.

Unpaved shoulder

See 'soft shoulder'.

Vehicle parapet (on bridges)

A longitudinal safety barrier whose primary function is to prevent an errant vehicle from going over the side of the bridge structure. It can be constructed from either steel or concrete.

Vehicle restraint system

A device used to prevent a vehicle from striking objects outside of its travelled lane. This includes, for example, safety barriers, crash cushions, etc. These are classified as a group of restraint systems under 'road restraint systems'.

Verge

An unpaved level strip adjacent to the shoulder. The main purpose of the verge is drainage; in some instances, it can be lightly vegetated. Additionally, road equipment such as safety barriers and traffic signs are typically located on the verge.

Vertical alignment

The geometric description of the roadway within the vertical plane.

ISBN : 979-10-93321-01-1



La Grande Arche, Sud 19^e
FR – 92055 PARIS – LA DEFENSE
Tel: + 33 (0) 1 40 81 36 87 Fax: + 33 (0) 1 40 81 99 16