

Exp Astron (2011) 31:69–81
DOI 10.1007/s10686-011-9232-7

ORIGINAL ARTICLE

Optical Frequency Comb as a general-purpose and wide-band calibration source for astronomical high resolution infrared spectrographs

Giulia Schettino · Ernesto Oliva ·
Massimo Inguscio · Carlo Baffa · Elisabetta Giani ·
Andrea Tozzi · Pablo Cancio Pastor

Received: 10 November 2010 / Accepted: 8 June 2011 / Published online: 29 June 2011
© Springer Science+Business Media B.V. 2011

Abstract A spectrally filtered Optical Frequency Comb (OFC) laser is proposed as a versatile calibration source for astronomical spectrometers in the 1–2 μm spectral range. Such a source overcomes the limitations of current calibration lamps providing a uniform spectrum of equally spaced lines with similar intensity and extremely high long-term frequency stability. We present preliminary studies and results of a system which filters the OFC from a 100 MHz comb spacing to 16 GHz one, an adequate spacing for spectrometers with resolving power $\Delta\lambda/\lambda > 30000$. The first approach employs two Fabry-Perot cavities in series, made of dielectric coated mirrors, followed by a non-linear optical broadening system. The limitations of such a filtering process are discussed. These can be overcome by the second approach, based on filtering cavities with metallic coated mirrors.

Keywords Optical Frequency Combs (OFCs) ·
Near-IR astronomical spectrographs

G. Schettino (✉) · M. Inguscio
Dipartimento di Fisica e Astronomia, Via Sansone 1, 50019 Sesto Fiorentino (Fi), Italy
e-mail: giulia@arcetri.astro.it

G. Schettino · E. Oliva · C. Baffa · E. Giani · A. Tozzi
INAF-Oss. Astrofisico di Arcetri, Largo E. Fermi 5, 50125 Firenze, Italy

M. Inguscio · P. Cancio Pastor
LENS, Via Carrara 1, 50019 Sesto Fiorentino (Fi), Italy

M. Inguscio · P. Cancio Pastor
INO-CNR, Largo E. Fermi 6, Firenze 50125, Italy

1 Introduction

The growing astronomical interest in performing high resolution spectroscopy in the near-IR part of the spectrum has stimulated the development of a new generation of astronomical spectrographs capable of reaching a precision in radial velocity measurements of the order of 1 meter per second or even better. One of the main applications in this field is the detection of Earth-like planets orbiting around M-type stars via the radial velocity method [1]. In this case, a significant advantage respect to the search of Earth-like planets around Sun-like stars is that, fixed the planet mass, the lower is the star mass the higher is the detectable radial displacement. The detection of extra-solar rocky planets around red dwarfs is one of the main goals of the GIANO spectrographs [2]. GIANO is a cross-dispersed echelle astronomical spectrograph designed to achieve a high spectral resolution (up to 50,000 resolving power with a 2 pixel sampling) in the near-IR spectral range (0.9–2.5 μm) and to maintain long-term stability.

Building an adequate calibration source for high resolution astronomical spectroscopy is a general problem to be considered. The ideal source [3] should consist of a spectrum of uniformly spaced and of almost equal strength lines. They must be unresolved by the astronomical spectrograph and their spectral linewidth has to be narrower than the spectrometer resolution. Moreover, their frequencies must be well known and stable over long time scales. The standard astronomical calibration source is the Th-Ar discharge lamp. The

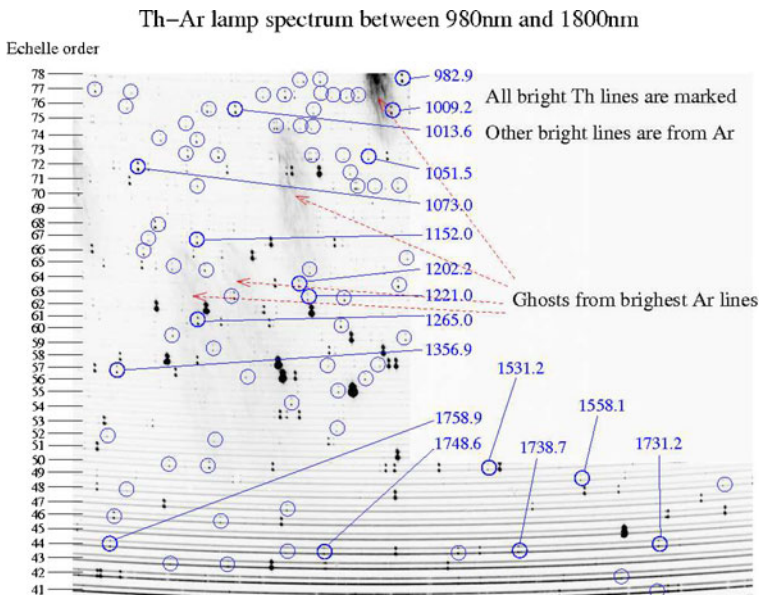

Fig. 1 Part of the echelle spectrum of a Th-Ar lamp taken with the GIANO spectrograph. For each order, two parallel spectra are visible because the instrument is fed by two fibers

practical problems and limitations of this source can be visualized in Fig. 1, which displays a part of the echelle spectrum of such lamp taken with the GIANO spectrometer. The spectrum is dominated by prominent Ar lines, some of which are so strong to produce spurious reflections and light ghosts in the spectrometer. The Ar lines are not accurate calibrators because their wavelengths depend on the current intensity and/or on the gas pressure inside the lamp (see e.g. [4]). The Th lines are much more stable but are relatively weak and, most important, the number of lines decreases dramatically at wavelengths longer than 1200 nm. For example, no bright lines are detectable in the region between 1690 nm and 1720 nm (grating order 45).

The use of femtosecond mode-locked lasers controlled by stable oscillators such as atomic clocks as the calibration source for high-resolution astronomical spectrograph has recently been proposed (e.g. [3, 5]). In fact, the Optical Frequency Comb [6, 7] source fits all the above requirements but one, the desired comb spacing. The present available OFCs in the visible and near-IR range have repetition rates between hundreds and thousands MHz, which are of the order of 10–100 times lower than required comb spacing for astronomical calibration purposes. Filtering the OFC light with one or two Fabry-Perot (F-P) cavities in series could give a solution to this drawback [8]. Recently, the application of OFC technology to calibrate a visible large-band astronomical spectrometer has been demonstrated [9]. Although the required OFC filtering was shown in this work, the spectral calibration range was limited to a few nm in the visible due, in part, to the cavity mirrors dispersion and, mostly, because the authors frequency doubled a filtered near-IR OFC to reach the visible range. In addition, a 12.5 GHz-spaced OFC covering the 1,380–1,820 nm range has been obtained [11] starting from a 250 MHz-spaced OFC and filtered with 2 F-P cavities. Nevertheless, wide operation range of an OFC astronomical calibrator, as an octave in the visible or near-IR spectral range, has been not yet demonstrated. Indeed, coating dispersion of the filtering cavity mirrors prevent wavelength matching between F-P fringes and OFC modes for wide spectral ranges.

In this paper, we describe an experimental approach which overcomes such limitation, by filtering a near-IR 100 MHz-spaced OFC to 16 GHz spaced calibration lines, with a spectrum spanning an octave (1–2 μm). We propose to filter the OFC spectrum by using two filtering F-P cavities in series in a limited range between 1,500–1,650 nm, where the limitation of mirrors dielectric coating dispersion can be avoided. Several laser amplification stages of the OFC light, before and after the filtering process, provide enough power of the filtered OFC to non-linear optical broadening up to 1–2 μm range by using a highly non-linear optical fiber.

2 Filtering Fabry-Perot cavity specifications

The optimal line spacing for near-IR high resolution astronomical spectrographs lies typically between 10 and 20 GHz. In the case of GIANO,

considering the highest resolving power obtainable with the spectrograph, the optimal line spacing for the calibration spectrum lies around 16 GHz. For our experimental set-up we start from a near-IR Er-doped fiber laser comb with a repetition rate $f_r = 100$ MHz (MenloSystems model FC1500) and 1–2 μm spectral coverage. If a single F-P cavity is used to filter it, a Free Spectral Range (FSR) of 16 GHz is required, with a filtering order $m = \text{FSR}/f_r = 160$. As a first consequence, at least a factor m of power decreasing in the filtered comb with respect to the input must be considered.

To infer the required cavity finesse, let's consider that the upper limit of a calibration spectral shift due to the presence of one unfiltered OFC side mode, Δf , is imposed by the condition $\Delta f \simeq 3 \cdot 10^{-10} f$. This value refers to a precision of about 10 cm/s, as required by the radial velocity measurements in the case of a Sun-Earth system. Considering a frequency $f_m = 200$ THz, it results $\Delta f \simeq 3 \cdot 10^{-10} f_m \simeq 6 \cdot 10^4$ Hz. The side-mode suppression [10], ρ , needs to be $\rho \sim \Delta f/f_r \simeq -32$ dB. Being ρ the F-P cavity transmission function $T(f, F, m)$ at the f_r frequency, we calculated a cavity finesse $F = 3200$ for $m = 160$ and $f = f_r = 100$ MHz. This value corresponds to mirror reflectivity $R = 99.9\%$, for a linear symmetric F-P cavity. In Fig. 2, we show the effect of F in the ρ parameter for the case of a F-P cavity with a $\text{FSR} = 1.6$ GHz ($m = 16$). A variation of a factor 3 in the F value, from $F = 600$ (lower curve) to $F = 200$ (upper curve), causes a change of a factor 10 dB in the suppression of the first adjacent mode respect to the transmitted one. This means that the side-mode suppression ρ , i.e. the Δf value and so the available resolution $\Delta f/f$, is worsened by a factor 10.

On the other side, dispersion due to cavity mirror coatings changes the F-P cavity FSR at different wavelengths [12]. In fact, in the non-ideal case the FSR

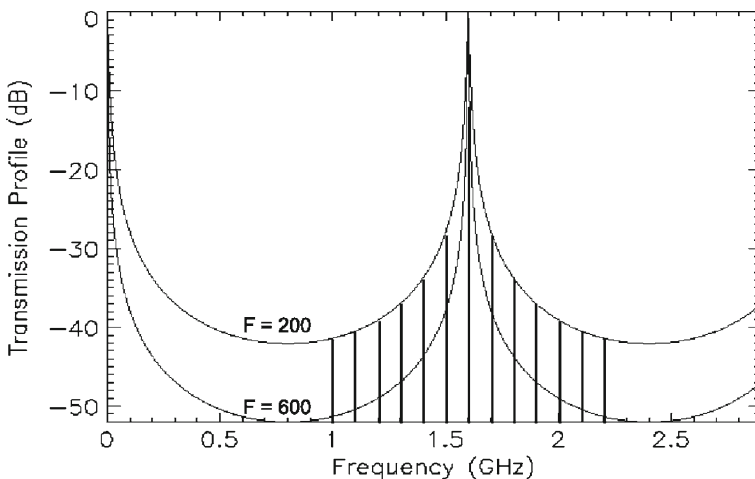

Fig. 2 The Transmission Profile of an ideal F-P cavity of $\text{FSR} = 1.6$ GHz in the case $F = 200$ (upper curve) and $F = 600$ (lower curve). The peaks corresponding to each OFC mode are also shown

depends also on the frequency and we can estimate the dispersion-induced changes, by introducing the group delay dispersion (GDD), $GDD(f) = d/df(1/FSR(f))$ [12]. The relative shift between cavity transmission peaks and OFC modes due to GDD must be less than $f_r/2$ in order to avoid an error in the assignment of the order number of filtered modes. In our case, with $f_r = 100$ MHz, we require $GDD < 10$ fs² in the whole spectral range, which corresponds to a maximum shift in the FSR value of about 1%.

The above requirements lead to three main technical limitations: (i) the mirror coating dispersion could limit the filtered spectral range with unique correspondence between OFC modes and F-P fringes; (ii) the mirror coating must ensure high reflectivity values as required by high side-mode suppression; (iii) the high power losses due to the required high filtering m order. Unfortunately, GDD increases with the mirror reflectivity, avoiding to get both high finesse and wide filtering spectral coverage with a single F-P cavity. A possible solution is to use two or more F-P cavities in series with a less stringent mirror reflectivity requirement, but with the same total side-mode suppression. In addition, a lower finesse of each cavity allows a less stringent active control of the relative frequency fluctuations between OFC and filtering cavity. Different FSR of each cavity can be chosen in order to reduce the filtering order m_i (with $m = \Pi m_i$), and hence with, at least, the same OFC power lost due to the number of the filtered 100 MHz comb mode. Another parameter to take in account is the cavity configuration, i.e. radius of curvature of the mirrors. It must be chosen accurately to avoid coincidences between high-order cavity transversal modes and OFC modes to be filtered. After an accurate analysis of different simulated configurations, we chose a quasi plane-plane one, composed by one plane and one curved mirror (radius of curvature 100 mm). This is the best compromise between high-order transversal modes suppression and an easy as possible cavity alignment.

3 The experimental apparatus

For our case, a compromise among high side-mode suppression, a wide as possible OFC filtering spectral range and the number of filtering cavities to avoid a complicate set-up, allows us to develop a system with two filtering cavities with $F = 600$, operating in a limited spectral range (1,500–1,650 nm). Different FSR were chosen, 1.6 GHz for the first cavity and 16 GHz for the second, in order to reduce the order m in each filtering process to 16 and 10 respectively. Then, the filtered comb will be broadened to the 1–2 μm range by using non-linear effects in optical fiber as used in OFC technology [13]. In addition, several fiber laser amplifiers, disposed as described below, must boost the OFC power, necessary for filtered OFC broadening. This set-up is schematically shown in Fig. 3. In this figure, in addition to the OFC laser, a continuous wave (cw) laser emitting around 1,554 nm is shown. This laser, which is combined with the comb light at the input of each cavity by

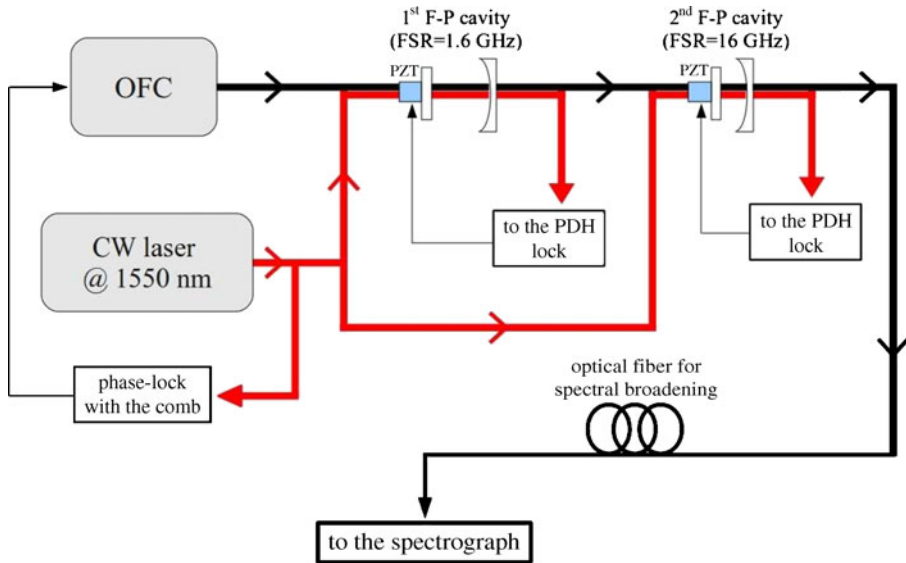

Fig. 3 Scheme of the experimental apparatus

using a polarization beam-splitter, controls the cavity alignment and frequency fluctuation, as described in the following subsection.

The two F-P cavities are built in the same quasi plane-plane configuration. The curved mirror has a radius of curvature of 100 mm, chosen to minimize the possible overlap between unwanted high-order transversal modes and the cavity transmission mode (see [14]). The first cavity has a length $L_1 = 9.375$ cm (quasi hemifocal), while the second has $L_2 = 0.9375$ cm. The mirrors have a nominal reflectivity $R = (99.5 \pm 0.2)\%$ in the 1,500–1,650 nm interval and a GDD less than 10 fs^2 in the same interval (as provided by Layertec GmbH).

3.1 Check of the mirror coating specifications

To check these mirrors specifications in the 1500–1650 nm range, we tuned the wavelength of a cw-laser at $\lambda = 1, 545, 1,575, 1,604$ nm. The spectrum, as resulting from the addition of three images recorded from an IR camera (Xeva-796), is shown in Fig. 4a. In addition, the F-P transmitted spectrum of the cw-laser at these three different wavelengths is also shown (Fig. 4b, c, d, only one FSR is depicted). These F-P spectra were recorded by detecting the cw laser light transmitted by the F-P cavity with an InGaAs detector, while the F-P length was scanned via a piezoelectric transducer (PZT) mounted on the cavity plane mirror.

Such spectra allow us to check the GDD and R characteristics of the mirrors. In terms of arbitrary units, the FSRs at 1545, 1575, 1604 nm result $FSR_{1545} = 0.23186$, $FSR_{1575} = 0.23061$, $FSR_{1604} = 0.23006$, respectively. Considering a mean FSR, $FSR_m = 0.23084$, we obtain a maximum shift in the FSR

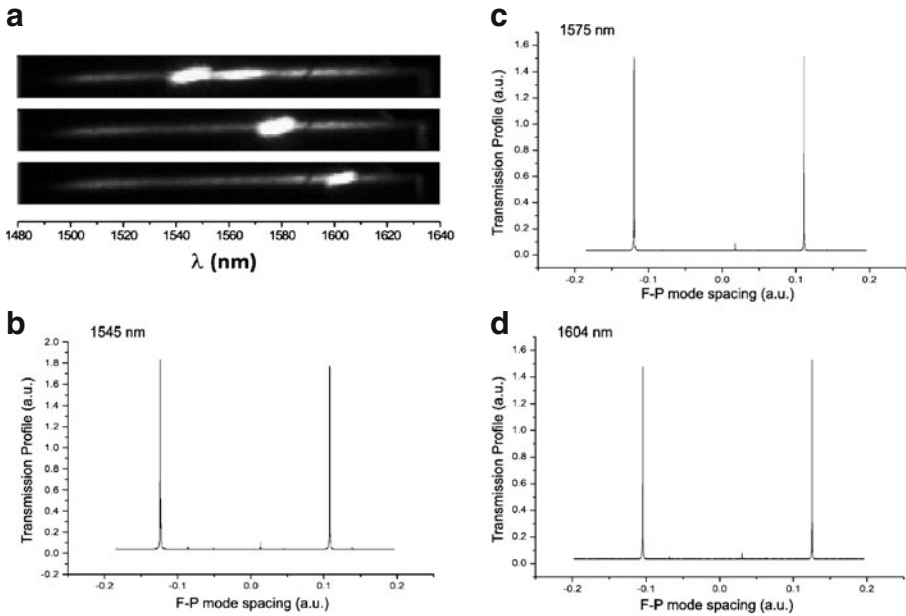

Fig. 4 The cw-laser at different wavelengths superimposed on the comb: **a** image taken with the IR camera Xeva-796; **b, c, d** cw-laser transmission spectrum for the 1.6 GHz F-P cavity with the cw-laser wavelength set at 1,545, 1,575, 1,604 nm, respectively. For the **b, c, d** graphs, both scales are expressed in arbitrary units, a.u.

value of 0.4% (corresponding to a maximum deviation of $\Delta FSR_m = 0.00102$), to be compared with the required 1% due to GDD limitation. In conclusion, the dispersion due to the mirror coating will not affect our calibration in terms of bad assignment of the comb order of the filtered OFC in this spectral range.

For each of the three cw-laser wavelengths, we infer the finesse F , calculated from the ratio between linewidth of one transmitted F-P peak (in a.u.) and FSR. As a result, $F_{1545} = 930$, $F_{1575} = 1,050$, $F_{1604} = 1,150$, and thus the corresponding reflectivities are $R_{1545} = 99.66\%$, $R_{1575} = 99.70\%$ and $R_{1604} = 99.73\%$. In conclusion, the measured reflectivities over the spectral range of our interest are larger than the nominal ones and, consequently, an ever better side-mode suppression can be allowed.

3.2 Preliminary results of the first filtering process

The details of how the system works for the first cavity are shown in Fig. 5. First of all, the reduced comb spectrum between 1,500 and 1,650 nm is amplified by an Er-doped fiber amplifier (MenloSystems P250 Pulse-EDFA) from 30 mW up to 450 mW. Then, the light from the cw-laser and from the amplified comb, after passing some optical components, are superimposed and they enter the first cavity with orthogonal polarization. At the cavity output, the light from the two sources is separated again via a beam-splitter polarizer. The transmitted

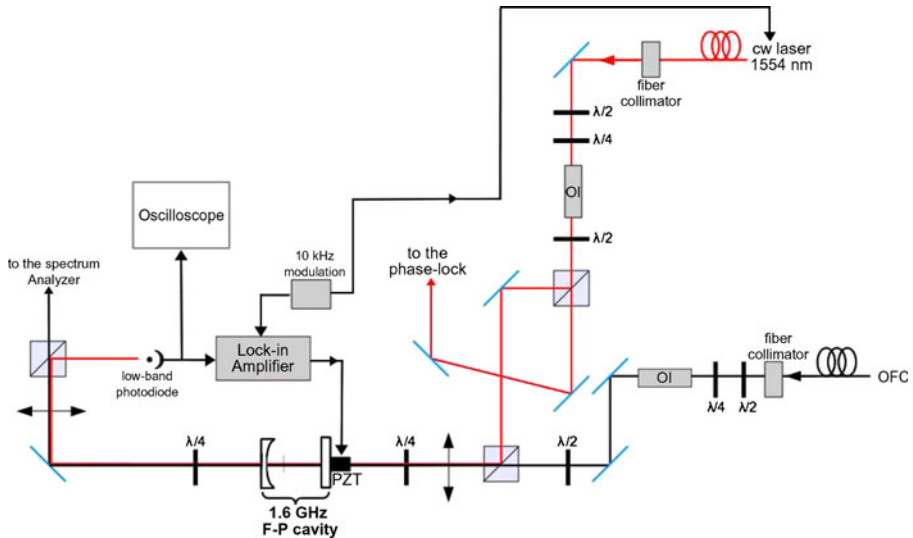
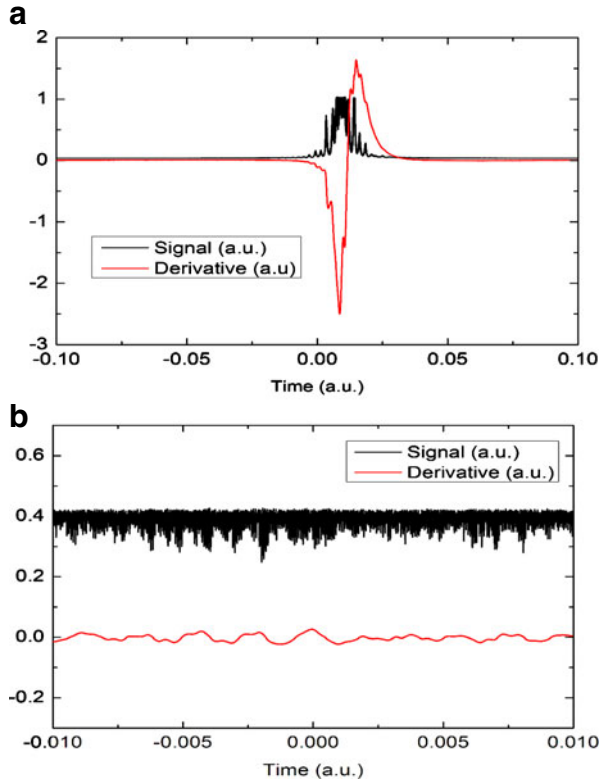

Fig. 5 **a** Scheme of the experimental apparatus; **b** the detailed apparatus for the first F-P cavity

comb is sent to the second cavity for further filtering, or alternatively it is detected by a 40 GHz fast photodetector for analysis. Instead, the transmitted cw-laser light is used for the frequency lock system.

Indeed, the control of the cavity length drifts and fluctuations in time is of critical importance in order to maintain the cavity always resonant with the same comb modes. To this aim, we use the cw diode laser at 1,554 nm. The approach is the following: first, the cw-laser frequency must be coincident with that of one OFC mode, by using a phase-lock system as described below. Second, due to the fact that both OFC and cw-laser have a common optical path inside the cavity, we can use F-P transmission peaks of the cw-laser to control the cavity length, hence automatically satisfying the resonant condition for the coincident comb mode. In addition, if the cavity FSR (i.e. cavity length) is set to be an integer multiple of the OFC f_r , we get, in this way, the resonant condition for all comb modes spaced by one FSR. To this purpose, the curved mirror support is mounted in a micrometric translation stage, which roughly fixes the cavity length. Fine tuning is achieved by using the PZT system mounted on the plane mirror. To actively control this length, the cw-laser frequency is modulated at 10 kHz rate by applying modulated current to the diode. The first derivative of the transmission peak of the cw-laser coincident with the comb mode is obtained by using a lock-in detection. Such dispersive signal is used as a frequency discriminator to correct relative frequency fluctuations of the cavity against cw-laser frequency. In Fig. 6a, the F-P transmission peak for the cw-laser and its first derivative are shown. The maximum of the transmission peak coincides with the passage through 0 Volt of the derivative, and then a retroactive loop is closed on the mirror PZT

Fig. 6 **a** cw-laser F-P transmission peak and its first derivative recorded by a lock-in detector; **b** cw-laser and its derivative cavity transmission traces when the cavity is frequency stabilized against cw-laser frequency



to control cavity frequency fluctuations with a bandwidth of about 1 kHz. A trace of transmitted intensity for both cw-laser and its derivative when the stabilization loop is active is shown in Fig. 6b.

For a phase-lock between OFC and cw-laser, a small fraction of the cw light is picked before entering the cavity, sent to a 80 MHz acousto-optic modulator (AOM), and beated in a 125 MHz photodetector with the nearest comb mode (see Fig. 7). The phase of the beat-note is compared with that of a 80 MHz frequency synthesizer, and phase variations between both are corrected by feeding the corresponding correction to the diode laser drive current with a bandwidth up to 50 kHz. In this way, the 80 MHz-shifted diode laser is a spectral copy of the nearest comb mode, as shown in Fig. 7 (black line). Consequently, the diode laser sent to the cavity has the same frequency of the nearest comb mode, as required to actively control the cavity length. Finally, we can note that alternative approaches, as for example to use directly the filtered comb light [11], can be used to control the cavity frequency, but cw-laser approach helps also to make easier the initial cavity alignment.

Under cavity lock conditions, we have analyzed the filtering ratio by using a spectrum analyzer. A plot of the OFC filtered spectrum is shown in Fig. 8. The feature at 1.6 GHz is the beat signal of all transmitted comb modes each

Fig. 7 Beat note between 80 MHz-shifted cw-laser and the nearest comb mode as recorder by a spectrum analyzer. *Red line* cw-laser unlocked, *black line* cw-laser phase-locked to the comb. The 100 MHz peak represents the beat between adjacent comb modes (i.e. the repetition rate)

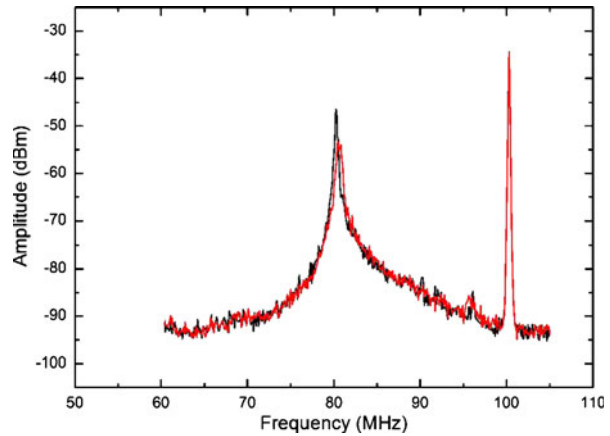

FSR for the whole 1,500–1,650 nm range, while the other peaks, one each 100 MHz on both sides of the 1.6 GHz peak, are the corresponding beats for the first, second, third,... adjacent OFC modes, filtered by the cavity. This image is repeated at each multiple of $FSR = 1.6$ GHz. From this figure we measured that the first adjacent mode is suppressed by a factor $\rho = -32.1$ dB. We have measured an OFC transmitted power of 14 mW by using a thermal power meter. Since before the cavity the power was 450 mW, the filtering attenuation factor is 32, a factor 16 by the filtering order and an additional factor 2 due to cavity coupling losses.

Similar performances are expected for the filtering process by the second cavity. The only difference is the FSR, which is 16 GHz in this case. We are confident that such a filtering system with two cavities guarantees the calibration requirements in the 1,500–1,650 nm range.

Fig. 8 The OFC filtered spectrum after the first F-P cavity as it appears on a spectrum analyzer

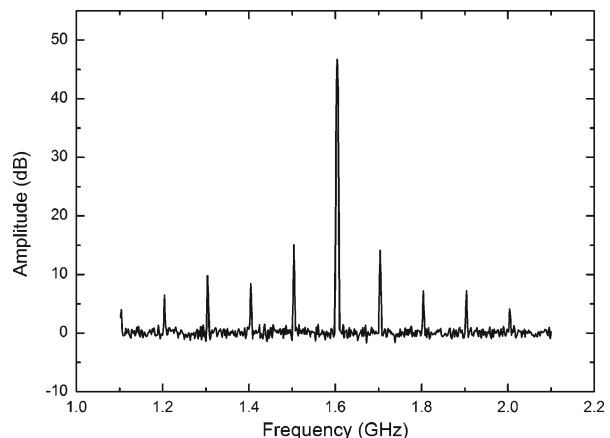

3.3 1–2 μm broadening: limitations and perspectives

The second part of the apparatus consists in the broadening of the filtered spectrum, to obtain a final calibration comb spectrum in the whole spectral range of interest. We plan to do this using a highly non-linear fiber (HNLf) [13]. First of all, to seed the HNLf in a way to generate an octave-spanning spectrum starting from the 1,500–1,650 nm filtered comb spectrum, it is necessary to have, at least, some tens mW of power at the output of the second cavity. Assuming the OFC power decrease factor for the second cavity equal to that measured for the first, we would have a final output comb power of about 1 mW, starting from 450 mW. While this power is enough to be detected by the astronomical spectrograph (and so a 16 GHz-spaced calibration comb in the 1,500–1,650 nm range is already feasible), to broaden the spectrum to cover the 1–2 μm range the power is definitely low. Installing another Er-doped fiber amplifier between the two cavities would lead the power entering the second cavity to 450 mW again, reaching a final power of about 25 mW, which is still below the limit for an efficient broadening. So a third amplification stage after the second cavity is necessary. This makes the system more complicated and very expensive, although it is still feasible (see e.g. [11]). In addition, as the laser amplification is a stimulated process, further amplification of the filtered modes could be achieved, attenuating or deleting the benefits of the previous filtering process. This fact implies that a better than 32 dB suppression of the first adjacent mode is, at the end, mandatory to guarantee a final (after spectral broadening) 32 dB side-mode suppression.

Therefore, alternative approaches must be proposed to overcome such possible limitations or set-up complications. Our approach is to use metallic mirrors instead of dielectric coated ones. In this case, there is virtually no dispersion problem due to the coatings, and this makes possible to filter directly the octave-spanning comb output (1–2 μm). The main disadvantage is that using metallic mirrors implies lower reflectivities. As a consequence more than two cavities are necessary to reach the required side-mode suppression ratio. It complicates the experimental set-up, but the lower finesse of each cavity with respect to the cavity described above will help to relax the electronic requirements necessary for frequency cavity control. On the other side, the cost of such filtering system is lower, because the fiber amplifiers are no more necessary. We have done an accurate study of the metallic coating materials useful in this spectral window. From that, we plan to use Silver coated mirrors with thickness adjusted to obtain a mean transmission and reflectivity of 1 and 96% respectively, in the 1–2 μm range. The expected performances of the cavities as a function of wavelength, in the best case of three cavities in series with FSRs 1.6, 8 and 16 GHz respectively, are summarized in Table 1. It follows that to reach the same level of side-mode suppression as with dielectric mirror cavities three cavities in series are necessary.

Another mandatory limitation to be considered in the case of using Silver coated mirrors is the quick degradation of the coatings with time. This is in contrast with the requirement of a long term stability; in fact, a gradual

Table 1 Predicted parameters (transmission T , reflectivity R and corresponding finesse F) of the F-P cavities based on Silver coating (thickness 40 nm) and the side-mode suppression ρ in the case of 1 cavity with $FSR = 1.6$ GHz, 2 cavities in series with FSRs 1.6 and 8 GHz respectively, 3 cavities in series with FSRs 1.6, 8 and 16 GHz respectively

λ (nm)	T (%)	R (%)	F	ρ_{1cav} (dB)	ρ_{2cav} (dB)	ρ_{3cav} (dB)
900	2.02	95.7	73.1	-19.02	-25.24	-27.79
1,000	1.62	96.1	80.5	-19.88	-26.77	-29.73
1,200	1.09	96.7	95.2	-21.34	-29.45	-33.20
1,500	1.40	95.7	73.1	-19.02	-25.24	-27.79
1,800	0.94	96.5	89.8	-20.83	-28.50	-31.95
2,000	0.75	96.9	101.3	-21.89	-30.47	-34.55

deterioration of the coatings causes a worsening of the side-mode suppression in time, because of the reduced coating reflectivity. To this aim, first of all we use protected coated Silver mirrors, to slow down the degradation process. Second, we place the cavities in appropriate boxes where vacuum can be maintained, so that the coating properties are preserved. These precautions should be sufficient to obtain the required long-term stability.

4 Discussion and conclusions

In this paper we describe the general problem of building an adequate calibration system for high resolution near-IR astronomical spectrographs. A 16 GHz filtered OFC laser is proposed as the calibration source for these instruments in the 1–2 μm range. A first proposed set-up is to start with an OFC (100 MHz repetition rate) and to filter the spectrum in the 1,500–1,650 nm range with 2 F-P cavities in series made with dielectric coated mirrors, to reach a 16 GHz mode spacing. The first cavity filtering process was experimentally implemented. A 32 dB level of side-mode suppression ratio was measured for such filtering process with a reduction of the OFC power by a factor 32. Similar results are expected for the second cavity, which demonstrate the calibration source performances to be suitable in the 1,500–1,650 nm range. A broad operation to the 1–2 μm range will be achieved by non-linear optical conversion of the filtered comb by using a HNL fiber. Power requirements of such processes need several comb amplification stages to compensate the power decrease during filtering process. Apart of the high cost of such approach, further amplification of the filtered modes could limit its practical application.

When aiming to broaden the comb spectrum to an octave, we propose a simpler solution, in terms of costs, which is to use metallic coated mirrors for the F-P filtering cavities. In this case, overcoming the coating dispersion limit, it becomes possible to filter directly the octave-spanning output of the comb. This fact solves the major problem of broadening the spectrum with a HNLF after the filtering process, but the system requires three F-P cavities in series instead of two to reach the same final finesse level of the dielectric cavities.

References

1. Santos, N.C.: Extra-solar planets: Detection methods and results. *New Astron. Rev.* **52**, 154–166 (2008)
2. Oliva, E., Origlia, E., Baffa, C., Biliotti, C., Bruno, P., D'Amato, F., Del Vecchio, C., Falcini, G., Gennari, S., Ghinassi, F., Giani, E., Gonzalez, M., Leone, F., Lolli, M., Lodi, M., Maiolino, R., Mannucci, F., Marcucci, G., Mochi, I., Montegriffo, P., Rossetti, E., Scuderi, S., Sozzi, M.: The GIANO-TNG Spectrometer. *Proc. SPIE* **6269**, 626919–626928 (2006)
3. Murphy, M.T., Udem, Th., Holzwarth, R., Sizmman, A., Pasquini, L., Araujo-Hauck, C., Dekker, H., D'Odorico, S., Fischer, M., Hansch, T.W., Manescau, A.: High precision wavelength calibration of astronomical spectrographs with laser frequency combs. *MNRAS* **380**, 839–847 (2007)
4. Kerber, F., Nave, G., Sansonetti, C.J., Bristow, P., Rosa, M.R.: The spectrum of Th-Ar hollow catode lamps in the 900–4,500 nm region: establishing wavelength standards for the calibration of VLT spectrographs. In: *ASP Conference Series*, vol. 364, pp. 461–478 (2007)
5. Osterman, S., Diddams, S., Beasley, M., Froning, C., Hollberg, L., MacQueen, P., Mbele, V., Weiner, A.: A proposed laser frequency comb based wavelength reference for high resolution spectroscopy. *Proc. SPIE* **6693**, 66931G-1-9 (2007)
6. Udem, T., Holzwarth, R., Hansch, T.W.: Optical frequency metrology. *Nature* **416**, 233 (2002)
7. Maddaloni, P., Cancio Pastor, P., De Natale, P.: Topical review: Optical comb generators for laser frequency measurement. *Meas. Sci. Technol.*, **20**, 052001 (2009)
8. Steinmetz, T., Wilken, T., Araujo-Hauck, C., Holzwarth, R., Hansch, T.W., Pasquini, L., Manescau, A., D'Odorico, S., Murphy, M.T., Kentischer, T., Schmidt, W., Udem, Th.: Laser Frequency combs for astronomical observations. *Science* **321**, 1335–1338 (2008)
9. Wilken, T., Lovis, C., Manescau, A., Steinmetz, T., Pasquini, L., Lo Curto, G., Hansch, T.W., Holzwarth, R., Udem, Th.: High precision calibration of spectrographs. *MNRAS* **405**, L16 (2010)
10. Steinmetz, T., Wilken, T., Araujo-Hauck, C., Holzwarth, R., Hansch, T.W., Udem, T.: Fabry-Perot filter cavities for wide-spaced frequency combs with large spectral bandwidth. *Appl. Phys. B* **96**, 251 (2009)
11. Quinlan, F., Ycas, G., Osterman, S., Diddams, S.A.: A 12.5 GHz-spaced optical frequency combs spanning >400 nm for near-infrared astronomical spectrograph calibration. *Rev. Sci. Instrum.* **81**, 0631051–0631059 (2010)
12. Thorpe, M.J., Ye, J.: Cavity-enhanced direct frequency comb spectroscopy. *Appl. Phys. B* **91**, 397–414 (2008)
13. Chang, G., Li, C.-H., Phillips, D.F., Walsworth, R.L., Kartner, F.X.: Toward a broadband astro-comb: effects of nonlinear spectral broadening in optical fibers. *Opt. Express* **18**, 12736–12747 (2010)
14. Schettino, G., Baffa, C., Giani, E., Inguscio, M., Oliva, E., Tozzi, A., Cancio Pastor, P.: The Astro-comb project. *Proc. SPIE* **7808**, 78081Q (2010)