

# Networks of trends: systematic definition of evolutionary scenarios

Gaetano Cascini<sup>1,2</sup>, Federico Rotini<sup>2</sup>, Davide Russo<sup>3</sup>

<sup>1</sup>Politecnico di Milano, Dip. di Meccanica, Italy

<sup>2</sup>Università degli Studi di Firenze, Dip. di Meccanica e Tecn. Ind.li, Italy

<sup>3</sup>Università degli Studi di Bergamo, Dip. di Ingegneria Ind.le, Italy

## Abstract

TRIZ literature presents several papers and even books claiming the efficiency of Altshuller's Laws of Engineering System Evolution as a means for produce technology forecasts. Nevertheless, all the instruments and the procedures proposed so far suffer of poor repeatability, while the increasing adoption of innovation as the key factor for being competitive requires reliable and repeatable methods and tools for the analysis of emerging technologies and their potential impact. The present paper proposes an original algorithm to build a Network of Evolutionary Trends for a given Technical System with repeatable steps. Such a goal has been achieved by integrating well known models and instruments for system description and functional analysis. The overall procedure, still under further development, has been clarified by means of one of the case studies carried out for its validation.

## Keywords

Technology Forecasting, Laws of Engineering Systems Evolution, FBS model, EMS model, Functional Basis

## 1 INTRODUCTION

Nowadays the analysis of emerging technologies and their potential impact on markets, economies and societies requires reliable and repeatable methods and tools since the related information plays a critical role for strategic decisions of private and public organizations.

Therefore it is not surprising that more than fifty methodologies with different characteristics and specific purposes have been proposed so far in this field [1]. Nevertheless all these techniques reveal several weaknesses [2] as: limited accuracy on middle and long-term forecast; lack of robustness; poor adaptability, i.e. no universal methods are known, besides complementary instruments must be integrated according to the specific goal and data availability.

Within this context TRIZ is emerging as a systematic forecasting methodology and the TRIZ community widely claims the benefits arising from the application of Altshuller's Laws of Engineering System Evolution (LESE) [3, 4] and the corollary trends identified so far.

Besides, as already discussed in [2, 5], also TRIZ instruments suffer from lack of robustness (different teams work independently produce different scenarios) and lack of accredited procedures for their application.

In facts, several TRIZ tools have been proposed to support technology forecasting activities: S-curve, system operator, laws of technical systems evolution, lines of evolution (trends), Ideality increase, morphological analysis, wave model of systems evolution, ARIZ. Nevertheless, while these tools reveal relevant potentialities in several specific situations, their integrated use is limited to inventive problem solving tasks (ARIZ), while it is still missing for forecasting applications.

The present paper proposes a step-by-step algorithm for analyzing a Technical System (TS) and the way its Main useful Function (MUF) is delivered at different detail levels. The working principle is then compared with previous generations of the system in order to build a structured classification of the information, suitable for evolutionary comparisons. These comparisons allow to build a network of scenarios with different involvement of resources, which constitutes a map of the TS evolution,

where already commercialized products are visualized together with emerging patented inventions and free spaces for investments. The choice of the favorite strategical direction is still assigned to the beneficiaries of the forecast according to their attitude to the world, their mission and values, as already suggested by Altshuller [3]. Nevertheless, the proposed procedure carefully limits the evolution space by means of a detailed resources analysis.

Such a network of trends proved to be an effective tool for exploratory analysis of potential evolutions of a TS in three extended industrial applications and several minor applications to literature examples.

In this paper, in order to illustrate and clarify the proposed algorithm we report some details from an experience in the field of aseptic filling of beverage containers related to a cooperation with GEA-Procomac. Such an activity has lead to the identification of some specific solutions the company was not aware of, which are actually under development by Procomac's competitors. Moreover new R&D opportunities have been highlighted and the company has positively evaluated the chance to invest in those directions. All these results are considered a positive validation of the proposed procedure.

## 2 TRIZ INSTRUMENTS AND FORECASTING

Fey and Rivin in [6] first positioned TRIZ as a "powerful structured methodology for a directed development of new products/processes" alternative to more classical Technology Forecasting approaches like trend extrapolation, morphological analyses and Delphi methods. Besides, the methodological description was limited to the LESE with a number of examples, without providing proper details about the way the TRIZ laws should be applied.

Then Cavallucci in [7] started integrating TRIZ LESE into the product development cycle as a means to predict the impact of a technical solution.

The abovementioned approaches, indeed adopted by several TRIZ professionals and implemented in some software applications, are helpful to explore variants of the analyzed TS, but no directions are provided to identify elements and functions to be evaluated and further

developed according to the LESE; moreover no specific comparison means are available. As a result, the robustness of the process is poor and strongly dependent on the skill and the experience of the analyst.

It must be mentioned that a few TRIZ professionals have proposed integrated procedures for technology forecasting purposes [8, 9]; nevertheless, the authors believe that both Directed Evolution by Zlotin, Zusman and Evolution Trees by Shpakovsky are still mostly focused on the interpretation of the LESE than on the analysis of the system the forecast is about.

Such a lack of preliminary classification, especially in case of complex systems, is the main reason for poor repeatability of TRIZ forecasts, since different researchers apply TRIZ LESE to different details/characteristics of the same technical system and/or limit their study to superficial features of the system itself.

In this paper the authors propose an algorithm for the definition of the evolutionary scenarios of a technical systems by applying the LESE. The original contribution of this work is the definition of a systematic procedure to analyze a technical system, compare alternative means to deliver the same functions, synthesize new opportunities of development, assess the limitations of the resulting forecast.

### 3 ALGORITHM FOR BUILDING A NETWORK OF EVOLUTIONARY SCENARIOS (NXXX)

As stated in the previous section, a crucial issue is the identification of the proper function(s) delivered by the analyzed system, the influence on its evolution of auxiliary functions and undesired side effects, the competing alternative technologies. In order to provide systematic directions to function classification and to adopt a terminology well known by the scientific community, the algorithm has been based on well known models of Design Theory.

A further critical task of a technology forecast is the collection and analysis of information; therefore, specific guidelines have been provided to gather information both from experts and patent databases.

#### 3.1 Reference models for system analysis

The following models are adopted as elementary references for the definition of the Nxxx:

- EMS model [10]: Any technical system can be modeled as a black box channeling or converting energy, material and or signals (information) to achieve a desired outcome.
- Minimal Technical System: In [11] the adoption of the EMS model was proposed also for problem formulation and analysis as an alternative means to Su-Field modeling. Nevertheless, the decomposition of the black-box into sub-systems lacks of precise directions about the level of details to be provided. In order to deal with a repeatable model, whatever is the complexity of the system to be analyzed, four element must be recognized (figure 2, above): a Tool, i.e. the working element delivering the function of the TS; a Supply, i.e. the element providing the energy necessary to produce the expected effect of the function; a Transmission, i.e. the element transmitting energy from the Supply to the Tool; a Control, i.e. an element governing at least one of the above elements [3]. According to the classical definition of the minimal technical system, just energy flows are taken into account; besides, the concept of the Law of Completeness of System Parts can be extended also

to different types of flows, namely Material and Signals. A detailed explanation of this statement is out of the scopes of the present paper, nevertheless the authors are going to publish a paper fully dedicated to the extension of the first three LESE to a general EMS model.

- System Operator [3]: the analysis must be conducted at different detail levels with a proper hierarchical classification of system elements (figure 3). As a consequence, each of the four elements of the minimal technical system can be further decomposed into four subsystems with the same structure (figure 2, below).

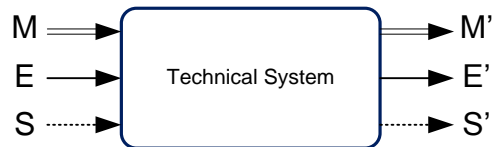

Figure 1: EMS model: Energy, Material and or Signals are channelled or converted to deliver a certain function.

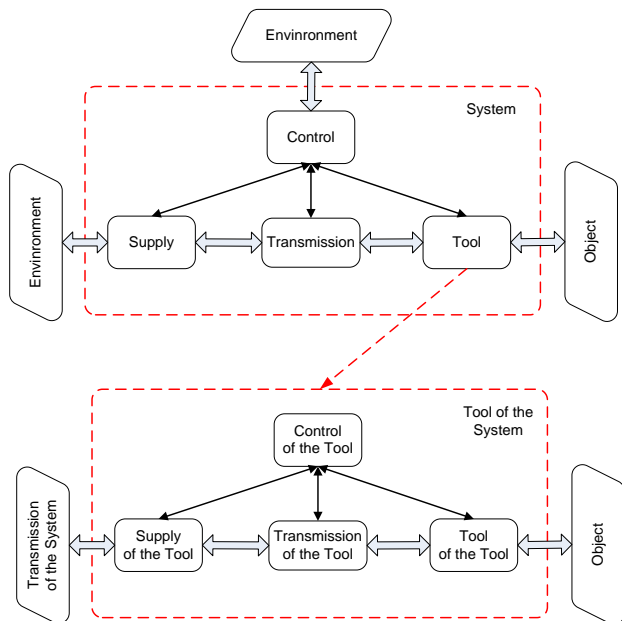

Figure 2: Minimal Technical System (above) and hierarchical decomposition of its elements (below).

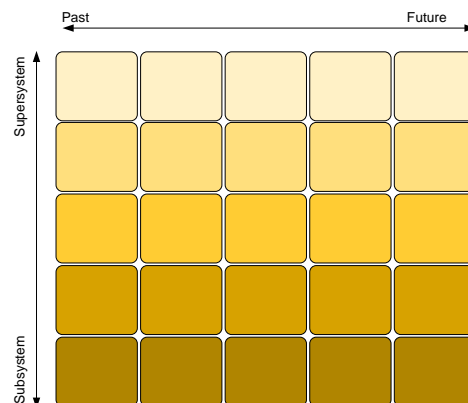

Figure 3: System Operator.

- Function-Behavior-Structure (FBS) [12]: the Function of a TS is the motivation for its existence; at the Structure level, a TS is constituted by entities, attributes of these entities and relations among them; the Behavior, defined as sequential changes of objects state governed by the Laws of Nature [13], is the link between Function and Structure. Different Behaviors can produce the same Function, as well as different Structures can be characterized by the same Behavior.
- Functional Basis for Engineering Design [14]: The need for formalized representations in function-based design is often overlooked in the literature; however, it is an issue of critical importance to reduce ambiguity at the modeling level (when multiple terms are used to mean the same things, or when the same term is used with multiple meanings) and to improve repeatability of the models (the larger the number of terms there are in a vocabulary, the more different ways there are to model or describe a given design concept). The distillation of a large body of terms into a concise basis does not eliminate these problems entirely, but it significantly lessens their occurrence. A further advantage of the functional basis approach is that it fits with the previously mentioned models, since the taxonomy of functions is expressed by a number of functional verbs applied to EMS flows. The formers are hierarchically subdivided into 8 classes, 21 secondary and 24 tertiary actions on flows; these are classified in three levels including 6 secondary and 11 tertiary material flows, 12 secondary and 4 tertiary energy flows, 2 secondary and 7 tertiary signal flows. Nevertheless, it is worth to notice that although these efforts for a standard taxonomy for engineering functions by the NIST Design Repository Project are well established, they still lack operational relationship with FBS behaviors [15].

### 3.2 Integrated model for function-behavior analysis

The reference models presented in the previous section can be integrated in order to provide systematic and repeatable means to perform the analysis of a TS before to apply comparisons and extrapolations based on the LESE.

TRIZ practitioners usually express functions in terms of triads Subject-Verb-Object such that the Subject modifies a parameter of the Object according to the action described by the Verb. In other terms, the pair Verb-Object can be translated into an expression like "changes <parameter> of the Object". Such a parameter constitutes an evaluation means for assessing the performance of the function and thus the degree of satisfaction of the TS itself.

Besides, in order to adopt a formulation compatible with the Functional Basis for Engineering Design mentioned above, it is suggested to associate an EMS model to the intended function of the TS.

Generally speaking, the EMS model of a TS hides several elementary functions, since the TS may impact several parameters of the same object. As an example, a nozzle for sterilization devices, heats (changes temperature) and directs (changes direction) a sterilant.

Thus the EMS model must be split into elementary black boxes each delivering one of the basic actions constituting the Functional Basis. Energy, Material and Signal flows can be detailed according to the secondary and tertiary classes proposed in [14].

Such a detailed functional model still doesn't represent the specific solution adopted to deliver each function, i.e. the model must be integrated with the behaviour of the TS, or in TRIZ terms the physical, chemical, geometrical effect adopted.

In this paper it is proposed to represent the behaviour of each elementary function by means of the Minimal Technical System model. Figure 4 shows an exemplary integrated model for a sterilizer nozzle: the EMS model is further developed in terms of elementary actions according to the functional basis and each of them is associated to a specific behaviour model representing a way to perform the corresponding function. A Su-Field model related to the interaction Tool-Object has been added to each behaviour model; however it is suggested to build a Su-Field model for each pair of interacting elements of the Minimal Technical System model.

### 3.3 Information gathering and classification

The construction of a network of evolutionary scenarios for a technical system clearly requires collecting and classifying data and information from several sources. These can be mainly divided in two main categories (figure 5): experts somehow involved in the product cycle of the TS, i.e. executives, managers, researchers, designers, sales representatives etc.; scientific and technical literature, i.e. articles, patents, catalogues, etc.. Interviews and searches to elicit information from these sources can be driven by specific tools. At the beginning of the study general structured questionnaires are useful to follow a systematic approach in order to identify functions, relationships with the environment, causal relationships. An example of structured questionnaire well known by the TRIZ community is the Innovation Situation Questionnaire (ISQ) [16]. The authors have created a customized questionnaire which allow to perform a similar investigation, according to the models mentioned in section 3.1, thus collecting information about EMS flows, identifying the main four elements for each function, mapping hierarchical relations among those elements.

The answers provided by the experts can be integrated by specific literature searches; modern text mining technologies provide valuable means to improve the efficiency of this task [17].

Once the general data about the system have been collected, their classification can be approached according to the LESE as explained in the following section. Such a structured view of the gathered information clearly raises new questions both to complete the map under construction and to validate the directions suggested by TRIZ trends of evolution. Again experts and literature are fruitful complementary sources to complete the task.

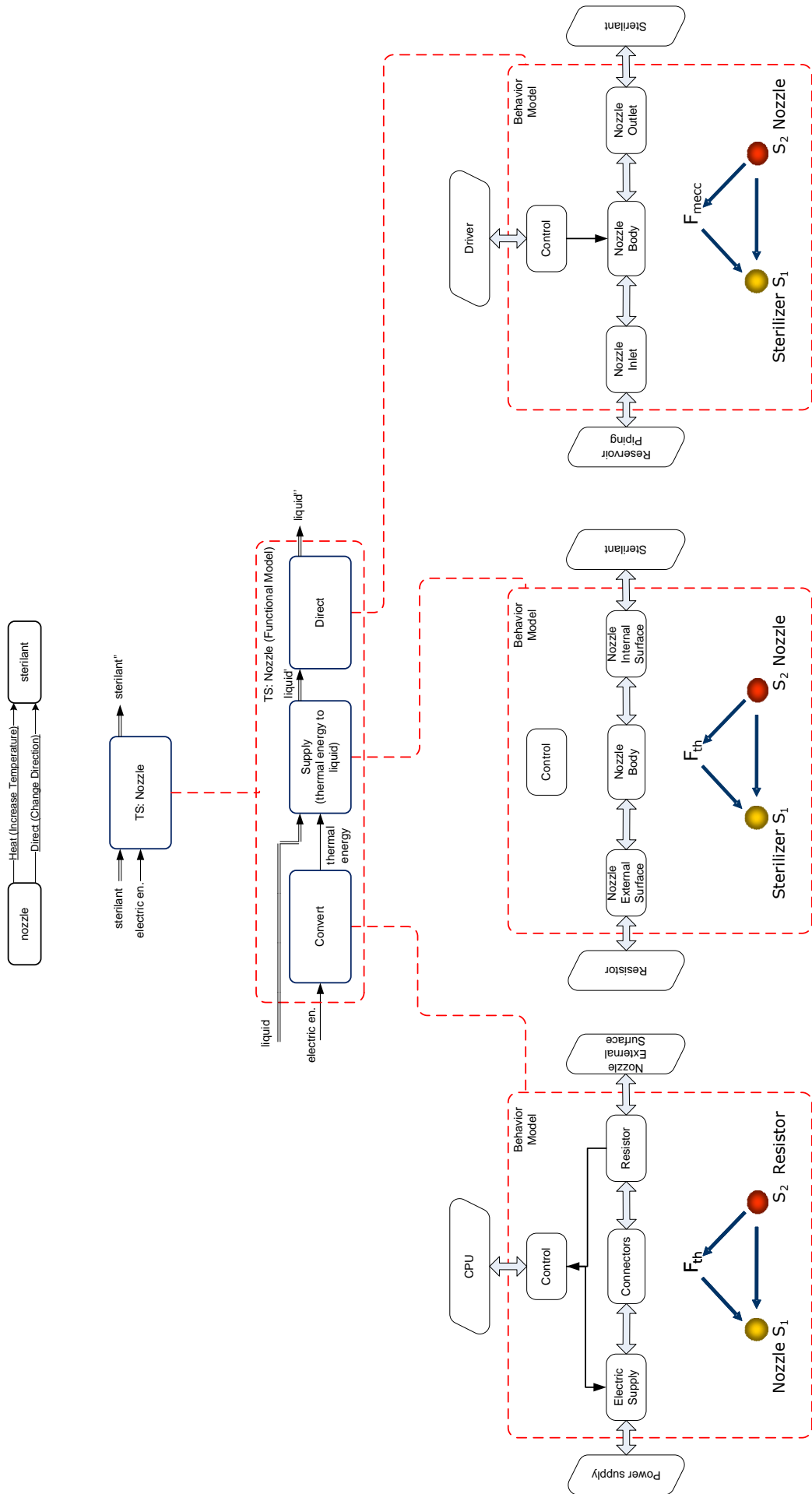

Figure 4: Integrated model for functional-behavioral analysis.

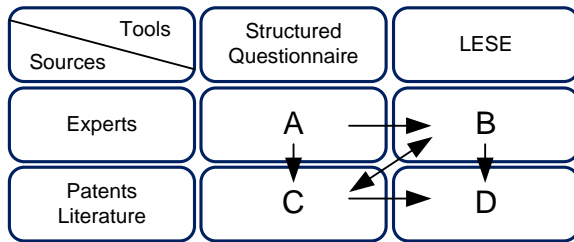

Figure 5: Main sources of information and tools for classification.

### 3.4 Main steps of the algorithm

The main steps of the proposed algorithm are represented in figure 6. Further details of each step will be provided in section 3.5.

The preliminary analysis of the TS aims at the identification of the MUF, the Structure and the Behavior of the system at different detail levels, both of its current version and its historical evolutionary steps. Then the resulting functional and behavioral models are compared according to TRIZ trends of evolution. The third step consists in assembling the relevant trend recognized for each element into a map representing also: links between different generations of the TS characterized by a different behavior, usually due to a Transition to Microlevel; links between the four elements of each minimal technical system associated to each function; links between an element and its subsystems. Browsing the Nxxx is then possible to identify missing implementations of the TS through trends interpolation/extrapolation: within this fourth step, unexpected patent activities of the competitors are likely to appear, as well as virgin scenarios where to focus R&D activities. Finally the limits of the Nxxx validity must be checked by analyzing what happens if an assumption fails or a certain functional parameter has sudden variations out of the expected range.

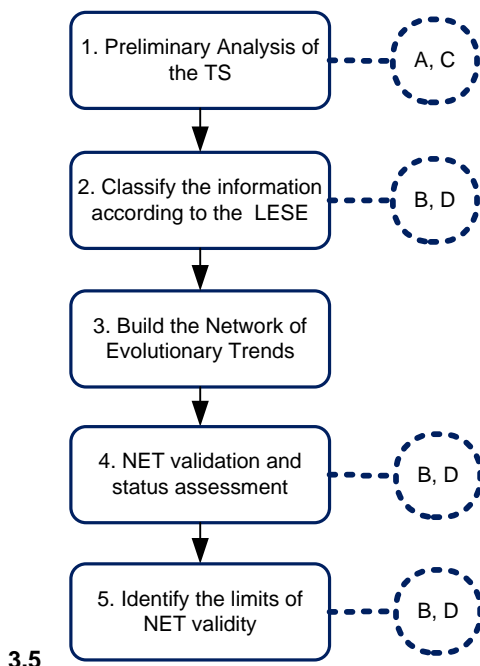

Figure 6: Main steps of the algorithm and relationships with Information sources and gathering tools (fig. 5).

### 3.6 Detailed description of the algorithm

Each of the abovementioned steps consists in several sub-steps and clearly requires a detailed description within the limits of the paper extension. In order to clarify the proposed concepts, some trivial over-simplified examples are reported.

#### 1. Preliminary analysis of the TS

##### 1.1 Identify the MUF of the TS, its characterizing parameters and expected values

- Identify the Evaluation Parameters defining the performance of the MUF
- Decompose the MUF, according to the Functional Basis [14], into elementary functions needed to impact those Evaluation Parameters
- Identify constraints and minimum performance values (e.g. due to standards, certification systems etc.)

##### 1.2 Analyze the goal of the TS and the role of its MUF at a super-system level; identify all the functions acting on the same object of the MUF

- E.g.: Let's consider a sterilization module in a machinery for aseptic filling of beverage containers; its function is reducing the amount of pathogenic organisms (Evaluation Parameter) in the container, e.g. a bottle, before to fill it, until a sealed cap will be applied; in this case it is important to identify further functions acting on the bottle, e.g. handling, because they can interfere with the TS under study.

##### 1.3 Identify the alternative Behavioral Models (BM) of the TS capable to produce the expected MUF

- This task should be performed taking into account also out-of-date configurations of the TS
- Only different BM of the MUF should be mapped, while other differences between possible embodiments (structures) of the TS can be neglected at this stage
- E.g.: Let's consider a machine for rubber pulverization (MUF): alternative BMs are cryogenic milling, high-speed cutting, high compression and shear milling, waterjet cutting etc.

##### 1.4 Identify the Auxiliary Functions requested by each specific BM of the MUF

- E.g.: in the example of bottle sterilization, if the elimination of bacteria is obtained through a chemical substance like peracetic acid, an auxiliary function to be delivered is bottle rinsing, since even small drops of the sterilizer could negatively impact the taste of the beverage.

##### 1.5 Identify the undesired Harmful Effects generated by each specific BM of the MUF

- This step leads to the identification of Technical Contradictions in the following form: the Structure of the TS should have the behavior represented by BM in order to deliver the MUF, but should not have such a behavior in order to avoid its harmful effects

##### 1.6 Identify the amount of resources required by each BM to deliver the MUF

- In order to allow a comparison between different systems with the same BM, the resources should be normalized to the same performance parameter

or vice versa performances can be compared with respect to the same usage of resources

- In order to allow a comparison between different BMs, resources should be grouped into homogeneous classes, the most general classification being resources related to Space, Time, Energy, Material, Information
- The analysis of the resources must take into account also the Auxiliary (necessary) Functions identified at step 1.4

#### 1.7 Build the Minimal Technical System model of each BM of the MUF and of the other functions identified at step 1.2-1.4

- Complete the model with Su-Field analysis of each pair of interacting elements (e.g. figure 4)

### 2. Classify the information according to the LESE

#### 2.1 Compare the BMs of the MUF according to the Law of Transition to Microlevel

- The transition from macro to micro level, i.e. a transition to a smaller scale of the principle a BM is based on, is a typical trend of technical systems. Since such a transition is typically associated to major changes in the TS, it is suggested to apply this classification of the BMs before than proceeding with more detailed comparisons

#### 2.2 Analyze the Structure associated to each BM of the MUF and its level of completeness according to the first Law of evolution

- Check if the supply of the flow characterizing the MUF is integrated in the TS
- Check if the control of the flow characterizing the MUF is integrated in the TS and which is the controlled element
- This step, as well as the followings, should be performed iteratively for each BM of the MUF

#### 2.3 Analyze the Structure associated to each Auxiliary Function and its level of completeness according to the first Law of Evolution

#### 2.4 Analyze the interactions between each pair of elements of the Minimal Technical System for each BM of the MUF and perform a comparison according to the LESE and the TRIZ trends of evolution

- The priority should be given to the interaction existing between the Tool and the Object, then to the other pairs of elements, i.e. Transmission-Tool, Supply-Transmission, Control-Tool etc.
- Among the different formulations of TRIZ trends of evolution available in literature, the authors make use of the followings to be applied to each pair of elements
- Increase of controllability: introduce closed-loop feedbacks, move the control closer to the tool
- Geometric harmonization: geometrical evolution (1D-2D-3D and related modifications), increase of asymmetry, segmentations (voids, surface, volume), dynamization
- Rhythm harmonization: parts coordination, frequency of action
- Material harmonization (it is worth to note that this is not a classical TRIZ trend; nevertheless, the authors have encountered several systems evolving towards a harmonization of the materials of interacting elements)

- Mono-Bi-Poly and Trimming: Mono-Function Homogeneous systems, Mono-Function systems with Shifted Characteristics, Multi-Function Heterogeneous systems, Inverse Function, Partial Trimming, Extended Trimming; the assessment of the evolution-convolution stage should be performed also by taking into account the ratio between the performance of the function under analysis and the resources involved for its implementation

- Increase of Fields involvement

#### 2.5 Analysis of the contradictions and their relationships with the trends formulated at step 2.4

- Contradictions identified at step 1.5 disappearing due to the application of one or more trends
- Contradictions identified at step 1.5 not solved by the trends
- New contradictions emerging by the application of a specific trend of evolution
- New contradictions emerging by the application of two or more trends generating conflicts between the available resources

### 3. Build the Network of Evolutionary Trends

#### 3.1 Order the Minimal Technical System models of each BM of the MUF according to the trend Transition to Microlevel analyzed at step 2.1

#### 3.2 Within the same stage of Transition to Microlevel, order the BMs according to their completeness (without recurring to the support of external systems or to humans)

#### 3.3 Add the models of decomposed subsystems (figure 2, below)

#### 3.4 Add the models of the functions identified at step 1.2

#### 3.5 Represent as branches of a network the trends identified at step 2 by links to the corresponding elements of the model built at steps 3.1-3.4

### 4. NET Validation and status assessment

#### 4.1 Mark the nodes of the network corresponding to an existing configuration of the TS

- The authors usually apply a red circle around these nodes; further differentiations can be applied by highlighting with different colors sub-classifications like competitors, years of development, market sectors etc.

#### 4.2 Mark the nodes of the network corresponding to features found in patents, but still not brought to the market

- The authors usually apply a yellow circle around these nodes (figure 7, above).

#### 4.3 Identify new opportunities of implementation of the TS

- Recognize interpolation opportunities due to missing configurations in a trend of evolution (figure 7, middle).
- Recognize extrapolation opportunities due to not exhausted trends of evolution (figure 7, below).
- The authors usually apply a green circle around these nodes

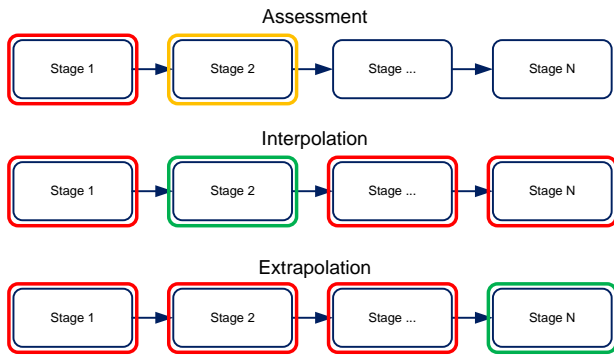

Figure 7: Evolutionary assessment of the Nxxx branches and identification of new opportunities for the TS.

### 5. Identify the limits of NET validity

#### 5.1 Search for functions alternative to the MUF capable to achieve the same overall goal

- It is suggested to start from the results of the analysis performed at step 1.2 and to apply the System Operator in order to identify alternative functions (in different screens) providing the same benefits of the MUF to the supersystem

#### 5.2 Analyze the parameters of the object of the MUF and check which variation of such parameters makes the TS incapable to provide the expected benefits, thus failing in the achievement of the goal

#### 5.3 Analyze the parameters of the object of the MUF and check which variation of such parameters makes the TS useless

#### 5.4 Investigate the impact of the removal of the constraints identified at step 1.1 or the introduction of new ones

The description of the algorithm (and most of all, steps 2.4 and 2.5) should be further detailed, but due to space limitations the authors have limited the explanation of tasks accomplished according to procedures already well discussed in literature (e.g. [8, 9]).

It is worth to notice that the structured approach of the investigation together with the precise directions of search provided by the trends (e.g. in step 2.4) allows to perform very precise questions to the experts, thus triggering their implicit knowledge, as well as to make use to a maximum extent of the functionalities provided by modern Text-Mining technologies, while analyzing electronic documents like patents and scientific papers.

## 4 EXEMPLARY APPLICATION: BOTTLE STERILIZATION FOR ASEPTIC FILLING

The authors have tested the proposed algorithm in three extended case studies related to disabled walkers, wood pellets production and aseptic filling of beverage containers. The latter is here reported as exemplary application.

The case study was conducted from September 2007 to February 2008 within a project aimed at the identification of next future technologies for bottle sterilization, coordinated by the R&D Department of GEA-Procomac a leading company in the field of aseptic filling.

The role of the University of Florence was the definition of a structured set of scenarios to support company's management in the selection of the most appropriate directions for investment.

The algorithm was carefully applied to collect and classify the implicit knowledge of company's experts as well as to direct the search for further relevant information from patent databases and other scientific sources.

Figure 4 is an exemplary result of the partial results produced after accomplishing the step 1.7, related to the function performed by the nozzle to the sterilant (tool of the sterilization process).

A comparison of the behavioral models according to the Law of Transition to Microlevel (step 3.1) and to the Law of Completeness (step 3.2) allows to create a preliminary overall map of the TS evolution (figure 8).

Then each behavior has been detailed by identifying the stage of development of each interacting pair of the corresponding Minimal Technical System according to the trends of systems evolution.

An excerpt of the resulting Nxxx is shown in figure 9: the application of hydrogen peroxide ( $H_2O_2$ ) as sterilant through a condensing film is performed by means of a nozzle subjected to several trends of evolution, but still open to further exploitation (figure 9).

For confidentiality issues the authors are not allowed to show further details from the most actual portions of the Nxxx. Nevertheless, it is worth to mention that at the end of the project it was possible to identify several relevant patents not known before to Procomac's R&D department, even outside the traditional field of sterilization by means of chemicals. Due to the high compatibility of those solutions with the possible scenarios of evolution, the company has therefore identified new technologies to be monitored to avoid the appearance of unexpected innovations from the competitors.

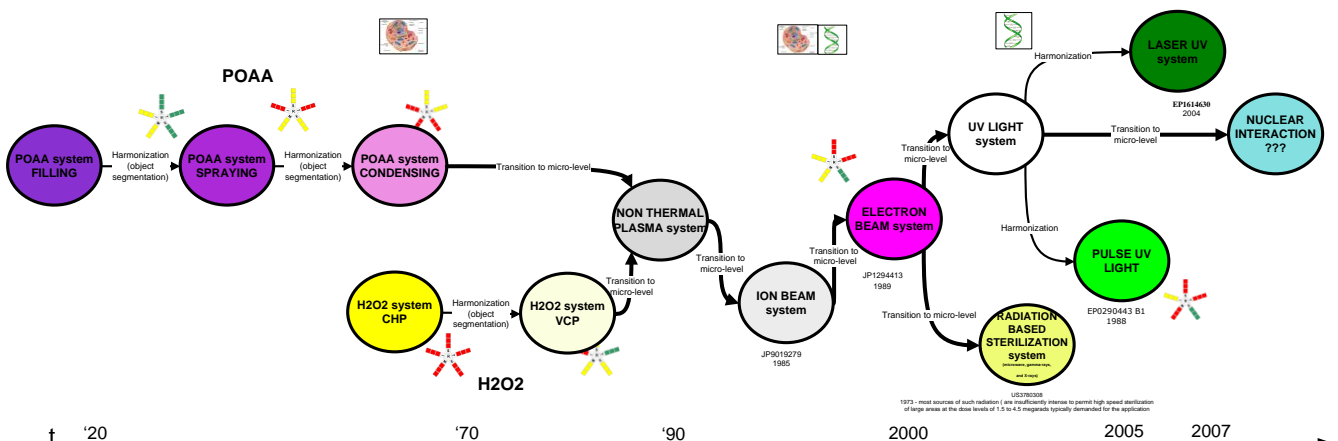

Figure 8: Aseptic filling: ordered set of Behaviors related to the MUF of a sterilizing apparatus, i.e. reduce the amount of pathogenic bacteria on a beverage container (step 3.1 of the proposed algorithm).

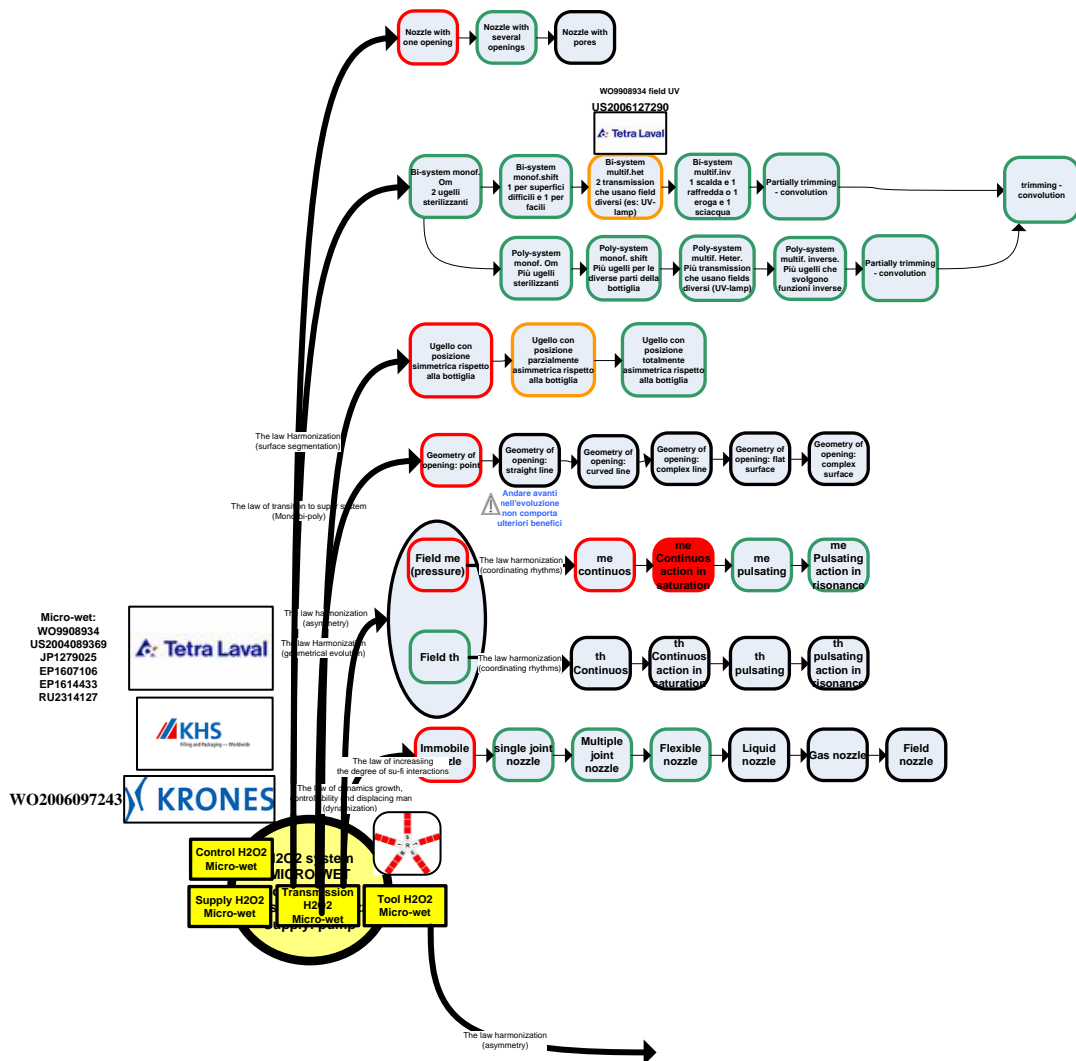

Figure 9: Aseptic filling: excerpt of the Nxx related to the so-called “microwet” technology for H<sub>2</sub>O<sub>2</sub> based sterilization.

Moreover, the Nxx has been used to define the strategic development of R&D activities, of course in accordance with the company's vision. The authors consider the positive judgment by the company of the proposed results a contribution to the validation of the algorithm presented in this paper.

## 5 CONCLUSIONS

The original algorithm for system analysis presented in this paper has revealed so far an adequate applicability to technical systems belonging to different fields of application and with radically different characteristics (operating machines, end products etc).

As a result it is possible to build with systematic and repeatable steps a Network of Evolutionary Trends to be used for supporting multi-criteria decisions and to highlight opportunities of development.

Compared with TRIZ-based forecasting approaches published in literature, the authors have focused their attention on the definition of a precise procedure to identify the elements and the features to be analyzed and benchmarked according to the TRIZ Laws of Evolution.

The authors are further developing the proposed algorithm with the aim of taking into account the analysis of entire business processes, where the evolution of each technical system involved in the process is impacted also

by the development of the engineering systems adopted in the other phases; thus, the process itself as a whole is considered as an evolutionary engineering system.

A further direction for investigation is the definition of criteria to prioritize the analysis of certain branches or details of the network. Indeed, when an express analysis is needed due to time or resources constraints, it is suggested to limit the study to the interactions Tool-Object and Control-X (according to the element of the system subjected to a control action). By the way, despite its intuitive nature, the last statement is still to be supported by a proper validation.

## ACKNOWLEDGMENTS

The authors would like to thank Alessandro Cardillo and Tiziano Montecchi from Università di Firenze for their contribution to the development of the present research and to Paolo Pagliarini R&D Director at Procomac and his team for the feedbacks related to the implementation of the algorithm in a real case study.

## REFERENCES

- [1] Porter, A.L. et al.: “Technology Future Analysis: Toward integration of the field and new methods”. Technological Forecasting & Social Change 71, pp. 287–303, 2004.



- [2] Kucharavy, D. and De Guio, R.: "Problems of Forecast". Proceedings of the 5th ETRIA TRIZ Future Conference, ISBN 3-7011-0057-8, Graz, Austria, November 16-18, 2005.
- [3] Altshuller, G.S.: "Creativity as an Exact Science: The Theory of the Solution of Inventive Problems". Gordon and Breach Science Publishers, ISBN 0-677-21230-5, 1984 (original publication in Russian - 1979).
- [4] Salamatov, Y.P.: "System of The Laws of Technical Systems Evolution" in Chance to Adventure (in Russian), ISBN 5-7545-0337-7. Karelia Publishing House, Petrozavodsk, 1991. pp. 7-174.
- [5] Kucharavy, D.: "TRIZ instruments for forecasting: past, present and future". Tutorials at the 7th ETRIA TRIZ Future Conference, Frankfurt, Germany, 6-8 November 2007.
- [6] Fey V. R., Rivin E. I.: "Guided Technology Evolution (TRIZ Technology Forecasting)". The TRIZ Journal, January 1999, available at <http://www.triz-journal.com/archives/1999/01/c/index.htm>.
- [7] Cavallucci, D.: "Integrating Altshuller's development laws for technical systems into the design process". CIRP Annals - Manufacturing Technology, vol. 50(1), 2001, pp. 115-120.
- [8] Zlotin, B.L. and Zusman, A.V.: "Directed Evolution. Philosophy, Theory and Practice". Ideation International Inc. ISBN 192874706X, 2001.
- [9] Shpakovsky N.: "Evolution Trees. Analysis of technical information and generation of new ideas" (in Russian), ISBN 5-9348-6048-8, TRIZ Profi, 2006.
- [10] Pahl, G. and Beitz, W.: "Engineering Design. A Systematic Approach", 2<sup>nd</sup> edition, Springer, ISBN:3540199179, 544 pp., 1996.
- [11] Ogot M.: "EMS Models: adaptation of engineering design black-box models for use in TRIZ", Proceedings of the 4th TRIZ Future Conference, Florence, 3-5 November 2004, published by Firenze University Press, ISBN 88-8453-221-3, pp.333-343.
- [12] Gero, J.S. and Rosenman, M.A.: "A conceptual framework for knowledge based design research at Sydney University's Design Computing Unit". Artificial Intelligence in Engineering, Vol. 5(2), 1990, pp. 65-77.
- [13] Takeda, H., Yoshioka, M., Tomiyama, T. and Simomura, Y.: "Analysis of Design Processes by Functional Evaluation Process", in N. Cross, H. Christiaans and K. Dorst eds., Analysing Design Activity, John Wiley & Sons, Chichester 1996, pp. 187-209.
- [14] Hirtz, J., Stone, R. B., McAdams, D. A., Szykman, S. and Wood, K. L.: "A Functional Basis for Engineering Design: Reconciling and Evolving Previous Efforts", NIST (National Institute of Standards and Technology) Technical Note 1447, February 2002.
- [15] Kitamura, Y., Kashiwase, M., Fuse, M., Mizoguchi, R.: "Deployment of an ontological framework of functional design knowledge", Advanced Engineering Informatics, Volume 18, Issue 2, April 2004, Special Issue on Ontology and it's Applications to Knowledge-Intensive Engineering, Pages 115-127.
- [16] Terninko, J., Zusman, A., Zlotin, B.: "Systematic Innovation: An Introduction to TRIZ", St. Lucie Press, ISBN 1574441116, 208 pages, 1998.
- [17] Cascini, G., Fantechi, A., Spinicci, E.: "Natural Language Processing of Patents and Technical Documentation", Lecture Notes in Computer Science, Springer-Verlag Heidelberg, ISBN: 3-540-23060-2, DOI: 10.1007/b100557, December 2004, pp. 508-519.