
Masters

Built Environment

2019-5

Idea, Form, Reality – the Implications of Natural Ventilation Strategies on public Buildings in Temperate Maritime Climates

Michael P.G. Haslam
Technological University Dublin

Follow this and additional works at: <https://arrow.tudublin.ie/builtmas>



Part of the [Architectural Engineering Commons](#), and the [Architectural Technology Commons](#)

Recommended Citation

Haslam, M. P.G. (2019) Idea, Form, Reality – the Implications of Natural Ventilation Strategies on public Buildings in Temperate Maritime Climates, Masters Thesis, Technological University Dublin.

This Theses, Masters is brought to you for free and open access by the Built Environment at ARROW@TU Dublin. It has been accepted for inclusion in Masters by an authorized administrator of ARROW@TU Dublin. For more information, please contact yvonne.desmond@tudublin.ie, arrow.admin@tudublin.ie, brian.widdis@tudublin.ie.



This work is licensed under a [Creative Commons Attribution-Noncommercial-Share Alike 3.0 License](#)

Idea, form, reality – the implications of Natural
Ventilation Strategies on public buildings in
temperate maritime climates

Michael P.G. Haslam, B.Sc.; B. Arch.; RIAI; RIBA

Submitted to the School of Architecture, Technical University
of Dublin, in fulfilment of the requirements leading to the
award of Master of Philosophy May 2019

Supervisors:

Noel Brady, Dip Arch, B Arch Sci, S.M.Arch.S, FRIAI.

Orna Hanley Dip Arch, B Arch Sci, MSc, FRIAI

Abstract

Natural ventilation is one of the prime form givers in environmentally responsive architecture – in its detail and its architecturally charged form of stacks and voids. It facilitates our understanding of a response to natural systems – not just in how it responds visually to warm and cool air but also in the adaptive approach to thermal comfort.

The purpose of this research is to investigate the impacts and implications of natural ventilation strategies for different typologies of public and commercial buildings. This is with the aim of attempting to define a vocabulary of ventilation techniques and details that are suited to particular categories of buildings within the temperate maritime climate of Europe.

The effectiveness of the natural ventilation strategies are investigated through the parameters of energy usage, internal air quality, thermal comfort and operation. Following these, the different architectural responses to the physics of natural ventilation have been examined and in particular in the more detailed responses of differing building types. From this we can start to define appropriate strategies and the formal response of building types to natural ventilation.

Declaration

I certify that this thesis which I now submit for examination for the award of Master of Philosophy, is entirely my own work and has not been taken from the work of others, save and to the extent that such work has been cited and acknowledged within the text of my work. This thesis was prepared according to the regulations for graduate study by research of the Technical University of Dublin and has not been submitted in whole or in part for another award in any other third level institution. The work reported on in this thesis conforms to the principles and requirements of the Technical University of Dublin guidelines for ethics in research. The Technical University of Dublin has permission to keep, lend or copy this thesis in whole or in part, on condition that any such use of the material of the thesis is duly acknowledged.

Signature _____ Date 20th September 2019.

Word count: 38,580

Acknowledgements

I wish to thank my both my present supervisors Noel Brady and Orna Hanley and my previous, Dr Anthony Farrell, for their assistance and support. I also wish to thank my family, particularly my wife Simona Castelli and daughter Zoë, my parents, for their support and interest throughout the process and Tim O’Leary and Dr. Eoghan O’Shea for their invaluable critique.

Abbreviations

ANV – Advanced Natural Ventilation

ASHRAE - American Society of Heating, Refrigerating and Air-Conditioning Engineers

BEMS – Building Energy Management System

BRE - Building Research Establishment

BRI - Building related illness

CEN - European Committee for Standardization

CFD Computational fluid dynamics

CIBSE - Chartered Institution of Building Services Engineers

EPBD - Energy Performance of Buildings Directive

IAQ – Internal Air Quality

IPCC - United Nations' Intergovernmental Panel on Climate Change

MVHR – Mechanical Ventilation Heat Recovery

PMV- Predicted Mean Vote

POE – Post Occupancy Evaluation

PPD – Predicted Percentage of Dissatisfied

PROBE - Post Occupancy Review of Building Engineering

SBS - Sick Building Syndrome

SNV – Simple Natural Ventilation

SQM – square metre

VOC - volatile organic compounds

Table of Contents

List of Tables and Figures

1. Chapter one: Introduction

- 1.1. Context of Research
 - 1.1.1. Designing within a Culture of Sustainability
- 1.2. Purpose and objectives
- 1.3. Delimitations

2. Chapter two: Literature Review

- 2.1. The role of ventilation in buildings
- 2.2. Building regulations
- 2.3. Achieving ventilation
- 2.4. Benefits of natural ventilation
- 2.5. Measuring Success - Parameters of successful ventilation
- 2.6. Energy Use Reduction
 - 2.6.1. The impact of climate change.
 - 2.6.2. Legislation.
 - 2.6.3. Energy and Ventilation
 - 2.6.4. Heat Reclaim.
 - 2.6.5. Energy consumption benchmarks
- 2.7. Thermal Comfort
 - 2.7.1. Internal Heat Gains
 - 2.7.2. External heat gains
 - 2.7.3. Steady state comfort criteria
 - 2.7.4. Adaptive comfort theory
 - 2.7.5. Occupant control and adaption
 - 2.7.6. Thermal symbolism
 - 2.7.7. Localised thermal discomfort
 - 2.7.8. Thermal Comfort Benchmarks
- 2.8. Internal Air Quality (IAQ)
 - 2.8.1. Poor Internal Air Quality
 - 2.8.2. Building related illness (BRI) and Sick Building Syndrome (SBS).
 - 2.8.3. Indoor environment and performance
 - 2.8.4. Air changes and ventilation rates
 - 2.8.5. Bench mark data for IAQ
- 2.9. Ease of Operation
 - 2.9.1. Types of operating systems
 - 2.9.2. Control of natural ventilation systems
 - 2.9.3. Components of a ventilation system
 - 2.9.4. BEMS user interface

- 2.9.5. Cost
- 2.9.6. Ease of operation – key benchmarks
- 2.10. Summary
- 2.11. Driving forces for Natural Ventilation
 - 2.11.1. Site design issues
 - 2.11.2. Wind pressure and thermal buoyancy
 - 2.11.3. Natural ventilation strategies
 - 2.11.4. Selecting the strategy
 - 2.11.5. Design Tools
- 2.12. Natural Ventilation, the Architectural Response
 - 2.12.1. The vernacular of ventilation
 - 2.12.2. The vernacular of biological organisms
 - 2.12.3. The architecture of natural ventilation
 - 2.12.4. Related design issues
 - 2.12.5. Vocabulary of ventilation, a summary
 - 2.12.6. Natural Ventilation System Components
- 2.13. Vocabulary of ventilation: Offices
 - 2.13.1. Key architectural elements for naturally ventilated office spaces
- 2.14. Vocabulary of ventilation: Auditoria
 - 2.14.1. Key elements for naturally ventilated auditoria
- 2.15. Vocabulary of ventilation: ANV in deep plan buildings
 - 2.15.1. Key architectural elements for ANV buildings

3. Chapter Three Case Study Methodology

- 3.1. Introduction
- 3.2. Case Studies
- 3.3. Methodology

4. Chapter 4 Case Studies

- 4.1. Case study 1: Limerick County Council Offices
 - 4.1.1. Context
 - 4.1.2. Metrics
 - 4.1.3. Natural ventilation strategy
 - 4.1.4. Qualifiers
 - 4.1.5. Design issues
 - 4.1.6. Operational Issues
 - 4.1.7. Natural Ventilation Design Development
- 4.2. Case Study 2: Auditoria: Contact Theatre, Manchester, UK
 - 4.2.1. Context
 - 4.2.2. Metrics
 - 4.2.3. Natural ventilation strategy
 - 4.2.4. Qualifiers

- 4.2.5. Design issues
- 4.2.6. Operational Issues
- 4.3. Case Study 3 Libraries: Lanchester Library, Coventry, UK
 - 4.3.1. Context
 - 4.3.2. Metrics
 - 4.3.3. Natural ventilation strategy
 - 4.3.4. Qualifiers
 - 4.3.5. Design issues
 - 4.3.6. Operational Issues

5. Chapter 5: Recommendations

- 5.1. Study Parameters
- 5.2. Further refinement
- 5.3. Design Fundamentals
- 5.4. Further Research Areas
- 5.5. The Pattern Which Connects

Bibliography

Appendices

- Appendix 1: Initial interview format for operational managers
- Appendix 2: Follow up Questionnaire for Facility Managers
- Appendix 3: Interview with Pdraig Power Facilities manager
- Appendix 4: Interview with Merritt Bucholz 7th September 2017
- Appendix 5: interview with Steve Curtis Operations Manager
- Appendix 6: Interview with Mike Langmead Operations manager
- Appendix 7: List of publications

List of tables and figures

	description	acknowledgement
Table 1	Spectrum of ventilation methods	author
Table 2	Vocabulary of ventilation – a summary	author
Table 3	Ventilation system components	CIBSE AM10
Table 4	Characterization of ANV strategies	Lomas
Table 5	Case study selection criteria	author
Figure 1	Heat loss mechanisms of the human body	Clinical gate
Figure 2	Mean Annual wind speed, Ireland	Met Eireann
Figure 3	Wind roses, Ireland	Met Eireann
Figure 4	Mean annual wind speed UK	Met Office UK
Figure 5	Wind directional pressures on buildings	Thomas R
Figure 6	Wind directional pressures on site layout	Thomas R
Figure 7	Wind pressure ventilation	author
Figure 8	Thermal buoyancy ventilation	author
Figure 9	Single sided and cross ventilation strategies	author
Figure 10	Wind pressure and thermal buoyancy	unknown
Figure 11	Passive stack ventilation, design rules	Short Associates
Figure 12	Wind tunnel testing	Loughborough Uni
Figure 13	Wind tunnel testing	Loughborough Uni
Figure 14	CFD modelling	Meteo dyn
Figure 15	Smoke visualisation test	BRE
Figure 16	Badgir, wind scoop and exhaust.	unknown
Figure 17	Urban wind scoops, Hyderabad	Creative commons
Figure 18	Section through Bagdir	author
Figure 19	Section through Long House	author
Figure 20	Human respiratory system	Army medical publ.
Figure 21	Termite mound ventilation routes	What-when-how.com
Figure 22	Blue Water shopping centre wind scoop	Battle- McCarthy
Figure 23	BedZed wind cowls	Bill Dunster Architects
Figure 24	GSW Tower Berlin, double skin stack	Sauerbruch Hutton Architects
Figure 25	St Mary Axe, sky gardens	Foster Associates
Figure 26	Thermal mass in ceiling deck Woodland Trust HQ	Feilden Clegg Bradley -Studios
Figure 27	Atrium ventilation system in SSEES, London	Short Associates,
Figure 28	Bench topped air inlet to earth tubes,	Solearth Architecture
Figure 29	Air vent outlets to earth tubes, Airfield Estate,	Solearth Architecture
Figure 30	UK open plan office design	Shahzad S.
Figure 31	Inland Revenue Centre, internal axonometric	Hopkins Associates
Figure 32	Inland Revenue Centre, internal view	Hopkins Associates
Figure 33	BRE office building south elevation;	Feilden Clegg Architects
Figure 34	BRE office building interior;	Feilden Clegg Architects
Figure 35	BRE office building section	Feilden Clegg Architects
Figure 36	Fingal County Hall atrium	Bucholz McEvoy Architects
Figure 37	Portcullis House, ventilation stacks	Hopkins Associates
Figure 38	Key architectural elements NV office spaces	author
Figure 39	Kursaal interior,	author
Figure 40	Kursaal, section, Harrogate UK	author
Figure 41	Bedaes Theatre, external view, UK;	Feilden Clegg Architects

Figure 42	Bedales Theatre, internal view, UK;	Feilden Clegg Architects
Figure 43	Bedales Theatre, section, UK;	Feilden Clegg Architects
Figure 44	Axonometric, Queens Building, De Montfort University; UK	Short Ford Associates
Figure 45	Interior of auditorium, Queens Building	Short Ford Associates
Figure 46	Key architectural elements NV auditoria	author
Figure 47	Interior of the Reading Room, British Museum,	British Museum archive
Figure 48	Queens Building, 'edge in – centre out'	Short Ford Associates
Figure 49	Judson University Library, Chicago	Alan Short Associates
Figure 50	Queens Building, street view	Short Ford Associates
Figure 51	Key architectural elements ANV	author
Figure 52	Limerick C.C. Offices south west façade	author
Figure 53	Limerick C.C. Offices north east façade	author
Figure 54	Limerick County Council Offices site plan	author
Figure 55	Limerick C.C. Offices timber brise-soleil	author
Figure 56	Limerick C.C. Offices interior of offices	author
Figure 57	Schematic plan of Limerick C.C. Offices	author
Figure 58	Schematic section of Limerick C.C. Offices	author
Figure 59	Limerick C.C. Offices north west end of atrium	author
Figure 60	Limerick C.C. Offices south east end to atrium	author
Figure 61	Limerick C.C. Offices internal view of atrium	author
Figure 62	Limerick C.C. Offices internal view of atrium	author
Figure 63	Limerick C.C. Offices BEMS user interface	author
Figure 64	Natural ventilation elements of Limerick C.C. Offices	author
Figure 65	Limerick C.C. Offices atrium - shutters	author
Figure 66	Limerick C.C. Offices atrium showing actuator	author
Figure 67	Limerick C.C. Offices internal elevation	author
Figure 68	Limerick C.C. Offices exposed thermal mass	author
Figure 69	Limerick C.C. Offices detail of shutter screen	author
Figure 70	SAP Building Atrium, Galway	Bucholz McEvoy Architects
Figure 71	Westmeath County Council building – double skin façade to south elevation	Bucholz McEvoy Architects
Figure 72	public entrance to the Contact Theatre,	author
Figure 73	Contact theatre site plan	author
Figure 74	Contact Theatre -schematic long section theatre	author
Figure 75	Contact Theatre - schematic cross section theatre	author
Figure 76	Contact Theatre - schematic ground floor plan	author
Figure 77	Contact Theatre - louvered air intake to main theatre space	author
Figure 78	Contact Theatre - acoustic attenuation into main theatre	author
Figure 79	Contact Theatre: heating elements and grills	author
Figure 80	Contact Theatre - ventilation grills to rear of seating in main auditorium	author
Figure 81	Contact Theatre - main auditorium space	author
Figure 82	Contact Theatre - main auditorium space	author
Figure 83	Contact Theatre - view from western courtyard with main theatre in foreground	author
Figure 84	Contact Theatre - air intake for foyer	author

Figure 85	Contact Theatre - ground floor of foyer	author
Figure 86	Contact Theatre - plenum beneath studio theatre	author
Figure 87	Contact Theatre - studio theatre space, inlet grills in floor and outlet at top of walls	author
Figure 88	Contact Theatre - detail view of brick H-pots to studio theatre	author
Figure 89	Contact Theatre - BEMS user interface	author
Figure 90	Natural ventilation elements of the Contact Theatre	author
Figure 91	Contact Theatre - courtyard to rear of main theatre showing louvered air intake beyond fire escape	author
Figure 92	Contact Theatre - brick stacks to studio theatre	author
Figure 93	Contact Theatre - zinc-clad stacks to main theatre	author
Figure 94	Lanchester Library - main entrance elevation	author
Figure 95	Lanchester Library - site plan	author
Figure 96	Lanchester Library - schematic ventilation plan	author
Figure 97	Lanchester Library - schematic roof plan	author
Figure 98	Lanchester Library - schematic section showing ventilation outlets	author
Figure 99	Lanchester Library - schematic section showing ventilation inlets	author
Figure 100	Lanchester Library - perimeter extract stacks	author
Figure 101	Lanchester Library - inlet vents at base of building	author
Figure 102	Lanchester Library - view of extract stacks at roof	author
Figure 103	Lanchester Library - plenum beneath light well/ air ingress and fin heating radiators	author
Figure 104	Lanchester Library - light well/ air ingress showing louvers	author
Figure 105	Lanchester Library - central light well/ air extract showing louvers at high level	author
Figure 106	Lanchester Library - main library floor showing wall extract vents at high level	author
Figure 107	Lanchester Library - top library floor showing ceiling extract vents	author
Figure 108	Lanchester Library - main library floor showing low level ingress vents and heating floor ducts adjacent	author
Figure 109	Lanchester Library - main library floor showing wall extract vents at high level	author
Figure 110	Natural ventilation elements of Lanchester library	author
Figure 111	Lanchester Library - external view perimeter towers	author
Figure 112	Lanchester Library - detail view of multi-directional extract stacks	author
Figure 113	Lanchester Library - ground floor looking up into the central extract light well	author
Figure 114	Key natural ventilation elements	author
Figure 115	Idealised office building section	author
Figure 116	Idealised auditorium section	author
Figure 117	Idealised deep plan and section	author

1.0 Chapter One Introduction

1.1. Context of Research

We live in a time of uncertainty in our relationship with planet Earth with concerns about our future fuel supplies, planetary warming and toxicity in our environment and our resultant health. These concerns compel us as architects to consider how to design buildings that use less energy and are also comfortable and healthy. Not only ecosystems but also human societies are put at risk by climate change: the present mainstream sustainability debate centres on the compromises between social justice, ecological integrity and economic well-being. As we debate these issues we put our hopes of environmental salvation in green technological innovations. We need, however, a more paradigmatic shift in world views if ecology and human society are to survive and flourish. It is argued that the foundations of this shift towards a culture of sustainability should be based in systems thinking.

1.1.1 **Designing within a Culture of Sustainability.** Capra F. (1997) proposes a systems view of planet Earth in ‘The Web of Life’ and uses the concept of networks as its cornerstone. A network is a pattern common to all life from the metabolic networks inside cells to the food webs in human societies; the components of a living system are interlinked in a network fashion. An important point about systems thinking is that it is contextual. Philosopher and sociologist, Edgar Morin (Kagan S. 2011, p185) makes the point that the ‘alpha idea’ of all ecological thought is that the independence of a living being necessitates its dependence on its environment; our state of ‘inter-dependence’.

Human society has reached transformative capabilities in relationship to the world ecosystem and with this, has gained responsibilities. We need to apply our ecological knowledge to the fundamental redesign of our technologies and social institutions, so as to bridge the current gap between human design and the ecologically sustainable systems of nature. McDonough and Braungart (2002) noted in their 'Cradle to Cradle' methodology that the first principle of eco-design is that waste equals food. This closed loop thinking begins to inform all our spatial design strategies so that they are fundamentally concerned with ecological networks of energy and material flows.

Fostering ecological literacy in human societies is one of the key stepping stones towards a culture of sustainability. Orr, (2004) the environmentalist and educator, has written at length on the necessity for ecological literacy in society and he has noted that good design needs to respond positively to its ecological, social and cultural context. Eco literacy is a detailed understanding of nature as a complex interacting creative process in which humanity participates. Eco literacy results in an increased awareness of the basic dependence of all biological and ecological systems (architecture and its occupancy being but one facet of this) on their underlying physical and material systems.

“as perception becomes informed by eco literacy it can begin to bridge the dichotomy between the artificial and the natural, as well as between humanity and nature” (Wahl, 2006, p1)

Both Bateson (1972) and Prigann (cited by Wahl, 2006, p10) have argued that an ecological aesthetic is the recognition of a pattern of interconnectedness. An ecological aesthetic places artefacts including buildings into a dynamic

interconnected context rather than understanding them as separate from natural processes. This demands then an element of clarity in the material usage, the energy expression, the gathering of water and the means of ventilation. Designing the artificial, whether detail or system, must come from an understanding of the relevant natural processes and thus develops as an expression of the appropriate participation in these.

Defining an ecological aesthetic from the point of view of systems theory leads one to look at the connections between nature and culture, the aesthetic of integration. Philosopher and cultural ecologist David Abram (as cited in Kagan S. 2011, p252) sees the purpose of aesthetics as to assist in restoring our closeness to the rest of nature. *“The touchstone for an experiential world now inundated with electronically generated vistas and engineered pleasures”*... would be the reconnection to a direct sensuous reality.

The *pattern which connects* is as clear in the cycles of oxygen and carbon dioxide within our breathing as much as it is in the hydrological cycle, energy flows and material cycles of our built environment. The recognition of this pattern in architecture and art would utilise environmental function to assist in the generation of environmental form. It moreover needs to engage not only with further complexities within the networks of our environment but also with the occupants and the wider public at a cultural level.

A science of systems and complexity forms the basis for cultures of sustainability. Green aesthetics grow from the knowledge of complexity within the science of ecology, generating an architectural aesthetic that engages with

interactions and relationships, not with objects alone. Working with this approach gives a basis for our understanding of natural ventilation strategies as part of a larger system and enables a qualification of their architectural effectiveness.

1.2 Purpose and objectives

The purpose of this research is to examine the impacts and implications of natural ventilation strategies on the architectural design of public buildings. The success of these strategies is assessed through an examination of the following four qualifiers:

- Energy use reduction
- Thermal comfort provision
- Internal Air Quality
- Ease of operation

The three case studies are contextualised within both the general strategies of natural ventilation and then in the more specific realms of the building typologies. The aim is to define a vocabulary of ventilation techniques, resultant building sections and details that are suited to these differing typologies of public and commercial buildings within the study area: the temperate maritime climate of Europe.

Buildings need to interact with their environments with internal arrangements that deliver ‘nutrients’ such as fresh air, warmth and light to their occupants. This is essentially a systems mode of thinking about buildings, an appreciation of the energy flows onto a site and the material cycles. Within any building there is an exchange

of heat, water vapour, or other chemical components via the air moving through the building. This is to attain the required indoor environmental characteristics and to do this needs energy. Energy is needed to heat or cool, to evaporate or condense and, in mechanically ventilated buildings, to move the air around. In naturally ventilated buildings the energy required is provided by wind pressure and thermal differentials; in mechanically ventilated buildings this work is undertaken by a fan. A building well adapted to its local environment, its habitat, has a physiology of form and arrangement that is a response to its functional operations.

1.3 Delimitations

The area of study has been chosen as the temperate maritime bio-climate of Europe which includes the north western sea board of the continent and in particular the islands of Britain and Ireland (Köppen climate classification, 1936). The rationale for this is twofold: natural ventilation is widely regarded as an appropriate passive strategy for fresh air and cooling within this bio-climatic region; secondly, there exists well-documented guidelines and literature on the topic. There are a number of key public buildings designed using natural ventilation strategies, of which three have been chosen as case studies. These case studies have all been completed within the last twenty years, a time frame which has allowed the so-called performance gap between design and operation to be addressed. The resultant documented changes facilitate a critique of the strategies used to address energy, thermal comfort, internal air quality and ease of operation.

2.0 Chapter Two Literature Review

2.1 The role of ventilation in buildings

“The approach to environmental control which has predominated historically in temperate climates ... has depended upon the selective admission of substantial elements of the external environment into the building” (Hawkes, 1996, p 38)

The role of ventilation in building is to maintain internal air quality (IAQ), through the introduction of fresh air, and assist in the provision of thermal comfort; in order to achieve this, airflow rates need to be controlled. In our temperate maritime climate, buildings need to be ventilated throughout the year: in winter, ventilation should be minimised in order to prevent heat loss and to avoid draughts; in summer maximised in order to optimise the cooling process. The priority in winter is to maintain good indoor air quality through the removal of CO₂, ventilation requirements are determined by activities, processes and the density of human occupation (Fordham M. 2000)

The capacity for summer cooling is limited when the temperatures inside a building and outside are similar. This can be ameliorated by the cooling effect of night time ventilation when the external temperature is lower. It is in these conditions that the thermal capacity of the structure and the rate of heat transfer between air and structure becomes the defining issue. CIBSE AM10 (2015) notes that the air flow for cooling is higher than that required for air quality (8-10 l/sec per

person for air quality) and as such it is the summer ventilation rates which are the stronger determinant of the architecture of natural ventilation.

2.2 Building Regulations

In Ireland and the UK ventilation rate compliance is guided by Part F (TGD) of the Building Regulations. Ventilation (F1: Means of Ventilation) sets out the ventilation function for non-complex buildings of normal design and construction:

“Adequate means of ventilation shall be provided for people in buildings. This shall be achieved by a) limiting the moisture content of the air within the building so that it does not contribute to condensation and mould growth, and b) limiting the concentration of harmful pollutants in the air within the building.” TGD Part F Ireland (2009)

TGD Part F (Ireland) enlarges upon the above Building Regulation wording to include the provision of an adequate supply of fresh air for the occupants of a building. Ventilation is defined as: “the supply of fresh outside air and the removal of stale indoor air to or from spaces in a building;” and it is further noted that the ventilation strategy adopted should ensure controllability so that ventilation objectives can be achieved without an unreasonable waste of energy.

The section covering non-domestic buildings in TGD Part F for both Ireland and the UK makes reference to CIBSE Application Manual “AM10 (2015): Natural Ventilation in Non-Domestic Buildings” for more detailed design of naturally ventilated buildings. The importance of a general level of background ventilation is noted:

A well-designed building that minimises heat gains and utilises passive cooling by means of natural ventilation should require little or no mechanical ventilation. (Ghiaus C, Allard F. 2005). That said, mechanical ventilation can be useful for example where the plan form of the building means that natural ventilation cannot penetrate to the core or when external noise levels are unacceptable or when pollution levels mean that filtration is required. The advantage of mechanical over natural ventilation in these instances is the force it provides to overcome the resistance over depth and or through filtration. Mechanical ventilation also provides more controllable air flow rates and a more uniform distribution. Mechanical ventilation can be subdivided into three categories: supply only, extract only, balanced and in addition potentially comfort cooling and air conditioning with the latter providing humidity control (Thomas R. 1999).

A variation on the spectrum above is when natural ventilation alone, in certain circumstances, may not be enough to ventilate adequately a space or building: especially in spaces with high humidity and those requiring very specific temperature control. An alternative low energy strategy is a hybrid system which should be designed to utilise natural ventilation possibilities to the full whilst incorporating a mechanical system efficiently. This requires an intelligent control system to minimise energy consumption whilst maximising indoor air quality and comfort. Hybrid ventilation can be utilised in various combinations for example mechanical extract, mechanical supply or mechanical heating with cooling utilising natural ventilation. (The use of hybrid systems in domestic scenarios usually entails extract from warm, wet areas such as bathrooms and kitchens with heat recovery providing up to 60-70% from the exhaust).

In order that hybrid systems are effective, the system in use (that is, whether natural or mechanically assisted) at a given time depends on the natural driving forces available, the outdoor climate and the indoor need for cooling. Typically a balanced mechanical system is used in the heating season when heat recovery is beneficial and preheating of incoming air is required (Heiselberg P. 2008).

2.4 Benefits of natural ventilation

“It is (the design of) passive buildings that will enable us to survive the climate change and fossil fuel exigencies of the 21st century” (Roaf, S. 2007)

Natural ventilation refers to the flow of external air to an indoor space and the resulting flow back out again as a result of pressure differences arising from natural forces without using mechanical systems. It is not just an alternative to mechanical ventilation and air conditioning but can be an effective instrument to improve air quality, provide thermal comfort and reduce unnecessary energy consumption.

Natural ventilation strategies have to work in combination with:

- internal heat load reduction strategies
- an envelope design that effectively modifies the external environment
- the placement of thermal mass within the building
- the plan depth and section height of the building

The design of these four elements, which is an integral part of the architecture of the building, entails that there is an impact on built form and detail.

The potential benefits of natural ventilation over mechanical are to be described in more detail later, but below is an initial summary:

Energy:

- Reduced environmental impact compared to use of mechanical plant with natural ventilation using two to three times less energy than air-conditioning (PROBE 2002)

Thermal comfort:

- Increased occupant productivity due to occupant control of own ventilation rate

Internal Air quality:

- Potential increase in IAQ and subsequent reduction in absenteeism

Operation:

- Lower operating costs (both in energy required and in maintenance)
- Simpler environmental control systems because the building envelope acts as the primary climate modifier.
- As a result capital costs are typically 10-15% lower than an air-conditioning system

2.5 Measuring Success - Parameters of successful ventilation

In order to understand the success of natural ventilation strategies the following four qualifiers are used for the case study buildings:

- Energy reduction
- Thermal comfort provision
- Internal Air Quality
- Ease of operation

The choice of the first 3 qualifiers reflects the general requirements for ventilation as established in the Building Regulations and in the documentation from CIBSE. Ease of operation also forms part of CIBSE's scope and furthermore, is the qualifier that addresses the pragmatic remit that should play a key element of the choice of natural ventilation.

2.6 Energy Reduction

“Energy consumption defines the quality of urban life and the global environmental quality of cities” (Ghiaus and Allard, 2005)

The first of the four qualifiers on the use of natural ventilation within buildings is energy reduction. In air conditioned offices ventilation and the associated heating and cooling accounts for a third of building services costs (BRESCU, 2000). As an environmental design strategy for buildings, natural ventilation has been shown, through the PROBE studies in the 1990s, to reduce building energy consumption whilst ensuring good indoor air quality and providing thermal comfort.

Roulet (2008) notes that the main purpose of buildings is to provide a comfortable living environment despite potentially uncomfortable external conditions:

“Except in very mild climates, the largest amounts of energy are used to ensure a comfortable indoor climate, either by heating or cooling. Therefore indoor environment control has the largest impact on the energy use of buildings” (Roulet P. 2008)

The environmental impact of a building’s energy usage and its resultant CO₂ emissions depends on its overall design including issues such as site planning, form, construction, and operation which all affect performance. Buildings are a major consumer of energy in both construction and operation. 40% of all energy consumed in the European Union is used in buildings and 40-60% of this is used for heating and ventilation (EU web resource 2018). Providing for comfortable environments using technology, in the form of mechanical ventilation and air conditioning, needs to be reconsidered if we are to produce low energy, environmentally responsive, sustainable architecture.

2.6.1 The impact of climate change. Although there are areas of uncertainty as to the effect of global warming on climate conditions in north western Europe – not least because of our dependence on the Gulf Stream for our climate modification - an increase in global temperatures is anticipated. Studies, including the Stern Review (2006), have demonstrated the impact of climate change. Average temperatures have climbed 0.8 degree Celsius around the world since 1880, much of this in recent decades. The rate of warming is also increasing: the 20th century's last

two decades were the hottest in 400 years. The United Nations' Intergovernmental Panel on Climate Change (IPCC) reports that 11 of the past 12 years are among the dozen warmest since 1850.

For much of Europe, the impact of this climatic instability on buildings is the effect on indoor temperature and thermal comfort conditions. Specific heating energy requirements may be lowered and specific cooling energy requirements increased. Both factors would impact on the aggregate energy demand of the building sector; it is the latter which can be assisted through natural ventilation techniques.

2.6.2 Legislation. Within the European Union the response to environmental change, global warming and resource depletion has been the tightening up of the legislation regarding building environmental performance. From 2013, the Energy Performance Building Directive (EPBD) was superseded by the Recast EPBD and S.I. No 666 of 2006 was superseded by S.I. 243 of 2012. It binds member European states to ensure that:

“(a) by 31 December 2020, all new buildings are nearly zero- energy buildings; and

(b) after 31 December 2018, new buildings occupied and owned by public authorities are nearly zero-energy buildings.”

Annex 1 of the EPBD recast notes that:

“The energy performance of a building shall be determined on the basis of the calculated or actual annual energy that is consumed in order to meet the different needs associated with its typical use and shall reflect the heating energy needs and cooling energy needs (energy needed to avoid overheating) to maintain the envisaged temperature conditions of

the building.”

The EPBD lists both passive and active aspects of a building’s environmental performance, which are attributes to be considered in the design of zero energy buildings or near-zero energy buildings. A zero-energy building, also known as a zero net energy (ZNE) building or a net-zero energy building (NZEB) has zero net energy consumption and zero carbon emissions annually. Buildings that produce a surplus of energy over the year may be defined as Energy-plus buildings and buildings that consume slightly more energy than they produce are called "near-zero energy buildings"

2.6.3 Energy and Ventilation. Within any building there is an exchange of heat and water vapour to or from the air entering or leaving the building to attain the required indoor air qualities and to do this needs energy. Energy is needed to heat or cool, to evaporate or condense and, in mechanically ventilated buildings, to move the air around. In naturally ventilated buildings the energy required is provided by wind pressure and stack effect; in mechanically ventilated buildings this work is done using a powered fan.

“In modern and retrofit buildings, ventilation is probably the greatest component of the total energy consumption. This is usually in the range of 30-60% of the building energy consumption” (Awbi, 2003)

Heating air in well-designed passive buildings utilises energy from solar gain, the metabolic rate of the occupants, internal lighting and other activities within the building. Cooling buildings in order to avoid summer overheating through passive means can be achieved both by increased day time ventilation rates and by night time

ventilation. Passive cooling strategies are most useful in climates where the daily average outdoor temperature is within comfort limits and there is a useful diurnal range. Therefore this is an appropriate strategy for the temperate maritime bioclimate with mean daily maximum annual temperatures of 13-14°C and minimum 4-5°C (met office UK)

The imperative of reducing emissions of greenhouse gases has stimulated interest in the design of low energy buildings. The PROBE studies (Post Occupancy Review of Building Engineering undertaken by CIBSE) in the UK in the late 1990s showed that 9 of the 10 lowest CO₂ emitters were naturally ventilated buildings. Energy consumption within naturally ventilated buildings is lower due to the elimination of active cooling and mechanical ventilation which accounts for the reduction in CO₂. The BRE (1991) estimated that a naturally ventilated office uses half as much energy as an air conditioned one.

“The high proportion of greenhouse gas emissions resulting from highly serviced buildings is one of the primary arguments driving the move back to the use of natural ventilation and passive heating and cooling of buildings” (Santamouris, 2005, p 19)

However, in parallel with this is the need to reduce thermal load within the building design; for example, the building envelope both in terms of heat loss and gain requires consideration of glazing ratios, solar shading, the amount and positioning of insulation. Further load reductions can be achieved through the use of daylight-controlled dimming on artificial lighting which has a positive effect on the thermal comfort and reduces the total energy consumption of the rooms. With the

use of CO₂-sensors to control the fresh air supply, the heating energy consumption can be kept low in winter (Wood A., Salib R. 2013).

2.6.4 Heat Reclaim. In a well-insulated and sealed building, ventilation represents the main source of heat loss. This can be mitigated through pre-heating cold incoming fresh air by passing it over a heat exchanger across which the warm outgoing stale air is flowing. Heat recovery makes it possible to use a full fresh air system while minimising heat loss. It is most beneficial in centralised ventilation systems such as air conditioning when used between exhaust and intake. It is important to consider the overall cost benefit of a heat recovery system, the running cost as well as the capital cost; a balanced mechanical ventilation system can recover between 50 – 80% of ventilation heat loss but fans and pumps consume electricity. In naturally ventilated buildings this is much harder to achieve, however the passive use of thermal mass to store warmth and coolth has less knock on energy costs in comparison with mechanical systems. (CIBSE AM10, 2015)

Sassi (2013) makes an important point regarding the need, or not, for MVHR (mechanical ventilation heat recovery) in Passive House design in temperate maritime climates. Additionally, it is important to note that heat exchange devices introduce an extra resistance to air flow thus posing difficulties with natural ventilation strategies which will often require additional fans. Fixed flat plate heat exchangers bring the two air flows of intake and extract into useful proximity. As Sassi has noted: in climates such as Ireland and the UK the electrical energy required by the fan goes a long way to off-setting the heat reclaim (in colder climates, however, where heat loss can be greater, it is sensible to utilise heat reclamation).

Ideas for providing heat reclaim with natural ventilation need further research although they are inherently difficult to realise as it is not possible to achieve heat transfer without some loss of momentum and loss of air pressure. However, as seen at Bill Dunster's BedZed housing scheme in London (2003), low velocity stack ventilation systems achieve some heat transfer between exhaust air from wet areas and incoming fresh air. Bucholz McEvoy, architects of the SAP building in Galway (2005), likewise have installed a form of wind pressure-vented heat exchanger. Additional research is needed in this area, particularly on pay back periods against the capital cost of installation.

2.6.5 Energy consumption benchmarks

Energy Consumption Guide 19, 'Energy Use in Offices' (2000)

- A naturally ventilated, open plan building would typically have an energy performance of **236 kWh/sqm/yr.** (BER: D1) (or 0.075kWh/sqm/h)
- A naturally ventilated, open plan building good practice would have an energy performance of **130kWh/sqm/yr.** (BER: B3) (or 0.055kWh/sqm/h)
- Note: Air conditioned standard typical 0.10kWh/sqm/h
- Air conditioned good practice typical 0.07kWh/sqm/h

Energy consumption targets have progressively decreased with the proposed NZEB benchmarks for naturally ventilated offices in Ireland: 35 – 70 kWh/sqm/yr

(Towards Nearly Zero Energy Buildings in Ireland Planning for 2020 and Beyond
Department of the Environment, Community and Local Government, 2012)

The typical energy use for theatre buildings the bench mark is taken from the Display Energy Certificate used within the buildings from the Department of Environment, Transport and the Regions (UK) which gave (2014):

- heating **445kWh/sqm/year**;
- electricity 179kWh/sqm/year

Energy Consumption Guide 54, 'Energy Efficiency in Further and Higher Education (1997), Libraries:

- fossil fuel usage (heating) **150kWh/sqm/year**;
- electricity 50kWh/sqm/year

2.7 Thermal Comfort

The second of our qualifiers, thermal comfort, has been defined as:

“the state of mind which expresses satisfaction with the thermal environment” (ASHRAE standard 55, 2004).

This definition describes a person’s psychological state but takes into account physical parameters which include:

- Air temperature
- Mean radiant (surface) temperature
- Relative air speed
- Humidity

And personal factors:

- Metabolic heat production
- Clothing

Ireland and the UK are both climatic regions with moderate heating and cooling loads and in such, ventilation strategies are designed to provide thermal comfort during summer (Kolokotroni and Santamouris, 2005). The body endeavours to maintain core temperatures at circa 37°C through internal thermo-regulation. The body heat production rate, which results from the oxidation of food for energy, is known as the metabolic rate and depends on diet and level of activity. The body seeks to lose heat through evaporation, respiration, radiation, convection and conduction.

“Air conditioning – (much apart from its use of high grade fossil fuels) removes the need to understand what it is to be too hot” (Fordham M. 2000)

Awbi (2003) noted that the connection of body and environment is through four environmental parameters: air temperature, mean radiant temperature, air velocity and water vapour pressure and three personal parameters: metabolism, work, thermal insulation of clothing. The usual basis for determining thermal comfort is the air temperature of a room, however, since radiation accounts for almost half the body's heat exchange, a room with a low mean radiant temperature will be perceived as cooler.

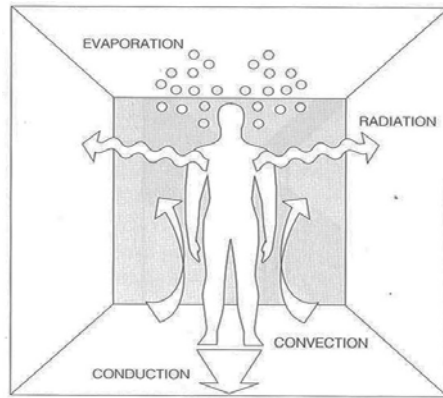


Figure 1: Heat loss mechanisms of the human body (Clinical Gate).

2.7.1 **Internal Heat Gains:** CIBSE guidance document AM10 (2015)

illustrates the level of internal gains to be expected in a building. Firstly those from occupant density and activity noting that small power gains on average are 20W/sqm in commercial buildings and that occupants contribute 70 – 100 W per person; secondly noting that lighting gains are a function of required illuminance, the form of lighting and the control strategy employed. It categorises buildings (see table 2.1) as:

- Low total gains 6 – 16 W/sqm
- Medium total gains 18 -30 W/sqm
- High total gains 30 – 50 W/sqm

2.7.2 **External heat gains:** The total heat load for a natural ventilated

building is the sum of the above internal heat gains plus climate gains. Solar gain can be a significant factor through glazing particularly on the south and west facades; in all buildings it is important then to minimise glazed areas of the façade exposed to solar gain to 20- 40% of the floor area and by the provision of good solar protection using shading, blinds, or solar control glass. Higher glazing rates will require greater

and more sophisticated protection. Good external shading and solar control glass can limit climate heat gains to 10W/ sqm for a 30% glazing ratio (AM10).

2.7.3 Steady state comfort criteria. The term ‘reasonable comfort’ is used by ASHRAE Standard 55 (2004) and considers 80% of occupant satisfaction as a *reasonable* limit for the minimum number of people who should be thermally comfortable in an environment at a given time. Creating conditions of thermal comfort in non-domestic buildings has been, since the 1950s, typified by the adoption of a building-centred approach which focusses on creating constant, uniform thermal conditions through the use of forced ventilation and air conditioning. The primary purpose of air conditioning systems is to provide an acceptable indoor air quality and thermal comfort aiming for an optimum ‘steady-state’ temperature setting. This is based on Fanger’s predicted mean vote / predicted percentage of dissatisfied (PMV–PPD) model (Fanger, 1970). The ‘static’ approach to thermal comfort was intended to maximize safety and comfort.

PMV is the mean vote derived by averaging the thermal sensation voting of a large group of people in a given environment. PMV and the associated PPD is a thorough methodology but it applies to mainly sedentary activities in light clothing. PMV uses the theory of heat transfer to determine different comfort temperatures for people in a specific environment; in this case, individuals studied in tightly controlled situations (Ghiaus C., Allard F. 2005).

The wide use of air conditioning systems has depended on the use of PMV and the relative rigidity of temperature and humidity ranges it implies. This has

produced many examples of mechanically-dependent buildings and their ensuing energy consumption.

2.7.4 Adaptive comfort theory. In a critique of the PMV methodology, Nicol and Roaf (2007) claim that the philosophy of comfort embodied in international standards promotes mechanically cooled environments, regardless of their necessity. They suggest that an unvarying temperature resulting in high-energy use is not necessary for comfort. Varying thermal sensation is part of a feedback system by which the human body is kept in thermal equilibrium. That is to say: building occupants provide the change themselves to achieve comfort whether this is in clothing or activity or change of environment.

The debate between the steady state and the adaptive approach has been a key discussion in the recent development of thermal comfort science (Nicol and Humphreys, 2002). As noted above, the thermal comfort standard used by ASHRAE is based on experiments in climate chambers initiated by Fanger in the 1960s. The adaptive approach, on the other hand, is based on field studies undertaken by Humphreys in the early 1970s, demonstrating that people are more tolerant of temperature changes than laboratory studies suggest. In fact, people act consciously and unconsciously to affect the heat balance of the body – a form of behavioural thermo-regulation. In this way, comfort is normally achieved in a wider range of temperatures than predicted by ASHRAE standards (Heschong, 1979; Nicol and Humphreys, 2002). CIBSE AM10 (2015) has noted that building occupants are generally more tolerant of higher temperatures with a perception of environmental control.

The development of adaptive models in the 1980s and 1990s became useful in arguments for and in the design of, naturally ventilated buildings. These thermally free running buildings allow for and promote an interaction between the occupant and their thermal environment e.g. changing clothes, posture changes, moving position within a building, activity changes, opening a window, using a fan, changing the heating. These are also time dependent short-term, such as diurnal, or long-term such as seasonal adjustments. The fundamental assumption of this approach is expressed by the adaptive principle: *'if a change occurs such as to produce discomfort, people react in ways which tend to restore their comfort'* (Nicol and Humphreys, 2002).

Adaptive models do not predict comfort responses: *"but rather the thermal conditions under which people are expected to be comfortable in buildings"* (Awbi, 2008, p21) and he draws the conclusion that the temperature ranges for thermal comfort are, in actual fact, broader than as shown by PMV. The adaptive approach to comfort relates acceptable indoor conditions to those found outside. During summer months many buildings in temperate climates are free running (not heated nor cooled mechanically) and so the temperatures indoors respond to the external temperature as will the clothing of the occupants. Bands within which comfortable conditions have been found to lie are more generous than those with mechanically heated or cooled buildings i.e. a greater thermal tolerance exists ranging between 18 to 29°C in relation to outdoor temps of 7 to 25°C compared with 21 to 27°C for a mechanical approach (CIBSE A, 2006).

2.7.5 **Occupant control and adaption.** Providing the opportunity for the occupants to make adaptive changes to their environment involves potentially a number of small changes such as in clothing, opening of vents or windows but *“because all the adaptive opportunities work in the same direction, the cumulative effect of a number of small changes can result in a significant improvement in comfort.”* (CIBSE AM10, 2015, p18). Thermal comfort utilising natural ventilation entails that the temperature will vary throughout the day depending on external weather conditions; it has been suggested that the visual connection from inside to outside is important so that building occupants understand and potentially predict their thermal comfort.

2.7.6 **Thermal symbolism.** An environment of hermetically sealed buildings has not only damaged our thermal coping and sensing mechanisms but destroyed thermal symbolism and our ability to feel and understand what it is to be hot and cold claims Fordham M. (2000). Humphreys and Nicol (1998) argue that the application of the Fanger equation underestimates human adaptability to indoor climate by about 50%, leading to excessive energy use and inappropriate design in mechanically-based ventilation systems. It is argued that thermal adaptability is a human characteristic, which gives a greater sensation of comfort than a steady state thermal environment. Furthermore some of these changes have evolved into a way of life from the siesta of Spain, as a response to summer heat, to the traditional Yazdi house, who inhabit differing parts of the building depending on the diurnal and seasonal climate, an adaptive strategy for a hostile environment.

“Change and movement is the essence of the adaptive approach: stasis, the existence of a static relationship between occupant and environment, is only achieved in very specific circumstances”. Nicol and Roaf (2007)

Heschong (1979) argues in a similar vein that change and movement are essential means to experience a building and, to take this further, to understand the interconnected whole: the various ways that people use, remember, and care about the thermal environment and how they associate their thermal sense with their other senses. The hearth fire, the sauna, the Roman and Japanese baths, and the Islamic garden are all archetypes of thermal delight about which rituals and meaning have developed.

2.7.7 Localised thermal discomfort. Aside from excessive environmental temperatures, thermal discomfort depends too on the avoidance of local discomfort sources. This can be due to asymmetrical thermal radiation e.g. from cold windows, or from temperature gradients particularly between head and feet. ASHRAE standards limit the thermal gradient to 3°C for seated and standing. More specifically, in terms of natural ventilation, draughts can be a source of thermal discomfort – the undesired local convection cooling of body by air movement. This can result in heating systems designed to compensate with subsequent energy usage or blocking of vent ducts and decrease in air quality. CIBSE A (2006) notes that air speeds greater than 0.3m.s⁻¹ are probably only acceptable in a naturally ventilated space in summer. Where wind speeds in a room are greater than 0.15m.s⁻¹ the operative temperature should be increased to compensate for the cooling effect.

2.7.8 **Thermal Comfort Benchmarks:**

- CIBSE 2002 thermal discomfort criterion less than 5 % of occupied hours should exceed 25 °C
- CIBSE 2005/06 thermal discomfort criterion that less than 1 % of occupied hours should exceed 28 °C.

2.8 **Internal Air Quality (IAQ)**

One of the principle roles of ventilation in buildings is the provision of clean air for the occupants and the removal of pollutants. Our third qualifier is Internal Air Quality (IAQ) and the use of outdoor air to provide this serves a number of purposes:

- Human respiration which requires 0.1 – 0.9 l.s - per person depending on metabolic rate
- Dilution of gaseous contaminants within the building: CO₂, odours, vapours of harmful contaminants
- Control of aerosols inside buildings using filtered outside air
- Control of internal humidity
- Promoting air movement to provide comfort

(Olesen B, Bluysen P, Roulet C, 2008)

A minimum supply of air is required for removal of odour, carbon dioxide and any other contaminants produced by human occupation and activities. CO₂ and water vapour are usually the two most important determinants of the required ventilation rate. According to CIBSE A (2006) outside air supply of 8 l/s per person

is usually sufficient depending on activity; furthermore, in order to provide good air quality, air supply rates should reflect these minimum requirements:

- 0.3 l/s per person to provide oxygen
- 5 l/s per person to reduce build-up of CO₂
- 8 l/s per person to control body odour

CO₂ is sometimes reported as being an unreliable ventilation rate indicator due to the uneven mixing of CO₂ levels in a room as a result of sedentary occupation or stratified airflow from the room ventilation. In low levels of occupation, volatile organic compounds (VOCs) are taken as the determining factor for ventilation (Ellis J. 2010).

Effective ventilation requires that outdoor air is cleaner than indoor air which it replaces. This is not always the case however and sometimes precautions must be taken, for example, ensuring that the air intake is positioned away from busy roads and car parks or other sources of contamination. It should also be noted that filters to remove particulates are useful but may require fan power to assist air movement and these filters do not remove gaseous contaminants such as CO, CO₂ or NO. Natural ventilation can improve IAQ when outdoor pollutant level is low, outdoor temperatures within comfort levels and when it does not contribute to other sources of stress to occupants such as noise.

2.8.1 Poor Internal Air Quality. The drive to reduce energy consumption in buildings has greatly influenced IAQ through the advent of air tight construction and the resultant prescribed minimum ventilation rates. Ventilation requirements for

good IAQ have been the subject of continued research over the years. Yaglou C.P. was commissioned in 1936 by ASHVE to research the minimum ventilation rate required for the reduction of body odour (ASHRAE 1999). This approach still forms the basis for prescribed minimum ventilation rates, focused on removing metabolic odours and not necessarily on the removal of indoor air contaminants Ellis (2010).

Poor IAQ affects the occupants of a building in terms of:

- Comfort e.g. stuffy, odorous
- Acute health effects e.g. chest symptoms, transmission of airborne disease
- Chronic (delayed) health effects.
- Productivity

Pollutant sources are either external pollutant sources carried into buildings such as particulates or gases from traffic and industry and/or internal sources from such as building materials, furnishings, occupant activities and equipment. Awbi notes (2003) that these problems have been increasing due to:

- Increased air tightness
- Reduction in ventilation rates in order to reduce energy consumption
- Increase in use of computers, printers and other office equipment.
- Increase in use of textile flooring and soft furnishings
- Increase in use of air conditioning and lack of maintenance

Most ventilation standards still specify outdoor airflow rates adequate to dilute human bio-effluents but not enough to deal with contaminants from other sources. Ellis (2010) notes Volatile Organic Compounds (VOCs) are a main category of indoor pollutants and are highly variable in their chemical composition. These stem from construction materials, lacquers and paints, flame retardants in furnishings and cleaning products. Equally, formaldehyde emissions from timber based products and glues are frequently reported as causes of building IAQ problems. The greater prevalence in use of IT equipment notably in office buildings has further increased internal pollutant sources. Recommendations for improving IAQ whilst at the same time maintaining an optimum balance with energy consumption generally include measures for preventing pollutants at source such as no smoking, non-pollutant furnishings, evacuating contaminants at source.

2.8.2 Building related illness (BRI) and Sick Building Syndrome (SBS).

The growth of thermally controlled environments through the use of air conditioning systems has been mirrored by the increase in health issues connected with building occupancy. Although air conditioning systems were originally partly employed to create better working conditions, a side effect has been that buildings are increasingly becoming 'sick.' Internal Air Quality (IAQ) can be worse in air-conditioned buildings than naturally ventilated equivalents.

“IEQ complaints are also related to sickness absence rates of office workers due to sick building syndrome (SBS) and building related illnesses (BRI). Losses in work productivity and performance have a direct financial impact on business” (Fisk 2000)

Research has shown (Clausen et al 2004) that ventilation ducts in mechanical and air-conditioned buildings can be dirty and filters not changed leading to a build-up of contaminants which are recirculated into the inhabited spaces. Awbi (2003) suggests this manifests itself in increased absenteeism from work and resultant productivity reductions and in more serious health issues such as outbreaks of legionnaire's disease. Natural ventilation strategies have been shown to be as effective in providing IAQ in buildings without the ensuing health implications that can arise from HVAC systems; although, as will be demonstrated through the case study examples, issues of maintenance of plenums and ventilation paths are also important within natural ventilation strategies.

Blyussen et al (2001) studied the connections between HVAC systems and pollution, measuring perceived air quality, particles and chemical compounds - studied in both laboratory and field conditions. The research showed an increased risk of infectious disease transmission from re-circulated air with HVAC systems causing an overall distribution of pollutants. The study concluded that the main sources of pollution were filters and ducts, particularly as sources of odours.

2.8.3 Indoor environment and performance.

“the complexity of a real environment makes it very difficult to evaluate the impact of a single parameter on human performance mostly because most of them are present at the same time and, as a consequence, act together on each individual” Olesen B, Blyussen P, Roulet C (2001).

Several studies have been undertaken to look at the effect of the indoor environment and occupant worker performance. Roelofsen P. (2002) concluded that

in the office environment it was the temperature and air quality that had the most influence on people's productivity. Studies undertaken by Wargocki et al (1999) have shown a connection between poorly perceived IAQ and worker performance and established a relationship between overall ventilation rate and productivity. These studies suggest that improvements or reductions in productivity were around 1% -2% when due to perception of IAQ, whereas similar studies suggest that thermal conditions can affect performance by up to 15%. In this respect, this diminishes the role of IAQ in comparison to the thermal environment; however, since the salaries of workers in typical office buildings exceed the building energy and maintenance costs by up to 100:1 even productivity increases of 1-2% would be worthwhile to pursue (Wyon 1996; Djukanovic et al 2002).

Whilst there is less research available linking SBS symptoms and worker productivity, Raw et al (1990) did find a link between self-reported SBS symptoms and loss of productivity. Fisk and Rosenfeld (1997) in the USA showed that good IAQ reduces the prevalence of SBS symptoms. There appears to be a correlation between performance and a feeling of well being amongst the occupants of a building; whether this is predominantly due to the thermal environment or perceived IAQ. That IAQ is generally perceived as of higher standard in naturally ventilated buildings compared to mechanical vented ones has been shown by the research of Bluysen (2001) amongst others.

2.8.4 Air changes and ventilation rates. Following the introduction of ASHRAE Standard 62 -2001 in the USA, IAQ assessment generally includes evaluation of two principal performance criteria: ventilation flow rate and ventilation

effectiveness. Ventilation rates are selected to control temperature, pollution and air movement. Fordham M. (2000) notes that the ventilation rates required to control summer time temperatures are very much higher than the ventilation rates required to control pollution or odour. Over the years ventilation rate guide lines have continuously been revised due to building design changes, technological development, lifestyle changes and costs. Ventilation rates required for a given internal space are determined to satisfy both health and comfort criteria: health criteria are concerned with indoor pollutant levels; comfort is concerned with the removal of odour and other sensory irritants. Comfort criteria are generally applied to homes and offices, health criteria are usually applied to industry where pollutant sources are potentially greater.

Recent standards from ASHRAE (2001) and the European Committee for Standardization (CEN, 2008) take account of people and building types for ventilation rates and can be assessed in two modes:

- Prescriptive – a minimum ventilation rate per person and per sqm of floor area.
- Analytical – calculated on a comfort basis (perceived odour) and health basis – the higher of the two values (usually comfort) is then used as the required minimum ventilation rate.

Ventilation rates of outdoor air supply differ between ASHRAE and CEN in how buildings are categorised: minimum ventilation rate for occupants in ls-1 vary from 3.8 for restaurants and auditoria to 2.5 for offices according to ASHRAE. CEN

categorises buildings within use classes with ranges of 4 to 10 ls-1. Both add on additional ventilation for the building in ls-1/sqm.

CO₂ has traditionally been used as the sensor for poor air quality but Fanger's studies (1988) showed that this does not necessarily correspond with the perception of poor air quality: for occupants of buildings, body odour perception tends to be the determinant. CO₂ levels however do reflect the levels of occupation of an internal space. In addition to CO₂ it is important to note that the production of water vapour in dwellings from human activities leads to higher concentrations of water vapour than in commercial buildings and is a particular determinant of ventilation rates in Irish and UK building regulations. Note too that CO₂ levels are not a good indicator of the concentration and occupant acceptance of other indoor contaminants, such as volatile organic compounds off-gassing from furnishings and building materials. It is argued that CO₂ concentration is not a reliable indicator of overall building air quality (ASHRAE standard 62.1 2016) but in the absence of major contaminants, carbon dioxide (CO₂) levels are generally recognised as a key indicator of indoor air quality.

2.8.5 Bench mark data for IAQ:

“As a general rule the fresh air supply rate should not fall below 5- 8 litres per second per occupant but this will depend on various other factors including floor area per occupant, processes carried out, equipment used and whether the work is strenuous” (CIBSE AM10)

For a 'standard' room occupation a rate of 8 l/s fresh air per person would mean that the levels would rise 600 ppm CO₂ which, when added to the normal outdoor CO₂ of

400 ppm, gives an internal CO₂ concentration of 1000 ppm – this is unlikely to provide any discomfort. (CIBSE Journal Module 27)

2.9 Ease of Operation

“The purpose of ventilation control is primarily to adapt the airflow rate to the actual demand, which is a requisite for a successful ventilation solution”
(Heiselberg P, p374, 2008)

The fourth qualifier is the ease of operation of the ventilation system: one of the key factors in the choice between natural ventilation and mechanical is in the ease of operation. Controls, louvers and dampers are critical natural ventilation elements when utilised as part of the adaptive approach. Operating systems are essential for the safe and energy efficient operation of a building, providing good IAQ, for thermal comfort and as part of fire and acoustic strategies. They must also be capable of providing feed-back to those in charge of their operation (Thomas R, 1999).

CIBSE AM10 (2015) notes the importance of the robustness of the operating system: in natural ventilation the control strategies usually involve the occupant as part of the adaptive approach. A good natural ventilation operating system should have a robust solution with fewer failure modes due to the reduction in the number of components that are susceptible to mal-function. In comparison, the electro-mechanical systems involved in air conditioning tend to be complex and require regular maintenance.

Energy use efficiency is a key element. The difference between actual energy required and the base energy requirement – that level of energy expended to meet the business needs of a building operation - represents avoidable waste. CIBSE -H, (2000) notes that in a well-managed building avoidable waste levels should be below 15%. A good Building Energy Management System (BEMS) helps achieve this performance through managing time and controlling internal temperature, ventilation and lighting. The operating system contributes in reducing waste through limiting heating and cooling to the minimum period necessary utilising systems such as time switches and occupancy detection.

Conversely, Mumovic D., et al (2013) report, that poor controllability of natural ventilation systems can result in sub-standard ventilation or poor air distribution with resultant poor IAQ. Furthermore, poor operational systems can result in over-ventilation and higher heat losses during winter months if not correctly adjusted.

2.9.1 Types of operating systems. Operating systems function largely under an automated programme but the building/ facilities manager can choose from a number of options:

- out-source BEMS
- in-house BEMS
- a combination of the two.

The scale and complexity of the control system must be appropriate to the building and its operation, noting that staff costs are also an important factor in this. (CIBSE-H 2000)

2.9.2 **Control of natural ventilation systems.** Complete control of natural ventilation by opening windows alone is only possible in smaller buildings. For larger buildings with natural ventilation strategies, some form of mechanical operation is essential, linked through to a BEMS control strategy. Controlled devices for natural ventilation consist principally of modulating inlet and outlet vents through the use of actuator operated dampers; in some cases low energy extract fans might be used to assist in auditorium spaces in stagnant wind conditions. CIBSE AM10 (2015) gives the following points for design consideration:

- Work through all normal operating modes – winter, summer and night time and emergency including such as smoke control and fail safe modes in the event of power loss. For example, when the building is in heating mode then occupancy sensors would control the ventilation rates in response to CO₂ levels. When the building is in cooling mode ventilation is adjusted, guided by internal temperature and sometimes external temperatures too. If the internal temperature is high in the evening and the external temperatures are lower, then night cooling is initiated – usually automatically.
- Vents should open not just on the basis of internal conditions but also when external conditions demand an override to protect against excessive wind speed.
- Occupant control should be territorial, be intuitive and in obvious positions.
- Consideration must be given to rain and wind control and security – particularly in relation to night time venting.

2.9.3 **Components of a ventilation system.** These include the following:

Sensors:

- Temperature sensor – for example room or zone thermostats
 - Slab temperature or internal air temperature – slab temperature is a better indicator if using thermal mass as temperature control – inserted 25 – 50mm into slab
- Humidity sensor – using for example the expansion of nylon film
- Air quality – the level of CO₂ in an internal space is most generally the accepted measure of the relationship between occupancy and ventilation. CO₂ concentration is set at a level for initiating ventilation which is particularly useful in buildings with a varying occupant rate
- external weather sensors:
 - External air temperature – mounted on north face out of direct radiation
 - Rain intensity sensor – for closing or opening inlets and outlets
 - Wind speed - for closing or opening inlets and outlets
 - Wind direction – for selection of wind ward or lee ward vents
 - Solar radiation – to increase ventilation rates if high solar gain or to operate sun screening

Actuators:

- respond to an output signal from a controller and provides the mechanical action to operate the final control device typically a valve or a damper

Dampers:

- Used to control air flow at inlets and outlets

Fans:

- required if additional power is needed to move air in cases of greater resistance (such as heat recovery or climate-induced lack of thermal buoyancy)

In naturally ventilated buildings – without the energy required for mechanical ventilation - lighting can account for 40% or more of the total electricity demand (CIBSE – H; 2000) and thus lighting design, fittings and controls are all important factors as part of a BEMS in order to maximise daylight and reduce lighting (and hence energy demand) of unoccupied spaces to a minimum.

2.9.4 **BEMS user interface.** CIBSE-H, (2000) recommends the following strategies for communications within a BEMS:

- management level for supervisors;
- automation level for controllers
- field level for sensors and actuators

BEMS systems are largely controlled by software apparatus and are operated by a range of users with different levels of responsibility, qualifications and experience; therefore controls need to be set at a level which can be operated appropriately.

Adaptive building ventilation strategies for thermal comfort involve enabling a certain element of occupant control. Except in small building, it is not reasonable to

expect occupants to take responsibility for overall running of a building and hence the need to incorporate an overall building energy management strategy.

“full occupant control is only feasible in small cellular offices where the control choices have limited effect on the rest of the building”. (CIBSE-H, 2000, p145)

CO₂ measurement is often used to assess occupancy and resultant ventilation demand with actuator controlled dampers to modulate external wind variables.

Strategies are usually divided into two parts: the occupancy period and night time ventilation strategies to cool the building. During warm weather in the occupancy period there will be no heating requirement and the BEMS is used to modulate the air inlets in order to control internal temperatures. During cold weather, when heating is required, the BEMS sets the inlets and outlets to provide for minimum ventilation to maintain air quality typically via CO₂ measurement at a set point below 1000ppm.

CIBSE note that a night cooling strategy requires temperature monitors to respond to an outdoor mean ambient temperature (typically 20°C) and one of a daytime internal mean ambient temperature (22°C) or internal slab temperature (typically 23°C) or peak zone temperature (23°C). The BEMS will subsequently activate inlets and outlets in order for ventilation to flush the building and cool it prior to re-occupancy the following day.

2.9.5 Cost. The cost implications of the chosen ventilation system require a detailed life-cycle cost evaluation. In early design phases, a cost comparison of design features and ventilation system elements should be assessed and include:

Initial capital costs

- The cost of building elements associated with natural ventilation, which includes operable windows, vents, chimneys, screens, louvers, etc. These also include the cost increase associated with building components such as an atrium, if its inclusion is predominantly for natural ventilation purposes.
- Devices such as monitoring and control system
- Mechanical assistance system – if required

The capital cost of natural ventilation is generally 15% cheaper than mechanical ventilation but also note that building envelope costs may increase as a result of shading requirements to reduce passive solar gain and the need for better quality vents and damper systems. The net to gross area of the building can also be smaller because of plan depth restrictions in natural ventilation (CIBSE AM10 2015).

Operating and replacement costs include:

- Maintenance costs.
- Energy consumption if required
- Energy savings against a mechanical alternative.
- The replacement cost of those components with short lifetimes.

Utility costs typically in naturally ventilated office buildings are 40% less than that of an air conditioned building and maintenance costs can be up to a quarter of those incurred by an air conditioned building. (CIBSE AM10, 2105)

The investment in natural ventilation is both in the design coordination and

then in the capital cost of the supporting building elements for example: stacks and louvers. Brand S. (1994) suggests that the skin or envelope of a building has a life span in excess of 20 years whereas services can be in need of replacement within 15 years. One of the important design considerations of natural ventilation is that the components that make the system work – windows, louvres, atriums, etc. - form part of the more durable elements of a building compared with the more quickly redundant mechanical services.

2.9.6 Ease of operation – key benchmarks

- Robustness – reduction in number of components – designed simplicity
- Occupant control – territorial and intuitive, well placed
- Ease of maintenance
- Response to both internal and external conditions
- Security

2.10 Summary

Natural ventilation refers to the flow of external air to an indoor space as a result of pressure differences arising from natural forces without using mechanical systems. It is not just an alternative to mechanical ventilation and air conditioning but is a multidimensional approach which can be an effective instrument to improve air quality, provide thermal comfort and reduce unnecessary energy consumption. In terms of energy, the use of passive wind pressure and thermal strategies to move air

can result in the reduction of power requirements of fans. In terms of thermal comfort, when combined with heat load reduction strategies, natural ventilation can provide sufficient cooling and facilitates greater occupant control of the interior environment. In terms of IAQ, when combined with the monitoring of CO₂ and an appropriate operational strategy, natural ventilation can provide the requisite air changes and ventilation rates. The designed ease of operation for natural ventilation is an important consideration in determining the longevity of the proposed ventilation system and its cost effectiveness.

2.11 Driving forces for Natural Ventilation

“For all natural systems the most important issues are related to optimum use of driving forces combined with minimising pressure losses in the system” (Heiselberg P. 2008)

The principles of natural ventilation are based on pressure and temperature differences to induce air movement. Natural ventilation requires an average wind speed in excess of 2.5m/s in order to be effective in wind pressure derived ventilation (Awbi, 2003). The suitability of our temperate maritime climate for natural ventilation is confirmed by the average wind speed in Britain and Ireland which ranges from 3m/sec in eastern areas to 8m/s in exposed western coastal areas (between 6 – 15 knots).

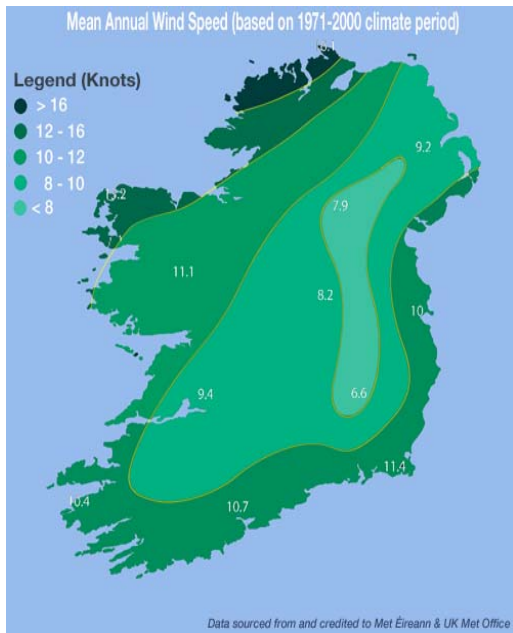


Figure 2: Mean annual wind speed Ireland (Met Eireann)

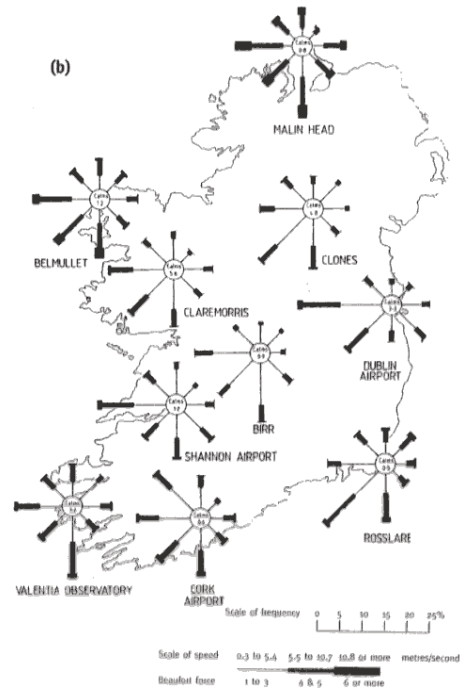


Figure 3: Wind roses Ireland (Met Eireann)

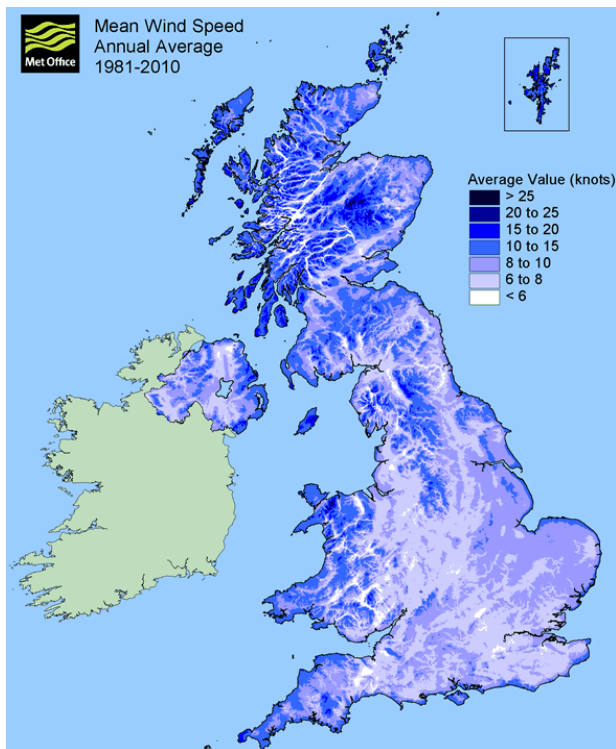


Figure 4: Mean annual wind speed UK (Met Office UK)

2.11.1 **Site design issues.** The Design Wind Speed is used to assess the suitability for natural ventilation and is typically measured at a height of 10 metres above open ground by continuously recording anemographs. These are presented as mean wind speeds that are likely to be exceeded by a specified percentage of time in a year. Wind characteristics however, need to be considered at differing climatic scales:

- the global – factors that create seasonal and diurnal differences as well as continental differences due to land mass and oceans;
- the regional – influence of mountain ranges, proximity to bodies of water;
- the local – urban variations, lakes, hills;
- micro climate – largely issues created by man’s influence in terms of buildings and infrastructure.

The influence of the local and micro-climate on wind speed is very important, most flows in nature are turbulent, laminar flow is the exception. Ghiaus C. and Allard F. (2005) note that air movement from rural to urban can reduce average wind speed by 20-30% and increase turbulence by up to 100%. As the wind blows over rougher terrain, such as towns and cities, frictional drag at the surface reduces overall wind speed whilst at the same time increasing the turbulence. This factor needs to be considered when designing for wind pressure ventilation in urban environments.

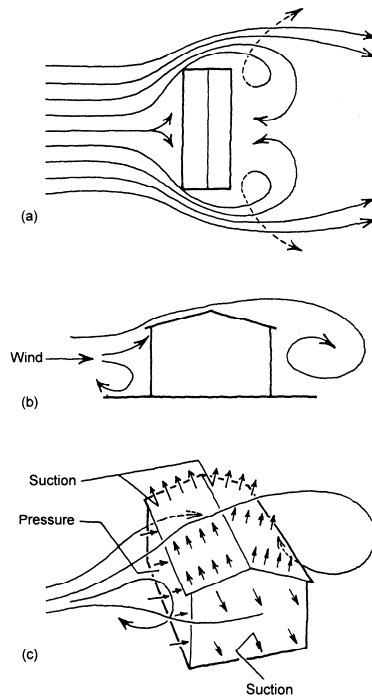


Figure 5: Wind directional pressures on buildings (Thomas R)

Blackmore P. (2011) noted that all buildings obstruct the free flow of the wind, causing it to be deflected and accelerated, resulting in complex flow patterns. When the wind strikes the front face of a building, it will produce positive pressures up to a maximum value at a point about two thirds of the building height. Below this height the wind will tend to be deflected down the front face towards the ground and accelerated around the corners at ground level producing areas both of higher wind speed and strong negative pressure. Above this height the wind will be deflected upwards and accelerated over the roof, again causing areas of high wind speed and increased turbulence. Downwind, the area known as the ‘wake’ is where the flows around the building recombine forming a region of negative pressure. This will persist for between about six and ten times the building height before the original flow patterns are re-established – in urban areas it is likely that further turbulence will follow.

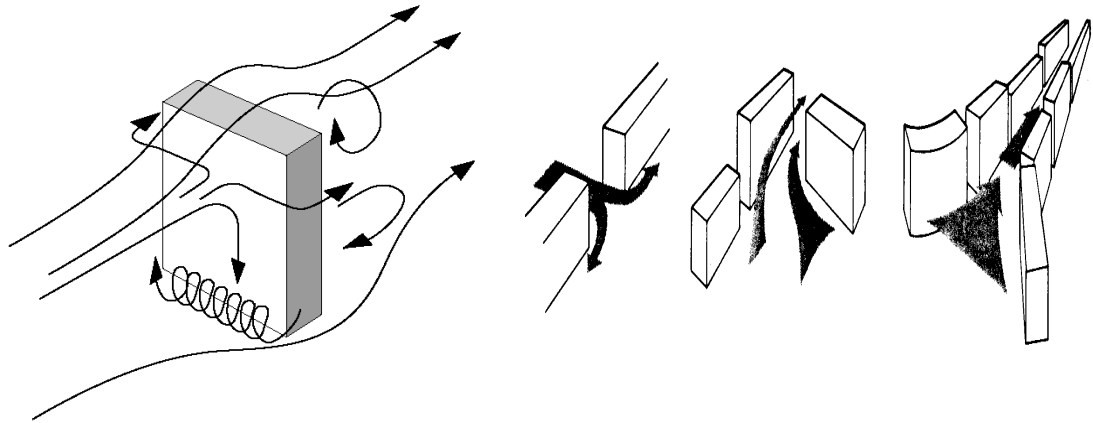


Figure 6: Wind directional pressures on site layout of buildings (Thomas R)

The performance of a naturally ventilated building is influenced by a number of key dimensions:

- Building spacing, particularly in urban areas, and understanding the microclimate for the building in terms of shading and wind
- Plan width/ depth, determines the ventilation strategy
- Room height, this gives the capacity of building to incorporate natural ventilation and day light and is improved by increasing the ceiling height. (CIBSE AM10, 2015)

2.11.2 Wind pressure and thermal buoyancy. There are two principle forms of natural ventilation connected with buildings: firstly, wind induced ventilation occurs through wind pressure distribution on a building and is determined by its orientation towards the prevailing wind as well as building geometry. Secondly, thermal buoyancy-induced ventilation occurs due to variation in air density as a result of a difference in temperature; the difference between openings for

intake and extract defines the vertical gradient in density. Thermal buoyancy is relatively straightforward to predict and control; it is a factor of temperature, air density and height differential between the two openings. Wind pressure on openings, due to the vagaries of wind direction and speed, is more difficult to predict and control (Heiselberg P. 2008). This is a strong factor in the development of Advanced Natural Ventilation (ANV) strategies which rely on the greater surety of thermal buoyancy. Wind driven ventilation is caused by differences in pressures acting across the external surface of a building. These pressure differences depend on the terrain surrounding the building; the wind speed and direction and the shape of the building (CIBSE AM10, 2005)

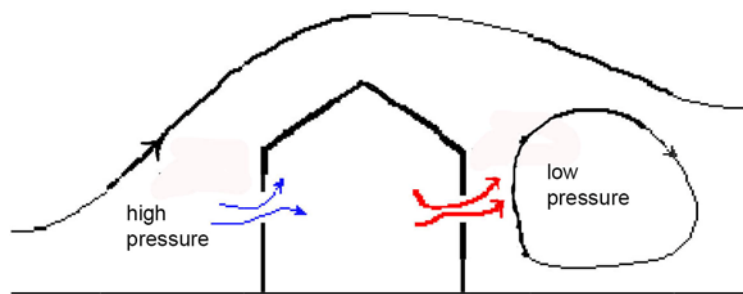


Figure 7: Wind pressure ventilation (author)

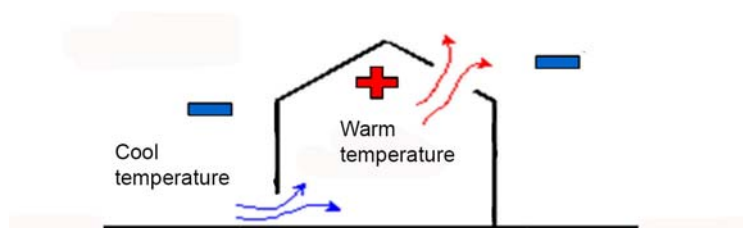


Figure 8: Thermal differential ventilation (author)

In terms of assessing the correct position for inlets and outlets it is worth noting that positive pressures will be created on the windward face and suction on the

building's side, flat roof and leeward faces. However, ASHRAE (2005) note that with pressure driven natural ventilation, wind may augment, impede, or sometimes reverse the airflow through a building. Any natural ventilation openings could see either a positive or negative pressure, dependent on wind speed and direction. This can occur even in our temperate maritime climate with a strong predominance of south westerly winds. One of the challenges of natural ventilation design is to ensure that the building will work notwithstanding changes in wind direction.

Equally, when wind and buoyancy ventilation are combined, they can assist each other resulting in a flow that is upward and straightforward. However, when in opposition, the air movement is complex and the two can cancel out the effectiveness of each other (Li Y et al. 2001). Thus in order to ensure optimal use of wind and thermal buoyancy correct positioning of the exhausts becomes crucial.

2.11.3 Natural ventilation strategies. A natural ventilation strategy suited to a particular building must consider:

- Depth of space relative to the size and position of ventilation openings
- Ceiling height
- Thermal mass exposed to air movement
- Location of ingress vents in respect to external pollution sources
- Heat gain within the building
- Climate including wind speeds, diurnal range.

Single sided ventilation (figure 9), in some respects the simplest form of venting a space, has been shown to be effective for room depths up to two-and-half

times the height of the opening (CIBSE AM10). As it is a wind pressure driven mode of ventilation it is dependent on external climate which means a low level of operational control. Single sided ventilation can be increased in effectiveness by high level and low level openings such as facilitated by the traditional sash window. This can increase effective ventilation depth to three times the height of the opening with incoming air usually entering at lower level and warmed air exiting at higher level. Useful for summer cooling and odour removal but, in a temperate maritime climate, this strategy will require winter heating of incoming air to avoid discomfort and subsequent energy losses.

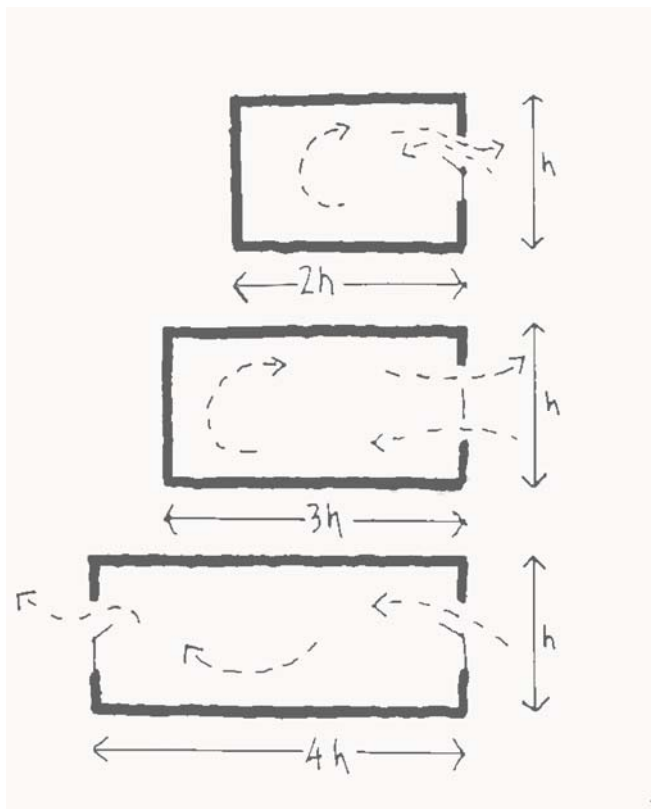


Figure 9: single sided and cross ventilation strategies – effective depth to height (author)

Cross ventilation (figure 9) is again largely wind pressure driven but will also have some element of thermal buoyancy where there is a change in height between

the inlet and outlet. This strategy is usually effective for room depths up to four times the height of the opening which has traditionally given building depths around 12 to 13m. Awbi (2003) claims effectiveness up to five times the height of the opening thus giving potential plan depths of in excess of 15m in standard commercial room heights (note however that this plan depth would be the maximum for useful day lighting which is facilitated by a room depth of two-and-half times the opening height). Like single-sided ventilation, it is dependent on external climate so a level of control is lacking and likewise, winter heating of incoming air is required.

Cross ventilation is usually conducted via windows and ducts but wind scoops can be used when there is a dominant prevailing wind direction. To improve air distribution into deeper spaces ducted or underfloor vent paths can be used – these supply ducts must be designed for very low pressure.

Stack ventilation covers those strategies where driving forces direct an outflow from the building and thus draw in cool air at low level and uses the density differential between cooler and warmer air. For equal ventilation rates the openings at ground floor need to be smaller than those nearer the top of the building. If using chimneys for stack ventilation then essential that the air in the chimney is warmer than the ambient air which might mean insulation required. The chimney outlet should be in the negative pressure zone of the building.

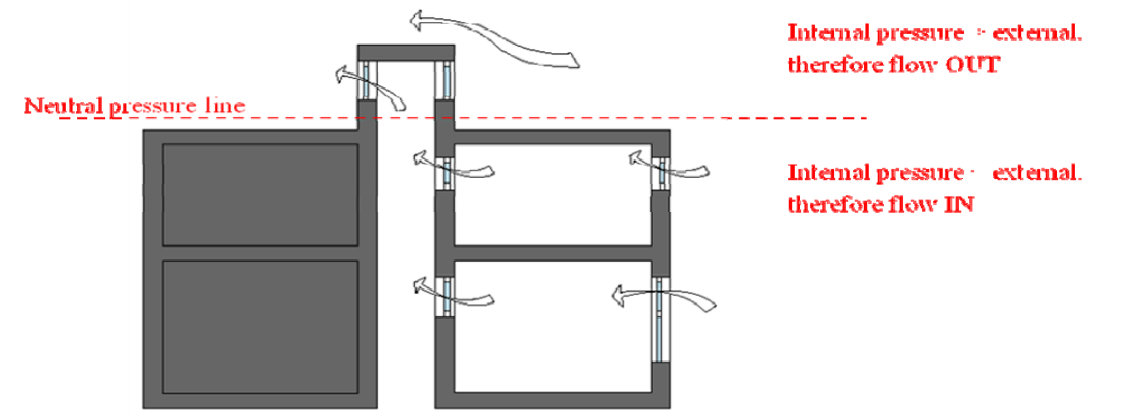


Figure 10: wind pressure and thermal buoyancy

Stack ventilation (figure 10) can be used when cross or single-sided ventilation strategies don't provide enough air or may be considered too unreliable. This can be because the building plan is very deep or because a high ventilation rate is required for example in auditoria. Thermal buoyancy is the main ventilation driver, but depending on positions of inlet and outlet, wind pressure may assist or indeed, counteract the ventilation effectiveness. Large enclosures and high-ceilinged spaces such as atria experience temperature stratification with the warm air at higher levels helping to drive stack ventilation.

Air flow in stack ventilation is due to:

- Stack pressure –this is proportional to the vertical distance between inlet and outlet; it also requires, and is driven by, the temperature difference between air inside and outside.
- The wind pressure at the discharge end of the stack.

Stack effect is due to density differences: warm air rising with cooler air replacing the rising warm air. The level within the building where the inflow changes to an outflow is the neutral pressure level. The position of the neutral

pressure level is a function of the density difference between cold and warm air and the vertical distribution of the openings. The stack pressures are a function of the temp difference and the height between the opening and the neutral pressure level. (CIBSE AM10, 2015)

Awbi further notes that the performance of the stack is most reliable in colder weather and high wind speeds when the temperature differential between inside and outside is greater and suction higher. The minimum height of the stack above roof level, to avoid back flow into the building, is dependent on the position of the stack above the roof and also the roof pitch. It is important that the vent stack is sized correctly in order to minimise pressure drops due to friction and dynamic pressure loss at outlets, bends, grilles and cowls.

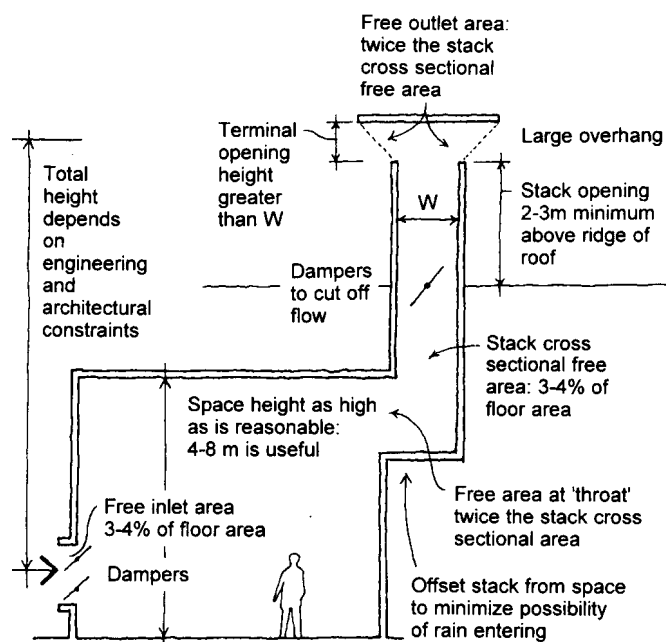


Figure 11: passive stack ventilation, design rules (Short A. 2017)

There are several factors which can be utilised in order to increase the effectiveness of natural driving forces in ventilation:

- Vertically spacing intake and extract openings as far apart as possible to increase thermal buoyancy.
- Optimising the use of wind conditions on site by using for example wind towers
- Using large room heights and volumes to even out variations in ventilation flow rates (Heiselberg P. 2008).

When utilising low level openings in the façade for natural ventilation then it becomes important to preheat the incoming air in winter to avoid cold draughts in winter. A combination of low and high level openings can work successfully: low level windows in the winter heating season, preheating the air and utilising the higher wind pressures; high level windows for the cooling season with the lower natural driving pressures, night cooling of exposed ceilings and larger airflow rates.

(Heiselberg P. 2008)

Heiselberg's work examines pressure losses and some of his conclusions are important rules of thumb in the design of natural ventilated buildings:

- Use as few ventilation components as possible i.e. keep it simple
- Use low pressure-loss components for example by using an aerodynamic form
- Use components that are easy to use and clean

- Minimise the need for ventilation channels by using façade air intakes and direct air transfer between rooms
- Use air paths of large dimensions and aerodynamic sections in which air speed is less than 1ms-1

Natural ventilation responds to the prevalent site conditions and, when well designed, is a measured interaction between external and internal environmental conditions. Site and climate data such as temperature and humidity, prevailing wind speed and direction, solar radiation, and external noise and pollution sources are all critical factors in assessing the role of natural ventilation in building design.

2.11.4 **Selecting the strategy.** CIBSE AM10 (2015) manual contains a useful section on the selection of the appropriate ventilation strategy which includes the following:

- Define the desired air flow pattern from the vent inlets through the occupied spaces to the exhaust. The air flow pattern must be considered for winter and summer regimes and night ventilation. Note that this is closely related to the form and organisation of the building: plan depth, layout, section heights, internal partitioning, window design, fire and acoustic requirements and external issues.
- Identify the principle driving forces for the desired air flow pattern. In a good design, the dominating forces are in sympathy with the intended air flow distribution. The magnitude and the pattern of air movement through a building depends on the strength and direction of the natural driving forces and the resistance of the flow path.

- Size and locate openings so that required air flow rates can be delivered: firstly the flow rates need to be determined using as a starting point the air quality and thermal comfort requirements; secondly size and locate the openings to deliver the flow rates, thirdly a control system must be specified to maintain the required flow rates under differing occupancy and varying weather conditions.

2.11.5 **Design Tools.** Traditionally, starting points for natural ventilation design were bio-regionally based, responding to general climate patterns and prevailing winds, afterwards being developed in a more site specific manner. Battle G., McCarthy C. (1999) note that the expansion of the aeronautical industry throughout the last decades of the Twentieth Century has provided a source for more accurate wind data and airflow testing facilities and this has led to an increased understanding of airflow around objects. As a result building designs have become more responsive to wind patterns and utilise these properties more efficiently to ventilate their interiors.

One of the initial difficulties of designing natural ventilation systems is the collection of relevant data. For example, the prediction of wind pressures on a building must be specific to the actual terrain; wind speed at roof level in a city may be only 33% of wind speed in countryside/ airports where wind speed is generally measured by the met office. There may also be microclimate issues such as local turbulence or the wind canyon effect. As CIBSE AM10 (2015) notes, because wind pressure is proportional to the square of the wind speed then a 67% reduction in speed gives a 10 fold reduction in wind pressure. Furthermore, the estimation of

internal temperature distribution especially in summer conditions using stack driven strategies can pose difficulties.

In order to determine the air flow quantities required, reference can be made to minimum ventilation rates for IAQ in winter months and summer thermal comfort can be based on temperature predictions which use some form of dynamic thermal analysis. For this the designer needs to know: glazing ratios and orientation; internal heat gains, weather data and the proposed ventilation strategy

As Battle McCarthy noted, computational programmes have become widely available in the last two decades. Selecting the appropriate tool for the complexity of the question is important: computational fluid dynamics predicts air movement and particularly local air movement and stratification and therefore is useful for the study of atria or other single spaces or zones. It is also useful for the prediction of external air flow around buildings. Physical models include salt bath techniques or wind tunnel testing; the former is particularly useful for stack driven strategies to model fluid flow whilst the latter deals with flows around buildings.



Figure 12: Wind tunnel testing (Loughborough University)



Figure 13: Wind tunnel testing (Loughborough University)

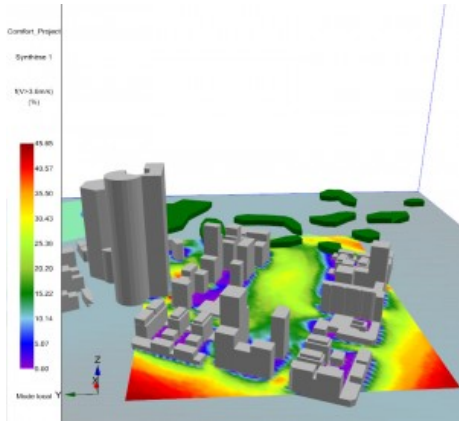


Figure 14:CFD modelling – (Meteo dyn)

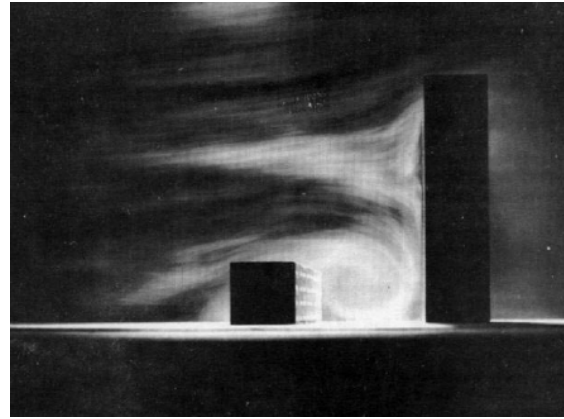


Figure 15: Smoke visualisation test (BRE 2003)

2.12 Natural Ventilation, the Architectural Response

“One of the key aspects of moving towards a sustainable architecture is to get the building itself to play a larger role, thus reducing the dependence on services” Thomas R. and Garnham T. (2007, p33)

Natural ventilation strategies, in order to be effective in the reduction of energy use within a building, have to work in combination with:

- internal heat load reduction strategies
- an envelope design that prevents summer overheating
- the placement of thermal mass within the building.

The design of these three elements, which is an integral part of the architecture of the building, entails that there is an impact on built form and detail.

2.12.1 The vernacular of ventilation. In pre-industrial vernacular architecture we recognise how buildings worked without the use of a low cost, carbon-rich fuel source such as coal or oil. Thermal control in particular was

traditionally provided by the building fabric as the “*primary agent of mediation between the external and internal environments*” (Hawkes D. P13 1996). This economy of means approach has provided us with a rich vocabulary of building methods from which to learn. Vernacular architecture demonstrates how to create a relationship between the building and the microclimate in the pursuit of thermal comfort; vernacular buildings act as passive modifiers of the external environment. Fathy H. (2000) working in Arid and Mediterranean climatic zones such as New Gurna, Luxor, Egypt has helped define a useful direction for climatically responsive architecture by evaluating traditional solutions and adopting, modifying or developing these to become compatible with modern living requirements.



Figure 16: Badgir, wind scoop and exhaust.



Figure 17: Urban wind scoops, Hyderabad

In terms of ventilation, architects and engineers have re-evaluated the vernacular of hot, arid bio-climates where wind towers and scoops have long functioned as part of natural ventilation strategies. One of the reasons for this is that the architectural forms employed have shown success with ventilation and cooling

requirements analogous to the thermal comfort demands of modern buildings in a temperate maritime environment (Roaf S. 2008).

The Malqaf or wind catcher used in Egypt from 1300BC onwards, orientated towards the prevailing wind direction, consists of a large shaft rising above the roof and channels the breeze into the courtyard below with outlets at high level above the central living space for the exit of the warmed air (Battle, McCarthy 1999).

Similarly, the Badgir (figure 16) – used in Iraq and the Gulf states – consists of a 3 x 3 metre wide and up to seven metre tall shaft which acts as both wind scoop and exhaust, open at the top on all four sides with a pair of partitions placed diagonally across each other down its length. When wind speeds are low and the scoop aspect is not functioning, the towers continue to ventilate the rooms using stack effect alone.

Urban wind scoops such as those in Hyderabad, Pakistan (figure 17), are some of the most evocative forms in bio-climatic architecture. Like the Malqaf (figure 18), these towers are open in a fixed position, designed to scoop up the prevailing afternoon winds, channelling cool air into each room of the multi-storey houses.

Roaf S., (2008) showed the variety of wind tower forms in Yazd or Shah-e-Badgirha (city of the winds); each area has its own range of shapes, sizes and orientation of tower. She observed the connection between the stack and interior noting that the more complex the internal path ways the stronger the air paths needed to be and more generally that:

“Forms and functions of wind catchers in reality vary enormously with micro, meso and macro-climate, geomorphology and the comfort expectations and habits of locally adapted populations” (Roaf S., 2008)

There are other architectural vernaculars of ventilation which can provide design inspiration: in Tropical zones with high average temperatures and humid air, wind speeds tend to be low (average 1-3m/s) so that achieving thermal comfort has been achieved by techniques to increase wind speed, such as the Malay and Indonesian roof forms of the traditional long house (figure 19). The building is raised on stilts to allow air to circulate underneath and through floor boards, but most striking, is the funnel-like gable end which directs air through the roof space, increasing its velocity, to cool the house.

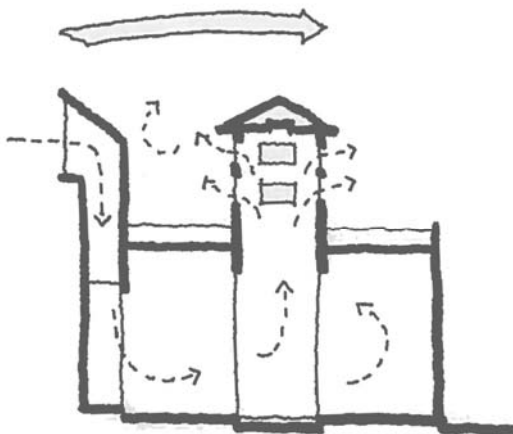


Figure 18: Section through a traditional Malqaf

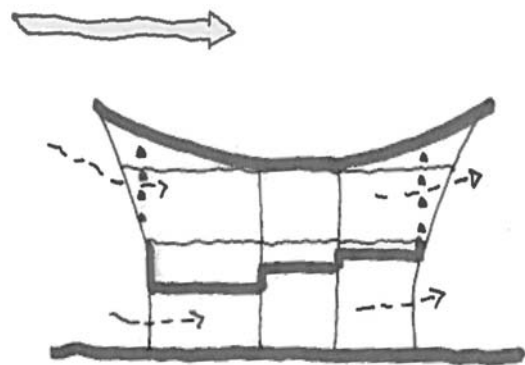


Figure 19: Section through Long House

2.12.2 The vernacular of biological organisms. In a similar manner to vernacular buildings, there are lessons to be learnt from biological organisms such as the mass structures of termite mounds, where the control of heat gains, thermal mass and ventilation become critical inter-related issues. In more complex animals (figure

20) respiration systems are required both to provide oxygen - so that energy can be derived from food - and to take away the products of this metabolism such as CO₂. Likewise in buildings, which need ventilation to bring in fresh air and to take away stale air; more complex buildings require a strategy developed in plan, section and elevation.

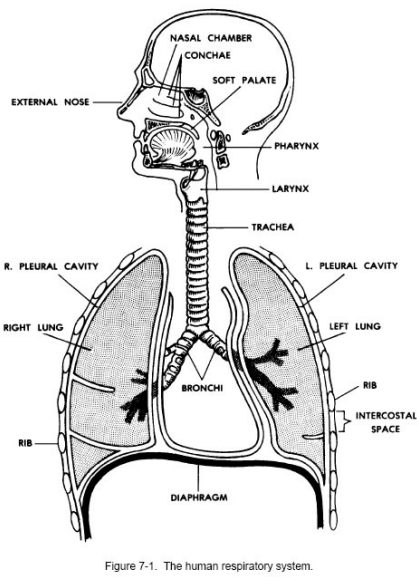


Figure 7-1. The human respiratory system.

Figure 20: Human respiratory system

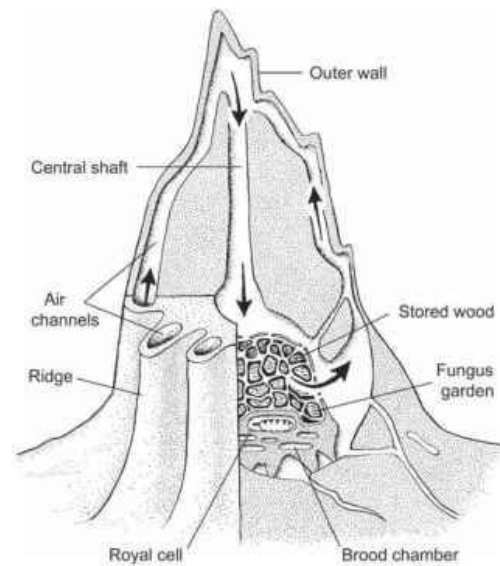


Figure 21: Termite mound ventilation routes

One such example is the termite mound (figure 21) which draws air in from outside through a constructed thermal mass to maintain air at 31° C (exterior air temperature can reach in excess of 50° C). The mounds also draw water up from the earth to maintain an internal relative humidity of 90%. Mound walls are 50cm thick and this provides both good insulation and high thermal inertia. It should be noted that the compact form of a termite mound absorbs less heat with the thermal mass positioned to absorb solar radiation during the day and to lose heat at night. The use

of thermal mass to temper ventilating air temperature is a critical part of natural ventilation design in buildings.

2.12.3 **The architecture of natural ventilation.**

“Architecture is increasingly being designed to utilise the free energy available from the environment, with the result that climatic forces are more and more responsible for shaping a new generation of structures”
Battle G. McCarthy C. (1999)

Wind pressure driven single-sided and cross-ventilation strategies require appropriate micro-climates providing steady average wind directions and strengths. These simple strategies demand specific plan depths relative to room height in order to function optimally. Micro climate, urban restrictions or building type may prevent these wind driven strategies from being utilised. In addition, the vagaries of wind pressure ventilation may even preclude single-sided or cross ventilation. Natural ventilation using thermal buoyancy gives increased reliability compared with cross ventilation and it is this reliability which has given designers and clients greater confidence to rely on a non-mechanised approach.

There is an important distinction between wind and thermal chimneys: wind chimneys or towers are designed to enhance the wind pressure differences which occur when air flows around obstacles. Inlets, such as wind catchers or scoops, function on a pressure increase whilst the outlets, usually towers or stacks, function on depressurisation caused by suction pressure due to either lee pressure or the Venturi effect. Ventilation stacks amplify pressure-driven cross ventilation forces

extending the effective depth of a naturally ventilated building. (Ni Riain C and Kolokotroni M. 2000)

In comparison, thermal chimneys utilise buoyancy forces generated by temperature differences caused by heat gains within the space. Solar chimneys are a variant on this and use passive solar gains to enhance thermal buoyancy, particularly to increase ventilation rates in summer on hot still days.

Chimneys are part of the elemental architectural vocabulary of ventilation particularly in “*the late 19th Century when health and hygiene concepts were promoted for both small and large public buildings*” (Ni Riain C and Kolokotroni M. 2000 p2).

Two key elements of wind pressure driven ventilation are towers and scoops. In their research work with Imperial College London, Battle McCarthy (1999) made the following observations: in order to operate in differing wind directions, wind scoops must be omni-directional turning to take advantage of the wind by the use of a vane. They are particularly successful when supplying large open spaces such as atria, facilitating the air supply mix within the space. In general they supply the air at a relative high velocity so should not be positioned close to occupants. Effectiveness of the scoop is maximised by catching the wind at the area of greatest positive pressure. This can be aided by height of the scoop and a suitable building shape where the form directs the air stream towards the scoop increasing wind speed and thereby increasing positive pressure (subsequently utilised by Battle McCarthy effectively in conical format at the Blue Water shopping centre, UK, figure 22).

Balanced stack ventilation, a transfer of Middle Eastern strategies such as the Malqaf and Bagdir, uses both high level inlets and exhausts. The effectiveness of wind towers to extract stale air from a building is based on producing the maximum pressure difference between air inlet openings and exhaust of the wind tower, therefore height is important. Optimum opening positions are determined by the air flows around the building: the ideal position to harness the negative pressure created by winds from all directions is at the centre of the roof. The height of the wind tower must be sufficient to avoid air turbulence around the roof and a taller tower will have stronger winds passing over it creating greater negative pressure in the lee. Like the wind scoops, it is best to have omni-directional inlet openings for all wind directions.

Modern variants of these traditional ventilation techniques use both the principles of wind scoop to drive air into the building and of passive stack as extract vents. Wind tunnel tests (Awbi and Elmualin A. 2002) showed that wind catcher performance depends more on wind speed than wind direction. Wind catchers are capable of providing larger air flows than conventional stacks because they harness wind pressures more effectively.

Wind scoops and wind towers can be used in combination and by collecting and extracting air at high level rather than through the facades can facilitate a greater pressure differential between the devices and thus enhance the air flow. In theory it is possible to utilise a single device for both inlet and outlet; Bed-Zed in London utilises one such system for domestic use (Dunster W. ZED factory, 2001, figure 23). A combined system with extract and intake all achieved at roof level can be

beneficial in urban conditions, here the wind is generally less polluted, carries less acoustic disturbance and is less turbulent.



Figure 22: Blue Water shopping centre wind scoop (Battle McCarthy)



Figure 23: BedZed wind cowls- ingress and egress with heat exchanger (Bill Dunster)

Thermal buoyancy has been used as the prime ventilation driver for the auditoria in the Queens Building at De Montfort University in Leicester (Short, Ford Associates, 1993) and the Contact Theatre in Manchester (Case Study Two). A variant on the thermal buoyancy strategy is solar-gain induced ventilation which involves heating part of the building fabric by solar irradiation to give greater temperature differences and so larger flow rates. Double skin façades can form part of this strategy, in these cases the whole façade acts as an air duct. This can work like a solar chimney heating the air to promote convective flow and so inducing extract; or it can operate as a supply plenum preheating incoming air to the building and if air gets too hot then a bypass vent is used. Examples include solar chimneys

with an optimum depth of 200mm (Bouchair A. 1988) and Trombe wall installations (with a depth of 50-100mm for warmed air to rise).

The principle of thermal stack ventilation for high rise buildings illustrates the usefulness of double skin facades for solar assisted stack ventilation (Wood and Salib 2013). The outer skin provides protection against weather conditions and external noise allowing for greater control of incident wind speeds. It operates as a thermal buffer mediating temperatures between inside and outside: winter uses passive solar gain to preheat air; or summer the buffer is ventilated to carry away excess heat. The outer skin can also protect the shading devices for both solar gains internally and glare. The GSW tower (Sauerbruch and Hutton, 1999, figure 24) in Berlin uses this technique on the southwest façade, with an outer single-glazed weather screen and inner double-glazed façade with opening windows. The interstitial space acts as thermal flue assisted by a roof top aero-dynamic wing which increases wind speeds and draw. The natural ventilation strategy relies on cross ventilation from east to west induced by stack effect – thermally assisted cross ventilation.

To enhance natural ventilation strategies particularly in tall buildings aerodynamic forms such as St Mary Axe (figure 25) cylindrical shape helps speed up wind as it passes and so increases pressure differentials for both intake and extraction. The wing roof on GSW tower uses the Venturi effect to generate additional uplift force in the thermal flue. (Wood A., Salib R. 2013)

The BRE Environmental Building at Garston, UK, (Feilden Clegg Bradley Architects 1997) utilises solar assisted thermal chimneys. A subsequent study of this building, which is both naturally ventilated and passively cooled, focussed on the

south façade passive stacks and their relative contribution to cooling through increased ventilation (Ni Riain C. Kolokotroni M. et al. 1999). The research concluded that, with the relatively narrow plan of the building at 12 metres, the cross ventilation flow paths could satisfy most of the summer cooling requirements, but that the passive stacks enhanced the cooling ventilation of the space during warm and still days and can also have the potential to assist night time cooling due to their thermally massive structure. Under warm still conditions the stacks can provide more ventilation than cross ventilation alone.

Buildings which operate on a displacement ventilation approach, that is, with air supplied at low level and internal heat gains warming the air so that it rises - such as theatres and auditoriums - can effectively use wind towers to remove warm air at ceiling level. In a similar manner, large volume spaces which permit air stratification to take place such as sports halls can use a form of displacement ventilation with high level extraction via wind towers.



Figure 24: GSW Tower Berlin, double skin stack (Sauerbruch and Hutton)



Figure 25: St Mary Axe, sky gardens (Foster Associates)

Atrium ventilation is a variant of the thermal chimney principle but the atrium serves other functions too within a building such as circulation and day light. For natural ventilation to be effective the depth of flanking spaces to be ventilated must conform to the cross ventilation limits: a maximum of 15 metres in plan depth. Atria are usually solar assisted with glazed roofs so the design should allow for a reservoir of warm air above the last occupied floor. Care should be taken also in order to prevent sun light heating up internal surfaces below the glazing; this may require some form of internal screens or external louvres. The atrium roof profile should position extract vents in the negative pressure zone or automatically opening depending on the wind direction. The height of the atrium above the surrounding floors must be sufficient to provide a reservoir of warm air and prevent warm air leakage back into the top floor (Wood A, Salib R, 2013)

Sky gardens, used in high-rise buildings, and atria, used more typically in deep plan buildings can be used for air intake and extraction. They function as buffer zones between outside and inside spaces and allow ventilation and daylight deeper into the plan. Norman Foster has used variants of the sky garden on the Commerzbank in Frankfurt (1997) and 30 St Mary Axe, London (2004, figure 25) in order to assist ventilation strategies in high rise buildings.

2.12.4 Related design issues. Related design issues with natural ventilation strategies focus on other areas of the building. For instance, thermal insulation and solar control are critical elements of envelope design: insulation limiting both solar heat gain and heat losses; solar control is valuable in preventing excessive solar gain in glazed areas. The limiting of internal heat gains is a necessary design and specification objective for equipment including computers, kitchens and lighting design. Both strategies are required to limit the cooling load that ventilation may have to otherwise deliver – whether natural or mechanically ventilated.

Thermal inertia, the thermal response of the building, depends on material thermal mass - the amount of heat a structure can absorb for a given temperature rise – and its placement within the building. Thermal mass is based on the specific heat capacity of a material to absorb energy. The correct use of thermal mass for limiting the peaks and troughs of internal temperature plays an important role particularly in night time cooling strategies and may be used to articulate a building's interior (figure 26). When heat enters a space the temperature rise will be in inverse relationship to the accessible volume of thermal mass; so if there is little thermal

mass in the room then the temperature will rise almost immediately (Baggs, Mortensen, 2006).



Figure 26: Thermal mass in ceiling deck at the Woodland Trust HQ. (FCB-Studios)

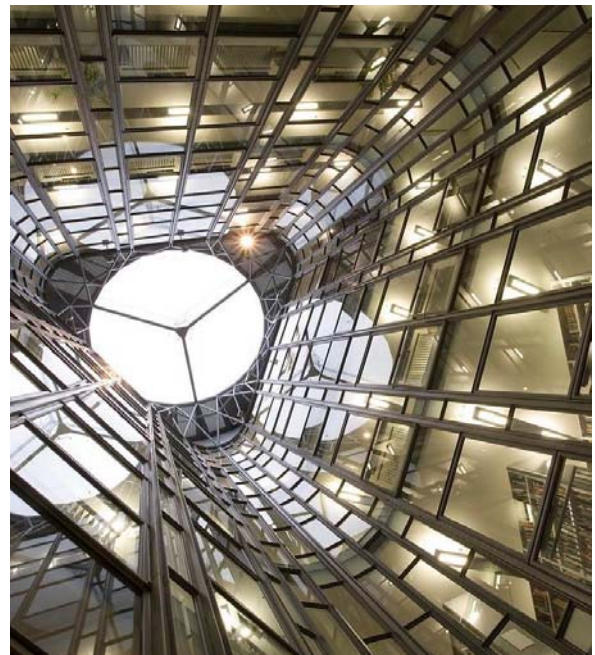


Figure 27: Atrium ventilation system in SSEES. (Short Associates)

In a similar vein, embedded earth ducts take advantage of fairly uniform ground temperatures to temper the incoming ventilation air. They have been utilised in combination with wind scoops such as at Mont Cenis, Herne (Jourda and Perraudin 1999) and in Dublin at the Airfield Estate (Solearth Architecture 2013 figure 28 - 29). Earth ducts can pre warm winter air or pre cool summer air but may sometimes require localised fan assistance. Well placed inlets into the building with actuators can avoid draughts. The ventilation outlet from the space is typically achieved through thermal buoyancy at a higher level.



Figure 28: Bench topped air inlet to earth tubes, Airfield Estate, (Solearth Architecture)



Figure 29: Air vent outlets to earth tubes, Airfield Estate, (Solearth Architecture)

An overall trend exists over the last few decades towards less heating and more cooling demand placed on buildings in countries with a temperate maritime climate. This is due to climate change but also to occupancy and the significant increase in incidental heat caused by technological advances. Passive cooling by night-time ventilation, therefore, has become increasingly important, particularly for commercial buildings. The basic concept, (Olesen B, et al 2008) involves cooling the building structure overnight by passing colder night air over the exposed thermal mass – usually positioned on the ceiling. The exposed thermal mass provides a heat sink that is available during the daytime occupancy period, re radiating heat during the unoccupied period at night when the relative temperature is cooler. A high potential exists for night time ventilative cooling in temperate maritime areas.

Fire engineering and smoke control take on more importance in a building design that relies on openness to generate air movement as fire may spread quickly along the natural ventilation paths (Wood A, Salib R, 2013). Prescriptive Building Regulations can also influence a natural ventilation system design with requirements on the opening size and opening locations in external walls. The need for compartmentalization may also limit the application of natural ventilation. However,

the regulations may not necessarily be a major barrier to the implementation of natural ventilation. Strategies such as heat and smoke detection for fire are linked to alarms which signal to the occupants, and openings can be automatically or manually controlled to close, or open for smoke ventilation. Short A. et al (2017) have invested considerable time in negotiating agreements with respective Fire Officers for their natural ventilation strategies. In particular the School of Slavonic and East European Studies - “*an engineered fire and smoke control strategy was brokered with the London Fire Brigade*” (Short A., 2017). It became necessary to define the building as one single compartment, naturally vented to extract smoke in order to avoid the sub-separation as a one hour fire compartment of the central air supply light well from the rest of the building which would negate its role as the lung of the building.

Similar issues arise in the acoustic design of naturally ventilated buildings as can occur with fire engineering. Again, particularly in the design of atria or stacks which link floors to facilitate air movement, these can conflict with the need to provide acoustic privacy. This can be overcome through degrees of separation of spaces and the use of separate vents for particularly noise sensitive spaces such as auditoria – as utilised in the Queens Building, De Montfort University. However, low resistance paths are demanded by the low pressure designs of natural ventilation strategies so that acoustic attenuation at inlets and exhausts becomes critical. In noise-polluted, usually urban environments, this can require a re-evaluation of the ventilation strategy employed: repositioning of inlets and extracts away from noise sources may be essential.

2.12.5 Vocabulary of ventilation, a summary.

Strategy	Architectural impact	Notes
single sided and cross ventilation	plan depths ranging from 8 to 15 m depending on ventilation openings and height of internal space	Relies on the unpredictability of wind direction and speed so tolerance in design required
Balanced stack ventilation	uses both high level inlets and exhausts.	Stack pressure is proportional to indoor-outdoor temperature difference and the vertical difference to the neutral pressure line (NPL).
wind towers	Towers typically are used to draw air out of buildings	to be effective must be omni-directional to facilitate suction as a result of different wind directions
Wind scoops	Wind scoops typically used to bring air in	to be effective must be omni-directional turning into the wind
Double skin facades	Double skin acts as thermal buffer zones to temper air	can be used for solar assisted stack ventilation and/ or utilise internal heat gains to drive the thermal stack
Sky gardens	Used in high-rise buildings for air intake and extraction.	They function as buffer zones between outside and inside spaces and allow ventilation and daylight deeper into the plan
Atria	Used more typically in deep plan buildings, central space between building accommodation providing daylight and ventilation;	requires outlets above surrounding ceiling heights and relies on inlets through flanking building accommodation which must conform to the cross ventilation rules.
Embedded ducts for passive heating and cooling	External vents, earth tubes and internal vents with louvers and controls	These take advantage of fairly uniform ground temperatures to temper incoming air

Additional measures to facilitate natural ventilation		
thermal insulation	Depth of insulation within building envelope	insulation playing the role of limiting both solar heat gain and heat losses
solar control	<p>External brise soleil related to quantity of glazing on southern, eastern and western facades</p> <p>Shading type: – internal, external, fixed or movable.</p>	<p>solar control being valuable for preventing excessive passive solar gain with glazed areas</p> <p>Note that:</p> <ul style="list-style-type: none"> • Glazing orientation - for good solar control better to orientate the primary glazed facades towards north and south. • Glazing ratio – solar gain is directly proportional to the glazed area – optimum for ratio of glazing to wall of 25- 50% depending on type of glass.
Limiting of internal heat gains	Lighting design - promotion of correct day-lighting strategies.	<p>design and specification issue for working equipment including computers and kitchen areas</p> <p>Heat gain control – internal issues</p> <ul style="list-style-type: none"> • Use of space • Occupancy – 70 – 100W per person • Lighting – lighting selection key • IT equipment
Thermal inertia,	Thermal mass placed usually at high level because heat rises.	<p>The correct use of thermal mass for limiting the peaks and troughs of internal temperature has an important role to play particularly in night time cooling strategies</p> <p>Positioning issues in ceiling:</p>

		<ul style="list-style-type: none"> • acceptable finish to concrete • Acoustic control • Integration with light fittings <p>Note thermal mass, because of cyclical nature of gains, only needs to be max of 75mm thick.</p>
passive cooling by night time ventilation	External vents and position of thermal mass	Cooling the building structure overnight in order to provide a heat sink that is available during the daytime occupancy period.
Fire and smoke evacuation	Fire and smoke detectors; smoke vents and potential compartmentation particularly important in the design of atria or stacks which link floors	Fire safety – where a fire barrier is rated at 30mins – it is possible to have vent openings but they must be closed in the event of fire. Also critical is the relationship between escape routes and the normal vent path
acoustic design,	low resistance paths are demanded within the low pressure designs of natural ventilation strategies so that acoustic attenuation at inlets and exhausts becomes critical Particularly important in the design of atria or stacks which link floors and the need to provide acoustic privacy.	Acoustics – important considerations for natural ventilation are external noise control through placement of vents or acoustic attenuation and the provision of acoustic absorption when large areas of thermal mass are present

Table 2: Vocabulary of ventilation – a summary

2.12.6 **Natural Ventilation System Components.** At design stage it is important to understand the air flow characteristics of each type of ventilation component and the way in which they influence performance:

component	Purpose	Design issues
windows	<p>Opening windows – effective opening important – and acknowledging pressure gradients at windows for single sided ventilation</p> <p>Position – high if required for night venting providing contact with thermal mass</p>	<ul style="list-style-type: none"> • Controllability: good control over smaller openings is important for winter comfort. • Comfort – summer breeze but winter draught? Separate vents for winter use – high level trickle vents? • Security – particularly in night ventilation mode • Integration with blinds • Maintenance and cleaning
trickle vents	Intended for background vent (c 5l/sec/person) so main purpose is for winter months	
louvres	When closed can be difficult to create air tight seal	
dampers	Used with automatic control	
shafts and ducts	Shafts – vertical distribution; ducts - horizontal – sized to keep pressure drops low and so usually larger dimensions than mechanical	<ul style="list-style-type: none"> • Position of roof outlet – minimum height above roof level at roof s of less than 23 deg pitch is 0.5m. • Design of cowl should prevent rain entering the stack and can accelerate flow close to outlet. • require provision of inlet screens and access for cleaning.
Internal obstructions	Obstructions from such as partitions and doorways	<ul style="list-style-type: none"> • degree of compartmentalisation is important to understand at design – e.g cross ventilation – transfer grilles incorporated and their resistance assessed

Table 3 Ventilation system components - Adapted from CIBSE AM10

The architecture of natural ventilation for public buildings covers a range of differing building types from less densely inhabited office spaces through to the heavy ventilation demands posed by the density of occupation of auditoria. It raises the question does the form of natural ventilation systems follow human occupation density? In order to answer this and thus gain a more specific understanding of the architectural vocabulary of natural ventilation, it is instructive to look at building types with differing occupational densities and differing spatial challenges. These typologies present differing ventilation requirements in public buildings: firstly offices, a typology with a relatively low ventilation load required from occupation levels of an average of one workspace per 10.9sqm (British Council for Offices 2013); secondly, auditoria with conversely a high ventilation load required from occupation levels of circa 1sqm per person; and thirdly a library with medium ventilation loads and occupation levels of circa 3sqm per person (both figures from the Metric Handbook 2002). A spatial differentiation in the case studies also exists with both shallow plan and deep plan buildings investigated. Natural ventilation strategies tend to eschew deeper plans but these can be required by clients demanding greater flexibility of internal space usage or as a specific context related spatial solution.

2.13 Vocabulary of ventilation: Offices

The first air conditioned office building was the Milam Building in San Antonio Texas by Willis and Diver in 1928 (Banham, R. 1969); ten years later the emergence of the fluorescent tube light, with its relatively low heat output, meant that air conditioning could cope, economically, with internal heat gains in office buildings.

“The use of PSALI (permanent supplementary artificial lighting of interiors) at the core of very deep floor plans could never have come about without the neat confluence of the potentials of air conditioning and fluorescent light” (Banham R. 1969)

And with that marriage of convenience, Banham goes onto say that:

“All precepts for climatic compensation through structure and form are rendered obsolete”.



Figure 30: UK open plan office showing use of suspended ceilings and artificial lighting within a mechanically ventilated office (Shahzad S.)

An internal office architecture of suspended ceilings with acoustic tiles, recessed lighting and hidden ventilation ducts became synonymous with our white collar work places in the latter 20th century; albeit, not without recurring issues of

occupant dissatisfaction with their environment, poor internal air quality and high energy consumption. All three of these issues have been instrumental in the re-evaluation of the environment of work places in the late 20th century.

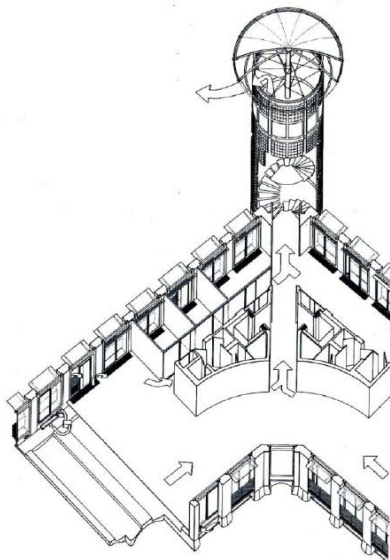


Figure 31: Inland Revenue Centre, internal axonometric showing ventilation paths (Hopkins Associates)



Figure 32: Inland Revenue Centre, internal view showing sinusoidal ceiling to expose thermal mass (Hopkins Associates)

A receptive attitude towards naturally ventilated office buildings emerged as the background to the development of designs in the 1990s. The Inland Revenue Centre in Nottingham (figures 31, 32) a 40,000 sqm office complex completed in 1994 and designed by Hopkins Architects with Ove Arups as both structural and services engineers. The design utilises a solar chimney stack-induced cross ventilation strategy with a designed energy consumption of 89kWhr/sqm/year. The complex consists of seven free standing courtyard and L shaped buildings with a constructional system that includes precast brick piers and wave form concrete floor slabs to provide exposed vaulted ceilings to the interior. These slabs function both as

the structural floor deck and as exposed thermal mass which is purged of its collected heat through a night time ventilation cooling strategy. Air enters through occupant controlled tilt and slide windows and under floor perimeter inlets and exits the building via solar assisted corner ventilation towers. At the corners of the blocks, the air within the glass block stair towers warms and rises on sunny days, assisting the ventilation paths within the office space. Fabric umbrellas on the tops of the towers act as large dampers, lifting on warm days to exhaust hot air. The fabric roof of each tower can be raised or lowered to control the ventilation rate of exhaust. The fire rated doors to the stairs are held open on emergency release electro-magnets. The site is laid out as a campus and in this manner external ventilation paths into the buildings are largely preserved. Hopkins employed here and in Portcullis House (2001) light shelves to the southerly facades to shade the office spaces from unwanted solar gain and to bounce daylight deeper into the plan of the building.

The BRE Environmental Office Building in Garston (Feilden Clegg Bradley Architects, 1997) uses similar natural ventilation strategies (figure 33 - 35). A key part of the brief was to reduce the energy consumption and CO₂ emissions by 30% from what was then current best practice. A natural ventilation and cooling strategy was employed utilizing five glass fronted stacks to the south side as extract ventilation which assist in drawing cooler air through inlet vents on the opposite side of the building. Exposed curved hollow concrete floor slabs are used to maximize available thermal mass for tempering internal temperatures and as part of the night time purge cooling strategy. Day lighting to the offices is maximized but glare and solar control is managed by external louvers.



Figure 33: BRE office building south elevation; showing thermal chimneys. (Feilden Clegg Architects)



Figure 34: BRE office building interior; showing curved concrete soffit. (Feilden Clegg Architects)

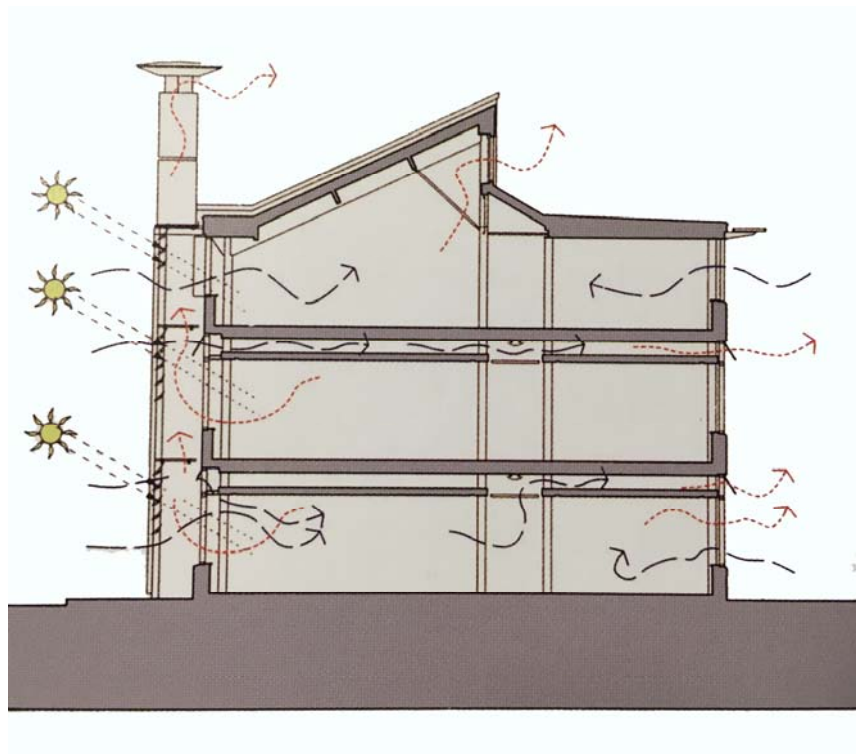


Figure 35: BRE office building section; showing cross and stack assisted ventilation paths. (Feilden Clegg Architects)

Bucholz McEvoy Architects designed a predecessor to Limerick County Council Offices (see Case Study One) in Swords for Fingal County Council in 2000 (figure 36). Like the Limerick County Council Offices, it employs a single-sided atrium both in the creation of an internal public space and to assist cross ventilation using a thermal buoyancy strategy. The atrium is north-west facing which limits the potential usefulness of passive solar gain in the atrium space but relieves it from the need for complex solar shading. The building was designed with narrow floor plates and sculptured exposed concrete soffits to assist the natural ventilation strategy whilst providing useful thermal mass.



Figure 36: Fingal County Hall atrium. (Bucholz-McEvoy Architects 2000).

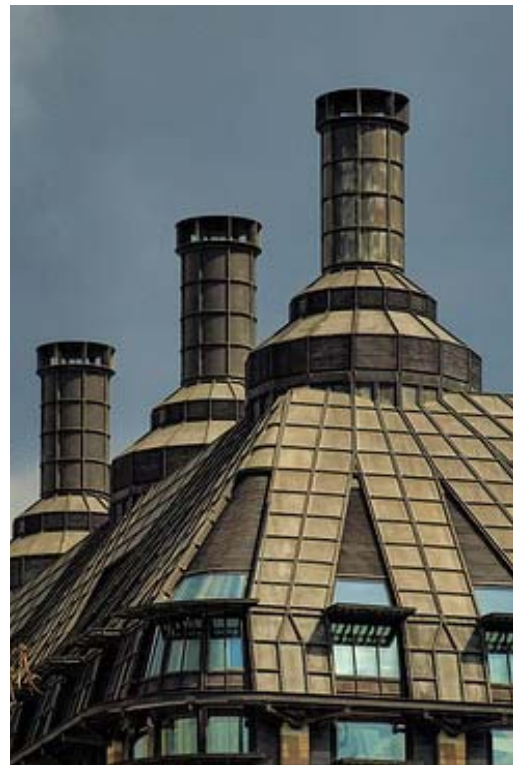


Figure 37: Portcullis House, ventilation stacks. (Hopkins Architects 2001).

The reduction in cooling loads due to solar shading, daylight controls for lighting, and the correct assessment of IT loads is critical to the success of natural

ventilation strategies (CIBSE good practice guide 237, points out that IT loads rarely exceed 20W/sqm and natural ventilation strategies have been shown to be able to handle 40W/sqm total heat load). A natural ventilation system also needs to work in a range of conditions as well as avoid the ingress of external pollutants. This is a particular issue in urban environments where careful placing of the inlets is required. Portcullis House, London (Hopkins Architects, 2001, figure 37) deals with the street pollution by placing high level air inlets at the base of the ventilation chimneys; fresh air from these is fed into under floor plenums and then into rooms where, as it warms, it rises and exits in ducts located on the outside of the building, rising through the tall chimneys which act as ventilation stacks.

2.13.1 Key architectural elements for naturally ventilated office spaces:

-
1. clear ventilation paths as part of the site strategy. A narrow floor plan to encourage cross ventilation, (c.12m)
 2. heat load reduction strategies both internally and externally against excessive solar gains
 3. thorough planning of the internal ventilation flow path for all seasons. Generally open plan but cellular offices with solid partitions at right angles to perimeter walls partitions to allow flow of air
 4. high floor to ceiling height (c 3m) in order to increase day light penetration and allow space for stratification of hot air to collect above the occupant zone
 5. day-lighting with occupant control of glare and operational windows. Possible use of glass light shelves to shade perimeter offices but allow daylight into deeper plan
 6. careful positioning of service centres for possible separate venting systems
 7. exposed concrete soffits for thermal mass – sinusoidal to increase surface area and to assist with acoustics; coupled with the above, a raised access floor for cabling services to enable flexibility
 8. thermal buoyancy cross ventilation assistance provided through towers, stacks or atriums.
 9. BEMS for lighting, heating, ventilation, but with occupant override control

Figure 38: Key architectural elements for naturally ventilated office spaces

2.14 Vocabulary of ventilation: Auditoria

In contrast to the office work place with a density of occupation of c.10 per sqm, the auditorium is at the other end of the spectrum with closer to 1 person per sqm occupancy. The general ventilation challenges facing theatre design are due to their intermittent heavy occupancy and the high thermal loads from stage lighting (Jones P. 1997). In addition, both due to sightlines and the need to stratify warm air above the heads of the audience, theatre auditoria are generally quite high and of large volume. Air conditioned solutions for theatres tend to have relatively high running and maintenance costs and as such, naturally ventilated solutions can offer dramatic savings over time (Jones P. 1997). However, it should be recognised that although the capital and maintenance costs of the mechanical plant for such an approach are lower, the building costs for naturally ventilated theatres can be of an equal magnitude if not more.

Natural ventilation for auditoria uses a form of displacement ventilation with warm air being evacuated at upper levels pulling in fresh air below. Large inlets and outlets are required to ensure that the warmer stale air remains above the audience's breathing zone, the issue of which can be exacerbated with steep raked seating and balconies. Auditoria rarely have windows and require strict black out conditions so that the placement of inlets and outlets needs careful consideration. Furthermore inlets (as in all naturally ventilated buildings) must be positioned so as to avoid negative pressures that limit air intake. In terms of operational strategies the varying and intermittent use requires a BEMS that is able to respond effectively to these dynamics and at differing levels of occupancy.

“The environmental problems caused by large numbers of people crowded into confined space have been a problem since the theatre became a fully roofed enclosure. Added to this are the high heat loads from lighting.” (Kenton A.2004)

The history of theatre design, notably surrounding the particular environmental demands of ventilation, is complex and rich. By the late 1870's the advent of electric lighting eased the problems of ventilation caused by gas, though brought its own issues of thermal loads (Kenton A. 2004). By the end of the 19th century electrical fans began to assist air movement. The former Kursaal in Harrogate UK, now known as the Royal Hall, (Mitcham, F. 1903, figure 39, 40) illustrates some of the preoccupations of naturally ventilated theatres of this period. Much of the original ventilation design is still in existence today. Fresh air for the auditorium and stage is brought in at roof level via square ducts with omni-directional fixed louvers. The air is delivered to ground level at the rear of the auditorium, preheated as required and then rises in displacement mode due to the heat generated in the auditorium. The warmed stale air is extracted through decorative ceiling vents and exhausted via six outlets on the roof. The variegations of the roofscape designed around the inlets and outlets are part of the architectural power of the building's appearance.



Figure 39: Kursaal interior, Harrogate UK (F. Mitcham Architect)

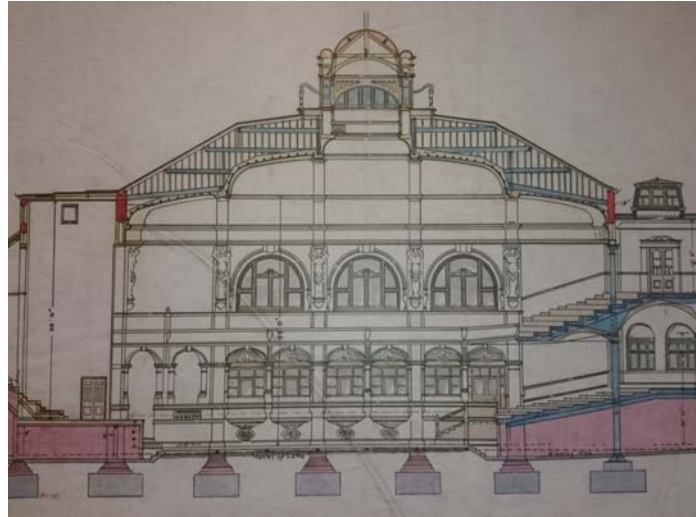


Figure 40: Kursaal, section, Harrogate UK –(F. Mitcham Architect)

In contrast, the first air conditioned theatre was probably the Metropolitan in Los Angeles in 1922 (Banham R.1969). By 1930 the Carrier Engineering Corporation had air-conditioned 300 theatres in the United States and this became the preferred mode of ventilation for theatres during the 20th century (Kenton A. 2004). The standard system is often distinguished by air entering through overhead diffusers at low velocity, from where it settles in a cool blanket over the whole audience then to be extracted through grilles in risers under the seats. This reversed the 19th century system of blowing air in under the seats.

Following on from the oil crisis of 1973 came renewed interest in low-energy buildings, particularly in the UK, and several examples of naturally ventilated auditoria existed prior to the rebuilding of the Contact Theatre (1999). The drivers behind the new designs were different from those of the 19th century:

“Electric lights are in use ubiquitously, but modern audiences expect a sanitised environment. The internal environment of the theatre is

therefore expected to provide air quality on a par with air-conditioning.”
(Kenton A.2004)

Strategically the approach in relation to the intake and extraction of air are similar to those used in the 19th Century. Air intake is typically at low level passing through acoustic dampers and entrained through a plenum of thermally heavyweight material. The thermal mass of the plenum assists in pre-cooling the air intake in summer, and in warming the incoming air in winter above the external ambient temperature. Heating in winter is via radiator coils usually under the auditorium seats, the warmed air passes into the auditorium and rises; the stale air is generally exhausted directly through stacks from the auditorium to the outside.

The Olivia Theatre at Bedales School in southern England (Feilden Clegg Bradley Architects 1996, figures 41, 42, 43) utilises a single stack vented auditorium with an electric fan used to increase the ventilation rate should it be required at higher temperatures. Air enters through an undercroft (plenum) from two opposing sides and is preheated as required by steel fin heaters. The thermal mass of this undercroft is a critical part of temperature control, particularly as the building envelope of the auditorium is of timber frame construction. The BEMS controls the electric fan operation and the extract dampers on each side of the stack. Ventilation rates in the auditorium are determined in response to CO₂ levels and to velocity monitoring sensors beneath the seats. Temperature control in the undercroft is used to control whether night time thermal purging is required.



Figure 41: Bedales Theatre, UK; exterior view showing stack above auditorium. (Feilden Clegg Architects)



Figure 42: Bedales Theatre, UK; interior view showing auditorium space rising to a central stack. (Feilden Clegg Architects)

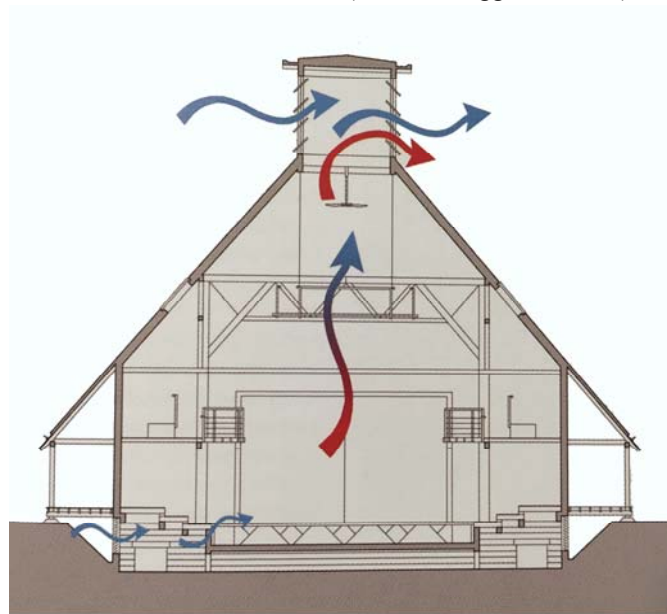


Figure 43: Bedales Theatre, UK; cross section showing incoming air to plenum rising through the auditorium space to a central stack. (Feilden Clegg Architects)

The Contact Theatre design has taken its cues from the lecture auditoriums designed at the Queens Building, De Montfort University (figure 44), Leicester, (Architects: Short Ford Associates; Max Fordham Associates service engineers,

1993). This engineering school of 1000sqm has an overall energy consumption of 120kWh/sqm/yr. The central portion of the building has a deep plan and utilises stack effect chimneys to extract air from the laboratory concourse and atria. A row of chimneys exhausts stale warm air from the auditoria. Each auditorium is supplied by air at low level through acoustic dampers to reduce noise from the adjacent street and passes through a plenum under the raked seats. The height of the auditorium is sufficient to allow one meter depth of warm stale air in the space to be above the heads of the occupied zone.

When the auditorium (figure 45) is in heating mode high air buoyancy can result which can cause draughts thus dampers are required to vary louver opening size accordingly (Short A. 2017). The single stage preheating strategy was considered crude and it was found that incoming air can by-pass the finned tube heating elements. The single stage heating is replicated later in the Contact Theatre (Case Study Two) however with greater proximity between the heating fins and the air inlets to the auditoria; but for the Lanchester Library (Case Study Three) a two stage preheating system was used. The dampers for the incoming air at Queens were found to be not sufficiently accurate for the required level of operational control and this feedback forced a rethink of the design of the Contact Theatre and Lanchester Library. Thermal mass was found to be useful, especially when coupled with night time ventilation, in slowing temperature rise during summer periods, the mass positioned both in the plenum and in the auditorium.

The height of ventilation stacks was found to be critical as a high stack may allow the air to cool to the extent that back flow may occur into the auditoria –

although design tests showed this not to be the case. Another issue to consider in the design of the ventilation stacks was whether on a cold, damp, still winter morning there would be too much inertia for the stack effect to work. In order to safe guard against this at design stage, a fan was installed in one stack in each auditorium.

(CIBSE AM10, 2015)

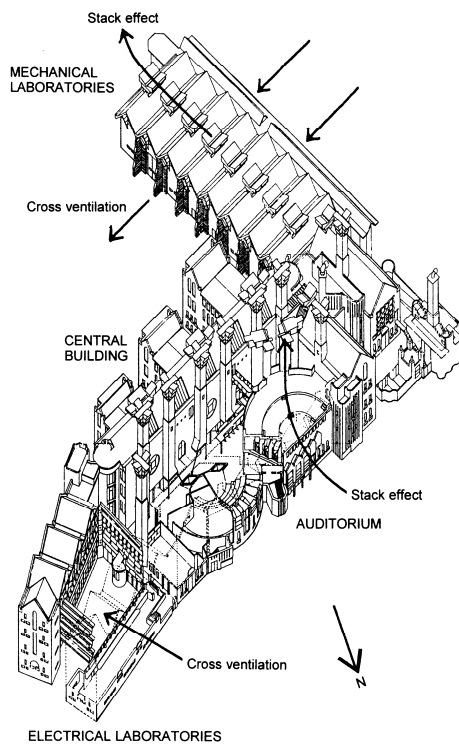
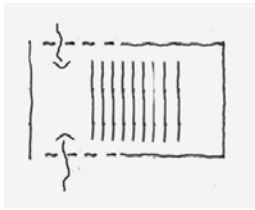


Figure 44: Axonometric, Queens Building, De Montfort University; Leicester, UK.; (Short-Ford Associates)

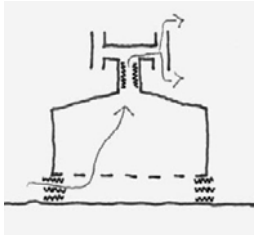


Figure 45: Interior of auditorium, Queens Building, De Montfort University; Leicester, UK. (Short-Ford Associates)

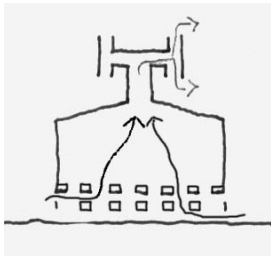
2.14.1 Key elements for naturally ventilated auditoria:



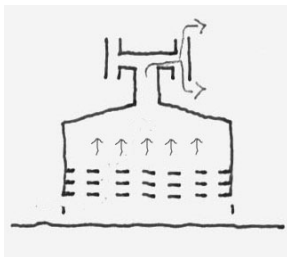
1. clear ventilation paths as part of the site strategy



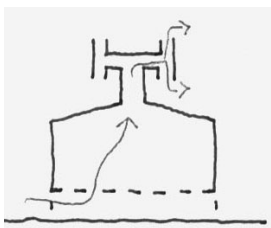
2. use of acoustic dampers to lower noise ingress at intake and extract



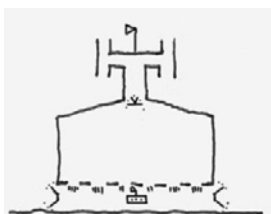
3. use of a plenum to balance out air flow across the auditoria with exposed thermal mass within the plenum and auditorium for summer temperature control



4. height of auditorium to allow space for stratification of hot air to collect above the occupant zone



5. extract stacks above auditoria to take advantage of thermal buoyancy



6. BEMS for lighting, heating, ventilation

Figure 46: Key elements for naturally ventilated auditoria

2.15 Vocabulary of ventilation: Libraries and advanced natural ventilation in deep plan buildings

The design of the new reading room at the British Museum in London (Panizzi A., Smirke S. completed 1857, figure 47) is an interesting precedent in the design of a deep plan library building – its plan layout being 56m by 78m. The ventilation system employed utilises a 1.8m high plenum beneath the reading room which is connected to it by ventilation tubes beneath the reading tables. The plenum is fed by an 18m high chimney to bring in fresh air which can be diverted via heating pipes when required. Extract is through ventilation grilles in the window soffits at the base of the dome and above the heads of the reader at the top of the dome. The construction of the dome has two voids: one functioning as a thermal buffer between the brick lining and the outer copper and the other between the brick and the suspended ceiling which allowed the warm, stale air to escape (Hawkes D. 2012). The integration of constructional system of the dome with the ventilation system is a good example of intelligent design. The use of a plenum draws on research work undertaken by Reid D. (1844) in *Illustrations of the Theory and Practice of Ventilation* and the use of which persists until today.

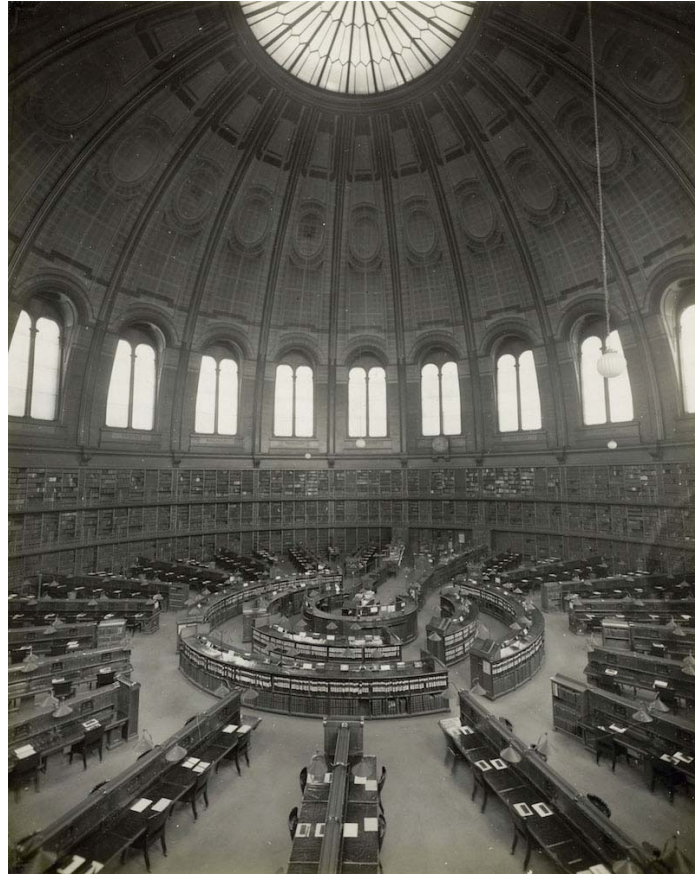


Figure 47: Interior of the Reading Room, British Museum, London, UK - showing the vent extracts above the windows in the soffit and at the top of the dome and intakes are concealed beneath the tables. (British Museum archive)

The ventilation of deep plan libraries still has to deal with the issues of thermal buoyancy of stale air, the use of an air mixing plenum and the supply of fresh air into the space. It is these principles which form a background to the development of Advanced Natural Ventilation (ANV) undertaken at the Department of Building Simulation at Loughborough University directed by Professor Kevin Lomas. In his writings (Lomas K. 2006) makes the distinction between simple natural ventilation (SNV) strategies, which generally work using a combination of thermal buoyancy and wind pressure, with ANV strategies. ANV is characterized by use of ambient air to cool and ventilate a building utilizing the internal buoyancy forces generated by internal heat gains alone. These allow the building's natural ventilation strategy to

operate effectively independently of external wind pressure variations. These strategies can enable deep plan buildings with sealed facades to be naturally ventilated – such as libraries.

Conventional naturally ventilated buildings are shallow plan with an extended perimeter and façade openings which provide fresh air and exhaust. These might not always be compatible with tight urban sites where perimeter inlets are generally susceptible to noise, pollution and security issues. At the design stage, reliable prediction of internal conditions is difficult for SNV because it relies on variable pressure differences set up across the building.

ANV on the other hand brings together the two principles of stack driven flow and displacement ventilation - cool air entering in at lower levels of a building or floor plate with warm air extracted at the upper levels. The flow rate of the air in the building is proportional to the strength of the heat source within unrestricted displacement ventilation (Lomas K. 2006). This means that prediction of performance at the design stage can be comparatively reliable and controllable. Lomas notes that there are different forms of stack ventilation which he has characterised based on the particular intake and extract positions: ‘edge in centre out’ (such as Short’s Queens Building at De Montfort University, figure 48, 50); ‘edge in edge out’; ‘centre in centre out’; ‘centre in edge out’. Lanchester Library is a ‘centre in edge out’ stack ventilation system.

It is also interesting to note that, when looking at deep plan building designs, stacks have the advantage over atria (an alternative design strategy for natural

ventilation for deep plan buildings) of requiring less space, of providing more reliable ventilation performance and in having stack terminations which are less susceptible to wind effects and can if necessary incorporate low-powered axial fans. If designed correctly they can also provide the benefits of dispersed day lighting as, if not more, effectively as atria.

It appears that Lanchester Library in Coventry UK can bear the accolade of the first deep plan ANV building. The team of Short Associates and Kevin Lomas have however, subsequently, been involved in a number of other ANV buildings, notably the School for Slavonic and East European Studies in the London heat island which uses, in summer, a passive down-draught cooling ventilation strategy. Also of note is a further library design for Judson University in Chicago within a temperate continental climate of hot summers and cold winters (figure 49). The design - like Lanchester Library - follows a ‘centre in’ ventilation supply through a light well and ‘edge out’ exhaust air stacks embedded in the façade. Air enters the library spaces from the light well via BEMS controlled openable windows.

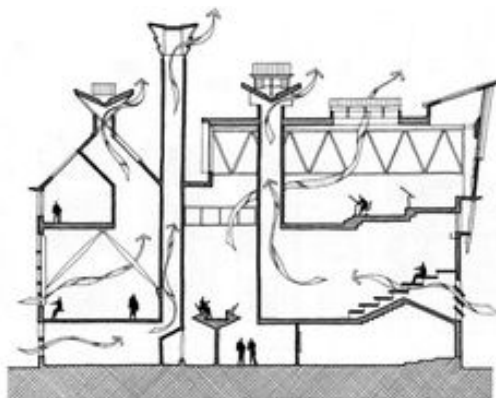


Figure 48: Queens Building, ‘edge in – centre out’- Short Ford Associates



Figure 49: Judson University Library, Chicago - Short and Associates



Figure 50: Queens Building, ‘edge in – centre out’ ventilation – inlet vents visible on street elevation and chimney stacks outlets - Short Ford Associates

These further ANV building examples both have a basic square deep plan – for low surface area to volume ratio and with high insulation levels used in the roof and walls to minimise fabric heat gains and losses. Windows are shaded to reduce heat gains through a variety of methods including deep window reveals or metal louvers. There is too an enlivened roofscape of extract stacks and terminations and, embedded in the building plan, the use of light wells doubling up as ventilation supply routes. Flat concrete ceilings are utilised for night cooling with minimal or permeable down stand beams to avoid inhibiting air movement. A specific architectural vocabulary of ANV is emerging.

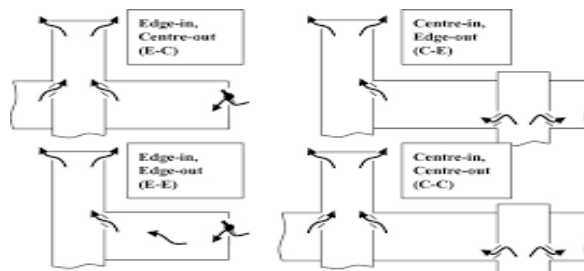
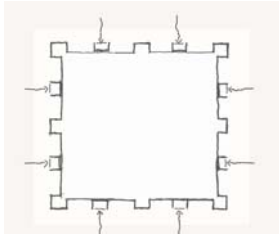


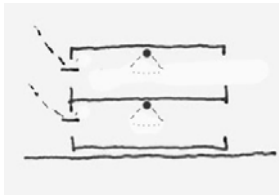
Table 4: Characterization of advanced naturally ventilation strategies, Lomas K, 2006

2.15.1 Key architectural elements for Advanced Naturally Ventilated

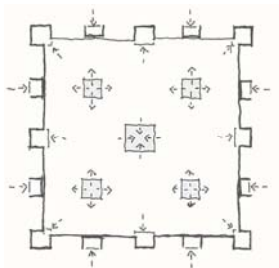
buildings:



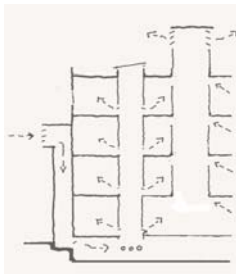
1. clear ventilation paths as part of the site strategy



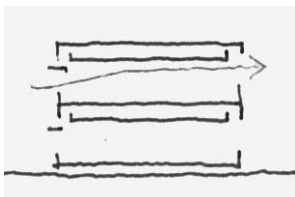
2. heat load reduction strategies both internally and externally against excessive solar gains



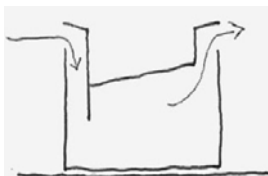
3. thorough planning of the internal ventilation flow path. Light wells doubling up as ventilation ducts



4. incoming air use of a plenum to balance out air flow across the space; exposed thermal mass within the plenum for summer temperature control



5. Flat concrete ceilings used for both thermal mass and so as not to inhibit air flow



6. Intake scoops and extract stacks to take advantage of thermal buoyancy

Figure 51: Key architectural elements for Advanced Naturally Ventilated buildings

3.0 Chapter Three Case Study Methodology

3.1 Introduction

The purpose of this research is to investigate the impacts and implications of natural ventilation strategies on architectural design in public buildings. Domestic buildings have their own ventilation issues particularly in regard to humidity control in well-sealed buildings. However, it is the potential benefits of natural ventilation and the resultant architectural forms of public building typologies which is the focus of this investigation. This relatively broad category contains different building types with potentially differing ventilation responses. The literature review has investigated the requirements for ventilation and examined four criteria to gauge the usefulness of natural ventilation as opposed to mechanical systems: namely Energy Reduction, Thermal Comfort Provision, IAQ and Ease of Operation of the ventilation system. Following this, the different architectural responses to the physics of natural ventilation have been examined and in particular the more detailed responses of differing building types.

From this study of building types we have started to define appropriate strategies and a formal response to natural ventilation. This then forms the basis for the range of case study choices.

3.2 Case Studies

In order to understand the implications of natural ventilation design strategies on how the building typologies function, three case studies have been investigated. The selected buildings are all within the temperate maritime climatic zone, in the UK and Ireland and purposefully not within the known heat island of London (which is arguably an exception to the temperate maritime climate zone). Thus ventilation strategies are climatically appropriate and comparable, responding too, to similar local building regulations and regulatory bodies. Each building was completed in the last twenty years and has also been operational for at least a decade. The case studies, therefore, have had the time to go through periods of calibration and recalibration of their ventilation strategies and operational systems. They have had some level of post occupancy study (see individual case studies) undertaken which may have led to the recalibration of systems or the confirmation of design intent predictions.

The selected case study buildings each are used by the public and demonstrate a variety of ventilation demands and a range of different strategy responses. Through studying these three buildings in the context of other naturally ventilated examples, we can assess appropriate strategy responses for generic building ventilation loads and through this understand the appropriate architectural response. The building typologies were selected to represent differing occupancy loads; the occupation density of the buildings determines the ventilation load that is required both for thermal comfort and for good IAQ. These typologies present differing

ventilation requirements: firstly offices, a typology with a relatively low ventilation load from occupation levels of an average of one workspace per 10.9sqm (British Council for Offices 2013); secondly, auditoria with conversely a high ventilation load from occupation levels of circa 1sqm per person; and thirdly a library with a medium ventilation load and occupation levels of circa 3sqm per person and a deep plan spatial layout (both figures from the Metric Handbook 2002).

In addition to the different typologies each building type exhibits a different architectural response to its ventilation strategy: the Auditorium is vented through thermal buoyancy and extract stacks; the Office building utilises a combination of cross ventilation and thermal buoyancy; the Library uses stack ventilation in a deep plan building - an Advanced Natural Ventilation (ANV) strategy.

3.3 Methodology

The Case study typically is used to research a topic using set procedures, often with different combinations of data collection. This form uses triangulation techniques gathering three sources of varied evidence. The advantage of this form of research is that it allows the researcher to evaluate three different sources of information to test a particular concept on the basis that a consensus on findings will yield more robust results (Proverbs D., Gameson R. 2008). This form of research uses mixed mode (quantitative and qualitative data) comprising of a combination of research techniques including interviews, reviews of documents and observations where the intention is to achieve a convergence of findings.

The methodology for the case study research involves the gathering of basic building data as part of desk top research study based on a framework developed by CIBSE and Hegger M. et al (2008) and modified to suit the relevance of the three case study buildings:

- Site data – location, urban/rural/ suburban
- Human Data – client, use, design team.
- Climate data – cooling days, diurnal range, prevalent wind directions
- Building data – plan, section, shape, surface to volume, size, structure, thermal mass
- Envelope data –glazing levels, solar shading.
- Ventilation data – strategy, type, inlet outlet design
- Operational Control system utilised

Firstly, the ventilation issue is defined for each building type and case studies are initially referenced against energy bench marks of standard air-conditioned building and natural ventilation equivalents, against thermal comfort benchmarks and against internal air quality (IAQ) bench marked data. Utilising available data an assessment is made under the headings of Energy use, IAQ and Thermal Comfort. A schematic is drawn of how the ventilation system functions in the differing modes.

Secondly, field research was conducted with visits to the Case Study buildings. These were used to investigate issues of detail in the above data against the four qualifiers of Energy use, Thermal Comfort provision, Internal Air Quality and Ease of Operation. The latter in particular relied on interviews with the building facilities

managers to discuss the building's performance. A follow up questionnaire, designed for the building managers, was used to pick up or clarify any outstanding issues. These qualitative interviews (Haigh R. 2008) were used as an open ended exchange focused on a particular topic using both structured and unstructured techniques. The interview was guided by a specific set of themes and questions which were utilised as the basis for each case study. These themes and questions centred on the direct experience of the building facilities manager with the operation of the ventilation system in providing comfort and good internal air quality. Their usefulness was partly for validation of the case study literature review but more significantly in providing an insider's guide to the daily and seasonal issues surrounding the management of the internal environment of the building.

Thirdly, in order to define the architectural vocabulary of ventilation for each of the three building types, research was undertaken into the design strategies of the architects involved. This research was through a review of publications of the architect's work; including a recently published series of essays authored by one of the architects. In addition an interview was conducted with the other of the two architects; this also used structured and unstructured techniques.

The literature review assisted in establishing an inventory of the architecture of natural ventilation and corroboration for findings from the case studies has been sought through the examination of published buildings that relate closely to the chosen case study themes. Conclusions are then drawn in regard to how architectural design in both form and details were combined to achieve the required performance

levels - defined by the categories of Energy, IAQ and Thermal comfort and ease of Operation.

Building type:	Auditorium	Library	Offices
Occupant density:	1 sqm per person	3 sqm per person	10.9 sqm per person
Ventilation load:	high	medium	low
Spatial challenge:	Single enclosed volume	Deep plan layout	Shallow plan with atrium
Case study building:	Contact Theatre, Manchester, UK	Lanchester Library, Coventry University, UK	Limerick County Council Offices, Ireland
Environmental challenges:	High thermal load, humidity and odour combined with sensitive acoustic environment	Deep plan building, Use of thermal buoyancy from internal occupant loads	Passive solar gain, internal occupant loads, seasonal changes
Basis of vocabulary of ventilation:	Wind towers, attenuation, thermal mass, plenum	ANV utilising plenum intake and light wells with perimeter stack extract	Shallow plan offices, atrium, solar shading exposed thermal mass

Table 5: Case study selection criteria

4.0 Chapter 4 Case Studies

4.1 Case study 1: Limerick County Council Offices

4.1.1 **Context.** Research in the 1990s led CIBSE to report that the avoidance of mechanical ventilation and air conditioning in office buildings – and thus a reliance on natural ventilation strategies - can lead to lower running costs, lower construction costs and to higher occupant satisfaction. CIBSE went on to record that construction costs are on average 10 – 15% less for naturally ventilated office buildings than their air conditioned equivalents (in contrast to theatre buildings as will be shown in Case Study Two). Positive feedback on naturally ventilated buildings also came from the PROBE (Post Occupancy Review of Building Engineering) reports authored by William Bordass Associates (WBA), notably PROBE 2 studies 1997 to 2000 which reviewed, in particular, a variety of office buildings with mixed mode, air conditioning and natural ventilation.

It was in this context that Bucholz McEvoy won the competition for the design of Fingal County Council Offices – completed in 2000 – as a single-sided atrium assisted cross ventilation strategy. Following this achievement they went on to win the contract for the design of Limerick County Council Offices with a similar natural ventilation strategy.



Figure 52: south west façade showing brise-soleil to the atrium



Figure 53: north east façade showing air intakes incorporated into the glazing system

4.1.2 Metrics

Limerick County Council Offices

The civic office element of the building is fully naturally ventilated with cross ventilation of the office spaces driven by the thermal buoyancy of the atrium.

Site data: location, urban/rural,

Dooradoyle, Co. Limerick, Limerick City suburban site, open surrounding space



Figure 54: Limerick County Council Offices site plan

Site data: Latitude/Longitude:

52.6680° N, 8.6305° W

Climate data: cooling days, diurnal range.

Limerick's climate is classified as temperate oceanic (KöppenCfb).

(Cooling degree days are a measure of how much (in degrees), and for how long (in days), the outside air temperature was above a certain level. They are used to calculate the energy required to cool buildings.)

Limerick has a mild climate, with the average daily maximum in July of 19.8 °C and the average daily minimum in January of 3.2 °C. The highest temperature recorded was 30.6 °C, and the lowest –11.4 °C (*Met Éireann Shannon data*)
Cooling days approximately 5 days per annum (*Met office*)

Human Data: client, use/ brief,	<p>Limerick County Council Office accommodation.</p> <p>The project brief was to design a new headquarters to accommodate and enhance the public services offered by the council and to provide office space for 260 employees.</p>
Human data: design team.	<p>Architects: <i>Bucholz-McEvoy Architects</i></p> <p>Building Services Engineers: <i>BuroHappold Engineers</i></p> <p>Structural Engineers: <i>Michael Punch & Partners</i></p> <p>Quantity Surveyors: <i>Boyd & Creed</i></p> <p>Fire Engineering: <i>FEDRA BuroHappold UK</i></p> <p>Main Contractor: <i>John Sisk and Son Ltd.</i></p> <p>Luminaire Design: <i>BDP Lighting with Bucholz McEvoy</i></p>
Environmental design tools:	<p>Thermal Analysis Software (TAS) provided a dynamic computer simulation of the building environment, establishing the energy targets for summer and winter conditions. (TAS was used to investigate the influence that solar gains would have on internal temperatures. Early morning sun, streaming in through the office elevation, was found to have sufficient intensity to cancel out the effects of the previous night's cooling strategy. This observation led to the specification of solar control glass with a 60% shading coefficient.)</p> <p>The Brise Soleil, required to shade the atrium's glazed façade, was modelled, to investigate the effectiveness of different louver configurations. This study produced a set of recommendations to determine its final design. Instead of adopting a conventional louvered configuration, RFR, the façade engineers, created a saw-toothed form, to intercept both midday and evening solar gains whilst allowing low angled morning sun in. (Ryan C.P. 2005)</p>



Figure 55: detail of timber brise-soleil to atrium facade

Occupation date	2003
Building data: plan, section, shape, surface to volume, size,	<p>The main five-storey block provides 7,100 sqm of floor area within a 12.7m deep floor plate. The building is c 75m long and the floor to ceiling height is 3.2 high. The southwest elevation is dominated by a large common atrium into which the top four levels of office accommodation open. A smaller three storey block intersects the main building's southwest façade and houses the council chamber and public viewing gallery, a restaurant with kitchen and public entrance.</p>
Building data: structure, thermal mass distribution	<p>The building is composed of predominantly pre-cast elements, including a post and beam structural frame, concrete floor slabs and heavy internal partitions. Vaulted concrete soffits are provided in all the office areas. These six metre long slabs were cast in fibre glass moulds allowing an exposed high quality surface finish to be achieved for the benefit of utilizing the thermal mass.</p>



Figure 56: interior of office space; w.c.s to right, atrium to left

4.1.3 Natural ventilation strategy. The building is strategically split into zones, with the functional requirements of each zone dictating the environmental control strategy used. Passive ventilation is employed in the offices; mechanical extract ventilation is used in the kitchens and toilets, while comfort cooling has been provided in the Council Chamber. (The Council Chamber is the only space with a mechanical supply and extract system. A CO₂ sensor reduces the volumes of air moved when the Council Chamber is unoccupied or only partially occupied, reducing energy consumption. In winter, a heat exchanger recovers heat from extracted air to further improve energy efficiency).

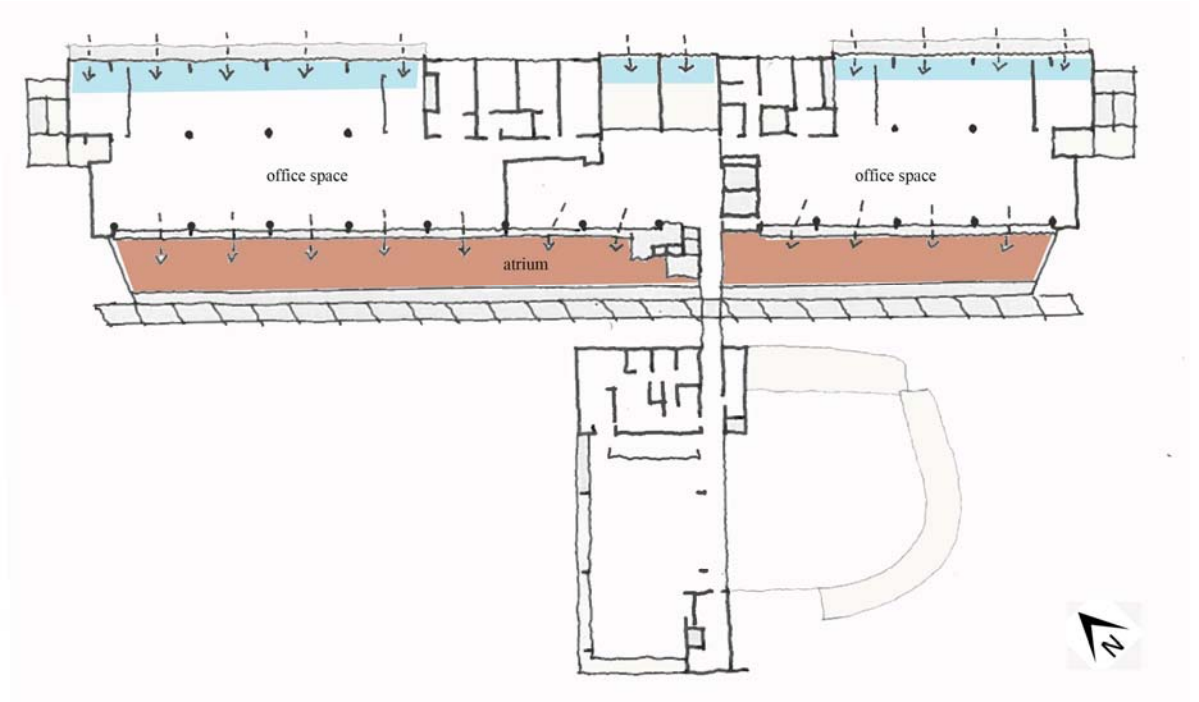


Figure 57: schematic plan of Limerick County Council Offices showing ventilation routes

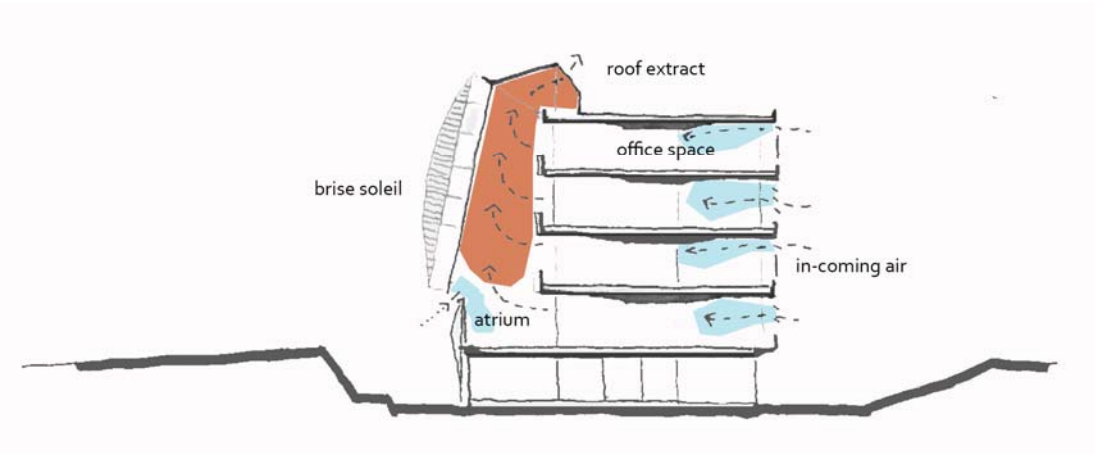


Figure 58: schematic section of Limerick County Council Offices showing ventilation routes

The form of the Limerick County Hall has been developed to support a passive ventilation strategy. Orientated to face directly into the prevailing south-westerly winds, the building's shallow floor plate supports a cross ventilation strategy. On warm windless days the four story atrium generates air movement via the stack effect, drawing air through the offices before expelling it through high level vents.

The sizing of the ventilation openings is based on the minimum required free areas for the atrium; these were identified through thermal analysis, as 15m² of louvers at low level and 33m² of louvers at high level. These are in addition to the air vents incorporated in the north east façade glazing system. In summer, automatic openings in the atrium combine with manual and automatic openings in the offices to ventilate the main building and offset heat gain. During winter, trickle ventilation provides fresh air to the atrium. Its external solar shading reduces the unwanted solar gain and minimizes glare. (Ryan C.P. 2005)



Figure 59: north west end to atrium



Figure 60: south east end to atrium



Figure 61: internal view of atrium showing manually operated glare control blinds on the right



Figure 62: internal view of atrium with stair

The construction and layout of the building is designed to facilitate night time cooling. During summer nights, automatic windows controlled through the BEMS, open to pre-cool the exposed building's thermal mass using the lower night temperatures. This 'free' cooling reduces peak internal temperatures, with the exposed mass of the ceiling structure encouraging air to move across its surface and maximise energy transfer. Night cooling is initiated based on feedback from temperature sensors located throughout the building. Each zone is provided with at least two averaging air temperature sensors and one slab temperature sensor. (Ryan C.P. 2005)

4.1.4 Qualifiers

Energy

Bench mark data:

- The energy consumption benchmark is that specified by DETR, Energy Consumption Guide 19, 'Energy Use in Offices' (2000) A naturally ventilated, open plan building would typically have a performance of 236 kWh/sqm/yr. (BER: D1)
- A naturally ventilated, open plan building good practice would have a performance of 130kWh/sqm/yr. (BER: B3)

Design	Performance
The target energy performance for this building was 76.4kWh/sqm/yr. (BER: B1)	Initially performing at BER: D2 but on-going operational modifications has resulted in BER: B3 (125kWh/sqm/yr) with resultant benefits of halving the gas consumption and a 20% reduction in electricity consumption. (Power P. 2015). Although this puts the building in the energy bracket of <i>good practice</i> this is still some way off the energy target. It is unlikely at this point that major improvements can be made but it is understood that further fine tuning adjustments of operation are continuing.

Thermal Comfort

Bench mark data:

- CIBSE 2002 overheating criterion less than 5 % of occupied hours over 25 °C
- CIBSE 2005/06 criterion that less than 1 % of occupied hours should exceed 28 °C.

Design	Performance
<p>The building is designed to follow both CIBSE criteria</p> <p>Air velocities within the building are to be maintained below 0.8m/s.</p>	<p>Temperatures and air velocities are maintained within design parameters (Petrie G et al 2012):</p> <p>CIBSE (2002) criteria of not exceeding 5 % of occupied hours over 25 °C and CIBSE (2005/2006) 1 % of occupied hours not exceeding 28 °C are met.</p>

IAQ

Bench mark data:

- For a 'standard' room occupation a rate of 8 l/s fresh air per person would mean that the levels would rise 600 ppm CO₂ which, when added to the normal outdoor CO₂ of 400 ppm, gives an internal CO₂ concentration of 1000 ppm – this is unlikely to provide any discomfort. (CIBSE Journal Module 27)

Design	Performance
<p>CO₂ concentrations would be expected to remain within the levels recommended for office buildings (1000 ppm) since the BEMS constantly monitors CO₂ concentrations in the building and adjusts fresh air provision using a set point of 1000 ppm</p>	<p>CO₂ concentrations are maintained at or below 1000ppm (Petrie G et al 2012)</p>

Ease of operation

key benchmarks

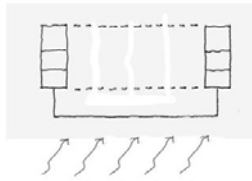
- Robustness – reduction in number of components – designed simplicity
- Occupant control – territorial and intuitive, well placed
- Ease of maintenance
- Response to both internal and external conditions
- Security

Design	Performance
<p>Air enters and leaves the building through approximately 90 mechanically actuated windows and vents. These windows operate under the control of the BEMS, but they are also equipped with a manual override facility. When wind or rain precludes the opening of windows, a mechanical extract fan, located in the atrium roof, draws air through the offices from louvered ventilators located in the building's north east façade.</p> <p>In addition, the external conditions are assessed using a roof top weather station, which collects temperature, wind speed, wind direction and rainfall.</p> <p>Occupant control consists of local operating of trickle vents, windows, blinds and radiators.</p>	<p>BEMS has been modified over time to fine tune the building towards greater efficiency in energy operation – see below.</p> <p>Note too that a manual override is used in the operation of the BEMS in the opening of actuator-driven windows and vents; these are located in the office spaces.</p> <p>Manually operated blinds have subsequently been installed between the atrium and the office spaces for localised glare control.</p>

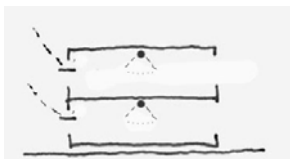


Figure 63: BEMS user interface – monitoring temperature internally and externally, wind direction and speed, ventilation openings.

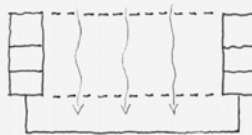
4.1.5 **Design issues.** Limerick County Council Offices is an atrium assisted cross-ventilation system relying on wind pressure differential and internal heat gains. The building sits in a sub-urban environment and benefits from clear, relatively unobstructed wind paths. It uses the standard architectural lexicon of natural ventilation for offices, including:



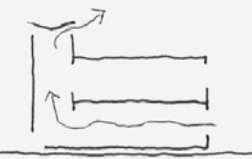
1. clear ventilation paths as part of the site strategy. Generally open plan but cellular offices with solid partitions at right angles to perimeter walls partitions to allow flow of air.



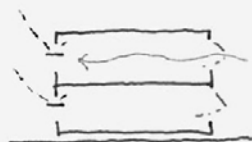
2. heat load reduction strategies both internally and externally against excessive solar gains



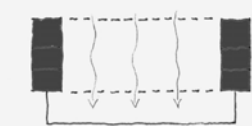
3. thorough planning of the internal ventilation flow path for all seasons. A narrow floor plan to encourage cross ventilation, (c. 12m). *Note the plan of the Limerick County Hall inhibits ventilation paths through the position of services in the middle of the plan*



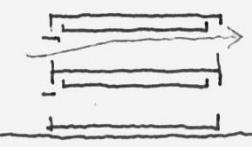
4. high floor to ceiling height (c 3m) in order to increase day light penetration and allow space for stratification of hot air to collect above the occupant zone



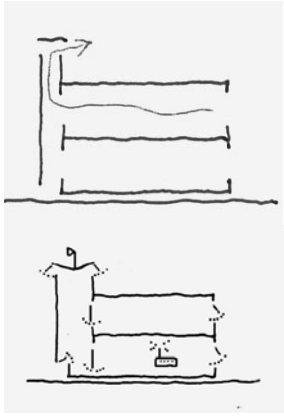
5. day-lighting with occupant control of glare and operational windows. Possible use of glass light shelves to shade perimeter offices but allow daylight into deeper plan. *Note: Limerick County Hall relies on an external brise soleil –see below*



6. careful positioning of service centres for possible separate venting systems. *Note see above regarding position of services*



7. exposed concrete soffits for thermal mass – sinusoidal to increase surface area and to assist with acoustics; coupled with the above, a raised access floor for cabling services to enable flexibility



8. thermal buoyancy cross ventilation assistance provided through towers, stacks or atriums.
9. BEMS for lighting, heating, ventilation, but with occupant override control. *Note see operational issues below*

Figure 64: Natural ventilation elements of Limerick County Council Offices

Where it diverges from a simple atrium assisted cross-ventilation design is in the orientation of the building which positions the atrium towards the south west. This decision is in part driven by the desire for a figurative transparency of local government – as per Fingal County Hall – and the creation of a front window for the building. That said it is acknowledged both by the architect and in the post occupancy evaluation that the atrium plays an important part in a passive solar design role in providing warmth to help drive the natural ventilation, particularly in winter.

“The use of passive solar energy during the later morning and afternoon to warm the air in the atrium and provide a free source of heat energy in winter formed a key component of the energy savings realised in Limerick County Hall.” (Petrie G. 2012)

The south west orientated glazing demands a complex (and spectacular) external brise-soleil in order to prevent overheating in summer. This brings with it issues of cost, maintenance and cleaning. The service life of the brise-soleil should be 40-50 years but this largely depends on the ability of the timber to dry out and not trap moisture at the connections. Furthermore, the brise-soleil has very noticeably become the perch for a large flock of starlings. Although starling murmuration is an

added joy to the building and its setting, it has left the glazing with a cleaning issue which is not easily addressed – abseiling down the glass façade is the only way to keep the external glazed atrium clean – a necessary operational cost.

The atrium faces into the predominant wind direction but the incoming ventilating air is largely through the opposite north east façade. It does not appear that this is a problem in terms of the functioning of the natural ventilation and the wind direction is utilised more for negative pressure on extraction from the atrium at high level, thus improving the pull of air through the building.



Figure 65: atrium showing light weight shutters to offices for light control



Figure 66: atrium showing actuator-driven louvre to base of glazing

Atriums typically are used within deeper plan buildings where they help provide a communal space, day light and collect the warmed air to help drive the cross-ventilation through the adjacent office spaces. Subsumed within the building, the design of the external glass envelope is principally about the roof where solar control both for heating and glare is required. Bucholz-McEvoy's later SAP building in Galway (2005, figure 70) uses the atrium in this manner venting out at the top to both east and west sides depending on wind direction and thus provides a more economical design but equally lacks the transparency and the elegance provided by the single sided atrium of Limerick.

The external access to the atrium is through sliding doors which was a cost saving prior to construction. Even with the draught lobby this design still lets draughts in and this cools the building unnecessarily requiring additional winter heating. Revolving doors – as per the original design - would have functioned more efficiently through draught reduction.

4.1.6 **Operational Issues**

“Dooradoyle has less in-built tolerance as a naturally ventilated building than subsequent designs” (Bucholz M. 2017)

Interviews with both the current operations manager – Pauric Power – and the architect – Merrit Bucholz – confirmed the need for a dedicated evolution of the controls of the natural ventilation system. One of the immediate issues was that the atrium did not function as predicted: solar overheating in the atrium in winter meant that the controls attempted to evacuate warm air in the top half of the space and

thereby opened both top and bottom vents, allowing cold air to surge into the ground floor as a result. This prompted the heating to turn on to counteract the drop in temperature. Mr Power rightly recognised that the decoupling of the top and bottom vents meant that the top vents could evacuate without needing a cold air supply at the base – the necessary cooling of the space was achieved from above only and no additional heating was required.

A further example of the systems evolution, and with that a reduction in the energy demand of the building, was in respect to the office lighting. Artificial light levels are dropped in summer to give a sense of coolness which has been shown to be effective in reducing the ventilation requirement for desired cooling. Tuning the lighting control system to the available daylight wherever possible has minimised the use of artificial lighting. Petrie G. (2012) reports that over the two year period of the post occupancy study, a 30% saving in annual electrical cost compared with the first year of operation, was achieved in this manner.



Figure 67: office internal elevation showing light shelves and ventilation shutter and opening window

Another operational issue is the need for a quick response and BEMS override for interactive management; this is due to the changeability of weather patterns in the west of Ireland. It took a dedicated operations manager to work with the BEMS and operations system to fine tune a building which had little in-built tolerance; more so considering the potential diurnal range of insolation, temperature and wind (Buchholz M., 2017). Petrie again reports that a concerted collaborative effort on the part of the facilities manager and the post occupancy research team have realised savings of approximately 40% of annual energy use in Limerick County Hall compared with the first year of operation. This has brought the building's energy performance back towards, but not meeting, the original design aspiration.



Figure 68: office showing exposed thermal mass of the ceiling slab



Figure 69: detail of manually operated shutter screen between office and atrium to control daylight levels.

4.1.7 **Natural Ventilation Design Development.** An issue that has evolved in the architectural practice Bucholz-McEvoy's design work since Limerick regards the use of thermal mass. It has been shown (Tuohy et al 2004) that the effective thickness of the thermal mass on a daily cycle in the temperate maritime climate is only up to 50mm. This has allowed Bucholz-McEvoy Architects to reduce the amount of concrete in the buildings and use more timber as structural decks thus reducing the embodied energy of the design and increasing the ability of the building to operate as a carbon sink. One of the first of their designs to explore this is the Ballyogan operations and maintenance depot (2013). This building follows on from the Woodland Trust HQ (FCB-Studios 2010) which uses precast concrete slabs integrated within the cross-laminated timber ceiling deck.



Figure 70: SAP Building, Galway – showing the internal atrium – (Bucholz-McEvoy Architects)



Figure 71: Westmeath County Council building – double skin façade to south elevation – (Bucholz-McEvoy Architects)

A further design lesson more specifically from Limerick is that naturally ventilated buildings need more tolerance in terms of operation (Bucholz M. 2017).

As highlighted above, it has taken some years to fine tune Limerick County Hall in order to operate it close to the original design goals. This fine-tuning is time and money consuming and benefitted considerably from the Post Occupancy research undertaken by SAUL (School of Architecture, University of Limerick). Westmeath County Council Offices from 2009 (Bucholz-McEvoy Architects, figure 71) has many of the successful attributes of Limerick, but, for both operational and contextual reasons it has eschewed the southerly orientation of the single-sided atrium for a northerly one. The southern façade however has more layers to it with a double skin that operates horizontally not vertically to suck air out in summer and pre warm in winter. These additional layers give greater operational tolerance to the building and it has required less fine-tuning as a result as (Bucholz M. 2017).

Other design developments can be seen in the aforementioned SAP building 2005 (figure 70) with central atrium; the external facades use fixed, closed windows - windows are heavy to move repeatedly and more prone to durability failures as a result (Bucholz M. 2017) and uses instead insulated light-weight panels to facilitate ventilation and which are easier to operate. It also utilises dispersed heat exchangers for a tempered fresh air inlet in the external facades. The utility of the passive, dispersed heat exchanger has yet to be fully analysed but should be the subject of future research particularly in terms of cost effectiveness.

The success of the naturally ventilated building depends as much on the client as on the design team and facilities manager: the client must want a climate responsive building and understand that the investment made is in facades and design – not in a piece of kit hidden in the basement or on the roof (Bucholz M. 2017).

4.2 Case Study 2: Auditoria: Contact Theatre, Manchester, UK

4.2.1 Context


“The theatre environment poses a challenge to the passive designer due to the high, intermittent occupancy and lighting loads, the sedentary nature of the occupants, stringent acoustic requirements, blackout conditions and the need to ensure satisfactory removal of heat, odours and carbon dioxide” (Jones P, 1997)

Alan Short, the architect of the rebuilt Contact Theatre and leading proponent of passive building strategies, questions what is his own reasoning behind “attempting to build a free running theatre”? He concurs with Jones’s opening remarks that the density of people and lights generate so much heat that the design of the Contact Theatre would require an “absurd increase in the number and size of punctures for air inlets and outlets” and further that “the form would probably disintegrate, what hope would there be of containing sound?” (Short A.2017)

Despite these musings, his motivations were, he describes, firstly about funding: arts buildings in the United kingdom in the 1990s were *capital rich but cash poor* (Short A. 2017). As a result the initial investment in design and building fabric which is necessitated by natural ventilation could be facilitated on the basis that the projected running costs would be low - a prime motivator in choosing natural ventilation strategies. A further, motivation was derived from his knowledge of theatre and he quotes theatre directors, many of whom have a serious issue with air conditioning of theatres destroying the atmosphere of the auditorium. Finally, as an environmental response of low energy design from his experience, he notes how well suited natural ventilation is as a passive cooling system (Short A. 2017).



Figure 72: public entrance to the Contact Theatre, showing studio theatre stacks and behind the main theatre block with its dedicated zinc clad ventilation stacks.

<p>4.2.2 Metrics</p>	<p>Contact Theatre, Manchester</p> <p>A renovation of the main theatre space and the addition of a studio theatre both utilising thermal buoyancy natural ventilation</p>
<p>Site data: location, urban/rural,</p>	<p>South Manchester, urban/ suburban site, open surrounding space to south and east, courtyard to west</p>  <p>Figure 73: Contact theatre site plan</p>

Site data: Latitude/Longitude:	53.4808° N, 2.2426° W
Climate data: cooling days, diurnal range.	Manchester experiences a temperate maritime climate with the average daily maximum in July of 20.2 °C and the average daily minimum in December of 0.6 °C. The highest temperature recorded was 31.6 °C in 1995, and the lowest –11.4 °C in 2010. (<i>UK met office</i>). Cooling degree days approximately 5 days per annum. (<i>UK met office</i>)
Human Data: client, use/brief,	To improve the functionality of the existing theatre with rehearsal space, studio theatre and foyer. To make the theatre more visible in its context; to minimise the potential significant financial and operational costs of a large mechanical ventilation and cooling system.
Human data: design team.	Architects: Short Ford Associates Services consultant: Max Fordham LLP, Structural engineer: Modus Consulting Engineers Quantity surveyor: Dearle & Henderson.
Design tools:	Environmental design based on physical modelling and computer simulation
Occupation date:	Original Contact Theatre was built in 1963. Refurbishment work involved the existing 320 seat main theatre space, new foyer added, new rehearsal space and a new 80 seat flexible studio performance space to the side of the original brick masonry auditorium. Refurbishment completed 1999
Building data: plan, section, shape, surface to volume, size,	Main theatre space 30m x 17m wide; 5m high stacks Studio theatre space 12m x 12m x 6.5m high 600mm high plenum; 5m high stacks. Total useful floor area: 3753sqm
Building data: structure, thermal mass distribution	Original theatre space load-bearing masonry walls, light weight roof construction – new steel framed stacks were designed on the current lightweight roof of the main auditorium; plenum beneath seating of concrete thermal mass with block work divisions. Studio theatre – concrete and block work to give both acoustic mass and thermal mass (Originally there was to be a further mezzanine gallery in this space and access to an external theatre space on the roof). Foyer: - concrete, block and brick

4.2.3 Natural Ventilation Strategy

The design challenge with naturally ventilated theatres derives from their high, intermittent occupancy rate and thermal loads from lighting. In addition to this are the stringent acoustic requirements, blackout conditions and the need to ensure satisfactory removal of heat, odours and carbon dioxide.

In natural displacement ventilation layers of warm air at high level drive a flow of air out through high level openings. This draws in fresh air at low level. Large inlets and outlets are required; height too so that warm stale air is always above the breathing zone. Inlets and dampers must be carefully considered to prevent wind induced negative pressures at the inlet.

The ventilation design is based on a stack dominant system using an "H-Pot" chimney configuration to operate regardless of wind direction. The potential for conflicts between wind and buoyancy forces have been reduced through the location and positioning of inlets and through the sizing and design of the stack and H-pot chimney vents. (Cook M. & Short A., 2009)

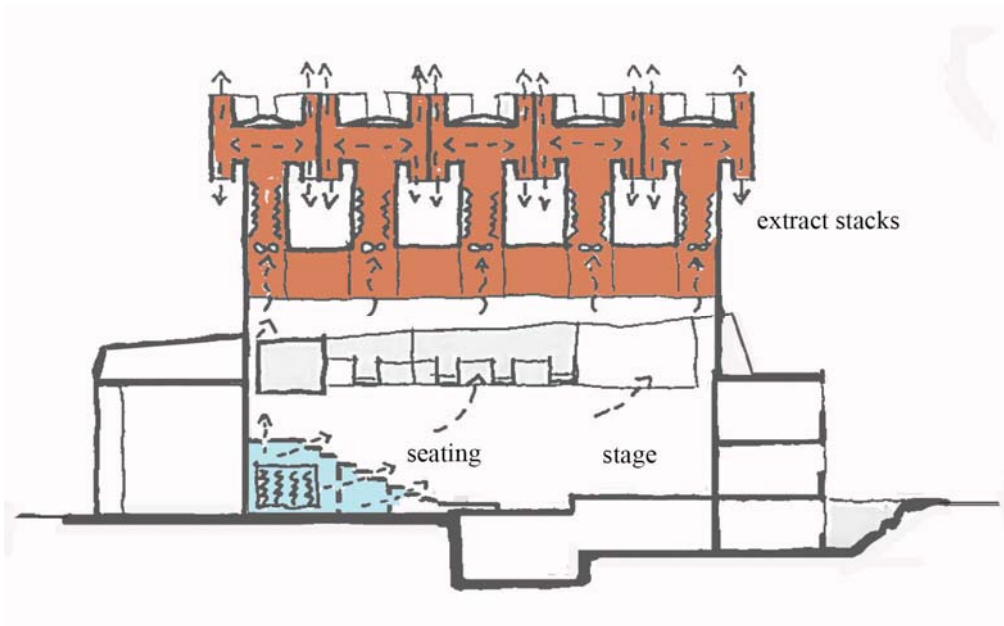


Figure 74: schematic long section through main theatre space showing thermal buoyancy air movement from the sub-seating distribution. Note position of fan in stack for ventilation assistance as required.

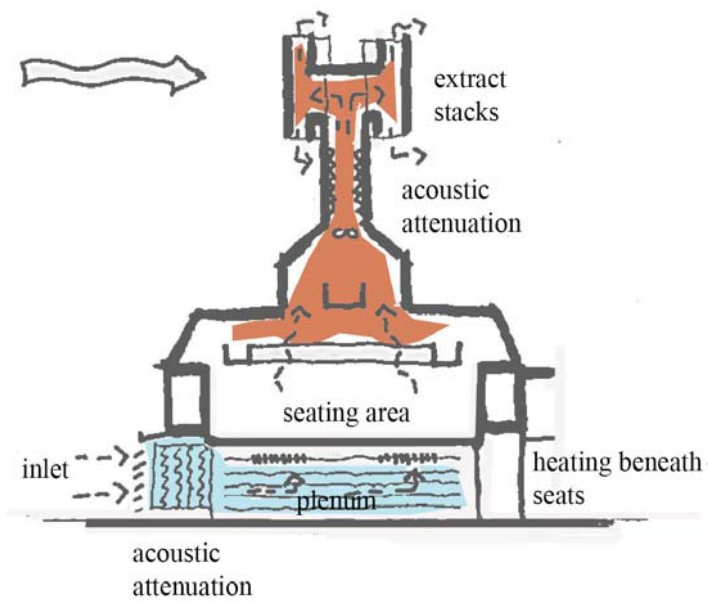


Figure 75: schematic cross section through the main theatre space showing air entering via acoustic attenuation to the sub-seating plenum and rising past heating elements into the auditorium.

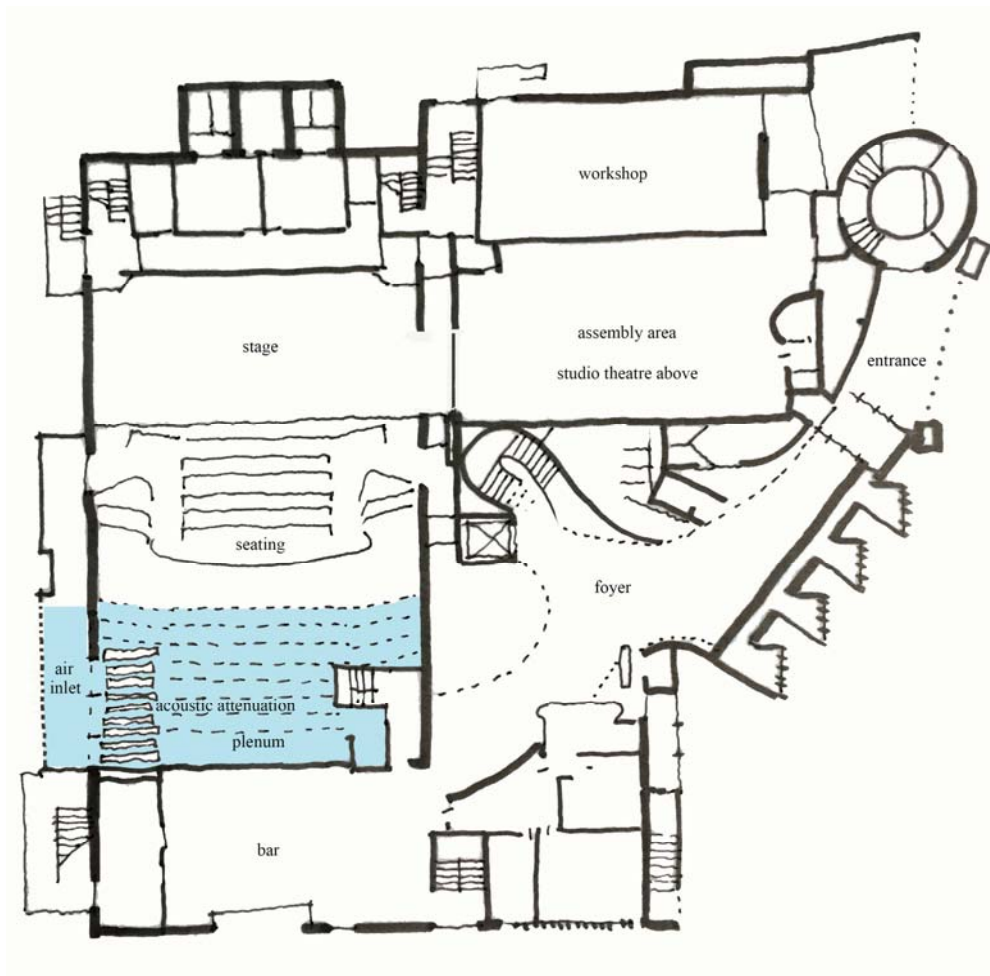


Figure 76: schematic ground floor plan showing the main theatre space and foyer and plenum below seating

Within the main auditorium air is introduced through a bank of acoustic splitters 2.4 metres in length into a plenum beneath the auditorium seating. The plenum is split in to four compartments, each individually controlled by dampers. Thermal mass inside this concrete labyrinth helps to cool peak summer conditions. A 90 degree turn in air flow direction helps reduce any risk of gusts through into the auditorium. Heating elements are hung beneath each seating platform to pre warm colder winter air as required. Air enters each seating row through continuous openings in risers with a free area of 20sqm or 3.2 % of gross floor area. Air is exhausted through a new 5m high chamber cut in the existing roof profile. Five

stacks each with 4sqm free area contain dampers and low speed fans. These stacks contain vertically mounted splitters to help minimise noise ingress from above. Stack terminations contain two integrated orthogonal H pots to minimise flow reversal and help generate negative pressure for all wind directions. Trays below each stack are used to catch any stray rain drops.



Figure 77: louvered air intake to main theatre space from courtyard



Figure 78: acoustic attenuation into main theatre looking towards external louvers



Figure 79: suspended heating elements and grills through seating to main auditorium



Figure 80: ventilation grills to rear of seating in the main auditorium



Figure 81: main auditorium space with lighting gantries and above them the ventilation stacks



Figure 82: main auditorium space from stage to seating



Figure 83: view from western courtyard with main theatre in foreground with zinc clad stacks and the brick stacks of the studio theatre beyond.

Within the Studio theatre air is introduced at 6 metres above street level into a 600mm high plenum. The plenum is constructed as a high thermal mass labyrinth with banks of acoustic splitters. Air enters the studio space on all four sides past heating elements. Air is exhausted via four vertical openings at soffit level connecting to an exhaust plenum above the perimeter corridor on all four sides. Four tapering splitter chambers connect to masonry stacks above terminating in H pots. Small fans are placed at the base of each stack above the attenuators. Air is extracted through the four H pots which do not always extract but sometimes depending on wind pressure blow in (Cook M. & Short A., 2009; Fitzgerald S., Woods A., 2007).



Figure 84: air intake for the foyer at ground level



Figure 85: ground floor of foyer



Figure 86: plenum beneath studio theatre space, heating elements below inlet grills in floor



Figure 87: studio theatre space, inlet grills in floor and outlet at top of walls



Figure 88: detail view of brick H-pots to studio theatre

4.2.4 Qualifiers

Energy

Bench mark data:

- *Typical energy use for theatre buildings:*
- heating 445kWh/sqm/year;
- electricity 179kWh/sqm/year (Display Energy Certificate)

Design	Performance
Target energy performance n/a	Display energy certificate 2014 – 16 Energy performance operational rating: B- 29 with 100 being typical for a theatre building (this scale is related to efficiency of energy use) 57% better than a standard equivalent building Annual energy use: heating 124kWh/sqm/year; electricity 54kWh/sqm/year

Thermal Comfort

Bench mark data:

- Recommended temperatures for auditoria (CIBSE)
- Winter (dry bulb) 22 – 23 deg C. clothing (clo) 1
- Summer (dry bulb) 24 – 25 deg C. clothing (clo) 0.65

Design	Performance
<p>Typically temperatures in auditoria ramp upwards over time which coincides with the occupants increased sensitivity to their surroundings – Kenton (2004) concludes that it is better to allow temperatures to be slightly cooler (18 – 19 deg C) than standard on arrival (individual metabolic rate higher at that time) and so increase at end of performance is still within comfort temperatures. Note too that the ergonomics of seating is a key factor in overall comfort in an auditorium.</p> <p>Internal temperatures comfort zone 18 to 23° C Air velocities within the building are to be maintained below 0.8m/s.</p>	<p>Thermal comfort of auditorium has “<i>never been an issue</i>” as the BEMS adjusts accordingly with temperatures within the comfort range (Curtis S. 2015). Temperature is monitored in both auditoria (at differing vertical positions) and ventilation paths respond to this - either fans are automatically switched on in order to assist air movement within the stacks and so help cool the auditorium; or heating coils are automatically switched on to warm incoming air beneath the seating.</p> <p>Internal temperatures remain in the comfort zone of 18 to 23deg C.</p> <p>The stage area however is effectively by-passed by the ventilation strategy of the auditorium and the associated heating of the auditorium. The area tends to be cool - more so now that halogen lights have been changed to LEDs – this is an important part of the internal heat load reduction strategy. (Curtis S. 2015)</p>

IAQ

Bench mark data:

- “*Comfort (odour) criteria with respect to human bio effluents are likely to be satisfied if the ventilation results in indoor CO₂ concentrations less than 700 ppm above the outdoor air concentration.*” This translates as c1100ppm.(ASHRAE standard 62.1 2016)
- Note that the Building Bulletin BB101 (2006) recommends as average maximum of 1500ppm for CO₂

Design	Performance
CO ₂ concentrations would be expected to	CO ₂ concentrations can rise to 1200ppm during

remain within the levels recommended (max of 1500 ppm) since the BEMS constantly monitors CO₂ concentrations in the building and adjusts fresh air provision accordingly with a minimum required air change rate of 5/hour

occupation of the auditorium (S Curtis 2015)

Ease of operation

Key benchmarks

- Robustness – reduction in number of components – designed simplicity
- Occupant control – territorial and intuitive, well placed
- Ease of maintenance
- Response to both internal and external conditions
- Security

Design	Performance
<p>The building is controlled by a Building Energy Management System (BEMS) which needs to understand the intermittent usage of the auditorium.</p> <p>In the main auditorium the BEMS operates dampers to balance the distribution of the air entering each section of the four chambered plenum; operates the heating through monitored temperatures; and the use of fans as required within the outlet shafts.</p> <p>In the Studio theatre: a wall-mounted dial allows staff to input the anticipated level of occupancy. Their predictions inform the BEMS, which makes a decision concerning the opening extent of the dampers in the inlet and outlet stacks.</p>	<p>Operational systems function largely as designed in terms of the BEMS following initial period of adjustments. The following issues were noted in interview with the operations manager Steve Curtis:</p> <p>Studio theatre: air enters from north side first floor grills past tightly packed acoustic attenuators passing heating elements into meter high plenum space beneath the studio theatre. None of which is easy to clean. However, maintenance and cleaning in particular is laborious and not well designed-in with a plethora of actuator driven openings and louvres. Cost cutting in the final build led to inadequate external extract louvre quality provision and thus some vermin ingress.</p>

An override to the foyer BEMS is designed with occupancy response button which opens or closes windows and louvres as desired. Note that the BEMS has a midnight close down button shutting all windows and louvres on basis that the building is then unoccupied for security reasons.

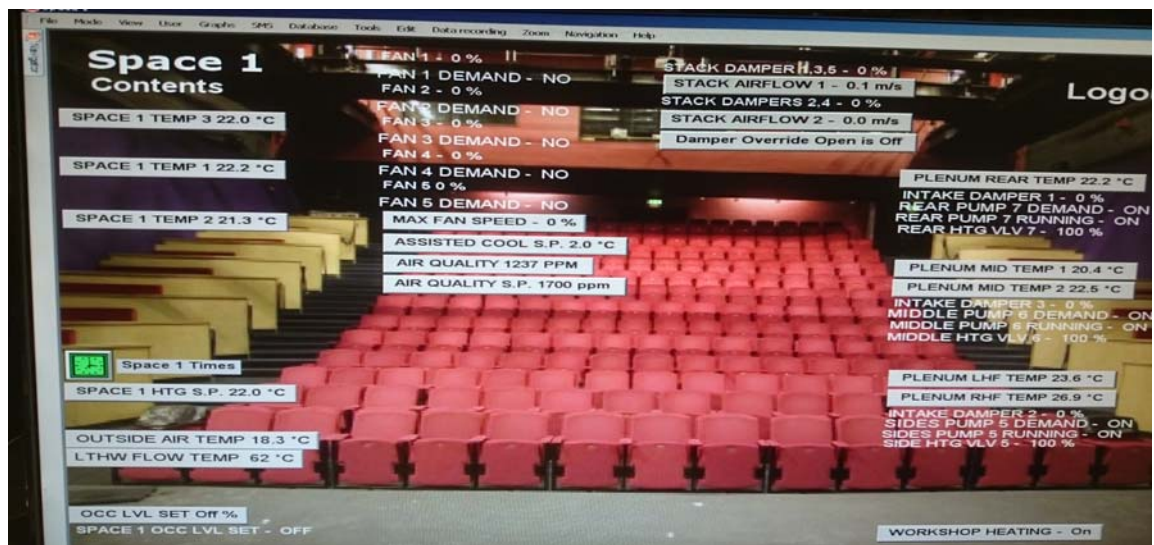
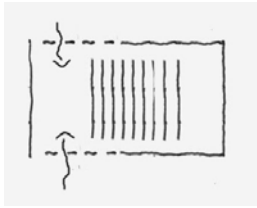
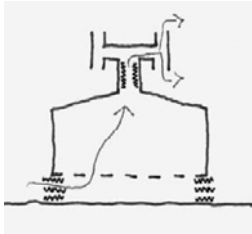


Figure 89: BEMS user interface – showing main theatre space – internal and external temperatures, fan response as required, airflow within stacks, temperatures in the plenum and requirement for heating.

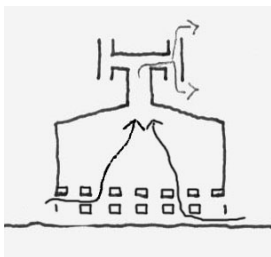
4.2.5 Design issues. The Contact Theatre was in many ways breaking new ground in the major refurbishment carried out by Alan Short and team: taking a poorly mechanically ventilated existing theatre building, extending it with new foyer, rehearsal room and studio theatre; then cutting into the existing fabric in order to bring air in and – with heightened architectural drama – let the warmed stale air out. As a theatre it does however work well in terms of our qualifiers and exhibits successfully some of the characteristics of a naturally ventilated auditorium.



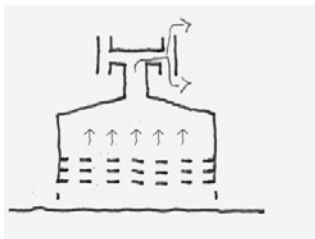
1. clear ventilation paths as part of the site strategy. *Note the Contact Theatre has compromised site ventilation routes*



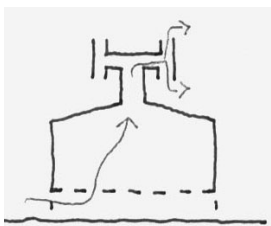
2. use of acoustic dampers to lower noise ingress at intake and extract



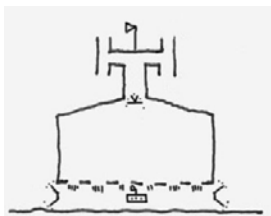
3. use of a plenum to balance out air flow across the auditoria with exposed thermal mass within the plenum and auditorium for summer temperature control



4. height of auditorium to allow space for stratification of hot air to collect above the occupant zone



5. extract stacks above auditoria to take advantage of thermal buoyancy



6. BEMS for lighting, heating, ventilation and external weather condition monitoring

Figure 90: Natural ventilation elements of the Contact Theatre

The Contact Theatre – like other low energy auditoria – relies on the design of the plenum in order to attenuate, distribute and warm in-coming air. This is in effect an undercroft set beneath the seating area, constructed out of heavy materials with exposed thermal mass in order to act as a heat sink. It is recommended to split the plenum into chambers – as in the Contact Theatre - to allow for a more balanced distribution of fresh air into the auditorium. Ideally this plenum is served by louvered inlets to opposing directions in order to facilitate wind pressure ventilation by avoiding localised negative pressures. The Contact Theatre is unable to do this as it is blocked by the foyer space –should this have been planned differently or does it indeed matter as the main auditorium ventilation appears to function well. The thermo-dynamic of the warmed rising air in the space draws the cooler fresh air through the plenum; thermal buoyancy driven ventilation solutions such as in auditoria are generally more robust and less complex than those relying on wind driven alone (Cook M. & Short A., 2009).

The Architect's response to the site was driven by the placement of the existing theatre building, the position of a large car park and the need for visibility from the main road. The design has endeavoured to make the best of this in terms of natural ventilation with the use of high inlets for the Studio theatre and the air inlet to the main theatre space is orientated out into a courtyard, at present a paved and planted space. There is a risk here however, in that future development of the courtyard could introduce a source of pollution and the main theatre auditorium then has few options beyond a redesign of the intake strategy. As a general rule we can assume that some control of the external space for sourcing clean air is important and in-built

flexibility to allow for contingency actions if required. Alternatively, the use of high level wind scoops could have been an option considering the stack driving force of the warmed air.



Figure 91: the pedestrian courtyard to the rear of main theatre showing louvered air intake beyond fire escape door

Cook and Short (2009) note that fly screens, grilles, dampers, acoustic attenuators and insulation will all reduce pressure along air inlet paths and that it is important to check that the total effective inlet area equates to what is required in design. Acoustic attenuation in particular reduces effective duct area by up to 50% - however, it is a necessary attribute particularly in an urban environment.

We can conclude that the plenum is critical to the architectural section of the naturally ventilated auditorium; it is however a place of restricted access, low head height and tightly packed acoustic attenuators. This space is not impossible to clean but it is not easy to do so and inevitably the incoming air brings with it dust and dirt. It does appear that one of the criticisms of ducted mechanical ventilation – that of the

potential for poorly maintained filters – could be levelled equally at the restricted design of the plenum in naturally ventilated buildings. However, there is little evidence as yet to show poor air quality in the theatre as a result.

The auditorium itself need not suffer the conflict between balanced acoustics and exposed thermal mass as this mass is largely effective in the plenum to temper the incoming air. The upward evolving heat issued by the audience and the lighting is an important part of the thermo-dynamic of the ventilation system. Again looking at the architectural section, height is important – keeping the pool of warmed stale air above the heads of the audience; Short A. notes (2017) that the required volume may be in excess of what makes for good acoustics, not apparently a conflict in the Contact Theatre but one which may be of future concern.

The exhaust stacks must have a free area that equates with the supply (Cook and Short 2009 report that the open area should be 3 -4 % of floor area of the space to be ventilated) and, like the inlets, require acoustic attenuation. Both the Contact Theatre's two auditoria and Bedales Theatre (see Literature review) have low speed fans within the stacks to assist in the event of summer stagnation temperatures. Curtis S. – the facilities manager – noted that in the Main Auditoria the fans are positioned below the acoustic attenuators which assists with ease of access but does give some acoustic disturbance when in operation; within the Contact Studio Theatre they are positioned in reverse and so present less of an acoustic issue but require dedicated access. It is also noted that the stacks ideally are constructed with thermal mass in order to retain heat or insulated if made of light weight construction – the

Contact Theatre design has both examples – insulated zinc-clad stacks to the Main theatre and thermally massive brick ducts to the Studio theatre.



Figure 92: brick stacks to studio theatre



Figure 93: insulated zinc-clad stacks to main theatre

In contrast to the Main Auditorium, the Contact Studio Theatre was wholly new build and not compromised in terms of air intake. Air is extracted from this space through four H pots which do not always extract but sometimes, depending on wind pressure, blow in. Woods and Fitzgerald (2007) in their POE showed that the Contact Studio Theatre is not fully operating in a displacement mode as cold air also drops down one of the stacks back into the studio space however this is sufficiently dilute in a 5m high space not to cause a problem for audiences. Originally there was to be a further mezzanine gallery in this space and access to an external theatre space

on the roof (Curtis S. 2017). This would have further helped to justify the perceived construction expense of the brick H pots.

The stack terminations must be resilient to wind direction changes so as to always have the benefit of a positive pressure gradient from intake level. The H pot at the Contact Theatre achieves this being of an omni-directional design; a higher stack gives better thermal draught but there is an inevitable trade off with issues such as cost and maintenance. These are critical architectural elements for natural ventilation and part of the rich vocabulary of European chimneys and middle-eastern wind towers. If there is a lesson to be learnt it is to provide ease of maintenance access, less critical for cleaning as the air is exhausted at these points but necessary to maintain the mesh for the prevention of vermin ingress.

4.2.6 **Operational issues.** Information on the operation of the theatre is from the post occupancy monitoring work of the Studio theatre space by Woods and Fitzgerald (2007) and Cook and Short's evaluation of lessons learned from the study of various naturally ventilated auditoria (2009). Critically too it is from a 'walk through' interview conducted with facilities manager Steve Curtis. Woods and Fitzgerald have pointed towards the need for good controls, high quality components (such as dampers) and a culture of understanding of the control strategy in the building occupants/ facilities managers. They note that the dampers need to be well sealed when closed and be able to be modulated for finer control. The BEMS is essential to balance air supply with extract.

This *culture of understanding*, as is the case with Limerick County Hall, is an important part of operational management. Steve Curtis is intimately involved in the running of the Theatre's environmental systems and it appears the building needs this level of attention. It is interesting to note that Ben Twist the artistic director of the Contact Theatre, who inherited the design, was not wholly convinced by the building. Short generously quotes him:

“ I really wonder, and I don't know how much extra these towers cost but I really wonder for half a million quid or whatever it probably was, whether you couldn't have got ...other environmental measures...that wouldn't provide the same or better savings – greater environmental and financial savings.... I think the ventilation system ended up driving the architecture and the engineering which ended up driving the project quite a lot...the cost got greater and so we had a limited budget. So we kept on having to cut down on studio and so on to accommodate what is basically a ventilation system so there's a bit of a danger that you've got a ventilation system with a theatre attached rather than a theatre with a ventilation system.” (p 192; 2017)

The critique is in part directed at the Studio Theatre, which, for its relatively small capacity (80 seats), requires a very similar architecture of natural ventilation as the larger main auditorium (320 seats). Bedales Theatre, with c 250 seats, certainly has a more refined single stack ventilation system. Would it have been possible to have refined the Studio Theatre ventilation system in a similar manner following the design removal of the mezzanine and the roof top theatre? The architect does not identify this in his subsequent account however, it is reasonable to assume that this possibility existed.

4.3 Case Study 3 Libraries: Lanchester Library, Coventry, UK

4.3.1 **Context.** The head librarian for Coventry University during the development of Lanchester Library was instrumental in establishing the brief for the building:

“We wanted to provide maximum flexibility for the future. We had seen plenty of examples where layouts and space use had changed significantly in comparatively short periods of time and wanted to be sure that we could accommodate such changes if they became necessary. Part of this dictated that we wanted a rectangular, preferably square building to make layouts and therefore legibility and navigation easy for customers” (Noon P. 2008)

Although there were, we are led to understand, some creative tensions between the design team and the client initially over the form that a sustainable building should take, Lomas notes that the ANV deep plan building has become a further design strategy for natural ventilation:

“The desire to maximise the use of urban sites, through the use of deep plan built forms, the imperative of sealed facades to reduce the ingress of urban noise and to ensure security, and the increases of internal heat gains due to computers and longer periods of occupancy are all seen as barriers to natural ventilation. It has been shown that these perceived barriers can be overcome by designing buildings which use the centre-in, edge-out, buoyancy-driven stack ventilation approach” (Lomas, Cook 2005).



Figure 94: main entrance elevation to Lanchester Library

4.3.2 Metrics

Lanchester Library, Coventry University

A deep plan flexible library space utilising thermal buoyancy as the natural ventilation driver

Site data: location, urban/rural,

Coventry UK, urban site, adjacent to ring road and built-up area



Figure 95: Lanchester library site plan

Site data: Latitude/Longitude:	52.4068° N, 1.5197° W
Climate data: cooling days, diurnal range.	Coventry experiences a maritime climate with cool summers and mild winters. Maximum average temperature 20.9 °C July; Minimum average temperature 0.2 °C January. Temperature extremes recorded in Coventry range from –18.2 °C in February 1947, to 35.1 °C in August 1990 Cooling degree days: 4.5 days Note weather data cooling days are increasing in number Birmingham has c 4.5 days with external temps of 27deg C or more but in 1960 2.7 days. (<i>UK met office</i>)
Human Data: client, use/ brief,	Central library for the University of Coventry, integrated learning resource centre: books, journals, media resources and electronic resources; PC provision, flexibility for future changes. To be a highly energy efficient building, but the site, and the desire for a simple, legible library layout, demand a deep plan form. Additional constraints were the close proximity of the site to main roads, resulting in high noise levels and pollutant concentrations.
Human data: design team.	Architects: Short and Associates Services consultant: Max Fordham LLP/ Environmental Design Partnership Structural engineer: Stephen Morley Engineers
Design tools:	Environmental design based on physical modelling and computer simulation included CFD simulations which were used to simulate conditions on the individual library floors and to determine suitable ventilation outlet opening sizes. Based on these simulations, it was predicted that, by appropriately sizing openings, uniform temperature distributions across each floor could be achieved. (Lomas K.J, Cook M. J., Short A 2009).
Occupation date:	Completed Sept 2000
Building data: plan, section, shape, surface to volume, size,	The floor area of the building is 9,103sqm Flexible floor space over 4 floors, a square foot print of 50m x 50m with a floor to ceiling height of 3.9m. No atrium, but daylight and ventilation are provided by five light

	<p>wells distributed evenly in a cruciform plan each light well being 42sqm (6.5 m x 6.5m), spread evenly through the plan so that no part of the floor space is more than 12m from an air inlet. This basic layout was used as a template, modified for each floor to facilitate specific uses</p>
Building data: envelope	<p>Solar gains are minimized by moveable translucent horizontal blinds at the head of the supply light wells, careful window placement and the use of overhangs and metal shading fins</p>
Building data: structure, thermal mass distribution	<p>Flat, exposed soffit precast concrete slab construction on steel frame</p>

4.3.3 **Natural Ventilation Strategy.** The natural ventilation design challenge was set by the desire for a deep plan building – usually only achievable with the use of an atrium – and the use of internal occupant thermal loads.

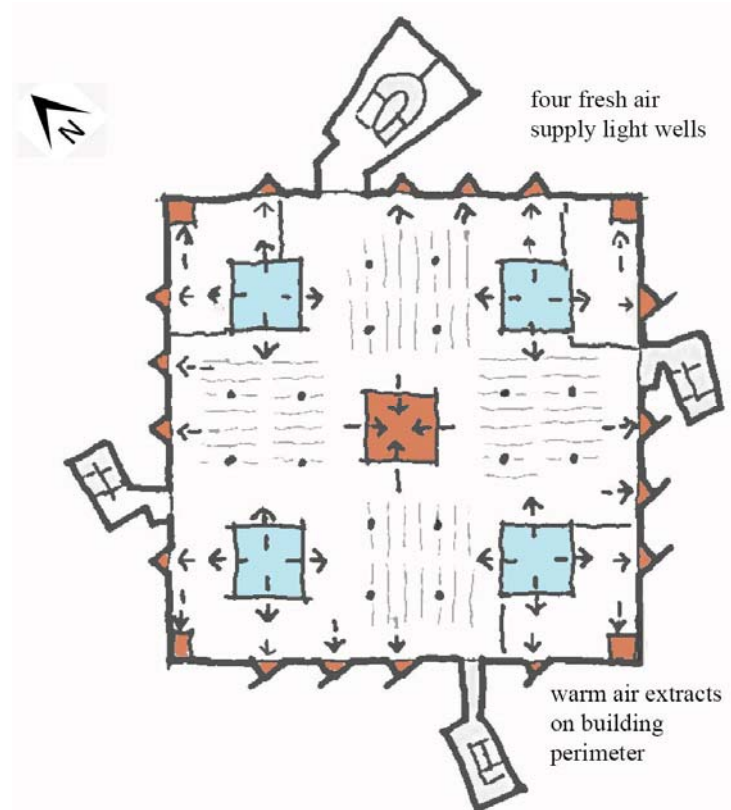


Figure 96: schematic ventilation plan of Lanchester Library

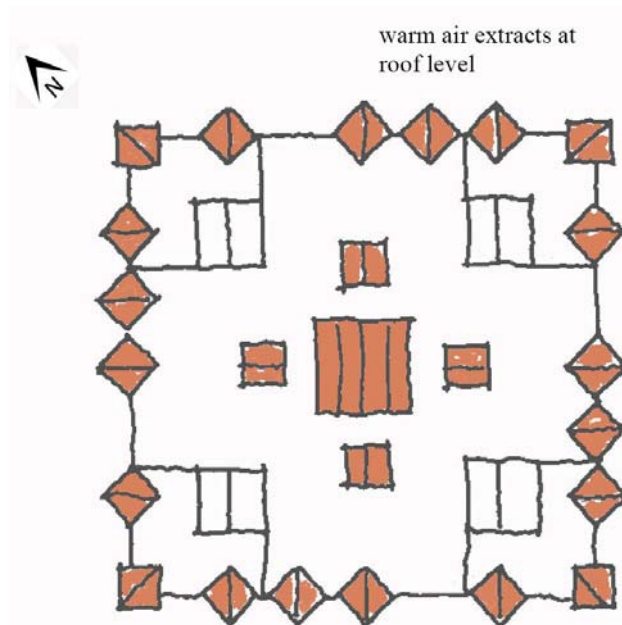


Figure 97: schematic roof plan of Lanchester Library

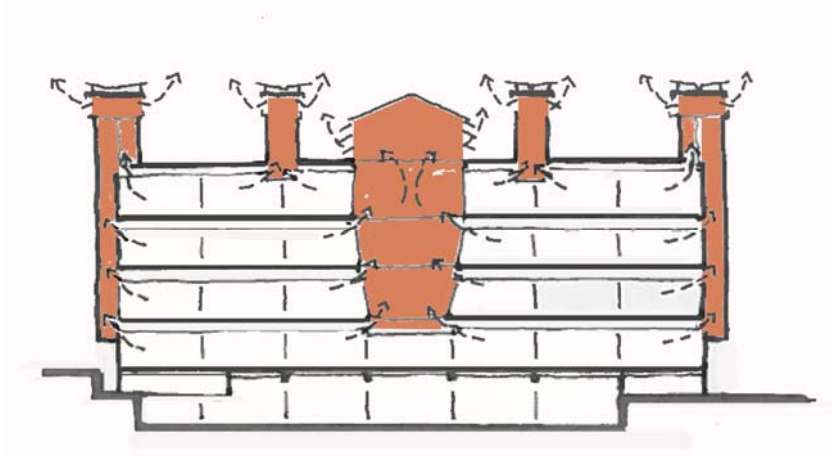


Figure 98: schematic section of Lanchester Library showing warm air extract

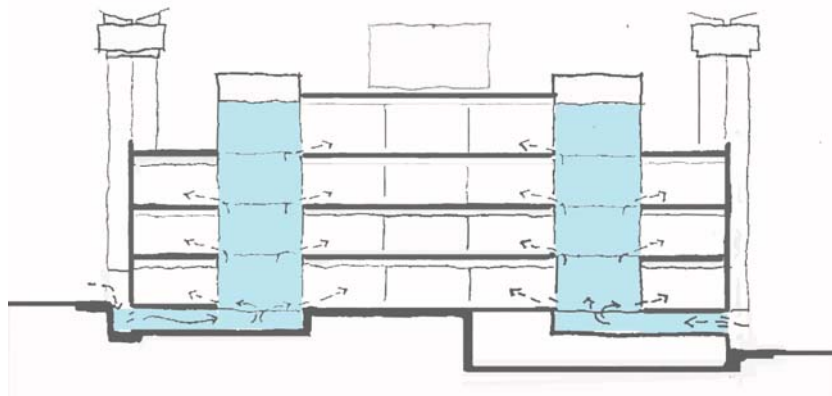


Figure 99: schematic section of Lanchester Library showing fresh air intake

The design and operation of the ventilation strategy utilises four 42sqm naturally ventilated light wells which receive fresh air from the plenum beneath and each then has air outlets into the library at floor level. Warm stale air is exhausted at five points on each façade of the perimeter up vertical stacks and also through a central light well.

Fresh air enters the building through a plenum between the ground floor and the basement, which serves the four light wells, one in each quadrant of the building. The air is warmed by the heat from occupants, computers, lighting, and heating (in winter). The buoyant air rises and accumulates in a layer below the 3.9 m high ceilings before flowing out across the flat ceiling through the 20 number, 1.8sqm perimeter ventilation stacks and the central light well, due to thermal buoyancy. The

metal construction on top of the extract towers is designed to deflect strong winds so that the stack effect of the air is always maintained. (Lomas K.J, Cook M. J. Short A. 2009).

Four additional dedicated stacks were added for the ventilation of the top floor in order to avoid the problem of back flow of exhaust air from the central light well into the top floor which was identified during the design process (Cook et al.1999). Night cooling when the building is closed is used in order to purge the warm air as required.



Figure 100: perimeter extract stacks



Figure 101: inlet vents at base of building



Figure 102: view of extract stacks at roof level – note blue clad stack is for top floor only



Figure 103: plenum beneath light well/ air ingress and fin heating radiators



Figure 104: light well/ air ingress from above showing louvers into library spaces



Figure 105: central light well/ air extract showing louvres at high level



Figure 106: main library floor showing wall extract vents at high level and flat ceilings with openings cut in the web of the steel beams so that airflow is not inhibited



Figure 107: top library floor showing ceiling extract vents

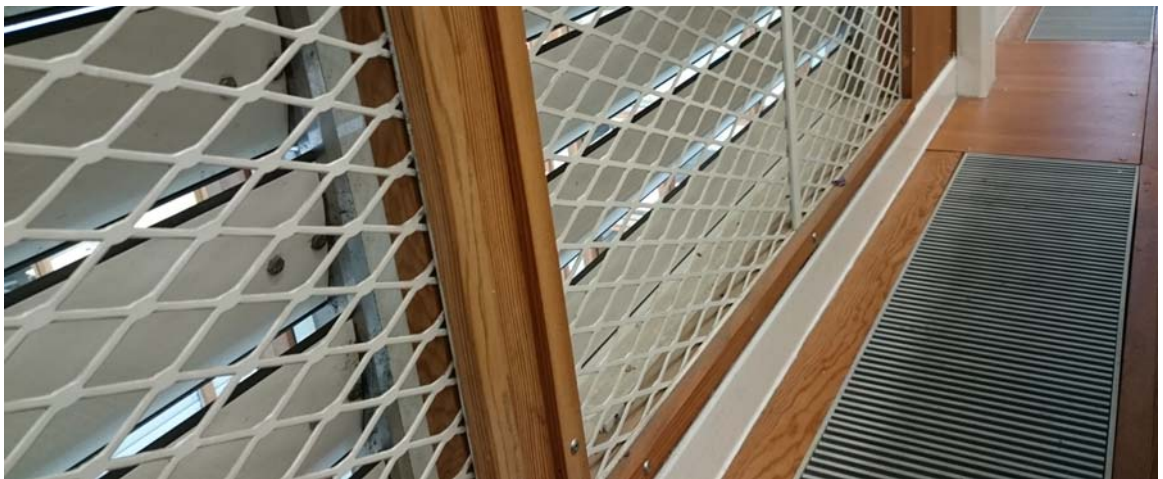


Figure 108: main library floor showing low level ingress vents and heating floor ducts adjacent



Figure 109: main library floor showing wall extract vents at high level

4.3.4 Qualifiers

Energy

Bench mark data:

Energy Consumption Guide 54, Libraries:

- fossil fuel usage (heating) **150kWh/sqm/year**;
- electricity 50kWh/sqm/year
-

Design	Performance
The target energy performance for this building was 0.055kWh/sqm/h	The library is accessible for approximately 4000 hours each year. However, with an annual energy consumption of 0.049kWh/sqm/h, the building performs better than the ECON54 guidelines. The building uses 51 % less energy than the typical air conditioned building and 35 % less than the typical naturally ventilated open plan building. (Krausse, B., Cook, M.J. Lomas, K.J., 2006).

Thermal Comfort

Bench mark data

- CIBSE 2005/2006 criterion: less than 1 % of occupied hours should exceed 28 °C.
- CIBSE 2002 over heating criterion (less than 5 % of occupied hours over 25 °C)
- Suggested air supply rate per person 8 l/s

Design	Performance
In winter the incoming air is warmed by pre-heating coils, which lie horizontally across the base of the 42.5 sqm supply light wells, and trench heating at the point where air enters onto each floor Cooling in the warm summer months is provided by passive methods. Night time venting is used to cool the exposed thermal	Data logged during the period June 2004 – June 2005 shows that the average temperature in the building remained relatively stable throughout the year. During the heating seasons the daytime indoor temperatures are dominated by the heating set points and the internal heat gains. The temperatures remained below 24°C during the daytime and decreased to approximately 21°C

mass of the building so that it can absorb heat during warm periods of the following day.

Constant air temperature 21 – 24deg C irrespective of ambient temperature.

Air velocities within the building are to be maintained below 0.8m/s. (Langmead M. 2016)

during the night, which is the minimum mid-week temperature set by the facilities managers. During the warmer periods of the year the internal temperatures are strongly influenced by those outside. However, because of the thermal mass and night venting strategy, individual hot days do not significantly raise the internal temperatures.

During the hot spell in August 2004 the ambient temperatures rose to over 30 °C. However, during this period, the night time ambient temperatures remained below 18 °C. There was therefore a passive night time cooling potential.

During the last 5 days of the hot spell the diurnal swing in internal temperature remained between 2 and 3 °C on all floors, with the ground floor, which benefits from the greatest height of ventilation stack, and thus the greatest buoyancy driving forces, having the greatest night-time temperature reductions. The third floor tended to be warmer than the second, which was warmer than the first. Considering the relative stack heights on each of these floors, and yet their similar occupancy characteristics, this should be expected.

The overheating statistics show that the temperature most frequently exceeded 25 °C on the third floor and the ground floor, whilst on the first floor temperatures remained below 25 °C throughout the entire monitoring period.

However, even on the third floor the CIBSE 2002 overheating criterion was met, with temperatures greater than 25 °C only occurring during 3.8 % of the hours of use. The internal temperatures never exceeded 27 °C, i.e. less than the number predicted at the design stage (11 hours)

(Krausse, B., Cook, M.J. Lomas, K.J., 2006).

IAQ

Bench mark data:

- For a 'standard' room occupation a rate of 8 l/s fresh air per person would mean that the levels would rise 600 ppm CO₂ which, when added to the normal outdoor CO₂ of 400 ppm, gives an internal CO₂ concentration of 1000 ppm – this is unlikely to provide any discomfort. (CIBSE Journal Module 27)

Design	Performance
<p>The library's performance in terms of indoor air quality was not predicted during the design phase. However, CO₂ concentrations would be expected to remain within the levels recommended for educational buildings (1000 ppm) since the BEMS constantly monitors CO₂ concentrations in the building and adjusts fresh air provision using a set point of 1000 ppm.</p>	<p>The BEMS air quality sensors log CO₂ concentrations at hourly intervals. Time series plots illustrate the different variability of the temperatures and CO₂ concentrations. Although both parameters are influenced by ventilation settings and occupancy levels, the CO₂ curves show distinct peaks, usually in the early afternoon, while the temperature curves rise throughout the day before decreasing sharply at night due to the night time venting strategy.</p> <p>The CO₂ concentrations for occupied periods during the six weeks investigated typically were between 400 and 500 ppm, with occasional peaks of up to around 700 ppm. The maximum CO₂ concentration recorded was 720 ppm, which is below the recommended limit of 1000 ppm (Krausse, B., Cook, M.J. Lomas, K.J., 2006).</p>

Ease of operation

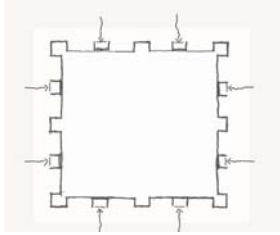
key benchmarks

- Robustness – reduction in number of components – designed simplicity
- Occupant control – territorial and intuitive, well placed
- Ease of maintenance
- Response to both internal and external conditions
- Security

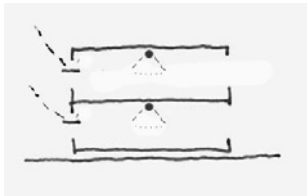
Design	Performance
<p>The building is controlled by a Building Energy Management System (BEMS) which operates dampers and windows depending on indoor and outdoor temperatures, wind speed and direction and CO₂ concentrations inside the library.</p> <p>Ventilation for night-time cooling is based on the BEMS's self-learning algorithm to 'predict' the likely (passive) cooling requirement for the next day. Over-cooling is prevented by monitoring slab temperature.</p> <p>Note that it is possible to isolate floors if some floors are not in use, the whole building approach effectively means cutting off ventilation to the closed areas. (Lomas K.J.2006)</p>	<p>Although incoming air is warmed to 12 – 15 ° C it can present quite a draught when entering the library space which can be perceived by students as unpleasant. Local heaters temper the air as required. Under floor heating is used for background heating as required.</p> <p>The building responds to CO₂ and temperature measurements set on walls and floors in c 3m x 3m bays. The BEMS is under centralised control. Note that the student occupants of the building are transitory and so it was not perceived as useful to give them local control. (Langmead M. 2016)</p> <p>The refinement of the BEMS is considered part of the improvement of the building. A year-long commissioning period is essential to cover unforeseen scenarios (Alan Short 2017).</p>

4.3.5 **Design Issues.** Short and Lomas reported in 2009 that the Lanchester Library broadly performs to its design intent following results from a two-year monitoring exercise undertaken by Krausse et al. (2006). Even during prolonged hot spells, which, in the period June 2004–June 2006, included outside air temperatures as high as 35.5° C, the internal temperature did not exceed 26.5° C. All floors of the building therefore met the prevailing CIBSE Guide A (2006) thermal comfort criterion: that there should be no more than 1% of occupied hours with a dry-resultant temperature above 28° C. The thermal comfort criteria – perhaps the toughest of the four qualifiers to meet in such a deep plan, load heavy design – have been satisfied.

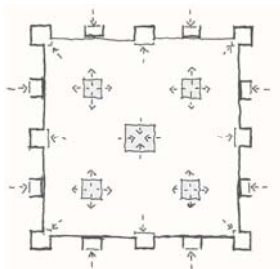
Like the auditorium ventilation design, ANV as used in Lanchester Library, relies on thermal buoyancy to drive the natural ventilation and becomes largely independent of wind pressure and this makes the performance of the building both more predictable at design stage and in use. Architecturally, the ventilation elements are not too dissimilar from the auditorium: a chambered plenum collecting the air – here from all four sides - air entering the occupied space pre heated – here, a potential two stage process – combined however, in the light wells, with the provision of daylight. As Lomas has pointed out, there are other variations of intake and extract within the menu of ANV but at Lanchester, the external envelope extract stacks are an important aspect of the animation of the façade as well as the roof line. Four additional dedicated stacks were added for the ventilation of the top floor in order to avoid the problem of backflow of exhaust air from the central light well into the top floor (as was identified during the design process with CFD analysis). This reinforces the notion that it is the top floors of naturally ventilated buildings that are the most susceptible to overheating but at the same time, with the opportunity to vent out through the roof, the issue is easily solved.



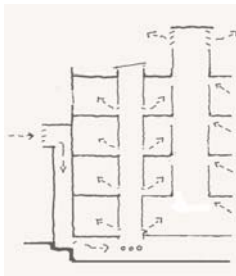
1. clear ventilation paths as part of the site strategy. *Note, ventilation paths are potentially compromised – see below*



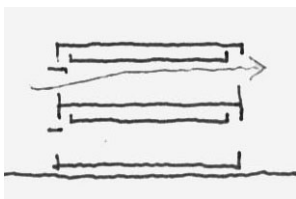
2. heat load reduction strategies both internally and externally against excessive solar gains



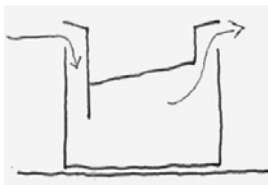
3. Thorough planning of the internal ventilation flow path. Light wells doubling up as ventilation ducts



4. incoming air use of a plenum to balance out air flow across the space; exposed thermal mass within the plenum for summer temperature control



5. Flat concrete ceilings used for both thermal mass and so as not to inhibit air flow



6. Intake scoops and extract stacks to take advantage of thermal buoyancy

Figure 110: Natural ventilation elements of Lanchester library

With reference to the design evolution of the ventilation stack design:

“ the necessary order of magnitude required to move such a huge air volume several times hourly obliges these elements to become architecturally charged objects” (Short A. 2017)



Figure 111: external view between perimeter extract towers showing metal stack terminations from below

Lanchester library stack outlets are a development of the stack terminations at Leicester Queen’s Building and the Contact Theatre; in particular, they are derived from a sketch drawn by Professor Tom Lawson of the aeronautical engineering department at Bristol University.

“They are composed of parallel racks of twin tubes off set half a module at each layer to catch the wind on any face and generate so much turbulence that all force was spent. Warmed air would continue to rise driven by relatively much smaller pressure differences and theoretically the potential for down-draughting is diffused.” (Short A. 2017; p 98).



Figure 112: detail view of multi-directional extract stacks

Here one sees in action the cross over between aeronautical engineering and architectural design. Furthermore, Lanchester Library has benefitted from wind tunnel testing of a detailed model at the Welsh School of Architecture to refine the ventilation strategy design. This showed some potential for reverse flow in the extract stacks on the north west façade in summer under particular wind conditions, although, no history of cold down draughts in the Library has been reported. Short Associates have also the research resource of working with the Centre for Built Form and Land Use Studies in the University of Cambridge where Alan Short has been Professor of Architecture since 2001. The Queens Building design had the benefit of dynamic thermal modelling under Professor Lomas at De Montfort and fluid flow mathematics from both Leicester De Montfort and the University of Cambridge. The continual collaboration with Professor Lomas is undoubtedly beneficial for the refinement of natural ventilation systems; and the link with, and assistance from, academic institutions permits a design rigour in calculations and simulations coordinated by Professor Short.

Fire compartment size proved to be a design stumbling block: the library is one single volume or compartment of 40000cubic metres with floor plates of 2230sqm. Part B TGD Fire (1995) of the Building Regulations allows a compartment size of 800sqm on a single level. Professor Short notes that the “*ventilation strategy for this building (Lanchester Library) develops a design entirely at odds with the prescriptive model of compliance with the Fire Regulations*” (2017; p 101). The light wells which puncture the floors are not fire rated and admit air to all the floors. An alternative route to compliance had to be followed, which is “potentially time consuming, risk laden and the outcome is unpredictable” (Short A. 2017; p103). This alternative route to compliance took 18 months to achieve. The architectural implications for this involved extending the light wells to create smoke reservoirs and the agreed positioning of fail open/closed damper positions. An adequate fire detection system was paramount and CFD modelling was required in order to demonstrate the ability of the building to evacuate smoke passively. This process and the subsequent similar compliance for SSEES Building have been documented in by Professor Short (2017).



Figure 113: ground floor looking up into the central extract light well

The building has accommodated several internal changes which include more computer usage; less books and a potential greater heat load as a result (Langmead M. 2016). More subdivided spaces requiring transfer grills and, perhaps the most critical, 24 hour usage which has limited the night purging facility. There is also a now post graduate facility in the basement, below the plenum which cannot benefit from natural ventilation system. As the building is still functioning well environmentally, we can conclude that ANV in this format is a sufficiently robust system accommodating changes in operation management.

The external changes have more potential to be disruptive: new buildings including a car park have been erected in proximity to the Library disrupting air flow and with the potential to increase carbon monoxide pollution in the library. This has been monitored but has not shown a significant increase and thus is not an area of concern (Langmead M. 2016). The thermal buoyancy driven ventilation entails a pull of air into the building even when external conditions are not assisting it. As such, the Library ventilation operates independently of the external wind pressure which in an urban environment, with the potential vagaries of external wind pressure, is an important factor. That said, it is independent in terms of quantity of air but not in terms of quality. A better assurance of cleaner air would be to scoop air in at a higher level.

4.3.6 Operational issues. Maintenance of the building's ventilation structures is reported by the facilities managers to be difficult: access into the top of the light wells requires abseiling and access to the lower parts of light wells requires

scaffolding to be placed between the heating elements. Access is required particularly after 16 years of occupation, for sun-blind repairs, painting and replacement of automatic openers.

Ventilation stacks, it appears, tend to be susceptible to mesh or netting deterioration and this is also the case with Lanchester Library with the external extract vents' anti pigeon netting and as a result bird ingress has caused some faecal build up. Again, this is an extract vent issue so that occupant health is not affected and, it should be borne in mind that the maintenance of roof top elements, whether chimneys, plant equipment or stacks is usually accompanied by some degree of access challenges.

Perhaps of more concern, as per the Contact Theatre, is the incoming air into the plenum. The air intake through the plenum vents is driven only by stack effect and cannot be filtered without restricting air flow. As a result dust and dirt are deposited within the plenum space and this requires at least an annual clean. Plenums are usually around half a storey high, in the case of Lanchester, filled with steel fin heaters and are not the easiest of places to keep clean.

Mike Langmead, operations manager of this part of the University campus, makes the comment that in comparison with mechanically ventilated buildings on campus certain things are more difficult within the Library, for example: changing filters on a mechanical ventilation system in other buildings is straight forward even when done quarterly whereas cleaning the plenum is less so. However, the

management of the library systems is relatively straight forward; and some of the state of the art mechanically ventilated buildings on campus are high energy consumers and have a complex BEMS. This is perhaps reinforcing Leaman and Bordass's point (2004) that building technology is inextricably linked with manageability and its success dependent on it.

5.0 Chapter 5: Recommendations

This research has been concerned with understanding effective natural ventilation strategies for different typologies of public buildings and thus endeavouring to discover a vocabulary of ventilation techniques and details that are suited to particular categories of non-domestic buildings within a temperate maritime climate.

5.1 Study Parameters.

The chosen parameters to investigate the effectiveness of the natural ventilation strategies included energy usage, internal air quality, thermal comfort and operation.

- Energy usage was investigated to see if the case study buildings all achieved their design aspirations of low running costs and low CO₂ emissions. Limerick County Council Offices fell short of the design aspiration of 76.4kWh/sqm/yr; however the achieved 125kWh/sqm/yr is well within the ‘good practice’ guidelines for the time (though not meeting the 2020 NZEB energy use target). The Contact Theatre was 57% more efficient than the bench mark for energy use in buildings. Whilst Lanchester Library records a 35% improvement on the bench mark for higher education library buildings.

- Thermal comfort was likewise assessed through literature review and interviews, to examine whether the natural ventilation strategies can attain the CIBSE comfort criteria (2002 and 2005/6). Both Limerick County Council Offices

and the Contact Theatre have demonstrated they meet CIBSE criteria; Lanchester Library had a rigorous POE to backup their successful meeting of the criteria – this documentation was critical to support the future design of ANV.

- Internal air quality (IAQ), as an industry standard is measured by CO₂ ppm, and is deemed representative of human occupation levels in the three chosen typologies. All three case study buildings monitor CO₂ levels and use a maximum value to operate the actuators on the ventilation as required. That auditoria can exceed the CIBSE standard of CO₂ of 1000ppm for short periods of time (1200ppm noted in the Contact Theatre) is acceptable (see BB101 2006). Though, as acknowledged by ASHRAE amongst others, CO₂ levels do not necessarily relate to levels of VOCs in the internal space and soft upholstery of auditorium seating can be a source of such.

- Finally, Ease of Operation, which underpins the other criteria and investigated through interviews and site visits, was used in order to understand how the building has addressed operational changes over time; the ease of maintenance and how performance targets could be achieved.

That natural ventilation strategies in public buildings function in these criteria was supported through the literature reviews of the case studies which demonstrated low energy consumption, good IAQ and an adaptive functioning thermal response. The weakness in Natural Ventilation is in the operation of each building's environmental controls which appears to have had significant difficulties:

- The Contact Theatre has a relatively complex natural ventilation system requiring annual maintenance to dampers, operating windows and mesh and cleaning of the air ingress and plenum.
- Lanchester Library requires a maintenance-heavy cleaning regime particularly of the plenum with its restricted access.
- Limerick County Offices has taken time (circa 6 years) to steer the operation of the environmental management towards the low energy design aspiration with associated man hours and inefficiencies.

Mike Langmead answered, in regard to Lanchester Library, but the answer encompasses the other case studies as well, that these difficulties are generally compensated by the ease of understanding of the functioning of the ventilation elements that – although controlled electronically – are still very much of the mechanical world. It is also compensated by the low running costs of the natural ventilation system.

5.2 Further refinement.

We can see both architectural practices of the case study buildings – Bucholz-McEvoy Architects and Short Associates – in the subsequent development of their work, refining their approach towards the architecture of natural ventilation. Compared with Limerick County Hall, there is greater design simplicity in the north facing atrium at Bucholz McEvoy’s West Meath County Offices and a greater robustness offered by the double skinned façade to the south. Likewise, there is a greater restraint shown in the architecture of Alan Short’s London School of

Slavonic and East European Studies (SSEES, see below). Whilst the Contact Theatre, in comparison, seems to delight in its exuberance - particularly in the foyer and studio theatre skyline - and with this exuberance opens itself for the critique of the quoted theatre director of the tail wagging the dog – a natural ventilation system with a theatre attached! But, the still clearly derivative brick architecture style of Lanchester Library should not have to apologise for its animated skyline, its brick vents nor its light wells in terms of an environmentally functional design.

5.3 Design Fundamentals.

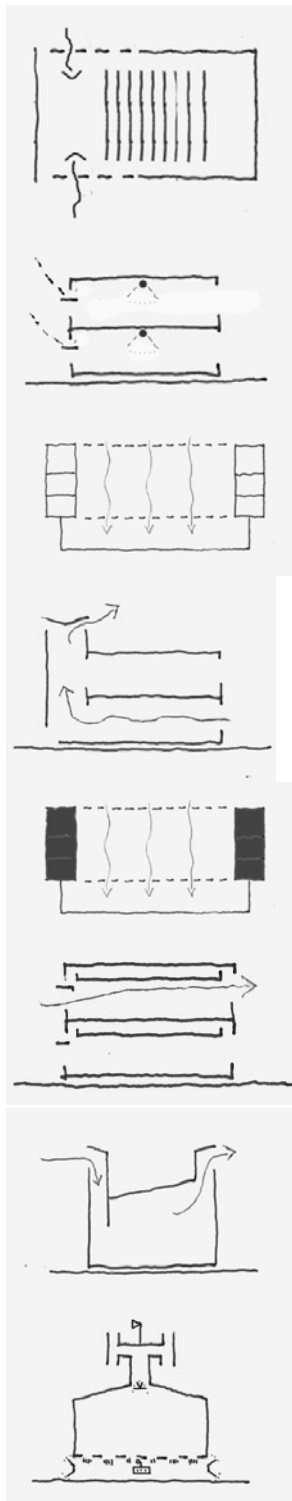
Although natural ventilation strategies are complex reflecting diurnal, seasonal, micro-climatic and occupation variations one can conclude that three fundamental design aspects are critical:

- An understanding of the micro-climate around the building, and the spatial control to govern external areas for ventilation ingress
- A refined simplicity of strategy, demonstrated through the clarity of ventilation paths, ease of maintenance and access for such.
- Tolerance and in-built flexibility in the natural ventilation design with the options provided by omni-directional venting both at extract and intake.

The first point regarding the control of the external spaces where air is drawn can be an area of future concern for all three buildings but more so for the two urban UK examples. The relationship of building to the site is more straight-forward in ventilation design for suburban and rural settings where predominant wind directions

can be utilised. Urban areas suffer from turbulence, potential pollution, wind canyons and wind shadows to the degree that planning for natural ventilation on wind pressure alone can be difficult. Using thermal buoyancy such as in auditoria and ANV designs can ensure the correct quantity of ventilating air but does not necessarily ensure the appropriate quality. In these circumstances it may be prudent, where there is a risk that development and pollution may encroach, to draw air in at higher level as at Portcullis House in London (Hopkins Associates, 2001), or as at the Kursaal Theatre in Harrogate (Mitcham F. 1903).

All three building types – office, auditorium, deep plan building – require particular design attributes in order to function efficiently and to offer the required summer thermal comfort criteria. There are however, as the case studies have shown, elements common to all three:



1. clear ventilation paths as part of the site strategy.
2. heat load reduction strategies both internally and externally against excessive solar gains
3. thorough planning of the internal ventilation flow path for all seasons
4. high floor to ceiling height to allow space for stratification of hot air to collect above the occupant zone
5. careful positioning of service centres for possible separate venting systems
6. use of thermal mass, either within a plenum or in the ceiling plane to store heat, dampen temperature swings and facilitate night time ventilation
7. the use of thermal buoyancy for higher occupancy loads, provided through towers, stacks or atriums
8. BEMS for lighting, heating, ventilation, but with occupant override control

Figure 114: key natural ventilation elements

Specifically for office buildings, getting the balance right between daylight ingress and solar control is critical as well as the distribution of thermal mass and acoustic response and the operation of the BEMS. Taking Limerick County Hall as the design basis, an idealised section might re-orientate the building with a northerly atrium which still facilitates the idea of a transparent communal space and allows a thermal stack to function. The southerly elevation could provide a double skinned façade with solar control, for draught control on windy days and for pre-warming incoming air in winter months. Depth and height ratios for cross ventilation and daylight would be preserved and thermal mass provided in the ceiling plane to facilitate night time cooling as required.

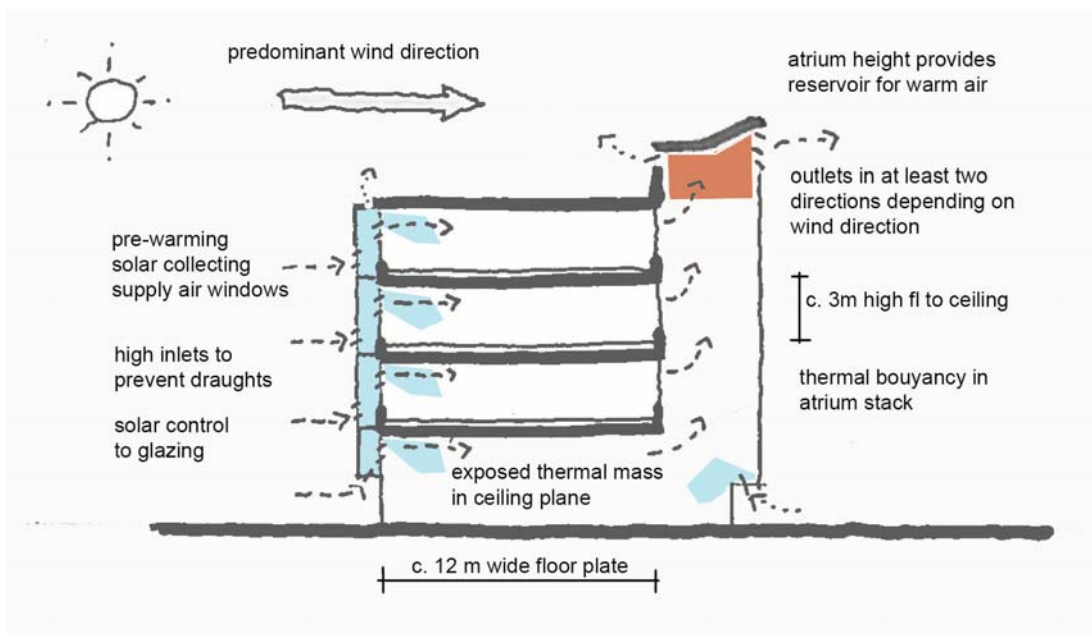


Figure 115: idealised office building section within suburban setting; showing double skin façade to south elevation air intake and atrium to northerly aspect with thermal buoyancy to drive the stack ventilation extract.

Specifically for auditoria, the volume of the space is critical to provide a hot air reservoir above the audience; a minimum dual direction air intake; the height and

terminations of the stacks and again the operation of the BEMS. The section below takes the Contact Theatre main auditorium as the starting point and modifies only the air intake scenario which in a dense urban environment might look at providing wind scoops to bring air into the sub seat plenum. The extract fan is positioned above the acoustic attenuation and importantly there is a facilitated external maintenance access route for the H pot stacks.

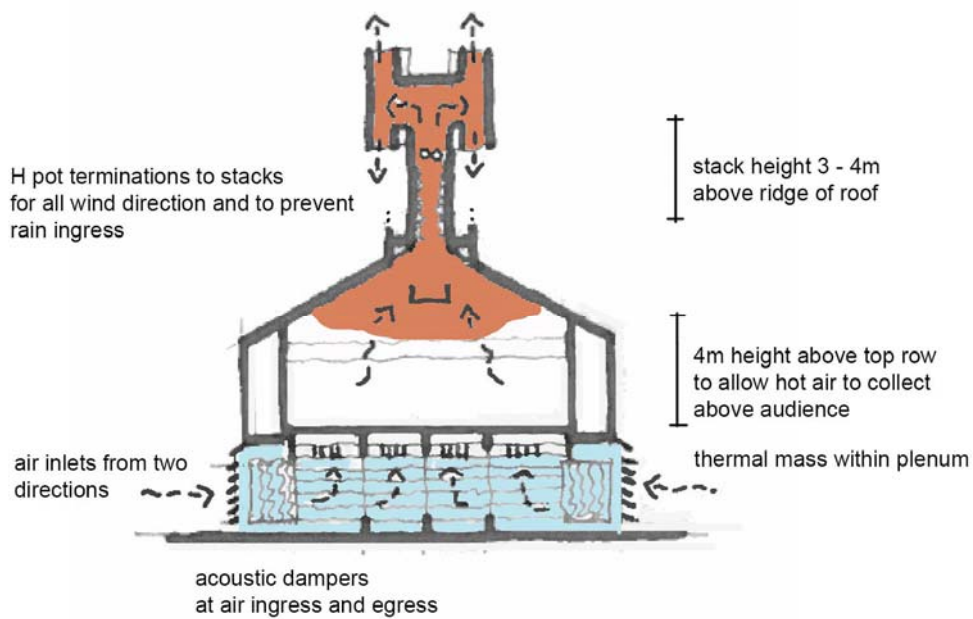


Figure 116: idealised auditorium section showing dual aspect air intake past acoustic attenuation into the plenum. External maintenance access facilitated in roof profile.

Specifically for deep plan buildings that inhabit denser urban environments it is the protection of the air supply which is critical; also the regular, mat-like distribution of the light wells which double up as vents; the importance of the plenum to distribute the air across the plan and the BEMS to monitor and control. The modifications below in the idealised variant on Lanchester Library are to avoid the potential pollution at low level intake. The plenum basement need not take the whole floor and can in part be used for storage given an acceptable height.

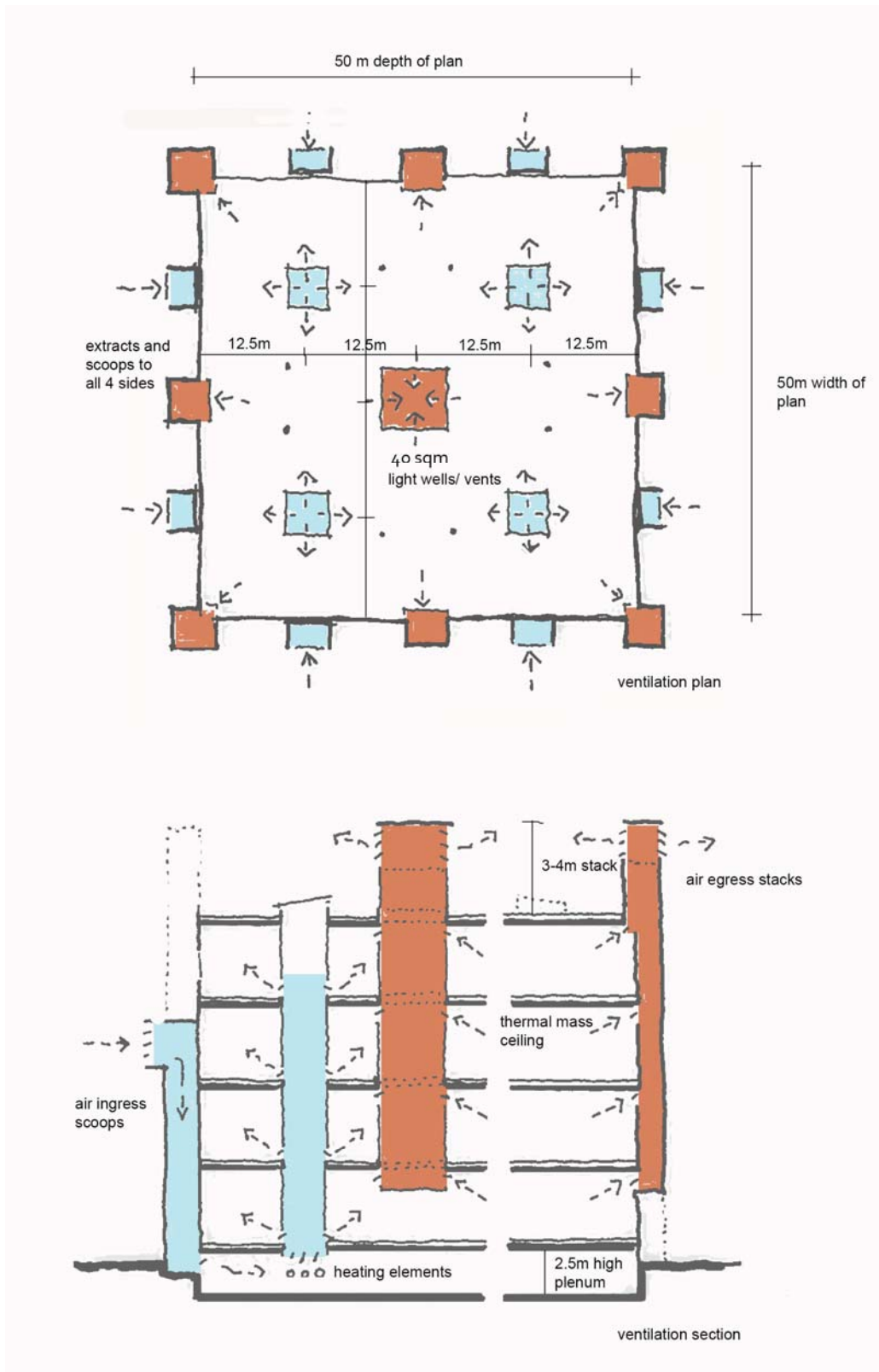


Figure 117: idealised deep plan and section showing omni-directional air intake at higher level dropping down into an accessible plenum and drawn up through four light wells to each floor. Warmed air is evacuated in the centre of the plan through a light well and through perimeter stacks with omni-directional extract.

The resultant architectural vocabulary of natural ventilation is illustrated in the design of the section both for cross ventilation strategies and stack ventilation, as has been shown in the case study analysis. There is a requirement for height – reflecting the fact that warm air rises - whether that is in the extension of an atrium above the top floor of a building, the volume of a space or the stacks and wind scoops of higher thermal load buildings. In buildings where thermal load is less critical and a more simple cross ventilation strategy is used, high floor to ceilings may provide this height allowing for air stratification and warm air exit through clerestory glazing.

Likewise there is a need for thermal mass correctly positioned to store generated heat and facilitate night cooling. But, as is shown in the new generation of timber frame designs, this does not necessitate a heavy weight building but rather strategic placement of thermal mass. Stack ventilation generally requires a plenum to balance and distribute the air, fulfilling too some of the role of the thermal mass. The plenum needs to be simple and accessible for cleaning and maintenance. It is crucial that the detail of the ventilation components is well considered, as Short and Cook have demonstrated: high quality louver systems are required at ingress and outlet; omni-directional wind stacks or scoops that give robustness to the ventilation system through their independence from wind direction. Finally, an intelligent BEMS to steer the building through the vagaries of occupation and weather conditions is essential and, hand-in-hand with this an operations manager who is prepared to engage with the natural ventilation system.

At the design level, the associated rules of thumb for stack ventilation and cross ventilation can be followed to allow the architect to establish the form and design parameters prior to the detailed modelling. Of equal importance is an early understanding of the potential conflicts that lie ahead in the design process: firstly, acoustics, the large external openings that natural ventilation requires will permit noise transfer. Careful positioning of the openings must be the first design consideration to avoid loud environments followed by the use of high acoustic attenuation as required. Coupled with acoustics, is the potential for and avoidance of external air pollution, as described above.

Secondly, fire compartmentation: the ability to ventilate naturally is reduced by floor to floor compartmentalisation. Addressing this at an early stage is essential with appropriate strategies documented in both Lanchester Library and in the SSEES (Short A. 2017). Here it should be noted that whilst wind towers assist in smoke evacuation, wind scoops must be stopped from supplying air in the event of a fire through such as a sealed louvre system.

5.4 Further Research Areas.

NZEB is defined in Ireland through the TGD part L 2017 Key Components of Performance Requirements:

- A 60% improvement in energy performance on the 2008 Building Regulations
- Improved Fabric Specification
- Advanced Services and Lighting Specification
- 20% requirement for renewable energy sources

As NZEB becomes the defining standard of European low energy- high performance buildings, natural ventilation design should be able to take a prominent role with its low energy demand, good air quality, good thermal performance and ease of operation. There are, however, a number of aspects which could benefit from further research.

Firstly a thorough analysis which looks at a comparison between the cost of providing mechanical plant and its associated ductwork with the cost of building works and components associated with natural ventilation elements. This can then be set against the operational costs over a 25 year period (the typical life span of mechanical services). Furthermore these costs can then be balanced against the associated costs of providing daylight into the building and one could take the analysis further by looking at the operational costs and office productivity in the working environment.

A second area of further research would be into the effectiveness of passive heat exchangers within, particularly, the working environment. As noted in the case studies, Bucholz McEvoy architects have utilised these in the SAP office building in Galway to give a tempered fresh air inlet at the point of warm air discharge in the external facades. The success of the passive, dispersed heat exchanger in terms of cost effectiveness and humidity control in our temperate maritime climate is an important area to investigate.

Thirdly is a topic which Short Associates have been investigating with their work in the urban heat island of London at the School of Slavonic and East European (SSESS). This building seeks to demonstrate how natural ventilation strategies can be usefully employed in urban heat islands (which are deemed now to include Birmingham and Manchester but not yet Dublin) where the ventilation challenge is not so much the high summer day time temperature but more so the uplift in night time temperatures which restricts the ability to night cool.

The natural ventilation of the SSESS building is based around a centre in - edge out strategy; so that the building operates as a low level supply and stack vented system in winter /early spring /late autumn. But this is reversed in the summer cooling season: the building is sealed at the base and pre cooled air is admitted at the head of the central light well dropping through the section of the building. Some stack pressure difference develops which exhausts warm air out of the perimeter.

“The SSEES building shows it is viable to create a building in an urban heat island without the need to resort to traditional air-conditioning. The avoidance of air conditioning not only improves resilience and reduces the CO₂ emissions, it reconnects architecture to the provision of air, light and thermal comfort”. (Short A. 2017)

It is a well-documented design process highlighting not just the ventilation issues but also the consequential acoustic and fire prevention issues. However, further research could help determine its applicability to differing building types and a thorough cost benefit analysis would help justify a wider usage in our urban centres. Climate change adaption of our building stock and of our design process is today particularly pertinent (Innovate UK 2104).

Discovering the parameters for natural ventilation design has been driven by the desire to fill the gap between designing with generic rules of thumb and the more specific (and costly) design by calculations and computer modelling. Appropriate early design investigation can now be made with this information based, as it is, on the ventilation loads of differing building types. In architectural practice, prior to the engagement of specialist engineering, the correct design moves can be undertaken, or alternatively, this knowledge facilitates a balanced design team discussion on the credible form that natural ventilation may entail.

The original driver for this thesis was also the idea of a design primer for architectural students. This had a similar intent of facilitating an informed set of design decisions regarding the issues involved with natural ventilation. In this way, student work can move beyond the vagaries of air movement diagrams to the more specific set of forms and details that are required in natural ventilation design. It is proposed that design studies with students on primer projects for natural ventilation can be a continuation of this thesis within Dublin School of Architecture.

5.5 The Pattern Which Connects.

It is this reconnection of architecture to the provision of air, light and thermal comfort which is the driving ideal behind this dissertation – and an answer to the challenge: “*All precepts for climatic compensation through structure and form are rendered obsolete*” (Banham R. p187, 1969). In part from the belief that there is a rich architectural vocabulary with which to play; in part because of the belief that well designed natural ventilation buildings are low energy buildings meeting the now

mandatory criteria of NZEB. In part, too, this is because an architecture of natural ventilation forms a crucial part of the ecological aesthetic of inter-dependence and the *pattern which connects*.

Natural ventilation is one of the prime form givers in an environmentally responsive architecture – in its plan depths, section heights, detail and potentially too its architecturally charged form of stacks and voids. It facilitates our understanding of a response to natural systems – not just in how it visually responds to warm and cool air but also in the adaptive approach to thermal comfort with the internal temperature range more reflective of outside temperatures.

Philosopher and sociologist, Edgar Morin states that the ‘alpha idea’ of all ecological thought is that the independence of a living being necessitates its dependence within its environment. And too Bateson and Prigann (1972) emphasise that an ecological aesthetic is the recognition of a pattern of interconnectedness. An ecological aesthetic places artefacts including buildings and the detailing of, into a dynamic interconnected context rather than understanding them as separate from natural processes.

The *pattern which connects* is as clear in the cycles of oxygen and carbon dioxide within our breathing as much as it is in the hydrological cycle, energy flows and material cycles of our built environment. The recognition of this pattern in architecture and art utilises environmental function to assist in the generation of environmental form. It is the spatial inventiveness, derived from a systems thinking approach, which can come to inform our architectural response to climate change.

Bibliography

- Acred A., Hunt G., (2014) Is the atrium our friend? *Natural Ventilation News 10*
CIBSE
- Aebischer B., Jakob M., Catenazzi G., (2007) *Impact of climate change on thermal comfort, heating and cooling energy demand in Europe*. European Council for an Energy Efficient Economy summer 2007 conference.
- American Society of Heating, Refrigerating and Air-Conditioning Engineers (ASHRAE) (2013). *Climatic Data for Building Design Standards ANSI/ASHRAE Standard 16*. Atlanta, USA: ASHRAE publications
- American Society of Heating, Refrigerating and Air-Conditioning Engineers (ASHRAE) (2016). *The Standards for Ventilation and Indoor Air Quality ASHRAE Standard 62.1*. Atlanta, USA: ASHRAE publications
- Artmann N, Manz H, Heiselberg P. (2007)- Climatic potential for passive cooling of buildings by night-time ventilation in Europe - *Applied Energy*, Elsevier, pages 187-201.
- Awbi, H.B. (1996) Air movement in naturally-ventilated buildings, *Renewable Energy* 8 241–247.
- Awbi H., (2003). *Ventilation of Buildings*, (2nded.). London, UK: Spon Press
- Awbi H., (Ed), (2008). *Ventilation systems Design and Performance*. Abingdon, U.K: Taylor & Francis
- Baggs D., Mortensen N., (2006). Thermal Mass in Building Design. *BDP environment design guide*
- Baker N, Standeven M. (1995). *A behavioral approach to thermal comfort assessment in naturally ventilated buildings*. In: Proceedings of the C.I.B.S.E. National Conference, 1995.

- Banham, R., (1969). *The architecture of the well-tempered environment*, (2nd ed.), London, UK: The Architectural Press
- Bateson G., (1972). *Steps to an Ecology of Mind*. Chicago, USA: University of Chicago Press
- Battle G. & McCarthy C. (1999) *Wind Towers- Detail in Building Series*. London, UK: Academy Editions.
- Blackmore P (2011). *Wind Micro Climate around buildings; Digest DG 520; BRE Press*.
- Blondeau P., Spérandio M., Allard F., (1997). Night ventilation for building cooling in summer. *Solar Energy* 61 (5) 327–335.
- Bordass W. et al (2010) Assessment of building performance in use: the Probe process. *Building Research and Information*
- Brager, G.S., de Dear, R. (2000) A Standard for Natural Ventilation. *ASHRAE Journal*
- Brager, G.S., de Dear, R. (2001) Climate, Comfort, & Natural Ventilation: A new adaptive comfort standard for ASHRAE Standard 55. *Center for Environmental Design Research University of California, Berkeley*
- Brager G., Baker., L. (2009) Occupant satisfaction in mixed-mode buildings *Building research & information* 37(4) Routledge, 369–380
- British Standards Institution (1991). *B.S.I. BS 5925: Code of practice for ventilation principles and designing for natural ventilation*. London, UK: BSI.
- Capra, F., (1997). *The web of life, a new understanding of living systems*. New York, USA: Penguin Random House.
- Chartered Institution of Building Services Engineers (2006). *Environmental design - guide A* (7thed) London, UK: CIBSE

- Chartered Institution of Building Services Engineers (1998). *Energy efficiency in Buildings*; London, UK: CIBSE
- Chartered Institution of Building Services Engineers (2000). *Building control systems - guide H*. London, UK: CIBSE
- Chartered Institution of Building Services Engineers (2011). KS17 Indoor Air Quality and Ventilation. London, UK: CIBSE
- Chartered Institution of Building Services Engineers (2013). TM52 The Limits of Thermal Comfort. London, UK: CIBSE
- Chartered Institution of Building Services Engineers (2005). AM10 Natural Ventilation. London, UK: CIBSE
- Chartered Institution of Building Services Engineers (2005). *Natural ventilation in non-domestic buildings - a guide for designers, developers and owners – good practice guide 237*. London, UK: CIBSE
- Cook M. & Short A., (2009) Natural ventilation of auditoria: three case studies. In Mumovic D. & Santamouris M. (2009) *A handbook of sustainable building design and Engineering*. Abingdon, UK: Routledge, Earthscan
- Cresswell J., Plano Clark V., (2006) *Designing and Conducting Mixed Methods Research*. Oxford, UK: Blackwell
- Clausen G. (2004) Ventilation filters and indoor air quality: a review of research from the International centre for Indoor environment and energy. *Journal of Indoor Air*, Vol 14 p202 -207,
- Department of Energy, Transport and the Regions (DETR) (1997). *ECON54: Energy efficiency in further and higher education*. London, UK: CIBSE
- Department of Energy, Transport and the Regions (DETR) (2000). *ECON19: Energy consumption guide (best practice programme)*. London, UK: CIBSE
- Drake S., de Dear R., Alessi A., Deuble M (2010). Occupant comfort in naturally

ventilated and mixed-mode spaces within air-conditioned offices. *Architectural science review*, Earthscan 297–306

Ellis J. (2010). Indoor Air Quality in Lecture Theatres and Large Enclosed Public Spaces. University of Brighton

European Union: www.ec.europa.eu/energy/en/topics/energyefficiency/buildings

Fanger P.O. (1988) Olf and decipol: new units for perceived air quality. *Building Services Engineering Research & Technology*,

Farrell A. (2010) VEPA (Vitruvian eco-physiological Architecture) – a primer for a sustainable built environment. *Built environment* - Sept/Oct 2010

Fisk, W.J. (2000). Review of health and productivity gains from better IEQ. *Proceedings of Healthy Buildings 2000* Vol. 4. 23

Fisk, W.J. (2002). How IEQ Affects Health and Productivity. *ASHRAE journal*

Fitzgerald S., Woods A., (2007). Dramatic Ventilation. *Building Services Journal*. www.bsjonline.co.uk

Fordham, M. (2000), Natural ventilation. *Renewable Energy* 19 (2000) 17-37, Elsevier

Ghiaus C. & Allard F.,(Ed) (2005). *Natural ventilation in the built environment – assessment and design*. Abingdon, UK: Routledge, Earthscan.

Gratia E. & De Herde A. (2004). Natural cooling strategies efficiency in an office building with a double-skin facade, *Energy and Buildings* 36 (11) 1139–1152.

Green N., Riffat S., Etheridge D., Clarke R., (1998). Traffic pollution in and around a naturally ventilated building. *CIBSE A: Building Serv. Eng. Res. Technol.* 19(2) 67-72.

- Haigh R., (2008), Interviews a negotiated partnership. In Knight A. and Ruddock L. (Ed) (2008). *Advanced research methods in the built environment*. Oxford, UK: Wiley Blackwell
- Hawkes D., (2012). *Architecture and Climate, an environmental history of British Architecture 1600-2000*. Abingdon, UK: Routledge
- Hegger M., Fuchs M, Stark T, Zeumer M. (2008) *Energy Manual Sustainable Architecture*. Munich, Germany: Birkhauser
- Heiselberg, P. (2008). The characteristics of natural and hybrid ventilation systems. In Awbi H., (Ed), (2008). *Ventilation systems Design and Performance*. Abingdon, U.K: Taylor & Francis
- Humphreys M. (1995) *What causes thermal discomfort?* In: Proceedings of the Workplace Comfort Forum, RIBA, London
- Jones P, (1997) *Natural ventilation of the contact theatre*. In: Proceedings of 18th AIVC Conference "Ventilation and Cooling", Athens, Greece, 1997
- Ji Y. & Lomas K.J (2009) *Current and likely future performance of advanced natural ventilation*. Proceedings of UK Glasgow, Eleventh International IBPSA Conference
- Kagan S., (2011). *Art and Sustainability: Connecting Patterns for a Culture of Complexity*. Bielefeld, Germany: Transcript Verlag.
- Kenton A., G. (2004). *Natural Ventilation in Auditorium Design: Strategies for Passive Environmental Control*. In: PLEA 2004 Conference on Passive and Low Energy Architecture
- Kenton A., G. Fitzgerald S., Woods A., (2004). *Theory and Practice of Natural Ventilation in a Theatre*. In: PLEA 2004 Conference on Passive and Low Energy Architecture
- Krause, B., Cook, M.J. Lomas, K.J., (2006). *Environmental performance of a*

naturally ventilated city centre library. Proceedings of the International Conference on Comfort and Energy Use in Buildings - Getting them Right, Windsor, UK, 27th-30th April 2006,

Krausse, B., Cook, M.J. Lomas, K.J., (2006). *Performance Monitoring of a Naturally Ventilated City Centre Library* Proceedings of PLEA2006 - The 23rd Conference on Passive and Low Energy Architecture, Geneva, Switzerland, 6-8 September 2006

Kuehn T. H., (2005). Airflow around buildings chapter 16. In *ASHRAE Handbook-Fundamentals*. Atlanta, USA: ASHRAE publications

Kukadia V., Pike J., White M.,(1997) *Air Pollution And Natural Ventilation In An Urban Building: A Case Study* -CIBSE National Conference 1997

Latham I. & Swenarton M.,(Ed) (2007). *Feilden Clegg Bradley: The Environmental Handbook*. London, UK: Right Angle Publishing Ltd

Lewis A., Brooks B; (2011) *Fundamentals of building operation maintenance and management*. Atlanta, USA: ASHRAE publications

Li, Y (2008). Airflow, heat and mass transfer in enclosures. In Awbi H., (Ed), (2008). *Ventilation systems Design and Performance*. Abingdon, U.K: Taylor & Francis

Lomas K.J. (2006) *Architectural design of an advanced naturally ventilated building form* . Institute of Energy and Sustainable Development, Energy and Buildings 39 166–181 Elsevier

Lomas K.J, Cook M. J. Short A (2009) *Commissioning Hybrid Advanced Naturally Ventilated Buildings: A US Case Study*. Building research & information 37(4), 397–412 Routledge Taylor Francis

Lomas K.J, Cook M. J. Short A (2009). *Delivery and Performance of a Low-Energy Ventilation And Cooling Strategy*. Building Research & Information 37(1), 1–30, Routledge Taylor Francis

- Martin, A.J. & Fletcher, J. (1996). Night Cooling Control Strategies. *Building Services Research & Information Association*, BSRIA
- McDonough, W. and Braungart, M.(2002).*Cradle to Cradle: Remaking the Way We Make Things*. New York, USA: Macmillan.
- Mumovic D., Wilton O., Hong S. M., (2013).Natural ventilation in city centre buildings. In Mumovic D., Santamouris M., (Ed) (2013) *A handbook of sustainable building design- an integrated approach to energy health and operational performance*. Abingdon, UK: Routledge, Earthscan
- Nicol F and Roaf S. (2007). Progress on passive cooling: – adaptive thermal comfort and passive architecture. In Santamouris M. (Ed) (2007).*Advances in Passive cooling - Buildings energy solar technology series*. Abingdon, UK: Routledge, Earthscan
- Orr, D. W. (2004) *Earth in Mind: On Education, Environment, and the Human Prospect*. Washington DC USA: Island Press.
- Olesen, B.W. (2007). The philosophy behind EN15251: indoor environmental criteria for design and calculation of energy performance of buildings. *Energy and Buildings* 39.
- Olesen B, Bluysen P, Roulet C (2008). Ventilation and indoor environmental quality. In Awbi H., (Ed), (2008).*Ventilation systems Design and Performance*. Abingdon, U.K: Taylor & Francis
- Noon P., (2008) The Lanchester Library - Building a Sustainable Library. *Liber Quarterly* 18 (2), Netherlands: Utrecht Publishing & Archiving Services
- Penn A., (2008). Architectural Research. In Knight A. and Ruddock L. (Ed) (2008).*Advanced research methods in the built environment*. Oxford, UK: Wiley Blackwell
- Petrie G., Reidy C., Nealon D., (2012). *Uncommissioned Reports – Energy Use and Environmental Performance in Public Buildings*. Limerick: SAUL Press.

- Proverbs D. and Gameson R., (2008), Case Study research. In Knight A. and Ruddock L. (Ed) (2008). *Advanced research methods in the built environment*. Oxford, UK: Wiley Blackwell
- Ni Riain C. Kolokotroni M. et al. (1999) Cooling Effectiveness of South Façade Passive Stacks in a naturally ventilated Building. *Indoor built environment*; 8:309-321
- Ni Riain C and Kolokotroni M. (2000) *The effectiveness of Ventilation Stacks in enhancing natural ventilation in non-domestic buildings*. Architecture, City, Environment: Proceedings of PLEA 2000, James & James Ltd, London, UK, 2000
- Rijal H., Humphreys M., Nicol F. (2009). Understanding occupant behaviour: the use of controls in mixed-mode office buildings. *Building research & information* 37(4), Routledge Taylor Francis 381–396
- Roaf S., (2008) *The Traditional Technology Trap (2): More lessons from the Windcatchers of Yazd*. 25th Conference on Passive and Low Energy Architecture, Dublin, 2008.
- Roelofsen P. (2002). The impact of office environments on employee performance: The design of the workplace as a strategy for productivity enhancement. *Journal of Facilities Management, Vol. 1 Issue: 3, pp.247-264*
- Roulet C (2008). Energy implications of indoor environment control. In Awbi H., (Ed), (2008). *Ventilation systems Design and Performance*. Abingdon, U.K: Taylor & Francis
- Ryan C.P. (2005) *SEI Good Practice Case Study 15*. Dublin: SEI publications
- Sassi P. (2013) *A Natural Ventilation Alternative to the Passivhaus Standard for a Mild Maritime Climate*. Buildings 2013, 3, 61-78. www.mdpi.com/journal

- Santamouris M. (2005). *Advances in passive cooling*. Abingdon, UK: Routledge, Buildings Energy and Solar Technology
- Schulze T. & Eicker U. (2012) Controlled Natural Ventilation for energy efficient buildings energy and buildings *Energy and Buildings* 56.Elsevier221–232 223
- Short A.C., (2017).*The recovery of natural environments in architecture*.*Air, comfort, climate*. Abingdon, UK: Routledge, Earthscan
- Sustainable Energy Authority of Ireland SEAI (2016) *The Energy Performance of Buildings Directive (EPBD)*-www.seai.ie
- Sustainable Energy Authority of Ireland SEAI (2019) *The Energy Show, Part L and EPBD*-www.seai.ie
- Thomas R & Garnham T., (2007). *The Environments of Architecture – Environmental Design in Context*. Abingdon, U.K: Taylor & Francis
- Tuohy P., McElroy L., Johnstone C. (2004) Thermal mass, insulation and ventilation in sustainable housing - an investigation across climate and occupancy. University of Strathclyde.
- Turner, J.S., Soar R.C., (2008). *Beyond biomimicry: What termites can tell us about realizing the living building*. First International Conference on Industrialized, Intelligent Construction (I3CON) Loughborough University, 14-16 May 2008
- Wahl, D. C., (2006). *Eco-literacy, ethics, and aesthetics in natural design: The artificial as an expression of appropriate participation in natural process*. Dundee, UK: Centre for the Study of Natural Design, University of Dundee.
- Walsh R., Kenny P., Brophy V. (2006). *Thermal Mass and Sustainable Building*. Dublin: Irish Concrete Federation publications
- Wood A., &Salib R., Council on Tall Buildings (2013). *Natural Ventilation in high rise office buildings*. Abingdon, UK: Routledge

Yun G., Steemers K. & Baker, N. (2008) Natural ventilation in practice: linking facade design, thermal performance, occupant perception and control. *Building research & information* 36(6), 608–624. Routledge Taylor Francis

Zhao Y., Jones J.R. (2007) Decision Support for Natural Ventilation of Non-residential Buildings. *Journal of architectural engineering*, American Society of Civil Engineers

Appendices

Appendix 1: Initial interview format for operational managers

Case study project

place

time

Interviewee and position

Walk through and description of natural ventilation strategy

Changes required to natural ventilation strategy since opening of facility

Reason for changes internal issues

Reason for changes external issues

Building layout organisation issues

Change in energy rating

Occupant interaction with building

Maintenance of natural ventilation building components

Management of BMS

Effectiveness of natural ventilation as means of providing fresh air

Effectiveness of natural ventilation as means of providing cooling requirement

Appendix 2: Follow up Questionnaire for Facility Managers (selected elements used as appropriate)

Energy

Can you confirm the current Building Energy Rating for the building?

How has this changed from the design energy rating? And post completion energy rating?

-
- What are running costs of the facility in kWhr?
 - Heating
 - Cooling
 - Electricity
-

Operation

Are there any specific issues involved in the maintenance of the ventilation system, such as:

- Cleaning of ducts and dampers
 - Maintenance of louvres
 - Operational accessibility
 - Periodicity of inspections
-

To what level are the ventilation controls left to the occupant?

Are there any operational issues with the BMS system?

Has the BMS been upgraded since installation?

How flexible is the system in responding to external weather changes?

Internal Air Quality

What are the air changes per hour provided by the ventilation system?

At design?

and at post occupancy?

Is CO2 level adequately monitored?

Are there any noted issues with air borne pollutants?

Are there any noted issues with unwanted odours?

Is there a system in place for occupant feedback/ reporting complaints or third party monitoring?

Comfort

Is thermal comfort maintained within CIBSE recommendations?

If comfort temperatures are exceeded what is the frequency/ annum and how is this dealt with?

Are localised draughts avoided?

Appendix 3: Notes from interview with Pdraig Power Facilities manager

Case study 1: Limerick County Council Offices

Case study project place	Limerick county council offices Dooredoyle, Limerick
time	12:30; 9th September 2015
interviewee position	Padraig Power facilities manager
Walk through and description of natural ventilation strategy	
Changes required to natural ventilation strategy since opening of facility	Tweaking consisted of recognising overheating in the atrium in winter: trying to evacuate warm air in top half of foyer opened both top and bottom vents, surging in cold air in ground floor kicked the heating on unnecessarily. Decoupling the top and bottom vents meant that top vent could evacuate without needing cold air at base. No further heating required and cool from the top.
Reason for changes internal issues	overheating in the atrium in winter
Reason for changes external issues	Quick response and BMS override due to changeability of weather patterns
Building layout organisation issues	layout of offices means service spaces inhibits cross ventilation in third of plan. Sliding doors – as cost saving – even with draught lobby still let draughts in and cool building unnecessarily. Revolving doors would have been better. Council chamber needs quick response heating as infrequent use. Large thermal mass wall in space is not helpful
Change in energy rating	D2 to B3 (resultant benefits: halving the gas consumption and a 20% reduction in electricity consumption)
Occupant interaction with building	Occupant control consists of local operating of trickle vents, windows, blinds and radiators
Maintenance of natural ventilation building components	External brise soleil is a bird perch, abseiled required to clean glass because cherry picker won't fit between
Management of BMS	Further tweaking involves interactive management with the BMS on a daily basis because Irish weather is changeable. Lighting levels are dropped to give a sense of coolness.
Effectiveness of natural ventilation as means of	CO2 levels below 1000ppm.

providing fresh air
Effectiveness of natural
ventilation as means of
providing cooling
requirement

Temperatures are comfortable and within CIBSE
values

Appendix 4: Notes from interview with Merritt Bucholz 7th September 2017

Evolution of natural ventilation strategies in office design?

Immediate issues with Dooradoyle – as per P Power – atrium did not function as well as predicted – over heating in winter, kicked in top and bottom vents opening and as a result cold air flooding the lower floor which would kick on the heating system. P P rightly recognised that the separation of the two vents meant that necessary cooling of the space was achieved from above only. In summary, it took a dedicated operations manager to tinker with the BMS and operations system to fine tune a building which had little in built tolerance. More so considering the potential diurnal range of insolation, temperature and wind.

It is a slow evolution but the main difference is in that there are more metrics today than in 2000 when Dooradoyle was designed. We still use thermal modelling which drives all our design decisions.

One of the issues that has changed in our design work regards thermal mass – it has been shown that the effectiveness of the thermal mass in our climate is only up to about 35mm deep. This has allowed us to reduce the amount of concrete in our buildings and think about using more timber as structural decks eg Ballyogan operations and maintenance depot 2013 and cf FCBStudios Woodland Trust HQ with precast concrete slabs integrated within the timber ceiling deck.

Design lessons in Dooradoyle : natural ventilated buildings need more tolerance, Westmeath Coco for example has more layers to it – the south façade with a double skin that operates horizontally not vertically to suck air out in summer and pre warm in winter and the north facing atrium. These additional layers give a more tolerance in terms of operation.

Energy, comfort and health would all be very similar to Dooradoyle – i.e same parameters used.

Operation – has developed to become more intuitive and more tolerant.

SAP building 2005 with central atrium - vents out of this both to east and west – external facades use fixed, closed windows (windows are heavy to move repeatedly) and uses instead insulated light weight panels which are better to open. It also utilises dispersed heat exchangers for a tempered fresh air inlet.

Design obstacles:

The success of the building depends as much on the client – the client must want a responsive building with an engaged relationship with the climate. And understand that the investment is in facades and design – not a piece of kit.

Appendix 5: notes from interview with Steve Curtis Operations Manager

Case Study 2: Contact Theatre

Case study project	contact theatre
place	contact theatre Manchester
time	12 noon 16th October 2015
interviewee	Steve Curtis
position	operations manager
Walk through and description of natural ventilation strategy	Ventilation to foyer External pods passing through heating elements but air rises to first and second floor First floor former bar area incoming vent through entrance screen and over heaters with extract vent through side towers within screen using stack effect. Ventilation to space 1 main theatre Through four plenums beneath seating from west side louvres and past acoustic attenuators before passing heating elements under seats. Extract ventilation is through 5 H pots with fans positioned within auditorium – ease of access but acoustic disturbance – air passes through acoustic attenuators before exiting. Ventilation of space 2 studio theatre Air enters from north side first floor grills past tightly packed – i.e not easily cleanable – acoustic attenuators passing heating elements into meter high plenum space beneath the studio theatre. Air extracted through 4 H pots which do not always extract but sometimes depending on wind pressure blow in.
Changes required to natural ventilation strategy since opening of facility	Note the ventilation requirements of the foyer have substantially reduced following the prohibition of smoking inside Thermal comfort of auditorium never an issue but stage area is effectively by passed by the ventilation strategy and its associated heating more so now that halogen lights have been changed to LEDs. Originally there was to be a further mezzanine gallery in this space and access to an external theatre space on the roof which would have made more sense of the expense of the H pots.
Reason for changes internal issues	No smoking internally in bar;
Reason for changes external issues	No external changes
Building layout organisation issues	Complexity of plan and section – existing building meant some compromises on imposing nat vent system
Change in energy rating	Generally, system now works quite well and energy

	rating is a B which is 57% better than a standard equivalent building.
Occupant interaction with building	Only in bar area
Maintenance of natural ventilation building components	Difficult, tightly packed acoustic attenuation However, maintenance and cleaning in particular is laborious and not well designed in. Cost cutting in final build led to inadequate external louvre provision and thus some vermin ingress. Mechanical opening rods in bar area are laborious to maintain and operate
Management of BMS	Override to foyer BMS with occupancy response button which opens windows, louvres or closes. Note that the BMS has a midnight close down button shutting all windows etc on basis that the building is then unoccupied.
Effectiveness of natural ventilation as means of providing fresh air	For main theatre – good, for studio theatre sometime inadequate
Effectiveness of natural ventilation as means of providing cooling requirement	For main theatre – good, for studio theatre sometime inadequate

Appendix 6: Noted from interview with Mike Langmead Operations manager

Case Study 3: Lanchester Library

Case study project	Lanchester library
place	Lanchester library Coventry university
time	15th March 2016.
interviewee	Mike Langmead
Position	mechanical operations engineer

Walk through and description of natural ventilation strategy

Changes required to natural ventilation strategy since opening of facility

Reason for changes internal issues	More computer usage, less books, potential greater heat load More subdivided spaces requiring transfer grills 24 hour usage curtailing night purge facility Post grad facility in basement, below plenum cannot benefit from at vent system
------------------------------------	--

Reason for changes external issues

New buildings including car park and ECB in proximity disrupting air flow and potential increase in carbon monoxide, monitored but not significant.

Building layout organisation issues

Note it is possible to isolate floors if some floors are not in use, though whole building approach effectively means cutting off ventilation to the closed areas.

Change in energy rating

Occupant interaction with building

Note student occupants of building are transitory and sonot useful to give them local control.

Maintenance of natural ventilation building components

Maintenance of building in aspects of nat vent generally difficult:

Access into top of light wells requires ropes
Access to lower parts of light wells requires scaffold placed between heating elements
External extract vents anti pigeon netting has deteriorated and bird ingress has caused fecal build up.
Note that air intake through the plenum vents is driven only by stack effect and cannot be filtered without restricting flow. As a result dust and dirt deposited within plenum requires annual clean.

In comparison with mechanically ventilated buildings on campus certain things are more difficult eg changing filters on a mech vent system is straight forward even when done quarterly whereas cleaning the plenum is not. However, the management of the library systems is relatively straight forward, the state of the art ECB is both a high energy consumer and complex BMS.

Management of BMS

Note building operates its ventilation steered more by CO₂ than by temperature, greater toleration of a slightly warmer building. However, any cooling of the building required can only be achieved through nat vent.

Building responds to CO₂ and temperature measurements set on walls and floors in c 3m x 3m bays. Centralised control BMS.

Effectiveness of natural ventilation as means of providing fresh air

Note although incoming air is warmed to 12 – 15 degree C it will present quite a draught when entering the library space which is perceived by students as unpleasant. Local heaters temper the air as required. UFH used for background temp.

Effectiveness of natural ventilation as means of providing cooling requirement

Appendix 7: **List of Publications**

- Across Architectural Research through to Practice

48th International Conference of the Architectural Science Association
Genoa 2014

“Natural ventilation strategies as a design primer in near-zero-energy building”

- AIARG 2014

3rd Annual Conference of All Ireland Architectural Research Group

“Natural ventilation strategies as a design primer in near-zero-energy building”

- AIARG 2015

4th Annual Conference of All Ireland Architectural Research Group

“A Vernacular of Ventilation”

- AIARG 2016

5th Annual Conference of All Ireland Architectural Research Group

“Building Within a Culture of Sustainability”