



Technological University Dublin
ARROW@TU Dublin

Conference papers

School of Civil and Structural Engineering

2009

Highway Bridge Assessment for Dynamic Interaction with Critical Vehicles

Daniel Cantero
University College Dublin

Eugene J. O'Brien
University College Dublin

Arturo González
University College Dublin

Bernard Enright
Technological University Dublin, bernard.enright@tudublin.ie

Cillian Rowley
Follow this and additional works at: <https://arrow.tudublin.ie/engschcivcon>
Buro Happold Ltd, London

 Part of the [Civil Engineering Commons](#), and the [Structural Engineering Commons](#)

Recommended Citation

Cantero, D., O'Brien, E.J., González, A., Enright, B. and Rowley, C. (2009), 'Highway Bridge Assessment for Dynamic Interaction with Critical Vehicles'. In: Furuta, Frangopol & Shinozuka eds. 10th International Conference on Safety, Reliability and Risk of Structures, ICOSSAR 2009 Osaka, Japan, pp.3104-3109.

This Conference Paper is brought to you for free and open access by the School of Civil and Structural Engineering at ARROW@TU Dublin. It has been accepted for inclusion in Conference papers by an authorized administrator of ARROW@TU Dublin. For more information, please contact yvonne.desmond@tudublin.ie, arrow.admin@tudublin.ie, brian.widdis@tudublin.ie.



This work is licensed under a [Creative Commons Attribution-NonCommercial-Share Alike 3.0 License](#)



Highway bridge assessment for dynamic interaction with critical vehicles

D. Cantero, E.J. OBrien & A. González

University College Dublin, Dublin, Ireland

B. Enright

Dublin Institute of Technology, Dublin, Ireland

C. Rowley

Buro Happold Ltd, London, England

ICOSSAR 2009 – 10th International Conference on Structural Safety and Reliability. Osaka. Sep 2009

ABSTRACT: Dynamic vehicle-bridge interaction is often considered for the most common classes of vehicle such as the 5-axle articulated truck. However, the dynamic response of bridges to this type of trucks is quite different to the response to the vehicles more likely to feature in maximum-in-lifetime traffic loading events. This paper focuses on large (>100 tonne) cranes and crane-type vehicles that have been recorded at Weigh-in-Motion sites in Europe. This paper analyses the total bending moment due to these vehicles on short to medium span bridges and compare them to 5-axle articulated trucks. To account for the variability in vehicle characteristics, more than 40,000 vehicle-bridge interaction events are computed using Monte Carlo simulation.

1 INTRODUCTION

Freight transport has increased by 45% in Europe over the past decade (Eurostat 2008) and this trend seems likely to continue into the medium term future. A possible solution to the resulting capacity problem that this creates would be to increase the permitted gross vehicle weight to 60t and the number of axles to 8 (OBrien et al. 2008). The effect on highway bridges of this potentially significant change in traffic configuration is currently under evaluation, although Weigh In Motion (WIM) records have already observed high frequencies of extremely heavy vehicles, with weights well in excess of the normal legal maximum in some heavily trafficked highways. These extreme vehicles, with gross weight in excess of 100 tonnes, tend to be either mobile cranes with very closely spaced axles or low loaders with much longer wheelbases. Such vehicles would be expected to have special permits and escort vehicles, but were recorded mixed with normal traffic and travelling close to the speed limit of 80km/h. Whether or not the legal limit for trucks without permits was changed, it is reasonable to expect that cranes and crane-type vehicles will govern the design/assessment of some bridges in some circumstances. Therefore, it is needed to assess their dynamic interaction with bridges and the allowance that needs to be made for dynamics. So, this paper reviews the dynamic effects of large cranes on short to medium span

bridges and compares them to common 5-axle articulated trucks, focussing on the mid-span bending moment load effect. Bending moment load effects are obtained using a Monte Carlo simulation that varies the parameters of a 2-dimensional vehicle-bridge interaction model.

2 CRITICAL VEHICLES

WIM measurements were taken in 2005 at a heavily





Figure 1. Photo examples of recorded WIM trucks, a) 5-axle truck, b) crane.

trafficked site near Woerden, 30 km east of the port of Rotterdam, the Netherlands. There are 77 week-days for which a full record is available, giving a total of 546,448 measured trucks. There are cameras at the WIM site which photograph unusually heavy trucks, and these photographs provide useful evidence to support the identification and classification of vehicle types. A significant feature of the gathered data is the high population of extremely heavy vehicles – cranes and low loaders – with a total of 892 vehicles in excess of 70t, daily occurrences of vehicles over 100t, and a recorded maximum of 165t.

Heavy low loaders are characterised by a group of closely-spaced axles at the front of the vehicle, followed by a gap of about 10m and another group of axles at the rear. On the other hand, all axles on cranes are closely-spaced, and this concentration of weight over a much shorter wheelbase produces significantly higher bending moments on the bridge spans under study in this paper therefore only cranes are studied here. Figure 1 shows an example of a typical crane and a 5-axle truck of the type used for comparison. The 9-axle crane in Figure 1(b) has a gross vehicle weight of 110.6t and a wheelbase of 14.85m. Cranes are frequently accompanied by vehicles carrying ballast which have gross weights and axle layouts which are very similar to the cranes. These “crane-type” vehicles are included in this study.

3 VEHICLE-BRIDGE INTERACTION MODEL

3.1 Vehicle Model

To describe the vertical forces applied by a vehicle to a bridge structure, an articulated 3-dimensional truck model that allows for the definition of any number of axles on both, tractor and semitrailer, is built as repre-

sented in Figure 2. This model consists of a combination of rigid bodies and lump masses, representing the body and axle masses. These are linked together and to the profile by spring-dashpot systems, representing the tyres and suspensions.

The vehicle model assumes constant speed, tyre-ground contact at one single point, vertical vehicle forces and linear stiffness and damping elements. Similar vehicle models are widely used in the literature (Wang et al. 1992, Gillespie et al. 1979) representing vehicle-bridge interaction with a good accuracy (Cebon 1993). Those vehicle models have been extended here to allow for a variable number of axles and an optional articulation, making it possible to easily represent either 5-axle articulated trucks or larger rigid vehicles such as cranes.

The vehicle parameters were obtained from a number of different sources: the body masses and axle spacing were calculated directly from the WIM measurements, the suspension mechanical properties for 5-axle trucks were taken from the large database provided by Fu et al. (2002) who provides a large suspension database, the tyre properties are those proposed by Kirkegaard et al. (1997), the crane suspension properties are those recommended for a similar vehicle by Li (2005), and finally, the crane tyre properties are those found from extensive experimental tests by Lehtonen et al (2006).

3.2 Bridge Model

The bridge is represented as a simply supported orthotropic plate (Rowley 2007). The finite element bridge model consists of plate elements with 16 degrees of freedom, and it is solved using Kirchhoff thin plate theory. The bridge properties are listed in Table 1 and are typical of bridges with voided cross section (OBrien et al. 1999). A 3% structural damping is assumed for both bridge spans.

Table 1. Properties of studied bridges

Span	Width	Depth	Density	1 st natural frequency
m	m	m	kg/m ³	Hz
15	9	0.8	1929	6.9
25	9	1.2	1562	4.12

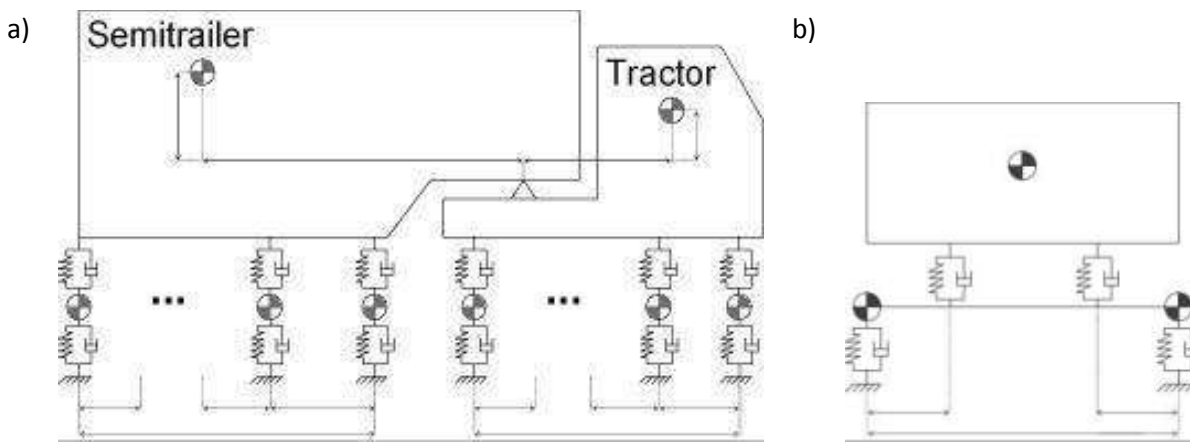

Figure 2. Vehicle model sketch, a) Side view, b) Front view

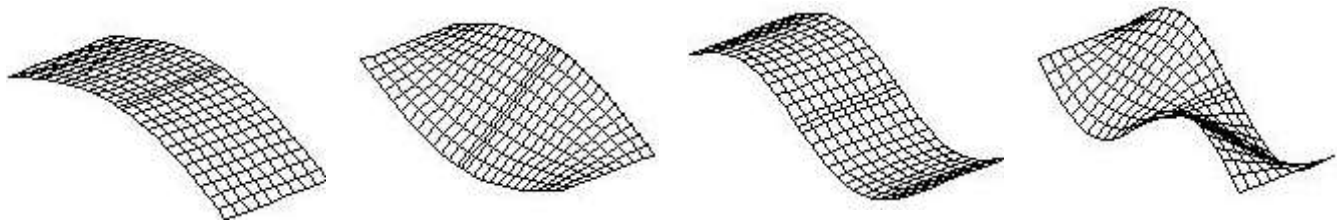

Figure 3. First four mode shapes for simply supported plate

The finite element model allows to specify a non-uniform spacing and a finer mesh near mid-span. The first four mode shapes of the modal analysis for the simply supported plate model are illustrated in Figure 3.

3.3 Interaction Solution

The solution of a vehicle moving at constant speed over a bridge with an uneven road profile is an iterative procedure (Green et al. 1995). The calculations needed in the iteration process can be described in five steps:

- 1 Calculate vertical forces of vehicle wheels due to movement over road profile (ignoring bridge)
- 2 Calculate vertical displacements of bridge due to vehicle forces
- 3 Add bridge deformations to the profile elevations
- 4 Recalculate vertical forces for the new 'profile'
- 5 Repeat steps 2 to 4 until convergence is reached

The convergence criterion adopted in this paper is that the bending moment difference between two

consecutive iterations becomes less than or equal to 1N·m. Figure 4 is an illustration of the iterative process.

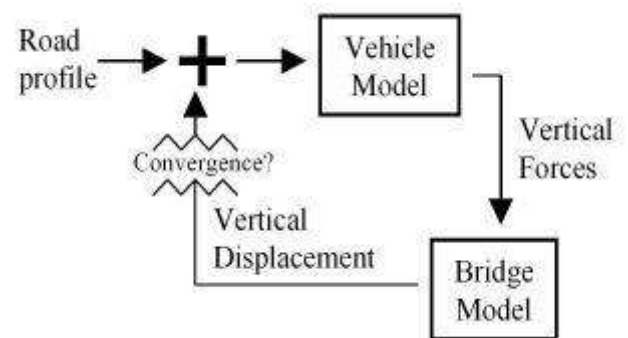

Figure 4. Iterative process diagram

The equations of motion of the vehicle are implemented and solved in Matlab by reducing the second order dynamic equations to a system of first order ordinary differential equations. These are solved using the Runge-Kutta numerical integration scheme, with the Dormand-Prince pair (Shampine 1986). The plate differential equations are solved by means of modal superposition and the exponential matrix integration scheme (Busby et al. 1997). The results obtained by

this iterative process were found to agree with results from an experimentally validated 3-dimensional vehicle-bridge-road profile interaction finite element model developed by González (2008) using MSC/NASTRAN software.

4 DYNAMIC ANALYSIS

Dynamic Amplification Factor (DAF) is widely used in the literature either for theoretical studies (Ruíz-Terán et al. 2006, Savin 2001, Harris et al 2007) or experimental results (Senthilvasan et al. 2002, Naumoski et al. 2004, Paultre et al. 1995) to evaluate the dynamics of a vehicle-bridge system,. This factor evaluates the increase of a certain load effect due to dynamics by comparing the total response to the static response. In this paper the bending moment at mid-span is under consideration, and DAF is defined as the ratio of total to static bending moment.

4.1 Monte Carlo simulation

From the WIM data described in section 2, the 5-axle trucks and cranes that generate the daily maximum static bending moment were selected to be studied dynamically in a Monte Carlo simulation. A total of 18 different vehicle parameters were varied within a realistic range of values, including speed, suspension mechanical properties (allowing for air and steel suspensions), tyre properties, axle masses and others.

As the condition of the road profile is a major factor influencing the response of the bridge to a passing vehicle (DIVINE 1998), simulations have been carried out for three different profiles independently for each of the two bridge lengths considered. The profiles were generated using the recommendations of ISO8608 (1995). This is a stochastic process described by a power spectral density function that varies depending on the road class from A ('very good') to E ('very poor'). Here only class A profiles have been analysed, which are assumed to represent well maintained highway pavements.

4.2 Results

Over 40,000 dynamic simulations were performed within the Monte Carlo simulation scheme described in section 4.1. A fleet of 77 crane-type vehicles and 77 5-axle trucks were studied for both spans under consideration. Each single vehicle was studied for a variety of speed and vehicle characteristics combinations. The bridge response is quite sensitive to the road surface. Due to the huge number of events gathered, the means and standard deviations of bending moment were found for each specific vehicle. The results, shown in Figure 5, correspond to the mean DAF for one particular profile. However the conclusions drawn are the same for all three profiles under investigation.

While there is considerable variation in DAF, it can be seen that the mean dynamic amplifications for the crane population are generally less than for the 5-axle truck fleet, and that a similar trend is observed for both bridge spans.

Figure 6 gives the standard deviations of DAF for each vehicle and shows that the variability in dynamic amplification due to vehicle properties is also smaller for cranes. Combining the results of Figures 5 and 6 it is shown that any confidence interval for DAF will tend to be significantly less for cranes than for 5-axle trucks.

When assessing a structure for the effects of traffic loads, it is clearly the extremely heavy vehicles that tend to govern, particularly cranes in the case of a simply supported bridge as the axle spacings are quite small. These results show that DAF for such extreme vehicles is considerably smaller and also less variable than DAF for the more common 5-axle truck.

In Figure 7 the results for the whole vehicle fleet are presented in histogram form, showing that the most frequent DAF values for cranes are smaller than for 5-axle trucks. In addition the smaller variability in crane values relates to the narrower shape of histograms. When results for both bridge spans are compared, there is greater scatter for the longer structure.

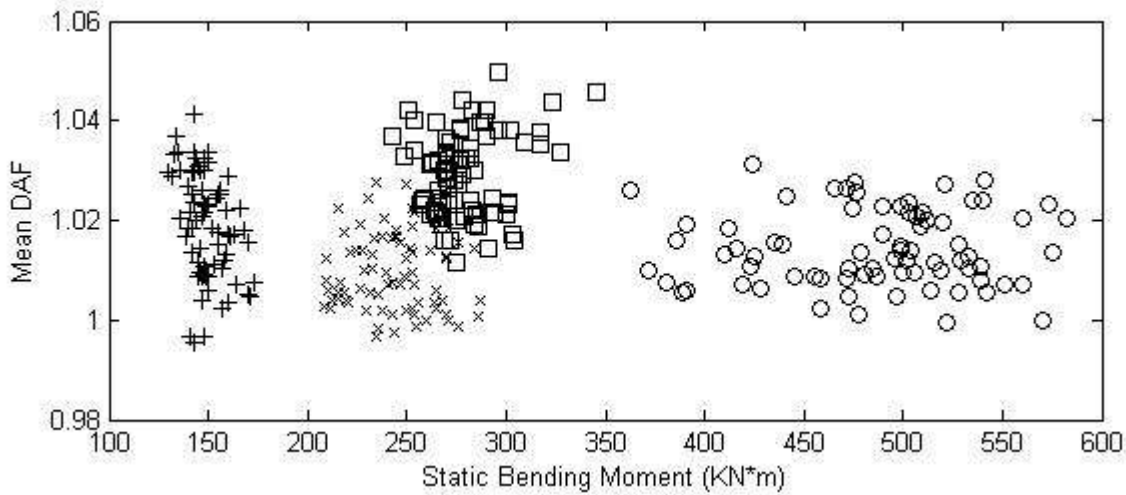

Figure 5. Mean DAF value for each vehicle. 5-axle & 15m (+), crane & 15m (x), 5-axle & 25m (□), crane & 25m(o).

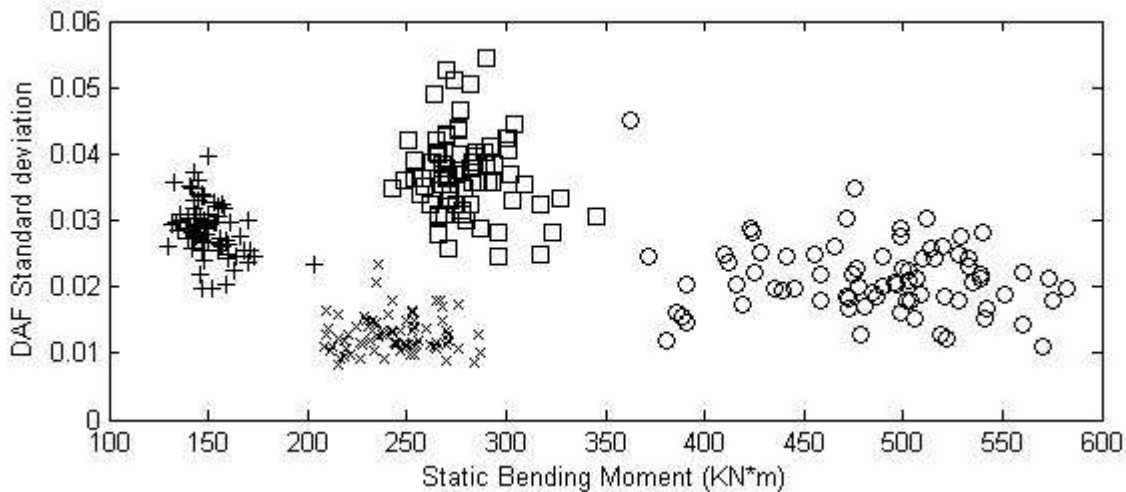

Figure 6. Standard deviation DAF value for each vehicle. 5-axle & 15m (+), crane & 15m (x), 5-axle & 25m (□), crane & 25m(o).

Table 2 presents the mean DAF values for the whole vehicle fleet results showing a significant reduction in dynamic amplification. Moreover, it shows that the value within a 95% confidence interval follows the same bias.

Table 2. DAF results summary

	15m		25m	
	mean	95%	mean	95%
5-axles	1.019	1.077	1.029	1.100
Cranes	1.010	1.035	1.014	1.056

Within the Monte Carlo simulation carried out in the investigation, typical values for air and steel suspen-

sions were considered. Figure 8 gives DAF for the range of suspension stiffness tested showing that softer suspensions originate smaller and less disperse dynamic effects on the bridge.

5 CONCLUSIONS

The growth of freight transport in recent decades is an important issue in Europe, and an increase of maximum allowed weight may be a possible solution to increase transport capacity. Heavy trafficked European highways are already recording the frequent crossing of overloaded vehicles that may be placing the health of a number of bridges in jeopardy and immediate attention is required. It also appears that any introduction of heavier vehicles will be less important for

bridge loading than these extreme vehicles already present in some highways. This paper has studied the dynamic effects on short to medium span highway bridges of these extreme heavy vehicles by means of a Monte Carlo simulation, and compared them to the more common 5-axle articulated truck. It has been shown that DAF mean and standard deviation values are significantly reduced.

ACKNOWLEDGMENTS

The authors would like to express their gratitude for the financial support received from the 6th European Framework Project ARCHES (Assessment and Rehabilitation of Central European Highway Structures) towards this investigation. The authors would also like to gratefully acknowledge the assistance of the Rijkswaterstaat Centre

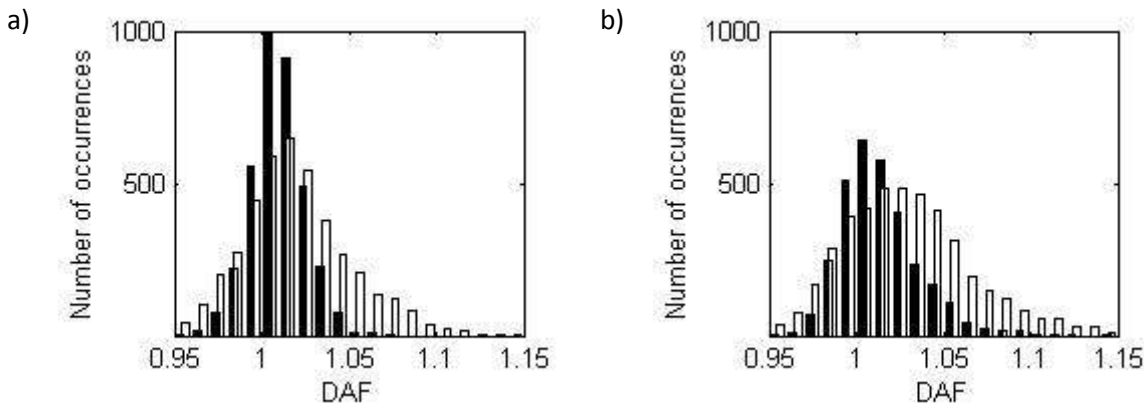

Figure 7. DAF histograms for cranes (Black) and 5-axle trucks (White). a) 15m span; b) 25m span.

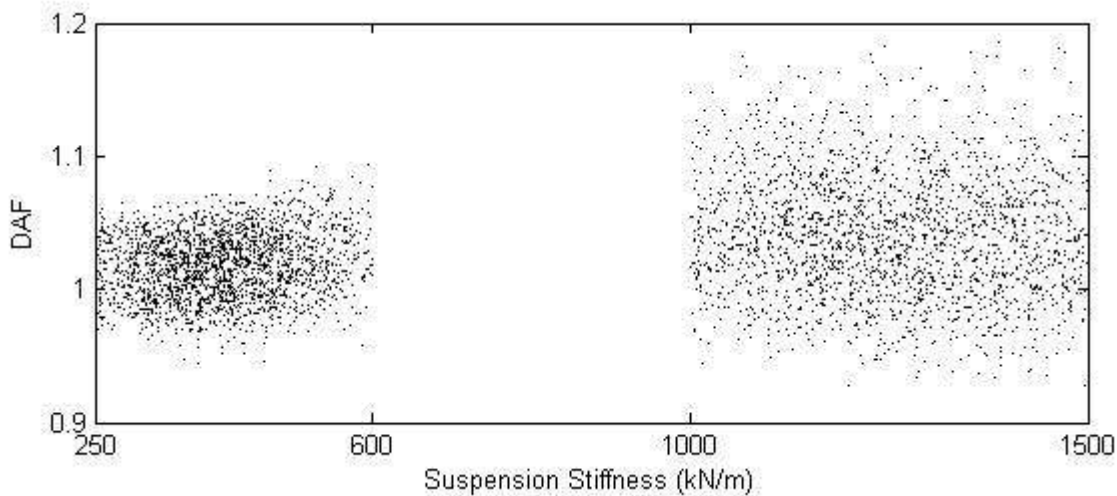

Figure 8. DAF for 5-axle trucks on 25 m bridge

for Transport and Navigation (DVS), an advisory institute of the Dutch Ministry of Transport, Public Works and Water Management in the Netherlands, who provided the WIM data.

REFERENCES

- Busby, H.R. & Trujillo, D.M. 1997. Optimal regularization of an inverse dynamics problem. *Computers & structures* 63(2):243-248.
- Cebon, D. 1993. Interaction between heavy vehicles and roads. *Society of automotive engineers* SP-951.

- DIVINE, 1998. *Dynamic interaction between vehicles and infrastructure experiment*. Organization for Economic Co-operation and Development. For further details see: www.oecd.org/dataoecd/9/22/2754516.pdf.
- Eurostat 2008. *EU energy and transport in figures*. Luxembourg: Office for official publications of the European communities. Full document at: <http://ec.europa.eu>.
- Fu, T.T. & Cebon, D. 2002. Analysis of truck suspension database. *International journal of heavy vehicle systems* 9(4):281-297.
- Gillespie, T.D., McAdam, C.C., Hu, G.T., Bernard, J.E. & Winkler, C.B. 1979. *Simulation of effects of increased truck size and weight*. Michigan: Ann Arbor.
- González, A., Rattigan, P., OBrien, E.J. & Caprani, C. 2008. Determination of bridge lifetime dynamic amplification factor using finite element analysis of critical loading scenarios. *Engineering structures* 30: 2330-2337.
- Green, M.F. & Cebon, D. 1995. Dynamic interaction between heavy vehicles and highway bridges. *Computers & structures* 62(2): 253-264.
- Harris, N.K., OBrien, E.J. & González, A. 2007. Reduction of bridge dynamic amplification through adjustment of vehicle suspension damping. *Journal of Sound and Vibration* 302(3):471-485.
- International Organization for Standardization 1995. *Mechanical vibration - Road surface profiles - Reporting of measure data*. ISO8608. (BS 7853:1996).
- Kirkegaard, P.H., Nielsen, S.R.K. & Enevoldsen, I. 1997. Heavy vehicles on minor Highway bridges – Dynamic Modelling of vehicles and bridges. Department of Building Technology and Structural Engineering, Aalborg University.
- Lehtonen, T., Kajjalainen, O., Pirjola, H. & Juhala, M. 2006. Measuring Stiffness and Damping properties of Heavy Vehicles. *Society of automotive engineers of Japan (FISITA)*:1-11.
- Li, H. 2005. Dynamic Response of Highway Bridges to Heavy Vehicles. PhD Thesis, Florida state university, USA. For further information see: <http://etd.lib.fsu.edu>.
- Naumoski, N., Cheung, M.S. & Foo, S. 2004. Dynamic performance of the Confederation Bridge due to traffic and wind. *Canadian journal of civil engineering* 31(3): 488-498.
- OBrien, E.J., & Keogh, D.L. 1999. *Bridge deck Analysis*. London: E & FN Spon.
- OBrien, E., Enright, B. & Caprani, C. 2008. Implications of Future Heavier Trucks for Europe's Bridges. *Transport research arena Europe*.
- Paultre, P., Proulx, P. & Talbot M. 1995. Dynamic testing procedure for highway bridges using traffic loads. *Journal of structural engineering* 121(2):362-376.
- Rowley, C.W. 2007. Moving force identification of axle forces on bridges. PhD Thesis, University College Dublin, Ireland.
- Ruiz-Terán, A.M. & Aparicio, A.C. 2007. Dynamic amplification factors in cable stayed-structures. *Journal of sound and vibration* 300:197-216.
- Savin, E. 2001. Dynamic amplification factor and response spectrum for the evaluation of vibrations of beams under successive moving loads. *Journal of Sound and Vibration* 248(2):267-288.
- Senthilvasan, J., Thambiratnam, D.P. & Brameld, G.H. 2002. Dynamic response of a curved bridge under moving truck load. *Engineering Structures* 24:1283-1293.
- Shampine, L.F. 1986. Some practical Runge-Kutta formulas. *Mathematics of computation* 46(173):135-150.
- Wang, T.L. & Huang, D. 1992. *Computer modelling analysis in bridge evaluation*. Miami: Florida international university.