



Technological University Dublin
ARROW@TU Dublin

Conference Papers

School of Manufacturing and Design
Engineering

2009-09-01

On-Line Realtime Water Quality Monitoring and Control for Swimming Pools

Paul Duffy

Technological University Dublin, paul.duffy@tudublin.ie

Gerard Woods

Technological University Dublin, gerry.woods@tudublin.ie

Sean O'hogain

Technological University Dublin, Sean.Ohogain@tudublin.ie

James Walsh

Technological University Dublin, james.walsh@tudublin.ie

C. Caplier

Follow this and additional works at: <https://arrow.tudublin.ie/engschmanconn>

 Part of the [Electro-Mechanical Systems Commons](#), and the [Manufacturing Commons](#)

Recommended Citation

Duffy, P., Woods, G., O'Hogain, S., Walsh, J., Caplier, C.: On-Line Realtime Water Quality Monitoring and Control for Swimming Pools. International Manufacturing Conference, Trinity College Dublin, Ireland, September, 2009.

This Conference Paper is brought to you for free and open access by the School of Manufacturing and Design Engineering at ARROW@TU Dublin. It has been accepted for inclusion in Conference Papers by an authorized administrator of ARROW@TU Dublin. For more information, please contact yvonne.desmond@tudublin.ie, arrow.admin@tudublin.ie, brian.widdis@tudublin.ie.



This work is licensed under a [Creative Commons Attribution-NonCommercial-Share Alike 3.0 License](#)



ON-LINE REALTIME WATER QUALITY MONITORING AND CONTROL FOR SWIMMING POOLS

P. Duffy¹, G. Woods¹, S. O'Hogain², J. Walsh³, C. Caplier³

1. School of Manufacturing and Design Engineering, Dublin Institute of Technology, Bolton Street, Dublin 1, Ireland.
2. School of Civil and Building Services Engineering, DIT, Bolton Street.
3. School of Physics, Dublin Institute of Technology, Kevin Street.

ABSTRACT

Effective swimming pool water quality monitoring and control systems are important to safeguard public health and for bather comfort. Most Irish swimming pool monitoring systems rely heavily on manual methods for sampling, testing and data recording of important parameters. Microbiological testing is infrequent and results can often take days. The goal of this research is to develop a water quality monitoring and control system with real time data logging, automatic data analysis, remote monitoring and control, microbiological sampling capabilities and online connectivity. National Instruments hardware and its software package LabView form the basis of the monitoring and control system. Several sensors measure the main water parameters affecting disinfection and overall water balance: temperature, pH level, total dissolved solids, turbidity, chlorine level and redox potential. Water hardness is measured manually due to the prohibitive cost of an automatic system. The LabView package and related hardware controls the chemical dosing of the pool in order to maintain these parameters within their recommended optimum levels. An investigation is also being carried out into the development of a biosensor to detect E. coli, as it is the best indicator of faecal contamination in water. The flexibility of the technology used in this research means that it has numerous other potential applications, such as: drinking water treatment, waste water treatment, industrial process control, environmental study and monitoring.

1. INTRODUCTION

At present there is a lack of uniformity in the swimming pool sector, not only in Ireland, but in the U.K. and further afield. This is due to two main factors. Firstly there are no legally binding guidelines for pool operation methods, only recommendations for 'best practice'. Secondly there is no cohesive method in place for collecting and collating data from different pools. All bathing areas in Ireland must meet the minimum quality standards set out in the 2006 E.U Directive on Bathing Waters ^[1]. The Department of Environment, Heritage and Local Government, through the Environmental Protection Agency (EPA), is responsible for monitoring the quality of water in all public bathing water areas. Health and safety officers from the H.S.E are often involved in monitoring local authority pools. Private swimming pools are not currently subject to any statutory quality requirements.

Any system with automatic data logging of critical parameters and online connectivity will no doubt provide a platform for rationalisation. It will mean that inspections by relevant authorities e.g. HSE or I.L.A.M can be simplified and regularised. It will provide swimming pool owners with ready made data to strengthen applications for hygiene awards such as the White Flag award. The system also has the ability to reassure the end user by providing detailed performance on pools. Similar systems are currently available on the market, such as the

Chemtrol PC600 Controller and the Polaris 4 Function Controller E1. The Chemtrol controller offers limited data analysis but it is a factory sealed unit with no room for expansion, while the Polaris offers room for expansion but no data analysis. Neither controller can be programmed with the ease nor precision offered by a LabView software based controller and neither offers the same potential for data logging, analysis and access. Also these controllers do not have the option for a turbidity or microbiological sensor to be included.

1.1 Background and Theory

The goal of any pool operator should be to achieve a good water balance. Chemical values must be right for disinfection, safe for swimming and good for pool materials. The main source of pollution in any pool is from the bathers themselves. Pollutants deposited by bathers into the pool include: sweat, urine, mucus from nose and chest, saliva, hair, cosmetics and scales from skin and faecal matter. Such pollutants cause microorganisms to be introduced to the pool. There has been a number of disease outbreaks linked directly to swimming pools including E. coli, Cryptosporidium parvum and Naegleria fowleri.

In order to prevent disease outbreaks it is necessary to continually disinfect the pool water. The most common form of disinfectant used is calcium hypochlorite. The effectiveness of the disinfectant is not solely dependent upon the concentration dosed. Water temperature, pH and turbidity all affect the ability of the disinfectant to destroy microorganisms.

The more turbid the water the more particles there are to shield microorganisms from the disinfectant. The disinfectant destroys microorganisms by an oxidation reaction. Due to the varying rate of pollutant introduction to the pool a quantitative measure of chlorine level is not sufficient to provide efficient operation. An ORP probe measures the oxidation reduction potential (redox potential) in the pool. Redox potential gives a qualitative measurement of the effectiveness of the disinfectant. A redox reading of below 700mV indicates poor disinfection in the pool, regardless of chlorine concentration.

Water hardness and total dissolved solids outside of recommended ranges can cause damage to pool materials. A TDS of above 1000mg/l or a hardness value of below 40mg/l as CaCO₃ can lead to corrosion of pool materials. A hardness level of above 150mg/l as CaCO₃ can cause scaling to occur.

The following table summarises the chemicals and control methods selected for each of the pool parameters:

Parameter	Increase	Decrease
Temperature	Heater on	Heater off
Chlorine Level	Add Ca(ClO) ₂	Dilute with source water
pH Level	Add NaHCO ₃	Add HCl
TDS Level	n/a	Dilute with source water
Turbidity	n/a	Add Al ₂ (SO ₄) ₃
Hardness	Add CaCl ₂	Dilute with source water

Table 1 – List of Pool Water Parameters

1.2 System Overview

An overview of the proposed monitoring and control system is shown in Figure 2. The pool circulation system has been simplified somewhat for the purpose of clarity.

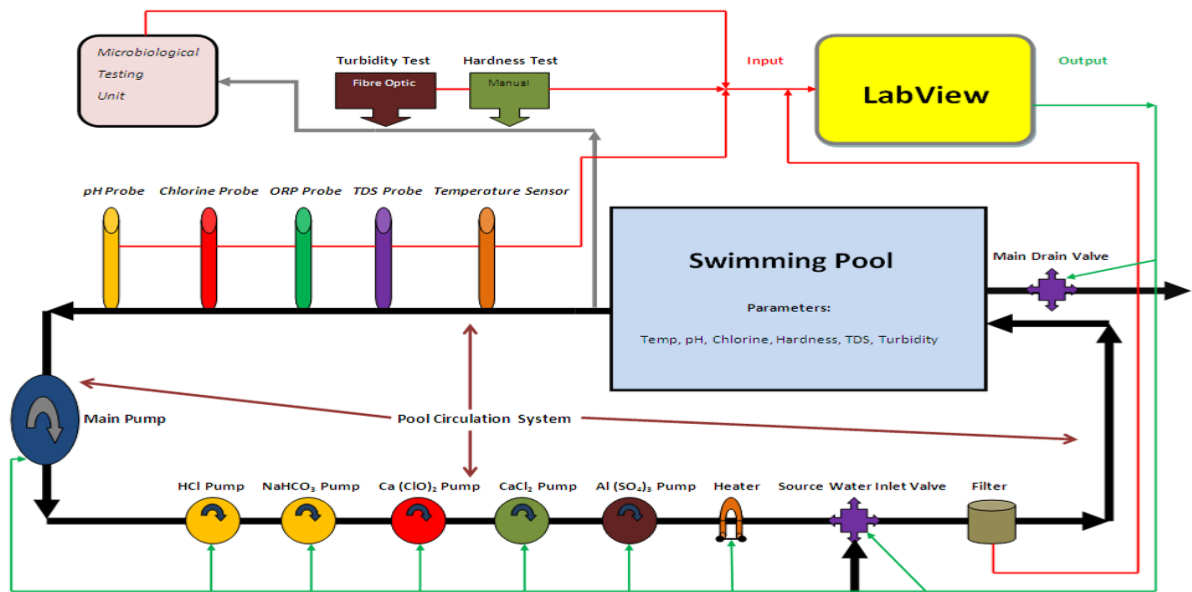

Figure 2 – Pool Operating System Overview

The system has a total of 9 inputs and 9 outputs. The pool circulation system has been mimicked by the use of a scaled rig. An overview of the test rig is shown in Figure 3. Due to the low flow rate of the rig circulation system it was decided to not include a filter in the rig. However the use of the system to control filter backwashing will be simulated using a series of switches.

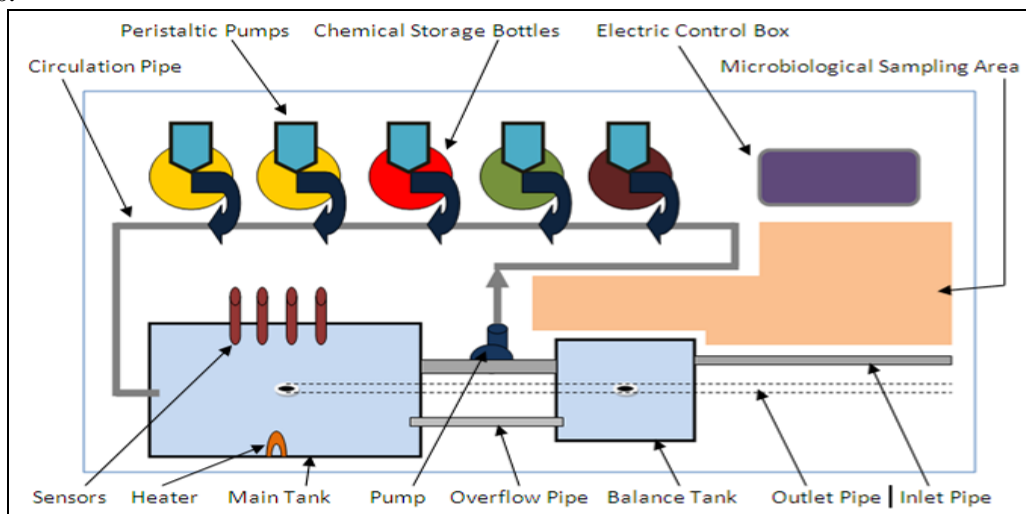

Figure 3 – Test Rig Overview

A National Instruments Compact Rio 9023 embedded controller was selected to operate the test system. Five modules were selected to be used with the controller – a 32 channel analog input module, a 32 channel output module, an eight channel digital input module, an eight channel digital output module and a 4 channel thermocouple module. The Compact Rio once programmed in LabView can function independently of a P.C. Data can be downloaded periodically to free up memory or continually via an Ethernet link.

2. ELECTRONIC CIRCUITRY

2.1 Pump Speed Control

Peristaltic pumps were selected for the chemical dosing process. The variable speed pumps selected each draw ~200mA at start up. The analog output channels of the Compact Rio controller each provided a maximum of 20mA. The control circuit shown in Figure 4 was designed to overcome this problem. Initial tests will be carried out using the digital outputs and simple rated on/off control. The performance of this control method will then be compared to proportional control using the analog outputs and the control circuit below.

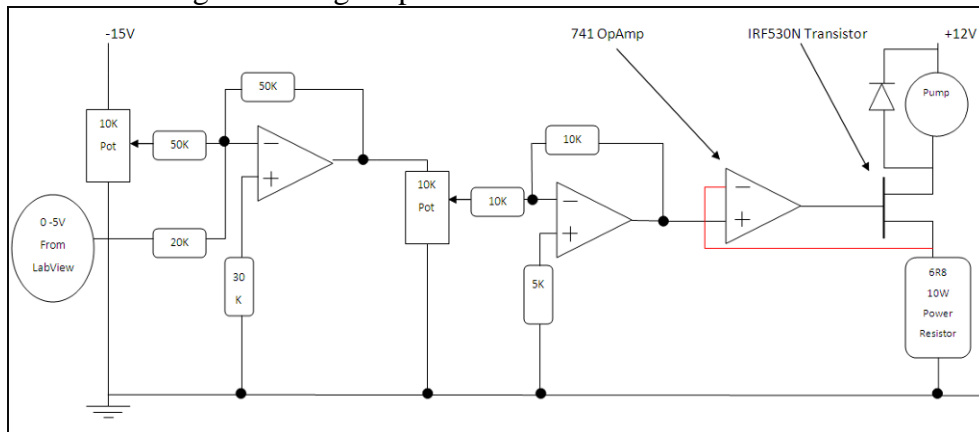

Figure 4 – Pump Speed Control Circuit

2.2 Probe Signal Amplification

The voltage output from the pH and Chlorine probes was found to be too small to provide accurate and repeatable measurements. A Laplace Instruments VIP 20 low level signal amplifier was selected to improve the output signal from the probes. Using an amplifier gain of 500 and signal processing within LabView a pH voltage relationship of 0.1V/pH unit was achieved. The control system requires an accuracy of 0.1pH units or 0.01V. The signal noise was found to be approx 0.0005V which was sufficiently small to enable this accuracy. Using the same signal processing, but a smaller amplifier gain of 200, a similarly accurate signal output was achieved for the Chlorine probe.

However the amplifier chosen may prove prohibitively expensive for real world implementation of this system. There are numerous designs of other amplifier circuits available for both pH and Chlorine probes. An example of such a circuit is shown in Figure 5. It is planned to build and test a selection of these designs in order to find an inexpensive, high performance replacement for the amplifier currently being used.

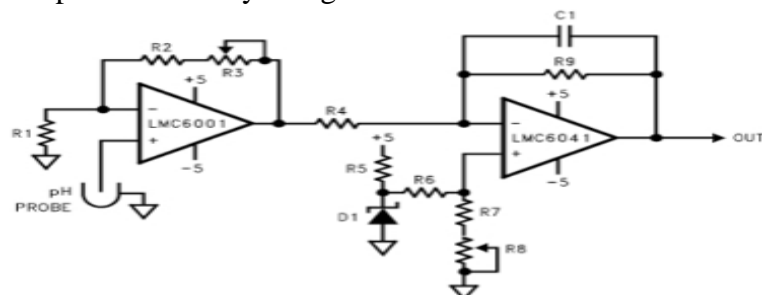
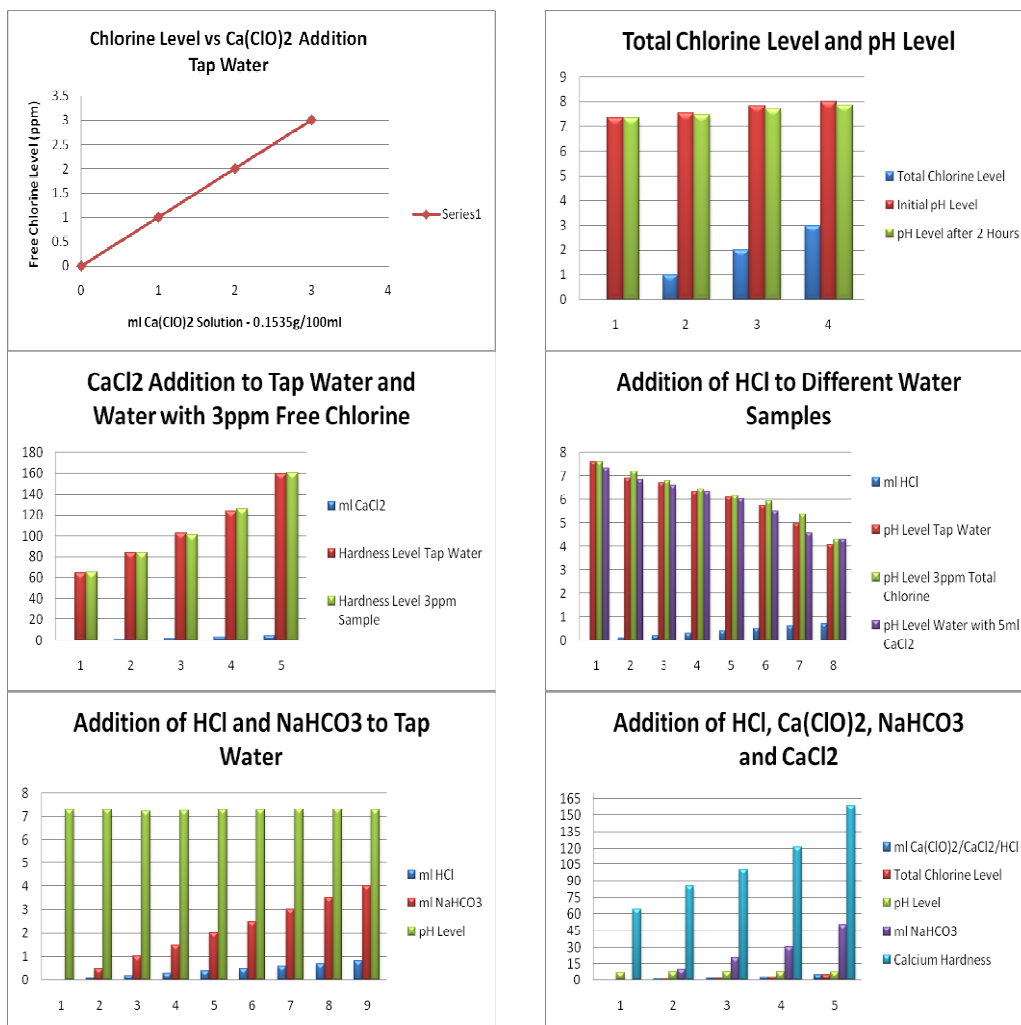

Figure 5: pH Probe Amplifier Circuit [2]

3. CHEMICAL EXPERIMENTS

A series of experiments were performed to confirm that the calculated chemical dosages were correct and to deduce their effects on relevant water parameters and each other. It was decided not to include aluminium sulphate in these tests as it will only be dosed occasionally. The following graphs illustrate some of the results obtained from these experiments.



Figures 6,7,8,9,10,11 – Graphs of Experimental Results

The experiments confirmed that the calculated dosages were correct and that, with the exception of Ca(ClO)₂, each chemical affected only its relative parameter. Ca(ClO)₂ was found to increase water pH by approx 0.2pH units/ml Ca(ClO)₂ added. This rise in pH can be offset by addition of HCl reduce levels to within the optimum operating pH range for disinfection of 7.2 to 7.6. NaHCO₃ can also be added to stabilise the solution. The solutions selected for each chemical are shown in Table 2:

Chemical	Concentration	Parameter Control
Ca(ClO) ₂	0.1535g/cm ³	Chlorine Level
HCl	0.1M	pH/Alkalinity
NaHCO ₃	1.4002g/cm ³	pH/Alkalinity
CaCl ₂	2.7672g/100cm ³	Calcium Hardness

Table 2 – List of Chemical Concentrations

4. ESCHERICHIA COLI AND TURBIDITY DETECTION

Research is currently ongoing into an optical fibre based sensor which can firstly be used as a turbidity meter and secondly to investigate its potential to selectively detect E. coli in water. Table 3 shows a summary of various E. coli detection methods using different forms of biosensors. The methods chosen were those that showed the best limit of detection for that particular method. While some show extremely good limits of detection they cannot selectively sense for E. coli in the presence of pollutants or other bacteria. Also some methods, such as sensing using glassy carbon electrodes, are ‘one shot’ systems with poor sensor storage times.

Method	Description	L.O.D.	Detection Time	Ease of Use
Glassy Carbon Electrode ^[3]	Electrochemical detection of GUD activity (enzyme)	2 CFU/100ml	~ 20 min	Good
Bio-Optical Signature ^[4]	Laser produced MALS to generate BOS detected using a solid state detector	10 – 100 CFU/ml	~ 5 min	Excellent
Tapered Optical Fibre with SYBR 101 dye ^[5]	Nucleic acid synthesis on fibre surface detects LacZ gene	35 ng of ssDNA	> 2 min	Extremely Poor
8 Channel Bulk Acoustic Wave Impedance Physical Biosensor ^[6]	BAW monitors culture medium conductivity which is changed by the growth of bacteria	100 CFU/ml	~ 900 min	Average
Cartridge Based UV Fibre Optic Spectrophotometry ^[7]	Detection of GUD and GAD by formation of fluorescent molecules	< 1 CFU/100ml 10 ³ CFU/100ml	18 hrs ~ 11.5 hrs	Excellent
Antibody Immobilized Biconical Tapered Optical Fibre ^[8]	Measurement of change in transmitted light due to changes in the evanescent field	70 cells/ml	~ 10 min	Average

Table 3 – Summary of E. coli detection methods

Initial E. coli testing was based on the Beer-Lambert Law ^[9] –

$$A = \epsilon bc$$

where A = absorbance

ϵ = molar absorptivity

b = path length of sample

c = concentration of compound in solution

4.1 Escherichia coli Experimentation

Preliminary tests were performed using Escherichia coli ATCC 25922 strain to quantify the current limitations of nephelometric techniques to detect E. coli. Two samples with an initial estimated concentration of 3×10^8 cfu/ml of the test strain was made using McFarland Standard Number 1. A series of 10 fold dilutions were then performed from 3×10^8 down to 3×10^0 for each initial sample. Each 5ml sample was placed in an Ocean Optics 3000 spectrophotometer and readings of its transmittance and absorbance were taken. Cultures were made of each sample and incubated overnight. A count of the cfu/ml of each sample was then performed to verify the initial concentrations were correct. It was then possible to make a correlation between E. coli concentration and absorbance. It was found that taking absorbance readings at 488nm the limit of detection was 10^5 cfu/ml of E. coli. The graph illustrates how absorbance varies with E. coli concentration.

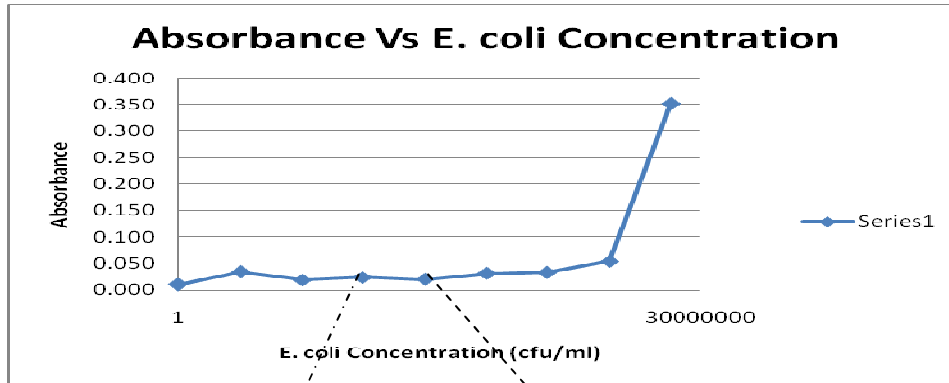
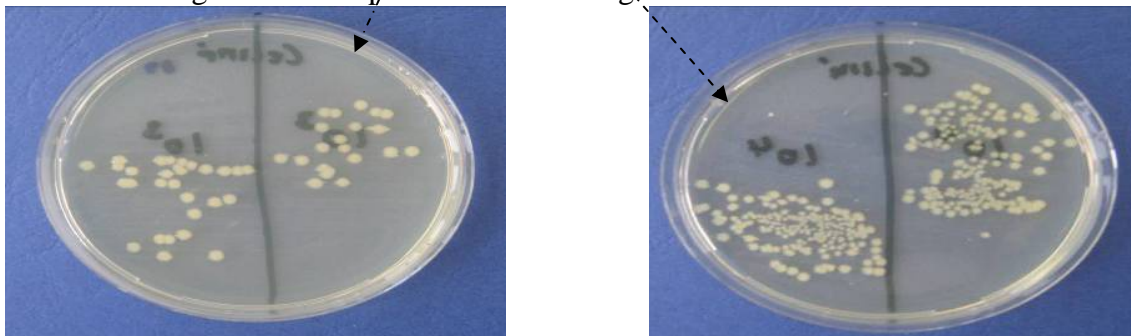

Figure 12 – Graph of Absorbance against E. coli Concentration



Figures 13 and 14 – Images of Cell Cultures with Concentrations of 10^3 and 10^4 cfu/ml

Further research is being carried out into the use of recombinant Enhanced Green Fluorescent Protein (EGFP) as a possible marker for E. coli in aqueous solutions. The EGFP fluoresces when excited by light at a wavelength of 488nm and emits light at a wavelength of 507nm. Previous research carried out by researchers at Purdue University, U.S.A. indicates that it is possible to use EGFP in this way^[9]. The intensity of light emitted by the EGFP would provide a direct correlation to the amount of E. coli present.

4.2 Optical Fibre Turbidity Sensor

Turbidity is an important pool water parameter. Not only does turbid water look unappealing to the bather but it can also cause a decrease in the effectiveness of the disinfectant agent. Turbid water can be an indicator of increased water pollution and of poor filtration. Currently manual tests are carried out for turbidity in most pools with the maximum recommended turbidity level being 0.5 NTU (nephelometric turbidity units). Preliminary work is being carried out on the design of a turbidity sensor for swimming pools. The system will work on a catch and release basis consisting of an LED light source, a feed and a return fibre and an analyser. The intensity of the light transmitted through the sample will be measured and correlated to a turbidity value. Figure 15 shows an outline of the proposed system.

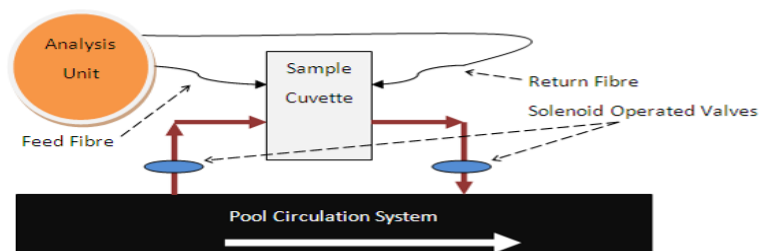

Figure 15 – Turbidity Sensor Outline

5. CONCLUSIONS AND FURTHER WORK

A suitable test rig has been designed which will accurately model the operation a swimming pool, incorporating a National Instruments Compact Rio 9023 embedded controller. Accurate relationships between water parameters and chemical dosing agents have been established. These are effectively linear relationships and can be easily integrated into the control system. The use of fibre optics as both a biosensor and turbidity sensor has shown potential.

Extensive testing of the control system is required using both rated and proportional dosing pump control. Standard pollutants will be introduced by both gradual and shock dosage methods to evaluate the system response. Further dialogue with the relevant authorities needs to be opened in order to develop the best possible data analysis. Trialling of system control via remote computer and mobile phone also needs to be undertaken. Further refinement of the current fibre optic E. coli detection system is needed to increase sensitivity. This will include both physical changes to the test rig, such as different light sources, and also further post processing of results. Following this, experimentation with the incorporation of EGFP to increase system selectivity will be conducted.

The prototype turbidity sensor outlined previously will be constructed. Testing of the system will include the use of different light sources and fibre optics (both off the shelf and laboratory made). A comparison of this method of turbidity measurement against a cost comparable vision system will be made.

Upon completion of the above application further investigation will be carried out into applications in drinking water monitoring and waste water treatment.

6. REFERENCES

- [1] Bathing Water Quality Regulations 2008 (SI no. 79 of 2008)
- [2] <http://www.electro-tech-online.com/attachments/general-electronicschat/12894d1179440753-question-about-lmc6001-ph-probe-amplifier-circuit-ph-probe-amp.jpg> - Website
- [3] B. Pletschke et al Online real-time enzymatic biosensor system for the rapid detection of faecal contamination in water intended for drinking purposes, *WRC Report 1603/1/08*, ISBN 978-1-77005-670-1
- [4] J. A. Adams et al Real-time, online monitoring of drinking water for waterborne pathogen contamination warning, *International Journal of High Speed Electronic Systems* Vol.17(2007) 643 – 659
- [5] A. Almadidy et al A fibre optic biosensor for the detection of microbial contamination *Canadian Journal of Chemistry* Vol.5(2003) 339 -349
- [6] J. Zhao et al Rapidly determining E. Coli and P. aeruginosa by an eight channels bulk acoustic wave impedance physical biosensor *Sensors and Actuators B* 107(2005) 271-276
- [7] Brown et al Detection of biological molecules by differential partitioning of enzyme substrates and products *United States Patent 7,402,426 WO/2004/027084*
- [8] K. Rijal et al Detection of pathogen Escherichia coli O157:h7 at 70cells/ml using antibody-immobilized biconical tapered fiber sensors *Biosensors and Bioelectronics* Vol.25(2005) 871-880
- [9] J. D. J. Ingle and S. R. Crouch, *Spectrochemical Analysis*, Prentice Hall, New Jersey (1988)
- [10] K. Hanyou et al A molecular beacon DNA microarray system for rapid detection of E. coli O157:H7 that eliminates the risk of a false negative signal, *Biosensors and Bioelectronics* Vol.22 (2007) 1041-1047