



Technological University Dublin
ARROW@TU Dublin

Conference Papers

Antenna & High Frequency Research Centre

2013-04-08

A Compact Shorted Printed Monopole Antenna for TV White Space Trials

Matthias John

Technological University Dublin, matthias.john@tudublin.ie

Max Ammann

Technological University Dublin, max.ammann@tudublin.ie

Follow this and additional works at: <https://arrow.tudublin.ie/ahfrcon>



Part of the [Systems and Communications Commons](#)

Recommended Citation

John, M. & Ammann, M.J. (2013) A Compact Shorted Printed Monopole Antenna for TV White Space Trials, *European Conference on Antennas and Propagation - EuCAP*, Gothenburg, Sweden, 08/04/2013, doi:10.21427/D7B01P

This Conference Paper is brought to you for free and open access by the Antenna & High Frequency Research Centre at ARROW@TU Dublin. It has been accepted for inclusion in Conference Papers by an authorized administrator of ARROW@TU Dublin. For more information, please contact yvonne.desmond@tudublin.ie, arrow.admin@tudublin.ie, brian.widdis@tudublin.ie.



This work is licensed under a [Creative Commons Attribution-NonCommercial-Share Alike 3.0 License](#)



A Compact Shorted Printed Monopole Antenna for TV White Space Trials

Matthias John¹ and Max J. Ammann²

¹ CTVR – the Telecommunications Research Centre, Trinity College Dublin, Dublin 2, Ireland, johnm@tcd.ie

² Antenna & HF Research Centre, Dublin Institute of Technology, Dublin 8, Ireland, max.ammann@dit.ie

Abstract—This paper presents a compact shorted printed monopole antenna for machine-to-machine, remote sensing and rural wireless applications in the TV whitespace band from 470 MHz to 862 MHz. The antenna's performance in this operating band is demonstrated.

Index Terms—printed monopole; TV white space;

I. INTRODUCTION

The switch-off of analogue TV transmission has sparked interest in the wireless communication communities to re-use that spectrum. It is envisioned that the TV white space (TVWS) frequency range is liberated for unlicensed use. Analogue TV broadcasting in Europe was allocated frequencies from 470 MHz to 862 MHz [1]. The digital terrestrial television (DTT) is more spectrum efficient and thus large parts of the spectrum are freed.

Applications like machine-to-machine, remote metering and rural wireless broadband (Wireless Regional Area Networks, IEEE 802.22 working group) will benefit greatly by the use of the TVWS spectrum because propagation conditions at these frequencies are superior to those currently used for GSM or 3G. For these applications, devices will utilise spectrum-sensing cognitive radios [2] to find unused portions of the spectrum and avoid interference with other services. Therefore, compact, wide-band antennas with an omnidirectional radiation pattern are required.

Terrestrial TV antennas for these frequencies are mainly large, directive yagi like antennas deployed on rooftops or loop and whip antennas for indoor use. Monopole antennas include sleeve-cage monopoles [3] or printed monopoles [4, 5]. For mobile use, recent publications on antennas covering this frequency range include printed monopoles [4], bow-tie [6] and 3D structures [7]. Reconfigurable antennas [8, 9], albeit being more compact, require re-tuning to cover the whole band.

Of these recent previous publications, the printed monopole [4] measures 200 mm × 40 mm and covers 530–3000 MHz. The printed bow-tie [6], 150 mm × 150 mm, 785–2500 MHz. The Compact 3D antenna [7], 77 mm × 37 mm × 45 mm, covers the same frequency range of 470–862 MHz targeted in this paper but sacrifices efficiency (14%) and requires matching components.

This paper presents a compact shorted printed monopole antenna with an omnidirectional radiation characteristic for

use on spectrum-sensing software-defined-radio equipment to be employed in upcoming TVWS trials in Ireland.

II. ANTENNA DESIGN

The antenna is designed on a 160 mm × 170 mm double-sided FR4 substrate of 1.52 mm thickness with a dielectric constant of $\epsilon_r = 4.3$. The rectangular groundplane on the back is 84 mm high and covers the full width of the substrate. The spline shaped radiating element on the front of the substrate is 69 mm × 145 mm. There is a feed gap of 7 mm, with a raised, shape-optimised matching section on the groundplane behind the feedline. The shorting stub is located 20 mm from the feedline and connected by a via to the groundplane on the back. The antenna is fed by a 50 Ω SMA connector.

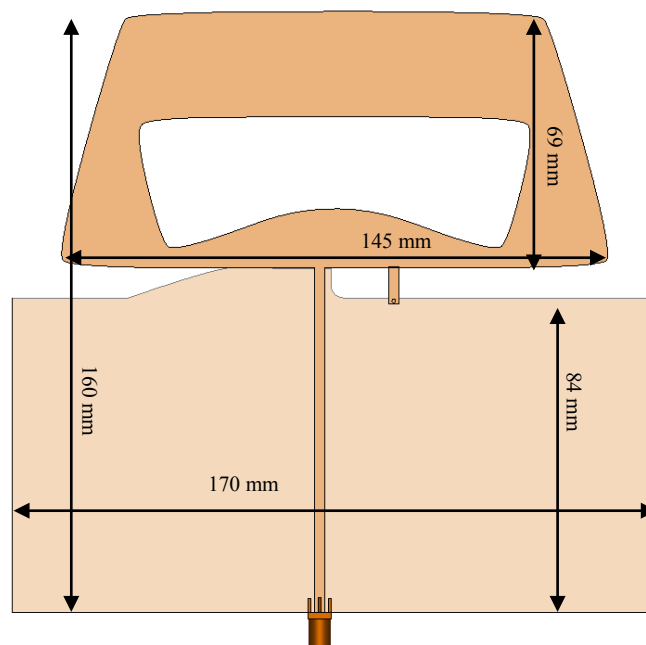

Figure 1. Geometry and dimensions of the printed monopole antenna.

The radiating element of the antenna was designed using a spline-shaped outline and cut-out. The geometry was optimised using CST Microwave Studios trust region framework optimiser and time domain solver.

The shape of the cut-out allows for wide band impedance matching by adjusting internal capacitance, while the position of the cut-out defines the width and thus inductance of the lower horizontal strip-width at the feed region.

A portion of the groundplane is extended behind the feedline and curves away in a smooth transition from the feed point to the edge of the groundplane. This raised section improves the wide band impedance match dramatically.

Fig. 2 illustrates the effect of the cut-out and the raised ground on the S11 response of the antenna. The cut-out is improving the lower operational frequency while maintaining the wide bandwidth. The blue curve shows a version of the antenna with a solid radiation element, without the cut-out. The lower edge frequency of this antenna is 524 MHz. Therefore, the addition of the cut-out improves the lower frequency by 54 MHz.

The green curve shows the antenna with a straight ground plane without the raised section behind the feedline. It is observed that the bandwidth is only 60 MHz, although starting from 450 MHz. Careful tuning of the shape of this raised ground element improves the matching across a wide bandwidth.

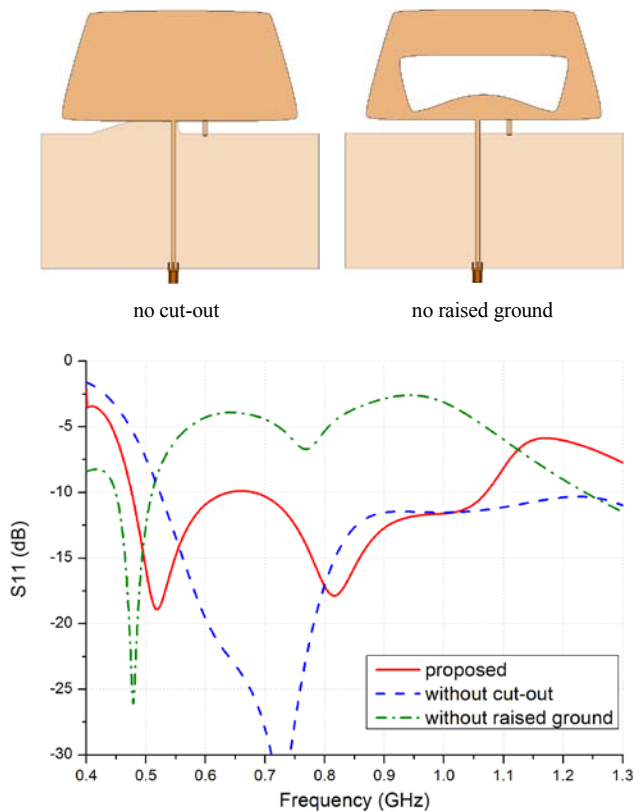

Figure 2. Simulated effect of cut-out and raised ground on the S11 of the antenna.

III. RESULTS

Simulated and measured S11 results are shown in Fig. 3, and are in good agreement. The antenna is well matched between 470 MHz and 1050 MHz.

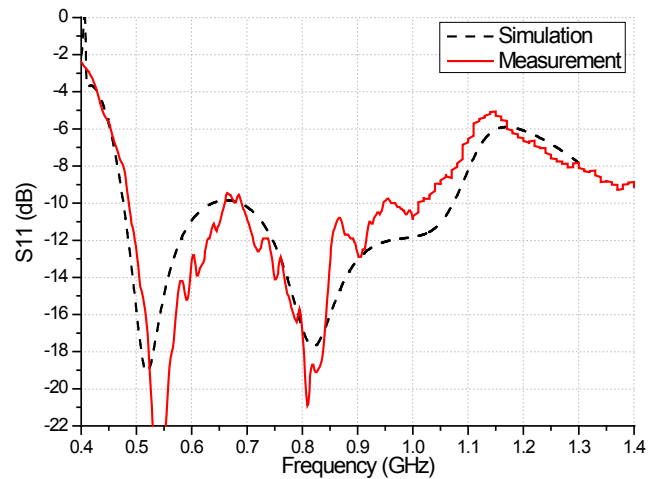

Figure 3. Simulated and measured S11 of the antenna.

Radiation patterns of measured realised gain of the antenna are shown in Figures 4 – 6 for 500 MHz, 700 MHz and 900 MHz. A good omnidirectional radiation characteristic in the azimuth plane is observed, making the antenna suitable for the applications mentioned in Section I. The elevation pattern ($\theta=0^\circ$) shows a typical monopole null. In the elevation pattern ($\theta=90^\circ$) there is an asymmetry observed due to the asymmetrical feed and shorting post.

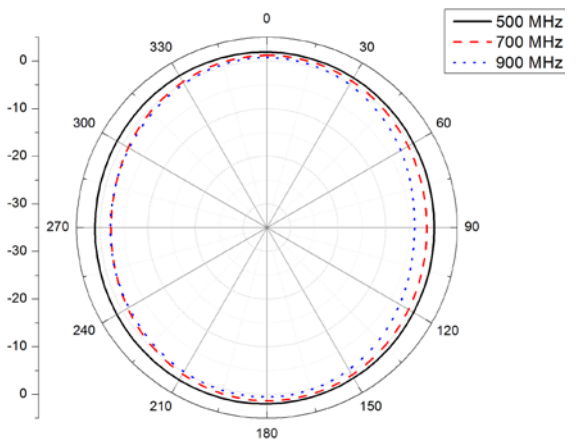

Figure 4. Azimuth plane radiation pattern at 500 MHz, 700 MHz and 900 MHz.

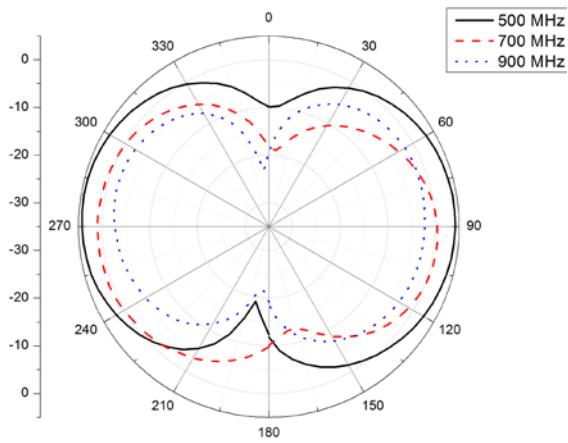

Figure 5. Elevation plane $\theta = 0^\circ$ plane radiation pattern at 500 MHz, 700 MHz and 900 MHz.

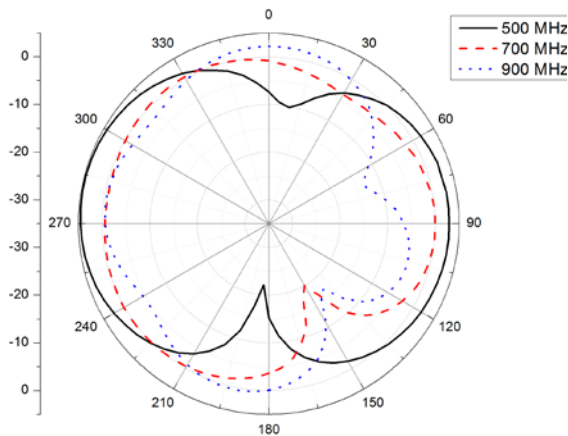

Figure 6. Elevation plane $\theta = 90^\circ$ radiation pattern at 500 MHz, 700 MHz and 900 MHz.

Realised gain and total efficiency are shown in Fig. 7. The antenna has a moderate gain between 2 and 4 dBi and is highly efficient throughout the operating band.

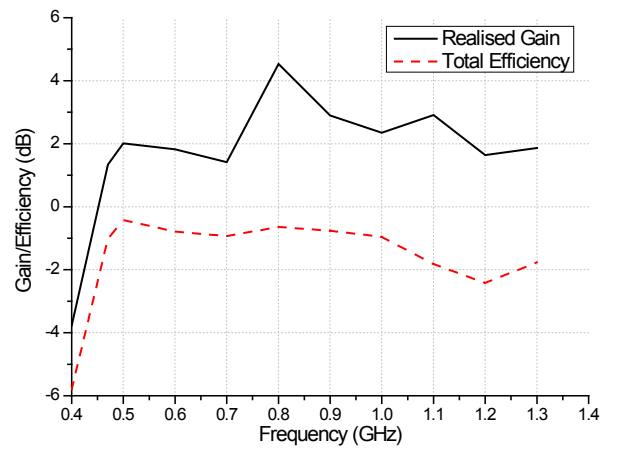

Figure 7. Realised gain and total efficiency of the antenna.

IV. CONCLUSION

A compact, shorted printed monopole antenna was presented for use in TVWS devices. The antenna was demonstrated to operate in the 470 MHz to 1050 MHz band with good radiation performance and high efficiency.

V. ACKNOWLEDGEMENTS

This material is based upon works supported by the Science Foundation Ireland under Grant No. 10/CE/11853.

REFERENCES

- [1] Electronic Communications Committee, "The European Table of Frequency Allocations and Applications in the Frequency Range 9 kHz to 3000 GHz," ECR Report 25, 2011.
- [2] J. Lotze, S. A. Fahmy, J. Noguera, L. E. Doyle, "A Model-based Approach to Cognitive Radio Design," in *IEEE Journal on Selected Areas in Communications*, vol. 29, no. 2, February 2011, pp. 455-468.
- [3] S.D. Rogers and C.M. Butler, "The sleeve-cage monopole and sleeve helix for wideband operation," *Antennas and Propagation Society International Symposium*, 1999, vol.2, pp.1308-1311.
- [4] W.S. Chen, Y.T. Chen, H.T. Chen and J.S. Kuo, "A Wideband Printed Monopole Antenna for Wireless Applications," *Antennas and Propagation Society International Symposium*, 2009, pp.1-4.
- [5] C.-Y. Huang, B.-M. Jeng and C.-F. Yang, "Wideband monopole antenna for DVB-T applications," *Electronics Letters*, vol. 44, no. 25, Dec 2008, pp. 1448-1450.
- [6] S. Raut and A. Petosa, "A Compact Printed Bowtie Antenna for Ultra-Wideband Applications," *European Microwave Conference 2009*, pp. 81-84.
- [7] X. Liang, R. Jin, Y. Zhao, and J. Geng, "Compact DVB-T printed monopole antenna," *International Workshop on Antenna Technology (iWAT)*, 2010, March 2010
- [8] X. L. Bao, S. V. Shynu, and M. J. Ammann, "Design of a Tunable Compact Antenna for Digital Video Broadcasting Handheld Terminals," *Loughborough Antennas & Propagation Conference*, Loughborough, UK, 2009, pp. 461-464.
- [9] D.H. Choi, Y.T. Im, Y.J. Cho, and S.O. Park, "A Tunable Antenna for DVB-H Applications," *IEEE Antennas and Wireless Propagation Letters*, Vol. 6, 2007, pp.515-517