Other Resources

Languages

2010

Peer Assisted Learning for International Business and Languages Students

Odette Gabaudan

Technological University Dublin, odette.gabaudan@tudublin.ie

Maria-Jose Gonzalez

maria-jose.gonzalez@tudublin.ie

Follow this and additional works at: <https://arrow.tudublin.ie/aaschlanoth>



Part of the [Curriculum and Instruction Commons](#), and the [Higher Education Commons](#)

Recommended Citation

Gabaudan, O.; González M.J. (2009). Peer Assisted Learning for International Business and Language Students. Technological University Dublin Teaching Fellowship Report 2009-2010, 6-13.

This Report is brought to you for free and open access by the Languages at ARROW@TU Dublin. It has been accepted for inclusion in Other Resources by an authorized administrator of ARROW@TU Dublin. For more information, please contact yvonne.desmond@tudublin.ie, arrow.admin@tudublin.ie, brian.widdis@tudublin.ie.



This work is licensed under a [Creative Commons Attribution-Noncommercial-Share Alike 3.0 License](#)

**DIT Teaching Fellowship Reports
2009–2010**

Contents

Foreword.....	2
Summary Overview of Projects.....	3
Teaching Fellowship Reports	
Faculty of Applied Arts	
Peer Assisted Learning Project	
<i>M-J. Gonzalez and O. Gabaudan</i>	6
Faculty of Built Environment	
Building Information Modelling Incorporating Technology Based Assessment	
<i>M. Murphy and L. Scott</i>	15
Formative Assessment Structures in First and Second Year Architectural Technology to Enhance Student Learning	
<i>C. Prunty and M. Crean</i>	23
Faculty of Business	
Action Accounting ‘Untying the Accountancy Knot’	
<i>A. Luby</i>	32
Curriculum Development for Delivery of a Standardised Business Research Methods Module	
<i>C. Horan</i>	39
Faculty of Engineering	
Improving the Quality of PBL Modules in an Engineering Programme	
<i>G. Duffy</i>	46
Improving Core Mathematical Skills in Engineering Undergraduates	
<i>M. Carr</i>	51
Faculty of Science	
Development of Student Centred Physics Labs from Years 1 to 4	
<i>R.Howard</i>	59
An Examination of the Use of Blended Learning to Support Improvement of Engagement and Retention of Part-time Postgraduate Level Students using Student Edited Podcasts	
<i>D. Lawless and D. Gordon</i>	65
Faculty of Tourism	
Get Smart! An Evaluation of an Initiative in Personal and Professional Development among First Year Undergraduates	
<i>M. O’Rawe</i>	69
Developing a Pedagogic Approach to Enhance Student Learning Before, During and After International Work Placement	
<i>F. Cullen</i>	76
Teaching Fellowship 2009-2010 Dissemination Outputs.....	82
Appendices.....	86

Teaching Fellowships were generously funded through the HEA SIF 2 – DRHEA project



Foreword

The DIT Annual Teaching Fellowships were established in 2009 as part of cycle II of the HEA's Strategic Innovation Funded Enhancement of Learning (EoL) strand of the Dublin Region Higher Education Alliance (DRHEA). This partnership Alliance of eight universities and Institutes of Technology across the wider Dublin region was awarded funding for a range of collaborative activities, with the aim of sharing expertise and creating economies of scale in their efforts to address strategic needs in Teaching and Learning, Graduate Education, Internationalisation and Widening Participation.

The aim of the DIT Teaching Fellowships was to support key faculty based educational research projects linked to the wider Institute Enhancement of Learning strategy themes. The title of 'Teaching Fellow' was to be awarded to an individual or a team, nominated by the faculty and who would undertake a research project to support the enhancement of learning and/or curriculum development at a programme, school or faculty level over a one academic year period. It was intended that evidence gathered from the studies would be utilised to inform relevant policy, practice or similar institutional research activities into the future.

Applications were invited for Fellowship projects that linked to the DIT strategic themes related to Diversity, Modularisation and e-Learning (See Appendix 1.1 for the 2009/10 Teaching Fellowship Strategy Grid). Initially a SIF funded Learning Development Officer, Rachel Fitzgerald, was responsible for overseeing the coordination of the Fellowship project processes. The LTTC provided Fellowship Project proposal and planning advice/guidelines to the Heads of Learning Development or equivalent and/or Fellowship applicants, upon request. However, the faculties were responsible for selecting projects aligned to their own strategic priorities. In September 2009, twelve DIT Teaching Fellowships were launched, two from each of the then six faculties.

Each Fellow was allocated two members of LTTC staff to help support their project work. A programme of six Fellowship workshops and project update sessions were scheduled throughout the year. A one-day writers' retreat was coordinated to encourage the Teaching Fellows to write their work up for a peer reviewed journal paper. A Fellowship website was established: <http://www.dit.ie/lttc/projects/institutionalprojects/>. Each project was asked to maintain regular updates on its work (through a website blog, update presentations and the final reports). At the end of the academic year, a number of Fellows participated in a DRHEA – Sharing Academic Excellence Event, in UCD. They were also asked to provide a set of recommendations on the basis of their research data at a DIT Management Forum in May 2010. An evaluative review of the Fellowship process was conducted at the end of the year (see Appendix 1.2.) As a result of this feedback a number of changes were made during the second year of the Initiative.

The establishment of DIT Teaching Fellowships has been fully embraced by the Institute. This has for the most part been due to the high quality of the work undertaken by the award recipients during this first year. This is clearly evidenced through the reports included in this publication and the number of papers, conference presentations and journal articles arising from this work. As a result, EoL funding was again allocated by the DIT to support nine Teaching Fellowships during 2010/11. Currently, work is underway to sustain this Initiative into the future once external funding ceases.

Jen Harvey, Head of the DIT, Learning, Teaching and Technology Centre

Summary Overview of Projects

Faculty of Applied Arts

María-José González and Odette Gabaudan, School of Languages



This project aimed to address student engagement and retention issues for first-years by using mentoring. The objective was to offer Year One students on International Business and Languages programmes additional support by training Year Two students as leaders in Peer Assisted Learning. The project aimed to focus primarily on students' needs in relation to language modules on the programme. It was hoped that this would contribute to greater student engagement and improved retention levels in Year One of the IBL programme.

Faculty of the Built Environment

Catherine Prunty and Maire Crean, School of Architecture



The intention of this project was to measure and record findings, from strategic student and staff surveys together with open discussions, the effectiveness of Formative Assessment strategies. The proposal aimed to implement these findings to further enhance student learning in the Architectural Technology Programme delivered by the Department (or any other courses within the Faculty of the Built Environment), all to improve the learning experience and development of the learner.

Maurice Murphy, Lloyd Scott, School of Construction



This project aimed to develop technology based student assessment practice using Building Information Modelling VLE software for first and second year technology and graphics construction and surveying students. This was to add to the recently developed BIM learning tool a virtual assessment system to allow first and second year student to progress within this virtual learning environment. Through creating student centred assessment methods (as opposed to traditional assessment of exams) this virtual learning environment of the Building Information Modelling aimed to enhance and motivate student learning.

Faculty of Business

Alice Luby, School of Marketing



This project aimed to be an innovative cross-faculty collaboration to develop e-learning activities to enhance and improve the learning experience of students. The project specifically targeted those who find the traditional lecture setting a barrier to learning as well as students with disabilities like dyslexia.

Conor Horan, School of Marketing



This project aimed to assess the appropriate teaching and learning strategies for the development of a fully modularised (and flexible) Business Research Methods (BRM) module with a view to co-ordinating an appropriate implementation of the Faculty Research Strategy, while accommodating specialist research methods within disparate disciplines within the Faculty

Faculty of Engineering

Gavin Duffy, School of Electrical Engineering Systems



During his fellowship, Gavin aimed to increase the number of problem-based learning modules to at least one in each of the four years of the electrical engineering degree and developed a framework for the progressive development of personal skills through these modules.

Michael Carr, School of Civil and Building Services



Building on his success developing a programme of maths support for students through the use of an online support module, Michael aimed to extend his model to eight first year modules in the Engineering Faculty with a view to have all first year modules in Engineering to take part.

Faculty of Science

Rob Howard, School of Physics



During his fellowship, Rob aimed to evaluate current physics lab modules throughout the School of Physics, and to create a student centred physics lab programme from first to fourth year and across into service courses. The project aimed to evaluate the development of lab skills from years one to four and to look at the best way to ensure that academic skills and learning outcomes are achieved.

Deirdre Lawless and Damian Gordon, School of Computing



Deirdre and Damian aimed to develop a blended learning approach for selected core modules on two M.Sc. programmes. The project also aimed to improve engagement and retention of part-time postgraduate students through the use of student edited podcasts and to develop a methodology for the creation of podcasts by staff, and to establish an open and

accessible repository of teaching and learning materials.

Faculty of Tourism

Mary O'Rawe, School of Hospitality, Management and Tourism



The Get Smart initiative aimed to develop academic skills in the first year. This fellowship allowed continuation of the programme with the aim of developing a framework that would allow Get Smart to slot into the modular structure for any subject area. It was hoped that this reform to the curriculum would allow students to change their learning strategies and meet the academic expectations of third level education. During the fellowship, Mary also looked to develop the content into an e-learning module to engage students online and effectively enable wider participation.

Frank Cullen, School of Culinary Arts and Food Technology



Frank's project aimed to identify a framework for preparing and monitoring students on national and international placements. As part of the project he aimed to identify key issues associated with student participation and develop a pedagogic framework to enhance student learning. Building on his prior work in this area he aimed to also develop the use of innovative assessment practices through the use of reflective portfolios.

Faculty of Applied Arts

1. Peer Assisted Learning Project

María-José González and Odette Gabaudan
School of Languages

Contacts: Maria-Jose.Gonzalez@dit.ie and Odette.Gabaudan@dit.ie

Abstract

This report provides a comprehensive outline of the context for the Peer Assisted Learning Project and the process of implementation in the BA (Hons) International Business and Languages in the academic year 2009–2010. It also includes a set of recommendations arising from the project and it concludes with an outline for future work in the area.

Keywords: curriculum development, first year curriculum, Peer Assisted Learning (PAL), student engagement and retention

Outline of Fellowship Project

Introduction

The aim of this project was to enhance the learning experience of Year 1 students in the BA (Hons) International Business and Languages. Many students in their first year at 3rd level find it difficult to integrate in and cope with what is a very different learning environment to that experienced at secondary school. The BA (Hons) in International Business and Languages is challenging and demands much of the first year student. Year 1 students often lack both the study skills and the personal skills necessary to succeed in this new learning environment. Oftentimes there is no overt effort to address these possible deficits through the learning objectives of Year 1 modules. As a result students may be left in a vulnerable situation that can lead to an increasing level of disengagement with particular modules or the programme as a whole. This in turn may result in high attrition rates.

Research at DIT level has shown a substantial decrease year on year on failure rate levels and attrition from Year 2 onwards. It has also shown significant levels of failure rates and its associated corollary: attrition in Year 1 of all programmes across the Institute. A similar picture emerges for the BA International Business and Languages. Failure rate and attrition is considerable in Year 1 of the programme but it decreases thereafter. From Year 2 onwards failure rates decrease and few students leave the programme. Furthermore, final year students' academic performance is regularly acknowledged by the external examiners to be on a par with that of students in other institutions. This would suggest that those who have managed to progress to Year 2 are equipped with a skills set that is essential for academic survival.

The aim for the Peer Assisted Learning Project was to support Year 1 students and assist them with the academic challenges they face in their first year in college. In order to enhance Year 1 students' learning and social experience a variety of issues need to be addressed. Issues such as integration into college life and engagement with the new academic environment in general and with the programme in particular are key for a positive experience. The involvement and support of Year 2 students was sought as it was considered that they were ideally suited to aid Year 1 students navigate their way through the first year of the course.

The concept for Peer Assisted Learning (PAL) or Peer Assisted Support is for Year 2 tutors to provide

friendly, informal and effective support to their peers in Year 1. The nature of the support was to be negotiated and agreed between tutor and tutee/s so that it could be better directed to the areas in need of development; be it academic skills or indeed abilities of a more personal and social nature. The latter are often difficult to identify but play a crucial role in the overall academic experience of Year 1 students. As outlined in the next section, research has demonstrated that a positive experience of first year is directly linked to enhanced academic performance and improved retention rates both of which are the principal expected outcomes of this project.

Definition and Features of PAL

The Peer Assisted Learning Project carried out for the BA (Hons) International Business and Languages fits well with the following definition: 'PAL may be defined as a scheme for learning support and enhancement that enables students to work co-operatively under the guidance of students from the year above' (Capstick, Fleming & Hurne, 2004).

In practical terms, the experienced student, most usually, second year student (PAL tutors) support the learning experience of less experienced students, typically first-years. A PAL tutor or a pair of PAL tutors are matched with small groups of students and meet on a regular basis for informal, flexible study support sessions in a friendly and collaborative atmosphere. PAL tutors are expected to manage discussions and suggest activities focused on matters particular to the students' course of study. This may include discussion of class material, clarification on course direction and expectations, development of good study habits and strategies for learning, discussion around non-course-related discussion such as adjusting to university life. The emphasis is on guided group discussion and active learning based on the group's needs. Therefore PAL tutors are trained in study techniques, group management and facilitation skills (Capstick & Fleming, 2001; Ashwin, 2002; Jacobs & Hurley, 2008).

Historical Background and Terminology

PAL has its origins in an approach developed in the University of Missouri in the 1970s. In the USA, it has since been referred to as Supplemental Instruction (SI). SI programmes have been implemented across the USA and their effectiveness has been recognised by the US Department of Education. Terminology referring to PAL varies. In the USA it is called Supplemental Instruction and in Australia and New Zealand it is known as Peer Assisted Study Sessions (PASS). In effect, while universities have developed distinctive approaches to suit local conditions (Capstick & Fleming, 2001), the guiding principles of SI, PASS and PAL study sessions are all similar (Van der Meer & Scotty, 2009).

Theoretical Background

PAL strategies are underpinned by constructivist learning theories (Inhelder & Piaget, 1958; Vygotsky, 1978). These theories focus on 'the cognitive development of students in which learning is constructed in an interactive social context (peer collaborative learning)' (Jacobs, Hurley & Unite, 2008: 6). In Congos & Schoeps' view (1998: 52), PAL students 'collaborate to supply missing information or attempt solutions to problems as they help each other'. Therefore, at the heart of learning lie the interactions between teachers and students and between students themselves. These interactions, referred to by Johnson & Johnson (1989) as 'promotive interaction' result in learning as students encourage and facilitate each other's efforts to reach the group's goals. Thus collaborative learning produces higher achievement than competitive or individual effort. Constructivist learning theories suggest that students who collaborate with their peers and take an active approach to their learning not only earn higher grades but also have a stronger ground up understanding of course material (Arendale, 2005). The processes that emerge from these theories are fundamental elements to be included in PAL tutors' training so that tutors will be equipped to

conduct effective PAL sessions (Jacobs & Hurley, 2008).

Objectives

Common objectives of PAL strategies are to improve student learning, support the first year student experience by helping them to integrate into university life, raise student grades and achieve lower attrition rate (Jacobs & Hurley, 2008; Van der Meer and Scotty, 2009). While the former are of direct interest to students, the latter is of particular interest at institutional level (James, 2001; Haggis & Pouget, 2002; Krause, 2006). Also of great institutional interest during the last decade is the concept of student engagement. By getting involved in PAL initiatives, students demonstrate a greater engagement in academic activities that are or are not directly related to course work (Prebble et al., 2004). This is also true for PAL leaders who find their overall learning experience enhanced (Topping & Ehly, 1998).

Effectiveness

Much of the literature reports on the effectiveness of PAL/PASS and more particularly of SI initiatives (McCarthy, Smuts & Cosser, 1997) whose efficacy at raising student grades, lowering failure rates and improving retention rates has long been recognised by the US Department of Education (Congos & Schoeps, 2003; Jacobs & Stone, 2008; Van der Meer & Scotty, 2009). Furthermore, research has shown that these academic support programmes enable the development of transferable skills both within and outside the academic context (Koehler, 1995; Price & Rust, 1995; Congos & Schoeps, 1998; Donelan, 1999).

Outline of Fellowship Initiative

The PAL initiative was first presented to the International Business and Languages programme teaching team during the School Meeting at the start of the academic year.

First year students were informed about the scope of the project during the International Business and Languages Induction Session in September 2009. This was followed by an email from the project coordinators outlining the potential benefits both of the initiative and their participation in the project. Year 2 students of all language streams were first emailed to encourage them to volunteer as tutors. This was followed by in class presentations which briefly outlined the role of the tutor in the initiative and associated benefits to volunteers. While project coordinators had felt this could perhaps be the biggest hurdle in the setting up phase of the project, Year 2 students displayed a very positive attitude towards the project and were eager to participate and become tutors. A list of Year 2 students volunteering to become tutors was compiled at the end of these in-class presentations.

In parallel to this, project coordinators were kindly invited to participate and sit in at the training session for PAL tutors held by the Department of Languages and Literary Studies in Trinity College Dublin. This training session provided the backbone and the foundation for the training sessions organised for the Induction session for IBL tutors a week later. The content for the induction session for Year 2 volunteers centered on the following points:

- Outline of objectives and benefits of PAL
- General guidelines about the role of the tutors
- Exploration of the concept of tutor as facilitator of learning
- Reflection on the concept of collaborative learning and its role in PAL sessions
- Interaction and scope of PAL sessions

The format for the Induction Session used a variety of techniques to elicit participation and

interaction amongst volunteers. It also aimed to provide volunteers with a model of what a PAL session should be like. At the end of the training session tutors were provided with the *Tutor's Handbook*. This Handbook contains useful information and general guidelines to aid tutors in their new role. The Handbook also includes feedback forms so that tutors can keep a log of meetings with tutees and the nature of activities undertaken during each session.

The Induction Session for Year 2 volunteers was offered on three different dates so that all volunteers could be trained.

Review week was identified as the ideal time for an informal get-together session between trained tutors and interested Year 1 students. The session was particularly well attended by tutors and it was used to pair tutors and Year 1 students. During this session mentors were paired off with tutees based on their respective language streams and their personal affinities. During the session it was emphasised that it was now up to the individual tutors and tutees to arrange weekly meetings, to decide on the range of activities and the type of support required to effectively guide and support Year 1 students.

Just before Christmas, a feedback questionnaire was sent out to both tutees and tutors with the objective of assessing the Initiative's roll out and identifying groups actively engaged in PAL, the frequency of PAL meetings, the issues encountered and the topics discussed during PAL sessions. As illustrated in the chart below, some attrition was noted, particularly in the French and Spanish streams. The German and English streams generally showed more commitment to the initiative.

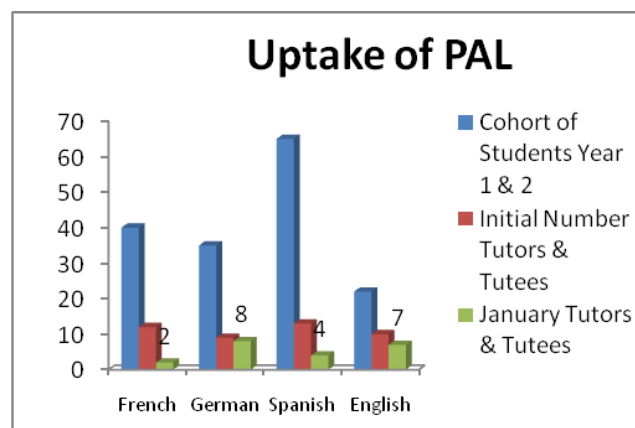

Table 1.1: Uptake of Peer Assisted Learning 2009–2010

In view of the survey findings it was decided to re-launch the initiative in Semester 2. In order to re-launch the project and attract more Year 1 students to become fully involved in the PAL sessions a series of steps were taken including the re-activation of a Facebook account for the project; the creation of a flyer to be displayed on Year 1 notice boards and distributed to Year 1 students in class; messages were also sent to Year 1 students' mobiles with information about PAL. Finally, Year 2 tutors volunteered to present the PAL initiative and its benefits to Year 1 students during class time thus hoping to engage first year students with their enthusiasm.

Recommendations from Peer Assisted Learning Teaching Fellowship

It is important to evaluate any PAL initiative from different perspectives in order to identify areas for improvement and enhance its implementation (Van der Meer & Scotty, 2009). In this section, the

perspectives considered will be that of the first year students, the second year tutors, the trainers, the staff and the institution. For each, some recommendations will follow a number of reflections.

First Year Students

Involvement in the Peer Assisted Learning Initiative has brought to light many issues relating to the experience of students in their first year in college. One of the most salient and recurrent issues throughout the duration of the initiative was the difficulty of establishing and maintaining a 'connection' with Year 1 students. The success of any project carried out in their interest can only be achieved if what makes them 'tick' is clearly identified and steps are taken to build on it. Research indicates that students enrol to improve their grades in the course (Van der Meer & Scotty, 2009). However, the uptake by first year students in the PAL initiative was unexpectedly low, attendance to meetings was inconsistent and tutors found it difficult to successfully engage Year 1 students. It would appear that there are other factors at stake that motivate or de-motivate students. The difficulties encountered may be a result of first year students' 'inappropriate expectations' (Capstick & al., 2004: 32), an aspect worthy of further investigation. Nonetheless there were some noteworthy examples of the positive impact the PAL Initiative had on a small number of Year 1 students. These students reported that their tutors had provided them with a much needed lifeline at various junctures during the year. These students found the support of the tutors invaluable in areas such as understanding the nature of assignments, lecturers' expectations in relation to written and oral assessments and preparation for exams. On reflection, this initiative worked very well for a small number but it failed to engage all Year 1 students. This was due to a variety of factors.

Second Year Tutors

Tutors were pleased with the outcomes of their PAL experience even though many of them would have liked to have seen a greater uptake among first year students. As suggested by the literature (Topping & Ehly, 1998), tutors acquired a transferable set of skills which they had not developed through their normal class work. They also became more aware of their own strengths and weaknesses. At an end of year meeting with tutors and tutees, tutors made special reference to their increased sense of confidence, the development of inter-personal skills and communication capability. Tutors' overall experience of their involvement in the initiative was one of achievement and accomplishment.

As a means to further capitalise on the tutors' learning, it is hoped that upon the validation of an extra-curricular activities module PAL tutors will have the option to complete this module in the form of a CPD course. Much of its content would cover similar skills to those necessary in the facilitation of PAL sessions. This module is to be validated shortly. Its aim would be twofold: to provide students with ongoing support in their PAL sessions as well as awarding them a certification recognisable by employers.

Trainers

The project leaders provided some basic training to the second year tutors based on the training of tutors observed in Trinity College and a review of the literature. In hindsight, the trainers' understanding of PAL methodology needed to be developed further to meet the many challenges encountered. Indeed, adequate training of project coordinators is essential for the successful running of a PAL scheme (Capstick & Fleming, 2001) as 'it is not enough to assume that because PAL is supposed to be cooperative, that in reality it will always operate in this way' (Ibid.: 72). Therefore, it will be important for the subsequent running of PAL programmes on this BA to provide trainers with the resources required to equip them with the necessary skills set to train tutors.

Staff

In the first year of its inception, project leaders focused their efforts on getting the project up and running. They informed colleagues of the initiative during school and committee meetings. However, this proved to be insufficient and while there was no overt resistance to the implementation of the programme, there was also no explicit support, for instance in the form of promotion of the programme in class. This is a shortcoming on the instigators' behalf which needs to be addressed as it is important for the success of the initiative to 'involve those affected by the introduction of the innovation' (Ashwin, 2002: 223). PAL must be widely supported by colleagues to ensure the initiative is championed by many rather than by two members of staff and also to elicit collaboration for instance by suggesting to students possible activities that may be used in PAL sessions (Capstick et al., 2004). In order to gather the required support, it will be important to put 'the innovation into the context of current conflicts in the system' (Ashwin, 2002). Indeed while at managerial or institutional level, the concerns may be around retention, lecturers and students have different overriding concerns. PAL should therefore be presented to them as 'a tool to shape and support courses' (Ibid.: 225).

Institutional Level

Understanding the mindset of Year 1 students requires a comprehensive strategy and approach at Institute level bringing together the knowledge on Year 1 gathered by DIT Retention Office and the expertise of the Learning and Teaching Centre. The outputs of some of the current Teaching Fellowships may indirectly throw some light on this matter. It is also recommended to encourage forthcoming Teaching Fellowships to specifically research what drives and motivates first year students.

Initiatives such as PAL have been adopted and embedded in all programmes in various Irish universities and IoTs so a concerted effort at institutional level should be investigated and implemented.

Future Work

PAL project leaders are committed to continuing the initiative in the next academic year. As it appears that an early implementation is key to the students' buy in, PAL will heretofore be embedded into the first year students' induction in September. Based on the University of Manchester's PASS experience, the PAL programme will be presented to first years as an opt out option rather than an opt in one, thus incentivising students to get acquainted with PAL and hopefully to remain engaged with it. Tutors who came forward prior to the summer break will be involved during the Induction. They will be paired off with first year students on the basis of their language choice. They will then be required to carry out an icebreaker activity outside of the academic context. Furthermore, a section of the student handbook will be dedicated to PAL thus contributing to giving the programme a greater relevance in the first year student's mind. In parallel, the programme lecturing team will be asked to regularly encourage first year students to attend PAL sessions as a beneficial and enjoyable way of discussing course material covered during lectures. Finally, formal training of project coordinators will be sought in order to enhance the preparedness of tutors and to be of a greater support to them throughout the year.

Conclusion

Implementing a PAL programme in the BA (Hons) International Business and Languages has been a challenging but worthwhile experience. The learning curve has been very steep with much of the experience confirmed by the literature on the topic, by seasoned PAL implementers or by experts in

the field. As Capstick et al. (2004), there is no one model for implementing PAL. PAL programmes need to be adapted both to the organisational and the course contexts. It is hoped the next attempt in the academic year 2010–2011 will provide an opportunity to tackle the many challenges and difficulties encountered in its first version.

References

Ashwin, P. (2002) Implementing Peer Learning Across Organisations: The Development of a Model. *Mentoring & Tutoring*, 10(3), 221–231.

Arendale, D.R. (2005) *Postsecondary Peer Cooperative Learning Programs: Annotated Bibliography*; available online at <http://www.eric.ed.gov/PDFS/ED489957.pdf>.

Capstick, S. (2004) Benefits and Shortcomings of Peer Assisted Learning (PAL) in Higher Education: An Appraisal by Students. Paper given at the Peer Assisted Learning Conference, January 2004; available online at <http://pal.bournemouth.ac.uk/documents/Bnfts%20%26%20Shrtcmngs%20%20of%20PAL3.pdf>

Capstick, S. & Fleming, H. (2001) Peer Assisted Learning in an Undergraduate Hospitality Course: Second Year Students Supporting First Year Students in Group Learning. *Journal of Hospitality, Leisure, Sport & Tourism Education*, 1(1), 69–75.

Capstick, S., Fleming, H. & Hurne, J. (2004) Implementing Peer Assisted Learning in Higher Education: The Experience of a New University and a Model for the Achievement of a Mainstream Programme. Paper given at the Peer Assisted Learning Conference, January 2004; available online at <http://pal.bournemouth.ac.uk/documents/implmntng%20pal%20article61.pdf>.

Congos, D. & Schoeps, N. (1998) Inside Supplemental Instruction Sessions: One Model of What Happens that Improves Grades and Retention. *Research and Teaching in Developmental Education*, 15(1), 47–61.

Congos, D.H. & Schoeps, N. (2003) Inside Supplemental Instruction Sessions: One Model of What Happens That Improves Grades and Retention Revisited. *Journal of Student Centered Learning*, 1(3).

Donelan, M. (1999) SI Leaders: The Real Winners. Paper delivered at the *National Conference on Supplemental Instruction*, Kansas City, USA.

Haggis, T. & Pouget, M. (2002) Trying to be Motivated: Perspectives on Learning from Younger Students Accessing Higher Education. *Teaching in Higher Education*, 7(3), 323–336.

Inhelder, B. & Piaget, J. (1958) *Growth of Logical Thinking from Childhood to Adolescence*. New York: Basic Books.

Jacobs, G. & Hurley, M. (2008) How Learning Theory Creates a Foundation for SI Leader; *Training Australasian Journal of Peer Learning*, 1(1), 6–12

Jacobs, G. & Stone, M.E. (2008) Foreword. In M.E. Stone and G. Jacobs (eds), *Supplemental Instruction: Improving First Year Student Success in High-Risk Courses*. (The First Year Experience Monograph Series No. 7, pp. v–vi). University of South Carolina: National Resource Center for the First Year Experience and Students in Transition.

James, R. (2001) Students' Changing Expectations of Higher Education and the Consequences of Mismatches with the Reality. Paper presented at the OECD-IMHE conference *Management Responses to Changing Student Expectations*.

Johnson, R. & Johnson, D. (1989) *Cooperation and Competition Theory and Research*. Edina, MN: Interaction Book.

- Krause, K. (2006) Accommodating Diverse Approaches to Student Engagement. Paper presented at the *New Zealand Quality Enhancement Meeting 11*, Wellington, 28–29 September.
- Koehler, C. (1995) Supplemental Instruction and Critical Thinking. *Supplemental Instruction Update*, Spring, 1–3.
- McCarthy, A., Smuts, B., & Cosser, M. (1997) Assessing the Effectiveness of Supplemental Instruction: A Critique and a Case Study. *Studies in Higher Education*, 22(2), 221–231.
- Prebble, T., Hargraves, L., Leach, L., Naidoo, K., Suddaby, G., & Zepke, N. (2004) *Impact of Student Support Services and Academic Development Programmes on Student Outcomes in Undergraduate Tertiary Study: A Synthesis of the Research*. Wellington: Ministry of Education.
- Price, M. & Rust, C. (1995) Laying Firm Foundations: The Long-term Benefits of Supplemental Instruction for Students in Large Introductory Courses. *Innovations in Education and Training International*, 32(2), 123–130.
- Topping, K. & Ehly, S. (1998) *Peer-Assisted Learning*. Mahwah, New Jersey and London: Lawrence Erlbaum.
- Van der Meer, J. & Scotty, C. (2009) Students' Experiences and Perceptions of Peer Assisted Study Sessions: Towards Ongoing Improvement. *Australasian Journal of Peer Learning*, 2(1), 3-22.
- Vygotsky, L.S. (1978). *Mind in Society: The Development of Higher Mental Processes*. Cambridge, MA: Harvard University.

Faculty of the Built Environment

2. Building Information Modelling Incorporating Technology Based Assessment

Maurice Murphy and Lloyd Scott

School of Construction Management & Technology

Contacts: maurice.murphy@dit.ie and lloyd.scott@dit.ie

Abstract

Building Information Modelling (BIM) is currently being developed as a virtual learning tool for construction and surveying students in the Dublin Institute of Technology. This advanced technology is also used to develop a technology based assessment practice for enhancing the learning environment of construction and surveying students. A theoretical design framework is presented in this paper, which combines advanced technology and assessment theory to create a virtual learning environment. This is based on the move from teacher-centered to student-centered learning, which attaches a higher degree of importance on what students know, understand, and can do as a result of their educational experiences. The design framework consists of three levels: the first incorporates student access for initial assessment, secondly student motivation is enhanced using self-assessment techniques and finally formative assessment through information sharing is introduced using student-teacher WEB-based interaction inside the virtual learning environment.

Keywords: assessment, building information modelling, curriculum development, e-learning, first year curriculum

Outline of Fellowship Project

Introduction

The aim of this project was to develop a technology based student assessment practice using Building Information Modelling (BIM). BIM is currently being developed as a virtual learning tool for construction and surveying students in the Dublin Institute of Technology (DIT). This aim was achieved through developing a theoretical design framework, which combined advanced technology and assessment theory to improve on the current BIM based virtual learning environment.

Throughout its development, evaluation was built into the process through testing the prototype with students and presenting the on-going work to seminars and conferences, in order to establish feedback, which could improve design. The outcome of the project is a prototype and a theoretical design framework for a technology based student assessment tool, which enables individual and group based student appraisal, that is student centred as opposed to being based on the traditional approach of exams.

Initial Step – Creating a Theoretical Design Framework

The outputs of two main pieces of research within the DIT's department of construction technology and management were used as the foundation for constructing a theoretical design framework for incorporating technology based assessment into building information modelling. The first is the outcome of an investigation of the assessment practices in undergraduate programmes in Built Environment. This research indicates that while the 'tide is starting to turn' there is still an over-reliance on the traditional summative examination at the end of a module or unit of learning. Secondly, new developments in the faculty using BIM as a virtual learning environment were incorporated into the design. Virtual learning offers a very different experience from classroom based learning; when interacting online individual students have their own perspective and experiences whereby they construct their own interpretations of the knowledge (Abrami & Bures, 1996). This was exploited in the design of learning software; students are encouraged to construct

their own interpretation from the simulation of realistic scenarios of the construction process thus improving the learning outcomes.

Defining the Technology

A study in the Civil and Environmental Department at Worcester Polytechnic Institute confirmed that the use of BIM facilitated effective learning mainly because it involves sharing, communicating, and group problem solving. It also helps students to actively engage in the process of planning, designing, and interpreting construction related data. Moreover, the concept represents an invaluable tool to teach students the notion of cooperative work, which is in line with the advancements of the construction industry (Salazar, Mokbel & Aboulezz, 2006).

As part of the initial design process a seminar was organised on BIM on Wednesday 25 November 2009; this attracted 150 participants and presenters from DIT, Industry and the University of Perdue. The recorded outcome of the seminar provided an understanding for the use of BIM in an educational setting. In particular there was a focus on the correct definition of BIM – where parametric objects are brought together as building components to create or form the entire building, this system is referred to as Building Information Modelling. The BIM can automatically create cut sections, details and schedules in addition to the orthographic projections and 3D models (wire frame or textured). The parametric building objects are not defined singularly but as systems using interaction with other objects and their own values (shape, texture etc.) within a BIM (Eastman, 2006). In building parametric objects, the problem of file format and exchange of data has been overcome within the ArchiCAD software platform by using a geometric descriptive language (GDL). The scripting in GDL allows for sharing and editing of the parametric objects at different levels. In Figure 2.1 below an example of a column with a capital and base is constructed using a GDL script (Graphisoft, 2006). Before placing a construction element, or GDL object, in a BIM, the default parameters can be edited by the software, changing parameters of shape, size or other properties as opposed to re-scripting in a GDL editor (Tse, Wong & Wong, 2005).

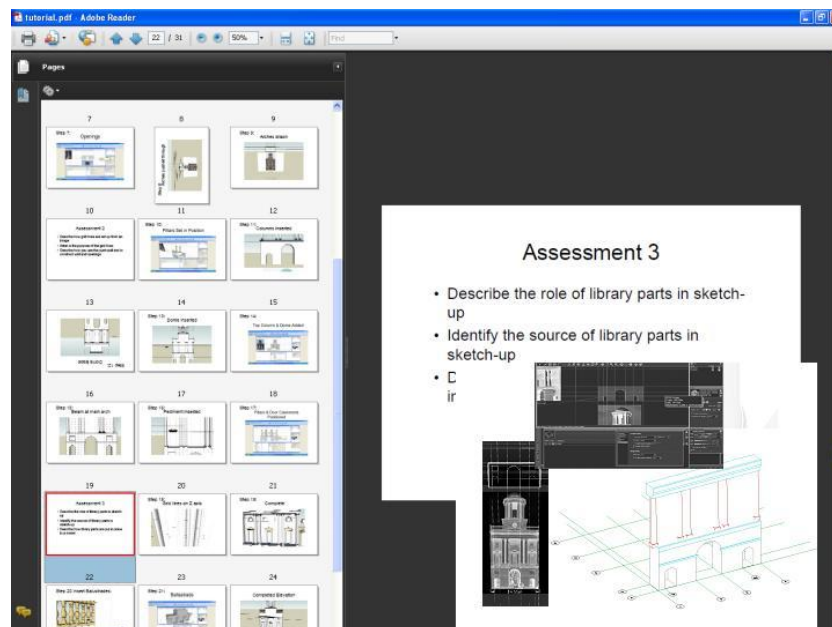

Figure 2.1: Initial assessment of Learning Environment

Defining Assessment

There are many reasons to assess students; these range from traditional summative assessment and the need for evidence and the classification of learning to formative assessment through guidance for improvement. There is also a move from teacher centered to student-centered learning (SCL) approaches, a higher degree of importance has been attributed to outcomes assessment and evidence of performance of what students know, understand, and can do as a result of their educational experiences (Lea, Stephenson & Troy, 2003). While there is evidence of a move to conceptualise learning through a constructivist lens, how we assess learning in this context has been relatively under-developed (Laurillard, 2002). Cross (1996) refers to assessment and feedback as providing one of three conditions for learner success. It is generally acknowledged that a student's approach to learning and the quality of learning achieved will be influenced by the way in which this learning is to be assessed (e.g. Entwistle & Ramsden, 1983; Gibbs, 1999). The critical importance of formative assessment (assessment that contributes to the student's learning through the provision of feedback about performance (Yorke, 2003) should not be under-estimated by educationalists and this is confirmed by Black and Wiliam (1998).

Assessment for learning, more commonly understood as formative assessment, is defined by Black and Wiliam (1998: 8) as 'all those activities undertaken by teachers and/or by their students, which provide information to be used as feedback to modify the teaching and learning activities in which they are engaged'. In very simple terms, assessment may be defined as such activities that measure student learning. Boud (1990) posited that assessment has two purposes: firstly that of improving the quality of learning where learners engage in activities and are given feedback that will direct them to effectiveness in their learning (commonly referred to as formative feedback). The second purpose concerns that of the accreditation of knowledge or performance, which occurs generally for the award of a degree or diploma (commonly referred to as summative assessment).

Nowadays, students are more focused and they approach assessment with a better understanding of what is involved. Bloxham and Boyd (2007: 19) refer to students as 'being cue conscious concentrating on passing an assessment'. Academics currently speak in terms of formative and summative assessment. A student-centered learning framework puts the learner at the centre of the learning process, in which assessment plays an important part. It is widely accepted that assessment has a direct impact on students' learning (Askham, 1997; Black & Wiliam, 1998; Stiggins, 2002). Research indicates that what the student will focus on during the course of their studies will be hugely influenced by the assessment methods employed to measure the learning experienced (Ramsden, 1992).

Assessment of learning (summative) is where assessment for accountability purposes is paramount; its function is to determine a student's level of performance on a specific task or at the conclusion of a unit of teaching and learning. The information gained from this kind of assessment is often used in reporting and is purely of a summative nature. Assessment *for* learning, on the other hand, acknowledges that assessment can be embedded as a regular part of teaching and learning and that the information gained from assessment activities can be used to shape the teaching and learning process. Gibbs & Simpson (2004) have developed a model that promotes eleven conditions under which assessment supports learning, as outlined in Table 2.1 below. It is within this theoretical framework that the development of the BIM assessment model is based.

Table 2.1: Eleven conditions under which assessment supports learning
(Gibbs & Simpson, 2004)

1. *Sufficient assessed tasks are provided for students to capture study time*
2. *These tasks are engaged with by students, orienting them to allocate appropriate amounts of time and effort to the most important aspects of the course*
3. *Tackling the assessed task engages the students in productive learning activity of an appropriate kind*
4. *Assessment communicates clear and high expectations*
5. *Sufficient feedback is provided, both often and in enough detail*
6. *The feedback focuses on students' performance, on their learning and on actions under the students' control, rather than on the students themselves and on their characteristics*
7. *The feedback is timely in that it is received by students while it still matters to them and in time for them to pay attention to further learning or receive further assistance*
8. *Feedback is appropriate to the purpose of the assignment and to its criteria for Success*
9. *Feedback is appropriate, in relation to students' understanding of what they are supposed to be doing*
10. *Feedback is received and attended to*
11. *Feedback is acted upon by the student*

Project Outcome – Combining Learning Technology and Theory

This stage combines assessment theory and the advanced technology of BIM in three levels:

Level 1 – Pre and initial assessment defines at what level a student should access the learning environment; this is built into tutorials to encourage the student to assess their entry level and encourage the student to revise and self-assess their work prior to moving to higher levels in the software. Figure 2.1 below is an extract from a set of tutorials based on sketch-up software platform.

Level 2 – Student motivation is enhanced using self-assessment techniques; this is scripted in the library objects using Geometric Descriptive Language (GDL), which is an open scriptable language that can be used to create parametric objects. GDL is an embedded programming language in ArchiCAD, which provides access to create and model parametric objects. The parametric objects are the components that the student brings together to form the entire building within a virtual environment. Figure 2.2 describes an example of a GDL script to form a Doric column.

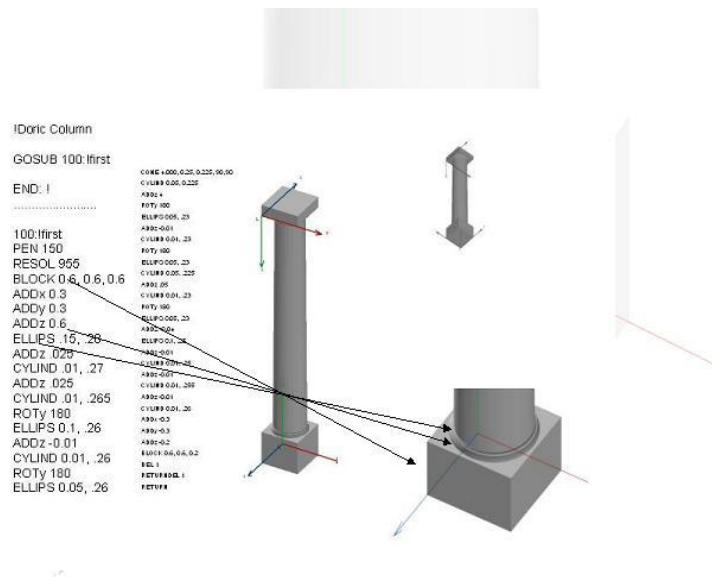

Figure 2.2: GDL Scripting to create a model

Level 3 – Formative assessments through information sharing is introduced using student–teacher WEB based interaction inside the Virtual Learning Environment (Salmon, 2002). Student–teacher WEB based interaction inside the Virtual Learning Environment using ArchiCAD BIM Server™ allows student and teacher to collaborate in real-time on BIM models through standard Internet connections from virtually any location. The BIM models are located on a single server and accessed by the student and can be observed and assessed by the teacher as the students work through the virtual building. The learning software and virtual building models can be accessed by the student on the Internet through PC, laptop and hand-held devices allowing participation and support for traditional and non-traditional learners.

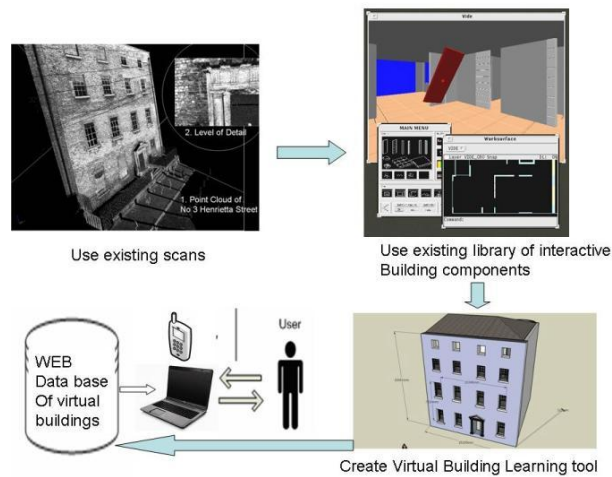

Figure 2.3: WEB interaction to support learning

Project Evaluation

The planned outcome of this project was evaluated through a pilot (see Figure 2.4 showing student field and lab BIM work) and subsequent interview process with 30 construction students. The majority favoured the technology based assessment methods to traditional assessment of exams.

They also favoured the virtual learning environment of the Building Information Model as a learning tool as it motivated them to progress through their programme module. To quote one student's reaction to BIM: 'extremely interesting and insightful' (Murphy & Scott, 2010). In contrast to the students' enthusiasm for BIM the students were critical of the pilot in terms of lack of the extra learning support required in learning to use the BIM software. When further questioned on the lack of support, the students described the extra support needed as additional computer lab time and small group tutorials. The concept of the students learning online using PCs, laptops or hand-held devices did not appeal to the majority of students, possibly creating problems in Stage 3; WEB based student/teacher communication environment.

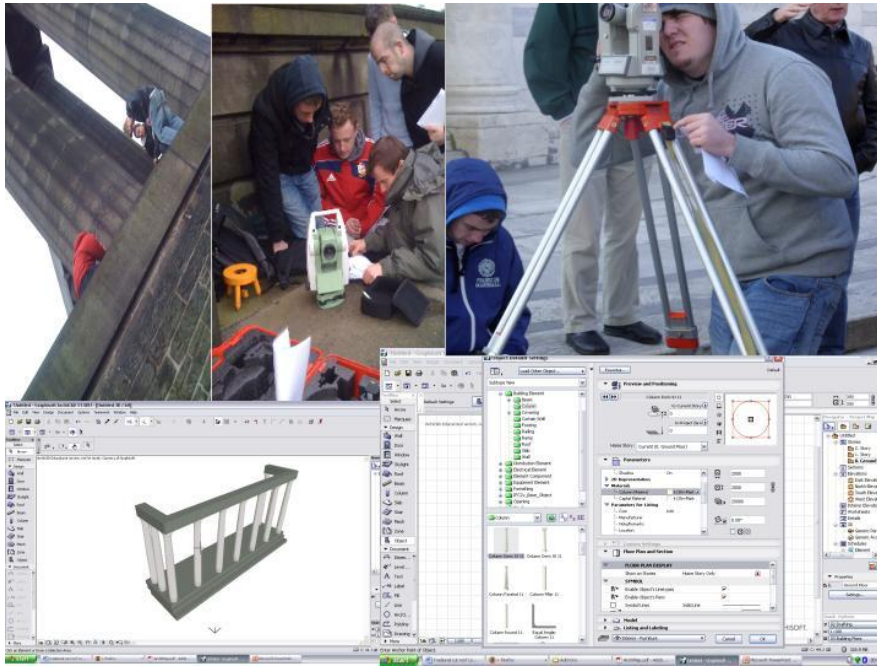

Figure 2.4: Student field and lab BIM work from the Pilot Programme

Proposed Future Work and Recommendations

The proposed future work will be to mainstream the virtual learning and assessment technology within the department in the academic year 2010/2011 and incorporate the identified improvements. This will be designed in particular for first and second year students in the department of construction technology and management to create an introduction to existing and historic building technology. In the initial design stage, it was assumed that many young students were comfortable with virtual learning environments because of involvement in social networking and game environments. This aspect will require introduction and promotion within small group lab tutorials alongside better training in the use of the BIM software. A more sophisticated evaluation process will be included in mainstreaming to measure how best this learning technology provides participation and support for traditional and non-traditional learners and how it best allows for progress at the student's own pace. The learning software will be continuously upgraded to include technology-based assessment, for initial and self-assessment and WEB based communication for formative assessment. The main recommendations at the institute level are the necessity to continue to create innovative pedagogic approaches through the teaching fellowship programme and other learning and teaching support programmes. There is also a need to create an ongoing link between formal research activities and developments in learning and teaching. As this project grew

out of DIT investment in learning and teaching and research and technology it offers a tentative example for other such approaches across the Institute. Both authors would like to acknowledge the assistance and support from the staff of the Learning and Teaching centre within the Dublin Institute of Technology.

References

- Abrami, P.C. & Bures, E.M. (1996) Computer Supported Collaborative Learning and Distance Education. *The American Journal of Distance Education*, 10, 37–42.
- Askham, P. (1997) An Instrumental Response to the Instrumental Student: Assessment for Learning. *Studies in Educational Evaluation*, 23(4), 299–317.
- Black, P. & Wiliam, D. (1998) Assessment and Classroom Learning. *Assessment in Education*, 5(1), 7–74.
- Bloxham, S. & Boyd, P. (2007) *Developing Effective Assessment in Higher Education*. Maidenhead: McGraw Hill Open University Press.
- Boud, D. (1990) Assessment and the Promotion of Academic Values. *Studies in Higher Education*, 15 (1), 101–111.
- Cross, K.P. (1996) Improving Teaching and Learning through Classroom Assessment and Classroom Research. In *Improving Student Learning using Research to Improve Student Learning*, G. Gibbs (ed.) Oxford: Oxford Centre for Staff Development.
- Eastman, C. (2006) University and Industry Support of Research in Support of BIM. In *Report on Integrated Practice*, M. Broshar, N. Strong & D. Friedman (eds) Washington DC: American Institute of Architects.
- Entwistle, N.J. & Ramsden, P. (1983) *Understanding Student Learning*. London: Croom Helm.
- Gibbs, G. (1999) Using Assessment Strategically to Change the Way Students Learn. In Brown, S. & Glasner, A. (eds) *Assessment Matters in Higher Education: Choosing and Using Diverse Approaches*. Buckingham: Open University Higher, pp. 41–53.
- Gibbs, G. & Simpson, C. (2004) Conditions under which Assessment Supports Student Learning. *Learning and Teaching in Higher Education*, 1, 3–31.
- Graphisoft (2006) ArchiCAD release 10, interactive training guide Graphisoft.
- Laurillard, D. (2002) *Rethinking University Teaching: A Conversational Framework for the Use of Learning Technologies*. London: Routledge Falmer, 2nd edition.
- Lea, S.J., Stephenson, D. & Troy, J. (2003) Higher Education Students' Attitudes to Student Centred Learning: Beyond 'Educational Bulimia'. *Studies in Higher Education*, 28(3), 321–334.
- Murphy, M. & Scott, L. (2010) Historic Building Information Modelling: A Virtual Learning Tool. *Proceedings of the 38th Conference on Computer Applications and Quantitative Methods in Archaeology*, Granada, Spain, April 2010.
- Ramsden, P. (1992) *Learning to Teach*. London: Routledge.
- Salazar, G., Mokbel, H. & Aboulezz, M. (2006) The Building Information Model in the Civil and Environmental Engineering Education at WPI. *Proceedings of the ASEE New England Section 2006 Annual Conference*.
- Salmon, G. (2002) *E-tivities: The Key to Active Online Learning*. London: Routledge Falmer.

Stiggins, S. (2002) Assessment Crisis: The Absence of Assessment for Learning. *Phi Delta Kappan*, 83 (10), 758–765.

Tse, T.K., Wong, K.A. & Wong, K.F. (2005) The Utilisation of Building Information Models in nD Modelling: A Study of Data Interfacing and Adoption Barriers. *Journal of Information Technology in Construction, ITcon 10*, Special Issue, *From 3D to nD Modelling*, 85–110.

Yorke, M. (2003) Formative Assessment in Higher Education: Moves Towards Theory and the Enhancement of Pedagogic Practice. *Higher Education*, 45, 477–501.

3. Formative Assessment Structures in First and Second Year Architectural Technology to Enhance Student Learning

Catherine Prunty and Maire Crean

School of Architecture

Contacts: Catherine.Prunty@dit.ie and Maire.Crean@dit.ie

Abstract

The multiplicity of learning and teaching theories and strategies that a teacher can use to assist the process of developing greater student learning and engagement is very broad and it can be overwhelming determining what best suits a teacher's particular environment or the type of learning required to be undertaken by the learners. However some in particular stand out from an Architectural Technology perspective that we believe will benefit many other taught project based Engineering and Built Environment courses.

While the subject 'Architectural Technology' is often very closely associated and allied with Architecture, it is in fact quite different. The emphasis is on the construction technologies rather than a design concept. Architectural Technologists also have very strong links with the other built environment professionals that form part of the methodology or process that 'gets buildings built'.

In the world outside academia, graduates of the many different professions and disciplines that form the project teams that work alongside each other – collaborating and contributing their various skills that all amalgamate to complete construction projects of many different sizes and varying complexity. This great collaboration unfortunately does not generally take place between the various Built Environment courses delivered, yet we probably all teach, and the students learn, in a similar experiential manner.

In this paper, we will outline and demonstrate how a technique called 'Crit-marking' can be used in a rigorous, technical and legislative discipline that will not only improve the quality of feedback to the learners, but will be faster and more timely. Promoting greater student engagement as well as nurturing deeper learning, this productive learning activity will help develop and enhance students employability skills along with an improved confidence, all moving towards enhanced personal and professional development.

This particular formative feedback process and method of assessment can be adapted for wider use to suit many different course types as well as become a far more creative and rewarding process for staff and students alike.

Keywords: experiential learning, formative assessment, formative feedback, productive learning activity

Outline of Fellowship Project

Introduction

The successful outcome of this small action research study, whereby the measurement of the effectiveness of formative assessment strategies through qualitative surveys (conducted with the students' consent) which formed the research undertaken for the Teaching Fellowship, has expanded the implementation of Formative Assessment as a teaching and learning methodology in the Department of Architectural Technology. (The data collected and disseminated through this project is available in another paper.)

Upon completion of our current research, information extracted from the strategic student and staff surveys has already helped support our earlier instinct that this strategy 'works', by demonstrating its observed effectiveness. We believe that the particular method we use (called 'crit-marking') which has been adapted from the 'crit' process applied in architecture and other design courses, could now be tailored to benefit other taught, project based Built Environment courses.

In looking at a method upon which to base our research, we initially established that the Gibbs and Simpson model ‘11 conditions under which assessment supports learning’ (2004) was the most appropriate framework for this particular study as there appeared to be a scarcity of information about formative assessment in higher education. The Gibbs and Simpson model was extremely useful and helped us to structure our research.

Context

The current Ordinary Degree, (changing to a Level 8, Honours Degree in September 2010) Bachelor of Science in Architectural Technology, is a constructively aligned syllabus, with explicit assessment criteria undertaken in a continual assessment method in a studio environment. The studio environment mimics an Architectural Office in the ‘real world’ in the manner in which realistic projects are set and in how the students are expected to engage.

Student intake – Average class size 55
<ul style="list-style-type: none"> ● Points 425 (2007), 380 (2008) to 370 (2009)* Demand generally exceeds place numbers ▪ 1st Round CAO ● Mature – circa 10% ● Round ‘O’ – circa 10%

*Reduction in points reflects impact of global recession particularly in the construction industry

Table 3.1 Class size and demonstration of diversity of student (learners) type on B.Sc. programme

Architectural Technology requires that the solutions to technical assembly problems of a building are the requirements that must *work*, for example, to keep water out, or not. The students have a choice of ‘answers’ they can produce, but they need to be sure that their solution is appropriately applied, meeting rigorous legislative and regulatory requirements also. The students are given a ‘problem’ and required to solve it by producing work in studio. They will discuss the project with their peers, studio staff or in a group or workshop style session. Using their relevant subject lecture notes or *webcourses* resource to research, work out one way, revise and re-work, all to arrive eventually at their proposed solution.

‘The “crit” is the review of the learning-by-doing process’ (Flynn, 2005: 11, 16), a formative feedback method usually used to critique or review *original* individual designs. We have adapted this method to assess work that must meet compulsory regulatory and legislative criteria. We also apply the ‘crit’ as a technical review process during projects as well as at the end of a project, post assessment. The ‘realistic’ workload immediately places the student in a productive learning activity which directly generates intrinsic motivation because of its perceived relevance. The Architectural Technology students are expected to complete project work, written assessments and undertake research outside their busy 36 hour contact week.

Studio project work (15 ECTS) per semester
<ul style="list-style-type: none"> ● continually assessed over 2 semesters ● 6 supporting subjects (5 ECTS each) – summative assessment ● Practical ‘<i>learning by doing</i>’ principle – course core ethos <p style="text-align: center;">60 ECTS Total</p>

Table 3.2: Subject ECTS on B.Sc. programme per academic year

While most students successfully achieve the learning outcomes, we feel that this intensity in the past has led to a surface-learning syndrome among them. As on many courses, many students 'write' or 'learn' only to pass on information or declare the level of their learned knowledge as required but not to any great depth. (Despite this, it is a peculiar fact that Architectural Technology students have generally graduated in the past with an exceptional ability to 'think on their feet'. They have demonstrated an excellent work ethic and make reasonably good critical judgements when required – all of which has greatly enhanced their employability potential.) The very practical 'learning by doing' principle, rather than merely accepting 'received', handed down wisdom, like many other courses, is also very much a core ethos of Architectural Technology which must be protected and augmented.

While there is a carefully planned sequence of tasks and projects to help pace the students' learning and time management, the projects which are constructively aligned are also structured to provide sufficient formative tasks. However, we realised that if there is a delay in receiving feedback on a task, as has happened in the past, the student can be uncomfortable or uncertain about what the desired outcome required on any subsequent task should be. Thus, the successful completion of each 'task' must clearly enable the learner to address each new task with recently learned incremental knowledge, skills, confidence and development. Any hold-up to this learning process in the past was a problem.

Tutors Workload

Any delay in providing feedback caused a knock-on effect, inducing stress among the students or learners. Tutors were aware of this anxiety while assessing work and attempting to meet required learning outcomes, and as a consequence the workload for tutors also had become quite onerous. As projects became progressively more complex, so too did the time required for assessment. Attempting to notate every piece of every student's work thoroughly enough to ensure that the feedback would be of good quality and was returned rapidly, created further pressure. Then to discover that despite the written or annotated comments on each student's work, its return invariably triggered further verbal explanations being required by a number of students. This subsequently doubled up on the 'feedback' process as well as consumed time allocated to the next project. Additionally, some of those students who appeared to accept the 'written' feedback comments as given did not necessarily understand the full extent or depth of the tutor's comments which became evident in subsequent project work. This was frustrating and as tutors we frequently wondered about the effectiveness of what we were undertaking. This prompted a thorough re-evaluation of the whole project assessment process.

Time for Change

By examining the situation it became clear that the 'crit' process we already used in a general way could be adapted for use to create a new assessment process that could provide quality formative feedback to each student individually. By arranging and timetabling all staff engaged in teaching in the studio environment to be available together on an agreed day or days to undertake the formative assessment was one of the keys to the success of the whole enterprise. This also reflected how feedback on projects at critical stages in an architectural office would also be undertaken, thus provided the students with an element of 'experiential' learning.

New Feedback Structure

We came to realise that a series of carefully planned tasks and projects which would help pace the students' learning and their time management were required

- to avoid any delay in delivering or receiving feedback

- that each tasks' successful completion should clearly enable the learner to address each new task with
 - incremental recently learned knowledge,
 - confidence, skills,
 - competence and development.

We also recognised the need to be very clear in stating the aims and learning outcomes of each project and task in order to

- improve the quality and speed with which formative feedback is given
- help enhance the depth and level of learning
- provide reflective time

By the staff 'year team' agreeing on these objectives and 'front loading' the detail and very thorough preparation of the brief, the usually burdensome and often very time consuming task of assessment has been transformed. This is achieved by a clear and rigorous marking or grading process conducted during the 'crit-marking' process, which matches the carefully planned project brief. Students and teachers are all very clear about what is required along with what elements carry what assessment weighting within a project or task from the outset.

Crit Marking – How it Works

The marking 'crit', commencing by having *every* student's work displayed on the walls of the studio, immediately allows each student to see how their work looks alongside that of their peers and as they become more familiar with the process they can see where they are positioned within the class group, subconsciously developing 'self' and 'peer' learning.

Following a gallery style walk-about by all, some general observations made by the staff about the project are then delivered to the class group covering the following common points:

- (a) Outlining and reminding the students of the learning outcomes that were expected to have been achieved, based on the brief issued at the beginning of the project.
- (b) Reminding the student group how the project work done is to be assessed.
- (c) How any work may be revised – if required.

Following several questions and answers and some general discussion with the class group, the studio tutors then break off into pairs initially to examine each student's work. Each staff member has a copy of the original brief issued to the students along with a separate Marking Sheet which identifies the Project, lists each student's name, and allocates an individual percentage under each of the following examples of headings:

- Demonstration of Technical Knowledge,
- Layout and Presentation (both visual and verbal, each marked separately) and
- Competence Demonstrated.

The students are then encouraged to talk about their project as the staff 'meets' each student, while standing beside their work. Students or their colleagues record any feedback comments of significance by the teaching team at this point. Research material can also be included, usually in a booklet form and displayed on an adjacent table to support the student's work. Other students awaiting their turn are encouraged to listen, observe or take part in the discussion. Tutors may indicate during the course of the discussion that something may be 'wrong' yet will talk through with the student how it can be 'fixed'. Frequently a technical issue or misunderstanding which may be common to several projects may require an informal workshop to take place on the spot which

includes and informs the whole class group.

Often in the course of the discussion with the student a tutor can glean whether the student understood what they were doing, or not. As CAD forms such a large portion of the course, and students can easily 'send' each other information electronically, the 'crit' process helps eliminate the complexities of any copied or downloaded work.

As staff then progress to the next student's presentation, they individually award marks for the work just viewed onto the structured 'Marking sheet'. These marks are then collated jointly by the staff *after* the session with the class group outside studio time, where they are then discussed and refined by the teaching team, prior to posting the grades awarded. The grades awarded are provisional, giving each student an indication of how they are doing. As the syllabus is taught in a continuously assessed framework, each student knows that they can revise their work towards their final grade at the end of the academic year.

This whole process of assessment generally can be done in one full day. With more complex projects, however, it could run over two days. While it is tiring for teachers, it is also very rewarding. One can perceive immediately improved incremental interaction, a significant improvement in the students' verbal skills, and tutors get to know their students better.

Student and Staff Feedback

The student feedback has been that they are very pleased to get their results so quickly, and can work to improve their grades immediately on subsequent projects. We have also observed an improved effort in taking notes and writing down any feedback during the individual 'crit' on the students' part. Almost as important, tutors have discovered that this method of 'formative feedback' assessment is a really far more pleasant, interactive task than the customary summative assessment undertaken over weeks previously. All staff recognise that the project brief preparation and pre-'crit' and post-'crit' meetings and discussions are extremely important, stating the required learning outcomes clearly and the method of assessment of each part.

Because of the perceived informality and collaborative quality of the feedback, even the most inhibited student has no difficulty with this method of assessment if it is handled sympathetically.

Project Summary of Findings

The introduction of formative feedback and formative assessment through the improved studio 'crit' process has helped enormously towards the rapid improvement in quality of much of the student project-based work, which was evidenced at the end of year exhibition and commented on by the external examiners. The pass rate between projects had improved as even weaker student's grasped concepts and understood their purpose. (By the end of the students' first week in college it was discernible that the atmosphere within the class group was more open and friendly than in previous years at this stage of the 'settling in process' for first-years.) The qualitative survey conducted as part of this study, observes that 89% of first year students and 100% of the second year students surveyed confirmed preference for the 'marking crit' as a form of assessment, which has underpinned our initial anecdotal observations.

Improving the quality and speed with which formative feedback is given to the students *immediately* after the completion of each task or project has helped enhance the depth and level of learning as well as alleviate any anxiety that may have arisen, which was common when there was unavoidable delay. Student retention also seems to have improved, but this is from observation only and will

require further research to be undertaken to support this particular aspect.

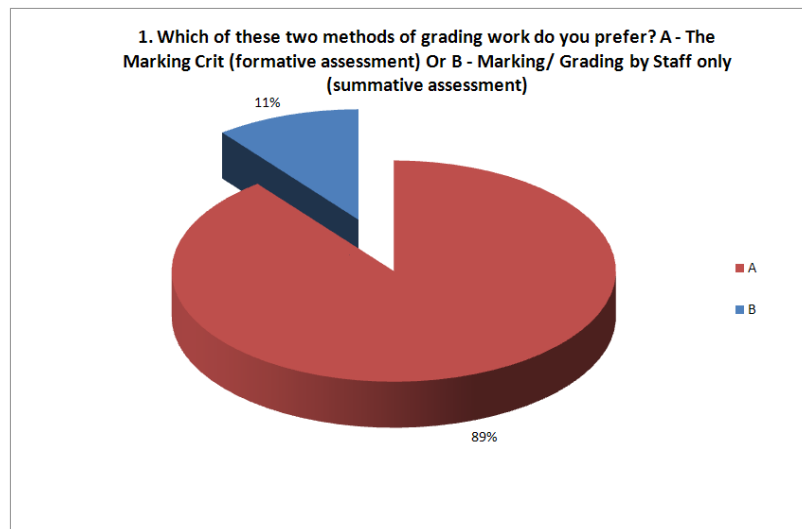

Figure 3.1: First Year DT105-1 Online Survey – Assessment Preferences: Mid Semester 2 Academic Year 2009–2010

The improvement in the level of self assessment or reflection on learning, along with work done as individuals and in groups has developed improved peer and teacher dialogue *around* learning. An improved culture of motivational philosophy and self-respect has also emerged. In conclusion, this study has helped the students to define their own understanding of learning as well as to enhance their learning experiences.

This responsibility the students have taken towards their own learning will also remain with them for the rest of their lives. Through employing improved teaching methods (and enhancing those existing methods that work) for the wide diversity of first year student ‘types’ and in light of external economic factors reducing numbers of teaching staff, all whilst delivering a good first year experience is an ambition that we may yet realise, despite resource constraints.

Conclusion

The positive feedback and observations made by both students and staff has encouraged us to bring this method of feedback and assessment forward into the new Honours Degree programme commencing in September 2010, refining it further as we, as teachers, also learn more through the process. Regardless of developments in e-learning or computer technology, as we are still dealing with human beings, this form of formative assessment and feedback will benefit other project based curricula, or disciplines. Posters, displaying a synopsis of students work, along with a dialogue *around* learning deliver immediate and effective verbal feedback, whether peer or teacher based.

The argument has been made that by implementing the Gibbs and Simpson framework ‘11 conditions under which assessment supports learning’ (2004) as a ‘check list’ to support our method which has enhanced all students’ learning and development, all within existing resource limits in Architectural Technology.

Using two-stage assignments with feedback on the first stage, intended to enable the student to improve the quality of work for a second stage submission, which is only graded,

Cooper (2000) has reported how such a system can improve almost all students' performance, particularly the performance of some of the weaker students.

(Gibbs & Simpson, 2004: 24)

The rate with which educators research and share new methods to enhance teaching and learning, despite economic constraints and external criticisms, is to be applauded. However, course managers must not view any changes in emphasis of teaching that enhances learning, such as this method of formative assessment and formative feedback, as being a 'solution' to reducing teacher numbers. The argument is made that by nurturing deeper learning through improved reflection on 'knowledge' learned, and by promoting greater student engagement, students as individuals and in groups will develop skills to improve their potential employability and confidence, while moving towards greater personal and professional growth.

Future Work and Recommendations

The long term strategic aims of our research are:

- to improve the approach to assessment practices, in particular formative, in undergraduate Architectural Technology programmes in the Dublin School of Architecture
- to strengthen the link between teaching and research in the discipline of Architectural Technology and other Engineering and Built Environment education disciplines
- to foster excellence in undergraduate learning and teaching in both Architectural Technology education and Engineering and Built Environment education.

Acknowledgements

We wish to acknowledge the support and funding of the DIT Research Fellowship 2009-2010 by the following:

References

Flynn, P. (2005) *Critting the 'Crit' in the Education of Architects: from Bauhaus to Bolton Street*. Master's Thesis. Dublin: DIT Learning and Teaching Centre.

Gibbs, G. & Simpson, C. (2004) Conditions Under Which Assessment Supports Students' Learning. *Learning and Teaching in Higher Education*, 1(1), 3–31.

Yorke, M. (2003) Formative Assessment in Higher Education: Moves Towards Theory and the Enhancement of Pedagogic Practice. *Higher Education*, 45(4), 477–501.

Yorke, M. (2007) Assessment, Especially in the First Year of Higher Education: Old Principles in New Wrapping? From the *REAP International Online Conference on Assessment Design for Learner Responsibility*, 29–31 May, 2007.

Bibliography

Andrade, H.L. & Gizek, G.J. (eds) (2010) *Handbook of Formative Assessment*. London and New York: Routledge Taylor Francis Group.

- Biggs, J. (2003) *Teaching for Quality Learning at University*, 2nd edition. Berkshire: SRHE & Open University Press
- Blanchard, J. (2009) *Teaching, Learning and Assessment*. Berkshire: Open University Press/Mc Graw Hill Education.
- Bloom, B.S., Hastings, J.T. & Madaus, G.F. (1971) *Handbook on Formative and Summative Evaluation of Student Learning*. New York: McGraw-Hill.
- Brown, S. & Glasner, A. (eds) (1999) *Assessment Matters in Higher Education: Choosing and Using Diverse Approaches*. Buckingham and Philadelphia: SRHE & Open University Press.
- Carless, D., Joughin, G., Ngar-Fun Liu et al. (2006) *How Assessment Supports Learning: Learning-orientated Assessment in Action*. Hong Kong: Hong Kong University Press.
- Cooper, N.J. (2000) Facilitating Learning from Formative Feedback in Level 3 Assessment. *Assessment and Evaluation in Higher Education* 25 (3), 279–291.
- Cowan, J. (1998) *On Becoming an Innovative University Teacher: Reflection in Action*. Buckingham: SRHE and Open University Press.
- George, J. & Cowan, J. (1999) *A Handbook of Techniques for Formative Evaluation: Mapping the Student's Learning Experience*. London: Kogan Page and Sterling, VA: Stylus Publishing.
- Gibbs, G. & Dunbar-Goddet, H. (2007) *The Effects of Programme Assessment Environments on Student Learning*. Report submitted to the Higher Education Academy, February 2007. Oxford Learning Institute, University of Oxford.
- Jarvis. P. (ed.) (2006) *The Theory and Practice of Teaching*, 2nd edition. Abingdon and New York: Routledge Taylor Francis Group.
- Nicol, D.J. & Macfarlane-Dick, D. (2006) Formative Assessment and Self Regulated Learning: A Model and Seven Principles of Good Feedback Practice. *Studies in Higher Education*, 31(2), 199–218.

Faculty of Business

4. Action Accounting ‘Untying the Accountancy Knot’

Alice Luby
School of Marketing

Contact: Alice.Luby@dit.ie

Abstract

Action Accounting ‘Untying the Accountancy Knot’ is an innovative cross-faculty collaboration to develop e-learning activities to enhance and improve the learning experience of students. The cross-faculty Action Accounting project team was established in 2008 and includes accountancy lecturers from the College of Business and the College of Arts and Tourism as well as members of the Learning Support Services and the Learning Teaching & Technology Centre.

Accounting lecturers had observed that many first year students had been struggling with the accounting modules and this often resulted in high levels of examination failure and low retention rates. They also recognised the need to cater more adequately to students who have learning disorders such as dyslexia, as well as those for whom the traditional lecture environment is a barrier to learning.

The ultimate aim of Action Accounting is to deliver e-learning activities and module content with student centred learning needs as its main focus, and to make learning accountancy more effective for students and subsequently more enjoyable. To achieve this, Action Accounting will:

- enhance the student learning experience
- improve student retention
- accommodate different learning styles
- increase the variety of learning conduits and thus facilitate ‘non-traditional’ students.

Outline of Fellowship Project

Introduction

The Action Accounting project was initiated because it was recognised by a group of accounting lecturers that many students have difficulty with accountancy. This is partly because some students see accountancy as old, dusty and uninteresting. Others view it as a non-core module and unimportant compared to more targeted and specific modules. As a result students may not become involved or engage with the material. Often students develop unfavourable preconceived perceptions about accountancy and as a result underperforming at accountancy can become a self-fulfilling prophecy. Those who have a dislike of numerical content and lack confidence in the area become disillusioned very early in the module and disengage.

Pedagogical assumptions underpinning this project are that learners learn more effectively and efficiently when they are in control of the learning pace and that feedback is a critical part of effective learning. In addition it was agreed that active involvement is more likely to lead to more effective outcomes than passive involvement.

The Action Accounting Project agreed on a technology based approach. According to Hutchins (2001) when technology was used in their courses, students were found to:

- perform better,
- have a heightened satisfaction, and more fulfilling experiences, and
- engage in more equitable and diverse communication.

In addition, McDowall & Jackling (2006) found that ‘Computer Assisted Learning programmes, introduced as part of the curriculum in accounting studies, have the potential to positively impact on

academic performance’.

This Action Accounting Project will provide an innovative and alternative approach that will enhance the student learning environment and at the same time improve the usability and accessibility of resources for dyslexic students. The team decided to find an e-learning solution in the form of electronic learning activities which could be used remotely, as an additional resource to build on the lecture experience. The e-learning activities could be accessed as frequently as the student required and at a time that suited them. Vitaly, the e-learning activities must be interactive and require the student to engage rather than passive tutorials. In addition, the e-learning activities would provide immediate help, feedback and encouragement. It is also envisaged that the e-learning activities can be modified to cater for the various learning styles.

Project Aims

The ultimate aim of Action Accounting is to deliver module content in the form of interactive e-learning activities, with student-centred learning needs as its main focus, and to make learning accountancy more effective for students and subsequently more enjoyable. To achieve this, Action Accounting aimed to

- enhance the student learning experience
- improve student retention
- accommodate different learning styles
- increase the variety of learning conduits and thus facilitate ‘non-traditional’ students.

This project is an innovative cross-faculty collaboration to develop e-learning activities to enhance and improve the learning experience of students. By catering for individual learning styles and needs, a more engaging, student-centred approach to learning accounting will be facilitated. The Action Accounting Project fitted a number of the Fellowship strategic themes identified for 2009/2010 as indicated in Table 4.1.

Theme	First Year Curriculum	Student Engagement & Retention	Curriculum Development
Diversity	These projects aim to explore and compare different strategies to support learner engagement within first year undergraduate programmes.	Projects focus upon the use of strategies to include, engage and retain non-traditional students within existing programmes.	
e-learning	Projects aim to make use of online resources to encourage active learning and information literacy among first year students.	Projects aim to improve student retention through the use of e-learning technologies.	Projects focus on the use of e-learning technologies to engage students and motivate them to more active learning.

Table 4.1: Fellowship strategic themes identified for 2009–2010

The project specifically targets those who find the traditional lecture setting a barrier to learning as well as students with disabilities like dyslexia. Dyslexic students constitute the largest percentage of disabled students in DIT. However, many of the current traditional teaching methods fail to cater for the needs of these students. Research has shown that dyslexic students find information and communication technologies or ICTs helpful to the learning process (Rooney 2006). A key objective of this project is to create a set of accessible online interactive e-learning activities which cater for

the learning needs of dyslexic students.

Ultimately e-learning activity software will be developed with a high level of interactivity and provide students with a significant degree of control over their own learning. The format and context of the e-learning activities will provide an interesting flexible and interesting environment to learn and create an alternative for students who may struggle in the typical lecture setting.

Perceived Benefits of the Project

Discussing the effect of digital technology at a conference in Cork, Lord David Puttnam stated that it 'has fundamentally reshaped the way in which young people engage with, and make sense of society'. The Action Accounting Project aims to maximise the potential of digital technology to enhance the learning experience of those studying accounting.

The DIT has published its Strategic Plan for 2009–2011, setting out its vision for the institute and the ways in which that vision can be achieved. The document also notes that one of the chief aims of the Government with regard to higher education is to increase participation rates, with a particular focus on improving access for those from disadvantaged backgrounds, and those with disabilities. In relation to the latter group specifically, the plan is to double, by 2013, the number of students in higher education with sensory, physical and multiple disabilities. *The immediate challenge facing DIT then is in supporting its teaching staff in efficiently and effectively adapting their teaching approaches to accommodate these students and to promote an inclusive learning environment so as to ensure that they do not leave the programme early due to failure, or indeed fear of failure.*

Action Accounting will provide an additional tool that will be particularly useful for first year students who are struggling with the numeric concepts covered in accounting modules. The significant increase in numbers of disability students and access students will have put additional pressure on student support services who will be working in an environment dominated by budget cutbacks. Action Accounting will have a vital role for students who may be facing a reduced level of support due to budget cutbacks.

Action Accounting also addresses DIT's core value of being student centred and being inclusive where diversity is valued. Specific benefits for students centre around the fact that the e-learning activities can:

- accommodate different learning styles
- enhance the student learning experience
- provide an accessible tool for those struggling to cope with the course material or the traditional lecture environment
- provide a means of building confidence in a topic
- provide students with disabilities an alternative method of learning
- provide access students an additional tool to practice at their own pace and build their confidence.

The e-learning activities should be a valuable tool for students with disabilities such as dyslexia who may be unable to get maximum benefit from accounting material in its traditional form. The e-learning activities will be presented in a form suitable for dyslexic students with a significant degree of customisation to allow for different requirements for a diverse range of issues. The project team includes a learning support officer and a student with dyslexia. The e-learning activities will also be an additional resource for access students. Access students may find the third level setting challenging and may be reluctant to show if they are struggling with content in the lecture

environment. The e-learning activities will provide them the opportunity to work interactively with module content, and the hints and feedback will help build knowledge and confidence. Ultimately, the e-learning activities should provide students who are struggling the opportunity to work with module content in an alternative environment at their own pace. It should prevent early disengagement with module content and help with student retention and success levels. Potential beneficiaries of the project would be:

- students and lecturers
- disability officers
- student retention staff
- student access departments
- learning teaching and technology centres.

Action Research Approach

Methodologically, the development team took an action research approach, wherein incremental development of the final product has been influenced both by our own experiences and by student feedback. As can be seen from the project map presented below, there were a number of key stages where software samples were piloted, evaluated and modified until the ultimate solution was found. At each evaluation point, key feedback proved vital in directing the form of resources being developed.

Project Map and Timeframe

The project which commenced towards the end of 2008 has a completion target of the end of 2010 for the first suite of e-learning activities. This suite of e-learning activities covers module content for three key early components of a first year accounting syllabus. Key timelines are as follows:

Date	Activity
Nov. 2008	Sample software developed
Dec. 2008	Pilot testing and student feedback
March 2009	Sample software developed
April 2009	Pilot testing and student feedback
Nov. 2009	Revised software developed
Dec. 2009	Pilot testing and student feedback
Feb. 2010	Sample scenario drafted
March 2010	Additional scenarios drafted
April 2010	Web based solution sought
May 2010	Detailed design specification and systems requirements brief
June 2010	Agreement with WeDoWebsites
begin. Sept. 2010	Software to be delivered by designers
mid Sept. 2010	Scenarios entered and system tested
end Sept. 2010	Pilot testing
Oct. 2010	Use on modules

This suite of e-learning activities covers module content for three key early components of a first year accounting syllabus.

Key Stages

Funding from a *Learning and Teaching Award*, as well as a small grant from *NAIRTL* (the National

Academy for Integration of Research, Teaching and Learning) allowed the Action Accounting Project Team to research, design and develop some prototype software demonstrating e-learning activities, and the subsequent pilot testing of these activities with students. The two initial software samples were developed in *Flash*. The first pilot highlighted the need to widen the project scope to meet the needs of disability students when a dyslexic student indicated that she couldn't read the text because the font appeared distorted.

From early pilots, the team outlined a robust suite of e-learning activities aimed at engaging and supporting these struggling students through their first year accountancy module and began developing an additional prototype. They also identified key issues for presentation and navigation.

In preparing software samples for the third pilot the team used *Dreamweaver* so the information could be presented in more complete setting, along with using *Articulate* in an attempt to overcome some of the problematic navigation issues previously encountered with *Flash*. However, the pilot testing still indicated issues with usability, navigation and setting. It was felt the design of professional e-learning activities, to the level the team required, was beyond the skills of the team and in-house development. However, the team was concerned that getting a professionally developed solution would be costly and that it may not be possible for the team to build additional scenarios and activities themselves. All student feedback had required multiple scenarios and activities for each topic to allow them to reinforce their learning.

A brief was prepared and a company (*wedowebsites.ie*) provided an ideal solution. Additional funding from LTTC and contributions from several Heads of School have been instrumental in facilitating the professional solution. The e-learning activities will be developed from an extensive MySQL database of variables from which a wide variety of accounting scenarios can be built and made available to the students; these will be presented on a web-based platform and will be fully interactive. Importantly, members of the Action Accounting Project Team, and other lecturers, will be able to maintain and add additional scenarios and activities without additional professional development. The project will have a student-friendly, web-based learning set of e-learning activities running on a MySQL database which will allow a variety of scenarios and activities to be generated for three key early topics in accounting.

Project Evaluation Process and Lessons Learned

It is important to point out that the project is ongoing and has not been completed; therefore the evaluation process only covers the research process and project to date. It is not possible to evaluate the success of the project as yet or to establish whether the aims were achieved. However, lessons have been learned already.

The action research approach adopted by the project was beneficial because at each stage, the evaluation highlighted key issues that the project had to consider and overcome. There were three separate software pilots and evaluations before the scenarios and final brief were prepared. From the onset student feedback on the broad idea was quite positive and it was seen as having good potential. However, some negative feedback on the 'technology' was encountered.

Important feedback included:

- The first software sample piloted could not be read by a dyslexic student who was randomly selected to test the software. This in effect drew awareness towards a significant group of students who should be catered for and the project moved from its initial aim and indeed the aim of the project was widened. *The way and the manner in which the material is presented can have a significant impact on the student's ability to learn from the resource.*

- It became obvious that we were not reaching our target group as some struggled with the prototype. It was found that a significant number of students who lacked confidence with numbers also lacked confidence with technology. They found that the navigation was not intuitive and that it was off-putting. *Therefore, it was accepted that navigation and ease of use was vitally important, particularly for the target groups.*
- Students wanted the software to be different to tests and on-line assessments and early pilots were not considered to be interesting and appeared too like a test. *The scenarios need to be realistic and creatively presented with lots of hints and feedback.*
- Students indicated that they wanted lots of options to try similar concepts over and over again and to be provided with feedback and tips if they were stuck. *Therefore, it was accepted that the software needs to have a number of scenarios with plenty of transactions.*
- Students indicated the need to have the activities more integrated and suggested that the setting/context of each online activity be shown more clearly. *This could be achieved perhaps by providing the aims and overview of each scenario and transaction.*

Future Plans

There is plenty of scope for further development of the e-learning activities. This suite of activities only covers three early topics from a first year financial accounting syllabus. There is a need to develop subsequent e-learning activities for the remaining sections of the syllabus. In addition a complete set of e-learning activities could be developed for management accounting. Furthermore, the approach could be modified to provide business relevant scenarios for more advanced accounting syllabi including Financial Reporting and Advanced Management Accounting.

Fellowship Impact and Recommendations

The teaching fellowship has positively impacted the Action Accounting Project. The fellowship provided the opportunity for one of the team members to drive the development of the third software sample and to pilot the approach. It also provided the fellow with the time to prepare the very detailed brief that was needed for the professional development of the e-learning activities. In addition, new ideas for how the project could be presented and refined were obtained from other teaching fellows. The teaching fellowship does draw attention to a project and help elevate the importance of that project in the mind of the fellow.

However, as the project is not complete, it is difficult to make specific recommendations at Institute level. It is too early to establish how the project impacted the student learning experience, retention, assessment success, and catering for non-traditional students.

References

Hutchins, H.M. (2001) Enhancing the Business Communication Course through WebCT. *Business Communication Quarterly*, 64(3), 93.

McDowall, T. & Jackling, B. (2006) The Impact of Computer-Assisted Learning on Academic Grades: An Assessment of Students' Perceptions. *Accounting Education*, 15(4) 377–389.

Puttnam, D. Lord (2010) *Education and the Digital Society*. IIEA Conference, Cork.

Rooney, P. (2006) Learning Technologies and Dyslexic Students at Third Level. Paper presented at Fourth Annual Conference on Teaching and Learning in Higher Education, National University of

Ireland Galway, June 2006.

5. Curriculum Development for the Delivery of a Standardised Business Research Methods Module¹

Conor Horan
School of Marketing

Contact: Conor.Horan@dit.ie

Abstract

The goal of this project is to provide a framework for a revised delivery of Research Methods across the College of Business. This project considers a number of issues and misconceptions that needed to be overcome regarding the delivery of Research Methods (RM) as a module and the recognition of RM as a discipline. This includes the misconception that ‘commonality’ of the student cohort was required for the delivery of RM and the issue of student disengagement. The outputs of this project are Module Descriptors for a generalised Research Report, case studies representing best practice in other institutions and the introduction of the Research Skills Development Framework through pedagogic development.

Key words: curriculum development, modularisation, research methods

Outline of the Fellowship Project

Introduction

The Research Skills Development Framework (RSDF) is presented as a way to encourage discussion on how to teach Research Methods across the College of Business. This is done to illustrate that commonality among students was not required to fully understand the process of research. The next stage of the process was to tackle student disengagement regarding the discipline of RM. The RSDF is proposed as a way to allow student researchers to take control of the development of their own research skills and reduce possible disengagement from the research process. The final stage of this process is to institutionalise best practice into module descriptors and validation documents of developing courses.

Evaluation of the Project

This project was evaluated on the basis of its implementation. Revised Module Descriptors have been implemented across two M.Sc. programmes: the MBA Programme and the M.Sc. Business & Entrepreneurship for the 2010–2011 academic calendars. Case studies illustrating this approach in other institutions are presented to support the use of the RSDF in pedagogic development. This was important so as to get buy in from the academic cohort. Student disengagement is dealt with through the development of activities that build awareness among the student cohort as they take responsibility for developing their own research skills. This will be evaluated at the end of the first semester and Academic Year 2010–2011 through a survey technique. Ongoing evaluation is on the basis of college discussions at College Day, Teaching and Learning Conferences and Management Forum where this project was presented and discussed. The logic behind the Research Skills Development Framework (RSDF) is important in securing a different perspective on how Research Methods should be approached. The presence of this conversation was timely. Recessionary times demand more efficiency in teaching delivery; an acceptance of combining classes was seen in that context.

¹ Prepared as a part of the Dublin Institute of Technology Teaching Fellowship 2009-2010. Funding for this project has been made available through the DIT Teaching Fellowship Scheme & The School of Marketing, DIT. A special thanks goes to Marian Fitzmaurice of the LTTC for her support in completing this report.

Fellowship Project Outputs

Teaching Outcomes

The teaching experience and the experience of the wider faculty was assessed to ensure that the 'research agenda' of the College of Business is supported, enhanced and improved.

Module Descriptors for both the Research Methods (RM) Module and resultant Research Report Module Descriptor were presented and finalised. These have already been validated on two Masters' programmes. The Research Methods Module is written with a number of options in place for assessment and content delivery. The content, and/or activities, of this module should be linked into the skills required to complete the assessment for the module and to be firmly placed to allow students to move toward completing the Research Report. This module focuses on explaining the 'research process' and the multiple forms this process can take. The Research Report Module is written so as to link specifically to the Research Methods module that preceded it. The term 'Research Report' is used as it reflects multiple outputs from the research process. An additional outcome that will come from this is to re-write module descriptors with an RSD-based approach. This was partially completed and can be implemented on a pedagogic level. However a rubric (implied or explicit) for assessing this will take longer to implement. For now the RSDF is used as a teaching aid.

Administrative Outcomes

The clear outcomes of this project will be the possible and successful combining of RM class cohorts from dissimilar disciplinary backgrounds. Where this improves standards and streamlines administrative duties will be used to evaluate the success of this project review. Currently this has been proposed and is being considered by management. A common module for Research Methods will now be run in the first semester of the academic year 2010–2011. Administratively this would be open to all M.Sc. students (including a proposed M.Sc. in Research in the long term) and M.Phil. students. M.Phil. students will also be offered a chance to take the RM module. Those intending to move onto the Ph.D. register would be required to complete extra modules in the future (as a part of a proposed M.Sc. in Research Methods). This module will run at a reduced number of times as this tackles the misplaced **assumption of cohort commonality**. One proposed way to run this would be to allocated three or four sessions spread across day and evening slots. Students would sign up for these slots. Plenary Sessions would also be run where students are exposed to alternative approaches to doing research. These sessions might require two facilitators to reflect a dialectical approach to delivering this part of the module. Most of these recommendations will not run in 2010–2011 but management are moving in this direction.

Student Outcomes

The student experience in relation to their perspectives of the RM module and the college support provided to meet the college's research agenda is clearly outlined at the commencement of all programmes. The clear and appropriate running of RM classes from an administrative and college perspective will also need to be evaluated on the basis of assessing **student disengagement**. The possibly current use of Q5 and Q6 forms can be used to assess student perspectives of the process. Additional surveys can be used to gauge the potential changes being proposed and the level of usage of the RSDF. Content of the Module will be discussed within the context of the outcomes for students and how their experience of the module will alter. Of course there are also administrative and teaching outcomes that will be affected by the content. The proposed structure will be the following.

A Proposed Module Structure

Common Methods for all Participants – weeks 1 to 8: Common activities to bring students toward the skills required for their Research Report. This will be assessed through RSD based activities and 100% continuous assessment. This is a common eight weeks of delivery covering a broad spectrum of methods.

Specialist Disciplinary Linked Methods – weeks 9 to 12: These weeks will be covered by lecturers/researchers within the specific disciplines and tackle specific methodological concerns that are more closely linked to particular disciplines. For example on the M.Sc. in Advertising, brand recall, content analysis and semiotics might be more relevant to that particular cohort than studying econometrical models that might be more relevant to a student in the M.Sc. in Finance. The goal here might be to provide a suite of topics covering broader and specialist methods.

Theoretical Framework and Discussion

From considering cohort commonality and student disengagement this paper proposes the use of the Research Skills Development Framework (RSDF) as a way to manage these issues. This section looks at these two theoretical constructs.

The Assumption of Commonality

This research project looks at the feasibility of delivering a standardised yet flexible RM Module across the College of Business (and potentially across the Institute). In the context of this goal many colleagues have concerns regarding the need for ‘Disciplinary Commonality’ among student cohorts; i.e. it is not possible to effectively deliver a standardised curriculum for students from disparate disciplines with distinct and diverse research traditions. This assumption leads to a groupthink within-paradigmatic perspective. Kuhn (1962) discusses what is understood as ‘normal science’ and that paradigms are judged within the rules of established disciplinary paradigms. For this reason students should be exposed to alternative approaches where methodological paradoxes are exposed. The cases presented in the full report illustrate how leading research universities teach RM as a common module to all students across multiple disciplines debunking the assumption that disciplinary commonality is required. The Research Skill Development Framework (RSDF), as illustrated below, can be used to show how many different forms of ‘inquiry’, across different disciplines, can be catered for within a core module. The RSDF also caters for multiple forms of research output, multiple research traditions and multiple research philosophies.

Decreasing Student Disengagement

Due to the frustrating aspects of the research process where leaps of faith are required and decisions are to be made without knowing what the outcome will bring, students tend to want to avoid these key decisions and not engage with the more critical or creative aspects of the RSDF (shown below). Harrington and Booth (2003) have written extensively on the concept of student disengagement. This fear can be overcome through a scaffolding process where steps are outlined and the ambiguity within these steps confronted as an aspect of the process rather than as something to be avoided. A specific aim of this research report is to consider how to decrease the prevalence of student disengagement. Two main recommendations are:

- to link ongoing module activities with different aspects of the RSDF and to illustrate this linkage so that students can see how their tasks are geared toward their research skill development over the course of their research
- to ensure that the specific Research Report from the research process is illustrated relative to the RSDF so that to complete the report the student will become aware of the skills required to do so.

The facet of inquiry and the autonomy of the student within their research project are both key to decreasing student disengagement. The next section discusses the RSDF in more detail.

Overview of the Research Skills Development Framework

The 'level of student autonomy' in arriving at a research topic represents an important consideration (Horan 2009).² This in conjunction with the second construct of 'facet of inquiry' delineates three different forms of research (Willison & O'Regan, 2007). It should be noted at this point that the research process requires you to oscillate across the different levels and requires different aspects of inquiry to be considered at different stages. If the RM process is considered from a skills development perspective all students should be brought from the top left hand side of the framework in undergraduate programmes to the bottom right hand side of the framework as the student progress to doctoral research. Students will be confronted with many of the issues raised in the middle of the framework as they move toward an 'open inquiry' where they synthesise, analyse and apply new knowledge.

Three broad scenarios, illustrating research across all disciplines are discussed in more detail in the full report.

- Closed Inquiry for Undergraduate Research Students – Developing Basic Research Skills
- Closed to Open Inquiry for M.Sc. Research Students
- Autonomous Open Inquiry for Ph.D. Students

Closed Inquiry for Undergraduate Research Students – Developing Basic Research Skills:

This form of inquiry is outside the scope of this particular project; however, a few items of note should be raised here. Research Methods for undergraduate research is not taught across the college in any consistent manner, however, Market Research and Statistical Course including SPSS and Critical Thinking are taught. The ideal here would be to have a consistent module that all undergraduate students would take to bring their research skills to Level 2 and at least to a facet of inquiry.

Why is this important? A standardised research skills module would thus differentiate itself from a RM Module at M.Sc. level and correctors' expectations could be managed more clearly with the RSDF rubric. Student without the skills (listed in Level 1 and 2) can be given a clear pathway with tasks to meet so that they come to an expected standard. Self assessment exercises can be conducted early in the research process to illustrate gaps in student knowledge.

Closed to Open Inquiry for M.Sc. Research Students

Whereas there is no distinct point on the RSDF that reflects M.Sc. level research at Level 9 NQAI, students are expected to move into Level 4 of the RSDF where they research at the level of a student initiated open inquiry within structured guidelines. At this level synthesis and analysis are required. The expectation to 'apply new knowledge' often does not occur as this is seen more at a Ph.D. standard. In any case from the diagram students are expected to move closer to the bottom right hand corner of the framework. Without the basic skills in Levels 1 and 2 it is hard to expect students commencing an M.Sc. to come up to speed. The phenomenon of 'student disengagement' in RM classes is widely recognised (Harrington & Booth 2003; Horan 2009). Through appropriate scaffolding and research skills development in undergraduate programmes gaps can be narrowed and disengagement minimised. Why is this important? Getting students to ask rigorous researchable questions based on new understandings (Level 3, Facet of Inquiry E) is an arduous process and students fail to timely develop their analytical skills.

² For more information see an earlier version of this paper at the DIT Arrow Repository <http://arrow.dit.ie/buschmarcon/1/>

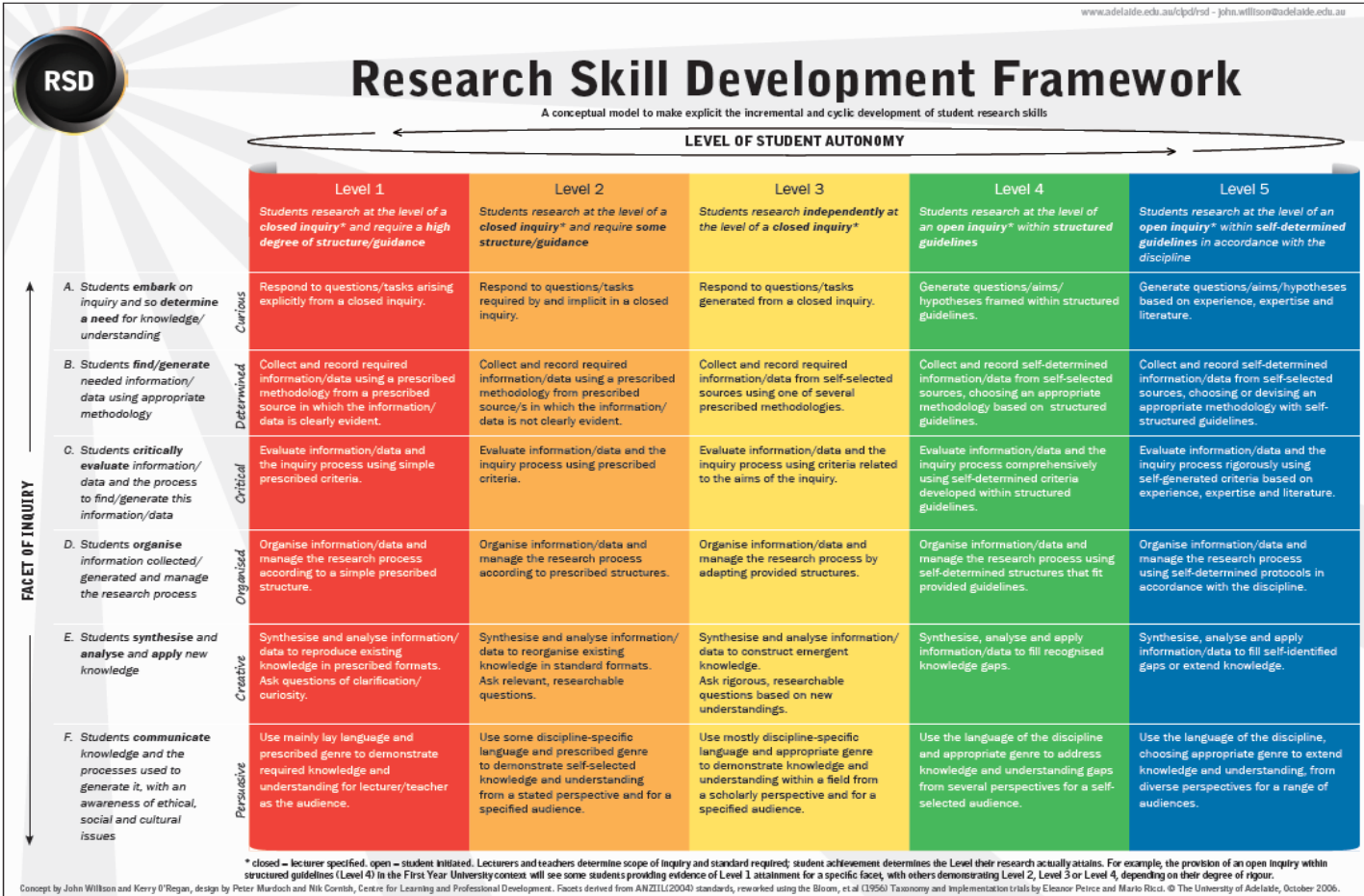

Autonomous Open Inquiry for Ph.D. Students

Students move toward an open inquiry as a part of a M.Sc. programme. As in the M.Phil. some structure relating to research skill development reflecting academic requirements, i.e. research philosophy and the structure of argument, might be appropriate. Open inquiry (Levels 4 and 5) is more within the confines of the Ph.D. requiring groundwork. For this reason it is envisaged that all M.Phil. students would be required to sit the RM programme to as to ensure a basic standard. This should occur within a structure of delivery that ALL M.Sc. students are exposed to within a 'research clinic' meeting with the institutional requirements as outlined at the beginning of this report. This opens up an opportunity to deliver an M.Sc. in Research; a taught programme dedicated to research methods and all its facets of inquiry as illustrated in the cases presented in this report.

Further Recommendations for the College and Institute

Long-term recommendations include the development of the M.Sc. in Research Methods. This will require the full development of other associated modules that may be run in blocks for all students doing an M.Phil. by research or even a Ph.D. This might also be run as a 'Research Clinic'. This clinic might help coordinate a wider initiative that looks at seminars and other events across the College of Business that a research related.

Proposed Future Research

This project's rationale is broader and wider than the issue presented here as it provides a better understanding for the feasibility of teaching RM in a more formalised and standardised pattern across the college while fostering support for specialist and evolving methods within the module. Students will be guaranteed a consistency of experience while specialist areas will be catered for more effectively. Future research will provide a better understanding of potential cost savings while at the same time increasing the College's Research Profile. Spin off projects for M.Phil., Ph.D., Hothouse companies is also envisaged and the development of college and institutional capabilities to ensure that need to be researched and put on a solid footing. This project is a first incremental step toward positioning the College of Business, to cost effectively promote research and innovation through the delivery of a standardised RM module.

References

- Harrington, J. & Booth, C. (2003) *Research Methods Courses in Undergraduate Business Programmes: An Investigation – A Report to the Learning and Teaching Support Network*, Business Education Support Team, Bristol Business School, July 2003
- Horan, C. (2009) Research Topic Selection and Development: Suggested Guidelines for the Student Researcher. Chapter 2 in J. Hogan, P. Dolan & P. Donnelly (eds), *Approaches to Qualitative Research: Theory and its Practical Application*. Cork, Eire: Oak Tress Press.
- Kuhn, T.S. (1962) *The Structure of Scientific Revolutions*. Chicago: Chicago Press.
- Willison, J. & O'Regan, K. (2007) Commonly Known, Commonly Not Known, Totally Unknown: A Framework for Students Becoming Researchers. *Higher Education Research and Development*, 26(4), 393–409.

Faculty of Engineering

6. Improving the Quality of PBL Modules in an Engineering Programme

Gavin Duffy,

School of Electrical Engineering Systems

Contact: Gavin.Duffy@dit.ie

Abstract

Engineering programmes have a strong reputation in the delivery of technical knowledge and skills. Graduates need equally high levels of competence in personal and professional skills to not only improve themselves and meet the existing requirements of employers and professional bodies but to also help them manage the inevitable changes that society is facing in an increasingly populated world. The need to move from traditional to student-centred learning in the context of engineering education was the motivation for this project. This can be facilitated through the use of group-based, problem-driven learning as this offers high integration of technical and non-technical knowledge and skills and requires more engagement with the programme from today's student.

The School of Electrical Engineering Systems in the DIT now delivers a number of engineering modules in this format but experience has shown that it takes a significant amount of time for students to develop personal skills to a high degree. The aim of this project was to develop additional group learning modules and enhance existing ones to pay more attention to personal development. Each of the first three years of the Bachelor of Electrical Engineering programme now contains a group-based module in which learning is project or problem driven and the tutor pays significant attention to individual personal skills. The concept of progressive development of personal skills was also investigated and a framework to develop these in a structured way through the delivery of group-based modules was proposed. The development of further group learning modules and an examination of the effectiveness of this framework will form the basis for continuing this project into the future.

Key Words: curriculum design, first year curriculum, problem-based learning

Outline of Fellowship Project

Introduction

This project involved the co-operation of a core group of five staff with a number of other lecturers involved to a lesser degree and the teaching fellow acting as researcher, reporter and organiser. The main activity of the staff was to act as a learning group confronted with the problems of 'how to facilitate group work, how to assess individuals in a group and how to give feedback'. This debate was informed by the research activity of the teaching fellow, input from an experienced problem-based learning (PBL) tutor in the College of Engineering and Built Environment and each person's experience of tutoring in the class room. Although we had been delivering group-based modules in which learning was driven by the problems or projects for a number of years we had been paying little attention to the *process* the students were following in their group work and individual activities. This project resulted in the addition of a group-based module to year two of the Bachelor of Electrical Engineering programme which filled the gap between the existing modules in years one and three.

All three modules were then delivered with a greater emphasis on 'the process', i.e. the tutor paid more attention to individual behaviour in the group: offering ideas, discussing, critical thinking, taking responsibility for self-directed learning, completing tasks, reporting back and many other actions that result in each member contributing as positively as possible to the group project. These skills are personal in nature and are demonstrated to varying degrees by each individual. The tutor's aim was and is to monitor and give feedback

so these skills can be enhanced and developed, the group works well and the students learn the required technical knowledge. This is consistent with the view of PBL as outlined by Boud (1985), Barrows (1988) and Woods (1994).

A parallel activity to the improvement of tutoring practice was to examine the electrical engineering curriculum in the context of developing personal skills and competences. Many of the current outcomes defined by the accrediting professional body, Engineers Ireland, relate to the development of personal and professional skills (Engineers Ireland, 2007). This is an activity that can and should happen throughout the entire programme and not just in one or two isolated modules or the final year project. In the context of medical education it has been argued that the sustained delivery of learning through PBL provides an opportunity to progressively develop self-directed learning skills (Miflin, Campbell, & Price, 2000).

This is achieved by steadily diluting over time the high level of direction from the tutor offered at the start of the programme. Students should immediately start taking greater responsibility in their learning and continue to grow in this way throughout the programme. The tutor fades from the group over time as both the individuals and the group become more autonomous. The model proposed by Perry (1999) covers a similar theme but from an intellectual point of view – students should progress from seeking the one right answer from the teacher (dualism) to realising there are multiple solutions, one of which they choose to commit to (relativism).

How can we do this in engineering? A framework to facilitate the progressive development of personal skills was developed during this teaching fellowship project. The emphasis in the first two years should be on the learning process. Frequent, formative assessment by and feedback from the tutor should focus on individual contribution to the group process during this period. Students must be *required* to contribute to the group discussion, question others, offer ideas, complete tasks, report back and demonstrate the wide range of attributes that need to be developed for them to be successful professionals. These skills should be explicitly stated, observed and assessed (Woods et al., 1996). Students should emerge from these two years as relatively competent group workers with a reasonably high level of self-direction. The use of reflection, although outside the normal language of engineers, should be given consideration as a powerful tool to help the learner to realise where development is needed and what actions can be taken to make the change. (Consider Kolb's learning cycle (Kolb, 1984) and Schön's reflective practitioner (Schön, 1991) for useful concepts in developing engineers.)

As they display group collaboration and self-direction to greater and greater levels the emphasis on these skills can be relaxed. Attention can be paid to other process skills such as critical thinking, creativity, management and ethics. Greater weightings can be given to the *product* of the group. The number of contact hours with the tutor can be reduced. Time invested in year one can be saved in year four. Projects should become progressively more complex. Exposure to industry and/or community projects should be considered in year three as a reasonably professional approach can be expected of the students at this stage.

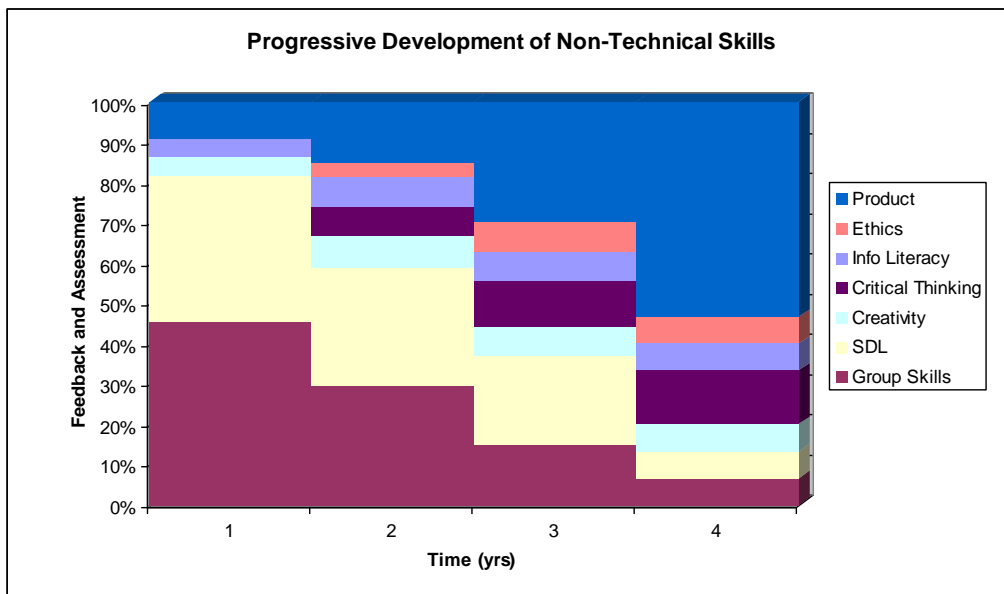

Figure 6.1: Change in focus on the process and the product during a four year programme. A selection of process skills are used to illustrate the point (SDL = self-directed learning).

Project Evaluation

The addition of an extra group-based module to the existing two modules on the Bachelor of Electrical Engineering combined with a greater emphasis on the learning process have enhanced the amount and quality of student-centred learning on this programme. The Bachelor of Engineering Technology offered by the School in the same discipline was also enhanced in a similar way. A large number of students therefore experienced a greater focus on the personal skills needed to work in a group on an open-ended project. Higher levels of engagement with the programme were observed by the staff which was consistent with delivering these modules in the previous years.

The formation of a cohesive group of staff to learn about tutoring and grow as PBL practitioners was a very important outcome from this project. This laid a foundation of PBL experience in the School that can only have a positive impact on the School's activities into the future. For example, a consequence of the formation of this group is a plan to refurbish a laboratory into a flexible learning space so that group work can be more easily accommodated. Further consolidation of group-based learning into the School's programmes are likely to continue with one goal being the provision of a group-based module in each semester so that sustained attention can be given to personal development.

The first workshops on PBL delivered by staff from the School happened during this project. Two workshops on student induction into group learning were delivered as well as two workshops for tutors.

The need to reconsider the traditional approach to engineering education to more closely align our learning, teaching and assessment methods with our programme outcomes (Biggs & Tang, 2007) is discussed in a paper presented at an Institute of Electrical and Electronics Engineers (IEEE) conference on Transforming Engineering Education that was held in Dublin in April 2010. The framework outlined above was discussed in more detail in this paper. The preparation of graduates not only for a more globalised world but also for a world that is facing environmental uncertainty, and in which a move to sustainability is inevitable, is also

facilitated by the group-based approach. The development of students' personal skills, the complex nature of open-ended problems, the ability to think creatively and critically, the move towards relativism and the development of a reflective practice are all positive inputs to preparing an engineer for this uncertain world. This was the argument in a second paper submitted to the Third International Symposium on Engineering Education, 'Educating Engineers for a Changing World', held in University College Cork in July 2010. This paper discussed the suitability of group-based learning in helping graduates be prepared for the future and the paper further elaborated on the framework for progressive development.

Project Recommendations to the College/Institution

Increasing the quantity and frequency of group-based project-driven modules is in line with the DIT strategic plan to move towards student-centred learning, enhance the first year experience and increase the use of formative assessment. Group-based modules can be delivered badly and tutors can have very different perceptions of the method. It is important that we display a high quality and professional approach in our delivery of these modules. Programme committees should expand debate beyond what we teach to include how we teach and how we develop our students in a coherent way from first to final year. The provision of flexible learning spaces is a strong enabler for this approach.

Proposed Future Work

This project will continue to evolve in the years ahead. An increase in the use of group-based learning in the Bachelor of Engineering and Bachelor of Engineering Technology will be debated in the programme committees with a view to embedding one per semester into these programmes. The refurbishment of laboratory space will be a project for 2010/2011. The proposed framework for the progressive development of personal skills will be further developed and this will also be evaluated in the coming years.

References

- Barrows, H.S. (1988) *The Tutorial Process* (Rev. edn). Springfield: Southern Illinois University School of Medicine.
- Biggs, J.B., & Tang, C.S.-K. (2007) *Teaching for Quality Learning at University* (3rd edn). Maidenhead: Open University Press.
- Boud, D. (1985) *Problem-based Learning in Education for the Professions*. Sydney: Higher Education Research and Development Society of Australasia.
- Engineers Ireland (2007) Accreditation Criteria for Engineering Education Programmes. Dublin, Ireland.
- Kolb, D.A. (1984) *Experiential Learning: Experience as the Source of Learning and Development*. Englewood Cliffs, London: Prentice-Hall.
- Mifflin, B.M., Campbell, C.B., & Price, D.A. (2000) A Conceptual Framework to Guide the Development of Self-directed, Lifelong Learning in Problem-based Medical Curricula. *Medical Education*, 34(4), 299–306.
- Perry, W.G. (1999) *Forms of Intellectual and Ethical Development in the College Years: A Scheme*. San Francisco: Jossey-Bass Publishers.
- Schön, D.A. (1991) *The Reflective Practitioner: How Professionals Think in Action*. Aldershot: Arena, Ashgate.

Woods, D.R. (1994) *Problem-based Learning: How to Gain the Most from PBL*. Waterdown, Ont.: D.R. Woods.

Woods, D.R., Hall, F.L., Eyles, C.H., Hrymak, A.N., & DuncanHewitt, W.C. (1996) Tutored versus Tutorless Groups in Problem-based Learning. *American Journal of Pharmaceutical Education*, 60(3), 231–238.

7. Improving Core Mathematical Skills in Engineering Undergraduates

Michael Carr

School of Civil and Building Engineering Services

Contact: Michael.Carr@dit.ie

Abstract

A large number of engineering undergraduates begin their third level education with significant deficiencies in their core mathematical skills. Every year, in the Dublin Institute of Technology (DIT), a diagnostic test is given to incoming first year students, consistently revealing problems in basic mathematics. It is difficult to motivate many students to seek help in the Maths Learning Centre to address these problems. As a result, they struggle through several years of engineering, carrying a serious handicap of poor core mathematical skills, as confirmed by exploratory testing of final year students.

In order to improve these skills in engineering students, a pilot project was set up in which a 'module' in core mathematics was developed. The course material was basic, but a grade of 90% or higher was required to pass the module. Students were allowed to repeat the module as often as they liked until they passed. An automated examination for this module was developed on WebCourses, and a bank of questions created for it. Initially, this project was piloted in the third year Ordinary Degree mathematics module in Mechanical Engineering in the DIT, where it proved very successful.

Subsequently, the pilot project was extended to five Ordinary Degree engineering programmes in the DIT, across three different year-groups.

Keywords: curriculum development, e-learning, first year curriculum, mathematics modularisation

Outline of Fellowship Project

Introduction

Many students upon entry to third level engineering programmes have problems with core mathematical skills. This has been borne out in the results of diagnostic tests carried out in many third level institutions, both in Ireland (Cleary, 2007; Gill & O'Donoghue, 2007) and in the UK (LTSN MathsTEAM, 2003; Savage et al., 2000). These problems with core concepts can lead to comprehension difficulties in numerous modules, both in mathematics itself and in related subjects. In recent years, this has been exacerbated by the fact that students are being recruited from an increasingly diverse student body. The academic years of 2008 and 2009, in particular, saw the return of a large number of students to full-time education after many years in employment, due to adverse economic conditions. In this paper we discuss the maths diagnostic test carried out in the Dublin Institute of Technology (DIT) and the deficiencies in students' core mathematics revealed by this test. We then outline the details of a pilot project carried out to address these deficiencies. The results of several focus groups are presented. The maths diagnostic test was also given to a selection of fourth-year students and the results of this test are shown. Finally we outline future work we intend to carry out on this project.

Core Skills Initiative

Research conducted by the DIT Retention Office showed that a student's mathematics grade in the Irish Leaving Certificate (the final examination in the Irish secondary school system) is a key determinant in that student's progression through engineering programmes (Russell,

2005). As a result, a mathematics diagnostic test has been given to first year students for several years now and a Maths Learning Centre (MLC) has been set up in the DIT.

Mathematics Diagnostic Test

The DIT Mathematics Diagnostic Test showed marked deficiencies in core mathematical skills (Ni Fhlionn, 2006). The test consists of 20 questions (ten paired questions) on basic topics such as algebra, fractions, indices, trigonometry, the equation of a line, logs, quadratic equations, simultaneous equations and basic differentiation. In 2006, the mean mark obtained by first year engineering students was 55% across all programmes. More worryingly, this mean dropped as low as 29% in some programmes. A large spread was seen within most programmes, with many students scoring significantly lower than the mean mark.

Core Skills Assessment

It was decided to set up a core skills assessment in mathematics, similar to that already in existence in the Institute of Technology Tallaght, Dublin (Marjoram et al., 2008). This consisted of a multiple-choice quiz on WebCT, based on a randomised question bank. The material covered by the test was basic but the pass mark was set at 90% for third-years and at 70% for first-years. The questions used were based on those already in use in the DIT Mathematics Diagnostic Test. Students were allowed to re-sit the assessment as frequently as required until they passed. Ideally a pass in this module would be compulsory for progression to the next year of the course, but this is not yet the case.

Pilot Project

In Ireland, students who have not achieved 55% or more in Higher Level Leaving Certificate mathematics are not eligible for the four-year Honours Degree engineering programmes, but instead may enter into a three-year Ordinary Degree programme. Upon successful completion of this, they may then enter into third year of the Honours degree. The pilot groups chosen for this study are first year Ordinary Degree students in Mechanical and Building Services, first year preliminary engineering, second year Ordinary Degree in Manutronics and third year students in the Ordinary Degree in Mechanical Engineering in DIT.

Course	Year	Leaving Certificate Points*
Preliminary Engineering	First	290
Building Services Engineering	First	150
Mechanical Engineering	First	315
Manutronics Automation	Second	150
Mechanical Engineering	Third	305

Table 7.1: List of courses included in the pilot project

*In the Irish Leaving Certificate, six subjects are included for the purpose of calculating points. A maximum of 100 points can be attained in any one subject.

Project Overview

The 'core skills assessment' was worth 10% of the mathematics module. In the first instance, the students sit the Mathematics Diagnostic. There are two different marking regimes depending on what year the students are. Third-years had to achieve a score of 90%. Those who scored 90% received nine marks out of ten, whilst those who scored less than 90% received no marks and had to take the core skills assessment at a later date. For first and

second year students a sliding scale was used, namely 70% = 4/10, 80% = 6/10 and 90–100% = 10/10. These students continued to sit the core skills assessment on a monthly basis until they achieved the required pass mark. After their first attempt, students were given access to a WebCT site with resources tailored for each question and were also encouraged to attend the MLC. After their second and subsequent attempts, special classes on problem topics were provided. At the end of the year, students were asked to fill in a reflective online survey on the core skills assessment, and selected students took part in focus groups to discuss the project.

Evaluation of the Mathematic Diagnostic Test/Core Skills Assessment

An evaluation strategy was devised in order to enhance and develop the diagnostic test and the way in which it is implemented in, and integrated into, the modules. The evaluation is essentially a comparison between aims and objectives of the development and implementing the test and the reality of the students' learning and development. However there was also a particular need for formative evaluation in order to discover areas where improvements can be made to the diagnostic test itself and its use within the engineering programmes. It was also the author's intention to obtain reliable and triangulated data that would inform the subsequent changes and refinements, and minimise the occurrence of intuitive decision-making. The evaluation combines both qualitative and quantitative research methods in order to ascertain the effectiveness of the diagnostic test and to determine where improvements can be made. The methods of data collection are questionnaires, focus groups, diagnostic test results, the number of attempts made by the students, and attendance at tutorials. It involves focus groups with different cohorts of students using the diagnostic test and hence a comparative analysis of the following groups is possible:

- Level 7 engineering first year students
- Level 7 engineering final-year students
- Level 8 engineering first year students
- Level 8 third year students
- Mature students
- Preliminary engineering students

The evaluation is to run over a complete academic year so that improvements to the test and its implementation can be made before the start of the next academic year. As this paper was written just before the end of the academic year, the evaluation process had not yet been completed in full, with only two focus groups carried out and not all quantitative data analysed, and therefore the next section presents preliminary findings.

The focus groups consisted of qualitative questions regarding the students' perceptions and opinions of the maths diagnostic test and the way in which it was implemented within their modules. They were carried out by an experienced education researcher who did not teach any of the students and was not known to the students. Analysis of the focus group data led to the following conclusions:

Positive Aspects

1. The students were able to describe the positive effects the diagnostic test had on the development of their mathematic abilities. They identified not only the ways in which their mathematical ability had developed but the role that the diagnostic test had played. They gave concise examples of difficulties they had in mathematics prior to the

test and described how these were remedied once identified through the results of the test.

2. The students were clearly aware of the formative nature and purpose of the diagnostic test even though their final mark in the test was to contribute to the overall module mark. They were also very cognisant of the need for the test to contribute to the module mark and the motivation associated with this.
3. The students supported the high pass mark and expressed their belief that it is this pass mark coupled with the fact that if they do not pass they get a mark of 0 that ensures the effectiveness of the test. It should be noted that a significant number of the preliminary engineering students felt that the pass mark of 70% was too low. This issue will be investigated further when all the data is obtained.
4. The students appreciated the chance to take the test multiple times and could clearly articulate the formative effect this had on their learning experience and development.
5. The importance in engineering of the mathematics examined by the test was evident to all students but particularly to the students in the later stages of their engineering programmes.
6. The quality of the mathematics online notes and the 'special' tutorials outside of timetabled hours was commended by the students and described as 'professional', 'effective' and 'concise'.
7. Confidence in their mathematics ability was perceived as being positively affected by the test (although it should be noted that a number of students said the result after their first attempt was disappointing and had a detrimental effect on their confidence).
8. The students appreciated the time, effort and commitment of the staff involved in the implementation of the diagnostic test.

Development Aspects

1. The diagnostic test could provide more specific feedback to the students. The students felt the effectiveness of the test could be improved if the result of the test was not just a mark but if it also suggested how the deficiencies could be rectified. For instance, the test could direct the students to a particular set of notes, chapter of a book or an online resource. In addition, if the lecturer noticed that a significant number of the students had difficulty with the same section, a tutorial could be run soon after the test to address that specific issue.
2. It was also suggested that similar diagnostic tests could be developed for specific elements of the mathematics modules. In that way, the full diagnostic test could identify areas of difficulty; the student then addresses this difficulty and can then complete a diagnostic test which only examines that particular area. The mark for this 'smaller' test would not count towards the final module mark and the student would still have the opportunity of retaking the full diagnostic test.
3. The students also expressed the view that a more advanced test could be developed for the latter stages of the engineering programmes, and for the students who excel in the diagnostic test on the first attempt.
4. All of the students expressed the opinion that the effectiveness of the test could be improved if its purpose, and the most effective way of using it, was clearly communicated to the students at the start of the process and again after the first attempt at completing the test.
5. It was suggested that greater links between the mathematics being developed within the maths modules (including the diagnostic test) and the other modules within the programmes could also improve the student mathematics ability.

Results of Diagnostic Tests

As a first step all of the students in the pilot project were given the DIT Maths diagnostic exercise. This text was also given to the first year Honours engineering class. These are the students who in the main have done higher level Mathematics for their Leaving Certificate, and provide a benchmark for the level of maths required to complete an Honours degree in Engineering. We can see that the majority of first year Honours students (69/87) have a mark of over 70% in the diagnostic exercise. Improving their core mathematics is clearly not a priority when we compare the test with the marks of other classes, and they are better than the marks of the third year students in this pilot who have already completed two years of mathematics at third level.

Overall Improvement

Throughout the lifetime of this Pilot we have seen a systematic improvement in the core mathematical skills of the students as measured by the Maths Diagnostic Test and core skills assessment. To illustrate this point we look at a case study for first year preliminary Engineering from October 2009 up to the time of writing.

Course Code and Name	Mean	Over 70%	Over 90%
DT025 first year Honours	80%	69/87	17/87
DT020 Prelim	48%	8/36	0/36
DT005/1 Building Services	65%	14/29	4/29
DT006/1 Mechanical	61%	30/72	11/72
DT003/2 Manutronics	45%	2/10	0/10
DT006/3 Mechanical	75%	16/23	7/23

Table 7.2: List of courses tested and marks received in the first test

The results below show a systematic improvement in the results of the students. On the first test only 1 out of 36 students achieved a mark of over 90%; by the time of writing this had increased to 7. More importantly 25 out of 36 failed to achieve a mark of 70% in their first attempt. This number has now been reduced to 11, with several opportunities remaining to complete the test.

Preliminary Engineering (36 students)	Mean	> 90%	> 70%	< 70%
First Attempt	54%	1	10	25
Christmas 2009	65%	6	14	16
April 2010	73%	7	18	11

Table 7.3: Grades of preliminary engineering students in the core skills assessment

Reflective Online survey

At the end of the semester all of the students in the project will be asked to complete an online survey to get their feedback on the pilot project.

Sample Group of Final Year Students

Finally, it was decided to test a small subgroup of final-year students who had already completed an Ordinary Degree and subsequently continued into the Honours Degree programme. Forty Eight students volunteered to retake the diagnostic exercise. These

students only had to take the test, no credit was awarded to them irrespective of how well or badly they did.

Final Year Engineering (48 students)	> 90%	> 70%	< 70%
Overall (48)	24	41	7
Ordinary Degree (23)	10	16	7

Table 7.4: Results of final year students

Some 24 out of 48 scored more than 90% while 41 scored more than 70%. Seven of the 48 students scored a mark of less than 70%. Of these 48 students, 23 of them came from an Ordinary Degree background, all seven students who failed to score more than 70% on the diagnostic test had come through from an Ordinary Degree, and three of these had failed to score 50%. Given that these students volunteered to do the test, there may be significantly more students in final year who still lack many core mathematical skills. These results show us that action needs to be taken early in the education of student engineers, doing ordinary degrees to address this problem.

Conclusion and Future Work

By participating in the core skills initiative there has been a systematic improvement in the core mathematical abilities of the students. This is evident both from the results of the students and the feedback we are getting from the focus groups. The results of the small group of final year Honours degree students who took the assessment have shown that there may be a significant number of students who struggle with basic mathematical concepts throughout their entire degree. Such problems are clearly endemic and will persist if not tackled in a consistent manner. The core skills assessment is one such way to encourage students to seek help to address these deficiencies, and it is extremely important that this work be rolled out across all first year courses in engineering.

Future Work

The core skills assessment will now be introduced to all first year classes doing an Ordinary Degree in Engineering. A full analysis of all the results of the tests will be carried out at the end of the academic year. The feedback from the focus groups and the online survey will be used to improve the process in the coming year. A more advanced version of the test is also being developed for students in the later years of the programme.

Recommendations to the College

1. The Core Maths Assessment should be extended to all Ordinary Degree Engineering programmes in the college.
2. A similar test should be set up for basic skills in mechanics, e.g. Resolving forces, etc.
3. We should proceed to develop a higher level version of the Core Maths Test to be administered in the third year of the Ordinary Degree. This would ensure that student are forced to revise/learn key components of the mathematics covered in college.
4. The pass mark for first year Mathematics in all first engineering year programmes should be increased to 50%.
5. There should be no choice on maths papers in the early years of all engineering programmes.

Proposed future work:

- It is envisaged that this work will be extended to other programmes in the college, both in Engineering and in the Built Environment. I am currently in consultation with lecturers both in Geomatics and Architectural Technology.
- To develop a higher level Core Maths Exercise for the third year of the Ordinary Degree.
- to continue to develop the Core Maths Assessment in the first year in response to the feedback from the focus groups including more sophisticated feedback and a series of practice tests.

References

Cleary, J. (2007) Diagnostic Testing: An Evaluation 1998-2007. In S. Close, D. Corcoran & T. Dooley (eds), *Proceedings of Second National Conference on Research in Mathematics Education (MEI2)* (pp. 215-227), St Patrick's College, Dublin.

Gill, O. & O'Donoghue, J. (2007) The Mathematical Deficiencies of Students Entering Third Level: An Item by Item Analysis of Student Diagnostic Tests. In S. Close, D. Corcoran & T. Dooley (eds), *Proceedings of Second National Conference on Research in Mathematics Education (MEI2)* (pp. 228-239), St. Patrick's College, Dublin.

LTSN MathsTEAM (2003) Diagnostic Testing for Mathematics. Accessed via http://www.mathstore.ac.uk/mathsteam/packs/diagnostic_test.pdf (6 November 2009).

Marjoram, M., Moore, D., O'Sullivan, C. & Robinson, P. (2008) Implementing a Key skills in Mathematics Initiative. *Proceedings of Mathematical Education of Engineers*, Loughborough.

Ni Fhloinn, E. (2006) Maths Diagnostic Report. Internal report. Dublin Institute of Technology.

Russell, M. (2005) Academic Success, Failure and Withdrawal Among First Year Engineering Students: Was Poor Mathematical Knowledge a Critical Factor?" Level 3(3). Accessed via http://level3.dit.ie/html/issue3_list.html (6 November 2009).

Savage, M., Kitchen, A., Sutherland, R. & Porkess, R. (2000) In Hawkes, T. & Savage, S. (eds), *Measuring the Mathematics Problem*. London: Engineering Council.

Faculty of Science

8. Development of Student Centred Physics Labs from Years 1 to 4

Robert Howard,* Cathal Flynn, Fran Pedreschi
School of Physics

Contact*: Robert.Howard@dit.ie

Abstract

Physics laboratories, with their usual relaxed atmosphere combined with the exploratory nature of physics should help to create a student centred learning environment in which the students develop the necessary lab skills. However in reality most physics labs, especially in years 1 and 2, are recipe driven and the students follow a set of instructions from a manual which require no or minimal student exploration of the physics involved. The assessment methods also appear to be misaligned as they often only assess the product (report and logbooks) and not the desired learning outcomes of the module.

During this project we evaluated and re-aligned the learning outcomes, teaching and assessment methods for years 1 to 4 of the physics laboratory programmes. We found that although they were aligned on paper they were not aligned in practice. We developed a new suite of first year experiments which are more exploratory based and build the students' skills so that they are able to work more independently by the end of the programme. A new first laboratory manual and corresponding tutor guide was also developed. In the higher years (2, 3, and 4) of the laboratory programme we identified core competencies, developed new experiments, and assessment methods. The assessment methods are more closely aligned with the laboratory learning outcomes.

Key words: curriculum alignment, exploratory, physics, laboratory, student centred

Outline Fellowship Project

Introduction

Physics labs, by their very nature, should be inherently student centred. The exploratory nature of physics should help to instil the students with a sense of learning by inquiry. The relaxed atmosphere in the lab, combined with this sense of exploration, should encourage a student centred learning environment in which the students develop the necessary lab skills. Unfortunately this is often not the case, as in reality most physics labs, especially in years 1 and 2, are recipe driven and students follow a set of instructions from a manual. There is often no or minimal student exploration of the physics involved. This problem seems to be compounded by the assessment methods which often appear to only assess the product (report and logbooks) and not the actual desired learning outcomes of the module. The implementation of modularisation in the Dublin Institute of Technology has also led to a misalignment of the development of lab skills up through the four years of the physics programmes. Concerns expressed by teaching staff over the past few years strongly suggest that physics students may not be achieving all the required learning outcomes through all four years of their physics programme. In addition, students who are taking physics labs as a service course might not be achieving these learning outcomes. As a result many of the key skills required by physics, engineering, chemistry and biology graduates are not being developed.

The aim of this project was to evaluate the current physics lab modules throughout the DIT's School of Physics, to build on the recent work in physics education research and to create a student centred physics lab programme from first to fourth year and across into its service courses. The project aimed to evaluate the development of lab skills from years 1 to 4 and look at the best ways to ensure that these skills and learning outcomes are achieved.

Approach and Main Findings

Curriculum misalignment: The first part of the project involved checking the alignment between the laboratory programme's; learning outcomes, teaching methods, and assessment methods. This was done for years 1 to 4, through both physics major courses and services courses, and in both level 7 and level 8 programmes. During this part of the work the learning outcomes of the relevant lab programme were compared to the teaching method (lab manual). Although various staff may interact with the students differently, it is the lab manual (or handout), its procedure and proposed method of analysis, which ultimately determines what the students do in the lab time. The assessment methods for each learning outcome were listed. It was possible to write down an assessment method for each learning outcome (LO), and on paper there appeared to be alignment between all three components of the curriculum matrix. However on closer inspection it was clear than many of the assessment methods were formative and did not appropriately assess the skill or learning outcome.

For example, in year 1 of the lab programme there is a learning outcome 'demonstrate the ability to use a micrometer'. The teaching method is to show/explain to the students how to use it and then get them to use it to measure the thickness of a piece of aluminium. There were three assessment methods listed with this LO: tutor questioning (formative), logbook (formative and summative), and formal report (formative and summative). However none of the assessment methods specifically test this learning outcome. The most obvious way to assess it is to get the student to measure something using the micrometer and see if they get the correct value. There were many examples of this misalignment between the three components of the curriculum matrix, although on paper it is possible for the laboratory programme to appear to be aligned. In general most of the laboratory learning outcomes, through all years of the programmes, were assessed using either logbooks or reports. While many desired lab skills, such as circuit building, use of equipment, uncertainties, were not directly assessed.

After talking to the laboratory supervisors from all years of the programme several concerns were also identified. Below are some examples and proposed solutions.

1. *The second year students did not have a rigorous scientific approach.* The suggested cause of this was that the year 1 experiments were too open-ended. The proposed solution to this was to change the teaching method in year 1 and strike a balance between structured, semi-structured and open-ended experiments.
2. *The students had a poor ability to use specific equipment.* It was noted that students can pass the lab programme without achieving this learning outcome. For example, analysis of the students' lab exam marks revealed that a student can get 40% (pass mark) in building an electrical circuit. However 40% of a circuit is not a circuit and it will not work. This is an example of misalignment of both teaching methods and assessment methods. The proposed solution was to increase the use of specific equipment, set them as core competencies (discussed below), and to continually evaluate these skills using the lab exam results in the future.
3. *The students have poor report-writing skills.* Although the students write between 20 and 30 lab reports over the four years of their degree the standard and quality of the reports are still very variable in their final year. This is despite report writing being one of the main assessment methods in all years of the lab programme. The proposed solution to this was to introduce a draft report step into the report writing system. This is a change in the teaching methods and is discussed later in this paper.

Teaching methods: The next phase of the project was to align the three components of the curriculum matrix. This involved changing both the ‘teaching methods’ and ‘assessment methods’ used in the lab programme. Changing the ‘teaching methods’ meant the modification of, or development of, new laboratory handouts. These were designed to not only help the students to understand the experiment, but also to allow them scope to explore the physics. It also led to the development of a new first year lab manual for the level 7 Science programme.

The new lab manual contained several new features. Firstly, the students had to complete pre-lab questions to prepare them for their lab session. These pre-lab questions were worth 20% of their mark. Secondly, direct instructions (structure) in the lab manual were present in early experiments but removed as the students progressed through the year. For example, early experiments contained a written experimental procedure (structured experiment), while in the later experiments the students had to design their own procedure (semi-structured). Also early experiments did not involve graphing, but graphing was introduced after a few weeks. The laboratory supervisors were also encouraged to question the students and draw out their knowledge instead of directing the students with instructions. Another noticeable change in the ‘teaching methods’ was that one of the experiments was removed and replaced by an in-lab graphing tutorial.

Assessment methods: In general most students are assessment driven. It is unusual for a student to try and achieve a learning outcome if they are not getting marks for it. What the lab supervisor thinks is important and what the students think is important are often two very different things. If the staff think that the ability to build a circuit is important, but they only grade the final report, then the student will put all their effort into the report. If there are marks awarded for doing something then it is important to the student. Awarding marks for the achievement of a learning outcome is one way for the staff to inform the students of what is important. With that in mind the learning outcomes are best achieved with both summative and formative assessment (with clear feedback). However, the assessment must match the learning outcome. Therefore, and it may seem obvious, if there are many different learning outcomes there needs to be an array of assessment methods to match them. Basically, one size does not fit all.

This project developed clearer curriculum matrices for years 1 to 4 of the level 7 and level 8 Physics programmes. Table 8.1 shows an aligned curriculum matrix for a typical physics laboratory. Specific years of a laboratory programme would have more detailed learning outcomes but the table shows generalised learning outcomes, teaching methods, and assessment methods. The table shows that different learning outcomes require various assessments methods. Also it is important that each learning outcome is taught in an appropriate way. It would be unfair to a student to assess a learning outcome when the teaching method does not promote the achievement of the learning outcome. A common example of this is the ability to use equipment. It would be unfair to assess a student on the use of an oscilloscope if they have only used it once during the year. The learning outcome (demonstrate the ability to use an oscilloscope) is valid, assessing it in a lab exam is valid, but only using it once (teaching method) causes misalignment. If the ability to use an oscilloscope is important to the staff, then the students should use it repeatedly during the course of their laboratory programme.

Core competencies: The idea of testing core competencies in the physics lab was based on DIT’s Optometry programme (DT224). Core competencies are skills which the students must possess (and demonstrate their ability to do) in order to progress to the next year. They are not graded but are either pass or fail. The students get up to three attempts to pass the core

competencies otherwise they must repeat the year. Several of these core skills were identified and the level of competency in the skill was identified for each year. For example the ability to use an oscilloscope was always considered as an important skill in a physics graduate and so it was set as a core competency. The competency level increases, as the students move from year 1 to 4. Such competency levels in using an oscilloscope are outlined below and are the minimum levels expected of the students.

Year 1: Read frequency and voltage values from an a.c. signal on an oscilloscope screen.

Year 2: Connections, channel selection and other settings, peak to peak amplitude, frequency.

Year 3 & 4: More advanced external trigger usage, internal and ring, Fourier analysis.

Learning outcome	Teaching method	Assessment method
Determine sources of experimental uncertainty and significant figures	Record in logbook, tutor feedback	Core competency and logbook
Use various instruments, e.g. oscilloscope	Use instruments (repeated and often) during experiments, tutor feedback	Lab supervisor and lab exam
Investigate the theoretical background to an experiment	Pre-reading and pre-lab questions, class discussion	Report and oral exam
Keep a well-maintained and instructive laboratory logbook	Use laboratory logbook, tutor feedback	Logbook assessment
Design experiments to test a hypothesis and/or determine the value of an unknown quantity	Move from structured to semi-structured to open-ended experiments	Lab exam

Table 8.1: An aligned curriculum matrix for physics laboratory

Report writing: As mentioned above, staff expressed concerns about the quality of the students' report writing. This is despite the fact that students write between four and ten reports per year, and that it is traditionally the main assessment method used in the physics labs. As part of this project a system of draft report writing was introduced to the first year of the level 8 Physics programme. The year 1 students usually write four reports on four separate experiments. They are also given a handout on how to write a physics lab report. The reports are marked and the students receive written feedback on where to improve their report writing. However in general the students are more interested in the mark they receive and pay little attention to the written feedback. As a result, the second, third and fourth reports often contain the same mistakes as the first report.

This year the staff decided to get the students to reduce the number of reports to two but get the students to submit two versions (draft and final) of the same report, both of which are marked. The reasoning was that the students are unlikely to ignore the feedback if they are re-submitting the same report. The average class marks for the reports, are shown in Table 8.2.

Report 1	Draft	Av. mark 51%
	Final	Av. mark 69%
Report 2	Draft	Av. mark 64%
	Final	Av. mark 79%

Table 8.2: Effect of feedback on report-writing marks

Table 8.2 shows that in general the students responded to the feedback on their first draft report and implemented the suggested changes by the staff member. This is indicated by the higher marks for the final version of the report than the draft version. This is probably to be expected. However the interesting result is that the average mark (64%) for the draft of the second report is similar to the average mark of the final version of the first report (69%). This suggests that the students remembered their feedback from the first report and implemented it in their second report. This result suggests that it is not the number of reports that is important but the response of the students to the feedback. The draft system with feedback (summative and formative) appears to be one way of achieving this.

Evaluation of Project and Main Outputs

The project was evaluated using several methods. As mentioned above, the new lab manual was piloted and specific lab skills were assessed. The effect of changes in either teaching methods or assessment methods, were evaluated based on the students' ability to perform the desired learning outcomes. Any changes which were judged to be effective, e.g. draft report writing, core competencies, new lab manual, will be expanded into other years and programmes. The proposed changes will be presented to the DIT's School of Physics in September 2010 and if accepted will be incorporated into the relevant programmes across the School of Physics. Many of the findings have already been presented to the DIT's Management Forum (May 2010) and the DIT's Showcase of Learning and Teaching Innovations 2010 (Jan 2010).

The main outputs were: (i) clearly aligned curriculum matrices for the lab programmes through years 1 to 4. (ii) A variety of assessment methods were developed to match the variety of learning outcomes. (iii) Core competencies were identified for years 1 to 4. (iv) A new exploratory based lab manual with tutor guide was developed and piloted.

Recommendations

The main recommendations of the project are the following.

1. Many of the lab's learning outcomes, teaching methods, and assessment methods can be aligned on paper while not being aligned in practice. It is important that effective learning does not get lost in a sea of paper and documentation. It is easy to achieve alignment of the curriculum matrix on paper, but this work has shown that with small changes in the assessment and teaching methods, that alignment can be achieved in practice too.
2. A variety of assessment methods are needed to match the variety of learning outcomes. This may sound obvious, but matching the appropriate assessment method to the desired learning outcome, and providing effective feedback, makes a

big difference. The 'one size fits all' approach to assessment of learning outcomes is very limited.

3. Core competencies are an effective way to showing the students which learning outcomes are really important. The pass/fail system removes the complacent attitude that 40% of a skill is okay.
4. The laboratory manual is a key teaching method in the laboratory. The way it teaches, and what it teaches, really affects the way students learn. Excessive direction leads to 'doing without thinking' and is the laboratory equivalent of rote learning. It is important that the students learn to think, as well as do. A progression from structured to semi-structured, to open-ended experiments is recommended.
5. It is important to continually evaluate the skills the students are developing. They need to be measured, recorded, and compared to previous years. This makes it easier to see whether changes in the laboratory's assessment and teaching methods are effective.

Proposed Future Work

All the goals of this project could not be achieved in one academic year. The project will continue and the proposed changes will be rolled out into all years and programmes throughout the School of Physics. The students' skills and achievement of learning outcomes will be continually measured. Hopefully this work will help to produce physics graduates which possess core lab skills and are self-directed learners. Ultimately the long-term goal is to develop a greater awareness of student centred learning in the School of Physics, not only in the laboratory but in all of its teaching spaces.

9. An Examination of the Use of Blended Learning to Support Improvement of Engagement and Retention of Part-time Postgraduate Level Students using Student Edited Podcasts

Deirdre Lawless and Damian Gordon
School of Computing

Contacts: Deirdre.Lawless@dit.ie and Damian.Gordon@dit.ie

Abstract

Part-time students must contend with a large number of logistical factors which may inhibit their ability to attend all required instruction sessions. The vast majority of part-time students are in full-time employment and due to either family or work pressure may be unable to attend all classes. This can have a significant impact on the student learning experience. Students can quickly fall behind, become de-motivated and can increasingly seek deferrals from either examinations or the programme itself. Given the current economic climate it is to be expected that the numbers of students interested in upskilling will be increased in the short- to medium-term and that the numbers forced to miss instruction sessions due to increased family and work commitments will also increase. This project investigated how a 'Blended Learning' approach, combining traditional and online delivery, and specifically, the use of podcasting could be used to address some of the problems encountered. Some teaching materials and classroom sessions from selected core modules on two M.Sc. programmes in the DIT School of Computing were recorded and made available as podcasts to students. In addition students were encouraged to annotate these podcasts and to develop companion podcasts to support the transfer of knowledge between classmates.

Keywords: Blended Learning, curriculum development, e-learning, Podcasts, student engagement

Outline of Fellowship Project

Introduction

This project investigated how a 'Blended Learning' approach, combining traditional and online delivery, and specifically the use of podcasting, can be used to address some of the problems encountered by part-time students. Teaching material and classroom sessions for selected core modules on two M.Sc. programmes in the School of Computing were recorded and made available as podcasts. Students were encouraged to annotate these podcasts and to develop companion podcasts that support the transfer of knowledge between their classmates and form the basis of a repository accessible to future cohorts.

There are four main objectives of the project:

- To develop, implement, evaluate and document an approach to using student-edited podcasts for part-time postgraduate education in the school of computing as part of a blended learning approach.
- To assess the impact of the use of student-edited podcasts, as part of a blended learning approach, on student engagement and retention in part-time postgraduate education in the school of computing.
- To provide recommendations on how to further develop a blended learning approach for part-time postgraduate education in the school of computing.
- To establish an open, accessible repository of teaching and learning material for use by current and future staff and postgraduate students of the school of computing.

The perceived benefits include:

- The development of a piloted and documented approach to blended learning for part-time postgraduate education in the school of computing.
- A piloted and documented methodology for the creation of podcasts by staff and the creation and annotation of same by students in the school of computing.
- A documented assessment of the impact on the use of student-edited podcasts on student engagement and retention of part-time postgraduate students in the school of computing.
- The establishment of an open, accessible online repository of teaching and learning for selected modules on postgraduate programmes in the school of computing.
- The contribution to the development of a broader blended learning strategy for the school of computing.

Project Evaluation

The evaluation process was undertaken in a multi-stage fashion. The initial evaluation process was to identify the most appropriate software tool to produce podcasts that would allow easy annotations to be added by the students. The second part of the evaluation process was to determine if some types of lessons more naturally lend themselves to podcasts. The final part of the evaluation was to assess the students' use of these podcasts and their contributions to the podcasting process.

There are a range of software tools available to create and publish podcasts, e.g. Audacity, Easy Podcast, ePodcast Creator, Free Podcast Maker, Podcast Accelerator, Podcast AutoCue, Podifier, PodProducer, WebPod Studio, Winpodcast. A range of these tools were reviewed under the following headings: *Ability to Record*, *Ability to Edit*, *Ability to Publish*, *Ease of Use*, and *Help/Support*.

Under these criteria *Audacity* (<http://audacity.sourceforge.net/>) was identified as the most appropriate tool for this research project; as well as being free and easy to use, *Audacity* supports a range of sound cards and channel mixers. At high frequency recording there are little or no latency issues, and a wide range of plugins are available without a fee.

Following this step, a number of lectures from two modules were recorded to determine whether some lessons were more applicable to audio podcasts than others, which was found to be the case. For example, one of the modules recorded concerned the creation of MindMaps; this topic was found to be unsuitable for audio podcasts as the teaching of this topic requires that the students develop a topological appreciation of the relationships between branches in a MindMap. Nonetheless a number of topics were identified which were highly applicable to podcasting, including *Interviews for Quantitative Data Collection and Analysis*, *Surveys for Quantitative Data Collection and Analysis*, *The Case Study Methodology*, *The PMI Lateral Thinking Technique*, *The CAF Lateral Thinking Technique*, *The OPV Lateral Thinking Technique*.

The final stage of evaluation was to assess to students' contributions to and use of the podcasts. It is worth noting at this point that one of the interesting effects of audio recording some of the lectures was that it caused the students to become more silent and less interactive in these sessions; they were nervous and reticent to contribute to group discussions when they knew they were being recorded. And yet when asked to contribute to podcasts individually they were articulate and quite frank about their views. The completed podcasts were made available to the students who praised the additional flexibility that they

provide, and evidence of the effect of these podcasts is becoming apparent in dissertations being submitted by these students.

Proposed Future Work

This project will continue on in a number of ways in the coming academic year, and in particular, the development of podcasts to support the induction process will be created. Based on the key theme of this research – that sometimes part-time students cannot be available to classes – induction is equally applicable to this situation, whereby part-time students just cannot make it in for induction, or can only attend part of the induction process.

Thus a number of new podcasts for the induction process will be developed:

- A virtual tour of the Kevin Street building, highlighting the key areas (lecture rooms, computer labs, School office, etc.), and we will encourage students to add to this with their own insights and humorous comments.
- Using electronic resources in the DIT and interacting with the technical staff.
- Using the library resources available to their fullest extent.
- Understanding rights and responsibilities as a student in the DIT.

These podcasts along with domain specific topics will continued to be developed to address the needs of the student both in general and from the topic specific material perspectives.

Faculty of Tourism

10. Get Smart! An Evaluation of an Initiative in Personal and Professional Development among First Year Undergraduates

Mary O’Rawe

School of Hospitality Management & Tourism

Contact: Mary.ORawe@dit.ie

Abstract

The third level learning environment today is characterised by many demand and supply-led challenges. Problems of student engagement, motivation and ability to perform in a third level education environment are well documented, as are the opportunities and challenges posed by new modes of delivery. Knight and Yorke highlight the importance of developing a strong set of personal ‘skills, understandings and personal attributes’ that make graduates ‘more likely to gain employment and be successful in their chosen occupations, which benefit themselves, the community and the economy’ (2003: 7).

In response to this complex relationship between the expectations of industry, student and academic stakeholder groups, the Get Smart! initiative is designed to offer an approach to developing personal and professional skills in first year undergraduate students throughout the DIT. It implements a range of innovative learning and teaching interventions, designed to give students greater ownership of their employability skills, and the confidence to cope with economic upheavals in order to identify and capitalise on career opportunities over a lifetime. Get Smart! tackles the complex relationships between transferable skills, employability and personal competencies, drawing on management competency frameworks and generic skills models. Key elements are the development of information literacy skills, a focus on professionalism, and closing the loop between student perception of the fit between self, programme and career. Engagement, motivation and socialisation are also key tenets.

Get Smart! adopts an innovative curriculum approach whereby the development of personal and employability skills are integrated into *all* modules of the first year curriculum. The initiative also experiments with a variety of traditional and contemporary modes (including Webcourses and Facebook) to assess the most effective means of engaging and communicating with first year students.

Keywords: engagement, first year curriculum, information literacy, personal development, transferable skills, retention

Outline of Fellowship Project

Introduction

The Get Smart! initiative is an innovative programme developed through a bottom-up approach within the School of Hospitality Management and Tourism, DIT. It embeds learning strategies, study skills, professional and personal development into *all* first year (particularly first semester) module content, thereby enhancing the learning experience for all students and contributing to the acquisition of a wide range of study, personal, professional, team and academic skills.

This new perspective on teaching and assessment methods aims to facilitate students in adapting confidently to third level education, contributing to the fulfilment of their personal and professional development through a supportive, stimulating and creative learning environment. Concepts of self-management, group management, information management and social awareness are highlighted, thereby further developing the student personally and professionally.

Overall rationale of Get Smart! project 2009/10: To develop a model that may be utilised more widely within the Institute, including the integration of online components to encourage active learning.

Objectives of Get Smart!

1. To improve levels of personal and professional development among first year students
2. To improve levels of information literacy so that students can perform at a high level in all modules, linking to Level 8 dissertation work
3. Through active learning, to increase students' engagement with their programme, and levels of motivation, mindful of the challenges of student retention
4. To support innovative assessment practices, employing online models and resources where possible
5. To foster a more creative and fun work environment
6. To realise enhanced employability and transferable skills

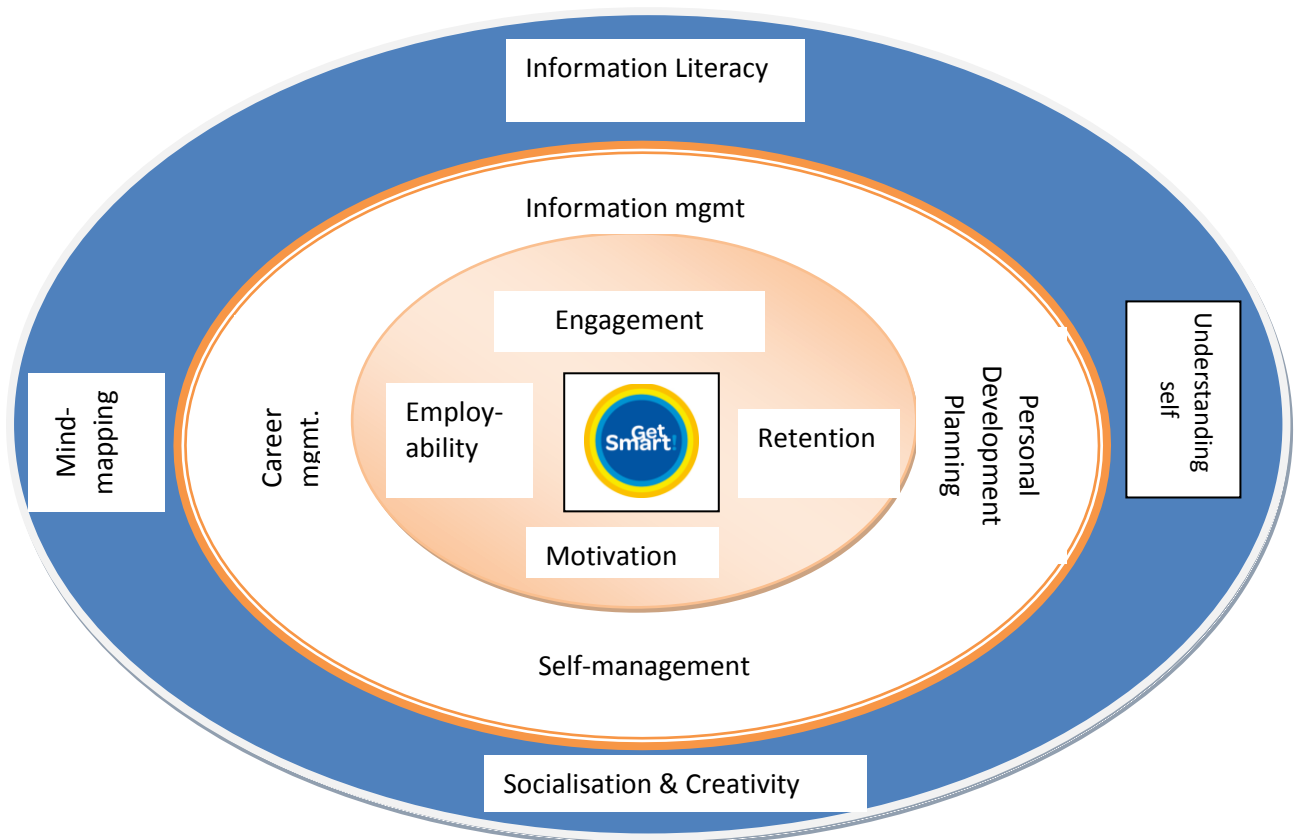

Figure 10.1: A model of the component parts of the Get Smart! initiative

Specifically, Get Smart! is delivered:

- (a) through a revised induction format, where students engage in a 90 minute Get Smart! session of group activities, writing, information searching and reflection
- (b) by integration into the tutorials of *all* modules which are scheduled during the relevant semester. (Each of the 6 modules per semester commits one to two hours to the Get Smart! initiative.)
- (c) by drawing on a three-session Information Literacy module which has been developed
- (d) through a four-hour Get Smart! workshop

- (e) by extensive utilisation of a Communications assessment template. This will mean that in all modules where similar assessment modes are used, common marking criteria will apply. Four such templates have been developed: short essay assessment guidelines, business report template, extended essay assessment guidelines and business presentation assessment template.
- (f) through Mind-mapping
- (g) by giving greater attention to written English, from the commencement of the student's participation in their programme at induction, and supported in time by online writing skills resources
- (h) by giving personal and professional development (PDP) a central role
- (i) by increased resources and time allocated to online resources to facilitate independent learning.

Components of Get Smart!

i. Information literacy sessions

In the academic year 2009/10, all first year students were encouraged to attend three information literacy sessions developed by the library in DIT Cathal Brugha Street in conjunction with Get Smart! These sessions were piloted in the academic year 2008/9 and revised in 2009/10 following discussions on how to create a more focused and systematic learning opportunity. Each of these sessions was linked to two academic modules and assessed through one.

The aim of these sessions was to enable students to confidently identify and use information from legitimate and academically recognised sources. This is particularly important as all final-year undergraduates in the school will be required to undertake a level 8 dissertation from September 2010. In some sessions, students also used practical worksheets which, again, were assessed through the aligned module.

183 students attended session 1

(Introduction to the research process, library orientation, getting going in the library, finding books and the internet and evaluation of information)

165 students attended session 2

(What's a journal and why are they important? Finding journal articles, developing search strategies and using them in a library database, and specialised hospitality, tourism, event and leisure databases)

140 students attended session 3

(Plagiarism, referencing and citing)

Pre-development research (carried out by the author as part of a School review 2007/8) showed that formal integration of these sessions into core modules would strengthen their effectiveness as well as helping to close the loop between these elements. Thus the three sessions were allocated a component mark from the available assessment marks for first year/first semester modules.

An online evaluation of the efficacy of these sessions was carried out in December 2009. Some 87.5% of respondents found these sessions 'very useful' or 'quite useful' in terms of feeling confident in searching for information; 70% rated the sessions 'very useful' or 'quite useful' in terms of settling into their programme, and 85% of students declared the IL sessions 'very useful' or 'quite useful' in terms of assessment preparation.

ii. *Workshop*

A central component of the Get Smart! initiative was the Get Smart! workshop. This four-hour workshop took place in February 2010 with the following objectives:

- to encourage self-reflection among students;
- to expose students to a range of themes around the area of personal development, professionalism, team dynamics, and employability;
- to foster socialisation among first year students, and between first year and final-year students.

The workshop followed the format of a keynote speaker (RTE's Kathryn Thomas), and an industry speaker who focused on professionalism and preparation for employment (Micheline Corr from 'The Firm'). DIT Careers' Peter Lewis facilitated students in examining the links between their academic programme, their personal input and their career, in conjunction with final-year students. The final component was a team-building 'game', where students competed in groups to solve a number of challenges.

Some 117 students attended the workshop, of whom 84 completed an evaluation. The workshop scored highest in respect of the following dimensions:

- The workshop activities stimulated my learning (mean 3.73 out of 5)
- The material caused me to think (mean 4.30)
- I enjoyed meeting, and working with, new students (mean 4.12)
- I will be able to use what I learned in this workshop (mean 3.83)

Comments also included: 'It was brill!', 'It was fab!', 'Inspiring', and 'Very impressive'.

Evaluation of the Most Effective Models of Delivery of Get Smart!

One of the key rationales for the development of Get Smart! is that students' methods of engagement in third level education are very different to those of a decade ago (Cloete, de Villiers & Roodt, 2009). There are a number of factors at the core of these changes in students' profiles, expectations and willingness to engage. The author employed a number of different tools to communicate the Get Smart! initiative to the students and to optimise engagement. In response to current student trends, Facebook and Twitter were used to encourage students to engage more in their academic environment. A comparative evaluation was carried out between Facebook/Twitter and the more traditional virtual learning environment (VLE), in the DIT's case Webcourses.

The following research questions were addressed in the evaluation of Get Smart!

- To what extent are first year undergraduates in the School of Hospitality Management Tourism, DIT engaging with the Get Smart! 'module' on Webcourses and/or a Facebook group set up to support the Get Smart! initiative?
- Do these students view social networking, and Facebook in particular, as a valid and attractive medium for academic learning?

A survey was distributed to a sample of first year undergraduates within the School of Hospitality Management & Tourism in May 2010. Questionnaires were distributed personally by the author and a usable total of 50 was achieved. It is intended to repeat this survey with modifications early in the academic year 2010/11.

A detailed explanation of the results is available from the author, however the following results were deemed valuable in determining the most effective mode of delivering Get Smart! and communicating to students in this regard: 98% of students surveyed had an active Facebook profile, compared with only 11% who were using Twitter. This low usage of

Twitter had already come to light in the early stages of the Get Smart! initiative where it was evident that students were not 'following' Get Smart! on Twitter.

Similar problems with engagement were found with the Webcourses site. The fact that 62% of students checked their Facebook account twice or more each day indicates the challenge that educators face in reaching students with more 'academic material'. There was no such similarly frequent interaction with Webcourses. The most frequent response for Webcourses was once or twice a week (41%).

Some 75% of students had joined the Facebook group specifically created for Get Smart! Those students who had not signed up offered reasons including

- 'Get Smart! is purely for academic material'
- Privacy concerns (four students)
- 'Never got around to it' (two students)
- 'Worried that lecturers will see my profile' (three students)
- 'Didn't know about it' (two students)

Respondents in general had a very low level of membership of 'academic' Facebook groups, citing only DIT library services and their own programme group as examples.

The main activity engaged in by students who were members of the Get Smart! group on Facebook was viewing photographs. These were photographs of the various Get Smart! events, including the workshop. The implications of visual learning may be important here. Traditional platforms such as Webcourses are not strong on these features and may need to become so if they are to encourage more interaction.

Despite their overwhelming engagement with Facebook, only 27% of students felt that they would like to see module/academic content posted there as its main location. This compares to 46% who felt that academic material should be reserved for Webcourses; 27% of students felt the two sites could potentially be used in conjunction with each other.

All the above points will be taken into consideration when further developing Get Smart!

Evaluation of Project

Central to the Get Smart! project was a comprehensive range of feedback mechanisms.

Date	Type of feedback/evaluation	Main outputs
Sept. 2009	Get Smart! school-wide meeting	Discussion of Get Smart! framework and its operationalisation
Dec. 2009	Get Smart! school-wide meeting	Feedback on first semester
Jan. 2010	Get Smart! school-wide meeting	Planning for Get Smart! workshop
Feb. 2010	Get Smart! school-wide meeting	Planning/finalisation of Get Smart! workshop
June 2010	Get Smart! school-wide meeting	Final wrap-up and feedback
Sept. 2009	Individual meetings M.O'R and Faculty librarian	Development of Information Literacy sessions
Sept. 2009	Get Smart! included on agenda for all programme meetings	Programme-specific implementation of Get Smart!
Dec. 2009	Student evaluation questionnaire	Available from the author
Dec. 2009	Student focus group	Student feedback on semester 1
Feb. 2010	Student evaluation questionnaire	Available from the author
May 2010	Student questionnaire: perceptions of the Get Smart! Facebook group	Available from the author
June 2010	School-wide meeting	Overall feedback and recommendations for 2010–2011

The author also held many individual meetings with the Faculty librarian, Brian Gillespie, the career team for the Faculty of Tourism and Food, industry representatives and the Head of School of Hospitality Management & Tourism.

Recommendations to the School/Institute

1. All induction sessions for first-years should be revised to include an introduction to third-level learning. Whilst research carried out for Get Smart! shows that students find it difficult to assimilate the amount of information they already receive at induction, consideration needs to be given to the balance between socialisation/familiarisation and preparation for academic rigour.
2. Curricula should no longer assume students' ability to be confident users of information or independent thinkers/writers.
3. Information literacy skills should be embedded into all first year modules, with face-to-face tutorials if possible, supplemented by e-learning tutorials. The acquisition of such skills needs to be incentivised by some form of accreditation. The format employed in Get Smart! (linking into assessment marks for first year modules) is one such possibility. The author feels that this approach has met with greater success than the traditional curriculum approach whereby educators 'bolt on' a module which focuses on personal development. The development of information literacy skills and their integration into *all* modules of the curriculum is the innovative approach used in the development of Get Smart!
4. Social networking tools should now be explored as a means of communicating with first year students and improving their levels of engagement with their programme. These tools need to be evaluated in terms of their use alongside Webcourses, or indeed, possibly instead of such platforms.

5. During the Get Smart! initiative, a clear picture has emerged whereby students saw Facebook as a social tool and did not fully endorse its use for formal teaching purposes, although they were very open to receiving messages through this medium and there *are* opportunities for more informal learning. The relative newness of these tools does make it more difficult to assess how they may develop over time. More understanding is needed of usage profiles of students in a certain college/faculty. However, making the progression from using social networks as communication tools, to their application as more academic tools to supplement/replace traditional teaching was ultimately not within the scope of the project within this academic year.
6. Students no longer avail of the traditional means of getting to know other first years, and indeed classmates. Student union activities, etc., are now often sacrificed for part-time, or pseudo full-time work commitments. This leads to a sense of disengagement and loneliness. Cross-programme socialisation, such as the Get Smart! workshop, can help in this respect.
7. Engagement is a factor of students' ability and motivation. Engaging with third level students is problematic in today's crowded environment of media platforms and messaging. There is a limited time span to secure the engagement of first year students, after which it is very difficult to restore. The author sees this timeframe to be the duration of the first semester.

Proposed Future Work

- There are clearly wide and varied opportunities for more detailed research into the use of Facebook, Twitter and other social networking tools in an academic environment. The author plans to develop this preliminary study in the academic year 2010/11 to attempt to give a more disaggregated view of how and why students use social networking in academic environments. The use of Facebook as a means of assisting social integration into third level life will be explored further through Get Smart!
- It would also be useful to perform a comparative analysis of online/distance education programmes as different levels of engagement are often evident within such student cohorts.
- To develop and implement Get Smart! beyond the first year curriculum.
- To enlarge the scope of Get Smart! whereby it combines and enhances aspects of academic and non-academic skills, liaising with the students union, Campus Life, Careers and the DIT Retention office.
- To roll out a number of web-based modules to support the delivery of Get Smart!

References

Cloete, S., de Villiers, C. & Roodt, S. (2009) Facebook as an Academic Tool for ICT Lecturers. Research presented at the annual meeting of Southern African Computer Lecturers' Association (SACLA), Eastern Cape, South Africa, pp. 16–22.

Knight, P. & Yorke, M. (2003) *Employability in Higher Education, Learning and Employability Series*. ESECT: LTSN Generic Centre.

11. Developing a Pedagogic Approach to Enhance Student Learning Before, During and After International Work Placement

Frank Cullen
School of Culinary Arts and Food Technology

Contact: Frank.Cullen@dit.ie

Abstract

The report commences with a brief overview of the Fellowship research and provides insight into the benefits of mobility. Erasmus mobility is viewed as a means to promote the Department of Culinary Arts in the international culinary arena via the student's skills and performance. It is clear from this research that the international internships provide exceptional opportunities for students to integrate and learn in different cultural environments. It is argued that this research addresses many of the unanswered issues related to internship before, during and after the experience: issues of knowledge, identity, integration and the student's personal development. This research framed the development of an internship model termed 'Academic Connection Internship Development' (ACID) that supports better learning and student development during national and international mobility. The research provided insight, understanding and knowledge in relations to student development and concerns when living and working in another country, and internship in general.

Keywords: assessment, e-learning, internship, student engagement and retention, work placement

Outline of Fellowship Project

Introduction

The Department of Culinary Arts is a department in the School of Culinary Arts and Food Technology, located in Dublin Institute of Technology (DIT), Cathal Brugha, Dublin 1. The Department of Culinary Arts' involvement in international culinary internships has experienced exponential growth over the past five years with the assistance of European Leonardo da Vinci and Erasmus funding for European internships. The aim of this research was to develop a pedagogic approach to enhance student learning. The research was an extension of current ongoing analysis of international internships to develop an in-depth understanding of the dynamics involved in international culinary internships. To achieve this aim the research question was identified as 'What is the "nature of being" for culinary arts students before, during and after international culinary internship?' To address the research question the methodology adopted was a mixed method pragmatic approach using phenomenological views from students of the B.A. in Culinary Arts, and quantitative data providing in-depth analysis of the 2006 to 2009 cohorts to establish their attitude towards and understanding of international internship, and develop a framework for internship. The research identified that the student's self-identity is interrupted during the internship and a categorisation of in-group membership is conducted that is based on the student's culinary practice. The research identified the need to develop better internship structures and presents a model for internship titled the Academic Connection Internship Development (ACID). Finally a framework for internship is presented that sets out a model for internships to promote connectivity between the academic and internship domains.

Framework for Internship

Figure 11.1 sets out a process to address internship preparation and other issues identified in this research.

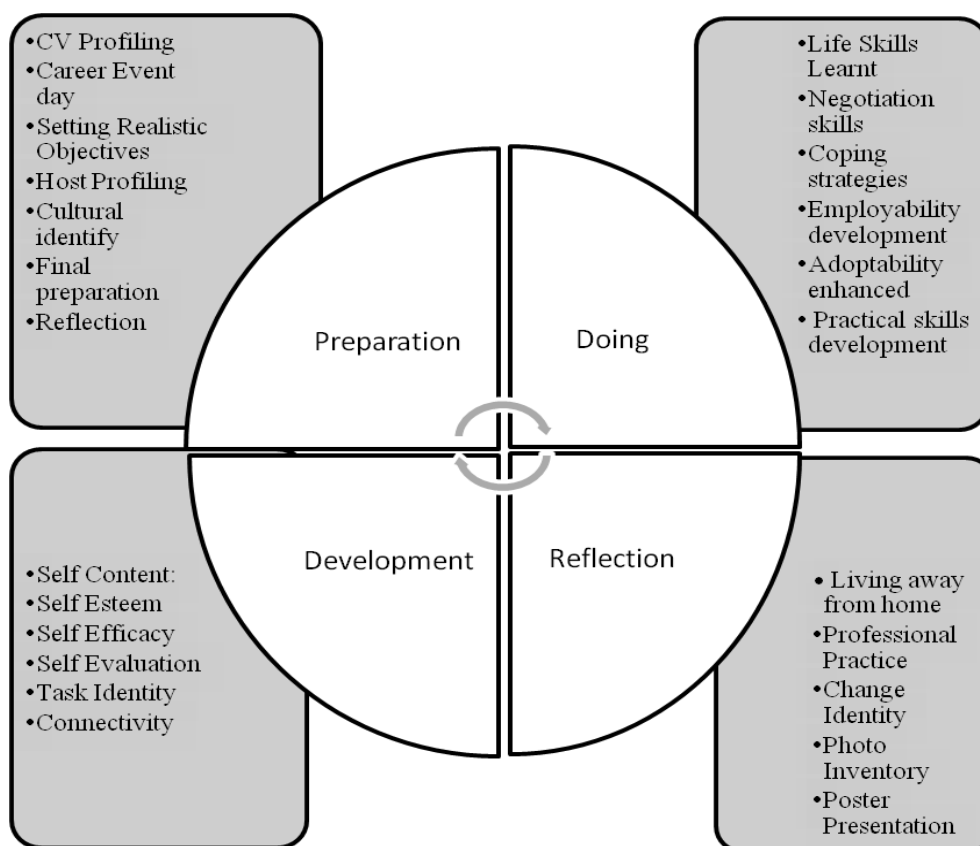

Figure 11.1 Academic Connection Internship Development (ACID) Model

Source: Proposed Internship Model to Address Academic Issues: developed for this research

The ACID model presented in Figure 11.1 identifies the learning experience related to ‘doing’ such as, living away from home, coping with the new environment, developing negotiation skills for dealing with everyday life and the internship as a process to enhance employability skills, task identity to allow adoptability. The reflective process identified captures the key issues associated with ‘self’ and the reconstructing of the self, taking on a new identity both in the professional practice, and self as a confident individual capable of exploring and living in new cultural environments. The next section deals with the internship framework in a stage-by-stage process.

The internship activities should incorporate a four-stage grading process carrying equal weighting:

- *Stage One:* Internship preparation continuous with three briefing/workshop sessions, 25%
- *Stage Two:* Career workshop, 25%
- *Stage Three:* Students internship with mentors appraisal, 25%
- *Stage Four:* Internship final report, poster and/or PowerPoint presentations, and debriefing session, 25%

Each stage of the process should carry a weighting of 25% of the final grade. The placement officer working alone can deal with a maximum of 200–225 students. In cases where the

number of students engaged with internship moves beyond 225, assistance is needed for the placement officer either on a full-time or part-time basis, depending on the increase in numbers. Some Erasmus management funding could be diverted to pay for a flexitime member of staff to assist the placement officer with Erasmus placement internships. Moving forward with Grange Gorman in mind, the DIT should be considering the development of a central hub for placement officers similar to DCU's setup where 900 students are engaged in national and international internship. The placement officer should be timetabled to meet with the students for at least one hour per week during the semester prior to the internship period. On programmes where the internship takes place in the first semester of the academic year, the placement officer should be timetabled in the second semester of the academic year prior to the internship.

Programmes that have internship timetabled in semester one should consider moving the internship into semester two to facilitate better continuum between academic and internship activities.

Internship Preparation

→Stage One of Internship Preparation Semester One

Briefing/Workshop Session One

The briefing session should take place at the start of the academic year in September/October of semester one, and be inclusive of all students preparing for internship. In cases where some programmes commence internship in semester one of year three, these students should be included in the preparation starting in semester one of year two of their programme. This briefing is an introduction to internship and its main focus is to motivate students to engage with the process, identifying the academic requirements for internship and making the necessary connectivity between the internship and the academic programme. The first briefing session should include one or two short presentations from previous internship students.

The session should also include topics such as:

- Why go on international internship-opening discussion
- Dealing with expectations
- Making the most of your internship experience
- Opportunity to develop
- Becoming a reflective practitioner
- What to plan for part one
- Erasmus funding documentation requirements, open discussion and including a booklet for internship
- Academic programme assessment requirements with open discussions to facilitate a questions and answers session
- Setting up of the Erasmus Showcase Event, open discussion and identification of student representatives
- A short internship booklet/handout should be provided setting out the requirements for the programme, including each of the topical areas above and a tick-box checklist

Students should be encouraged to start looking for suitable organisations as internship hosts following this session.

Briefing/Workshop Session Two

The briefing session's main focus should be to enhance the connectivity and provide further encouragement for student engagement with the internship process. Slides 11–17 identify the necessary requirements relative to the research findings. This briefing session should include topics such as:

- Professional practice concerns
- The reflective portfolio reinforcement of stage two
- Moving the internship forward
- Academic work and connectivity with internship
- Time-management actions
- Questions and answer session

Briefing/Workshop Session Three

This is the final briefing session to take place in the first week of May, reflecting on the requirements of the programme and encouraging students to develop individual plans.

- Reflective journal
- Interim report
- Final report
- Postal presentation
- Time management actions
- Questions and answer session

→**Stage Two: Career Workshop**

The career preparation focuses on preparing the students for their future career. This process is not unlike the requirements for internship. The internship preparation requires the student to assess the type of internship best suited to their interests and skills. Discussions with the DIT career officers informed the research on the aspects included in the career event:

- Self-assessment – examining values, interests, personality and skills (VIPS)
- Occupational research
- Networking and job search
- CV and cover letters
- Interview technique

→**Stage Three: Internship with Host Partner**

In order to ensure that the host partners and internship training agreements meet the learning objectives of the programmes the industry mentor needs clear guidelines to development of an understanding of the links between the academic domain and the connections between the student's programme of study and the internship. The following sections present recommended guidelines.

Industry Mentor's Role

The Mentor will ensure that the learner is fairly treated and that the work assigned is appropriate and challenging to the student, meeting the standard required for the level of award. The Mentor

- will encourage and facilitate the students learning
- encourage the development of new skill via a period of shadowing for a period of time each week

- assess the student's performance through encouragement and guidance during busy periods
- review the student's objectives and help set realistic objectives for internship and assist the student to achieve the objectives
- complete the internship assessment marking sheets.

→**Stage Four: Final report and Poster and/or PowerPoint Presentation**

This is the final stage of the internship process. The student's report needs to be based on a reflective journal providing a 'reflection of the reflections'. This style of report writing develops the student as a reflective practitioner and will further enhance the connectivity between the academic and internship domains. This should be a celebration of achievement, allowing the students to interact with each other and discuss their experiences. The internship, class tutors and placement officers discussions should draw upon:

- learning identified during the internship
- cultural integration
- benefits and any pitfalls experienced
- the poster presentation for the Erasmus Showcase event.

The internship tutor/s should also engage with the placement officer to assess and assist the student's development of:

- CV profiling
- career day participation
- setting realistic objectives
- host profiling
- cultural identify
- final preparation
- encouraging student reflection
- visiting the student during the internship.

Summary of Recommendations

1. Develop as policy to implement the four-stage internship process identified for Level 7 and 8 awards with internships offering 10 or more ECTS.
2. Adopt the Academic Connection Internship Development (ACID) Model for international internship as a minimum standard in DIT to ensure the internship is viewed as a continued academic process and meets the requirements of the National Framework of Qualification.
3. Adopt the National Framework Internship Models (NFI) developed for Higher Education awards with a view to reducing the number of current internship modules in the system. Page 20 presents the NFI module approach and a draft generic internship module for Level 8 award in Appendix 4.
4. Ensure the academic connectivity with internship by timetabling academic staff for each programme that incorporates work-based learning.
5. Develop a central hub for internship placement officers similar to UL and DCU operations, all programmes that incorporate internship would go through this hub to ensure quality standards in DIT's internship process.
6. Timetable the Placement Officer to meet with students weekly on all programmes that include internship.
7. Develop a flexible approach to awarding ECTS and grading the internship where necessary, that allows student progression (on a pending completion) into the next

stage of their studies having completed the first three stages of the internship process, the grade to be awarded on completion of stage four (final report and poster or PowerPoint presentation).

8. Review the current marking scheme in the DIT with a view to developing a more robust general grading system to minimise the possibility of grade inflation.
9. Adopt the proposed grading system in Appendix 1 for internship.
10. Award industry mentors for their contribution to internship following an agreed number of years service to DIT.
11. Develop a workshop for lecturers engaging in international internships.
12. Develop internship committees with a rotating chair every two years.

Proposed Future Research

- Feature projects could develop an e-portal that allows potential internship partners to upload offers of internship onto the DIT website.
- Research is needed to establish the cost benefit of developing a central office/hub for internship activities similar to the internship office in DUC.
- The development of an industry mentoring online training package is required and mentors should receive credits for completion.
- Future work: it is intended to develop a booklet on internship that sets out the process using an A to Z approach. This could be downloaded from the DIT site by all Colleges.
- Conduct research in the greater DIT to identify generic internship module and reduce the current number of module.

Acknowledgements

I would like to acknowledge the following groups and individuals for their valued contribution and co-operation in developing this framework.

Students of the B.A. in Culinary Arts.

Students of the B.Sc. in Culinary Entrepreneurship.

Ms Stephanie Bourke, Placement Officer.

College of Arts and Tourism Internship.

Dr Bernadette Quinn, Hospitality Management and Tourism.

Dr Julie Dunne, Food Science & Environmental Health.

Dr Mairtin Mac Con Iomaire, School of Culinary Arts and Food Technology.

Industry Respondents.

Staff of the DIT's LTTC.

DIT Careers Advisers Ms Jill Barrett and Mr Peter Lewis

Teaching Fellowship 2009–2010 Dissemination Outputs, Papers, Presentations

María-José González and Odette Gabaudan, School of Languages

- Gonzalez, M.-J. & Gabaudan, O. (2010) *Peer Assisted Learning at the DIT*. Presentation at the 4th Annual Peer Assisted Learning Symposium May 2010, a two-day symposium focusing on Student Led Learning: Supporting the 1st Year Experience at Galway-Mayo Institute of Technology. The symposium was a showcase for Peer Assisted Learning projects in Irish universities and Institutes of Technology.
- As part of the DIT Fellowship programme, an overview of the PAL project was given in Grangegorman on 25 September 2009. Updates of work in progress was given through the LTTC website, at the Showcase on 13 January 2010 and on 29 April as part of a Faculty presentation. Recommendations based on the research work were provided at the DIT Management Forum on 10 May 2010. In addition to the report included in this publication, a final summary of work will be presented as a poster at the 12 January 2011 Showcase event.

Maurice Murphy and Lloyd Scott, School of Construction Management & Technology

- Murphy, M., Cheanux, A., McGovern, E. & Pavia, S. (2009) *An Evaluation Case Study – a Historic Building Information Model (HBIM) of the Leaning Tower of Pisa*, ICERI2009 Conference Programme. Edited by International Association of Technology, Education and Development, IATED, Madrid, 2009.
- Murphy, M. & Scott, L. (2010) *Historic Building Information Modelling: A Virtual Learning Tool*, Proceedings of the 38th Conference on Computer Applications and Quantitative Methods in Archaeology, Granada, Spain, April 2010.
- Dublin Region Higher Education Alliance (DRHEA) – Sharing Academic Excellence Event, UCD May 2010, Presentation.
- As part of the DIT Fellowship programme, an overview of the project was given in Grangegorman on 25 September 2009. Updates of work in progress were also given through the LTTC website, at the Showcase on 13 January 2010 and on 24 February, as part of a Faculty presentation. Recommendations based on the research work were provided at the DIT Management Forum on 10 May 2010. In addition to the report included in this publication, a final summary of work will be presented as a poster at the 12 January 2011 Showcase event.

Catherine Prunty and Maire Crean, School of Architecture

- LIN (Learning Innovation Network) 'Motivating Learners through Creative Approaches to Assessment' 2nd Annual Conference October 2009 – Poster Presentation, *'Formative Assessment and the 1st and 2nd Year Student titled 'Formative Assessment Structures in 1st & 2nd Year Architectural Technology to Enhance Student Learning'*.
- ICERI 2009 (International Conference of Education, Research and Innovation), Madrid 2009. International Association of Technology, Education and Development. *'Formative Assessment Structures in 1st & 2nd Year Architectural Technology to Enhance Student Learning'*. Paper/poster presentation.
- All Ireland Symposium on Built Environment Education (AISBEE) Conference in Belfast, January 2010. Conference Paper – *Formative Assessment Structures in 1st and 2nd Year Architectural Technology to Enhance Student Learning that Could Be Used Effectively on other Engineering and Built Environment Courses*. ISBN 978-1-85923-245-3.
- Dublin Region Higher Education Alliance (DRHEA) – Sharing Academic Excellence Event, UCD May 2010, Presentation, *'Formative Assessment Structures in 1st & 2nd Year Architectural Technology to Enhance Student Learning'*.

- College of Engineering and Built Environment, Dublin Institute of Technology, Teaching Fellowship Seminar, May 2010, '*Formative Assessment as a Teaching and Learning Methodology*'.
- As part of the DIT Fellowship programme, an overview of the project was given in Grangegorman on 25 September 2009. Updates of work in progress were also given through the LTTC website, at the Showcase on 13 January 2010 and on 24 February, as part of a Faculty presentation. Recommendations based on the research work were provided at the DIT Management Forum on 10 May 2010. In addition to the report included in this publication, a final summary of work will be presented as a poster at the 12 January 2011 Showcase event.

Alice Luby, School of Marketing

- Kiely, T., Boylan, F. & Luby, A. (2009) Untying the Accountancy Knot. Poster presentation at the NAIRTL conference 11–12 November 2009.
- Boylan, F. & Kiely, T. (2010) Action Accounting: Untying the Accountancy Knot. Paper presented at the EdTech 2010 Conference in May.
- As part of the DIT Fellowship programme, an overview of the project was given in Grangegorman on 25 September 2009. Updates of work in progress were also given through the LTTC website, as part of a Faculty presentation on 24 February and at the Showcase on 13 January 2010. In addition to the report included in this publication, a final summary of work will be presented as a poster at the 12 January 2011 Showcase event.

Conor Horan, School of Marketing

- Horan, C. (2009) Research Topic Selection & Development: Suggested Guidelines for the Student Researcher. Chapter 2 in *Approaches to Qualitative Research: Theory and its Practical Application*, Hogan J., Dolan, P. & Donnelly P. (eds), Oak Tress Press.
- As part of the DIT Fellowship programme, an overview of the project was given in Grangegorman on 25 September 2009. Updates of work in progress were also given through the LTTC website, as part of a Faculty presentation on 24 February and at the Showcase on 13 January 2010. In addition to the report included in this publication, a final summary of work will be presented as a poster at the 12 January 2011 Showcase event.

Gavin Duffy, School of Electrical Engineering Systems

- Bowe, B. & Duffy, G. (2010a) A Framework to Develop Lifelong Learning and Transferable Skills in an Engineering Programme. In IEEE (ed.) *Transforming Engineering Education: Creating Interdisciplinary Skills for Complex Global Environments*. Dublin, Ireland: IEEE.
- Bowe, B., & Duffy, G. (2010b) A Framework to Develop Lifelong Learning and Transferable Skills in an Engineering Programme. In *3rd International Symposium for Engineering Education*. University College Cork: ISEE.
- Dublin Region Higher Education Alliance (DRHEA) – Sharing Academic Excellence Event, UCD May 2010, Presentation.
- As part of the DIT Fellowship programme, an overview of the project was given in Grangegorman on 25 September 2009. Updates of work in progress were also given through the LTTC website, at the Showcase on 13 January 2010 and on 24 March, as part of a Faculty presentation. Recommendations based on the research work were provided at the DIT Management Forum on 10 May 2010. In addition to the report included in this publication, a final summary of work will be presented as a poster at the 12 January 2011 Showcase event.

Michael Carr, School of Civil and Building Engineering Services

- Carr, M. (2010) Presentation at Irish Maths Service Teaching Conference. Carlow, May.
- Carr, M. (2010) Presentation at 15th SEFI MWG Seminar and 8th Workshop GFC in June.
- As part of the DIT Fellowship programme, an overview of the project was given in Grangegorman on 25 September 2009. Updates of work in progress were also given through the LTTC website, at the Showcase on 13 January 2010 and on 24 March, as part of a Faculty presentation. Recommendations based on the research work were provided at the DIT Management Forum on 10 May 2010. In addition to the report included in this publication, a final summary of work will be presented as a poster at the 12 January 2011 Showcase event.

Robert Howard, Cathal Flynn and Fran Pedreschi, School of Physics

- As part of the DIT Fellowship programme, an overview of the project was given in Grangegorman on 25 September 2009. Updates of work in progress were also given on 16 Dec as part of a Faculty presentation and at the Showcase on 13 January 2010. Recommendations based on the research work were provided at the DIT Management Forum on 10 May 2010. In addition to the report included in this publication, a final summary of work will be presented as a poster at the 12 January 2011 Showcase event.

Deirdre Lawless and Damian Gordon, School of Computing

- As part of the DIT Fellowship programme, an overview of the project was given in Grangegorman on 25 September 2009. Updates of work in progress were also given through the LTTC website, on 16 December as part of a Faculty presentation and at the Showcase on 13 January 2010. Recommendations based on the research work were provided at the DIT Management Forum on 10 May 2010. In addition to the report included in this publication, a final summary of work will be presented as a poster at the 12 January 2011 Showcase event.

Mary O'Rawe, School of Hospitality, Management & Tourism

- O'Rawe, M. (2010) Can we be 'friends'? Social Networking and Student Engagement in an Academic Environment. Paper presented at *Tourism and Hospitality Research in Ireland Conference*, Shannon, June.
- **Award:** Get Smart! was awarded 'highly commended' in the CONUL (Consortium of National & University Libraries) Irish Information Literacy Awards 2010.
- As part of the DIT Fellowship programme, an overview of the project was given in Grangegorman on 25 September 2009. Updates of work in progress were also given through the LTTC website, on 28 October as part of a Faculty presentation and at the Showcase on 13 January 2010. Recommendations based on the research work were provided at the DIT Management Forum on 10 May 2010. In addition to the report included in this publication, a final summary of work will be presented as a poster at the 12 January 2011 Showcase event.

Frank Cullen, School of Culinary Arts and Food Technology

- Cullen, F. (2010) Conference Paper presented (virtual) and published INTED 2010 see link <http://www.iated.org/inted2010/publications>.
- Cullen, F. (2010) Presentation at the Erasmus DIT Dublin Joint Staff Mobility Week March.
- Cullen, F. (2010) Paper in Food Science and Technology. Published by Taylor and Francis.
- As part of the DIT Fellowship programme, an overview of the project was given in Grangegorman on 25 September 2009. Updates of work in progress were also given through the LTTC website, on 28 October as part of a Faculty presentation and at the Showcase on 13 January 2010. In addition to the report included in this publication, a

final summary of work will be presented as a poster at the 12 January 2011 Showcase event.

Appendix 1.1

EoL strategic fellowship projects 2009/10 strategy grid

- drawing upon and contributing to the findings from the DIT's own data and national and international data and best practice as appropriate.

	First Year Curriculum	Assessment	Student Engagement & Retention	Curriculum Development
Modularisation	Projects in this cell would focus on curriculum reform – facilitated by our modular structure – to assist commencing students change their learning strategies to meet the expectations of HE.	Projects in this cell would consider the impact and potential of modularisation on assessment with particular attention to the pedagogical potential of formative assessment as a way to limit the overall summative assessment load.	Projects in this cell would address the way in which the DIT modular structure could be used to redesign delivery of programmes and/or curriculum design in a way that would be responsive to those factors contributing to retention.	Projects in this cell would use the modular structure to design programmes and to use teaching and assessment methods that would encourage student participation and engagement in their learning.
Diversity	Projects in this cell would explore and compare different strategies to support learner engagement within the first year of undergraduate programmes.	Projects in this cell would focus upon the use of ‘non-traditional’ assessments as a way to provide feedback to students on their learning.	Projects in this cell would focus upon the use of strategies to include, engage and retain non-traditional students within existing programmes.	Projects in this cell would develop creative ways to use the DIT modular structure to address the needs of non-traditional students.
E-Learning	Projects in this cell would make use of online resources to encourage active learning and information literacy among first year students.	Projects in this cell would leverage technology to support innovative assessment practices.	Projects in this cell will aim to improve student retention through the use of e-learning technologies.	Projects in this cell would focus on the use of e-learning technologies to engage students and motivate them to more active learning.

Appendix 1.2
Feedback from evaluation of teaching fellowships questionnaire 2009/10

- 1. How did you first become aware that the DIT was establishing Faculty Teaching Fellowships in each Faculty e.g. did you see them advertised, word of mouth etc.?**
 - word of mouth – 5
 - by e-mail /advert – 4

- 2. How did you become a Teaching Fellow for your Faculty eg were you nominated, did you apply?**
 - nominated by Faculty/ HoS – 2
 - Applied to Faculty – 7

- 3. How did you feel this process worked for you? How might it be improved if there is another call for Faculty Teaching Fellowships next year?**
 - It helped me see the variety of work going on looking at innovative teaching methods within the DIT. I hope it continues, with wider publicity for academics to take part and reflect on their teaching practices. I think evening sessions would have been more beneficial – head cleared and time to partake in the information sessions.
 - I think it worked very well, but then I got one of the fellowship so I would think that.
 - I was very happy with it (but then I did get one!) Similar to good assessment, a predefined set of criteria makes it very fair, e.g. alignment of project with strategy reduces subjectivity.
 - Form filling very laborious. Also, because projects are infant, it is not possible to give exact deadlines, outcomes etc.
 - It was a lot of additional work in the time span. Perhaps over a longer period of time.
 - It worked fine except that we did not hear in time about the funding for the buyout of hours. It meant we were not able to get support at the beginning of the semester.
 - It worked well, Head of Learning Development at the time made School aware of it.
 - It worked fine it was open competition which places more value on the Fellowship award.
 - No clear assessment strategy of how the project would be assessed.

- 4. a) Fellowship money from the HEA SIF project was set aside to buy out teaching hours. Do you feel this was the best way to support your work?**
 - Yes – 7
 - No – 1

b) If No, what would have been a better system?

 - I got four hours off my timetable which has been really helpful in allowing me to back up what we're trying to do on the ground with a theoretical framework. I've been able to do some writing in the last few weeks because of this. I've submitted a paper for a conference which my school will pay for. Maybe the fellowship could fund a conference visit?
 - Additional support dissemination of research
 - Flexibility to have hours added to a CID

- 5. a) As well as a Teaching Fellowship launch, a series of six lunchtime faculty sessions have been organised to support and promote your work within the DIT. Have you attended the sessions?**
 - Yes – 8
 - No – 1

b) If YES how many have you attended?

 - 50% of them, unfortunately clashed with my teaching timetable.

- I've attended them all, but not necessarily for the full two hours due to timetable commitments.
- All except one.
- I think I missed one only.
- I attended two. I am not able to attend tomorrow's as I have a validation of a new programme.
- All to date
- About 40%. The sessions were held on Wednesdays and I had a full timetable each Wednesday in semester one.
- One, in my own faculty.

c) How useful have these been to you and how might they be improved in any subsequent years?

- Extremely useful also to see that all ideas are welcome or have some relevance – very encouraging.
- I like the chance to discuss education ideas with like-minded people so I'll always feel these sessions are useful and will always try to get to them. They provide the opportunity for open discussion which is essential.
- Very useful, but I always seem to be rushing to or from a lecture.
- Very useful in finding out what others are doing and what problems they encountered and how they got over the problems. Perhaps they were too far apart in time.
- It is very useful to see what other projects are about and how they have resolved their 'teething problems'.
- Always thought provoking and interesting.
- I found the discussions and networking with lecturers and staff from other sectors of DIT of great value because you get insight into what these areas are researching and how.
- Honestly too busy teaching and trying to do the project without going to meetings. I think just let the fellow get on with their projects. There's no need to meet every month.

6. Support from the LTTC staff has been made available to help you plan/implement your Fellowship project. What kind of support have you found most useful so far and what kind of additional support would you like for the next stage of your work?

- Maybe a clearer induction for dissemination to department colleagues and head.
- I meet with the head of teaching and learning in my faculty every two weeks or so. I find this very useful and it keeps me focused on my work. I also did a one-off meeting with Roisin Donnelly. I found this meeting to be useful. On the whole though, I don't want to attend too many meetings as I need the time to do the research.
- I have received any support I've needed from the LTTC staff. I also have the support of my head of learning development who has experience in my area. This has been sufficient for me.
- LTTC support extremely useful. Would benefit from more support on learning objectives side as well as technology side.
- Faculty sessions.
- Excellent support from Muireann.
- Muireann's support has been excellent – she provided IT expertise and momentum to the project.
- I have not used the support yet but will answer this by the end of the project as I will need a fair bit of assistance now that I have the bulk of the data together.

- It was difficult to find out if and when the money was transferred into the School's account. But apart from that just let the fellows get on with their projects and produce their stated deliverables.

7 a) Has being a teaching fellow for your faculty been as you expected?

- Yes – 6
- No – 3

b) If NO, in what way has it been different?

- I really wasn't sure what to expect because my project involves change and was only going to be possible if others in my school came on board. I was very anxious that I may not get co-operation. However, the enthusiasm on their part has been much greater than I expected and we now have a cohesive group. I did not think so much would be achieved in this regard.
- Took more time than I had anticipated.
- Funding has been extremely difficult to pin down. This has led to much wasted time and effort.
- I had no expectations. I don't think anyone in my School knows I'm a fellow.

8. Any other comments you would like to make about your Teaching Fellowship?

- It was more work than I realised, but that was perhaps my naive perception initially.
- I only got the time off my teaching after week 6, in semester 1. This was very frustrating as this is when I needed to get the majority of the project set up.
- We need to keep learning and teaching on the agenda at all levels and the teaching fellowships are a very powerful tool in this regard. It continues to be a great experience for me and I'm fortunate to have had the opportunity.
- Very beneficial to see other projects in unrelated fields and share problems.
- I think we have learned a huge amount about how to manage our project for Year 1 students. We have continued to update and try new ideas reaching out to Year 1 students with the support of Year 2 Mentors. It would be a great idea to continue next year with the Year 1 students becoming mentors in Year 2.
- It's a pity the project has been clouded by funding issues as it has been very enriching otherwise.
- I think the attitude of the LTTC is excellent and I know that when I ask for assistance it will be provided. A big thanks to the team in the LTTC.
- I can't remember how I heard I got the fellowship, but I would nice if the names of the new fellows were officially announced to all staff.