



Technological University Dublin
ARROW@TU Dublin

Masters

Science

2007

The Clinical Utility of Forced Vital Capacity Measured at Six Seconds in the Spirometric Detection of Airways Obstruction

Janine Kelly
Technological University Dublin

Follow this and additional works at: <https://arrow.tudublin.ie/scienmas>

Recommended Citation

Kelly, J. (2007). *The Clinical Utility of Forced Vital Capacity Measured at Six Seconds in the Spirometric Detection of Airways Obstruction*. Masters dissertation. Technological University Dublin. doi:10.21427/D7H030

This Theses, Masters is brought to you for free and open access by the Science at ARROW@TU Dublin. It has been accepted for inclusion in Masters by an authorized administrator of ARROW@TU Dublin. For more information, please contact yvonne.desmond@tudublin.ie, arrow.admin@tudublin.ie, brian.widdis@tudublin.ie.



This work is licensed under a [Creative Commons Attribution-Noncommercial-Share Alike 3.0 License](https://creativecommons.org/licenses/by-nc-sa/3.0/)





The clinical utility of forced vital capacity
measured at six seconds in the spirometric
detection of airways obstruction.

Janine Kelly

A thesis presented to

The School of Physics

Dublin Institute of Technology

MPhil

2007

Supervisors:

Dr Patrick Manning

Dr Patrick Goodman

Dr Matthew Hussey

Declaration

I certify that this thesis which I now submit for examination for the award of Master of Philosophy, is entirely my own work and has not been taken from the work of others save and to the extent that such work has been cited and acknowledged within the text of my work.

This thesis was prepared according to the regulations for postgraduate study by research of the Dublin Institute of Technology and has not been submitted in whole or in part for an award in any other Institute or University.

The work reported on in this thesis conforms to the principles and requirements of the Institute's guidelines for ethics in research.

The Institute has permission to keep, to lend or to copy this thesis in whole or in part, on condition that any such use of the material of the thesis be duly acknowledged.

Signature _____ Date _____
Candidate

Acknowledgements

I wish to express acknowledgement to Dr Patrick Goodman for his ongoing support and advice and also to Dr Matt Hussey for his advice and suggestions. Special thank you to Dr Patrick Manning for his encouragement and advice throughout.

Table of Contents

Content		Page
CHAPTER 1	Introduction	1
1.1	Background	1
1.2	An alternative end of test	3
1.3	Aims of thesis	5
1.4	Specific questions	5
1.5	Outline of thesis	6
1.6	Summary	7
1.7	References	8
CHAPTER 2	Anatomy and Physiology of the Human Respiratory System	10
2.1	Introduction	10
2.2	Anatomy of Respiratory System	10
	2.2.1 Nose, Pharynx and Larynx	12
	2.2.2 Trachea	12
	2.2.3 Bronchi, Bronchioles and alveoli	13
	2.2.4 The lungs and Bronchial tree	13
2.3	Physiology of Respiration	15
	2.3.1 Pressure Gradients	16
	2.3.2 Resting breathing	17
	2.3.3 Inspiration	18
	2.3.4 Passive Expiration	19

2.4	Summary	19
2.5	References	20
CHAPTER 3	The Mechanics of breathing	22
3.1	Introduction	22
3.2	Airflow Patterns	23
3.3	Physics of airflow	23
3.4	Site of Airways Resistance	26
3.5	The Forced Expiratory Manoeuvre	29
3.6	Dynamic airway compression	31
	3.6.1 Tidal Breathing	32
	3.6.2 Forced Breathing	33
	3.6.3 Equal Pressure Point	34
	3.6.4 Waterfall theory	36
	3.6.5 Wave Speed Theory	36
3.7	Obstructive Ventilatory Pattern	37
3.8	Summary	38
3.9	References	39
CHAPTER 4	Spirometric parameters and Flow volume curves	41
4.1	Introduction	41
4.2	The evolution of spirometry measurements	42
4.3	Spirometer Devices	47
	4.3.1 Introduction	47
	4.3.2 Mass Flow Sensor	48

4.4	Indications for Spirometry Testing	49
4.5	Measurement Technique	51
4.6	Measurement Variability	53
4.7	Spirometric Parameters	54
4.7.1	Vital Capacity, Forced Vital capacity	55
4.7.2	Forced Expiratory Volume at (t) seconds	55
4.7.3	Ratio of Expired Volume to Flow	56
4.7.4	Forced Average Expiratory Flow as a percentage of FVC	56
4.7.5	Peak Expiratory Flow	56
4.7.6	Forced Expiratory Time	56
4.8	Expiratory Flow volume curves	58
4.9	Interpretation	60
4.9.1	Reference Equations	61
4.9.2	Defining Normality	63
4.9.3	Defining Airways Obstruction using Lower Limits of Normal.	65
4.10	Summary	66
4.11	References	67
CHAPTER 5	Literature Review	72
5.1	Introduction	72
5.2	Background	72
5.3	Studies into an alternative end of test point	73
5.4	Summary	80

5.5	References	81
CHAPTER 6	Methodology	85
6.1	Introduction	85
6.2	Section A	86
	The spirometric findings of smokers compared to non-smokers.	
6.3	Section B	88
	A comparison of FEV_1/FEV_6 to FEV_1/FVC in diagnosing airways obstruction	
6.4	Section C	92
	FEV_1/FEV_6 as a substitute for FEV_1/FVC in a subgroup of elderly patients using two sets of reference equations	
6.5	Summary	92
6.6	References	93
CHAPTER 7	Results and Discussion	94
7.1	Introduction	94
7.2	Section A: The spirometric findings of smokers compared to non-smokers.	95
	7.2.1 Aim of study	95
	7.2.2 Results	95
	7.2.3 Discussion	100
	7.2.4 Summary	104
	7.2.5 Hypostasis	104
7.3	Section B: A comparison of FEV_1/FEV_6 to FEV_1/FVC in diagnosing airways obstruction.	105

	7.3.1	Aim of study	105
	7.3.2	Results	105
	7.3.3	Discussion	107
7.4		Study B1: The effects of age on FEV ₁ /FEV ₆ and FEV ₁ /FVC ratios.	108
	7.4.1	Aim of study	108
	7.4.2	Results	108
	7.4.3	Discussion	109
	7.4.4	Summary	112
7.5		Study B2: The effects of the degree of airway patency on the FEV ₁ /FEV ₆ and the FEV ₁ /FVC ratios	113
	7.5.1	Aim of study	113
	7.5.2	Results	113
	7.5.3	Discussion	115
	7.5.4	Summary	117
7.6		Study B3: A comparison of FEV ₁ /FEV ₆ to FEV ₁ /FVC in diagnosing airways obstruction.	118
	7.6.1	Aim of study	118
	7.6.2	Results	118
	7.6.3	Discussion	119
	7.6.4	Summary	122
7.7		Section C: FEV ₁ /FEV ₆ as a substitute for FEV ₁ /FVC in a subgroup of elderly patients using two sets of reference equations	123

	7.7.1	Aim of study	123
	7.7.2	Results	123
	7.7.3	Discussion	127
	7.7.4	Summary	130
7.8		References	131
CHAPTER 8		Conclusions	140
8.1		Summary	142
8.2		Further Work	143
APPENDIX			144

CHAPTER 1 INTRODUCTION

1.1 BACKGROUND

Lung Function testing has been available as a widespread diagnostic test in the hospital setting for over 70 years. The term lung function is a collective name for a group of physiological tests that are designed to objectively assess a particular part or process of respiration. The advent of computerised analysis coupled with the standardisation of both equipment and testing procedures have helped to secure lung function testing an important place in the field of medical diagnostics.

The primary test of lung function is called spirometry; its name comes from the Latin word 'spirare' (to breathe) and the Greek word 'metron' meaning to measure. In a spirometry test a subject is instructed in a series of very energetic breathing manoeuvres designed to objectively assess the flow and volume of exhaled air. The test is carried out using equipment known as a spirometer. The spirometer records exhaled air volume, and produces graphic and numeric information in the form of spirometric parameters and tracings that can depict and describe the mechanical properties of the lung. These spirometry values give a snapshot into how the lungs are functioning mechanically just as a blood pressure measurement gives a quick and painless indication of a patient's cardiovascular status. The advantage of spirometry over other tests of lung function is in its simplicity and the fact that it can be performed as a stand alone test without the need for complicated computer software packages and gas analysis. It is also non-invasive and if performed and interpreted correctly spirometry has the potential to be a very effective screening tool for general lung health and in particular airflow limitation¹.

The measurement of the maximal volume of gas expired from the lungs is called the forced vital capacity (FVC) (expressed as a function of time) and the measurement of the maximum flow expired after 1 second of forced expiration is called the forced expiratory volume in 1 second (FEV₁). A spirometry test can be helpful in detecting the presence or absence of a condition associated with airflow limitation. Airflow limitation is defined as a ‘disproportionate reduction of maximal airflow from the lung in relation to the maximal volume that can be displaced’². The degree to which the airways are limited or ‘obstructed’ can be determined by the ratio of FEV₁ to FVC i.e. (FEV₁/FVC). When the airways are obstructed, for example in an individual with asthma, the airway walls contract and so reduce the flow of air passing through them. Flow is often reduced out of proportion to the volume that can be exhaled and hence the ratio of FEV₁ to FVC is reduced. To determine if a measured value is normal or abnormal it is compared to its equivalent ‘reference’ value. Reference values are values obtained from regression equations that have been calculated from the average values of a representative healthy population. Reference values are dealt with in more detail in chapter 3.

Spirometry has been found to be an invaluable tool for the detection and management of lung disease and for this reason, spirometric parameters are used extensively for defining and categorising airflow limitation³.

Airflow limitation is the main characteristic of chronic obstructive pulmonary disease (COPD), a disease which is a major source of mortality and morbidity worldwide and which is projected to become the third leading cause of death in the world by 2020⁴. COPD is an umbrella term that encompasses lung diseases which exhibit airflow limitation and includes asthma, chronic bronchitis, and emphysema. It is a preventable and treatable disease. Cigarette smoking is a major risk factor in the development of COPD⁵. However, in many smokers COPD can go undetected for many years, causing progressive loss of lung function at an accelerated rate. Population studies have shown

that simple spirometry testing can identify subjects at risk for undergoing accelerated lung function loss and can offer a valuable opportunity to identify individuals at risk of developing COPD by detecting airflow limitation in its early stages^{6,7}. In two large European studies, spirometry was found to be the key indicator of an accurate diagnosis of COPD in the primary care setting by general practitioners^{8,9}. Apart from its merits as a screening test for airflow limitation, spirometry is also a major independent and indirect predictor of cardiovascular morbidity and mortality¹⁰.

1.2 AN ALTERNATIVE END OF TEST TO THE FVC

The forced vital capacity (FVC) measurement is at the core of a spirometry test but it possesses an inbuilt variability in its primary measurement, lung capacity. All other spirometric indices are calculated from this capacity and therefore the ability to measure this parameter accurately is critical to achieving a successful test. Reproducibility of the FVC manoeuvre depends entirely on patient effort and co-operation; this requires that rigid guidelines be in place for determining an acceptable and reproducible test. The guideline that determines when a manoeuvre is complete and hence an accurate determination of expired volume is called the 'end of test' criterion. Current guidelines for the standardisation of spirometry testing in adults require a subject to inspire to maximal volume and then expel with both speed and force for at least six seconds or until no more than 25 millilitres (mls) of air are expelled over a period of 1 second. For reproducibility this manoeuvre is required to be repeated three times in succession with the goal of achieving two capacities within 150 mls of each other¹¹.

This end of test criterion is in turn dependant on the time taken to forcefully exhale all the air from the lungs, called the forced expiratory time (FET) which usually varies from subject to subject.

The majority of adults without airways disease have an average forced expiratory time of between six and seven seconds. In elderly subjects and subjects with airflow limitation, expiratory times are prolonged. The spirometry manoeuvre can then become physically exhausting to the patient as expiratory times stretch out in some cases for as long as 20 seconds, without adding much more additional clinical information. During a testing session if the end of test criterion cannot be achieved the measurement is judged to be unacceptable and the manoeuvre is repeated. In the clinical setting it is not unusual to have patients with prolonged expiratory times that extend beyond 10 seconds and patients are frequently encouraged to continue expiring until the end of test criterion is satisfied. This can make the test unacceptable to the patient.

In response to the need for an alternative end of test criterion, a forced expiratory manoeuvre of a duration that could be easily attained by the majority of adults has been researched in recent times. This has led to the suggestion of a forced expiratory manoeuvre based on six seconds duration, FEV₆, as a surrogate for FVC. A shorter manoeuvre such as FEV₆ has the potential of reducing the burden of the test for the patient and lowering the overall testing time. It also has the potential of improving interpretation by reducing the variability of the volume measurement and making it statistically more accurate when compared with reference values for the same measurement. Ideally this surrogate measurement should at least retain the diagnostic capabilities of the traditional FVC manoeuvre.

Figure 1.1 represents a graphical description of the FVC manoeuvre called a spirogram which is a plot of exhaled volume against time. Spirometry tracings will be covered in more detail in chapter 3. This shows the FVC and the FEV₆ end of test point in a subject with a prolonged forced expiratory time.

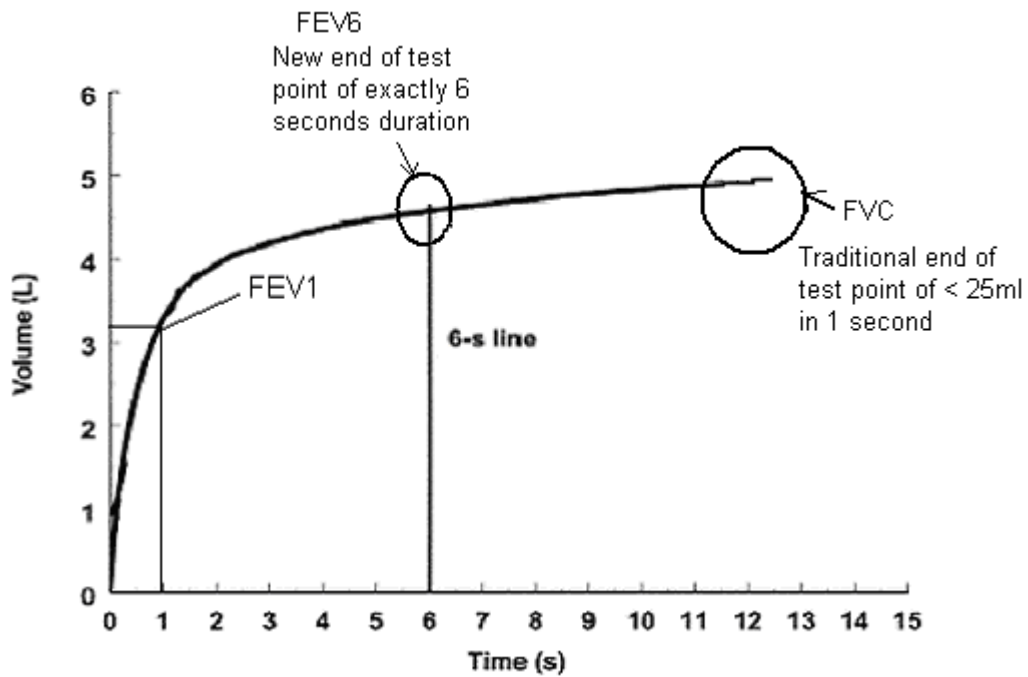

FIGURE 1.1 SPIROGRAM DEPICTING BOTH FVC AND FEV₆ END OF TEST POINTS¹

1.3 AIMS OF THESIS

The main aims of this research thesis are to assess the utility of the FEV₆ manoeuvre in patients undergoing spirometry testing and in particular to determine if spirometric indices measured at six seconds are clinically useful in pulmonary function, especially in screening for early lung disease in smokers with an otherwise normal spirometry pattern.

SPECIFIC QUESTIONS

The main questions this thesis seeks to answer are:

1. Are FEV₆ and FEV₁/FEV₆ as or more clinically useful as the gold standard FEV₁ and FEV₁/FVC?
2. In our patient population can FEV₆, FEV₁/FEV₆ be used instead of FVC and FEV₁/FVC without surrendering relevant diagnostic information?

3. In older individuals where expiratory times are naturally longer, does the FEV_6 parameter diagnose airflow limitation as accurately as the FVC parameter using specific reference equations for this age group?

OUTLINE OF THESIS

Chapter 2 gives an overview of the anatomy of the human respiratory system, and a brief description of the mechanisms involved in resting breathing. This chapter serves to provide a basic understanding of the mechanics of forced expiration which will be discussed along with the mechanics of airflow in Chapter 3.

Chapter 3 looks at the physics of airflow and introduces the concept of airflow limitation. Sections on the physiology of the forced expiratory manoeuvre and a brief description of dynamic airway compression provide an introduction to the differences that exist between obstructed and normal airflow.

Chapter 4 details the history of spirometry measurements, defines its parameters, introduces the equipment used to measure spirometry and outlines the guidelines and limitations associated with spirometry testing.

Chapter 5 gives an overview of published research to date on the FEV_6 parameter.

Chapter 6 is a short overview of the methodology and the statistical analysis used in this study.

Chapter 7 is a presentation and discussion of the results from each of the three studies designed to answer the questions posed by this research.

Chapter 8 gives a brief summary of the conclusions arrived at in this thesis and suggestions for further research into this topic.

1.6 SUMMARY

A shorter spirometry test manoeuvre that is easier for the patient to perform and that has the potential to increase the accuracy of the test by minimising measurement variability is an attractive feature for any diagnostic test. This is especially true for one that may have a future in screening for early COPD in at risk subjects such as smokers. An essential requirement of this possible surrogate test is that it at least upholds the diagnostic ability of the traditional spirometry manoeuvre. This will be investigated retrospectively in a patient population in this research.

1.7 REFERENCES

1. Clotet J, Gomez-Arbones X, Ciria C, Albalad J. Spirometry is a good method of detecting and monitoring COPD in high-risk smokers in primary health care. *Arch Bronconeumol* 2004; 40:155-159
2. Pellegrino R, Viegi G, Brusasco V, Crapo RO, Burgos F et al. Interpretative strategies for lung function tests. *Eur Respir J* 2005; 26: 948-968
3. Pawels RA, Buist AS, Calverly PM, Jenkins CR, Hurd SS. GOLD Scientific Committee. Global Strategy for the diagnosis, management, and prevention of chronic obstructive pulmonary disease. NHLBI/WHO Global Initiative for Chronic Obstructive Lung Disease (GOLD) Workshop summary. *Am J Respir Crit Care Med* 2001; 163:1256-1276
4. Murray CLJ, Lopez AD. Alternative projection of mortality and disability by cause 1990-2020: global burden of disease study. *Lancet* 1997; 394:1498-1504
5. Burrows B, Knudson RJ, Cline MG. Quantitative relationships between cigarette smoking and ventilatory function. *Am J Respir Dis* 1977; 115:195-205
6. Zielinski J. Early selection of COPD in a high-risk population using spirometric screening. *Chest* 2001; 119:731-735
7. Lunback B, Linberg A, Lindstrom M, Ronmark E, Jonsson AC, Jonsson E, et al. Obstructive Lung Disease in Northern Sweden Studies. Not 15 but 50% of

smokers develop COPD? - Report from the Obstructive Lung Disease in Northern Sweden Studies. *Respir Med* 2003; 97(2): 115-122

8. Van Schayck CP, Loozen JMC, Wagena E, Akkermans RP, Wesseling J. Detecting patients at a high risk of developing COPD in general practice: cross-sectional case finding study. *BMJ* 2002; 324:1370-1375
9. Zielinski J. Early selection of COPD in a high-risk population using spirometric screening. *Chest* 2001; 119:731-735
- 10 Beaty TH, Cohen BH, Newell CA et al. Impaired pulmonary function as a risk factor for mortality. *Am J Epidemiol* 1982; 116: 102-113
- 11 Pellegrino R, Viegi G, Brusasco V, Crapo RO, Burgos F et al. Standardisation of spirometry testing . *Eur Respir J* 2005; 26:319-338

FIGURES

1. Vmax database version 5A Sensor medics Viaysis

CHAPTER 2 ANATOMY AND PHYSIOLOGY OF THE HUMAN RESPIRATORY SYSTEM

2.1 INTRODUCTION

This chapter gives a brief outline of the anatomy and physiology of the respiratory system. The respiratory system made up of a group of interlinking components; each component has its own unique structure, which serves to underlie its function. If any one of the components is affected by disease this will impact negatively on the system as a whole. The respiratory system has close links with the circulatory system of the human body, both work together as pumps to maintain a steady state within the body. The respiratory system grows as the body changes from birth to old age and also adapts to the many challenges that comes its way from the simple increase in ventilation required to facilitate exercise to the complex response to disease. This chapter aims to introduce the various structures of the respiratory system and give a brief description of their function.

2.2 ANATOMY OF THE RESPIRATORY SYSTEM

The main function of the respiratory system is to facilitate gas exchange. The respiratory system is divided into two components the upper respiratory tract and the lower respiratory tract¹. The upper respiratory tract includes the nose, mouth, pharynx and larynx. The lower respiratory tract consists of the trachea, bronchi, bronchioles and alveoli. Each component of the respiratory system has a role to play in gas exchange. Gas exchange occurs when air rich in oxygen is inhaled into the lungs through the nose conducted through the respiratory system to the gas exchange areas of the lungs, called alveoli. Gas exchange occurs at this point and the carbon dioxide that is not wanted by the system is then expelled through the same pathway in the exhaled air.

The anatomy of the lung lends itself to carrying out gas exchange as efficiently and effectively as possible by providing a clear pathway from atmosphere to alveoli. The airways connect the alveoli with the outside world, and play a pivotal role in the understanding of lung function in health and disease. Figure 2.1 shows the anatomy of the lungs.

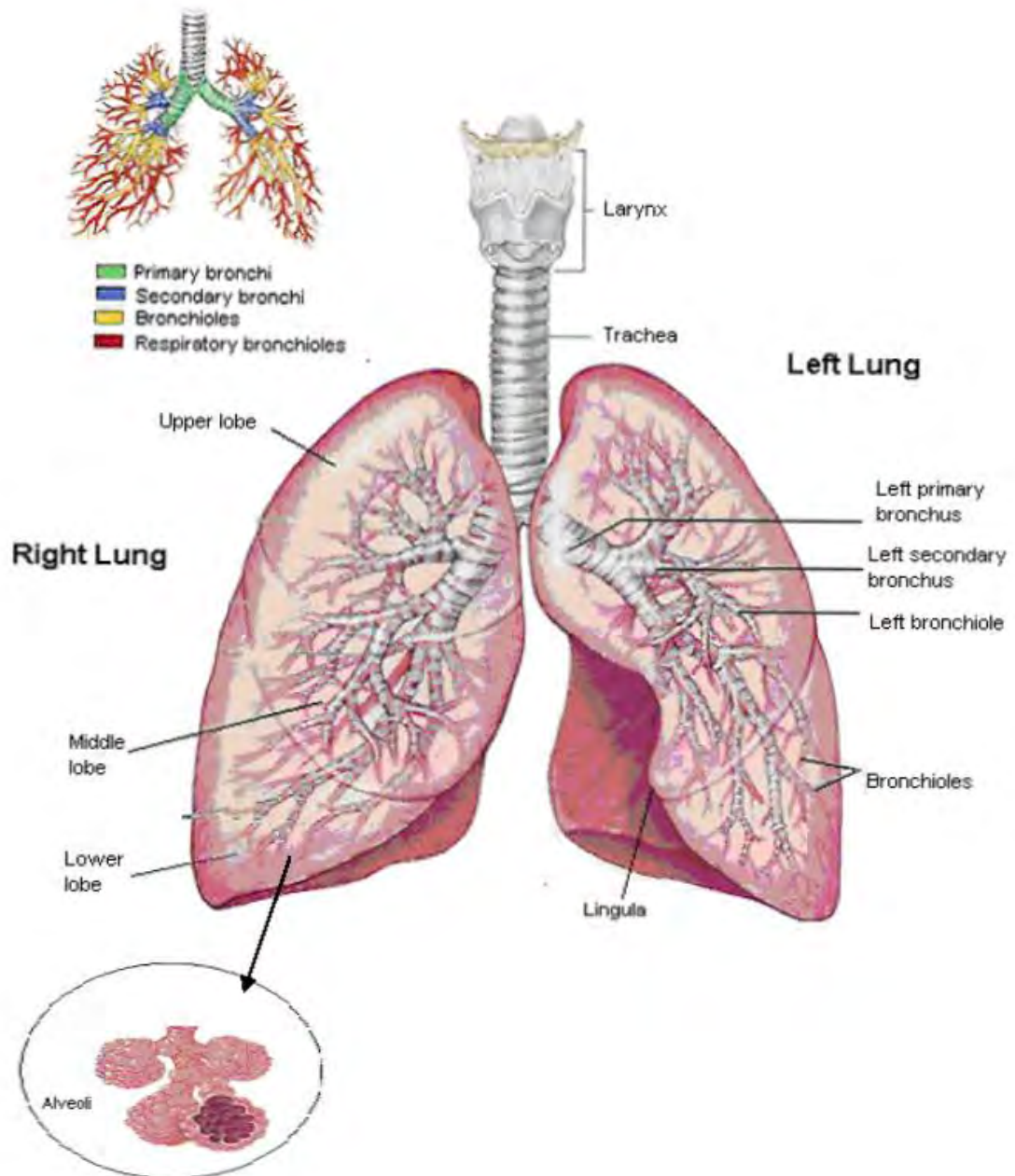

FIGURE 2.1 ANATOMY OF THE HUMAN LUNGS¹

2.2.1 THE NOSE, PHARYNX AND LARYNX

Air enters the respiratory tract through the nose and the mouth. Normal breathing occurs through the nose which has the advantage over mouth breathing in that nasal respiratory mucosa serves to humidify and filter the incoming air. In this mucosa are cells and glands lining the nose which secrete mucous to trap particulate matter and tiny coarse hairs which propel trapped particles towards the pharynx. The term pharynx comes from the Greek word meaning 'throat'; it is a passageway for both air and food and is connected to the voice box or larynx. The primary function of the larynx is to prevent swallowed material entering the respiratory tract and it is also responsible for speech².

2.2.2 TRACHEA

The trachea is approximately 11-13 centimetres long in adults³ and is essentially a tube that is prevented from collapsing by c-shaped rings of cartilage that surround it. As shown in figure 2.2 the trachea is lined with ciliated pseudostratified columnar epithelium and goblet cells, which trap and remove debris before reaching the lungs.

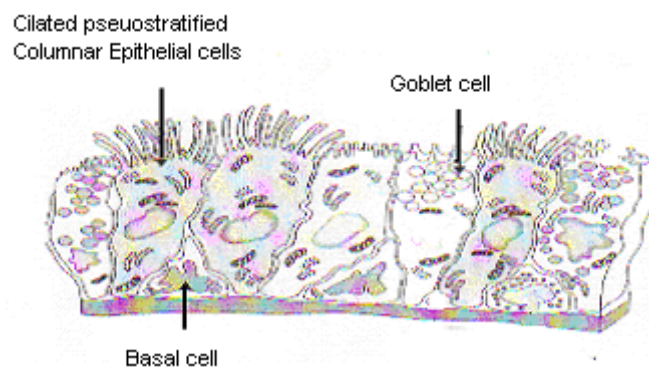

FIGURE 2.2 CELLS OF MUCOSAL LINING OF TRACHEA²

2.2.3 BRONCHI, BRONCHIOLES AND ALVEOLI

The trachea divides into two main branches called primary bronchi, left and right for each lung. The bronchi, just like the trachea, contain cartilage rings in their walls which allow for physical support. Each primary bronchus divides repeatedly in each lung giving rise to smaller branches called bronchioles which in turn subdivide into tiny microscopic branches called respiratory bronchioles. The respiratory bronchioles terminate into tiny saclike structures called alveoli where gas exchange occurs. A dense network of capillaries to maximise gas exchange surrounds each alveolus. There are approximately 400 million alveoli in each adult lung, and this figure is closely related to a persons total lung volume, that is larger lungs have been found to contain more alveoli⁴.

2.2.4 THE LUNGS AND BRONCHIAL TREE

The lungs lie in what is known as the thoracic or chest cavity, a rigid but expandable structure that protects the delicate organs contained within it⁵. The two lungs are separated from each other by a mass of tissues known as the mediastinum. Each lung has an apex or upper part which is located about one inch from the clavicle, and a base or lower part that rests above the principal muscle of respiration called the diaphragm. The right lung has three lobes (upper, middle and lower) while the left lung has an upper and middle lobe with an appendage of the upper lobe called the lingual. A membrane called the pleural membrane surrounds each lung and consists of an inner layer called the visceral pleura and an outer layer covering the ribcage called the parietal pleura. These pleural layers are shown in figure 2.3.

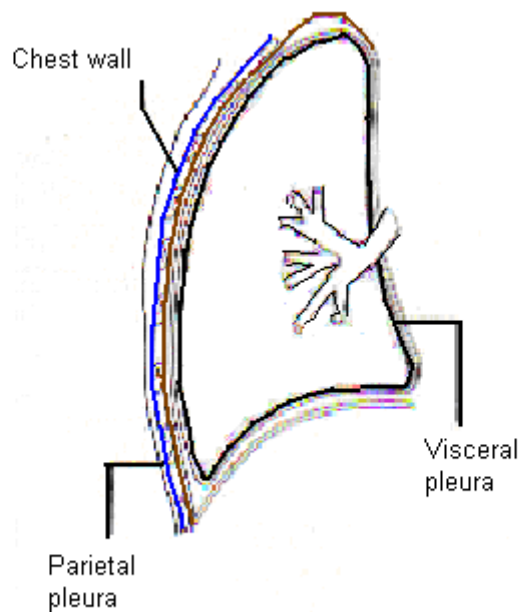

FIGURE 2.3 PLEURAL CAVITIES OF THE LUNG³

The space between these two layers is called the intrapleural cavity, and it contains a small amount of pleural fluid allowing lubrication of the membranes preventing friction during breathing. The intrapleural cavity or space plays a pivotal role in how the lungs inflate and deflate.

The geometry of the airways is analogous to a branching tree turned upside down. Where the tree first starts to branch at the trachea is referred to as generation zero and each set of branching thereafter gives rise to a new generation resulting in twenty-three generations in total⁶. Figure 2.4 shows the generation of branching from trachea to alveoli. The first sixteen generations are collectively referred to as the conducting airways, the remaining seven generations, which occupy most of the lung, are referred to as the respiratory zone and this is where gas exchange occurs.

As each branch subdivides the radius of that branch is reduced and as the branches get smaller the total cross sectional area rapidly increases. The function of such a huge increase in cross sectional area is to maximise the potential for gas exchange by making

sure that as much surface area as possible is available for the diffusion of gas across the blood gas barrier. The blood gas barrier itself is extremely thin, approximately 0.3 μm , and its surface area is enormous, approximately 50-100 square meters⁷.

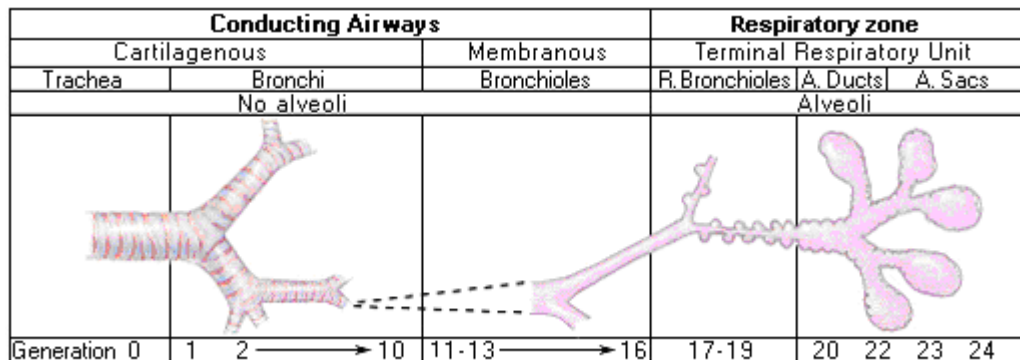

FIGURE 2.4 GENERATION OF AIRWAYS FROM TRACHEA TO ALVEOLAR LEVEL⁴

2.3 PHYSIOLOGY OF RESPIRATION

While the primary function of the lung is to facilitate oxygen and carbon dioxide gas exchange, the chest muscles also play a major role in the mechanism behind breathing. The main respiratory muscles used are the diaphragm and the external intercostals. The diaphragm is a big dome shaped muscle that lies at the base of the lungs and when it contracts as it does during inspiration, it straightens out and in doing so increases the thoracic cavity volume. As in Figure 2.5 the external intercostals are located between the ribs and on contraction they have the power to pull the ribs up and in doing so push the sternum forward increasing the diameter of the thorax. The muscles used for expiration are called the internal intercostals and the abdominal muscles. As expiration does not actively involve muscle contraction it is referred to as a passive motion. Normally the expiratory muscles are only called on during the laboured breathing that accompanies strenuous exercise. However, in subjects with obstructive ventilatory diseases such as COPD, these muscles may be called on early in an expiratory effort for assistance.

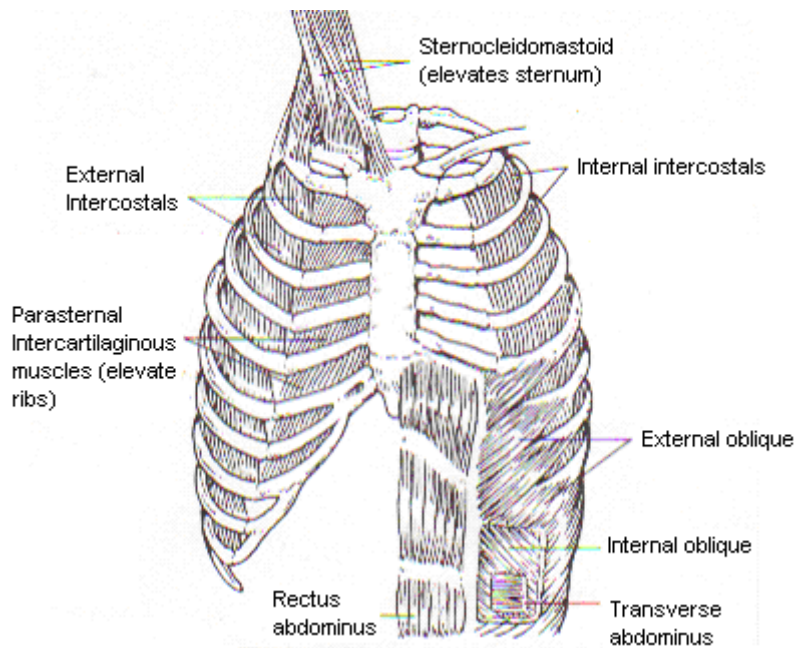

FIGURE 2.5 MUSCLES OF THE THORACIC CAGE AND ANTERIOR ABDOMEN⁵

2.3.1 PRESSURE GRADIENTS

The lungs can be looked upon as elastic structures contained in a chest cage that is expandable. The lungs have inward recoil that is directly balanced by the outward recoil of the chest wall. Breathing requires continuous movement of the lungs to and from their resting position. Initiation of breathing requires that a pressure called the elastic inward recoil pressure (P_L) of the lung is overcome. The ability of the lungs to overcome this pressure and expand and contract in a normal breathing motion relies on many factors working together, both inside and outside of the lungs⁸. Factors underlying the generation of airflow involve the behaviour of pressure differences in the respiratory system enabling the breathing process and preventing the lungs collapsing on expiration. During resting breathing air moves into the lungs by bulk gas flow from an area of higher pressure outside the lung to an area of lower pressure within the lung. The pressure outside the lungs called the atmosphere pressure (P_{atm}) is higher than the

pressure contained in the alveoli called alveolar pressure (*Palv*) and so air will be automatically drawn into the lungs.

The opposite will occur when pressure in the alveoli is greater than that of the atmosphere and air will automatically leave the lungs on expiration. Between breaths, alveoli and atmospheric pressure are equal and no flow exists. There is a tension in the thorax between the lungs trying to collapse and the chest wall trying to spring out. As mentioned in section 2.2.4 the space between the chest wall and the lungs is called the intra pleural space. This space has its own pressure called the intra pleural pressure (*Ppl*) which serves to balance the two opposing forces and prevents the lungs from collapsing. At any given time the *Ppl* is negative with respect to *Patm*, and negative with respect to *Palv*, because the *Palv* are connected to the atmosphere by the branching airways.

2.3.2 RESTING (BETWEEN BREATHS)

Figure 2.6 depicts the pressure gradients of the lung before inspiration begins.

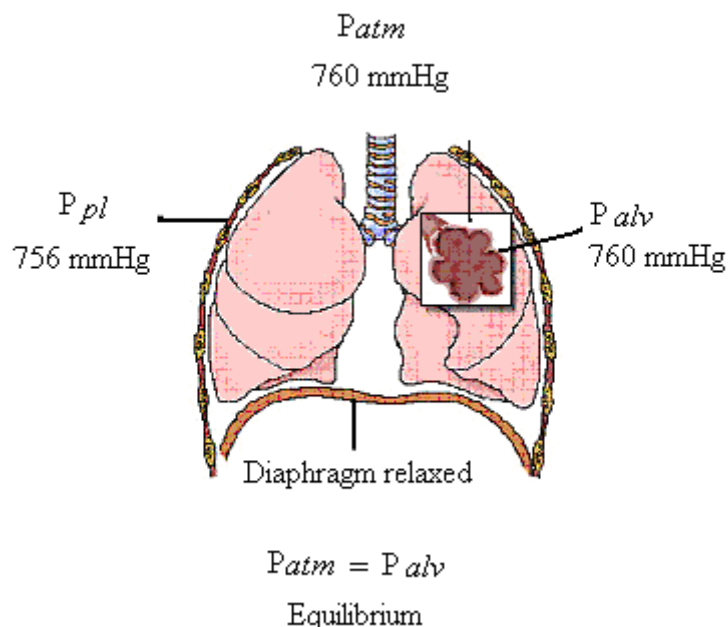

FIGURE 2.6 PRESSURE GRADIENTS OF THE LUNG BETWEEN BREATHS⁶

Just before inspiration, $Patm$ is equal to $Palv$ and as the pressure is zero in the airways no air flow occurs and the diaphragm is in a relaxed position. The lungs remain inflated due to the Ppl remaining at a lower pressure than the pressure contained in the alveoli. Thus the airways remain patent as the negative intrapleural pressure is balanced by a positive pressure of the same magnitude holding the airway open.

2.3.3 INSPIRATION (BREATHING IN)

On inspiration, the muscles contract, expanding the rib cage and the attached pleural membrane and thus widening the intrapleural space and lowering its pressure. This difference in pressure or pressure gradient between intrapleural and alveolar regions pushes the lung wall outwards and the lungs expand increasing alveolar space and lowering the pressure there. When $Palv$ is lower than $Patm$ air will flow into the lungs.

Figure 2.7 depicts the pressure gradients existing in the lung at inspiration. As inspiration begins both the intrapleural and the alveolar pressure fall and air flows into the lungs.

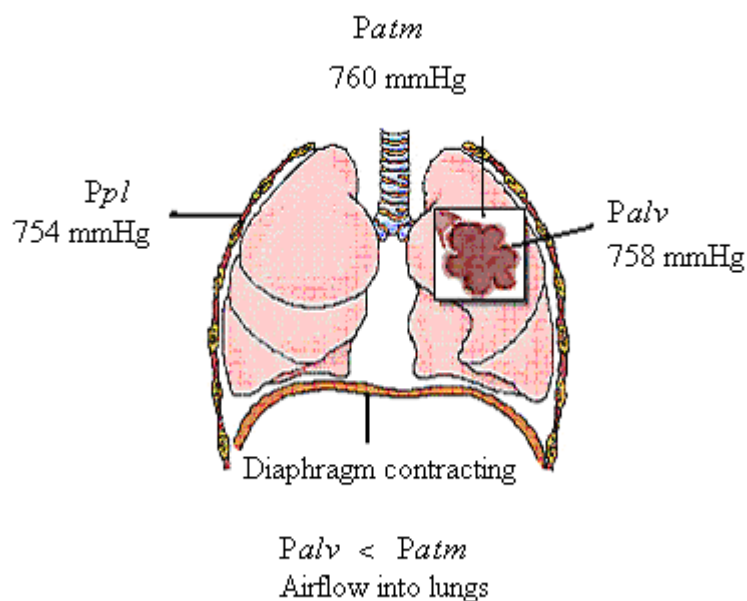

FIGURE 2.7 PRESSURE GRADIENTS OF THE LUNG ON INSPIRATION⁶

2.3.4 PASSIVE EXPIRATION (BREATHING OUT)

On passive expiration, the diaphragm and the intercostal muscles relax allowing the lung to recoil. After inspiration there is additional air in the lungs, which causes P_{alv} to be greater than P_{atm} thus causing bulk gas flow out of the lungs. Figure 2.8 depicts the pressure gradients existing in the lung at passive expiration.

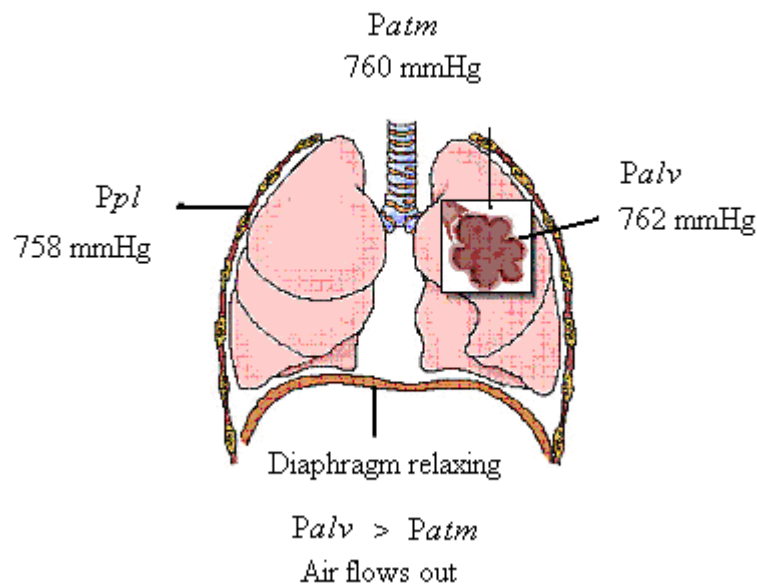

FIGURE 2.8 PRESSURE GRADIENTS OF THE LUNG ON PASSIVE EXPIRATION⁶

2.4 SUMMARY

This chapter briefly outlined the anatomy and physiology of the human respiratory system. A section on the respiratory muscles used in breathing and a brief description of the mechanisms involved in normal breathing serve to provide a basic understanding to the mechanics underlying forced expiration which will be discussed along with the physics of airflow in Chapter 3.

2.5 REFERENCES

1. Horsfield K, Cumming G: Morphology of the bronchial tree in man: J Appl Physiol 24:373-383, 1968 *In: Textbook of Respiratory medicine, 3rd Ed, Vol 1: Murray, Nadal, Mason, Boushey*
2. The Larynx, 2nd Edition. Tucker HM.Thieme 1993
3. Proctor DF: The upper airways III; The larynx and trachea. American review of respiratory disease 1977;115: 315-342
4. Ochs M, Nyengaard JR, Jung A, et al. The number of alveoli in the human lung. Am J Respir Crit Care Med 2004; 169: 120-124
5. Weibel ER: Morphometry of the Human Lung. New York: Academica Press, 1963 *In: Respiratory Physiology- the essentials 5th edition, J.B.West*
6. Horsfield K. Diameters, generations, and orders of branches in the bronchial tree. J.Appl.Physiol 1990; 68: 457-461
7. West JB, Mathieu O. Structure, strength, failure, and remodelling of the pulmonary blood-gas barrier. Annual review of physiology 1999; 61: 543-572

8. Weibel ER. Functional morphology of lung parenchyma, *In: Handbook of Physiology, mechanics of breathing, Part 1, section 3, Macklem PT, Mead J.*

FIGURES

1. McGraw-Hill Companies.Inc illustration
2. Life Art -Lippincott Williams and Wilkins, Balitmore,MD
3. Respiratory Anatomy and Physiology textbook C.V.Mosby Company (page 123)
4. Mechanics of breathing illustrations www.lib.mcg.edu
5. Respiratory anatomy and physiology textbook C.V.Mosby Company (page 48)
6. Mechanics of breathing website tutorial www.lib.mcg.edu

CHAPTER 3 THE MECHANICS OF BREATHING

3.1 INTRODUCTION

Air in its journey from atmosphere to alveoli will experience an opposition to flow due to frictional resistance. The amount of resistance will depend on the linear velocity of the airflow which will in turn be affected by the airflow pattern and its location within the bronchial tree¹. The nature and site of this resistance and the behaviour of airflow when it encounters the resistance gives an insight into how airways disease can have significant effects on lung function. The use of the forced expiratory volume at six seconds (FEV₆) to determine airways obstruction accurately and reproducibly through spirometry testing is a key focus of this thesis and so this chapter will concentrate on the physiology behind the flow volume curve generated during a spirometry measurement.

The first section of this chapter serves to introduce the concepts of airways resistance (RAW), the pattern of airflow, and the site of resistance. The second section will concentrate on the physics of airflow within the branches of the respiratory system. The final section details the physiology behind the spirometry manoeuvre and introduces the concept of airways obstruction from a physiological viewpoint. Tests of forced expiration reflect the mechanical workings of the lung. The physiological factors that determine maximal expiratory flow include the elastic properties of the lung, airways resistance and dynamic compression of the airways². How these factors interact in healthy lungs provides the basis for understanding how disease affects lung function, allowing a better understanding of patterns of dysfunction that spirometry testing reveal.

3.2 AIRFLOW PATTERNS

There are three main patterns of airflow that exist in the bronchial tree, laminar, turbulent, and transitional. Laminar flow is smooth, parallel airflow and can be found in smaller airways where the rate of airflow is slow. Turbulent flow as its name suggests, is a flow pattern that may be forward flow but unlike laminar flow it is non-parallel and non-linear. Turbulent flow occurs mainly in the large airways. The mixture of these two flow patterns, referred to as transitional flow, is most likely to exist at airway branch points. Figure 3.1 shows the various airflow patterns which occur within the human airways.

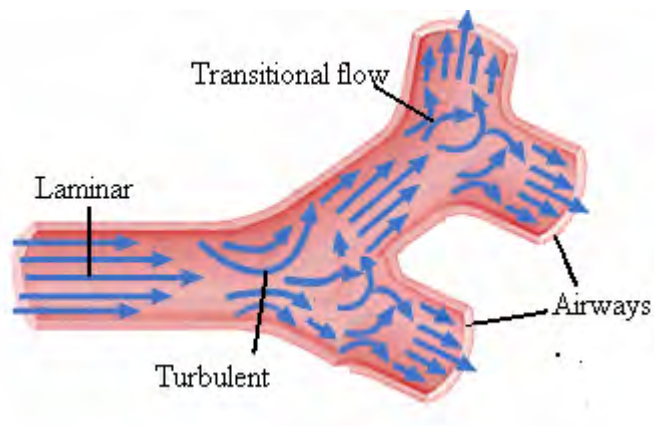

FIGURE 3.1 AIRFLOW PATTERNS¹

3.3 PHYSICS OF AIRFLOW

In order to understand the nature and contribution of frictional resistance encountered by air as it makes its way from atmosphere to alveoli, two relationships are used, the analogy to Ohm's law and Poiseuille's equation. The airways are analogous to an open tube, and as seen in figure 3.2 airflow occurs when there is a pressure difference between both ends of the tube P1 and P2.

Ohm's law for an electric circuit states that current is equal to voltage divided by resistance, and the equation reads:

$$I = V/R \quad \text{Equation 3.1}$$

where V = Voltage, I = Current and R = Resistance.

Applying by analogy, Ohm's law to conditions existing in the airways, the equation can be rearranged as follows $R = V/I$, and the airways resistance RAW then becomes:

$$RAW = \Delta P/V \quad \text{Equation 3.2}$$

where $\Delta P = P_1 - P_2$, the difference in pressure from P_1 to P_2 .

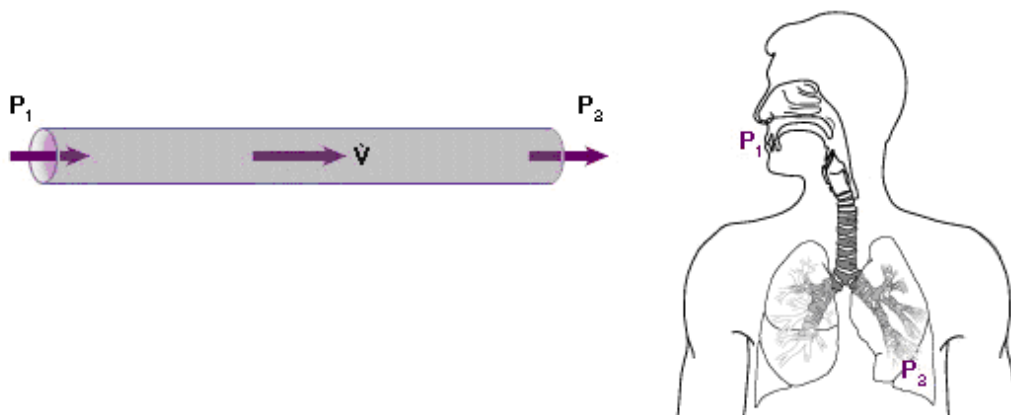

FIGURE 3.2 AIR FLOW IN THE HUMAN AIRWAYS UNDER PRESSURE DIFFERENCE¹

The resistance RAW to airflow is obtained by dividing the pressure difference in the airway by the airflow rate V. Two variables considered in Ohm's law are pressure and flow rate. Building on this a French physicist, Poiseuille, developed an equation to describe airways resistance through a tube in terms of the physical dimensions of the tube and the nature of the fluid moving through it (Figure 3.3) thus,

$$RAW = 8\eta l / \pi r^4 \quad \text{Equation 3.3}$$

where r = radius of tube , η = viscosity of flowing substance, l = length of tube,

$\pi = 3.14$

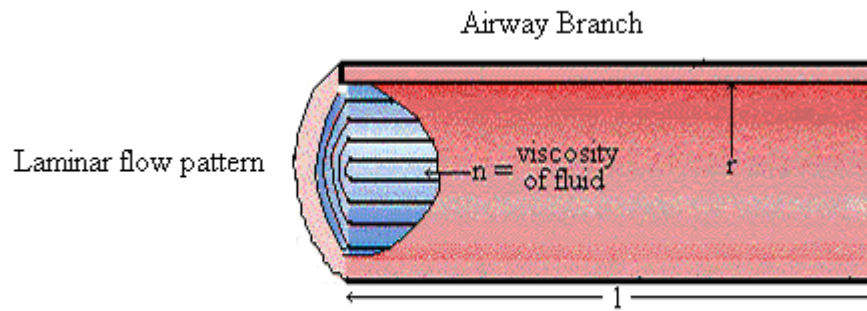

FIGURE 3.3 ILLUSTRATION OF POISEUILLE’S DESCRIPTION OF LAMINAR AIRFLOW APPLIED TO THE HUMAN AIRWAYS¹

Poiseuille’s equation states that the frictional resistance to flow is directly related to viscosity of the air and the length of the tube and indirectly related to the fourth power of the tube radius. According to Poiseuille’s equation the radius of the tube is critical in determining the magnitude of airways resistance. If the radius of the tube is reduced by approximately 50% with no change to either tube length or the viscosity of the air flowing through it, the calculated resistance would increase by sixteen-fold, or the driving pressure would need to increase by sixteen-fold to maintain the same flow. However unlike Poiseuille’s equation, which was derived using rigid smooth tubes that encourage a laminar flow pattern, the human airways are distensible and have continuously branching tubes of various radii, where both laminar and turbulent flow co-exist. The transition from laminar to turbulent flow can be indicated by a number called the Reynolds’ number.

$$\text{Reynolds' number} = \rho v d / \eta \qquad \text{Equation 3.4}$$

where ρ = density of fluid, v = linear velocity, $2r$ = diameter of tube, η = viscosity of fluid

The size of the Reynolds' number will to a large extent determine whether flow in a particular branch will be laminar or turbulent. Turbulence occurs when the Reynolds' number is very large, something in the magnitude of 2000, when the velocity of flow is high and the tube diameter is large, for example at the trachea. In the smallest of branches, the terminal bronchioles, Reynolds' number is approximately 1 and this dictates that the type of airflow there will be laminar. For the majority of the bronchial tree, flow is transitional moving from areas of turbulence to areas of laminar flow³.

3.4 SITE OF AIRWAYS RESISTANCE (RAW)

The nature and site of airways resistance is important in understanding the mechanism behind lung disease as resistance to airflow is likely to be increased in certain lung diseases⁴. As the bronchial tree subdivides and its branches become smaller and more numerous, the diameter of the terminal bronchioles are many times smaller than the diameter of the bronchi. As mentioned in chapter 2, section 2.2.4, each set of airway branchings gives rise to a new generation resulting in twenty-three generations in total. The fourth and eight order of branching include the medium sized bronchi. The eight to twelfth generations include the bronchioles and generation sixteen onwards include the terminal bronchioles. Figure 3.4(A) shows the position of airways resistance in relation to the order of generation of branches in the bronchial tree and Figure 3.4 (B) shows the relationship of linear velocity and cross sectional area through each generation of branching.

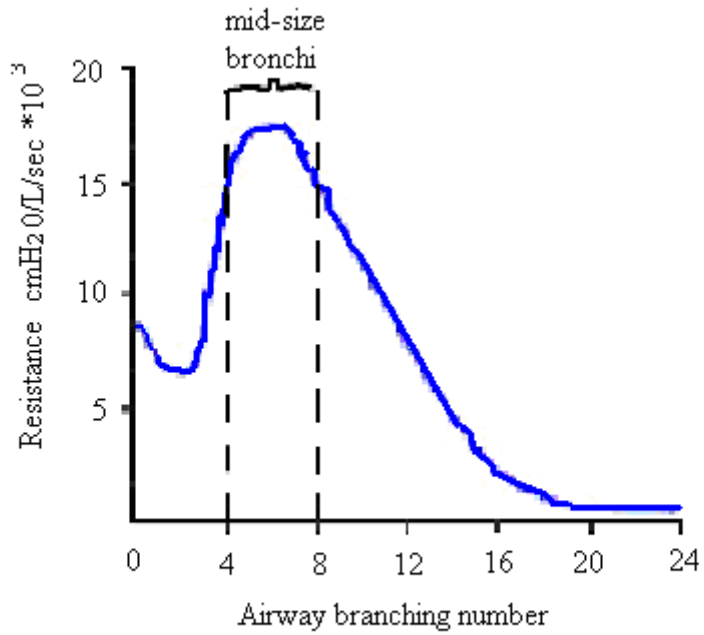

FIGURE 3.4 (A) SITE OF AIRWAYS RESISTANCE IN THE BRONCHIAL TREE²

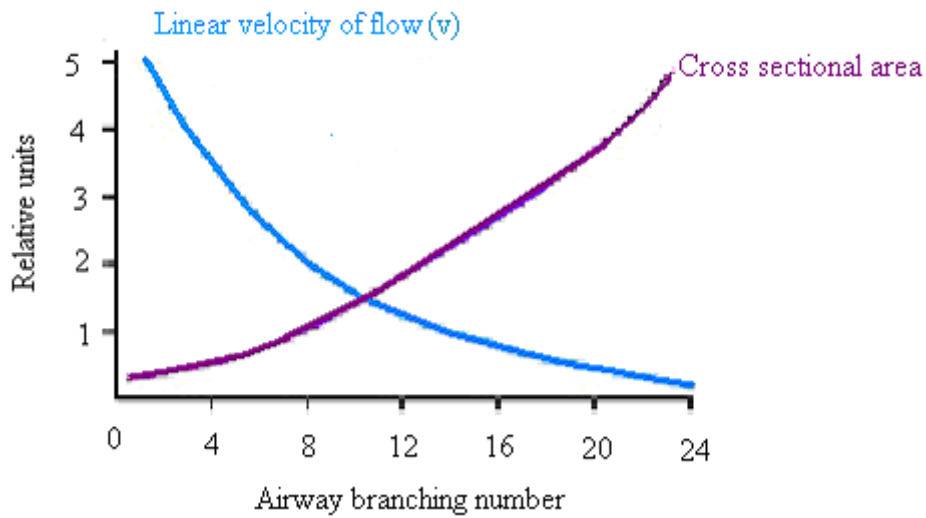

FIGURE 3.4 (B) RELATIONSHIP OF LINEAR VELOCITY AND CROSS SECTIONAL AREA IN THE BRONCHIAL TREE²

According to Poiseuille's equation (equation 3.3) the major site of airways resistance should be in the location of the smallest airways with their small radii at generation sixteen onwards. However, studies have shown this is not the case, but rather the medium size airways have the greatest airways resistance⁵. Small airways (< 2 mm in diameter) have the potential for greater airways resistance; however small airways branch repeatedly and in doing so create a large cross sectional area for airflow. This large cross sectional area dictates that flow in the small airways is slower and is laminar. An analogy to electrical resistors can also be used to describe the behaviour of airways resistance in the small airways. Like resistors in an electrical circuit, airways through the generations of branching from the trachea to the bronchi to the bronchioles can be described as being in series. Resistances in series are added to give the total resistance (R_{tot}).

$$\mathbf{R_{tot} = R_1 + R_2 + \dots + R_n} \qquad \mathbf{Equation \quad 3.5}$$

The total resistance of a given generation is greater in airways that exceed 2 mm (figure 3.4). When all the resistances of a generation are added together, the overall resistance of that generation decreases, this occurs because these resistances are in parallel and the total resistance is obtained from the inverse of the sum of the reciprocal of each resistance

$$\mathbf{R_{TOT} = 1/ 1/R_1 + 1/R_2 + \dots + 1/R_n} \qquad \mathbf{Equation \quad 3.6}$$

$$\mathbf{1/R_{TOT} = 1/R_1 + 1/R_2 + \dots + 1/R_n}$$

The resistances arranged in parallel can be added as reciprocals of their individual resistances therefore yielding a far less total RAW. This arrangement negates the effect of a reduced diameter on the resistance. The first studies conducted to determine the site of airways resistance was performed on dogs and later on humans using a catheter inserted into the lungs in an attempt to bypass the large airways.

These studies proved that small airways resistance was only a minor contributor to overall resistance⁶. As the small airways have little resistance, airways disease can go unnoticed for many years and this area is referred to as the 'silent zone' of early airways disease.

3.5 FORCED EXPIRATORY MANOEUVRE

Expiration in normal breathing conditions is a passive process but when air is physically expelled from the lungs the airways become compressed and close. This compression is a natural phenomenon occurring only at very low lung volumes in young healthy subjects. However disease of the respiratory system can cause this compression to be exaggerated and to occur earlier in the forced expiration than would naturally occur in healthy airways. This early compression is also apparent in the lungs of healthy elderly subjects mainly due to the loss of elastic recoil that accompanies the natural ageing process of the lungs⁷. The site and nature of airway compression can be measured indirectly by performing a breathing manoeuvre called a forced expiratory test on equipment known as a spirometer. The spirometer produces a graph called a flow volume curve which provides visual evidence of the airway compression.

Spirometry testing requires a subject to inspire to a maximum volume called total lung capacity (TLC) and then blow out very fast into a spirometer until a minimum volume is reached called the residual volume. By 'blasting' the air out of the lungs a force is applied to the thoracic cavity and lungs causing the pressure in the alveoli (P_{alv}) to increase well above atmospheric pressure (P_{atm}), which results in air leaving the lungs. Figure 3.5 depicts a typical flow volume curve produced from a forced expiratory manoeuvre.

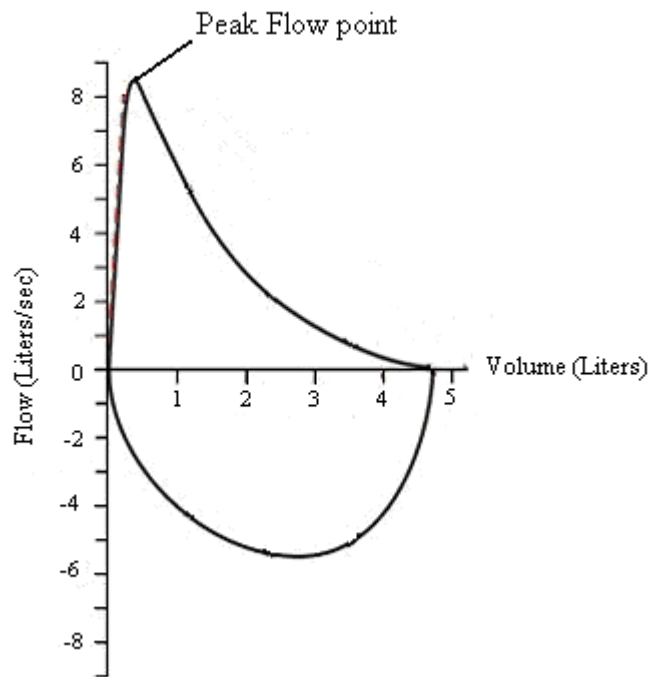

FIGURE 3.5 FLOW VOLUME CURVE ON NON-DISEASED AIRWAYS³

Flow begins at zero and rises rapidly to a peak flow point, the curve declines over most of the expiration as air is forced from large to medium to small airways until reaching a zero volume. The shape of a flow volume curve is very reproducible for non-diseased lungs but can be altered by airways disease in characteristic ways. This is due to a mechanism known as dynamic airway compression or flow limitation.

The site and extent at which flow limitation occurs will ultimately determine the shape of the flow volume curve. Section 3.7 will introduce the physiology behind the mechanism of flow limitation and provide a brief summary of some of the theories used to explain flow limitation.

3.6 DYNAMIC AIRWAY COMPRESSION/ FLOW LIMITATION

Dynamic airway compression as its name suggests describes what happens to the airways as air is physically forced out of the lungs with speed. The way in which the airways respond to this dynamic compression is different in health and disease. Spirometry testing has made it possible to understand the mechanical events that limit maximal exhalation, and to locate with the aid of flow volume curves the location of this dynamic compression.

In the build up to a forced expiration, a maximum breath is inhaled to TLC and in doing so the ribcage is expanded allowing the lung to hold this maximum volume, and as the lungs are now stretched the pleural pressure is at its maximum. The initial burst of air, called the peak flow point is effort-dependent and produced entirely by expiratory muscle force. Beyond the peak flow point the expiratory muscles fail to play a significant role and elastic recoil takes over to maintain the expiratory flow. The change from effort-dependent to effort-independent flow and the pressures that drive the flow at this point is called flow limitation. There are three theories used to explain flow limitation, the equal pressure point by Mead et al.⁸, the waterfall theory by Pride et al.⁹ and the wave speed theory of flow limitation by Dawson et al.¹⁰. A detailed description of the equal pressure point followed by a brief summary of the waterfall and wave speed theories of flow limitation follows.

As described in chapter 2 section 2.3.1, the normal breathing cycle is brought about by changes in pressure gradients. Pressure gradients behave differently when air is forced at speed from the airways and the following sections will describe this process.

3.6.1 TIDAL BREATHING

Tidal breathing is the pattern of breathing performed unconsciously at rest. On average a subject will inhale approximately 500ml of air with each tidal breath and exhale the same amount. Before inspiration begins the respiratory muscles are at rest and the elastic recoil of the lung (P_{el}) and the elastic recoil of the chest are equal but opposite and the pressure inside the alveoli (P_{alv}) is at the same pressure as the atmosphere (P_{atm}). As mentioned in chapter 2, section 2.3.1, a pressure gradient needs to exist before air can flow, and air will only flow from an area of higher pressure to one of lower pressure and since $P_{alv} = P_{atm}$ there is no airflow. During inspiration the diaphragm contracts and in doing so compresses the abdominal contents and decompresses the contents of the thorax causing the pleural pressure to fall. As P_{pl} falls, P_{alv} falls by an equal amount becoming sub atmospheric and creating a pressure gradient. Air flows into the lungs down the pressure gradient from mouth to alveoli. The lungs and chest expand in volume, and this causes the recoil pressure of the lung to increase until a new equilibrium is reached. Equilibrium exists after inspiration and before expiration begins. Air flows down the pressure gradient until the lung reaches a new equilibrium volume at which P_{alv} equals zero and the gradient for flow ceases to exist. Lung and chest wall are fully expanded.

During expiration the respiratory muscles relax, allowing the lung to recoil causing an abrupt increase in P_{pl} to a less negative value. Additional air in the lungs causes the P_{alv} to rise above P_{atm} and air flows out of the lungs. Lung volume and chest wall dimension decrease as air flows out causing lung recoil pressure to fall until a new equilibrium is reached. At end expiration, the pleural cavity and the alveoli return to the pressure relationship they had at the start of inspiration.

3.6.2 FORCED BREATHING

As detailed in Chapter 2, the lungs are elastic structures and they have an inbuilt tendency to want to recoil, like a spring, a tendency called the elastic recoil pressure of the lung (P_{el}). In the build-up to a forced expiratory manoeuvre, a deep breath is taken into the lungs and they stretch, and as the lungs stretch, they have an even greater tendency to want to spring back into the resting position. In order to overcome this tendency and expand the lungs to their maximum, a pressure known as the transpulmonary pressure ($P_{L_{el}}$) needs to be increased. The transpulmonary pressure is the pressure difference across the lungs. At the start of a forced expiration P_{pl} rises very steeply as the expiratory muscles contract and the lung volume decreases. The P_{alv} increases and forced expiratory flow begins. At this point a pressure gradient exists from mouth to alveoli, and as flow occurs the pressure inside the airway becomes less than the pressure outside the airway. The pressure falls steadily going from the alveoli where it is high, falling steadily through the bronchi (P_{br}) to the level of the mouth (P_{mo}) and out into atmosphere (P_{atm}). This pressure fall occurs because of the fall in resistance that is greater towards the trachea where the number of parallel airways decreases. In addition, the gas velocity increases towards the trachea, as the cross sectional area of the airways decreases. As this exhalation continues, lung volume decreases, causing a fall in the static recoil pressure which reduces the transpulmonary pressure. Somewhere along the airway, the transmural pressure will become negative, as P_{pl} will exceed the airway pressure, resulting in compression of the airways.

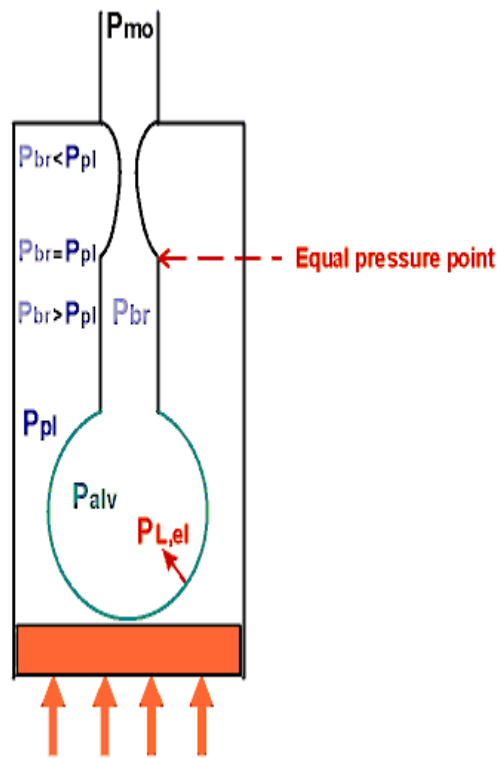

FIGURE 3.6 CONDITIONS EXISTING IN THE RESPIRATORY SYSTEM DURING FORCED EXPIRATION⁴

3.6.3 EQUAL PRESSURE POINT THEORY

By exhaling a full breath of air with maximal force, through a tube, as in a spirometry test, a large force is applied to the thoracic cavity, causing both pleural pressure (P_{pl}) and alveolar pressure (P_{alv}) to increase well above atmospheric pressure. Then as flow begins the pressure along the airways from the alveoli to the mouth drops and the airways tend to compress and limit flow. Once the expiratory flow becomes limited, the airways at the alveoli are distended whereas the airways at the trachea are compressed.

This led investigators to believe that there must be points between the trachea and the alveoli where airways are neither compressed nor distended. Such points were then called equal pressure points (EPP), where the pressure inside the airway had to be equal to the pressure outside the airway. The airways could be then looked upon as two separate segments, a distended segment and a compressed segment. At the EPP the limiting flow becomes the pressure outside the airway called the intrapleural pressure or

the elastic recoil pressure (P_{el}). This pressure is the driving pressure, and if a subject tries to physically force the breath out at the end of expiration by using respiratory muscles to increase intrapleural pressure further, this will have absolutely no effect on the driving pressure, making flow independent of effort. The maximum flow expelled however will decrease with decreasing lung volumes, because the difference between alveolar and intrapleural pressure decreases as the airways narrow up to the EPP. As the lungs empty the EPP moves into increasingly smaller airways and continues on until the airways close, trapping some gas in the alveoli at a point known as the residual volume of the lung.

This expiratory mechanism is called dynamic airway compression and is what gives the characteristic linear or slightly concave shape to the maximum expiratory curve on the spirometer tracing. The curve has a maximum flow/volume envelope that is remarkably consistent even with variable expiratory efforts. Figure 3.7 shows a forced expiratory tracing performed with various efforts and at various starting volumes.

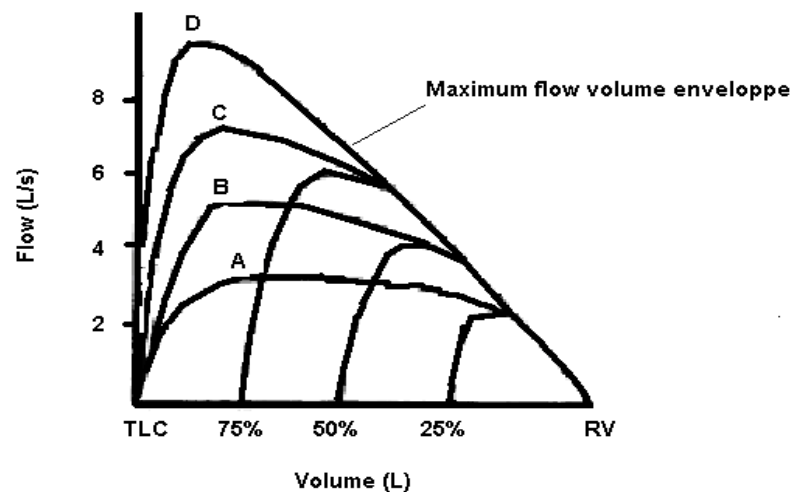

FIGURE 3.7 MAXIMUM EXPIRATORY EFFORT CURVES WITH VARIABLE SUBJECT EFFORT (A,B,C,D)⁵

When the maximum flow volume envelope is reached the decline in expiratory flow as the lung empties will always follow the same pathway regardless of the starting volume or effort. For each point of the curve, a maximum flow cannot be exceeded regardless of the effort exerted.

3.6.4 WATERFALL THEORY

Following from the equal pressure point theory, and in an effort to explain flow limitation researchers modelled the lung as a resistance between the alveoli and a point downstream from the EPP where transmural pressure reached a critical value that was enough to limit flow. This is analogous to a waterfall, where flow is independent of the height of the falls, just as maximal expiratory flow limitation is independent of the total driving pressure between alveoli and mouth.⁹

3.6.5 WAVE SPEED THEORY

Dawson and Elliott¹⁰ showed that maximal expiratory flow occurs when the linear velocity of gas at the flow limiting segments, which they termed choke points, becomes equal to the speed at which a pressure wave travels along the airways to the alveoli. This high linear velocity prevents transmission of downstream pressure through choke points, so that flow becomes independent of pressure.

3.7 OBSTRUCTIVE VENTILATORY PATTERN

Spirometry testing can reveal patterns in the form of numerical values and flow volume curves that are typical of specific lung diseases. These patterns are used to make judgements in clinical practice on the site and nature of the disease process within the lung in conjunction with other clinical data. Airways disease can be broadly divided into two main groups by the nature of their structural impairment termed obstructive and restrictive ventilatory disorders. Obstructive disorders as their name suggests, 'obstruct' the flow of air out of the lungs causing an increase in airway resistance, and included asthma, chronic bronchitis, emphysema and chronic obstructive pulmonary disease (COPD). Restrictive lung disorders can affect the bellows action of the lungs and chest wall by 'restricting' the process of inflation. Restrictive diseases include thoracic wall deformity and pulmonary fibrosis. An obstructive ventilatory airflow pattern typical of a subject with COPD produces a flow volume curve as shown in figure 3.8. A normal curve is superimposed for comparison. In obstructive airways disease the airway walls lose tension and become flaccid. During a forced expiratory manoeuvre, the airways collapse and the equal pressure point occurs nearer the alveoli than in healthy subjects producing a curve that has a 'scooped' out appearance. Obstructive diseases are also likely to cause an increased resistance in the smaller airways and an elastic recoil pressure occurring closer to the alveoli, which leads to greater compression and greater airflow limitation¹¹.

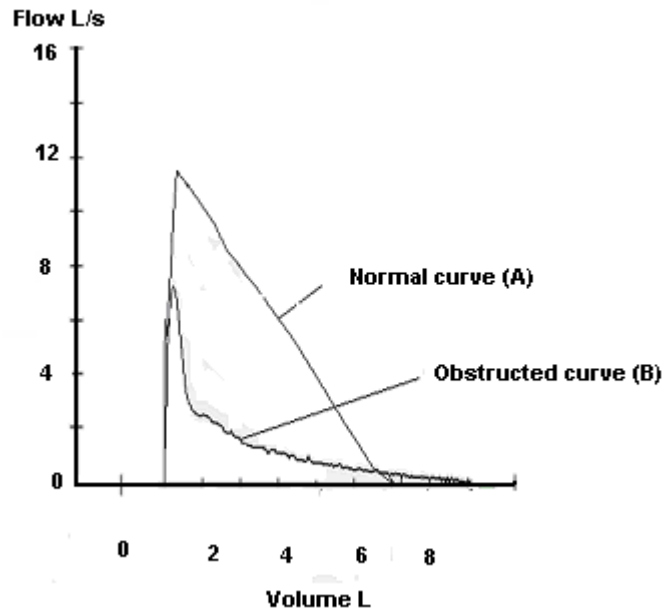

FIGURE 3.8 FLOW VOLUME CURVE OF (A) SUBJECT WITH NO AIRWAYS DISEASE AND (B) SUBJECT WITH SEVERE AIRWAYS DISEASE⁶

3.8 SUMMARY

This chapter outlined the mechanics of airflow. Sections on the physiology of the forced expiratory manoeuvre and a brief description of dynamic airway compression serve to introduce an understanding of the differences that exist between obstructed and normal airflow in terms of the site of airways resistance. The next chapter will deal with the parameters measured from a spirometry test.

3.9 REFERENCES

1. Martin DE, and Youtsey JW. Human Anatomy and Physiology. The C.V. Mosby Company. Missouri 1988
2. Murray JF, Nadel JA. Textbook of Respiratory Medicine. 3rd Edition. Volume one WB Saunders Company. London 2000
3. Weibel ER. Design and morphometry of the pulmonary gas exchanger. The Lung: Scientific Foundations. New York, Raven Press. 1991.
4. West JB. Respiratory Physiology-the essentials. 5th Edition. Williams and Wilkinson 1995.
5. Hogg JC, Macklem PT, Thurlbeck WM. Site and nature of airways obstruction in COPD. N.Engl.J.Med 1968; 278: 1355-60
6. In: Macklem PT. A century of Mechanics of Breathing. Am J Respir Crit Care Med 2004; 170: 10-15
7. Babb TG, Rodarte JR. Mechanism of reduced expiratory flow with ageing. J Appl Physiol 2000; 89:505-511

8. Mead J, Turner JM, Macklem PT, Little JB. Significance of the relationship between lung recoil and maximum expiratory flow. *J Appl Physiol* 1967, 22: 95-108
9. Pride NB, Permutt S, Riley RL, et al. Determinants of maximum expiratory flow from the lungs. *J.Appl.Physiol* 1967; 23: 646-662
10. Dawson SV, Elliott EA. Wave-speed limitation on expiratory flow –a unifying concept. *J.Appl.Physiol* 1977; 43: 498-515
11. Leaver DG, Tattersfield AE, Pride, NB. Contributions of loss of lung recoil and of enhanced airways collapsibility to the airways obstruction of chronic bronchitis and emphysema. *J Clin Invest* 1973; 52 :2117-2128

FIGURES

1. Mechanics of breathing www.lib.mcg.edu
2. John Hopkins School of Medicine, Interactive Respiratory Physiology
3. Vmax software tutorial section version 5A Sensor medics, Viaysis Inc
4. www.spirxpert.com
5. Anatomy and physiology the essentials. West J
6. Vmax Pulmonary Function database version 5A, Sensor Medics , Viaysis

CHAPTER 4. SPIROMETRIC PARAMETERS AND FLOW VOLUME CURVES

4.1 INTRODUCTION

The way in which the lungs behave mechanically differs in health and disease and depending on the site and nature of the disease this difference can significantly affect the lungs ability to perform its main function of gas exchange. An understanding of the volume and flow rates of the lung is necessary in order to assess the degree of lung impairment. Often in individuals with suspected lung disease, spirometry is the first test used in the investigation stage. The values generated from a spirometry test provide graphic and numeric information, which depict and describe the mechanical properties of the lung, chest wall and respiratory muscles. Although the breathing manoeuvre required for spirometry is far removed from a normal breathing pattern, the results and graphs created are very reproducible for a given person, and can show characteristic patterns of dysfunction in lung disease when present. Interpretation of spirometry results involves comparison of measured values with 'normal' reference values generated from a population of healthy individuals matched for age, height, gender and ethnicity.

The equipment necessary to carry out this test is called a spirometer. Spirometers come in various formats. Small portable stand-alone versions are commonly used in clinics whereas more complex devices tend to be found in specialised hospital-based lung function equipment. This chapter will focus on the parameters and tracings produced from a spirometry test, and how these values are interpreted. Section 4.2 will cover the evolution of the spirometry measurement. Section 4.3 details spirometer devices the principles behind the measurement and quality control

in the measurements. A section describing how a spirometry measurement is performed followed by a section on the various parameters and tracings associated with spirometry testing. The interpretation of spirometry results and a section on reference values are covered in the final section of this chapter.

4.2 THE EVOLUTION OF SPIROMETRY MEASUREMENTS

In 1846 an English surgeon John Hutchinson published in the *Lancet* journal the first study of its kind documenting, measuring and advocating the importance of the physiological measurement of lung function. Hutchinson invented a calibrated bell, inverted in water, in order to be able to measure the volume of exhaled air from fully inflated lungs. This measurement he called the vital capacity (VC), meaning the capacity to live, as he realised that compromise of vital capacity was predictive of premature death. Hutchinson's studies showed that vital capacity in normal healthy subjects was directly related to standing height, and inversely related to the age of the individual. He also observed that vital capacity became mildly reduced following a large meal. In his first article published in 1846, he reported on the measurement on 2,130 individuals, including deceased patients. Hutchinson would go to the morgue immediately following death and insert into the trachea the equivalent of an endotracheal tube with a stopcock, and inflate the corpse with a bellows until no more air could enter. He then released the flow of air into his spirometer, observing that the lungs and thorax emptied under elastic recoil to a minimum volume called the residual volume. Hutchinson became a consultant to the insurance industry of London, advocating the need for spirometry measurements of vital capacity to be used in actuarial predictions for life insurance brokers. However, Hutchinson's spirometer was not widely accepted in London and at the age of 41 he emigrated to Melbourne, Australia where all further use of the spirometer was abandoned. Hutchinson spent his

final years on the island of Fiji, where a statue was erected in his memory by the Thoracic Society of Australia and the British Thoracic Association in 1990^{1,2,3,4,5,6}

Position of the body in filling the chest before breathing into the Spirometer.



FIGURE 4.1 SILHOUTTE OF JOHN HUTCHINSON AND HIS SPIROMETER¹

Hutchinson's research introduced to the world the first water-sealed type of spirometer which some aspects are still evident in today's devices. It was not until the 1940s that the concept of measuring the rate of volume exhaled was introduced, born from the observation that individuals with asthma, emphysema, chronic bronchitis and other such obstructive ventilatory disorders, exhaled at a slower rate than healthy individuals. The forced expiratory volume (FEV) was first described by Tiffeneau and Pinelli⁷ working in Paris, in December 1947, more than 100 years after the first measurement of lung function was made by Hutchinson. In those 100 years, spirometry had been considered an important tool but could not be utilised fully, mainly because the technology was not sufficiently sensitive to measure instantaneous flow. A more precise evaluation of the

dynamic behaviour of the lungs only became possible after the description of the pneumotachograph by Fleisch⁸ in 1925.

Soon afterwards, Engelmann¹⁰ noticed that asthma was characterised by a marked prolongation of the expiratory phase, and after epinephrine was administered to the patient, a normal expiratory phase was observed. Hermannsen¹¹ was the first to record the maximal ventilatory possibilities during a sustained voluntary effort in 1933, after this several investigators started to relate the sensation of dyspnoea to the maximum breathing capacity (MBC). A study published in 1938 by Barrack¹² computed the expiratory and inspiratory flow, and expressed them in cubic centimetres per second. This concept gave a greater insight into the patency of the airways and equipped the spirometer with a rotating drum, where volume changes could be recorded as a function of time. Gambits¹³ also in 1938 realized that the level of maximum breathing capacity MBC is determined by the size of the vital capacity (VC). He proposed to use the ratio $MBC (l/min) / VC (l)$, subsequently called the capacity ratio, and nowadays referred to the FEV_1/VC ratio. Courante et al.¹⁴ observed a striking decrease in the rate of expiration in patients diagnosed with emphysema.

Other studies at this time showed that the time necessary for a full maximal expiration was markedly different for normal subjects compared to patients with obstructive ventilatory diseases, for whom forced expiratory times were prolonged. Cara et al.¹⁵ specified that a subject must breathe out as quickly, strongly, and completely as possible, during a forced expiratory manoeuvre, and that correction factors for barometric pressure and temperature must be considered and applied to the measurement for accurate and reliable recordings to be made. Tiffeneau's group¹⁶ made several more important observations which are still largely valid today; they had noticed that during exercise both the circulating air or tidal volume and the respiratory frequency tend to increase. They proposed to measure the maximal volume that can be

expired in a space of time corresponding to the usual duration of an expiratory phase during exercise. They called this measurement the “*capacitē pulmonaire utilisable a l’effort*” (CPUE). The CPUE was proposed to be equal to the largest volume that can be expired in one second. This is now known as the forced expiratory volume in one second FEV₁.

Despite these observations and studies, the contribution of these French investigators remained largely ignored. A group of respiratory investigators in the US met in April 1950 to standardise the definitions and symbols used in respiratory physiology. In the US, at this time, it was Gaensler’s work¹⁷ on the analysis of the forced expiratory volume that was fast becoming accepted. Gaensler’s adaptation of the water-sealed spirometer using a micro switch to time the forced expiratory breath, meant that for the first time airway obstruction could be assessed. He proposed to calculate air velocity index (AVI) and made measurements in 435 patients. In 23 normal patients he found an AVI above 1, and similar results after a lobectomy. However in 36 asthmatics the AVI was reduced. He also noted that the slope of the expiratory tracings was very steep during the first seconds, and that an accurate measurement of the volume of air could not be made. He adapted the spirometer to introduce a time element, and thus the timed VC was born.

Gaensler’s studies concluded that a healthy individual could exhale approximately 80% of their capacity in the first second of a forced expiratory blow. Any forced expiratory measurement falling short of this critical measurement could be interpreted as indicating the presence of airways obstruction.

The timed VC then started to gain more popularity over the MBC. Fowler et al.¹⁸ provided evidence that there was no initial period of sustained constant flow rate, except occasionally in normal persons during somewhat sub-maximal effort.

The acceleration of the airflow during the first several tenths of a second was, in fact, so large that an accurate recording of this portion of the trace with a spirometer was considered uncertain. Therefore, they advocated measurement of the average flow over the middle of a rapid maximal expiration: the maximal mid-expiratory flow rate was born. They demonstrated a graphical method to assess airway obstruction, and were the first to measure and document the parameter $FEF_{25-75\%}$ that is the mid section of the forced expiratory tracing. This and other parameters were used with more confidence to differentiate healthy airflow from obstructed airflow. Ten years after his first work on the subject, Tiffeneau published his monograph summarising all his work on the VEMS, the “volume expiratoire maximum seconde”, the term that superseded the CPUE ¹⁹. The British Thoracic Society adopted recommendations on terminology for measurements of ventilatory capacity they replaced the term ‘timed VC’ with the expression we know today as the ‘forced expiratory volume over a stated interval of time’ and hence the FEV_1 and FEV_3 and FEV_6 . The nomenclature accepted today is the VEMS in French and the FEV_1 in English. After over 50 years, the VEMS and the FEV_1 have become used daily by respiratory physiologists and physicians to measure and document respiratory disease.

4.3 SPIROMETER DEVICES

4.3.1 INTRODUCTION

Spirometer devices are specifically designed to collect measure and display exhaled flow and volume. There are two types of spirometer, volume displacement and flow sensing. In a volume displacement spirometer exhaled volume is the primary signal and flow is obtained from differentiation of volume with respect to time. A flow sensing spirometer will measure flow directly and then integrate this signal to obtain a volume measurement. Regardless of the type of spirometer used it must conform to a set of specific standards as recommended by the joint working parties of the European Respiratory Society (ERS) and the American Thoracic Society (ATS)³ (Appendix A).

Conformity of equipment has led to a major reduction in the measurement variability that was previously witnessed between spirometers, but the requirement for accurate and reproducible measurements is still the responsibility of the individual providing the spirometry service¹⁶. Maintaining high standards of accuracy require that a robust quality control (QC) system is in place. Instrument quality control involves two related procedures called calibration and quality control-checks. Calibration is the procedure for establishing the relationship between spirometer-determined values of flow and volume and actual flow and volume. A quality control check is the procedure used to validate that the spirometer is within its calibration limits.

The modern spirometer is a lightweight portable medical device with a built-in microprocessor that can store and display many parameters, print tracings and even offer a computerised interpretation based on algorithms. Despite the many advances in medical technology, the underlying principle and the measurement of spirometry stay true to the original volume displacement spirometer introduced to the world by

Hutchinson more than a century ago. The type of spirometer used to produce the results in this research thesis is a flow-sensing anemometer type known as a mass flow sensor.

4.3.2 MASS FLOW SENSOR

The mass flow sensor is an application of an anemometer. The function of this device is based on King's law of energy loss from a heated wire⁴. As can be seen in figure 4.1 the mass flow sensor contains two metallic filaments situated in a tube that is tapered to encourage laminar flow. One filament wire is for sensing and the other operates as a reference. The reference filament tracks the temperature of the airflow passing by it. The sensing filament is maintained at a preset temperature approximately 50°C above the temperature of the reference. When a patient breathes into the mass flow sensor the gas in the exhaled breath cools the sensing filament.

To maintain the sensing filament at the same offset temperature more power is required to be delivered to it through an electrical circuit. The quantity of current delivered to maintain the temperature is proportional to flow. This flow signal is then integrated to obtain volume. The function of the circuit is to continually heat the sensing filament to a constant temperature above the reference filament and therefore above the gas temperature. To enable this to happen, the circuit 'senses' the filament temperature by reading the filaments electrical resistance.

The amount of electrical current required to raise the filament temperature back to its designated temperature is known from the control circuitry. The current flows in one direction only and is driven on the inside pins (figure 4.2). The second set of pins reads the voltage drop. The voltage drop occurs when gas molecules remove heat from the sensing filament. This voltage drop is fed through a series of pins, cables and cable connectors back to the circuitry where it is read.

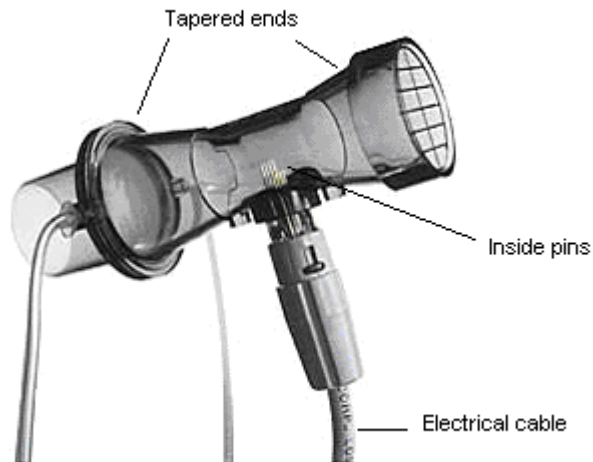

FIGURE 4.2 MASS FLOW SENSOR²

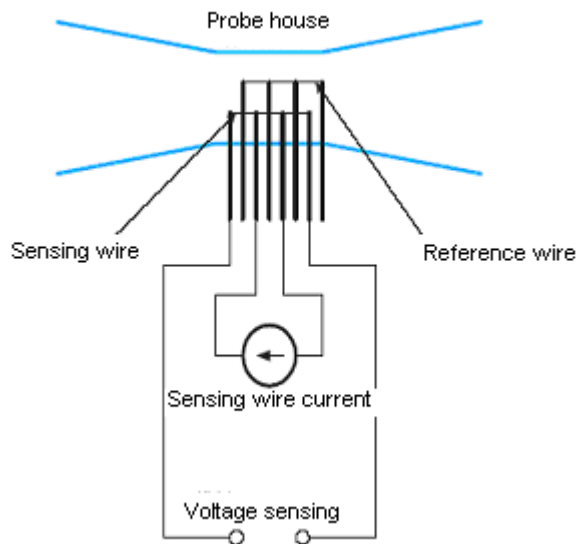

FIGURE 4.3 MASS FLOW SENSOR CIRCUITRY²

4.4 INDICATIONS FOR SPIROMETRY TESTING

Spirometry testing has the advantage of been non-invasive, well standardised, relatively short in duration with results available immediately post-test, and for these reasons it is indicated in a variety of clinical situations⁵ included in Table 4.1. As outlined in chapter 1, spirometry testing is gaining acceptance as an essential tool not only for quantifying the degree of lung impairment in COPD, but also as a screening tool for the detection of this disease in individuals at risk, such as smokers^{6,7}.

TABLE 4.1 INDICATIONS FOR SPIROMETRY TESTING

Diagnostic	<p>To evaluate signs and symptoms</p> <p>To measure the effect of disease on lung function</p> <p>To screen individuals at risk of having pulmonary disease and assess prognosis</p> <p>To assess pre-op risk</p> <p>To determine the degree of reversibility</p>
Monitoring	<p>To assess therapeutic intervention</p> <p>To describe the course of disease that affects lung function</p> <p>To monitor those exposed to agents known to be toxic to the lungs</p> <p>To monitor for drugs known to have pulmonary toxicity</p>
Disability/Impairment	<p>To assess patients as part of a rehabilitation programme</p> <p>To assess risk as part of an insurance evaluation</p>
Public Health	<p>Epidemiological surveys</p> <p>Derivation of reference equations and in clinical research.</p>

4.5 MEASUREMENT TECHNIQUE

Spirometry results depend largely on patient effort and understanding. The enthusiasm and attention to detail of the individual carrying out the test also plays an important role in obtaining accurate and reproducible measurements. In order to assure reproducibility between spirometry tests and also between test centres, guidelines on spirometry measurement have been published. Table 4.2 provides a summary of these guidelines⁸. Maintaining the comfort and safety of the subject during testing is as important as the technique itself. The first measurement made in a spirometry test, is the subject's standing height. Special attention must be given to this measurement as height together with gender and age are essential in acquiring the correct reference values used for interpretation of results. Interpretation and reference equations are covered in section 4.9. During a spirometry test, subjects are encouraged to remain seated upright throughout, as forced manoeuvres can cause prolonged interruption of venous return to the thorax causing a sudden dizziness referred to as syncope. Clothing around the chest and neck is loosened to allow for full chest expansion and a nose clip is used to ensure there are no air leaks during the manoeuvre. Every effort must be made at this preparation stage to ensure that the patient is comfortable. Patients are asked to sit straight with both feet on the ground. Tight clothing is loosened and water and tissues are made available. Spirometry begins with a maximum inhalation followed by a forced expiration that rapidly empties the lungs. Despite efforts to maintain patient comfort during a spirometry test the manoeuvre can prove to be a very uncomfortable experience for patients with airways disease and elderly patients, as the sustained long expiratory efforts required in the measurement can be tiresome.

The start of expiration must be swift, without any hesitation. The expiratory effort must continue for as long as possible or until a plateau in exhaled volume is reached signifying an 'end of test' criterion of < 25 ml over one second. There must be no

slowing down or malingering during the expiration as both have been shown to underestimate expired volume⁹. Maximum encouragement is given throughout the test, as sub-maximal efforts have been found to lead to spuriously high values¹⁰. An incorrectly inserted mouthpiece may lead to a sub-maximum effort therefore it is important that the patient has inserted the mouthpiece properly to ensure the expiratory volume is expelled smoothly and without obstruction by the tongue or false teeth. The patient is encouraged to rest between successive trials, as the technical acceptability of each manoeuvre is appraised. At least three forced manoeuvres of acceptable technical quality are required from any spirometry test session. Tables detailing technical acceptability and test reproducibility from forced expiratory manoeuvres can be found in appendix B. Table 4.2 outlines the procedure required to produce an accurate spirometry measurement.

TABLE 4.2 PROCEDURES FOR RECORDING A SPIROMETRY MEASUREMENT

1	Instruct and demonstrate the test to the subject, to include correct posture with head slightly elevated
2	Attach nose clip, place mouthpiece in mouth and close lips around the mouthpiece
3	Inhale completely and rapidly with a pause of <1 s at a full lung capacity
4	Exhale maximally until no more air can be expelled while maintaining an upright posture
5	Repeat instructions as necessary, coaching vigorously
6	Repeat for a minimum of three manoeuvres
7	Check test repeatability and perform more manoeuvres as necessary, no more than eight are usually required

4.6 MEASUREMENT VARIABILITY

To provide a spirometry result for interpretation that is an accurate reflection of an individual's lung function at the time of testing, involves an understanding not only of the limitations of the measurement but the factors that combine to make the measurement variable. A Combination of both technical and biological factors are responsible for most of the variability associated with spirometry. Technical factors can be controlled somewhat by following a quality assurance program that involves attention to calibration and instrument control checks.

Biological variability has been shown to be greater when spirometry measurements are made weeks and months apart and in subjects with respiratory disease^{11,12}. There are two types of biological variation, inter-individual (within-individual variation) and intra-individual (between-individual variation). An understanding of the role that both sources of variation play is important when it comes to interpreting a spirometry measurement. The primary source of inter-individual variation was found to be circadian rhythm, body and neck position and a sub-maximal spirometry effort, after accounting for short term variations caused by disease, drugs, smoking and instrument errors. Both host factors such as gender, height and age, and ethnicity and environmental factors such as the impact of tobacco smoke, general pollution and socioeconomic background all contribute as sources of intra-individual variation¹³.

In a large study carried out on quality control in spirometry testing in eight separate spirometry testing facilities¹⁴, findings demonstrated that more variability was attributable to using different operators than between identical spirometer devices. This study emphasises that training and a standardised procedure are equally important factors when it comes to reducing variability and improving the accuracy of a spirometry test.

4.7 SPIROMETRIC PARAMETERS

Breathing is a passive unconscious motion in non-diseased lungs. In a cycle of breathing approximately 500 ml of air are moved in and out of the lungs and this is called tidal volume (V_T). An excursion from this type of resting breathing will produce a volume, for example a full breath in to maximum capacity from a tidal breathing position is termed the inspiratory reserve volume. There are three distinct lung volumes and a combination of two or more volumes will produce a capacity. The measurements of lung volume and capacity are critical determinants of overall lung function. Figure 4.4 shows the position of each of volume and capacity of the human respiratory system. A definition of each lung volume and capacity can be found in appendix C.

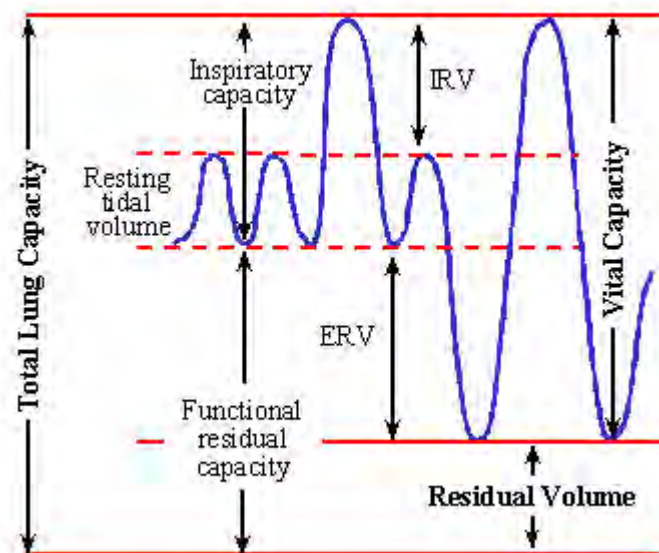

FIGURE 4.4 LUNG VOLUME AND CAPACITIES³

A single spirometry manoeuvre will produce an array of volume and capacity measurements. The most common spirometric parameters derived from a forced vital capacity manoeuvre are described below.

4.7.1 VITAL CAPACITY (VC) AND FORCED VITAL CAPACITY (FVC)

Vital Capacity (VC) is the maximum volume of air that can be exhaled (or inhaled) from a position of full inspiration (or full expiration). When this vital capacity is measured from a forced manoeuvre it is called a Forced Vital Capacity (FVC). The FVC can be reduced in both obstructive and restrictive ventilatory disorders. In obstructive lung disease mucous plugging and constriction of the airways can reduce the volume of air to be expired. In restrictive lung disease the distensibility of the lung tissue itself may be compromised resulting in an inability to move a sufficient capacity of air out of the lung. A reliable FVC can only be achieved when a subject can forcefully exhale all the air out of his or her lungs up to the point where the airways close, called residual volume. This is called the end of test point and corresponds to a position whereby less than 25 ml of air are left to exhale.

4.7.2 FORCED EXPIRATORY VOLUME AT (t) SECONDS (FEV_t)

The forced expiratory volume at (t) seconds is the volume of air expired during a given time interval (t) from the beginning of the forced vital capacity manoeuvre. The FEV_t can be at 0.5, 3 or 6 seconds, but the FEV at 1 second is the most widely used standardised parameter in lung function¹⁵. The FEV₁, just like the FVC, can be reduced in both obstructive and restrictive airway diseases. A distinction between these two patterns of dysfunction can be inferred by relating the FEV_t to the vital capacity and expressing it as a ratio FEV_t/VC.

4.7.3 RATIO OF EXPIRED VOLUME TO FLOW (FEV₁/FVC) and (FEV₁/FEV₆)

The FEV₁/FVC ratio is the standard index for assessing and quantifying airflow limitation. However, this ratio naturally declines with age in adults due in part to loss of

elastic recoil of the lungs¹⁶. The FEV₁/FEV₆ ratio is relating how much volume is expired in the first second of a forced vital capacity manoeuvre to that expired after six seconds.

4.7.4 FORCED AVERAGE EXPIRATORY FLOW AS A PERCENTAGE OF FVC (FEF 25-75%)

The forced expiratory flow (FEF_{x-y}) is the average flow rate during a given volume of the FVC manoeuvre. _{x-y} refers to the portion of the FVC for which this average flow is measured. FEF _{x-y} is expressed as a percentage of the FVC. The portion of 25% to 75% of the capacity expired is called the maximal mid expiratory flow rate or the forced expiratory flow from 25% to 75% of the exhaled volume. (MMEFR or FEF_{25-75%}). This measurement encompasses flow from both the medium sized and the small airways, and may be a more sensitive indicator for airways obstruction in patients with normal FEV₁ and FEV₁/FVC values¹⁷.

4.7.5 PEAK EXPIRATORY FLOW (PEF)

A peak expiratory flow (PEF) is a measure of the initial burst of air leaving the lungs and during testing can be a good indicator of patient effort. It reflects the portion of air leaving the large airways. Table 4.4 gives a definition of the main parameters measured during a forced expiratory manoeuvre.

4.7.6 FORCED EXPIRATORY TIME (FET)

The time taken to forcefully exhale a volume of air from a position of full inhalation to one of full exhalation.

TABLE 4.3 DEFINITIONS OF SPIROMETRIC PARAMETERS

Parameter	Units	Definition
VC	L	The maximal volume of air exhaled from a maximal inspiration

FVC	L	The maximal volume of air exhaled with maximally forced effort from a maximal inspiration
FEV ₁	l/s	The maximal volume of air exhaled in the first second of a forced expiration from a position of full inspiration
FEV ₆	L	The maximal volume of air exhaled in the first six seconds of a forced expiration from a position of full inspiration
FEV ₁ /FVC	%	FEV ₁ expressed as a percentage of FVC
FEV ₁ /FEV ₆	%	FEV ₁ expressed as a percentage of FEV ₆
FEF _{25-75%}	l/s	The mean forced expiratory flow between 25% and 75% of the FVC.
PEFR	l/s	The maximum expiratory flow generated during a maximum forced expiration, starting without hesitation from the point of maximal lung inflation

As well as producing an array of spirometric measurements, most spirometers also provide a graphical representation of exhaled volume. The ability to view a graphical representation of the manoeuvre is essential for assessing patient effort and appraising test acceptability. The fact that healthy lungs provide very reproducible graphs and diseased lungs can alter these graphs in a characteristic manner makes visual inspection of the overall shape of the graphs very significant for interpretation purposes.

4.8 EXPIRATORY FLOW VOLUME CURVES

The terms graph and curve are used to describe the graphical representation of a forced expiratory manoeuvre. Most spirometer devices have the facility to produce a graphical representation of the forced expiratory manoeuvre in the form of a plot of volume expired over time called a Spirogram, and or, flow rate plotted against volume, called a flow volume curve. Tracings allow for inspection for maximal patient effort and manoeuvre acceptability. The availability of a flow volume curve tracing can assist in test interpretation due to the fact that the flow volume tracing produces a very characteristic shape in certain lung diseases due the physiological phenomenon of dynamic airway compression as discussed in chapter 3. Figure 4.5 shows the spirogram of a subject with healthy airways who expired maximally. Volume is displayed on the x vertical axis and time on the y horizontal axis.

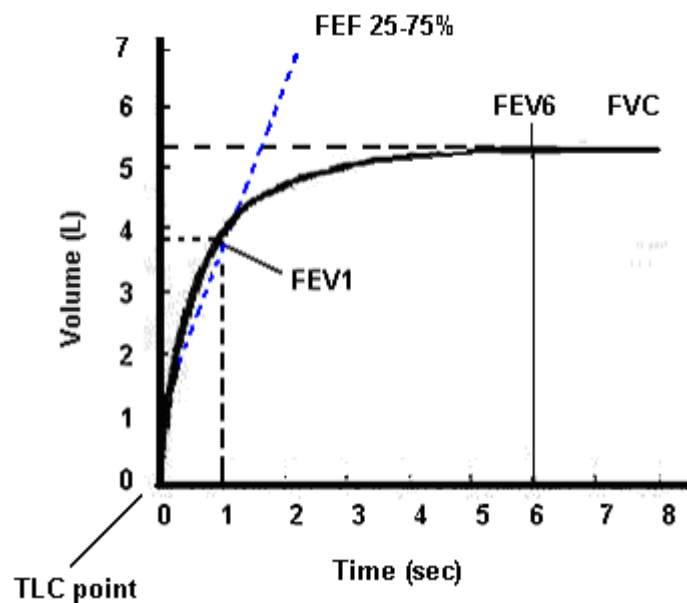

FIGURE 4.5 SPIROGRAM⁴

The volume exhaled is started at time zero or at the point of full inspiration, called total lung capacity (TLC), and as the patient expires forcefully the tracing rises abruptly as air leaves the large airways and then starts to plateau off as air is squeezed from progressively smaller airways until a point is met where no more air can be physically expired, a point known as the residual volume (RV) of the lung. The initial increase from time zero to where the line begins to curve represents the volume of air leaving the large to medium airways. The line then starts to 'shoulder' as air is forced from the medium to small airways and then plateaus as the small airways empty, trapping the essential residual volume that keeps the lungs inflated.

Forced vital capacity can be measured directly from the spirogram tracing by extending a straight line from the point where the tracing plateaus to the y axis. Where this line intersects the y axis is the forced vital capacity measured in litres. A measurement of flow in the first second FEV₁ is made by extending a vertical line from 1 second on the time scale to touch the curve and from this point a horizontal line is extended to the y axis where volume can be read. The FEF_{25-75%} can be calculated by dividing the FVC volume by two and dividing this by the time required to expire the middle half of the FVC.

$$\text{FEF}_{25-75\%} = \frac{1}{2} \text{FVC} / \Delta t \qquad \text{Equation 4.1}$$

where Δt = the time difference between 25% and 75% points on the curve.

The second type of tracing produced is the flow volume curve when flow rate in litres per second (l/s) is plotted against volume in litres (l) up to the total volume exhaled. The same spirometric information contained in the spirogram also exists in the flow volume curve, but this type of tracings makes it easier to see the subtle changes that may occur in the small airways.

It is also easier to see technique faults with this type of tracing. Fig 4.6 shows a typical flow volume curve from a subject with no airways disease. There is a rapid rise to peak expiratory flow as air is initially forced from the large airways, but the curve then descends gradually with no interruption back down to zero flow as the lungs empty.

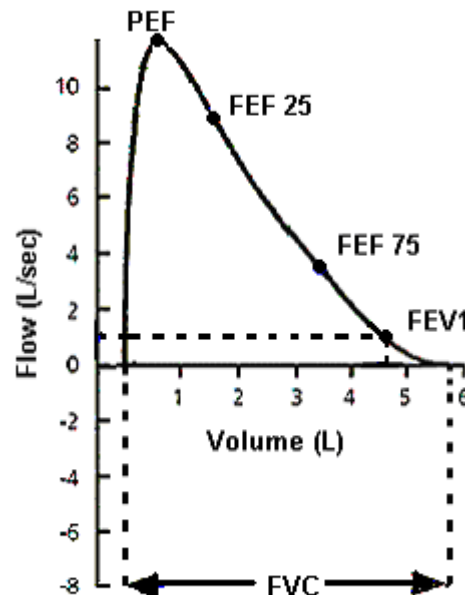

FIGURE 4.6 FLOW VOLUME CURVE⁵

4.9 INTERPRETATION

In interpreting a spirometry test, consideration is given to the quality of the measurement with respect to patient effort, test acceptability and test reproducibility and to the many different sources of variation as discussed in section 4.6. When all of these factors have been taken into account the work of interpreting whether a given set of spirometry results are 'normal' or 'abnormal' begins with a comparison to reference values based on a population of 'healthy' subjects who had performed spirometry testing under similar conditions. These reference equations are usually pre-programmed

into the spirometer's microprocessor and are easily accessible. There are wide choices of reference equations available, but differences in interpretation using different reference equations have been documented, highlighting the need to choose a reference set that is compatible with the population being tested¹⁸. Guidelines on lung function interpretation do not recommend any specific set of equations for use in Europe but do suggest the need for a new updated set of equations¹⁹. Reference equations are an important element of spirometry testing because without them interpretation would be very difficult. The following section provides some background information as to how these reference values are produced.

4.9.1 REFERENCE EQUATIONS

Stature and age play important roles in the establishment of spirometric reference equations. Stature can be used to empirically scale lung volumes and ventilatory flows and age has been shown to have a linear relationship with decline in lung function²⁰. The development of the lung does not take place uniformly with stature, and differs between genders; females have on average smaller lungs and larger airways than men of comparable size²¹. In childhood lung growth reflects the normal body growth which continues up to the age of puberty. During puberty which occurs at approximately age 12 years in girls and age 14 years in boys there is a natural growth spurt after which a plateau occurs in lung function followed by an age-related decline²². This rate of decline is related not only to body changes but is also influenced somewhat by environmental factors²³. The decline observed in lung function can begin during the plateau phase after puberty and has shown to occur earlier in smokers than in non-smokers²⁴.

In respiratory medicine, assessment of lung function and grading of severity of lung disease requires accurate interpretation of the various lung function parameters. This interpretation process requires knowledge of what constitutes a 'normal' lung function measurement and a 'normal' level of decline. Normal in this context is taken to be a particular circumstance that does not exceed certain limits or does not deviate from an average or standard established for a group, class or species²⁵. To aid in the interpretation of measured data, lung function analysis relies on mathematical models called regression equations from which reference or normal values are calculated.

Interpretation involves relating a measured value to a reference value in order to determine if the result falls within a predefined range of normality. One such method is to compare a new measurement with a previously recorded baseline measurement. This technique is only practical in a situation where serial measurements are recorded routinely for example in an occupational screening program. More commonly, measured data are compared with average values from a representative population for which a reference range has been pre-determined by statistical analysis. A reference population in the context of lung function is a group of healthy individuals without relevant disease from which multiple regression equations have been statistically determined and which take into account the variables that determine the reference equation. In order to secure an accurate comparison the reference set chosen must be comparable to the patient population in terms of both biological and analytical variability.

Measurement of lung function is subject to large variation and age, stature, sex and ethnicity in reference equations have been shown to only account for some 40-50 percent of this variability²⁶. In an effort to minimise the many sources of variability that exist in lung function, selection of appropriate reference sets that fit the population being tested in terms of both biological variability and analytical compatibility is

required. Both the European and the American Respiratory Societies have published detailed recommendations on the procedures and techniques of lung function²⁷ which have been recently been updated. These together with the host values are the factors to be considered when selecting a reference set.

Studies designed to produce reference equations can be described as cross-sectional or longitudinal. In a cross-sectional study, each participant is examined once at a single point or period in time. In a longitudinal study, the participant is examined at pre-defined periods of time. Most lung function reference equations have come from an amalgamation of cross sectional studies from many research groups and are subject to the 'cohort effect'. The cohort effect describes the changes that may take place in the characteristics of a population such as a change in nutrition, environmental conditions, and other such factors which may have evolved from when data were first collected.

When data have been collected from a reference population they are subjected to statistical analysis in order to generate a reference value and reference range for a specific spirometry or lung function parameter. For each parameter measured in the reference population, an average value is calculated and a measure of the variability around the average is given. Average and variability are statistical terms that can be described using a 'normal' or Gaussian distribution. In a normal distribution, the average measure is called the mean and the measure of the variability is called the standard deviation (SD).

4.9.2 DEFINING NORMALITY

Pulmonary function variables can be described in terms of a Gaussian distribution where the mean and the standard deviation determine the range of normality. In a normal distribution the mean is represented by the 50% line, half of the observations are below the predicted and half above the predicted. Figure 4.7 shows a Gaussian

distribution which applies the empirical rule stating that 68% of the observations fall within ± 1 standard deviation of the mean, 95% of the observations fall within ± 2 standard deviations of the mean and 99.7% of the observations fall within ± 3 standard deviations of the mean. Each standard deviation represents the probability that a single measured value will fall within a certain distance from the mean.

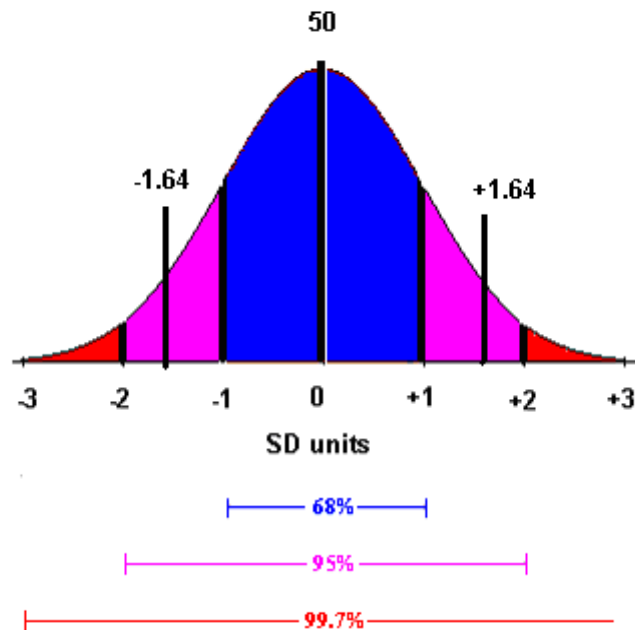

FIGURE 4.7 GAUSSIAN DISTRIBUTION⁶

A method of determining how far a result is from its predicted value is to express it in terms of the number of standard deviations the result is from the predicted. This is called the residual standard deviation (RSD).

In figure 4.7, one SD from the predicted value represents 68% and two SD represents 96%. In numerical terms one SD either side of the predicted line is -1.64.RSD or +1.64 RSD. The addition or subtraction of 1.64.RSD from the mean predicted value results in an upper or lower limit of normality²⁸. The addition of 1.64.RSD from the predicted value will give the upper limit of normal (ULN) the subtraction of 1.64 RSD from the predicted value will give the lower limit of normal (LLN). In 95% of individuals RSD is

less than 1.64 times the RSD and this is called the 95th percentile. In 5% of individuals the RSD is less than -1.64.RSD, this is called the 5th percentile.

The area between -1.64.RSD and +1.64.RSD in a Gaussian distribution comprises 90% of the population. 1.64. RSD is also referred to as the limit of normality. By defining the LLN as 1.64.RSD below the predicted line we are accepting a false positive rate of 5%.

A spirometry result that deviates from the expected value by greater than 1.64 times the RSD is taken to indicate that the spirometry measurement is abnormal, and this will be true in 95% of cases but may be an outlier in 5% of cases in individuals with healthy lungs.

4.9.3 DEFINING AIRFLOW OBSTRUCTION USING LOWER LIMITS OF NORMAL (LLN)

Current recommendations on the standardisation of lung function endorse the use of limits of normality to accurately interpret lung function²⁹. When defining airflow obstruction the use of lower limits of normal (LLN) can be used. All reference equations have pre-defined upper and lower limits of normal. In spirometry testing if a parameter is below its pre-defined lower limit of normal it is said to be an ‘abnormal’ finding.

In terms of airways obstruction, as mentioned in section 4.7.3, the FEV₁/FVC ratio is the standard index for assessing and quantifying airflow limitation. However current practice is to have what is called a fixed limit or a direct comparison of a measured value against its reference value to obtain a percentage predicted. An example of the use of fixed limits is the definition of an FEV₁ of 80% predicted or an airflow ratio FEV₁/FVC >70% which are often used to define normality³⁰. Fixed limits however have been found to be scientifically unfounded especially when applied to extremes of age and height and so tend to increase the likelihood of interpretative errors³¹. Because the

FEV₁/FVC ratio decreases physiologically with age, the use of fixed limits may result in many false positive diagnoses in older subjects. The joint ATS/ERS guidelines on interpretation published in 2005 define an obstructive ventilatory abnormality as a reduced FEV₁/VC ratio below the 5th percentile of the predicted value. They also acknowledge that early obstructive changes can be seen in the FEF_{25-75%} parameter but that this parameter is not specific for small airways disease in individual subjects.³²

4.10 SUMMARY

This chapter introduced the technical elements involved in spirometry testing and underlined the importance of achieving a spirometry manoeuvre that is both technically acceptable and reproducible. A section on reference equations and lower limits of normal serve to introduce the method in which spirometry values were used to detect the presence of airways obstruction in this thesis.

4.11 REFERENCES

1. Bishop PJ. A bibliography of John Hutchinson. *Med Hist* 1977;21: 384-396
2. The Birth and development of the forced expiratory manoeuvre: a tribute to Robert Tiffeneau (1910-1961). *Eur Respir J* 1997; 10: 270-271
3. Pellegrino R, Viegi G, Brusasco V, Crapo RO, Burgos F et al. Standardisation of Spirometry. *Eur Respir J* 2005; 26:319-338
4. Higgins J, Kittinger, P, Chu E. 'the Mass Flow Sensor: A Closer Look'. *Cardiopulmonary Review: Current Applications and Economics*. SensorMedics Continuing Medical Education Group.
5. *Manual of Pulmonary function Testing*. Ruppel GL. Seventh Ed. Mosby.
6. Pauwels RA, Buist S, Calverley PM, Jenkins CR, Hurd, SS. GOLD Scientific Committee. Global strategy for the diagnosis, management, and prevention of chronic obstructive pulmonary disease. NHLBI/WHO Global Initiative for Chronic Obstructive Pulmonary Disease (GOLD) Workshop summary. *Am J Respir Crit Care Med* 2001; 163:1256-1276
7. Zielinski J, Bednareck M et al. Early detection of C.O.P.D in a high risk population using spirometric screening. *Chest* 2001; 119: 731-736

8. Pellegrino R, Viegi G, Brusasco V, Crapo RO, Burgos F et al. Standardisation of Spirometry. *Eur Respir J* 2005; 26:319-338
9. D'Angelo E, Prandi E, Milic-Emili J. Dependence of maximal flow-volume curves on time course of preceding inspiration. *J Appl Physiol* 1993; 75:1155-1159
10. Pellegrino R, Decramer M, VAN Schayck CPO, et al. Quality control of spirometry: a lesson from the BRONCHUS trial. *Eur Respir J* 2005
11. Lebowitz MD, Quakerenboss J, Camilli AE, Bronnimann D, et al. The epidemiological importance of intraindividual changes in objective pulmonary responses. *Eur J Epidemiol* 1987; 3: 390-398
12. Burrows B, Lebowitz MD, Camilli AE, Knudson RJ. Longitudinal changes in forced expiratory volume in one second in adults. Methodological considerations and findings in healthy nonsmokers. *Am Rev Respir Dis* 1986; 33: 974-980
13. American Thoracic Society. Lung Function testing: selection of reference values and interpretation strategies. *Am Rev Respir Dis* 1991;144: 1202-1218
14. Kunzli N, Ackermann-Lieblich U, Keller R, Perruchoud AP, Schindler C, SAPALIA Team. Variability of FVC and FEV₁, due to technician, team,

device and subject in an eight centre study: three quality control studies in SAPALDIA. *Eur Respir J*.1995; 8: 371-376

15. Pellegrino R, Viegi G, Brusasco V, Crapo RO, Burgos F et al. Interpretation strategies for lung function tests. *Eur Respir J* 2005; 26: 948-968
16. Knudson RJ, Lebowitz MD, Holberg CJ, Burrows B. Changes in the maximum expired flow volume curve with growth and ageing. *Am Rev Respir Dis* 1983; 127: 725-734
17. Pride NB, Macklem PT. Lung mechanics in disease. In: Macklem T, Mead J, eds. *Handbook of Physiology. The Respiratory System. Mechanics of breathing. Section 3, Vol III, part 2.* Bethesda, American Physiological Society, 1986; pp 659-692
18. Celli BR, Halbert RJ, Isonaka S, Schau B. Population impact of different definitions of airway obstruction. *Eur Respir J* 2003; 22: 268-273
19. Pellegrino R, Viegi G, Brusasco V, Crapo RO, Burgos F et al. Interpretation strategies for lung function tests. *Eur Respir J* 2005; 26: 948-968
20. Hurwitz S, Allen J, Liben A, Becklake, MR. Lung function in young adults: evidence for the differences in the chronological age at which various functions start to decline. *Thorax* 1980;35: 615-619
21. Dirksen A, Groth S. Calculation of reference values for lung function tests. *Bull Eur Physiopathol Respir* 1986; 22: 231-237

22. Rosenthal M, Bain SH, Cramer D et al. Lung function in white children age 4-19 years. 1-spirometry. *Thorax* 1993; 48: 704-802
23. Coates J, Miller J, Chinn D. Lung Function. Sixth ed. Chapter 25. Reference equations. Pg 320. Blackwell publishing. 2006
24. Sherrill DL, Lebowitz DM, Knudsen RJ, Burrows B. Smoking and symptom effects on the curves of lung function growth and decline. *Am Rev Respir Dis* 1991;144:17-22
25. Hayakawa SI (editor) Cassell's modern guide to synonyms and related words. Cassell and Co Ltd, 1971. In Chapter 3, reference equations, Practical handbook of Respiratory Function Testing, Part 1. Association of Respiratory Technicians and Physiologists (ARTP). Second edition. 2003
26. Becklake MR. Concepts of normality applied to the measurement of Lung function. *Am J Med* 1986; 80: 1158-1164
27. Pellegrino R, Viegi G, Brusasco V, Crapo RO, Burgos F et al. Standardisation of Spirometry. *Eur Respir J* 2005; 26:319-338
28. Altman DG, Bland JM. The normal distribution. *Statistic notes. BMJ* 1995;35: 298-310

29. Pellegrino R, Viegi G, Brusasco V, Crapo RO, Burgos F et al. Interpretation strategies for lung function tests. *Eur Respir J* 2005; 26: 948-968

30. Pauwels RA, Buist S, Calverley PM, Jenkins CR, Hurd, SS. GOLD Scientific Committee. Global strategy for the diagnosis, management, and prevention of chronic obstructive pulmonary disease. NHLBI/WHO Global Initiative for Chronic Obstructive Pulmonary Disease (GOLD) Workshop summary. *Am J Respir Crit Care Med* 2001; 163:1256-1276

31. Roberts SD, Farber MO, Knox KS et al. FEV₁/FVC ratio of 70% misclassifies patients with obstruction at the extremes of age

FIGURES

1. A bibliography of John Hutchinson *Med Hist* 21;365-368

2. The Mass Flow Sensor: A Closer Look, Sensor Medics customer article

3. A manual of Pulmonary Function Testing, Ruppel G, 7th ed, Mosby

4. Sensor medics Vmax tutorial version 5A, Sensor medics, Viaysis Inc

5. Handbook of Respiratory Testing. Part 1, Association of Respiratory technicians and physiologists (ARTP)

CHAPTER 5. LITERATURE REVIEW

5.1 INTRODUCTION

This chapter sets out to provide a brief chronology and commentary of previous studies pertaining to the use of the forced expiratory volume at six seconds (FEV_6) as a surrogate for the forced expiratory volume (FVC) in lung function testing. The measurement of a forced vital capacity (FVC) coupled with the expression of this capacity as a function of time, the forced expiratory volume in one second (FEV_1) and their ratio FEV_1/FVC , are the cornerstone parameters for spirometry measurement and interpretation. Definition of these FVC parameters by Tiffenau and Pinelli¹ in the late 1940s has firmly endured in spirometric testing despite six decades of medical research and technological advances.

The undeniable importance of the spirometric ratio FEV_1/FVC as a capable independent predictor of morbidity due to chronic obstructive pulmonary disease (COPD) and also mortality due to cardiovascular disease and lung cancer coupled with the increase of lung disease worldwide has led to growing support of spirometry as a major player in early diagnosis of lung diseases in particular COPD².

5.2 BACKGROUND

The accuracy and reproducibility of a spirometry measurement is dependant on equipment functioning properly, on the physiologist's training and motivation, and on the subject's test performance³. In an effort to reduce variability and hence improve accuracy, guidelines on spirometry testing were first published in the early 1980s by Thoracic Societies on both sides of the Atlantic. More recently joint guidelines issued

by the European Respiratory Society and the American Thoracic Society have provided a standardized approach to spirometry testing and interpretation⁴.

To obtain a spirometry measurement that is technically acceptable certain criteria must be adhered to. One such criterion refers to when a forced expiratory effort has reached its natural end. Technically this criterion is satisfied when a subject's expired breath shows no volume change ($<25\text{ml}$) in ≥ 1 second. In practical terms the end of test criterion has proven to be the most difficult and demanding for patients. In the clinical setting it is not unusual to have patients with prolonged expiratory times that extend beyond 10 seconds. This inevitably results in significant strain and discomfort for the patient as they are frequently encouraged to continue expiring until the end of test criterion is satisfied. In response to the need for an alternative end of test criterion, interest in a forced expiratory manoeuvre of a duration that could be easily attained by the majority of adults was investigated.

5.3 STUDIES INTO AN ALTERNATIVE END OF TEST POINT (FEV₆)

The catalyst for research into an FVC manoeuvre of fixed duration came in the form of FEV₆ as proposed by Glindmeyer et al.⁵ in 1987. In an effort to ascertain test reproducibility in a large sample of patients undergoing spirometry testing it was found that an expiration time of 6.64 seconds was more than adequate to discern an acceptable and reproducible test result. Although this finding demonstrated that a truncated FVC manoeuvre of six second duration, FEV₆, reflected sufficient time to obtain test reproducibility, interpretation of spirometry results using this new parameter awaited the publication of up-to-date reference equations and lower limits of normal for a wide range of spirometry indices to include FEV₆ and its ratio FEV₁/FEV₆.

This finding seemed very promising as it offered the possibility of a shorter forced expiratory manoeuvre that fitted the criteria for an acceptable and reproducible test. In

theory this shortened manoeuvre would be less distressing for patients who have long expiratory times, i.e. those with obstructive airways disease and elderly patients.

In the United States a study called the National Health and Nutrition Examination Survey (NHANES) published its third set of findings⁶ in 1994. This survey was designed to obtain nationally representative information on the health and nutrition status of a US population through interview and physical examinations. Participants of this survey underwent spirometry testing to assess their lung function status. Utilizing spirometric data collected by this survey from life-long non-smokers aged 8-80 years with no history of lung disease, a group of researchers, Hankinson et al.⁷, created and published spirometric reference equations and lower limits of normal for FVC and included for the first time equations for the shorter spirometry manoeuvre FEV₆.

Both the NHANES III and another similar large American multi-centre survey, the Lung Health Survey (LHS)⁸, conducted at the same time, drew similar conclusions from their data. Both groups acknowledged spirometry as being effective in identifying mild airways obstruction in their participants who smoked, many of whom had previously denied any chest symptoms on interview. A statement documenting the importance of spirometry in detecting airways obstruction in asymptomatic adults was made. In response a subgroup known as the National Lung Health Education Program (NLHEP)⁹ was established to evaluate the role of spirometry testing as a means of assessing lung disease. This re-evaluation of the role of spirometry in light of previous research led the NLHEP group to conclude that, coupled with the appropriate reference equations, Glindmeyer's proposal of FEV₆ as a possible surrogate to FVC to detect early lung disease warranted further research. The need to advocate spirometry as a screening test in the primary care setting was the rationale behind their support for this shorter FVC manoeuvre. A handheld spirometer with electronic quality control statements guiding the operator in obtaining accurate results, coupled with a shorter test manoeuvre would

make spirometry a more attractive tool in screening. Following from this a number of studies were conducted with the common aim of investigating the credibility of FEV₆ as an alternative to FVC in detecting abnormal spirometry.

For FEV₆ and FEV₁/FEV₆ to have any diagnostic status, a statistical evaluation of the ability of this new parameter to differentiate normal from abnormal spirometry results— as defined by the statistical terms sensitivity, specificity, and positive predictive value (PPV) and negative predictive value (NPV) needed to be assessed. A section detailing the statistical methods used in this research and in other papers cited in this chapter is dealt with in chapter 6.

Swanney et al.¹⁰ were the first researchers to analyse and publish findings on the new FEV₆ parameter. This group retrospectively analysed spirometry data from 502 patients attending a New Zealand hospital. They found the new FEV₁/FEV₆ ratio to be a good substitute for the traditional FEV₁/FVC ratio in its ability to detect abnormal lung function. As part of this analysis, Swanney et al. directly compared FEV₆ to FVC and in doing so found FEV₆ to be less variable and more reproducible.

The ability of the FEV₆ parameter to accurately diagnose abnormal spirometry will depend on the prevalence of this abnormality in the population being tested. In Swanney's research population approximately two thirds of the subjects had documented airways obstruction i.e. the prevalence of obstruction was 65.6% leading to the high positive predictive value (PPV) of 98.6% experienced by that research group. This meant that a patient with airways obstruction had been correctly diagnosed with airways obstruction using FEV₁/FEV₆, 98.6% of the time.

Results from that study looked promising for FEV₆, but as the authors pointed out in their discussion, more work was required by other researchers using larger numbers of subjects in a population with a different prevalence of obstruction, to confirm their findings.

This call was answered by Vandervoode et al.¹¹ who analysed spirometry data from a much larger patient group (11,676) with an overall prevalence of obstruction of 39.9%. Results in terms of both sensitivity and specificity for FEV₆ were very similar to the previous researchers. A lower prevalence of obstruction in this group of subjects produced a lower PPV (89.8% vs. 98.6%), whereas the negative predictive value (NPV), in which a subject with normal lung function was correctly diagnosed as normal spirometry, using the new ratio was higher (96.0% vs. 91.1%). Vandervoode and co-workers' research added more weight to the argument that FEV₆ could be substituted for FVC without affecting the test's ability to detect abnormal spirometry.

Following this, in a study of 5,114 Turkish patients who underwent spirometry as part of their lung function assessment, Demir et al¹² found FEV₆ to underestimate FVC and so produce relatively low sensitivity (86%). They found this to be particularly evident in cases where the forced vital capacity measurement was more than 1 litre greater than the forced expiratory volume after six seconds. The reduced sensitivity experienced by this research group was not surprising given the 'fixed cut off' method employed to classify airways obstruction. In the study a spirometry result producing an FEV₁/FVC or an FEV₁/FEV₆ ratio below a fixed 70% was deemed abnormal. In using the same fixed cut off point for both ratios, this group failed to consider that both ratios not only decline with age but also with forced expiratory time¹³. To properly compare FEV₁/FVC with FEV₁/FEV₆ in the context of defining airways obstruction using a fixed cut-off point, an FEV₁/FEV₆ which best predicted an FEV₁/FVC ratio of 0.70 would need to be calculated using appropriate statistics.

This was duly researched in another study by Vandervoode et al. on the role of FEV₆ with the purpose of determining fixed cut off points for FEV₁/FEV₆ and FEV₆ in the detection of abnormal spirometry¹⁴. As traditional criteria for detecting abnormal spirometry involves the use of fixed cut off points¹⁵ this study unlike that of Demir et al.

sought to provide fixed cut of points specifically for the FEV₆ parameter. Results from this study showed that FEV₁/FEV₆ <73% can be used as a valid alternative to FEV₁/FVC <70% in the detection of airways obstruction. The authors rightly caution the use of fixed cut off points in spirometry interpretation, as this practice has been found to be statistically unsound particularly in the elderly age group due the fact that they fail to take into account the natural age related decline in the FEV₁/FVC and FEV₁/FEV₆ parameter, leading to the potential for misclassification¹⁶. However, as this group also pointed out there are no specific European spirometric reference equations and lower limits of normal for FEV₁/FVC and FEV₁/FEV₆ covering all age ranges. Until such reference equations are established the practice of using fixed cut off points will remain widespread.

The next major study on FEV₆ to be published reviewed its role in detecting abnormal spirometry in the workplace setting. Alkpinæ et al.¹⁷ hypothesized that the FEV₆ parameter would, in this setting, result in a 'low misclassification' rate for detecting airways obstruction, compared to the traditional FVC parameter. Spirometry results for 1,143 workers from four workplace settings were analyzed using appropriate reference equations and lower limits of normal for both parameters.

The authors concluded that FEV₆ could be used as a reliable substitute for FVC in detecting abnormal spirometry in the workplace setting. Results showed that only 3.8% of workers in this study were classified differently by the two techniques thus yielding a high sensitivity and low misclassification rate. This research was a departure from previous studies looking specifically at the diagnostic ability of FEV₆ in the clinical setting. In the workplace setting there is perhaps a greater reliance on good quality spirometric results for accurate interpretation from a medico-legal standpoint as the potential for developing lung disease from workplace exposures may exist in certain circumstances.

In a study published by Hansen et al.¹⁸ the use of FEV₆ in detecting airways obstruction was critically analyzed. Spirometry data from the NHANES III survey was used in this retrospective study. By substituting FVC with FEV₆ the authors found that the sensitivity of a spirometry test to screen for obstruction was reduced, particularly in elderly subjects and subjects with mild airways obstruction as defined by the FEV₁/FVC ratio. This prompted the authors to call into question the utility of FEV₆ in producing an accurate diagnosis in these two specific groups.

In response to the recommendation from the NHLEP advocating spirometry as a screening test in primary care settings, Gleeson et al.¹⁹ published a study on the accuracy of the FEV₆ in detecting abnormal spirometry at a community hospital. This study assessed the concordance of FEV₁/FVC and FEV₁/FEV₆ using NHANES reference equations and their own routinely used reference equations. Better sensitivity for detecting abnormal spirometry was found in their study group using the NHANES equations but moderate specificity was found when using their own reference equations. This study cautioned the use of FEV₆-based interpretation of spirometry results in a primary care setting irrespective of the reference equations chosen, citing the importance of motivated trained professionals in administering spirometry in an effort to curtail poor quality results.

The agreement between FEV₁/FEV₆ and FEV₁/FVC in an elderly population was further investigated by Melby et al.²⁰. This group analysed spirometric data from a large sample of Norwegian subjects over 60 years of age. They reported the mean difference in both ratios, regardless of gender to be 2.7%. On further analysis they found this difference to be more pronounced in smokers and those with a reduced FEV₁/FVC ratio. In response to previous research on fixed cut -off points this group sought to create fixed cut -off points specifically for their elderly study group. A fixed cut-off point of 73% for FEV₁/FEV₆ was found to be the best substitute for an FEV₁/FVC cut-off point

of 70%. This mirrored the results obtained for fixed cut-off points by the Vandervoede et al. group. The authors concluded that the FEV₁/FEV₆ ratio was a good substitute for FEV₁/FVC in an elderly population.

Reference equations are paramount in allowing investigators to determine the diagnostic accuracy of the shortened FEV₆ manoeuvre. However currently the only reference equations available for a wide age range (8-80) years that include the shorter FEV₆ parameter are those published by Hankinson from NHANES III data. The choice of reference equations in spirometry testing has been shown to have a significant effect on the interpretation²¹. In a recent consensus²² from experts on both sides of the Atlantic in an effort to standardize interpretation of lung function, choosing reference equations that accurately match the population being studied was advocated, while at the same time acknowledging the lack of widespread spirometric reference equations that take into account the rate of decline of lung function with age. In response to this dearth of appropriate spirometric equations for elderly subjects, studies have been published in recent years giving more equations and lower limits of normal for subjects over 60 years^{23, 24}.

In particular Garcia-Rio²⁵ published reference equation for European males and females in the age range 65-85 years and included for the first time reference equations and lower limits of normal for the FEV₆ and FEV₁/FEV₆ for European elderly adults. The availability of these equations provided the means for investigating the agreement between FEV₆ and FVC in diagnosing airways obstruction in patients over the age of 65 years in this thesis. The most recent addition to the library of FEV₆ reference equations has been published by a group of New Zealand researchers²⁶ for a New Zealand population of European origin aged 25-75 years.

Updated European spirometric reference equations for a widespread age range to include reference equations and lower limits of normal for FEV₆ parameters will lead

the way to much needed research into the utility of the FEV₆ parameter in spirometric detection of abnormality and in particular into early screening at a primary care level.

5.4 SUMMARY

The majority of research publications to date show that FEV₆ is a suitable alternative to the traditional FVC manoeuvre. Although the methods used to compare FEV₆ to FVC in the research studies outlined in this chapter are similar to this research, this study is the first to our knowledge to compare FEV₁/FEV₆ and FEV₁/FVC using the Garcia-Rio reference equations for elderly subjects aged 65-85 years.

5.5 REFERENCES

1. The birth and development of the forced expiratory manoeuvre: a tribute to Robert Tiffeneau (1910-1961). *Eur Respir J* 1997; 10: 270-271
2. Zielinski J, Bednareck M et al. Early detection of C.O.P.D in a high risk population using spirometric screening. *Chest* 2001; 119: 731-736
3. Kunzli N, Ackermann-Liebrich U, Keller R, Perruchoud AP, Schindler C, SAPALIA Team. Variability of FVC and FEV₁, due to technician, team, device and subject in an eight centre study: three quality control studies in SAPALDIA. *Eur Respir J*.1995; 8: 371-376
4. Pellegrino R, Viegi G, Brusasco V, Crapo RO, Burgos F et al. Standardisation of Spirometry. *Eur Respir J* 2005; 26:319-338
5. Glindmeyer HW, Jones RN, Barkman HW, Weill H. Spirometry: quantitative test criteria and test acceptability. *Am Rev Respir Dis* 1987; 136:449-452
6. National Center for Health Statistics 1994. Plan and operation of the third national health and nutrition examination survey, 1988-1994. www.cdc.gov/nchs/nhanes.htm
7. Hankinson JL, Odencrantz JR, Fedan KB. Spirometric reference values from a sample of the general US population. *Am. J. Respir. Crit. Care. Med* 1999; 159:179-187

8. Anthonisen NR, Connett JE, Kiley JP et al. Effects of smoking intervention on the use of an inhaled anticholinergic bronchodilator on the rate of decline of FEV₁: the lung health study. *JAMA* 1994; 272: 1497-1505
9. Ferguson GT, Enright PL, Buist AS, Higgins MW. Office spirometry for lung health assessment in adults: a consensus statement from the National Lung Health Education Program. *Respir Care* 2000; 45(5): 513-530
10. Swanney MP, Jensen RL, Crichton DA, Beckert LE, Cardno L, Crapo R. FEV₆ is an acceptable surrogate for FVC in the spirometric diagnosis of airway obstruction and restriction. *Am. J. Crit. Care. Med* 2000;162:917-919
11. Vandevorde J, Verbanck S, Schuermans D, Kartounian J, Vincken W. FEV₁/FEV₆ and FEV₆ as an alternative for FEV₁/FVC and FVC in the spirometric detection of airway obstruction and restriction. *Chest* 2005; 127:1560-1564
12. Demir T, Ikitimur HD, Koc N, Yildrum N. The role of FEV₆ in detection of airways obstruction. *Respir Med* 2005; 99:103-106
13. Knudson RJ, Lebowitz MD, Holberg CJ, Burrows B. Changes in the maximum expired flow volume curve with growth and ageing. *Am Rev Respir Dis* 1983; 127: 725-734
14. Vandevorde J, Verbanck S, Schuermans D, Kartounian J, Vincken W. Obstructive and restrictive spirometric patterns: fixed cut-offs for FEV₁/FEV₆ and FEV₆. *Eur Respir J* 2006; 27: 378-383

15. Pawels RA, Buist AS, Calverly PM, Jenkins CR, Hurd SS. GOLD Scientific Committee. Global Strategy for the diagnosis, management, and prevention of chronic obstructive pulmonary disease. NHLBI/WHO Global Initiative for Chronic Obstructive Lung Disease (GOLD) Workshop summary. *Am J Respir Crit Care Med* 2001; 163:1256-1276

16. Hardie JA, Buist AS, Vollmer VM , Ellingsen I, Bakke PS, Morkve O. Risk of over-diagnosis of COPD in asymptomatic elderly never-smokers. *Eur Respir J* 2002; 20:1117-1122

17. Akpınar-Elci M, Fedan KB, Enright PL. FEV₆ as a surrogate for FVC in detecting airways obstruction and restriction in the workplace. *Eur Respir J* 2006; 27: 374-377

18. Hansen JE, Sun X-G, Wasserman K. Should forced expiratory volumes in six seconds replace forced vital capacity to detect airway obstruction? *Eur Respir J* 2006; 27: 1244-1250

19. Gleeson S, Mitchell B, Pasquarella C et al. Comparison of FEV₆ and FVC for detection of airways obstruction in a community hospital pulmonary function laboratory. *Resp Med* 2006; 100: 1397-1401

20. Melby H, Medbo A, Crockett A. The FEV₁/FEV₆ ratio is a good substitute for the FEV₁/FVC ratio in the elderly. *J.PCRJ* 2006; 15: 294-298

21. Celli BR, Halbert RJ, Isonaka S, Schau B. Population impact of different definitions of airway obstruction. *Eur Respir J* 2003; 22: 268-273
22. Pellegrino R, Viegi G, Brusasco V, Crapo RO, Burgos F et al. Interpretative strategies for lung function tests. *Eur Respir J* 2005; 26: 948-968
23. Enright PL, Adams AB, Boyle PJ, Sherrill DL. Spirometry and maximal respiratory pressure references from healthy Minnesota 65 to 85 year old women and men. *Chest* 1995; 108: 663-669
24. Falaschetti E, Laiho J, Primatesta P, Purdon S. Prediction equations for normal and low lung function from the Health Survey for England. *Eur Respir J* 2004; 23: 456-463
25. Garcia-Rio F, Pino JM, Dorgham A, Alsono A, Villamor J. Spirometric reference equations for European females and males aged 65-85yrs. *Eur Respir J* 2004;24: 397-405
26. Marsh S, Aldington S, Williams M, Weatherall M, Shirtcliffe P, McNaughton A, Prichard A, Beasley R. Complete reference ranges for pulmonary function tests from a single New Zealand population. *NZMJ* 2006; 10: Vol 119

CHAPTER 6 METHODOLOGY

6.1 INTRODUCTION

This chapter gives a brief summary of the methodology used for each of the three main sections of this thesis. Ethics approval for this research study was sought and granted by the ethics committee of the Bon Secours Hospital Group and specific request to include the spirometry data from patients under the care of three referring consultant respiratory physicians was sought and granted. Spirometry was performed using the same mass flow- sensing spirometer (Sensor Medics Vmax 22 +Autobox V6200, Viaysis Healthcare), and the author of this thesis was responsible for carrying out each spirometry test included in this study. Equipment specification sheets are included in appendix D. The highest pre-bronchodilator FVC, FEV₁ and FEV₆ were included in the analysis.

All numeric values are given as mean \pm standard deviation. All of the data contained in this study were obtained retrospectively. Non parametric t- tests were chosen as the most suitable tests for evaluating the data in study 1. Statistical significance was taken at $p < 0.05$ level, and a statistically highly significant was taken as $p < 0.001$. Symbols are used to denote degrees of significance of the results tables in chapter 7. The system used is *, **, and *** to mean $P < 0.05$, 0.01 and 0.001 respectively¹. 2-by-2 contingency tables² are the statistical method chosen as the most suitable way to display data in sections B and C for statistical evaluation.

6.2 (SECTION A) THE SPIROMETRIC FINDINGS OF SMOKERS COMPARED TO NON-SMOKERS

As our objective in this study was to investigate the usefulness of spirometric parameters and in particular the new FEV₆ parameters in providing an early indicator of dynamic airway changes in smokers we carried out a retrospective search of the pulmonary function database to included patients with an FEV₁ and an FEV₁/FVC of greater than 75% of predicted. This search produced n = 156 smokers (91 female,65 male) and n = 178 non-smokers (111 female, 67 male). Smokers in this study were patients who smoked at the time of testing either daily or occasionally. Non-smokers were patients who had not smoked at all at the time of testing³. We chose the following demographic variables and spirometric parameters to compare both groups.

Demographics variables:

Age (Years)

Height (cm)

Weight (kg)

Body Mass Index (kg/m²)

Gender

Spirometric parameters

FVC

FEV₆

FEV₁/FVC

FEV₁/FEV₆

FEF_{25-75%}

FET

The spirometric parameters obtained represent the highest pre-bronchodilator from tests containing at least three spirometry manoeuvres. Each spirometry manoeuvre was assessed according to recently published guidelines on standardisation of spirometry testing⁴ and passed as acceptable and reproducible.

Data are presented as mean percent predicted \pm standard deviation and statistical significance was determined using non-parametric two tailed t-tests (Table 7.1).

Data from the smoking group were sorted by the number of cigarettes smoked daily. Two groups were established, Group 1 consisted of smokers with a self-reported consumption rate of less than 20 cigarettes per day ($n = 67$) and Group 2 greater than 20 cigarettes per day ($n = 89$). Data are presented as mean percent predicted \pm standard deviation and statistical significance was determined using non-parametric two tailed t-tests (Table 7.2)

Data were sorted by gender to compare male smokers ($n = 65$) to male non-smokers ($n = 67$) and female smokers ($n = 91$) to female non-smokers ($n = 111$). Results are presented as mean percent predicted \pm standard deviation and statistical significance was determined using non-parametric two tailed t-tests (Tables 7.3 and 7.4)

6.3 (SECTION B) A COMPARISON OF FEV₁/FEV₆ WITH FEV₁/FVC IN DIAGNOSING AIRWAYS OBSTRUCTION

A retrospective search of the pulmonary function database over a period of 4 months resulted in n = 171 patients, female (n = 87), male (n = 84). Only patients with spirometry data meeting the acceptability and reproducibility criteria set out in table 6.1 were included in this study.

TABLE 6.1 INCLUSION CRITERIA

Abrupt start of test with a back extrapolated volume < 150 ml of FVC
No evidence of cough
No evidence of glottis closure
A Forced Expiratory Time (FET) of at least 6 seconds duration
Three spirometry trials with each FEV ₁ and FVC within 150 ml of each other
Evidence of a satisfactory end of test (EOT) criterion (< 25 ml expired over 1 second)

Applying the above criteria resulted in 72 patients (33 female, 39 male) being excluded from the study. Subject demographics, specific reasons for exclusion and spirometry results of the excluded group are given in appendix E.

Of the remaining 99 subjects (55 female, 44 male) we calculated a mean and standard deviation on the following highest pre-bronchodilator measured spirometric parameters FVC, FEV₆, FEV₁, FEV₁/FVC, FEV₁/FEV₆, FEF_{25-75%}, FET and the following subject variables, age, height, gender and body mass index. (Chapter 7, Tables 7.5 and 7.6).

An inter-subject coefficient of variation (CoV) was calculated for FEV_1/FVC and FEV_1/FEV_6 , by dividing the mean standard deviation of the ratio by the mean of the ratio and multiplying by 100 to obtain the percentage CoV.

STUDY B1

The data were then sorted by age into four categories.

Category 1 20-29 years (n = 4)

Category 2 30-49 years (n = 24)

Category 3 50-69 years (n = 49)

Category 4 70-89 years (n = 22).

The mean measured FEV_1/FVC and mean measured FEV_1/FEV_6 were compared for each category. (Table 7.7)

STUDY B2

Data were then sorted by the degree of airways patency as defined by the mean measured FEV_1/FVC ratio, into four groups.

Group 1 $FEV_1/FVC > 80$

2 $FEV_1/FVC 70-80$

3 $FEV_1/FVC 50-69$

4 $FEV_1/FVC < 50$

The mean measured FEV_1/FVC and mean measured FEV_1/FEV_6 were compared for each category. (Table 7.8).

STUDY B3

In order to assess the diagnostic ability of FEV_1/FEV_6 in identifying airways obstruction we compared the measured FEV_1/FVC and FEV_1/FEV_6 to their corresponding lower limit of normal values. Lower limit of normal equations were obtained from the NHANES III reference set² are given in appendix F. If the measured value of the ratio was higher than its corresponding LLN value, the test was categorised as not obstructed. If the measured value was less than its LLN, the test was categorised as obstructed. To determine the sensitivity and specificity of the FEV_1/FEV_6 ratio in diagnosing airways obstruction a 2*2 contingency table was constructed. A sample contingency table is shown in table 6.2. The terms positive and negative are used to refer to the presence or absence of airways obstruction.

TABLE 6.2 SAMPLE CONTINGENCY TABLE

TP	FP
FN	TN

TP = True positive ($FEV_1/FVC < LLN$ and $FEV_1/FEV_6 < LLN$)

TN = True negative ($FEV_1/FVC > LLN$ and $FEV_1/FEV_6 > LLN$)

FP= False positive ($FEV_1/FVC > LLN$ and $FEV_1/FEV_6 < LLN$)

FN =False negative ($FEV_1/FVC < LLN$ and $FEV_1/FEV_6 > LLN$)

Sensitivity, Specificity, positive predictive value (PPV) and negative predictive value (NPV) were calculated following the Bland and Altman definitions⁵

$$\text{Sensitivity} = \text{TP} / (\text{TP} + \text{FN})$$

Equation 6.1

$$\text{Specificity} = \text{TN} / (\text{FP} + \text{TN})$$

Equation 6.2

$$\text{PPV} = \frac{\text{Sensitivity} * \text{prevalence}}$$

$$\text{Sensitivity} * (1 - \text{Specificity}) * (1 - \text{prevalence})$$

Equation 6.3

$$\text{NPV} = \frac{\text{Specificity} * (1 - \text{prevalence})}$$

$$(1 - \text{sensitivity}) * \text{prevalence} + \text{specificity} * (1 - \text{prevalence})$$

Equation 6.4

Values that fall into the FP and FN categories are referred to as discordant cases. The subject demographics and mean measured FEV₁/FVC and FEV₁/FEV₆ ratios of discordant cases together with their LLN values were calculated (Table 7.9).

6.4 (SECTION C) FEV₁/FEV₆ AS A SUBSTITUTE FOR FEV₁/FVC IN A SUBGROUP OF ELDERLY PATIENTS USING TWO SETS OF REFERENCE EQUATIONS

A retrospective search of the pulmonary function database was conducted for subjects aged 65-85 years who could exhale for at least six seconds and who met the clinical guideline criteria for this, resulted in n = 68 patients (35 female,33 male). Over the course of this research project our pulmonary function database was upgraded⁶ to allow us to input a specific search pattern to include only those subjects meeting the inclusion criteria set out in (Table 6.1)

Mean and standard deviation values were obtained for age, height and FET (table 7.11) and FVC, FEV₆, FEV₁, FEV₁/FVC, FEV₁/FEV₆, and FET (Table 7.12)

We compared FEV₁/FVC and FEV₁/FEV₆ to the lower limits of normal from the NHANES III spirometry reference set⁷, and constructed a contingency table as described in section 6.3. This was repeated using reference equations and lower limits of normal from the Garcia-Rio spirometry reference set⁸ (Table 7.13 and 7.14), appendix G.

6.5 SUMMARY

This chapter provided a brief description of the methodology used for the three results sections included in chapter 7.

6.6 REFERENCES

- 1 Bland JM, Bland DG. Statistics Notes: Presentation of numerical data. *BMJ* 1996;312:572
- 2 Altman DG, Bland JM. Statistics Notes: Diagnostic tests 1: sensitivity and specificity. *BMJ* 1994;308:1552
- 3 WHO Guidelines for controlling and monitoring the tobacco epidemic. Geneva, WHO, 1998
- 4 Miller MR, Hankinson J, Brusasco V, et al. Standardisation of spirometry. *Eur Respir J* 2005; 26: 153-161
- 5 Altman DG, Bland JM. Statistics Notes: Diagnostic tests 2: predictive values. *BMJ* 1994;309: 102
- 6 Sensor Medics, VMAX Relational database Manager software version 5.2.
- 7 Hankinson JL, Odencrantz JR, Fedan KB. Spirometric reference values from a sample of the general U.S population. *Am J Respir Crit Care Med* 1999;159: 179-187
8. Garcia-Rio F, Pino JM, Dorgham A, Alsono A, Villamor J. Spirometric reference equations for European females and males aged 65-85yrs. *Eur Respir J* 2004;24: 397-405

7 RESULTS AND DISCUSSION

7.1 INTRODUCTION

This chapter consists of results and discussion relating to the three main experiments to achieve the aims set out in Chapter 1. We have subdivided our results into three sections, Sections A, B and C. Section B is subdivided further into B1, B2 and B3. The heading of each section is as follows.

Section A:

The spirometric findings of smokers compared to non-smokers.

Section B:

1. The effects of age on FEV_1/FVC and FEV_1/FEV_6
2. The effects of the degree of airway patency on FEV_1/FVC and FEV_1/FEV_6
3. Comparison of the FEV_1/FEV_6 ratio to the FEV_1/FVC ratio in its ability to accurately diagnosis airways obstruction.

Section C:

Comparison of two different sets of FEV_6 reference equations and the ability of each set to detect airways obstruction in a group of elderly patients

Each section begins with a brief summary of the aim of the study, a table(s) of results, a discussion of results, and a brief summary. The methodology and statistical method used for each study is outlined in Chapter 6.

SECTION A

7.2 THE SPIROMETRIC FINDINGS OF SMOKERS COMPARED TO NON-SMOKERS

7.2.1 AIM OF STUDY

The aim of this study is to investigate whether a significant difference exists in the spirometric parameters of smokers compared to non-smokers. Among the parameters are the FEV₆ and the FEV₁/FEV₆ ratio. Smoking has been found to be a strong independent risk factor for the development of chronic obstructive pulmonary disease (COPD), and a high proportion of COPD patients are smokers¹. Cigarette smoking in particular has been documented in numerous cross-sectional and longitudinal studies to be an important determinant of the level of lung function reduction.^{2,3,4} However, other factors increase the likelihood of developing COPD and include passive exposure to tobacco smoke⁵, air pollution⁶, history of childhood respiratory infections⁷, presence of airway hyper-responsiveness⁸, alpha-1 antitrypsin deficiency⁹, and occupational inhalation hazards¹⁰. Spirometry testing has the ability to identify mild airflow abnormalities in asymptomatic smokers. In particular, a reduction in the FEV₁/FVC ratio has been shown to be a strong predictor for rapid progression of COPD¹¹ in subjects with a 'normal' FEV₁¹². All subjects in this study had an FEV₁/FVC and an FEV₁ of greater than 75% predicted.

In this study we hypothesised that by including data from patients with 'normal' spirometry, subtle differences in lung function between smokers and non-smokers may be detected. In particular we chose to investigate if the FEV₆ parameter could provide any additional information regarding early airway changes in subjects 'at risk' of developing COPD, our smoking group. We also looked at the possibility of a gender difference in susceptibility to smoking. The values presented in tables 7.1, 7.2, 7.3 and 7.4 are mean percent-predicted (\pm standard deviation) for smokers and non-smokers.

7.2.2 RESULTS

In this study the results presented in table 7.1 show the mean age of the non-smoking group to be 54.4 years (SD 16.3) and BMI 27.2 (SD 5.1), with the mean age of the smoking group 53.6 (13.7) years and mean BMI 26.9 (5.1). The mean percent predicted FVC of non-smokers is 92% (SD 12.1) and in smokers, this was found to be 94% (SD 10.6). The mean FEV₆ of the non smoking group is 93% (SD 12.3), and in the smoking group is 94% (SD 10.3). The FEV₁/FEV₆ ratio of non-smokers yielded the same mean % predicted as the FEV₁/FVC, 99%. However, the FEV₁/FEV₆ standard deviation value was slightly lower 6.08 compared to a SD of 7.4 for the FEV₁/FVC ratio. In smokers both FEV₁/FVC and FEV₁/FEV₆ had a mean percent predicted of 96% but again the FEV₁/FEV₆ ratio produced a lower SD of 6.0 compared to a SD of 7.6 for FEV₁/FVC in this group. The mean forced expiratory time of smokers was 9.4 (2.5) seconds and non-smokers 8.5 (2.2) seconds.

TABLE 7.1 DEMOGRAPHICS AND SPIROMETRY DATA OF NON-SMOKERS AND SMOKERS

Parameter	Non- Smokers n= 178 (111 female)	Smokers n=156 (91 female)	P value
FVC	92.3±12.1	93.9±10.6	0.218
FEV ₆	93.1±12.3	93.9±10.3	0.545
FEV ₁ /FVC	99.8±7.4	96.2±7.6	0.0001***
FEV ₁ /FEV ₆	99.1±6.1	96.3±6.0	0.0001***
FET (seconds)	8.5±2.2	9.4±2.5	0.0007***
FEF _{25-75%}	93.2±28.2	82.5±26.2	0.0004***
AGE (years)	54.4±16.3	53.6±13.7	0.648
BMI (kg m ²)	27.2 ± 5.1	26.9 ± 5.1	0.590
Values presented above are mean % predicted ± SD			

In Table 7.2 our results show that among our total smoking group 67 patients smoked on average less than twenty cigarettes a day, and 89 patients admitted smoking greater than 20 cigarettes a day. All mean percent predicted spirometric values are lower in the > 20 per day group compared to the < 20 per day group, but the statistical difference was not significant.

Smokers who consumed > 20 cigarettes per day were on average 4 years older 55(13.3) years compared to an average age of 51(14.2) years for patients with a < 20 per day habit.

TABLE 7.2 SMOKERS WITH <20 AND > 20 CIGARETTES SMOKED/DAY

	Smokers < 20/day (n = 67)	Smokers > 20/day (n = 89)	p value
FVC	95.0±11.1	93.1±10.0	0.287
FEV ₆	95.0±10.5	93.1±10.0	0.266
FEV ₁ /FVC	96.7±8.0	95.9±7.3	0.532
FEV ₁ /FEV ₆	97.0±6.1	96.1±6.0	0.590
FEV ₁	92.0±12.2	89.6±10.6	0.193
FEF _{25-75%}	85.4±27.4	80.4±24.9	0.244
FET	9.4±2.6	9.4±2.4	0.884
AGE	51.6±14.1	55.2±13.3	0.109
BMI	26.5±4.8	27.2±5.7	0.386

In Table 7.3 our results show a similar number of male smokers (n = 67) and male non-smokers (n = 65). Male smokers were on average slightly older, 51(12.8) years, than male non-smokers, 48(17.0) years, and had longer forced expiratory times 9.75(2.5) seconds compared to 8.48(2.3) seconds. Both FEV₁/FVC and FEV₁/FEV₆ ratios were significantly lower in male smokers than in male non-smokers. The mean FEF_{25-75%} in male smokers was 85% (26) compared to 93% (26) for male non-smokers.

TABLE 7.3 MALE SMOKERS AND NON-SMOKERS

Parameter	Male non-smokers n = 67 (mean ± SD)	Male smokers n = 65 (mean ± SD)	p value
FVC	92.3±12.8	92.9±9.3	0.756
FEV ₆	93.3±12.5	93.5±9.2	0.907
FEV ₁ /FVC	100.0±6.9	96.7±7.8	0.0115*
FEV ₁ /FEV ₆	99.0±5.5	96.3±6.3	0.0083**
FEF _{25-75%}	93.5±26.1	85.0±26.0	0.05
FET	8.5±2.3	9.8±2.6	0.010**
AGE	48.3±17.0	50.9±12.8	0.326

In Table 7.4 results on female smokers (n = 91) and female non-smokers (n = 111) show that female smokers have mean percent predicted FEV₁/FVC, FEV₁/FEV₆, FET and FEF_{25-75%} that are lower than female non-smokers, by a statistically significant difference, represented by a p value < 0.05.

TABLE 7.4 FEMALE SMOKERS AND NON-SMOKERS

Parameter	Female non-smokers n= 111 (mean ± SD)	Female smokers n = 91 (mean ± SD)	p value
FVC	92.2±12.3	94.6±11.3	0.161
FEV ₆	92.9±12.2	94.2±11.0	0.465
FEV ₁ /FVC	99.6±7.7	95.9±7.5	0.0007***
FEV ₁ /FEV ₆	99.0±6.4	96.3±5.9	0.0024**
FEF _{25-75%}	92.9±29.4	80.8±26.0	0.003**
FET	8.5±2.1	9.3±2.40	0.012*
AGE	58.2±14.4	55.6±14.1	0.205
BMI	27.6 ±5.4	26.5 ±5.6	0.157

7.2.3 DISCUSSION

Subjects tested were all patients referred to the pulmonary function laboratory for various clinical reasons. A proportion of this study group had suspected pulmonary disease and cannot be strictly classed as a 'normal' population. However the selection process ensured that only 'normal' spirometry data were included for both groups. Details on selection process and analysis are given in Chapter 6.

When statistical analysis was applied to the data, in the form of the non-parametric student's t-test, subject age and body mass index (BMI) were found to be comparable between both groups. We found no statistically significant difference between smokers and non-smokers in FVC and FEV₆ values. The average FEV₆ parameter expressed as a percent of predicted for both groups showed a very close agreement with its corresponding FVC, but did not offer any additional information regarding possible early signs of change in lung function in the current smoking group. Regardless of smoking history the FEV₁/FEV₆ ratio did exhibit a lower standard deviation (SD) value indicating that this parameter is a less variable, more definite end of test point compared to the FEV₁/FVC ratio.

In a group of middle aged men and women, mean age 54(15) years having performed spirometry testing for various clinical reasons we found a significantly lower FEV₁/FVC, FEV₁/FEV₆, FEF_{25-75%} and FET in smokers compared to non-smokers. Both ratios FEV₁/FVC and FEV₁/FEV₆ were reduced in the smoking group compared to the non-smoking group. From a clinical viewpoint, both smokers and non-smokers in our study have ratios that would be considered well 'within normal limits'¹³, (Table 7.1). However for the same mean age (smokers 53 years, non-smokers 54 years) the smoking group may be beginning to exhibit an earlier decline in lung function compared to non-smokers as shown by the FEV₁/FVC, FEV₁/FEV₆ ratios.

We can also see from this study that the FEV_1/FEV_6 ratio declines in a similar manner to the FEV_1/FVC ratio regardless of smoking habit. This finding would suggest that given similar readings the shorter FEV_6 manoeuvre could be used successfully as a surrogate for the FVC manoeuvre.

The lower SD scores of the FEV_1/FEV_6 ratio also suggest that this shorter manoeuvre has less variability. Reducing the variability of this type of measurement may lead to a more accurate interpretation of the measurement and result in a lower misclassification rate when it comes to classifying spirometry results as normal or abnormal.

In this study, further evidence of an earlier decline in lung function in smokers with a normal FEV_1/FVC and FEV_1/FEV_6 ratio can be seen in the reduced $FEF_{25-75\%}$. The majority of studies into the effects of smoking on lung function have focused on FEV_1 ^{14,15,16}. However, effects may also be revealed in other measures of lung function such as the $FEF_{25-75\%}$. This parameter is a measure of the average flow rate between 25% and 75% of the forced vital capacity, and flow rates from this portion of the FVC specifically reflect the patency of airways < 2 mm in diameter, called the peripheral small airways. The significance of a reduced $FEF_{25-75\%}$ has been investigated in other studies and although this parameter has a wide variability (reflected in this study by a large SD value), it has been suggested to be an early indicator of small airways disease in subjects who have otherwise normal lung function as assessed by means of FEV_1 and FEV_1/FVC ¹⁷. Early studies into small airways dysfunction revealed that COPD affects the small peripheral airways in its sub-clinical early phase¹⁸.

The $FEF_{25-75\%}$ parameter is significantly reduced in our smoking group, despite this group having 'normal' ratios. As airflow limitation prolongs the forced expiratory time (FET), the longer FET in the smoking group may reflect early closing of the peripheral airways and possibly the significantly reduced $FEF_{25-75\%}$.

Despite the subtle early differences seen in this study, a longitudinal study of these patients is warranted to properly assess if the smokers have a greater risk of a rapid decline in lung function heralding early COPD.

Previous longitudinal studies documented that the FEV₁/FVC ratio is a strong predictor for rapid progression of COPD in smokers¹⁹ and recently a study by Enright et al showed that the FEV₁/FEV₆ ratio could also predict lung function decline in adult smokers²⁰.

Other studies into early detection of COPD through spirometry testing have included data on the effects of smoking consumption in the form of pack-years. In our study we did not have access to pack years data, but were able to record the average number of cigarettes each smoker admitted to smoking per day. These data are included in Table 7.2 and our results show no statistically significant difference in either demographic or spirometric parameters in the smoking group, as between those smoking on average greater than 20 cigarettes per day and those smoking less than 20 cigarettes per day. Other studies in this area have found evidence that the number of cigarettes smoked has a linear effect on pulmonary function level and rate of loss. In particular a cross-sectional analysis in the Six Cities Study^{21, 23} showed that in comparison to ex-smokers, current smokers had lower levels of lung function as measured by spirometry. The subjects included in our study were a mixture of male and female current smokers and never smokers. To investigate if gender played a role in the differences between smokers and non-smokers with regard to spirometry values we compared male smokers to male non smokers and female smokers to female non smokers using student's t-tests for statistical significance, the results of which are shown in tables 7.3 and 7.4.

As shown in tables 7.3 and 7.4 the same parameters, FEV_1/FVC , FEV_1/FEV_6 , $FEF_{25-75\%}$ and FET that showed a statistically significant difference in our total smokers compared to non-smokers group (table 7.1) also showed a statistically significant difference in our comparison of male smokers to non-smokers and female smokers to non-smokers.

This finding suggests that gender did not give any additional information regarding subtle differences in smokers and non-smokers in our limited study group. However the male non-smokers were younger than the male smokers whereas the female non-smokers were older than the female smokers and this finding may be evidence for the claim that women are taking up smoking at a younger age. In a study of Irish teenagers, researchers found that 20.7% of young teenagers actively smoke and significantly more females than males do so²².

Several longitudinal studies have been published on gender differences in the susceptibility to cigarette smoking, but there is little clarity, as some studies show the reduced level of lung function associated with cigarette smoking to be greater in men than in women^{23, 24} and other studies report that women are more susceptible^{25, 26}.

7.2.4 SUMMARY

The initial aim of this study was to investigate if parameters from the shorter six-second spirometry test could provide early signs of airways obstruction heralding the beginning of COPD in a group of patients at risk for developing this disease due to their smoking habits. Our results showed that the FEV_6 parameters did not provide any additional information to that already obtained from the traditional FVC parameters, however the FEV_1/FEV_6 ratio did decline in the same manner as the FEV_1/FVC ratio in smokers compared to non-smokers of similar age and demographics. We also found that the FEV_6 parameters and in particular FEV_1/FEV_6 ratio had a lower standard deviation than

the FEV₁/FVC ratio, suggesting that this parameter may be a more accurate and reproducible measurement.

Given this finding the shorter FEV₆ manoeuvre could be an attractive shortcut to the traditional FVC spirometry manoeuvre. A shorter manoeuvre would reduce the burden of the test for those patients with prolonged forced expiratory times and in elderly subjects.

7.2.5 HYPOSTASIS

To further investigate if the shorter FEV₆ manoeuvre could be an alternative to the traditional FVC manoeuvre, we compared the FEV₁/FEV₆ ratio to the FEV₁/FVC ratio in their ability to diagnose airways obstruction using reference equations with lower limits of normal. The results of this study are set out in section B.

SECTION B

7.3 A COMPARISON OF FEV₁/FEV₆ WITH FEV₁/FVC IN DIAGNOSING AIRWAYS OBSTRUCTION

7.3.1 AIM OF STUDY

The initial aim of this study was to compare the FEV₁/FEV₆ ratio to the traditional 'gold standard' FEV₁/FVC ratio to determine its ability to detect airways obstruction. We compared each ratio with its corresponding lower limit of normal value which was taken from a reference set that included equations for both the traditional FVC and the 'new' FEV₆ parameters. Detailed equations and lower limits of normal used in this study can be found in appendix F. Using the spirometric data obtained from patients included in this study we were able to investigate the behaviour of both FEV₁/FVC and FEV₁/FEV₆ with increasing age and decreasing airways patency. These two studies are presented in sections B1 and B2 respectively.

7.3.2 RESULTS FROM SPIROMETRY DATA

In order to assess the ability of the FEV₁/FEV₆ ratio in diagnosing airways obstruction we examined spirometry data from a sample of our patient population. The subject demographics for ninety-nine subjects included in this study are presented in table 7.5. Mean (SD) age was 56.3(14.6) years and the mean (SD) forced expiratory time (FET) for the group was 9.4(2.8) seconds. Of the total number of patients included in this study forty-four were male and fifty-five female. The mean (SD) Body Mass Index (BMI) was 26.6(5.5) and mean (SD) height was 167(9.8) cm. We also looked at smoking habits of the group and found that 45 were non-smokers, 46 were ex-smokers, and 8 were current smokers. Of the current smokers seven out eight were female.

TABLE 7.5 SUBJECT DEMOGRAPHICS

Subject Demographics	Mean ± SD
Age (years)	56.3 ± 14.6
Age range	42 -70
Height (cm)	167 ±9.8
BMI (kg/m ²)	26.6 ± 5.5

TABLE 7.6 SPIROMETRY DATA

Spirometry Parameter	Mean ± SD
FVC %predicted	82.2 ± 16.5
FEV ₆ %predicted	81.7 ± 18.5
FEV ₁ %predicted	76.9 ± 22.5
FEV ₁ /FVC %	91.8 ± 15.7
FEV ₁ /FVC measured	71.4 ± 12.6
FEV ₁ /FEV ₆ %	92.5 ± 11.7
FEV ₁ /FEV ₆ measured	74.5 ± 9.8
FEF _{25-75%} predicted	71.3 ± 39.8
FET	9.4 ± 2.8
Mean difference in FEV ₁ /FVC and FEV ₁ /FEV ₆ ratios expressed as measured values	3.1
Inter-subject CoV	
FEV ₁ /FVC %	17.2%
FEV ₁ /FEV ₆ %	12.7%

Spirometry data

In table 7.6, a mean and standard deviation (SD) was calculated for each of the parameters. The standard deviation represents a measure of dispersion or variability in the data set. The higher the SD figure the greater the spread of values is around the mean value. The degree of variation about the measurement for the group is called the inter-subject coefficient of variation (CoV). In this study the mean inter-subject CoV for FEV₁/FVC was 17.2% and for FEV₁/FEV₆ was 12.7%.

7.3.3 DISCUSSION

This reduced variability in the FEV₁/FEV₆ ratio is likely attributed to the FEV₆ end-of test-point. An explicitly defined end-of-test of six seconds duration tends to increase the accuracy of the expired volume measurement. Therefore, with the FEV₆ manoeuvre terminating the expired volume at exactly six seconds duration variability surrounding the end of test volume is reduced. Guidelines on spirometry interpretation^{27,28} recommend that only reference equations that are technically and biologically appropriate for the population being studied are to be used, as any difference occurring between the methods in which the reference value and the actual measured value were obtained can lead to errors in interpretation. Therefore given that the shorter FEV₆ manoeuvre has the potential to produce more accurate spirometry results as seen in the reduced CoV (table 7.6), interpretation of spirometry results from this type of manoeuvre should only be carried out with the appropriate FEV₆ reference equations.

STUDY B1

7.4 THE EFFECTS OF AGE ON THE FEV₁/FEV₆ AND FEV₁/FVC RATIOS

7.4.1 AIM OF STUDY

In Table 7.5 the patients included in our main study of the comparison of FEV₁/FEV₆ to FEV₁/FVC in diagnosing airways obstruction had an age range from 42 to 70 years and we therefore choose to look at the effects that age has on the FEV₁/FVC and FEV₁/FEV₆ ratios.

7.4.2 RESULTS

The mean measured FEV₁/FEV₆ and FEV₁/FVC values by age categories are given in table 7.7

TABLE 7.7 MEAN FEV₁/FVC AND FEV₁/FEV₆ BY AGE CATEGORIES

Age years (± SD)	N	FEV ₁ /FVC (± SD)	FEV ₁ /FEV ₆ (± SD)	Δ (ml)	FET (± SD)	p- value
20-29 (± 3.7)	4	78.2 (± 11.1)	78.5 (± 11.4)	0.25	7.0 (±0.5)	0.979
30-49 (± 5.7)	24	76.5 (± 9.0)	78.2 (±7.4)	1.6	8.7 (±2.8)	0.500
50-69 (± 5.0)	49	71.1 (± 11.5)	75.0 (± 8.4)	3.9	10.0 (±2.8)	0.184
70-89 (± 3.8)	22	64.4 (± 14.8)	68.4 (± 11.5)	3.9	9.8 (±3.0)	0.341

Δ = absolute difference between both ratios expressed in ml

Values for FEV₁/FVC and FEV₁/FEV₆ reported are mean measured values.

Values for FET are mean average values reported in seconds.

Both ratios show a decline with increasing age and increasing forced expiratory time (FET). The mean difference between the FEV₁/FVC and FEV₁/FEV₆ ratios was found to increase with age from a difference of only 0.25 ml in the younger age bracket 20-29 years to a mean difference of 3.9 ml in subjects aged > 50years. We found no statistically significant difference between both ratios, p<0.05.

When the data are expressed in graphical form, it is easier to see the decline in both ratios with increasing age. The mean FEV₁/FVC and FEV₁/FEV₆ ratios are plotted for each age category in Figure 7.1.

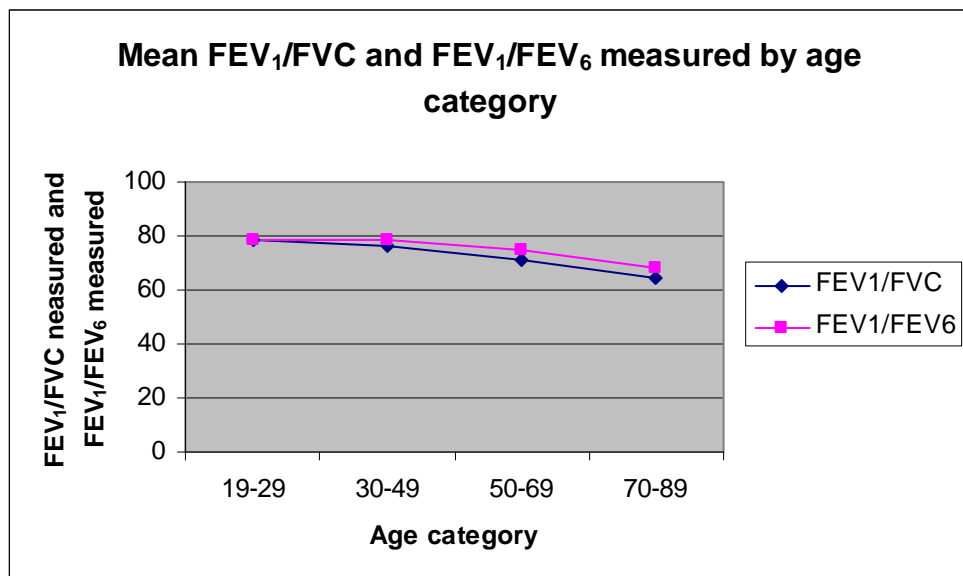

FIGURE 7.1 MEAN MEASURED FEV₁/FVC AND MEAN MEASURED FEV₁/FEV₆ IS PLOTTED FOR EACH AGE CATEGORY

7.4.3 DISCUSSION

Maximum lung function is reached at approximately 20 years of age in females and 25 years of age in males²⁹. This is due to the fact that girls reach puberty and attain their maximum lung size earlier than boys of similar age. In males after puberty, although growth in stature may cease, growth in lung capacity continues for some years due to the continued growth of the thorax²⁹. Lung function has been shown in numerous cross sectional and longitudinal studies to decline naturally with age^{30,31}, and therefore the

decline in both ratios seen in this study with increasing age is not unexpected. The normal annual decline in healthy never-smoking adults 35-65 years old has been determined to be on average 30 ml/year³². In elderly subjects this age related decline is accelerated^{33,34} and can be seen very readily in studies which are conducted for the purpose of creating reference equations. Such studies incorporate large numbers of healthy individuals of both sexes and represent a wide spectrum of ages.

A recent study establishing predicted reference values for elderly subjects³⁵ reported that the annual decline in FEV₁ values for healthy elderly females was 32 ml/year and for healthy elderly males of 44 ml/year. The same study also predicted the FEV₁/FVC ratio to decline with increasing age from a value of 80% to 70% predicted in females and from 79% to 73% predicted in males to the lower limits of normal from 71% to 68% and from 70% to 64% respectively. In another large reference based study conducted in the United States called the National Health and Nutrition Survey III³⁶, analysis of some 74,294 healthy subjects revealed a slower decline with age with FEV₁/FEV₆ than with FEV₁/FVC.

Our results mirror these findings showing a less steep decline in FEV₁/FEV₆ at all ages compared to FEV₁/FVC, (Figure 7.1). Our results also show that the FEV₁/FVC ratio declines with the duration of expiratory effort as indicated in the forced expiratory time (FET). This finding reflects how the FVC measurement depends on the time taken to empty the lungs forcefully. Longer expiratory times were needed to obtain the FVC measurement in subjects over fifty years of age. The age related decline in lung function can be accounted for by factors associated with ageing such as loss of elastic recoil of the lung that occurs naturally with age. Studies of the effects of ageing on the human lung have found that with healthy individuals the elastic recoil pressure decreases as age increases^{37,38}. Ageing also brings about changes in the respiratory system and each change plays a part in the natural decline of the lung function parameters FEV₁ and FVC

and hence the ratio FEV_1/FVC . These changes include the chest wall becoming stiffer with age. This stiffness is termed reduced compliance, and may be linked to calcification in the rib bones and the general geometric changes that occur to the rib cage and thorax with increasing age.

Structural changes also affect the force generating capacity of the diaphragm, the main muscle used in respiration and coupled with deficient nutritional status that comes with age, serve to reduce overall respiratory muscle strength and hence the ability to generate expiratory force. The principal cause of age-related decline in lung function is attributed to the nature of the tissues that make up the lung and airways called elastic and collagen fibers in the lung parenchyma. It is the inherent elasticity of the lungs that allows expansion on inspiration and enables them to spring back into shape on expiration. The force used here is called the elastic recoil pressure, and ageing causes this recoil to diminish, brought on by degeneration or changes in the arrangement of the elastic fibers.

During forced expiration in elderly subjects the chest wall is stiffer and the lungs are less elastic allowing inspired air to become trapped within the lungs. This causes the residual volume (RV) of the lung to increase and in doing so compromises the overall vital capacity and increases the functional residual capacity (FRC). When air is forced from the lungs of an elderly subject the natural degeneration of the fibers that support the walls of the airway cause the small airway ($< 2\text{mm}$) collapse or close more prematurely than they would in younger lungs. This closure or airway narrowing prolongs the expiratory time (FET) required to reach the FVC and in turn increases the variability of the FVC measurement. This is reflected in the results shown in table 7.6, the FVC parameters with larger standard deviations than the FEV_6 parameters, and the variability in the measurement as reflected by the larger SD increases with increasing age.

7.4.4 SUMMARY

This study showed that both FEV_1/FVC and FEV_1/FEV_6 decrease with age, and the difference between ratios is more pronounced the older the individual. The results of this study also demonstrate the longer the forced expiratory time the greater the difference between ratios. We looked at the effects of airway patency on both ratios in section B2.

STUDY B2

7.5 THE EFFECTS OF THE DEGREE OF AIRWAY PATENCY ON THE FEV₁/FEV₆ AND FEV₁/FVC RATIOS

7.5.1 AIM OF STUDY

The FEV₁/FVC ratio is widely used in clinical practice to determine if an obstructive ventilatory effect is present and is a measure of the degree of airway narrowing that occurs during a forced expiratory manoeuvre³⁹. Using the spirometric data from patients included in our main study of the comparison of FEV₁/FEV₆ to FEV₁/FVC in the spirometric diagnosis of airways obstruction, we investigated the difference between both ratios as the patency of the airway decreases.

7.5.2 RESULTS

In table 7.8 the absolute difference between the FEV₁/FVC and FEV₁/FEV₆ ratio and the corresponding forced expiratory time in four distinct categories based on the degree of airway patency as defined by FEV₁/FVC are shown.

The mean difference between the measured FEV₁/FVC and FEV₁/FEV₆ becomes greater the more narrow the airways become, as reflected by a decreasing FEV₁/FVC ratio from a difference of only 0.6 in subjects with an FEV₁/FVC of greater than 80 to a difference of 11.2 in subjects with an average FEV₁/FVC of less than 50. There is also a concomitant increase in the forced expiratory time from 7.2 (0.96) seconds to 15.2 (0.93) seconds. When these data are expressed in graphical form the decline in both ratios with decreasing airway patency is very apparent. The mean FEV₁/FVC and FEV₁/FEV₆ ratios are plotted for each value of FEV₁/FVC in Figure 7.2

TABLE 7.8 FEV₁/FVC, FEV₁/FEV₆ AND MEAN FET BY DEGREE OF AIRWAY PATENCY AS DEFINED BY THE FEV₁/FVC RATIO

Airway patency	FEV₁/FVC (± SD)	FEV₁/FEV₆ (± SD)	Difference	FET (± SD)	p-value
>80 (n =24)	83.8 (±2.9)	84.4 (±2.6)	0.6	7.2 (±1.0)	0.4450
70-80 (n = 44)	75.5 (±2.9)	77.6 (±2.7)	2.1	8.7 (±2.0)	0.0005***
50-69 (n = 23)	63 (±5.0)	67 (±3.6)	4.0	10.6(±2.6)	0.0005***
< 50 (n =8)	39 (±4.5)	50.2 (±3.2)	11.2	15.2(1±0.9)	0.0001***

FEV₁/FVC and FEV₁/FEV₆ above are represented as mean measured values.

Values for FET are mean average values reported in seconds.

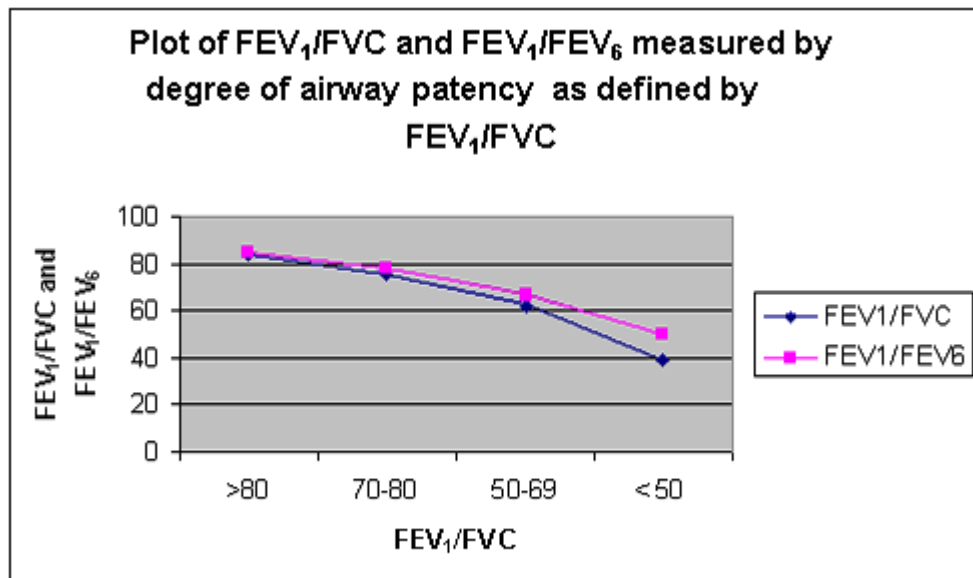

FIGURE 7.2 MEASURED FEV₁/FVC AND FEV₁/FEV₆ BY THE DEGREE OF AIRWAY PATENCY AS DEFINED BY THE FEV₁/FVC RATIO

7.5.3 DISCUSSION

The FEV₁/FVC represents the proportion of air that can be exhaled from the lungs in the first second of a forced expiratory manoeuvre in relation to the maximum volume of air that can be expelled from the lungs. The amount expired in the first second is a constant fraction of that which can be maximally exhaled. The difference between FEV₁/FVC and FEV₁/FEV₆ becomes more pronounced the more reduced the FEV₁/FVC becomes, from a difference of 0.6 in the group with an FEV₁/FVC ratio of > 80, to a difference of 11.2 in the group with an FEV₁/FVC ratio of <50, there is also a concomitant increase in the time taken to empty the lungs forcefully (FET), 7.2 seconds to 15.2 seconds respectively.

These results clearly show that the more reduced the patency of the airways the longer the FET becomes and this can be attributable to a number of factors. With a reduced airway patency known as airflow obstruction the diameter of the airways affected is narrowed due to excess mucous production and inflammation of the surrounding airway wall. This narrowing may also be due to a reduced elastic recoil pressure as discussed earlier which can cause the small airways to narrow early in the forced expiration, leading to a longer forced expiratory time. The significant difference observed in our limited study between ratios in the case of decreasing airway patency has the potential of causing misclassification when it comes to interpreting spirometry results.

In some subjects with airways obstruction the time taken to reach the 'end-of-test criterion' is prolonged well beyond six seconds and the more pronounced the difference between the FEV₆ end of test and the FVC end-of-test point will be.

Figure 7.3 shows a sample volume time curve to illustrate the difference between a FVC manoeuvre and a FEV₆ manoeuvre.

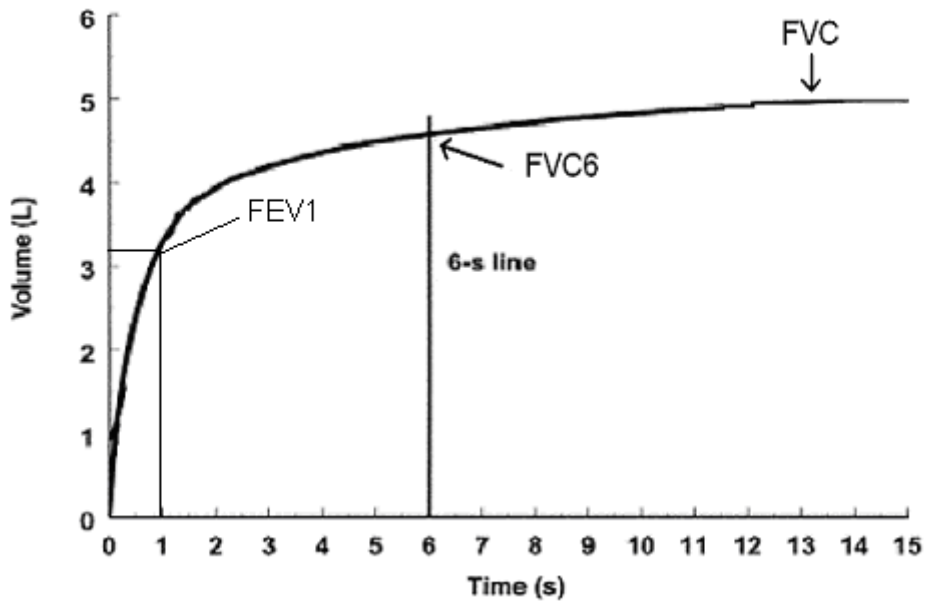

FIGURE 7.3 SPIROGRAM DEPICTING THE DIFFERENCE BETWEEN THE TWO END OF TEST POINTS FVC AND FEV₆

In this example the time taken to forcefully exhale a vital capacity breath is approximately 14 seconds, giving an FVC in this example of 4.9 litres. If the curve is truncated at six seconds (vertical line at 6 seconds) as would be the case in the shorter six second manoeuvre, the resulting forced expiratory volume at six seconds (FEV₆) is 4.6 litres. The forced expiratory volume after one second of exhalation (FEV₁) is 3.3 litres and this is the same regardless of the type of manoeuvre used. The FEV₁/FVC ratio is calculated to be 67 but the FEV₁/FEV₆ ratio due to the smaller denominator is greater at 72, therefore the shorter FEV₆ manoeuvre could underestimate the degree of airway patency and so create a false negative interpretation. However the potential for misclassification should be minimised if the correct reference values that have been derived from the same type of manoeuvre are used.

Interpretation of spirometry employs reference equations that are appropriate both to the measurement and to the population being studied. Clinical practice guidelines for spirometry interpretation endorse the use of the appropriate reference equations and

lower limits of normal to accurately define airflow obstruction⁴⁰. If the appropriate reference equations with well described lower limits of normal are used the difference between a manoeuvre lasting six seconds and the longer FVC manoeuvre will be accounted for. This was investigated by Demir et al⁴¹, who found in a study of 5,114 subjects that among those with an FEV₁/FVC ratio of less than 70, only 86% also had an FEV₁/FEV₆ less than 70, and that the mean difference between FEV₁/FVC and FEV₁/FEV₆ expressed as percentages increased from approximately 4 to 9 when FEV₁/FVC decreases from 70% to 50%. They found that if this difference is taken into account using appropriate reference equations for FEV₁/FEV₆, then the FEV₁/FEV₆ ratio from the shorter FEV₆ manoeuvre is as good a predictor of airways obstruction as the traditional longer FEV₁/FVC.

7.5.4 SUMMARY

We found in this study that a reduced airway patency causes a prolonged average FET. The longer the FET the greater the difference between the ratios FEV₁/FVC and FEV₁/FEV₆. However as other studies have pointed out, using the correct reference equations and lower limits of normal, FEV₁/FEV₆ may be used as a surrogate for FEV₁/FVC despite having a fixed shorter FET. This was investigated in our study population and the results are presented in Section C of this chapter.

SECTION B3

7.6 FEV₁/FEV₆ COMPARED TO FEV₁/FVC IN THE SPIROMETRIC DETECTION OF AIRWAYS OBSTRUCTION

7.6.1 AIM OF STUDY

The importance of a diagnostic test is its ability to give the correct diagnosis. It is unlikely that any diagnostic test is ever accurate all of the time. The diagnostic test of the FEV₁/FEV₆ ratio, to be useful must be sensitive enough to determine the correct diagnosis of airways obstruction in the substantial majority of cases. In this study the diagnostic ability of FEV₁/FEV₆ in identifying airways obstruction was tested by comparison with the 'gold standard' FEV₁/FVC ratio. Patients were classified into two distinct groups according to the presence or absence of airways obstruction as defined by a FEV₁/FVC and a FEV₁/FEV₆ above or below their respective lower limit of normal values. Results are presented in table 7.9.

7.6.2 RESULTS

Twenty six out of the ninety nine subjects included in this study had a diagnosis of airways obstruction confirmed by both FEV₁/FVC and FEV₁/FEV₆ and seventy one subjects had a diagnosis of no airways obstruction confirmed by both ratios. There were two cases where the diagnosis of airways obstruction differed between ratios, these were called discordant cases. One subject was diagnosed as having airways obstruction by the FEV₁/FVC ratio alone and the other was diagnosed as having airways obstruction by the FEV₁/FEV₆ ratio alone. Sensitivity for the group was calculated to be 96%, specificity 98%, positive predictive value 95% and a negative predictive value of 98%.

TABLE 7.9 DIAGNOSIS OF AIRWAYS OBSTRUCTION USING PRECISE LOWER LIMITS OF NORMAL FOR FEV₁/FVC AND FEV₁/FEV₆

FEV₁/FVC			
	Obstruction	No Obstruction	Total
FEV₁/FEV₆ Obstruction	26	1	27
FEV₁/ FEV₆ No Obstruction	1	71	72
Total	27	72	99
Sensitivity: 96.3%, Specificity: 98.6%, Positive predictive value (PPV): 95.6% Negative predictive value (NPV): 98.8%			

7.6.3 DISCUSSION

The proportion of patients with airways obstruction who were correctly diagnosed by the FEV₁/FEV₆ ratio (sensitivity) is 96.3% and those with no airways obstruction who were correctly identified by the FEV₁/FEV₆ ratio (specificity) is 98.6%. Therefore, in these patients we would expect 96.3% of patients with airways obstruction to be correctly identified by the FEV₁/FEV₆ ratio while 98.6% would be correctly identified as not having airways obstruction by the same ratio. If a patient is confirmed as having airways obstruction by the gold standard FEV₁/FVC ratio there is a 96.3% probability that the same patient would also be confirmed as having airways obstruction using the FEV₆ manoeuvre. In this study the use of the FEV₆ manoeuvre in predicting abnormality was also calculated and given as positive predictive value (PPV) and negative predictive value (NPV) in table 7.4. A PPV of 95.6% represents the proportion

of patients with airways obstruction for which the FEV₆ manoeuvre correctly identified them as having airways obstruction. A NPV of 98.8% shows the proportion of patients without airways obstruction which the FEV₆ manoeuvre correctly identified. The calculation of these predictive values is highly dependant on the prior probability of disease in the population being studied. This is known as disease prevalence. The prevalence of obstruction in this study population was calculated to be 24/99 (24%). This meant that before applying the above diagnostic accuracy test; there was a prior probability (24% chance) that a given patient would have airways obstruction.

These results confirm that replacement of the FVC ‘gold standard’ manoeuvre with a shorter FEV₆ manoeuvre and the use of proper reference equations in our patient population would not diminish the diagnostic accuracy of the spirometry test in identifying airways obstruction. The sensitivity of the FEV₆ method of 0.96 means that if a patient is confirmed as having airways obstruction by the gold standard FVC method there is a 96% chance that that same patient will also be diagnosed as having airways obstruction by the FEV₆ method. Consequently, this leaves 4% of the subjects studied who may be classified as not having airways obstruction, despite having the disorder. The specificity result of 0.98 on the other hand provides the scenario that a subject may be identified as not having airways obstruction by the FVC method there is a 2% chance that the same subject may be identified as having airways obstruction by the FEV₆ method. An example of this method in practice is shown in table 7.9 for two cases reported where the two ratios under investigation produced two differing diagnose or discordant cases.

DISCORDANT CASES

The spirometry test results for two patients were classified differently by the two ratios; however both had observed values close to their respective lower limits of normal.

Subject characteristics and spirometry data are presented in Table 7.10. In the first discordant case the FEV₁/FVC was above its corresponding lower limit of normal and therefore no airways obstruction was deemed to be present. FEV₁/FEV₆ was at its lower limit of normal value and in clinical practice this subject would be deemed to have airways obstruction. In the second discordant case the FEV₁/FVC ratio classified an obstructive ventilatory pattern as the measured value was at the lower limit of normal but the FEV₁/FEV₆ was above its lower limit of normal and therefore airways obstruction was deemed to be absent in this subject by this ratio.

TABLE 7.10 DISCORDANT CASES

Subject	Age (years)	FET (seconds)	Gender	FEV₁/FVC (LLN)	FEV₁/FEV₆ (LLN)
1	62	6.5	Female	69 (64)	69 (69)
2	63	12.2	Male	65 (65)	72 (70)
LLN refers to lower limit of normal Difference refers to the measured value minus the lower limit of normal. Age is in years Forced expiratory time (FET) is in seconds					

Both discordant cases have ratios that lie close to their lower limits of normal and therefore should be interpreted with caution. The day-to-day variation that occurs in spirometric measurements could shift the results across the lower limit of normal value.

Lung function has been shown to exhibit both diurnal and seasonal variation due to factors such as cyclical changes in blood cortisol and adrenaline levels, ambient temperature, airways resistance sleep patterns, posture, meals and hormone production in females⁴². Reported significant changes in FVC and FEV₁ for normal subjects within a day are 5%, this variability has been shown to increase to 13% for patients with chronic obstructive pulmonary disease. The equivalent weekly variation in these two

spirometry parameters is 11% and 20% respectively^{43,44}. In the context of the results seen in this study and in particular in the two discordant cases shown in table 7.6, results that lie close to their lower limit of normal can easily shift across this lower limit of normal threshold and be subject to a different diagnosis. Joint American Thoracic and European Respiratory Society guidelines on lung function interpretation recommend caution when interpreting spirometry results that lie close to the lower limit of the reference range and recommend clinical history and prior probability of disease as adjuncts in making a definitive diagnosis in these circumstances. The results of this study are similar to two other large studies published on this same topic. Compared to Swanney et al.⁴⁵ in our study we obtained slightly higher values of sensitivity and specificity (96%, 98% in our study compared with 95% and 97%). Swanney et al had a larger population of patients (n = 337) with a prevalence of obstruction of 65.5%. Similarly we obtained higher values in comparison with the Vandervoede et al study⁴⁶ which had a patient population of 11,676 and a prevalence of obstruction of 39.5%.

7.6.4 SUMMARY

As discussed in Chapter 6 the reference values used in this study are the only published references equations to date that include the FEV₆ parameter in the age range 8-80(years). Using the reference equations and lower limits of normal taken from a large American Health Study NHANES III this study demonstrated that the FEV₆ manoeuvre can be used as a surrogate for the FVC manoeuvre in the identification of airways obstruction in our patient population. We also found a much reduced inter-subject coefficient of variation in the FEV₆ parameter, suggesting that stopping the test at a pre-defined time of six seconds can significantly reduce the variability of the measurement and make it a more reproducible and accurate physiological measurement, while not losing its diagnostic ability.

SECTION C

7.7 FEV₁/FEV₆ AS A SUBSTITUTE FOR FEV₁/FVC IN A SUBGROUP OF ELDERLY PATIENTS USING TWO SETS OF REFERENCE EQUATIONS

7.7.1 AIM OF STUDY

This study was conducted to determine the reliability of FEV₆ and FEV₁/FEV₆ in detecting airways obstruction in an elderly patient group aged 65-85 years using European reference values specific to this age group (García-Río et al.)⁴⁷ and to evaluate the sensitivity and reliability in detecting airways obstruction using both the American (NHANES III)⁴⁸ and the European (García-Río et al.) reference values in this elderly population. It is in this group of patients that the shorter FEV₆ spirometry test may be of most benefit. As documented in Study B Section 7.3, the forced expiratory time generally becomes longer with age and so a shorter test will minimize the burden involved in reaching the standard end-of-test point.

The European reference equations used in this study are the first and only published spirometric equations to date extracted from a European population of elderly patients to include the new FEV₆ parameters.

7.7.2 RESULTS

In this study we had a total of n= 68 patients, n=35 female and n=33 male. Mean age of the group was 72 (5.2) years, mean height 167(9.8) centimeters, with females on average 14 cm shorter than males (Table 7.11). The mean forced expiratory time for the group was 9.6 (2.6) seconds. The mean measured spirometry parameters are shown in table 7.12. Mean measured FEV₁/FVC for the group is 68.3 with a SD of 12.2 compared to FEV₁/FEV₆ of 72.2 with a smaller SD of 9.8.

TABLE 7.11 SUBJECT DEMOGRAPHICS

	Male n = 33	Female n = 35	Total n = 68
Mean Age (years)	72.2 ± 4.8	72.5 ± 5.7	72.4 ± 5.2
Mean Height (cm)	174 ± 6.4	160 ± 7.4	167 ± 9.8
Mean FET (sec)	9.8 ± 2.5	9.4 ± 2.8	9.6 ± 2.6

TABLE 7.12 SPIROMETRY DATA

Spirometry Parameter	Mean (± SD)
FVC measured	2.6 ± 0.8
FEV ₆ measured	2.5 ± 0.8
FEV ₁ measured	1.8 ± 0.7
FEV ₁ /FVC measured	68.3 ± 12.2
FEV ₁ /FEV ₆ measured	72.0 ± 9.8
FET	9.6 ± 2.6

The comparison of FEV₁/FVC and FEV₁/FEV₆ with reference equations and lower limits of normal from the NHANES III reference set is expressed in a 2-by-2 contingency table (table 7.13). The ratios matched for diagnosis in all but one case where FEV₁/FEV₆ diagnosed airways obstruction and the FEV₁/FVC categorized this subject to have no airways obstruction (table 7.14). The sensitivity of the FEV₁/FEV₆ ratio for correctly diagnosing airways obstruction in this elderly cohort was calculated to be 100%, specificity 98%, with a positive predictive value of 95% and a negative predictive value of 100%.

TABLE 7.13 CONTINGENCY TABLE USING NORTH AMERICAN (NHANES III) REFERENCE EQUATIONS

FEV₁/FVC			
	Obstruction	No Obstruction	Total
FEV₁/FEV₆ Obstruction	21	1	22
FEV₁/FEV₆ No Obstruction	0	46	46
Total	21	47	68
Sensitivity: 100% Specificity: 98% Positive predictive value (PPV): 95% Negative predictive value (NPV): 100%			

TABLE 7.14 DISCORDANT CASE USING NHANES III REFERENCE VALUES

Subject	Age (years)	FET (secs)	Gender	FEV₁/FVC (LLN)	FEV₁/FEV₆ (LLN)
1	78	6.5	Female	69 (64)	69 (69)
LLN refers to lower limit of normal Difference refers to the measured value minus the lower limit of normal. Age is displayed in years Forced expiratory time (FET) is displayed in seconds					

This calculation was repeated using reference equations and lower limits of normal from the Garcia-Rio reference set, results are expressed as a 2-by-2 table (Table 7.15). Using these equations the sensitivity of FEV₁/FEV₆ was calculated to be 96%, with specificity 95% ,and positive predictive value of 92.6%, and a negative predictive value of 97.5%.

FEV₁/FVC and FEV₁/FEV₆ disagreed in their diagnoses of airways obstruction in three cases using this reference set (Table 7.16).

TABLE 7.15 CONTINGENCY TABLE USING EUROPEAN (GARCIA-RIO) REFERENCE EQUATIONS

FEV₁/FVC			
	Obstruction	No obstruction	Total
FEV₁/FEV₆ Obstruction	25	2	27
FEV₁/FEV₆ No obstruction	1	40	41
Total	26	42	68
Sensitivity: 96% Specificity: 95% Positive predictive value (PPV): 92.6			
Negative predictive value (NPV): 97.5			

TABLE 7.16 DISCORDANT CASES USING GARCIA-RIO REFERENCE VALUES

Subject	Age (years)	FET (secs)	Gender	FEV₁/FVC (LLN)	FEV₁/FEV₆ (LLN)
1	70	10.1	Female	62 (68)	70 (69)
2	67	7	Male	71 (70)	71 (72)
3	77	12.2	Male	65(67)	72 (69)
LLN refers to lower limit of normal					
Difference refers to the measured value minus the lower limit of normal.					
Age in years					
Forced expiratory time (FET in seconds)					

7.7.3 DISCUSSION

The main aim of this study was to investigate the diagnostic ability of the shorter six second manoeuvre in a subgroup of patients that have longer forced expiratory times (FET), due to the natural ageing process of the lung and loss of elastic recoil⁴⁹. Elderly patients may benefit most from a shorter spirometry manoeuvre, as less effort is required to reach the end of test point. From our results in Section 7.1, we found that the mean difference between the FEV₁/FVC and FEV₁/FEV₆ ratios increased with increasing age and forced expiratory time but using reference equations with LLNs that included FEV₆ parameters, we calculated the diagnostic ability of the FEV₁/FEV₆ to correctly diagnose airways obstruction was 96.3%.

The FEV₁/FVC ratio obtained from a spirometry or forced vital capacity manoeuvre is widely used in clinical practice to determine the presence of an obstructive ventilatory defect or airways obstruction^{50,51,52}. An obstructive ventilatory defect is defined as a disproportionate reduction of maximal airflow from the lungs in relation to the maximal volume that can be displaced from the lung⁵³. As the FEV₁/FVC ratio is based on the maximal volume of air that can be exhaled during a spirometry test the accuracy of this ratio becomes entirely dependent on patient effort and co-operation. In spirometry testing the ability to reach an acceptable exhaled volume or end of test point and the ability to reproduce this volume to within 150 ml as stated in the most recent guidelines on the standardization of spirometry testing⁵³ can be especially difficult for elderly patients and patients with severe airways obstruction. These patients often require up to 20 seconds to reach what is accepted as an adequate end-of-test point of a volume change of <25 ml over 2 seconds.

An alternative end-of test-point, where the forced expiratory volume is explicitly confined to 6 seconds duration has been suggested to be a more accurate less variable measurement and one that may be less demanding to perform.

There are numerous reference equations published for forced spirometry parameters such as the FVC and the FEV₁; in the Republic of Ireland over 90% of pulmonary function laboratories have adopted the 1993 Update European Respiratory Society spirometry reference values for adults aged 18-70 years⁵⁴ for their patient population. Two published reference equations exist for the FEV₆ parameter and its ratio FEV₁/FEV₆. The Third National Health and Nutrition Examination Survey (NHANES III) which was derived from a US population aged 8-80 years and the reference equations by García-Río et al. derived from a Spanish population with an age range of 65-85years. Studies to date using the NHANES III US reference values for FEV₆ and FEV₁/FEV₆ have shown FEV₆ to be reliable alternative for detecting airways obstruction (and restriction) in spirometry testing^{55,56} and that FEV₆ can be used as a surrogate for FVC in the workplace setting⁵⁷.

Another study published fixed cut-off-points for FEV₆ and FEV₁/FEV₆ that can be used as a valid alternative to the FVC and FEV₁/FVC ratio in the detection of airways obstruction⁵⁸. European reference values and lower limits of normal published to date that include values for FEV₆, FEV₁/FEV₆ and apply to subjects in the age range of 65-85 years. However it is in this particular group of patients that a shorter test manoeuvre may be of greater benefit, as it may prevent the undue fatigue and discomfort and in some cases syncope that can be associated with the standard prolonged test manoeuvre. In our study we documented that the average forced expiratory time for the group as a whole was 9.8 seconds, well above the suggested six second cut off point. The longer forced expiratory times (FET) in this particular cohort of patients may be due in part to the natural ageing process of the lung. The loss of

elastic recoil in ageing lungs can mimic an airways obstructive pattern⁵⁹. The difficulty with longer forced expiratory times is that they push the standard criteria for end-of-test further along the expiratory time curve, making it increasingly difficult for the patient to reach them. The shorter FEV₆ manoeuvre has a definite end-of-test of six seconds duration and so can reduce the effort required by the patient and by the test operator to meet a longer FVC end of test point. It can reduce overall testing time and may actually assist in interpretation by reducing the variability of the volume measurement, making it statistically more accurate when compared with reference values for the same measurement. In the present study using contingency tables and lower limits of normal, tables 7.13 and 7.14, we have shown significant agreement between FEV₁/FEV₆ and FEV₁/FVC in terms of diagnosing airways obstruction in both sets of reference equations for our elderly cohort and these findings reflect the values obtained in previous studies in other countries. However we did not get 100% agreement and where the ratios differed in diagnosis (discordant cases) the actual measured values for each ratio is very close to its respective lower limit of normal. This was the first study to date to look at the new FEV₆ parameters in terms of diagnosing airways obstruction in a strictly elderly group of patients, and the first to compare the differences between the two main reference equations published to date to include FEV₆ equations and lower limits of normal.

7.7.4 SUMMARY

The results of this study confirm that FEV₆ is a more reproducible parameter by showing the coefficient of variation for FEV₁/FEV₆ to be 23% less than that for FEV₁/FVC. This reduced variability suggests that the FEV₁/FEV₆ may be a more statistically accurate ratio for detecting airways obstruction.

Recently published joint ERS/ATS guidelines on the standardization of spirometry define an acceptable duration of exhalation as ≥ 6 seconds or the presence of a plateau to define end-of-test criteria, making way for this new FEV₆ parameter to be recognised as an acceptable surrogate for FVC provided the correct reference values are used. This work suggests there is need for updated European reference equations to be made available to include FEV₆ and FEV₁/FEV₆ for all age groups. This study has shown reduced variability of FEV₁/FEV₆ compared to FEV₁/FVC and therefore that FEV₆ has a role in spirometry testing, especially for patients unable to reach a satisfactory FVC endpoint. The agreement of FEV₁/FVC and FEV₁/FEV₆ using both reference sets and the sensitivity/specificity of FEV₁/FEV₆ in this cohort support the validity of using FEV₆ in the diagnosis of airway obstruction.

7.8 REFERENCES

1. National Heart, Lung and Blood Institute. Morbidity and Mortality: 2004. Chart book on cardiovascular, lung, and blood diseases. Rockville MD: National Heart, Lung and Blood Institute: 2004
2. Xu X, Weiss ST, Rijcken B et al. Smoking, changes in smoking habits and rate of decline in FEV₁: new insights into gender differences. *Eur Respir J* 1994;7: 1056-61
3. Burchfield CM, Marcus EB, Curb JD, et al. Effects of smoking cessation on longitudinal decline in pulmonary function. *Am J Respir Crit Care Med* 1995; 151: 1778-85
4. Sandvik L, Erickssen G, Thaulow E. Long-term effects of smoking on physical fitness and lung function: a longitudinal study of 1,393 middle aged Norwegian men for 7 years. *BMJ* 1995; 311: 715-18
5. Xu X, Li B. Exposure-response relationship between passive smoking and adult pulmonary function. *Am J Respir Crit Care Med* 1995;151:41-46
6. Tashkin DP, Detels R, Simmons M, et al. The UCLA population studies of COPD X1. Impact of air pollution and smoking on annual change in FEV₁. *Am J Respir Crit Care Med* 1994; 149: 1209-1217

7. Weiss ST, Tager IB, Munoz A, et al. The relationship of respiratory infections in early childhood to the occurrence of increased levels of bronchial responsiveness and atopy. *Am Rev Respir Dis* 1985; 131: 73-578
8. O Connor GT, Sparrow D, Weiss ST. The role of allergy and non-specific airway hyperreponsiveness in the pathogenesis of COPD. *Am Rev Respir Dis* 1989; 140: 225-252
9. Snider GL. Pulmonary disease in alpha-1-antitrypsin deficiency. *Ann Intern Med* 1989; 111: 957-959
10. Becklake MR. Occupational and environmental lung disease. Chronic airways disease: Its relationship to work in dusty occupations. *Chest* 1985; 88: 608-617
11. Anthonsien Nr, Connett JE, Kiley JP et al. Effects of smoking intervention on the use of an inhaled anticholinergic bronchodilator on the rate of decline of FEV₁: the lung health study. *JAMA* 1994; 272: 1497-1505
12. Mannino DM, Buist AS, Petty TL, Enright PL, Redd SC. Lung Function and mortality in the United States: data from the first National Health and Nutrition Examination Survey NHANES follow-up. *Thorax* 2003; 58: 388-393
13. Pellegrino R, Viegi G, Brusasco V, Crapo RO, Burgos F et al. Interpretative strategies for lung function tests. *Eur Respir J* 2005; 26: 948-968

14. Peat JK, Woolcock AJ, Cullen K. Decline of lung function and development of Chronic airflow limitation: a longitudinal study of non-smokers and smokers in Busselton, Western Australia. *Thorax* 1990;45: 32-37
15. Fletcher C, Peto R, Tinker C, Speizer FE. The natural history of chronic bronchitis and emphysema: an eight year study of early chronic obstructive lung disease in working men in London. Oxford, UK. Oxford University Press; 1976
16. Anthonisen NR, Connett JE, Kiley JP, et al. Effects of smoking intervention and the use of an inhaled anticholinergic bronchodilator on the rate of decline of FEV₁: The Lung Health Study: *JAMA* 1994; 272: 1497-1505
17. Marcq M, Minette A. Lung function changes in smokers with normal conventional spirometry. *Am Rev Respir Dis* 1976; 114:723-38
18. Hogg JG, Macklem PT, Thurlbeck WM. Site and nature of airways obstruction in Chronic Obstructive Lung Disease. *N Engl J Med* 1968; 278: 1355-60
19. Anthonisen NR, Connett JE, Kiley JP, et al. Effects of smoking intervention and the use of an inhaled anticholinergic bronchodilator on the rate of decline of FEV₁: The Lung Health Study: *JAMA* 1994; 272: 1497-1505
20. Enright RL, Connett JE, Bailey WC. The FEV₁/FEV₆ predicts lung function decline in adult smokers. *Respir Med* 2002; 96(6): 444-449

21. Dockery DW, Speizer FE, Ferris BG Jr, Ware JH, Louis TA, Spiro A. Cumulative and reversible effects of lifetime smoking on simple tests of lung function in adults. *Am Rev Respir Dis* 1988; 137: 286-292
22. Manning P, Goodman P, Kinsella T, Lawlor M, Kirby B, Clancy L. Bronchitis symptoms in young teenagers who actively or passively smoke cigarettes. *Ir Med J*. 2002-Aug;95(7):202-4
23. Camilli AE, Burrows B, Knudson RJ, et al. Longitudinal changes in FEV₁ in adults. Effects of smoking and smoking cessation. *Am Rev Respir Dis* 1987; 135(4): 794-799
24. Xu X, Dockery DW, Ware JH, Speizer FE, Ferris BG Jr. Effects of cigarette smoking on rate of loss of lung function in adults: a longitudinal assessment. *Am Rev Respir Dis* 1992; 146: 855-859
25. Lange P, Groth S, Nyboe J, et al. Effects of smoking and changes in smoking habits on the decline of FEV₁. *Eur Respir J* 1989; 2: 811-816
26. Langhammer A, Johnsen R, Gulsvik A, et al. Sex Differences in Lung vulnerability to tobacco smoking. *Eur Respir J* 2003; 21: 1017-1023
27. Miller MR, Hankinson J, Brusasco V, et al. Standardisation of spirometry. *Eur Respir J* 2005; 26: 153-161

28. Roca J, Burgos F, Sunyer J et al. Reference values for forced spirometry. *Eur Respir J* 1998; 11: 1354-1362
29. Hurwitz S, Allen J, Liben A, Becklake, MR. Lung function in young adults: evidence for the differences in the chronological age at which various functions start to decline. *Thorax* 1980; 35: 615-619
30. Falaschetti E, Laiho J, Primatesta P, Purdon S. Prediction equations for normal and low lung function from the Health Survey for England. *Eur Respir J* 2004; 23: 456-463
31. Enright et al. Spirometric reference equations for healthy middle-aged women and men Minnesota
32. Garcia-Rio F, Pino JM, Dorgham A, Alsono A, Villamor J. Spirometric reference equations for European females and males aged 65-85yrs. *Eur Respir J* 2004;24: 397-405
33. Janssens JP, Pache JC, Nicod LP. Physiological changes in respiratory function associated with ageing. *Eur Respir J* 1999;13: 197-205
34. Knudson RJ, Lebowitz MD, Holberg CJ, Burrows B. Changes in the maximum expired flow volume curve with growth and ageing. *Am Rev Respir Dis* 1983; 127: 725-734

35. Garcia-Rio F, Pino JM, Dorgham A, Alsono A, Villamor J. Spirometric reference equations for European females and males aged 65-85yrs. *Eur Respir J* 2004;24: 397-405
36. Hankinson JL, Odencrantz JR, Fedan KB. Spirometric reference values from a sample of the general U.S population. *Am J Respir Crit Care Med* 1999; 159: 179-187
37. Kerstjens HAM, Rijcken B, Schouten JP, et al. Decline of FEV₁ by age and smoking status: Facts, figures and fallacies. *Thorax* 1997; 52: 820-827
38. Turner JM, Mead J, Wohl ME. Elasticity of human lungs in relation to age. *J Appl Physiol* 1968; 25: 664-671
39. Pellegrino R, Viegi G, Brusasco V, Crapo RO, Burgos F et al. Interpretative strategies for lung function tests. *Eur Respir J* 2005; 26: 948-968
40. American Thoracic Society. Lung Function testing. Selection of reference values and interpretative strategies. *Am Rev Respir Dis* 1991; 144: 1202-1218.
41. Demir T, Ikitimir HD, Koc N, Yildirim N. The role of FEV₆ in detection of airways obstruction. *Respir Med* 2005; 99: 103-106
42. Spengler CM, Shea SA. Endogenous circadian rhythm of pulmonary function in healthy humans. *Am J Respir Crit Care Med* 2002; 162:1038-1064

43. Burrows B, Lebowitz MD, Camilli AE, Knudson RJ. Longitudinal changes in Forced expiratory capacity in the first second in adults. Methodological consideration and findings in healthy non-smokers. *Am Rev Respir Dis* 1986; 133: 974-980
44. Spencer DA, Marshall T, Weller PH, Williams J. A superior method of assessing the reproducibility of pulmonary function measurements. *Am Rev Respir Dis* 1992; 145: A253
45. Swanney MP, Jenson RL, Crichton DA, Beckert LE, et al. FEV₆ is an acceptable surrogate for FVC in the spirometric diagnosis of airway obstruction and restriction. *Am J Respir Crit Care Med* 2000; 162:917-919
46. Vandevoorde J, Verbanck S, Schuermans D, et al. FEV₁/FEV₆ and FEV₆ as an alternative to FEV₁/FVC and FVC in the spirometric detection of airways obstruction and restriction. *Chest* 2005; 127:1560-1564
47. García-Río F, Pino JM, Dorgham A, Alonso A, Villamore J. Spirometric reference equations for European females and males aged 65-85yrs. *Eur Respir J* 2004; 24:397-405
48. Hankinson JL, Odencrantz JR, Fedan KB. Spirometric reference values from a sample of the general US population. *Am.J.Respir.Crit.Care.Med* 1999; 159:179-187
49. Janssens JP, Pache JC, Nicod LP. Physiological changes in respiratory function associated with ageing. *Eur Respir J* 1999;13: 197-205

50. Millar MR, Hankinson J, Brusasco V, Burgos R, Casaburi R, Coates A, Crapo R, Enright et al. Standardisation of spirometry. *Eur Respir J* 2005; 26: 319-338
51. BTS/SIGN Guidelines on Asthma. <http://www.brit-thoracic.org.uk/asthma-guideline-download.html>
52. NHLBI/WHO workshop 1998. Global initiative for chronic obstructive lung disease. Global strategy for the diagnosis, management, and prevention of chronic obstructive pulmonary disease. www.goldcopd.org. September 2005
53. Millar MR, Hankinson J, Brusasco V, Burgos R, Casaburi R, Coates A, Crapo R, Enright P et al. Standardisation of spirometry. *Eur Respir J* 2005; 26: 319-338
54. ARTI Audit of Respiratory Laboratories in the Republic of Ireland 2005
55. Swanney MP, Jensen RL, Crichton DA, Beckert LE, Cardno L, Crapo R. FEV₆ is an acceptable surrogate for FVC in the spirometric diagnosis of airway obstruction and restriction. *Am.J.Crit.Care.Med* 2000;162:917-919
56. Vandevoorde J, Verbanck S, Scheuermans D, Kartounian J, Vincken W. FEV₁/FEV₆ and FEV₆ as an alternative for FEV₁/FVC and FVC in the spirometric detection of airway obstruction and restriction. *Chest* 2005; 127:1560-1564

57. Akpınar-Elci M, Fedan KB, Enright PL. FEV₆ as a surrogate for FVC in detecting airways obstruction and restriction in the workplace. *Eur Respir J* 2006; 27:374-377
58. Vandevorde J, Verbanck S, Scheuermans D, Kartounian J, Vincken W. Obstructive and restrictive spirometric patterns: fixed cut-offs for FEV₁/FEV₆ and FEV₆. *Eur Respir J* 2005; 27: 378-383
59. Babb TG, Rodarte JR. Mechanism of reduced expiratory flow with ageing. *J Appl Physiol* 2000; 89:505-511

CHAPTER 8 CONCLUSIONS

The utility of a shorter six second manoeuvre in spirometry testing has been assessed in this thesis with a special emphasis showing that spirometric indices measured at six seconds are clinically useful in detecting airways obstruction. The clinical utility of the traditional FVC manoeuvre has already been well established with the FEV₁/FVC ratio now firmly accepted as an indicator of the presence of airflow obstruction. However the FVC manoeuvre is not without problems. The prolonged forced expiratory times required to meet acceptable end-of-test criteria can be physically exhausting for subjects with airways obstruction and for elderly and infirm subjects. Also measurements with expiratory times that take up to or exceed 15 seconds have the potential to cause an increase in measurement variability. In addition an increase in the prevalence of respiratory disease worldwide, particularly COPD, has led to a renewed interest in making spirometry testing more user-friendly and less variable, thereby facilitating widespread implementation of spirometry as a means of detecting airways obstruction in its sub-clinical phase.

An alternative to the traditional FVC manoeuvre is the forced vital capacity at six seconds (FEV₆). In our investigations into the clinical utility of the FEV₆ manoeuvre we investigated if parameters measured at six seconds exhalation could provide any additional information regarding early detection of airways obstruction in smokers with otherwise normal spirometry values. The findings of this study revealed that a significant difference existed in the FEV₁/FVC ratio between smokers and non-smokers and that the FEV₁/FEV₆ ratio mirrored this finding. While the FEV₆ parameters did not provide us with any additional information regarding early indicators of airways obstruction, parameters measured at six seconds can be successfully used as a surrogate for the FVC manoeuvre in this study group. We also found that parameters measured at

six seconds are less variable and therefore are more easily interpreted with accuracy. The findings of this section of the thesis reveal that the FEV₆ measurement has a role to play in spirometry testing but further studies regarding its diagnostic ability are required. A longitudinal study of the spirometry results of smokers compared to non-smokers to include parameters measured at six seconds would give further scope to properly assess the merits of the FEV₁/FEV₆ ratio in providing additional information regarding accelerated lung function decline in smokers.

The diagnostic ability of the FEV₁/FEV₆ ratio to reliably detect airways obstruction using appropriate reference equations and lower limits of normal compared to the 'gold standard' FEV₁/FVC ratio was assessed. The results of this thesis confirm that forced expiratory volume in six seconds FEV₆ can be used as a surrogate for FVC in our adult patient population. We also confirmed that FEV₆ spirometry values are more reproducible and less variable than FVC values. We also compared FEV₆ to FVC in terms of detecting airways obstruction in an elderly patient group aged 65-85 years using two different reference sets. One set was from a North American population, and the second set was the only European spirometry reference set to date to include FEV₆ parameters, and specific to the age group being studied, 65-85 years. It is for this specific age group that a shorter spirometry manoeuvre such as the FEV₆ would be of greater benefit by easing the burden of the test. Given the naturally longer forced expiratory times that accompany natural ageing of the lung the potential for larger differences between parameters measured at the traditional FVC manoeuvre and those measured at six seconds exhalation FEV₆ exist. The findings of this study confirm that the FEV₁/FEV₆ is as good as FEV₁/FVC in detecting airways obstruction in this age group using both reference sets in our patient population. Where diagnosis differed between ratios, the actual measurements when inspected lay close to their respective lower limit of normal values. A spirometry value close to, or at, its lower limit of

normal value could be due to the day-to-day variation shift across this limit, meaning the same test may yield a different diagnosis if repeated some days apart. Therefore spirometry values that lie close to their lower limit of normal value should be interpreted with caution.

8.1 SUMMARY

This work demonstrates that the shorter FEV₆ manoeuvre is as effective as the traditional FVC manoeuvre in the detection of airways obstruction in our patient population, provided the appropriate reference equations and lower limits of normal are used. We found the FEV₆ parameter to be more reproducible than the FVC parameter, with prolonged expiratory times having a smaller impact on FEV₆ reproducibility than on FVC reproducibility.

The physical impact of a shorter FEV₆ manoeuvre will be more pronounced in subjects where multiple prolonged forced expiratory efforts are commonly required to satisfy reproducibility criteria, for example with elderly subjects and subjects with airways obstruction. Lowering the forced expiratory time to six seconds will reduce the likelihood of procedure related syncope (which is light headiness, faintness) general fatigue and distress that can accompany a session of numerous prolonged forced expiratory efforts. A fixed expiratory time of six seconds has been shown in this study to significantly reduce the variability of the test, and therefore improve the overall accuracy of the test. In addition the agreement of both FEV₁/FVC and FEV₁/FEV₆ in terms of sensitivity and specificity support the validity of using FEV₆ in the spirometric detection of airways obstruction.

8.2 Further Work

Using FEV₆ based spirometry values to detect airways obstruction could increase the popularity of spirometry testing in the primary care setting where the number quality of testing may not be as good as that in a hospital based lung function department. The shorter test manoeuvre coupled with the reduced variability of this measurement may provide a means of reducing the risk of mis-classification in this setting. As we have shown in this work FEV₆ parameters are less variable and therefore more reproducible than the standard FVC parameters. We have also shown that among other spirometric parameters the FEF_{25-75%} is significantly reduced in smokers compared to non-smokers. The diagnostic ability of the FEF_{25-75%} has always been limited because of its high variability; this was demonstrated in our work with inter-subject SD values of up to 29.0, compared to SD values for FEV₆ of approx 12.0.

The greater variability in this measurement is partly due to the variability of the FVC measurement, since this measurement is calculated from 25% and 75% of the end value FVC. Determining FEF_{25-75%} from a six second manoeuvre, which has proven to be less variable, may provide a more accurate means of detecting early airway changes compared to other tests of lung function.

For more work to be carried out on the clinical utility of the FEV₆ manoeuvre in pulmonary function new updated European reference equations and lower limits of normal for spirometry values to include FEV₆ are required over a wide age range, and especially for subjects over the age of 75 years.

APPENDIX A

RANGE AND ACCURACY RECOMMENDATIONS FOR SPIROMETERS*

Test	Range/accuracy (BTPS)	Flow Range	Time L.s ⁻¹	Resistance and Back pressure	Test Signal
VC	0.5-8 L, ±3% of reading or ± 0.050 l, whichever is greater	0-14	30		3-L Calibration syringe
FVC	0.5-8 L, ±3% of reading or ± 0.050 l, whichever is greater	0-14	15	<1.5cmH ₂ O.L ⁻¹ .s ⁻¹ (0.15 kPa.L ⁻¹ .s ⁻¹)	24 ATS waveforms 3-L Calibration syringe
FEV₁	0.5-8 L, ±3% of reading or ± 0.050 l, whichever is greater	0-14	1	<1.5cmH ₂ O.L ⁻¹ .s ⁻¹ (0.15 kPa.L ⁻¹ .s ⁻¹)	
Time zero	The time point from which all FEV _t measurements are taken			Back Extrapolation	
PEF	Accuracy: ± 10% of reading or ± 0.30L.s ⁻¹ (20 L.min ⁻¹) whichever is greater; repeatability: ±5% of reading or ±0.15 L.s ⁻¹ (10 L.min ⁻¹), whichever is greater	0-14		Mean resistance at 200, 400, 600 L.min ⁻¹ (3.3, 6.7, 10 L.s ⁻¹) must be <2.5 cmH ₂ O.L ⁻¹ .s ⁻¹ (0.25 kPa.L ⁻¹ .s ⁻¹)	26 ATS waveforms
Instantaneous flows (except PEF)	Accuracy ± 5% of reading or ± 0.200 L.s ⁻¹ , whichever is greater	0-14		<1.5cmH ₂ O.L ⁻¹ .s ⁻¹ (0.15 kPa.L ⁻¹ .s ⁻¹)	Data from manufacturers
FEF_{25-75%}	7.0 L.s ⁻¹ , ± 5% of reading or ± 0.200 L.s ⁻¹ , whichever is greater	± 14	15	Same as FEV ₁	24 ATS waveforms
MVV	250 L.min ⁻¹ at V _T of 2 L within ± 10% of reading or ± 15 L.min ⁻¹ , whichever is greater	± 14 (±3%)	12-15	<1.5cmH ₂ O.L ⁻¹ .s ⁻¹ (0.15 kPa.L ⁻¹ .s ⁻¹)	Sine wave pump

BTPS: body temperature and ambient pressure saturated with water vapour; VC: vital capacity; FVC: forced vital capacity; ATS: American Thoracic Society; FEV₁: forced expiratory volume in one second; FEV_t: forced expiratory volume in t seconds; PEF: peak expiratory flow; FEF_{25-75%}: mean forced expiratory flow between 25% and 75% of FVC; MVV: maximum voluntary ventilation; V_T: tidal volume.

* Millar MR, Hankinson J, Brusasco V, Burgos R, Casaburi R, Coates A, Crapo R, Enright P et al. Standardisation of spirometry. Eur Respir J 2005; 26: 319-338

APPENDIX B

SUMMARY OF WITHIN-AND-BETWEEN-MANOEUVRE ACCEPTABILITY CRITERIA*

Table 5 Summary of within-and between-manoevre acceptability criteria

Within-manoevre criteria

Individual spiromgrams are “acceptable” if

They are free from artefacts [3]

Cough during the first second of exhalation

Glottis closure that influences the measurement

Early termination or cut-off

Effort that is not maximal throughout

Leak

Obstructed mouthpiece

They have good starts

Extrapolated volume < 5% of FVC or 0.15L, whichever is greater

They show satisfactory exhalation

Duration of ≥ 6 s (3s for children) or a plateau in the volume-time curve or

If the subject cannot or should not continue to exhale

Between-manoevre criteria

After three acceptable spiromgrams have been obtained, apply the following tests

The two largest value of FVC must be within 0.150 L of each other

The two largest value of FEV₁ must be within 0.150 L of each other

If both of these criteria are met, the test session may be concluded

If both of these criteria are not met, continue testing until

Both of the criteria are met with analysis of additional acceptable spiromgrams
or

A total of eight tests have been performed (optional) or

The patient/subject cannot or should not continue

Save, as a minimum, the three satisfactory manoeuvres

FVC: forced vital capacity; FEV₁: forced vital capacity in one second

* Millar MR, Hankinson J, Brusasco V, Burgos R, Casaburi R, Coates A, Crapo R, Enright P et al.

Standardisation of spirometry. Eur Respir J 2005; 26: 319-338

APPENDIX C

DEFINITION OF LUNG VOLUMES AND CAPACITIES*

Volume (units: millilitres)	Definition
Tidal volume (V_t)	Volume of gas inhaled and exhaled during each respiratory cycle
Inspiratory reserve volume (IRV)	Maximal volume of gas exhaled from end inspiration
Expiratory reserve volume (ERV)	Maximal volume of gas exhaled from end expiration
Residual volume (RV)	Volume of gas remaining in the lungs after a maximal expiration

APPENDIX D

Vmax Series

SPECIFICATIONS

Note

Features and specifications are subject to change without notice.

Flow Volume Measurements

Flow Volume	
Type	Mass Flow sensor
Range	0-16 LPS
Resolution	0.003 LPS from 0.20 – 16 LPS
Flow accuracy	±3% of reading or 0.25 LPS, whichever is greater, across the range of 0.2 to 12 LPS
Volume accuracy	±3% of reading or 0,050 L, whichever is greater
Resistance	<1.5 cmH ₂ O/LPS at 12 LPS

APPENDIX E

EXCLUDED GROUP (EXCLUDED ON THE BASIS OF NOT MEETING CRITERIA AS SET OUT IN TABLE 6.1)

No	Reason for Exclusion	Hgt	FET	Gender	FEV1/FVC M	FEV1/FEV6M
1	Early Glottic closure	161	7.31	Female	89	89
2	Slow start	154	9.34	Female	58	63
3	Slow start	159	7.07	Male	81	81
4	Early Glottic closure	157	9.7	Female	75	77
5	Slow start	163	6.45	Female	72	73
6	Slow start	187	8.46	Male	78	80
7	end of test not met	176	8.75	Male	74	76
8	only 2 acc tests	173	6.44	Male	89	91
9	end of test not met	176	9.66	Male	66	69
10	only 2 acc tests	153	7.08	Female	74	74
11	end of test not met	173	8.46	Male	84	86
12	end of test not met	156	10.88	Female	69	75
13	end of test not met	144	6.05	Female	74	76
14	Slow start	161	9.17	Female	66	69
15	cough	166	10.14	Male	70	73
16	end of test not met	170	10.14	Male	47	53
17	end of test not met	170	14.2	Male	47	55
18	cough	159	7.4	Female	59	59
19	end of test not met	165	7.19	Female	85	85
20	end of test not met	185	13.78	Male	38	48
21	non-reproducible	184	12.11	Male	67	72
22	cough	164	7.54	Female	80	80
23	cough	174	15.98	Male	59	69
24	Slow start	172	7.06	Male	80	81
25	glottic closure	165	6.67	Female	82	82
26	non-reproducible	158	12.22	Female	69	75
27	glottic closure	174	6.61	Male	87	88
28	end of test not met	178	6.36	Male	98	98
29	cough	153	9.17	Female	69	72
30	end of test not met	188	7.01	Male	96	96
31	end of test not met	149	6.38	Female	58	58
32	end of test not met	177	6.73	Male	86	86
33	Slow start	162	7.57	Female	84	84
34	cough	158	7.46	Female	78	80
35	end of test not met	167	9.74	Male	57	61
36	end of test not met	184	7.74	Male	77	80
37	end of test not met	177	8.34	Male	50	55
38	end of test not met	150	11.18	Female	75	80
39	non-reproducible	166	6.54	Female	87	87
40	non-reproducible	156	10.75	Female	60	66
41	Slow start	175	11.18	Male	38	44
42	Slow start	189	11.23	Male	72	75
43	non-reproducible	174	6.55	Male	46	46
44	non-reproducible	177	9.02	Male	80	83
45	non-reproducible	169	8.33	Male	78	79
46	end of test not met	169	7.19	Female	73	73
47	non-reproducible	161	6.37	Female	74	74
48	cough	159	9.62	Female	44	50
49	Slow start	164	6.8	Female	74	75
50	cough	174	6.72	Male	86	86
51	non-reproducible	167	20.04	Male	47	60

52	end of test not met	169	9.33	Female	73	76
53	Slow start	184	11.12	Male	62	68
54	non-reproducible	159	6.83	Female	71	72
55	non-reproducible	171	6.51	Male	75	75
56	end of test not met	161	6.55	Female	76	77
57	non-reproducible	174	9.74	Male	55	59
58	non-reproducible	174	10.22	Male	65	69
59	non-reproducible	178	6.27	Male	85	86
60	non-reproducible	177	7.04	Male	85	85
61	non-reproducible	179	6.89	Male	81	82
62	Slow start	165	8.9	Female	73	75
63	cough	155	6.69	Female	71	72
64	non-reproducible	186	6.73	Male	75	75
65	non-reproducible	178	12.18	Male	55	61
66	cough	176	6.83	Male	65	66
67	non-reproducible	159	8.14	Female	73	77
68	end of test not met	172	7.87	Male	60	63
69	end of test not met	155	6.02	Female	70	71
70	end of test not met	174	13.06	Male	54	62
71	end of test not met	159	8.08	Female	82	84
72	non-reproducible	159	8.24	Female	53	55

	Total (% of total)	Male	Female
	72	39(54%)	33 (46%)
Non-smokers:	35	18	17
Ex-Smokers:	25	17	8
Smokers:	12	4	8
Age (Years)	60	58	62
FET (Seconds)	8.71	9.29	8.02
Height (Centimetres)	168	176	159
FVC	2.98	3.64	2.21
FEV ₆	2.86	3.45	2.15
FEV ₁	2.14	2.58	1.62
FEV ₁ /FVC	70.3	69.1	71.8
FEV ₁ /FEV ₆	73.0	72.3	73.8
Slow start	12 (16.6%)	6 (15.5%)	6 (18.2%)
EOT not met	24 (33.4%)	14 (35.9%)	10 (30.3%)
Not reproducible	22 (30.5%)	14 (35.9%)	8 (24.2%)
Cough	10 (13.9%)	4 (10.2%)	6 (18.2%)
Glottis closure	4 (5.6%)	1 (2.5%)	3 (9.1%)

FVC: forced vital capacity; FEV₁: forced expiratory volume in one second; FEV_t: forced expiratory volume in t seconds; EOT: end of test;

APPENDIX F

NHANES III PREDICTION AND LOWER LIMIT OF NORMAL EQUATIONS FOR FEV₁/FEV₆% AND FEV₁/FVC% FOR CAUCASIAN MALE AND FEMALE SUBJECTS AGED 8-80 YEARS

	Intercept _{PRD}	Age	Intercept _{LLN}	R ²
Male subjects				
Caucasian				
FEV ₁ /FEV ₆ %	87.340	-0.1382	78.372	0.2151
FEV ₁ /FVC%	88.066	-0.2066	78.388	0.3448
Female subjects				
Caucasian				
FEV ₁ /FEV ₆ %	90.107	-0.1563	81.307	0.3048
FEV ₁ /FVC%	90.809	-0.2125	81.015	0.3955

* Intercept_{PRD} is used for prediction equation and Intercept_{LLN} is used (replaces Intercept_{PRD}) for the lower limit of normal equation. Lung function parameter = b₀ + b₁

* age.

APPENDIX G

GARCIA-RIO PREDICTED EQUATIONS FOR HEALTHY CAUCASIAN EUROPEAN MALES AGED 65-85YRS

	Equation	R ²	RSD
FVC L	$0.0001572H^2 - 0.00000268A^3 + 0.223$	0.477	0.4458
FEV ₁ L	$0.0001107H^2 - 0.0445A + 2.886$	0.464	0.3797
FEV ₁ /FVC %	$-0.00198A^2 + 87.472$	0.083	5.2655
FEV _{0.5} L	$0.02615H - 0.0372A + 0.538$	0.411	0.3305
FEV ₂ L	$0.0001331H^2 - 0.00000283A^3 + 0.499$	0.488	0.4066
FEV ₃ L	$0.0001414H^2 - 0.0000028A^3 + 0.420$	0.488	0.4174
FEV ₆ L	$0.0001501H^2 - 0.000298A^2 + 0.869$	0.483	0.4288
FEV ₁ /FEV ₆ %	$-0.0000172A^3 + 85.536$	0.086	5.0040
FEF _{25%} L·s ⁻¹	$0.04185H - 0.137A + 8.947$	0.226	1.5178
FEF _{50%} L·s ⁻¹	$0.03174H - 0.0754A + 3.176$	0.170	1.0573
FEF _{75%} L·s ⁻¹	$0.009789H - 0.0184A + 0.355$	0.163	0.2776
PEF L·s ⁻¹	$0.07092H - 0.000939A^2 + 0.347$	0.221	1.7378
FEF _{75-25%} L·s ⁻¹	$0.02635H - 0.0604A + 2.042$	0.219	0.7241
FEF _{75-85%} L·s ⁻¹	$0.007765H - 0.00948A - 0.229$	0.149	0.1779
TC _{25-50%} s	$0.00005571A^2 + 0.153$	0.045	0.2041
MTT s	$0.00002282A^2 + 0.223$	0.054	0.0760
AEX L ² ·s ⁻¹	$0.0007148H^2 - 0.379A + 18.788$	0.397	3.3119
PIF L	$0.0002211H^2 - 0.0909A + 4.621$	0.247	1.2465
MIF _{50%} L·s ⁻¹	$0.0002133H^2 - 0.0856A + 4.128$	0.221	1.2759
FIV ₁ L	$0.0001585H^2 - 0.0526A + 2.592$	0.373	0.5967

The lower limit of the normal is computed as: predicted value–1.645xresidual standard deviation (RSD)

R²: adjusted coefficient of determination

GARCIA-RIO PREDICTED EQUATIONS FOR HEALTHY CAUCASIAN EUROPEAN FEMALES AGED 65-85YRS

	Equation	R ²	RSD
FVC L	$0.0003171H^2-0.0351A-6.368BSA+0.05925W+3.960$	0.589	0.3046
FEV ₁ L	$0.0001726H^2-0.0326A-2.303BSA+0.000122W^2+3.398$	0.527	0.2741
FEV ₁ /FVC %	$-0.155H-0.184A+116.096$	0.048	5.4974
FEV _{0.5} L	$0.00008072H^2-0.0251A+1.436$	0.432	0.2589
FEV ₂ L	$0.0001138H^2-0.0334A+1.844$	0.523	0.2963
FEV ₃ L	$0.0001218H^2-0.0336A+1.774$	0.529	0.3056
FEV ₆ L	$0.0003309H^2-0.0346A-6.987BSA+0.06548W+4.152$	0.566	0.3101
FEV ₁ /FEV ₆ %	$-0.181H-0.178A+120.544$	0.058	5.3530
FEF _{25%} L·s ⁻¹	$0.05351H-0.00000343A^3-2.756$	0.167	1.1193
FEF _{50%} L·s ⁻¹	$0.03414H-0.0540A+0.890$	0.188	0.8234
FEF _{75%} L·s ⁻¹	$0.005960H-0.0150A+0.660$	0.131	0.2467
PEF L·s ⁻¹	$0.0002283H^2-0.0644A+4.001$	0.209	1.1932
FEF _{75-25%} L·s ⁻¹	$0.02030H-0.0440A+1.538$	0.202	0.5828
FEF _{75-85%} L·s ⁻¹	$-0.0644A+0.735$	0.062	0.1345
TC _{25-50%} s	$0.0000003057A^3+0.288$	0.025	0.1743
AEX L ² ·s ⁻¹	$0.0005499H^2-0.158A+3.788$	0.419	1.7560
PIF L	$0.03154H-0.0553A+2.139$	0.153	0.9248
MIF _{50%} L·s ⁻¹	$0.02934H-0.0566A+2.363$	0.143	0.9552
FIV ₁ L	$0.03478H-0.143A+0.000006A^3+4.701$	0.411	0.3866

The lower limit of the normal is computed as: predicted value–1.645xresidual standard deviation (RSD)

R²: adjusted coefficient of determination

APPENDIX H

1. Irish Thoracic Society (ITS), Galway 2005-Oral presentation
(Irish Journal of Medical Science Supplement 3, Volume 174 Number 4)
2. European Respiratory Society , Munich 2006-Thematic poster presentation
Abstract Number: 253038

Title: FEV₁/FEV₆ as an alternative to FEV₁/FVC in diagnosing airway obstruction using USA and European reference values in an elderly Irish population.

Janine M Kelly¹, Patrick J Manning ¹and Patrick G Goodman². ¹Respiratory, Bon Secours Hospital, Glasnevin, Dublin 9, Ireland and ²School of Physics, Dublin Institute of Technology, Kevin Street, Dublin 8, Ireland.

Introduction:

This study evaluates the use of FEV₁/FEV₆ as an alternative to FEV₁/FVC in diagnosing airway obstruction, especially for patients who cannot provide a satisfactory FVC end of test criteria. This was done using US and European reference values with an elderly Irish patient group, age 65-85yrs, the only age group for which European reference values are available.

Method:

A retrospective analysis was conducted on spirometry data for 68 patients aged 65-85yrs who exhaled for at least six seconds who met ATS criteria. Coefficient of variance for both reference sets and the sensitivity and specificity of FEV₁/FEV₆ for diagnosing airways obstruction as defined by FEV₁/FVC was calculated.

Results:

	Using USA reference values	Using European reference values
Sensitivity %	100	100
Specificity %	97.9	95.5
Positive predictive value %	94.7	91.6
Negative predictive value%	100	100
Coefficient of variation %	FEV ₁ /FVC = 17.8%	FEV ₁ /FVC = 18.3%
	FEV ₁ /FEV ₆ =13.7%	FEV ₁ /FEV ₆ %=14.3%

Conclusions:

This study has shown reduced variability of FEV₁/FEV₆ compared to FEV₁/FVC demonstrating that FEV₆ has a role in spirometry testing, especially for patients unable to reach a satisfactory FVC endpoint. The agreement of FEV₁/FVC and FEV₁/FEV₆ using both reference sets and the sensitivity/specificity of FEV₁/FEV₆ in this cohort

support the validity of using FEV₆ in the diagnosis of airway obstruction. This work highlights the need for updated European reference values for FEV₆ for all age groups.