

4-1-2000

### BS News

Follow this and additional works at: <https://arrow.tudublin.ie/bsn>

 Part of the [Civil Engineering Commons](#), [Construction Engineering Commons](#), and the [Construction Engineering and Management Commons](#)

#### Recommended Citation

(2000) "BS News," *Building Services News*: Vol. 39: Iss. 4, Article 1.

doi:10.21427/D7J128

Available at: <https://arrow.tudublin.ie/bsn/vol39/iss4/1>

This Article is brought to you for free and open access by the Journals at ARROW@TU Dublin. It has been accepted for inclusion in Building Services News by an authorized administrator of ARROW@TU Dublin. For more information, please contact [yvonne.desmond@tudublin.ie](mailto:yvonne.desmond@tudublin.ie), [arrow.admin@tudublin.ie](mailto:arrow.admin@tudublin.ie), [brian.widdis@tudublin.ie](mailto:brian.widdis@tudublin.ie).



This work is licensed under a [Creative Commons Attribution-NonCommercial-Share Alike 3.0 License](#)

# **BSN News**

MECHANICAL & ELECTRICAL BUILDING SERVICES

- ◆ **Energy Show Preview and Catalogue**
- ◆ **Innovation from Carrier**
- ◆ **Standard Control Systems – Going for Further Growth**



- ◆ **Sound Seal™ ... Sounds Off**
- ◆ **Dan Chambers Looks to the Future**
- ◆ **Securing Long-Term Benefits from BMS**
- ◆ **Control Aer ... Promising a Breath of Fresh Air!**

# Innovation in Pumping Technology



MVi



MHi

Stainless Steel Vertical and Horizontal multistage pumps for water supply, boosting, sprinkling, irrigation, high pressure wash, fire protection and water treatment (De-mineralisation, Filtering).

- Water supply
- Boosting
- Sprinkling
- Irrigation
- High pressure wash
- Fire protection
- Water treatment
- Boiler Feed

**WILO**  
Pumping-Perfection

WILO Engineering Ltd., Enterprise Centre  
Childers Road, Limerick, Ireland

Telephone: 061- 41 09 63 Telefax: 061- 41 47 28 2



# BSNews\*

MECHANICAL & ELECTRICAL  
BUILDING SERVICES

ISSN 0791-0878

Published by:  
Pressline Ltd,  
Carraig Court,  
George's Avenue,  
Blackrock, Co Dublin.  
Tel: 01-288 5001/2/3  
Fax: 01-288 6966  
ISDN: 01 - 211 2338/9  
eMail: bsnews@pressline.ie

**Editor:** Pat Lehane

**Advertisement Manager:** Joe Warren

**General Manager:** Edel Burke

**Origination and Design:**

Pressline Ltd. Tel: 01 - 288 5001

**Subscription:** One Year — £30

**Printed by:** Kilkenny People.

© All editorial contents and all advertisements prepared by the publishers, Pressline Ltd.

\* Incorporating Irish Heating & Ventilating News.

## Readership Data

Irish Building Services News (formerly Irish H&V News) is Ireland's only Building Services magazine providing coverage of heating, ventilating, air conditioning, refrigeration, sanitaryware, plumbing, maintenance and environmental industries. It is the only publication catering exclusively for these industries and its circulation includes members of the following:- Chartered Institution of Building Services Engineers (CIBSE);

The Mechanical Engineering & Building Services Contractors' Association (MEBSCA); The Association of Consulting Engineers of Ireland (ACEI); The Mechanical Engineering Contractors' Association; The Institute of Domestic Heating Engineers (IDHE);

The Registered Heating Contractors Association; The Maintenance, Energy & Environmental Technology Association (MEETA) which incorporates energy managers and maintenance managers;

The Energy Conservation & District Heating Association; The Institute of Plumbing; The Irish Home Builders Association (IHBA); Builders Merchants/Trade Supply Outlets; Irish Property & Facilities Managers Association.

In addition, Irish Building Services News circulates to independent building services contractors and key executives in industry. Government, Semi-State and local authority bodies. Essentially, our circulation is virtually saturation coverage of all those with an interest and/or involvement in the industry.

## Is Building Services the Cinderella of Ireland's Construction Boom?

So, you think you've never had it so good .... business is the best it's ever been ... turnover is hitting all-time highs year after year ... order books are full well into the foreseeable future, etc, etc. You've got it made ... or have you?

Are you actually making money and, if so, is the margin sufficient to cover the extra workload and responsibility involved? The chances are that it is not.

Ireland's construction industry is indeed booming, demand outstripping supply to such an extent that the end-product prices paid for land, houses, and commercial and industrial buildings is bordering on insanity.

However, the advantages of this boom are not reflected on a *pro rata* basis down through the construction supply chain. Land owners appear to be getting the lion's share with general operatives and specialist personnel also doing well.

Where does that leave mechanical and electrical contractors, and suppliers? There is no denying that they are very busy, snowed under in fact. But prices are under extreme pressure with margins being squeezed from all directions. Sure everybody *appears* to be doing well ... but are they?

Look to your turnover, then look to the real bottom line and assess it in the context of the costs involved, such as increased labour charges, higher materials costs, longer working hours, greater management inputs, and extra responsibility.

Hopefully you won't be disappointed but, from talking to a broad cross-section of the industry, *BSNews* gets the impression that many are beginning to see the sector as the Cinderella of the construction boom.

### IN THIS ISSUE

Innovative Reciprocating Chillers from Carrier	2
Standard Control Systems – Going for Further Growth	3
Sound Seal™ ... Sounds Off!	4
Energy Show 2000 Preview & Catalogue	6
News & Product Information	30
Dan Chambers Looks to the Future	38
Securing Long-Term Benefits from BMS	39
Control Aer ... Promising a Breath of Fresh Air	40



NEW TO THE MARKETPLACE

## Innovative 30GK Reciprocating Chillers from Carrier

As part of Carrier's determined strategy to focus on continuous quality and reliability improvements, the company has developed the innovative reciprocating chiller range 30GK 085 - 245, which will replace the current reciprocating chiller range 30GH/GZ 085 - 245. There are 11 different sizes ranging from 240kW to 730kW.

The rationale behind the introduction of the new reciprocating chiller model 30GK are:-

- Component rationalisation with the Global Chiller 30GX;
- Prodialog 4;
- Siemens control panels;
- Lower manufacturing cycle time.

The main selling features for the new 30GK reciprocating chillers are:-

- Up to 30% footprint reduction;
- Reduced height (-180mm);
- Noise reduction: 2dB in average over 30GH/GZ;
- COP slightly higher than 30GZ (2% in average);
- Standard disconnect switch.

The 30GK series of air-cooled liquid chillers is designed for operation with refrigerant HFC-407C as standard to meet new environmental protection requirements, while R22 is available as an option. These chillers feature extra-quiet operation and a new ecological refrigerant, and offer an ideal solution for chilled water production.

The new, ecological refrigerant, HFC-407C, has an ozone depletion potential of zero and is not affected by international regulations on the usage

of CFCs and their derivatives. It is a blend of HFC-32, 125 and 134a and, as it is produced and distributed worldwide, it is widely available.

These new HFC-407C chillers have been designed using specific refrigeration components and new production methods and are backed by thousands of hours of laboratory and field tests.

The new version of the second-generation revolutionary, low-noise, shrouded axial "flying bird" fan is made of a composite plastic material which is fully recyclable. Together with a further reduction of compressor noise transmission (discharge muffler, anti-vibration mountings), this results in a uniform chiller sound spectrum and eliminates intrusive low frequency noises.

Excellent part-load energy efficiency is assured through use of multiple compressors and electronic expansion valves. As the chiller rarely operates at full load, significant savings are ensured. This reduced power consumption also contributes to limiting the greenhouse effect, resulting from power generation from fossil energy.

There are two independent refrigerant circuits. The second one takes over automatically when the first one malfunctions, maintaining partial cooling under all circumstances.

Rigorous factory tightness tests and use of temperature or pressure sensors without capillary tubes eliminate the risk of leaks. Shut-off valves permit isolation of the refrigerant charge in the heat exchangers. Maintenance operations become less frequent and more effective.

Contact: Austin McDermott, Core Air Conditioning. Tel: 01 - 294 3110; Fax: 01 - 294 3115; email: coreac@iol.ie Website: ireland@iol.ie/~coreac

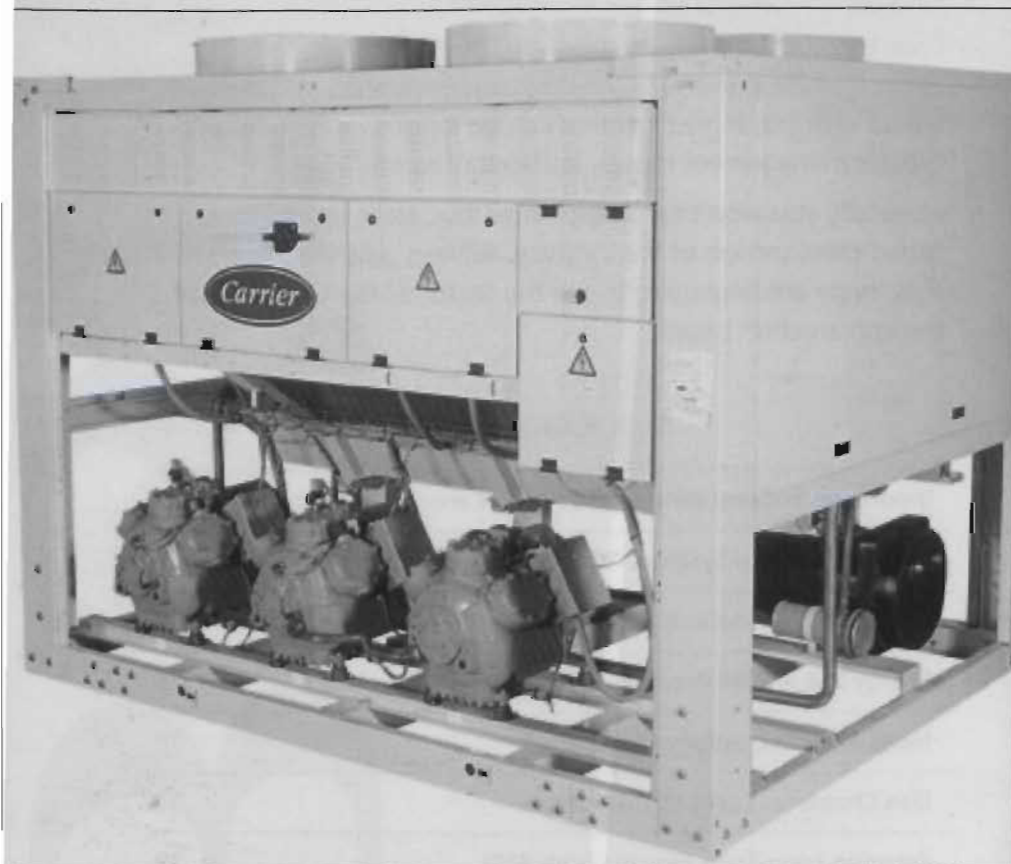

Carrier 30GK reciprocating chiller from Core Air Conditioning.



# Going for Further Growth

Standard Control Systems celebrate their continued success over the past 16 years with the launch this month of their new corporate brochure (see insert with this issue).

They are also proud to announce the appointment of Linda Healy and Michael Cullen to the board, as project directors. This brings to six the number of directors, with Cormac Walsh as MD, John Roe as Chairman, and Sean O'Toole and Declan McDonnell as Sales/Marketing and Technical Directors respectively.

The launch of the new image is, as Cormac Walsh is at pains to point out, more to do with substance than style. The contention now is that the company is extremely well positioned in the market to build on its past successes. As Cormac stresses: "we now have a team of totally-committed people dedicated to providing our clients with a level of service heretofore unknown. Put simply, we want to continue to be the best in the business".

Indeed, it is no mean feat to be still striving for growth at a time when many within the industry have thrown their arms up in despair at issues such as attraction and retention of staff. Standard Control Systems have managed to achieve phenomenal growth, even when involved in the largest and most tightly-programmed BMS contract ever undertaken in this country. The BMS installation at the new European headquarters of the Xerox Corporation in Dundalk is due for completion in May 2000.

Many highly-qualified and experienced engineers were recruited to cater for the increased workload.

The approach the company took was to tackle the project with a discrete group of highly-skilled engineers working out of the company's Dundalk office. "The objective was to have a dedicated 'Xerox' team, equipped to tackle the design and commissioning of the project without letting it impact on our other important clients and projects", says Cormac Walsh.

This approach has also worked well on other projects, such as the IBM Campus development at Mulhuddart,



Wyeth Medica in Newbridge, and Cadbury Schweppes in Russia.

Standard Control Systems are now concentrating, more than ever, on improving the diversity of their products and services. They have introduced the Trend card access system, which interfaces with the Trend BMS. They have also developed the BMS to communicate directly with commonly-used pager systems.

Another important development that has taken place is the introduction of the new Trend 962 front-end software. This software system provides the user with several key benefits, namely:

- Multiple users can benefit from simultaneous operation;
- Intuitive software ensures real ease of use;
- Internet Explorer V.4 or 5 is the only software required on client PCs;

- Information is tailored to match user needs;
- Site wide access is enabled using existing IT structure;
- Designed for flexibility to suit any application;
- Active graphics.

Using 962, it would be an easy and inexpensive matter to give BMS access to hundreds of people within a building, allowing them, say, to adjust their local air conditioning and/or lighting. Someone such as an on-call engineer, who wants to interrogate a system remotely, could do so using a laptop and mobile phone. To minimise call charges, connection could be made via the Internet.

Standard Control Systems prides itself on the partnership approach that it adopts with its customers.

They are renowned for working with consultants and contractors to get the job done and for ensuring the technical integrity of the project above all else. Furthermore, they have carved out quite a niche in the area of design-and-build type projects where they work closely with consultants and contractors to compete for specific projects.

They are also well versed in carrying out BMS/controls-related workshops with consultants, where the strength of the systems as they are today can be demonstrated, and a methodology gone through on the appropriate selection and utilisation of controls devices.

For more information please contact Sean O'Toole or John D'Arcy at Standard Control Systems.

Tel: 01-6246100; Fax: 01-6246105;  
email: scs@eircom.net  
Website: www.Standardcontrol.com



ACOUSTIC ENCLOSURES

# Sound Seal = Sounds Off!

United Process Inc of America is the creator of the Sound Seal™ flexible acoustic curtain. It manufactures a wide range of materials and composites for noise control use within industry. Traditionally, in Ireland acoustic enclosures are rigid and are manufactured from block, concrete, and steel among other composites. Where rigid enclosures offer excellent noise reduction, they have limitations.

NCRL Ltd in Dublin were sceptical, to say the least, when they first began talks with United Process Inc, primarily because all of their enclosures were rigid. "However, it didn't take long to convince us of the benefits of a flexible acoustic enclosure", says Ciaron King. "As a result of this, Sound Seal Europe™ is now a wholly-owned division of NCRL Ltd".

One of the most popular material compositions for the acoustic panels is the BSC-25. This is one of the standard Sound Seal Europe™ acoustic materials available and comprises a combination of a

quilted fibreglass sound-absorption material with a loaded vinyl noise barrier septum. It is fabricated into modular acoustic curtain panels with grommets at the top, and hook and loop fasteners along each edge. Individual panels are joined together to form any configuration necessary.

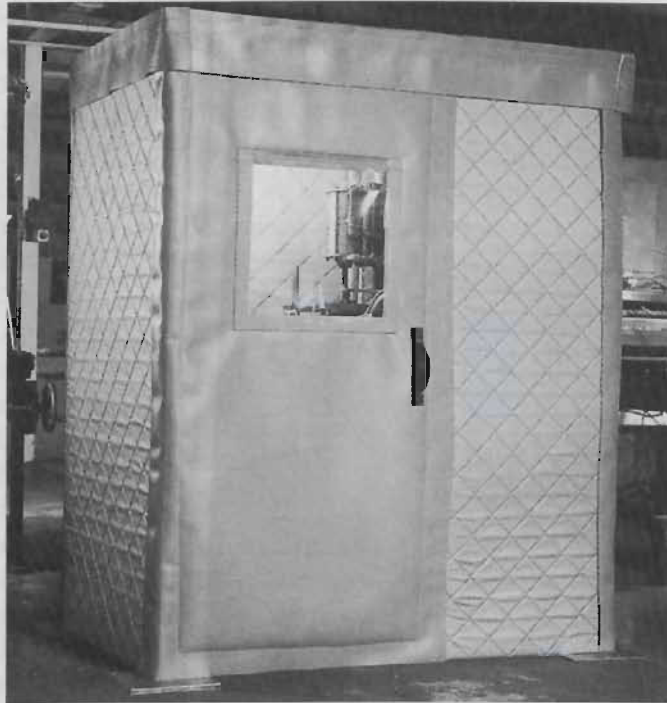

SONEX curtain Enclosure System™ from Noise Control Research Laboratories Sound Seal Division

An excellent example of the acoustic capabilities of this material was demonstrated at the Portland Museum of Art. Director of facilities Kevin Eames had a new air conditioning system installed. The new chiller was causing a disturbance, generally, the levels were 93 dB(A), with the

dominate disturbing frequencies at 250, 500 and 1,000 Hz. A Sound Seal™ BSC-25 enclosure was constructed around the chiller. The results were more than satisfactory.

- (1) The acoustic enclosure brought the work space noise levels down to 73 dB(A) – a reduction of 20 dB(A);
- (2) The Sound Seal™ vent baffles were placed to duct air over the hot spots, thus causing the chiller to be properly cooled, and the work space to be at normal temperatures;
- (3) The noise of the chiller in the museum viewing area is lost in the ambient background levels of the low 50's.

Contact: Ciaron King, Noise Control Research Laboratories.  
Tel: 01 - 667 1077; Fax: 01 - 667 1055;  
email: ncr1@eircom.net

Field Measured Noise Reduction								
Octave Band Center Frequencies (Hz)								
Location/Frequency	A	125	250	500	1K	2K	4K	8K
Equipment Room	93	74	86	89	88	82	68	60
Location 1 Before (6' from chiller)								
Location 1 After (6' from chiller)	73	70	68	73	69	63	60	53
Noise Reduction	20	4	18	16	19	19	8	7





## Adap-Kool® Refrigeration Controller Systems

"With the new AK Mimic monitoring software, supermarket refrigeration is treading completely new paths within the control and monitoring of refrigeration plant", says Dave Killalea of Danfoss Ireland.

"In the old days, a service technician had to be found when a fault occurred, even though the fault might well have been a minor one. With AK Mimic, it is now possible for shop personnel to correct minor problems themselves using the user-friendly graphical interface".

In principle, AK Mimic is a complete PC consisting of all necessary hardware and software. The user interface is built on the familiar AK monitor software, supplemented with graphical plant layout. It is often the case that shops are not interested in having a PC with AKM software. This might be because there is a shortage of space, or because of the fact that unauthorised users might create problems in the refrigeration system. However, with AK Mimic, the shop can have a PC that it is so compact it can be placed on the wall and used for its proper purpose ... monitoring the refrigeration system.

The user interface is also flexible and can be built up precisely as the customer wants.

With AK Mimic it is possible to define different access levels so that appointed employees are

able to make corrections to the more advanced settings in the refrigeration system, while others only have access to system monitoring. AK Mimic is suitable for use in all refrigerated areas and supplements the familiar ADAP-KOOL® product range.

The user friendliness of AK Mimic is also a big advantage for the refrigeration installer. The ease with which the icons can be used makes it possible for the installer to design the system for the individual shop, without having to involve Danfoss specialists.

AK Mimic represents a new area for ADAP-KOOL® refrigeration control systems. Market reaction has been positive, and the next version of the product is already under development.

AKA 310 and AK Mimic software are now a part of

the overall ADAP-KOOL® system. For the end user, AKA 310 is the visible part in the shop, while many other Danfoss products are hidden away behind the scenes. The ADAP-KOOL® Refrigeration Control System comprises a number of products that together create the possibility of monitoring, control and optimisation of the refrigeration plant. As regards both function and price, the system can be combined to suit the requirement of individual customers.

As a monitoring system the ADAP-KOOL® Refrigeration Control System provides the complete alarm monitoring of all temperature and other operating data. In the event of an alarm condition, a signal is sent to AKA 310 and the shop personnel will be able to analyse it. Outside of shop opening hours, alarms can also be sent to an external service company via a normal modem connection.

Temperature and data registration is performed by, for example, AKL 111A, a monitoring unit with eight temperature inputs and five digital inputs. The number of AKL 111A units installed will, of course, depend on the size of the supermarket.

If complete control and optimisation of the refrigeration plant is required, a display case controller from the AKC 100 series can be combined with electronic injection valves and AKC 25H5 regulators that take care of the compressor/condenser side.

Since the AKC controllers contain much more information on how the plant operates, the service company is able to use its modem connections to provide remote service. This gives better service planning and minimises the number and the duration of operating problems. The AKC controllers are intelligent and adapt themselves to given operating conditions, ie, they ensure optimum interaction between evaporators, compressors and condensers. The results are lower energy consumption, reduced loss of goods and improved food quality.

Examples of savings show a 12-25% reduction in energy consumption during optimum operation, and the more efficient use of service resources.

Contact: David Killalea, Danfoss Ireland.  
Tel: 01 - 626 8111;  
Fax: 01 - 626 9334;  
Marketing email: sampson@indigo.ie

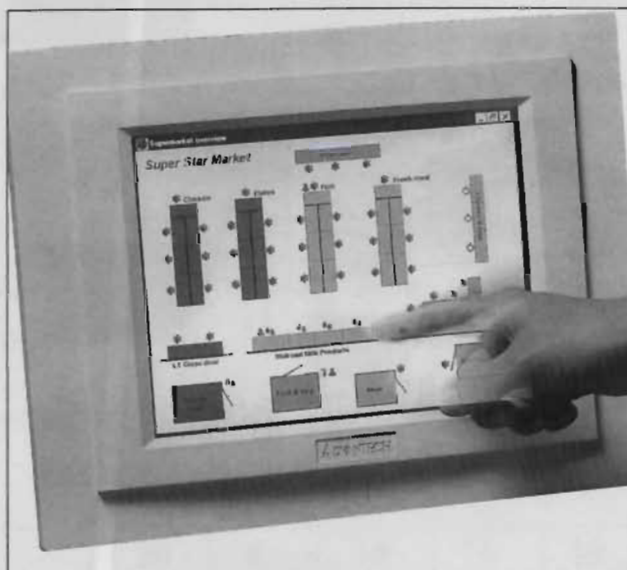

The AKA 310 graphical user interface makes it possible for shop personnel to correct minor problems themselves.



# Honeywell & Cylon from McCool

The Aquatrol 2000 is a versatile, multiple-function controller providing optimum start/stop; outside air-compensated flow control of mixing valve or direct with the heating boilers' boiler sequence control of up to two boilers; domestic hot water service (DHWS), either combined with the heating boilers or separate.

A full range of valves and actuators is available from which a comprehensive series of standard applications (Aquaplan) can be configured to meet most popular system requirements.

The Honeywell CX Series

inverters feature a range of integrated functions which eliminate the need for additional peripheral equipment. This includes programmable logic controllers, PID controllers, timers, and digital-analogue converters and signal conditioners. The CX Series is compatible with bus, supporting the Excel 5000

valves are used for modulating control of hot or chilled water or steam in heating, ventilating and air conditioning systems and can be operated by electric linear actuators as ML6420/25 and ML7420/25, or M6421 and M7421, or by pneumatic MP953.

Complementing these is a range of small linear valves used in combination with the M6520A/M6521B/M7521a small electric linear

efficiency, environmental comfort and effective management.

Key features of Unitron are simplicity, flexibility, power and speed.

Unitron is easy to adapt or extend and brings an unmatched scope of application. From basic stand-alone control, to the cohesive supervision of remote sites, up to large installations with many points. Third party functions – such as fire and

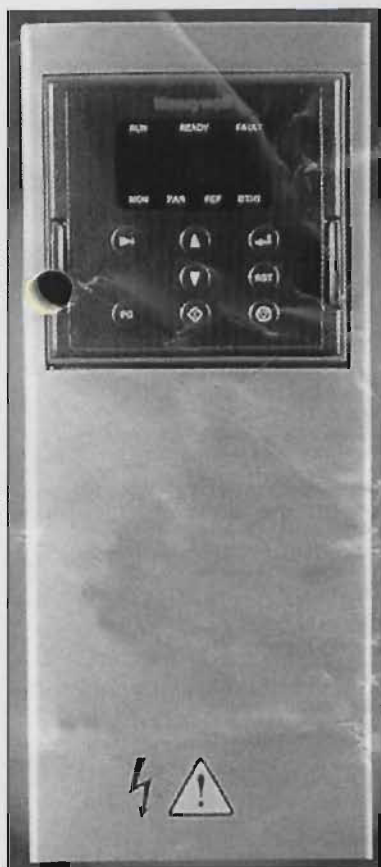

Honeywell CX Series Inverters from McCool Controls.

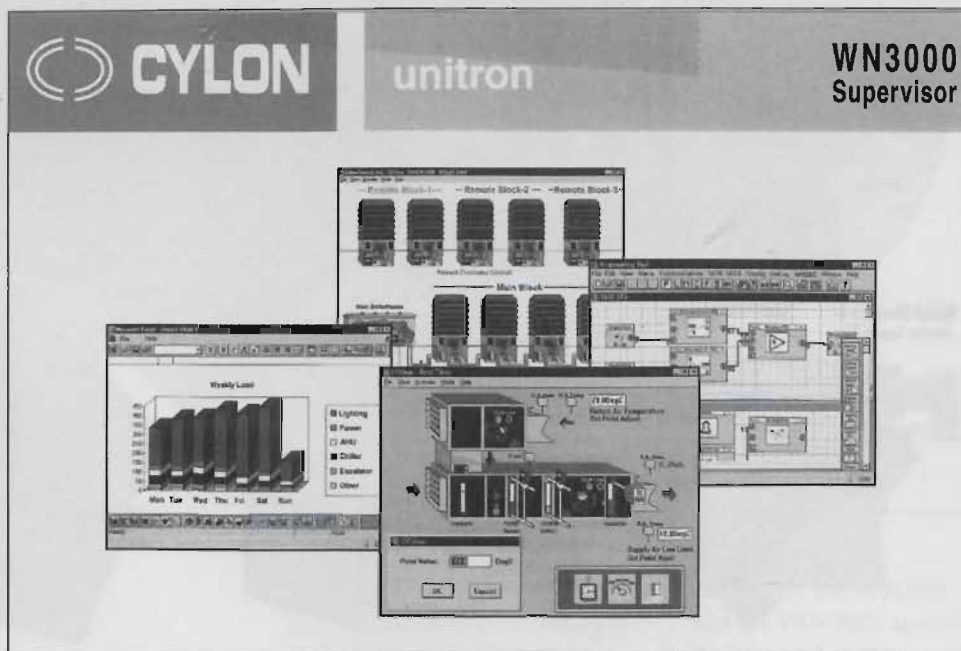

Cylon Unitron WN3000

range of controllers and the Echelon bus protocols.

Honeywell also provides a full range of complementary control products, from simple room devices to complex electronic sensors. Among these are the new "ValPac" range of valves, actuators and fittings, and the low-cost range of air differential pressure switches.

Also from Honeywell is a range of flanged linear valves. These 3-port mixing

actuator for the control of hot and/or cold water for fan coil units, small reheaters and coolers in electric temperature control systems.

The Cylon Unitron system provides a comprehensive solution to building and estates management, but it is also cost-effective for HVAC in small premises. Unitron controls and monitors all types of building services and utilities for energy

security – may be integrated to enhance operation, while server links to office networks allow datalogs, meter readings and maintenance alarms to be freely shared across departments. All this is achieved with a minimum of system components.

Contact: Finn McCool/Jeff Zacherl, McCool Controls. Tel: 01 - 855 0542; Fax: 01 - 855 0546.



# Noise Control Products For Industrial & OEM Applications



Portable Enclosures

VBD-10 Damping Compound & Soundamp E Sheets

Acoustical Pipe & Duct Lagging

Curtain Systems

Barriers

Quilted Fiberglass & Barrier Composites

Quilted Fiberglass Absorbers

Acoustical Wall Panels & Ceiling Baffles

- ◆ **SOUND ABSORPTION/NOISE BARRIER ACOUSTICAL CURTAIN SYSTEMS** are rugged and tough enough to handle the harshest industrial environment. STC ratings up to 33 offering significant noise reduction while allowing for complete accessibility, as well as visibility and ventilation. Easy installation on floor mounted, suspended, and wall mounted frames.
- ◆ **PORTABLE ACOUSTICAL ENCLOSURES AND SCREENS** are free-standing portable units which can be supplied with any of Sound Seal's quilted fiberglass or absorber/barrier composite panels. Perfect as machinery partitions, dividers or welding shields. Quick and easy installation. Also available, complete three or four-sided portable enclosures including windows, ventilation and roof tops.
- ◆ **QUILTED FIBERGLASS AND BARRIER COMPOSITES** are used in OEM applications to control noise in engine compartments and transmission housings. Also suitable for industrial applications, these absorber/barrier combinations are available in panels, rolls or custom configurations and are impervious to harsh environments.
- ◆ **ACOUSTICAL WALL PANELS AND CEILING BAFFLES**- Overhead baffles and wall mounted blankets are an effective, economic method of reducing reverberant noise in industrial or architectural environments. They are designed to improve acoustical conditions by introducing "soft" absorptive materials into an otherwise "hard" reflective environment. Perfect for theaters, auditoriums, sports facilities and industrial buildings. Also available FDA approved sanitary baffles.
- ◆ **QUILTED FIBERGLASS ABSORBERS** are fire safe, high performance, acoustic blankets used in OEM, in-plant and architectural applications. Constructed for superior mechanical strength, they are unaffected by moisture, humidity, dust, dirt, oils and most chemicals. NRC to 1.05, FMVSS 302 acceptable, fire safe class 1. In-house die cutting and custom fabrication satisfies any design requirement.
- ◆ **VBD-10 DAMPING COMPOUND AND SOUNDAMP E SHEETS**- Structure-borne vibration can be effectively and economically reduced with a simple application of either product. Damping compound may be brushed, troweled or sprayed. Paintable when dry. Meets ASTM E-162 and E-662 (Smoke and Flame). Wide temperature range. Ideal for OEM applications including rail, bus and marine. Excellent in industrial applications. Self adhesive damping sheet is .060" thick. Meets UL-94. Cuts easily to any size.
- ◆ **BARRIERS**-Flexible noise barriers are limp, tough, high-temperature-fused loaded vinyl with nonlead fillers and/or reinforced with high strength fabric. Perfect for applications requiring performance under moderate or severe temperature conditions. USDA acceptable, transparent noise barriers, high temperature and specialty barriers are available, including a Class 1 Flammability rated barrier.
- ◆ **ACOUSTICAL PIPE & DUCT LAGGING**- Features a loaded vinyl noise barrier with a reinforced aluminum foil facing. Used for wrapping steel, iron and plastic pipes, sheet metal duct work, and noisy valves indoors and outdoors. Excellent durability and corrosion resistance, high conformability and easily installed. Also available in composite form with a 1" or 2" quilted fiberglass absorber.

**SOUND SEAL™ EUROPE**  
Noise Control Research Laboratories Ltd  
11 Fitzwilliam Quay, Ringsend, Dublin 4, Ireland

Tel: 353+1+6671077, Fax: 353+1+6671055  
Web: www.ncrl.net E-mail: ctking@ventac.ie

Sound Seal Acoustical Products offer maximum noise reduction for minimum dollars. Curtain Panels and composite materials are Class 1 Flammability rated with STC rating up to 33 and NRC rating to 1.05.



## Super Innovative Actuators and Valves

EPH Controls Ltd, the Irish distributors for Sauter precision controls, will use the occasion of The Energy Show 2000 to unveil a number of new product introductions. These include the following:-

**AVM/AVF**  
electromechanical actuator – A stepping motor, an intelligent electronics control unit and a conventional spring ... these inner qualities put Sauter's innovative AVM/AVF actuator way ahead of the opposition. There is the unique ability to move the AVF drives with emergency function to a pre-defined position (ie open/closed) in the event of a power failure or on switching off. Whether you choose the AVM with, or the AVF without, the emergency function, you get an actuator which — due to its compactness and high degree of protection — will perform reliably, even in the most restricted of spaces and the most demanding of environments.

Although it can handle 350 N, the new gearbox design means that it needs little power to do so and is practically silent in doing it. The LED indicators keep you fully informed of what's going on.

Without having to open the drive, you can use the lever to move it to the preferred position. Extensive accessories – such

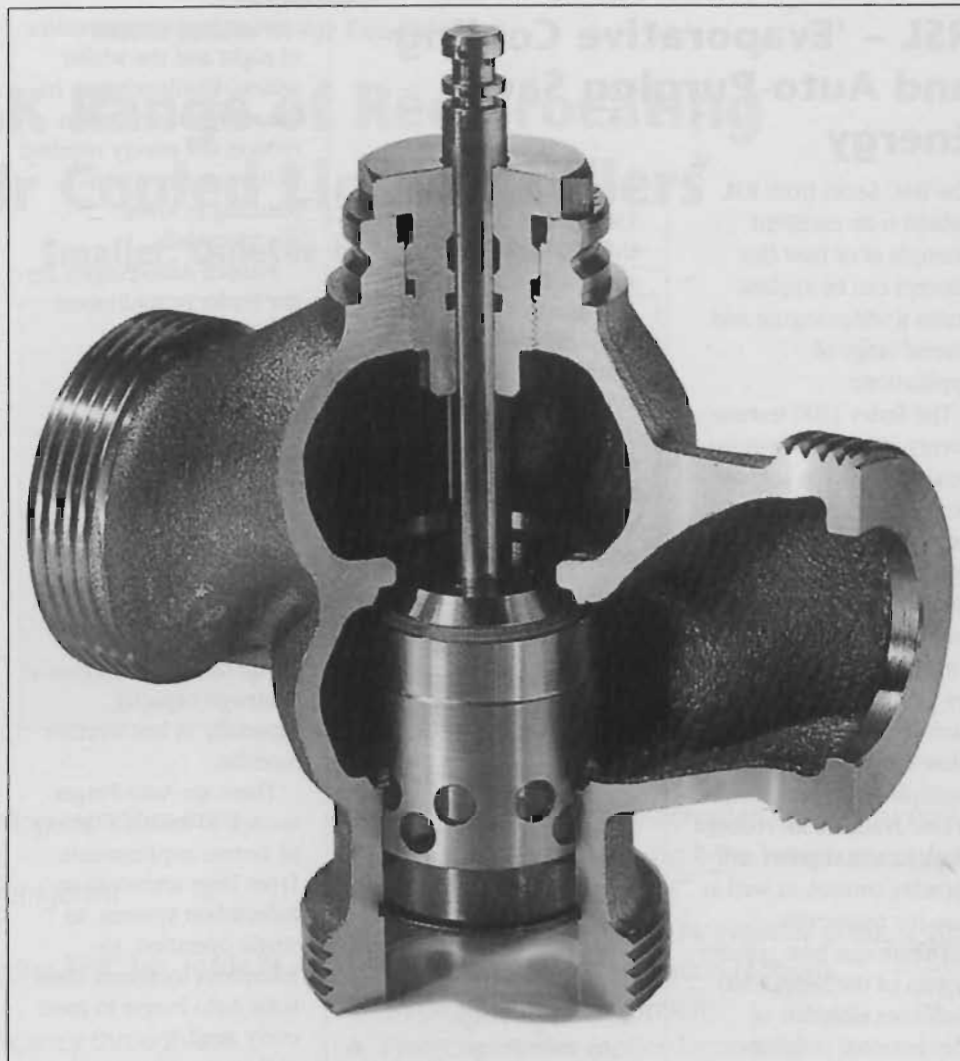

Sauter VXN/BXN male-thread valve from EPH Controls.

as auxiliary contacts or a potentiometer – are available.

Also new from Sauter is a range of VXN/BXN valves with male thread which was designed especially with the new drives (and industry requirements) in mind. They are available in sizes of DN 15 to DN 50.

Since they are intended to be operated at a nominal pressure of PN 16, these valves are very versatile. They can be used with hot or cold water or with low-pressure steam up to 115°C; a soft seal reinforced by Teflon and fibre glass ensures that the valves close tightly. The

valve and the drive are easily matched ... fitting is simple and no setting is necessary.

The actuator adapts itself automatically to the amount of valve stroke. On the drives with positioner, you can choose (even just before fitting) between three types of characteristic curve – linear, equal-percentage or quadratic. Because of the AVM/AVF drives' electronic adaptability to various requirements, you need to keep only a few different versions in stock.

As the latest additions to Sauter's family of drives

and valves, the AVM/AVF and the VXN/BXN are yet further proof of the company's know-how in this very specialist field. The whole concept of the drive makes it easy to fit it to the valve. Above all, though, the perfect teamwork between drive and valve is convincing because of its inner qualities ... whether with or without emergency function.

Contact: Trevor Casey,  
EPH Controls.  
Tel: 021 - 346238;  
Fax: 021 - 341271;  
email: eph@indigo.ie  
Web: sauter-controls.com



## RSL – ‘Evaporative Cooling and Auto-Purging Save Energy

The BAC Series from RSL Ireland is an excellent example of how this concept can be applied across a wide-ranging and diverse range of applications.

The Series 1500 features energy-efficient, low-noise axial flow fans to achieve very low fan motor requirements – one third to one half that is required by comparably-sized centrifugal fan units. Units with multiple fan motors are provided with plenum partitions as standard to allow fan cycling. The multiple fan motor system is also available for reduced energy consumption and capacity control, as well as standby protection.

The unique heat transfer system of the Series 1500 combines elements of conventional crossflow cooling towers and counterflow fluid coolers for enhanced closed-circuit cooling performance. Improved performance makes the Series 1500 fluid coolers and cooling towers ideal for close temperature approaches and difficult thermal duties. The Series 1500 is extremely cost-effective for such applications as condenser water cooling and process machinery cooling.

The compact size and single air inlet design of the Series 1500 allows better utilisation of space. Smaller, less costly enclosures can be used and units can be placed in narrow setbacks or close to solid walls. On noise-

sensitive projects, the Series 1500 is well suited due to the use of low-noise fan systems as standard. Additionally, lower sound levels can be achieved with optional sound attenuation.

The Series 1500 is designed to minimise installation costs for both new and replacement projects. A low operating weight requires less expensive support steel and the numerous support alternatives provide the ability to re-use existing support steel.

Examples from the full range will be demonstrated on the RSL Ireland stand, where personnel will be on hand to answer technical questions.

Also featured on the stand will be the Hansen Auto-Purger range.

An Auto-Purger noncondensable gas (air) purger quickly and efficiently removes air from a refrigeration system. Noncondensable gases, primarily air present in a refrigeration system, increase condensing pressures. Air also reduces the overall capacity of the refrigeration system by acting as an insulator, which increases the amount of time compressors must run.

The increased run-time of compressors, in turn, increases the energy required to operate the system throughout the year. This is true not only during the hot ambient temperatures of summer days, but also during the

cool ambient temperatures of night and the winter season. Eliminating air in the refrigeration system reduces the energy required to operate the system, resulting in lower electricity bills.

Hansen Auto-Purgers are the leader in multipoint purging. Multipoint purging is the only effective method for removing all air from a refrigeration system. In addition, the large air-removal capacity of Hansen Auto-Purgers allows a very large amount of air to be removed quickly. This helps ensure that the refrigeration system runs at its design capacity, especially in hot weather months.

There are Auto-Purger models to match a variety of system requirements. From large ammonia or halocarbon systems, to single operation, to hazardous locations, there is an Auto-Purger to meet every need.

Contact: Gerry McDonagh, RSL (Irl).  
Tel: 01 - 450 8011;  
Fax: 01 - 456 7512;  
email: gerry@rslireland.com

## The Hydri range of compressors & Retrofit Kits from Hanley

The Hydri range of CompAir Hydrovane compressors from Hanley Air Systems offer the user an unbeatable combination of performance and reliability.

Based on the award-winning CompAir Hydrovane compressors, the Hydri range is available in eight sizes ranging from 1.1kW to 75kW.

All CompAir Hydrovane compressors are manufactured to the highest quality standards. Hydri compressor packages are supplied as a complete, compact, self-contained unit, producing ultra-clean dry compressed air.

Hydri kits contain all the necessary components to convert a standard Classic 01-04 RM to produce ultra-clean dry compressed air.

The Hydri range has been designed to supply high-quality air directly

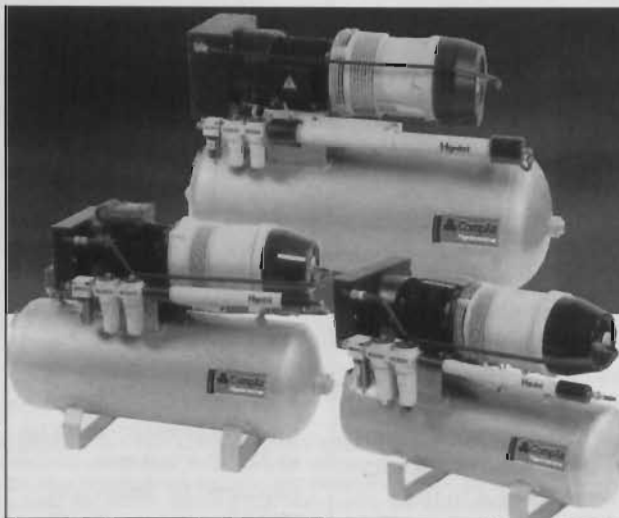

The Hydri range of compressors and retrofit kits from Hanley Air Systems.





World Leader In Air Conditioning

## 30GK Range of Reciprocating Air Cooled Liquid Chillers

Smaller, Quieter & More Efficient

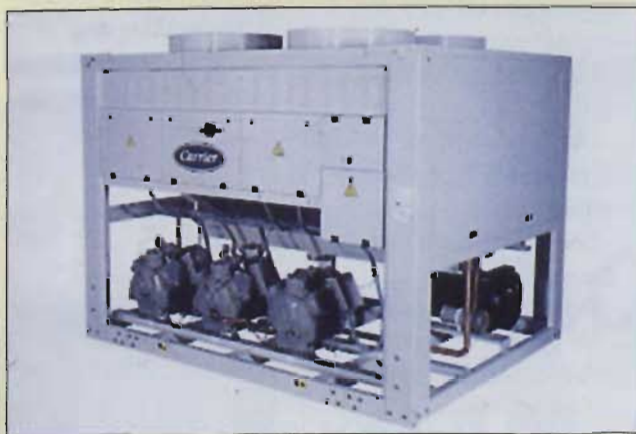

### Features

- ◆ Eleven sizes with nominal cooling capacities from 240 to 725 kW.
- ◆ Designed for operation with refrigerant HFC-407C.
- ◆ Low-noise, shrouded axial "Flying Bird" fan, made of composite plastic material.
- ◆ Excellent part-load energy efficiency through use of multiple compressors and electronic expansion valves.
- ◆ Two independent refrigerant circuits, maintaining partial cooling under all circumstances.
- ◆ Rigorous factory tightness tests and use of temperature or pressure sensors without capillary tubes eliminate the risk of leaks.
- ◆ Shut-off valves permit isolation of the refrigerant charge in the heat exchangers.

### Options and Accessories

- ◆ Special condenser anti-corrosion treatments (option).
- ◆ Low and very low leaving brine temperatures (option).
- ◆ Refrigerant R-22 (option).
- ◆ Condenser fan with 150 Pa available pressure (option).
- ◆ Compressor sound insulation (option).
- ◆ Tropicalised version (option).
- ◆ Protection grilles (option/accessory).
- ◆ Part-winding compressor start (option).
- ◆ High and low pressure protection and display for lead compressor or all compressors (option).
- ◆ Head pressure control for low outside temperature applications (fan speed variation) (option/accessory).
- ◆ Compressor suction valve (option).
- ◆ Evaporator with fewer or more baffles (option).
- ◆ Capacity reduction (one per lead compressor, 30GK 100-170) (option).
- ◆ 50% heat reclaim (option).
- ◆ Desuperheater (option).
- ◆ RS485 communications interface with open protocol (accessory).



AIR CONDITIONING LTD

Unit C1, Three Rock Road, Sandyford Industrial Estate, Dublin 18.

Tel: 01 - 294 3110; Fax: 01 - 294 3115;

email: [coreac@iol.ie](mailto:coreac@iol.ie) Website: [ireland@iol.ie/~coreac](http://ireland@iol.ie/~coreac)



World Leader  
In  
Air Conditioning



THE ENERGY SHOW 2000 PREVIEW

from the package, no additional parts are necessary.

Typical applications are: breathing; co-ordinate measuring; dentistry; electronics; instruments; laboratories; laser equipment; machine tools; medical; OEM applications; optical instruments; packaging; paint spraying; pneumatic control; printing; robotics; and spectrometers.

The Hydri package incorporates a unique design after-cooler with water drain, double-stage filtration, and the most advanced membrane drying technology.

The Hydri membrane dryer has been sized to give optimum dewpoint with minimal sweep air.

Typical performance – Pressure dewpoint depression -40°K below ambient temperature up to 20% Sweep air.

**Main Benefits**

- Engineered package for optimum performance;
- Complete, compact and ready to use;
- Ultra clean air (cleanliness to 0.01 micron);
- Ultra dry stored air (typically -40°K pdp below ambient);
- Completely silent dryer operation;
- Dry air stored in receiver;
- No receiver corrosion;
- Full stop/start control.

Contact: Finbar Keenaghan, Hanley Air Systems. Tel: 01 - 822 4822; Fax: 01 - 822 4833; email: finbar@dublin.hancon.ie

## The 2000i Family of Indicators and Alarm Units from Eurotherm Ireland

High accuracy measurement and display of temperature and other process variables, versatile alarm handling and advanced communication facilities are the hallmarks

- Calibration set for life: Assured accuracy without recalibration;
- Alarm outputs: For operator alert and plant protection;
- Front panel

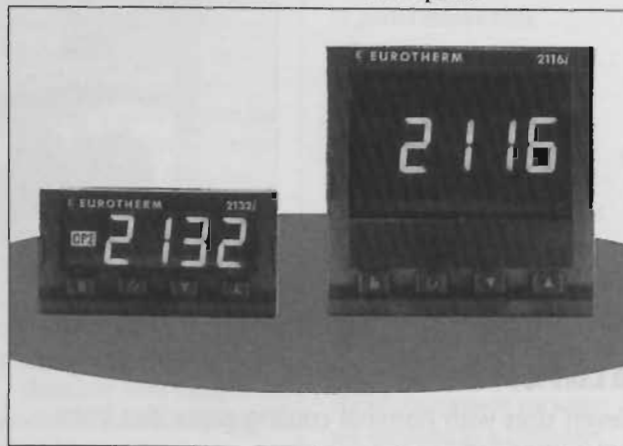

Series 2132i/2116i compact indicator and alarm units from Eurotherm Ireland

of the 2000i family of indicators and alarm units from Eurotherm Ireland. Complementing the Series 2000 range of PID controllers, the four new models share identical styling, operation and configuration. This consistency in appearance and operation helps reduce maintenance, training and operating costs.

Innovative design and advanced manufacturing methods provide enhanced features and performance.

- Key benefits include:-
- Bright, clear LED displays: Good visibility in high and low ambient lighting;
  - Universal input: Covers a wide range of temperature and process inputs;

- configuration: Easy, on-site set-up;
- Customer linearisations: Allows customer- defined linearisation curves;
- Wide-range supply: Can be used worldwide;
- Tactile buttons: Friendly to use;
- Plug-in from front: Rapid replacement, reducing downtime;
- Three year warranty: Low ownership cost.

Contact: Aidan Finnegan, Eurotherm Ireland.  
Tel: 045 - 879937;  
Fax: 045 - 875123;  
email: aidan.finnegan@controls.eurotherm.co.uk

•continued on page 29



CompAir offers a comprehensive range of equipment and accessories under the 'Cascade' name. Details from Hanley Air Systems.

# Official Catalogue

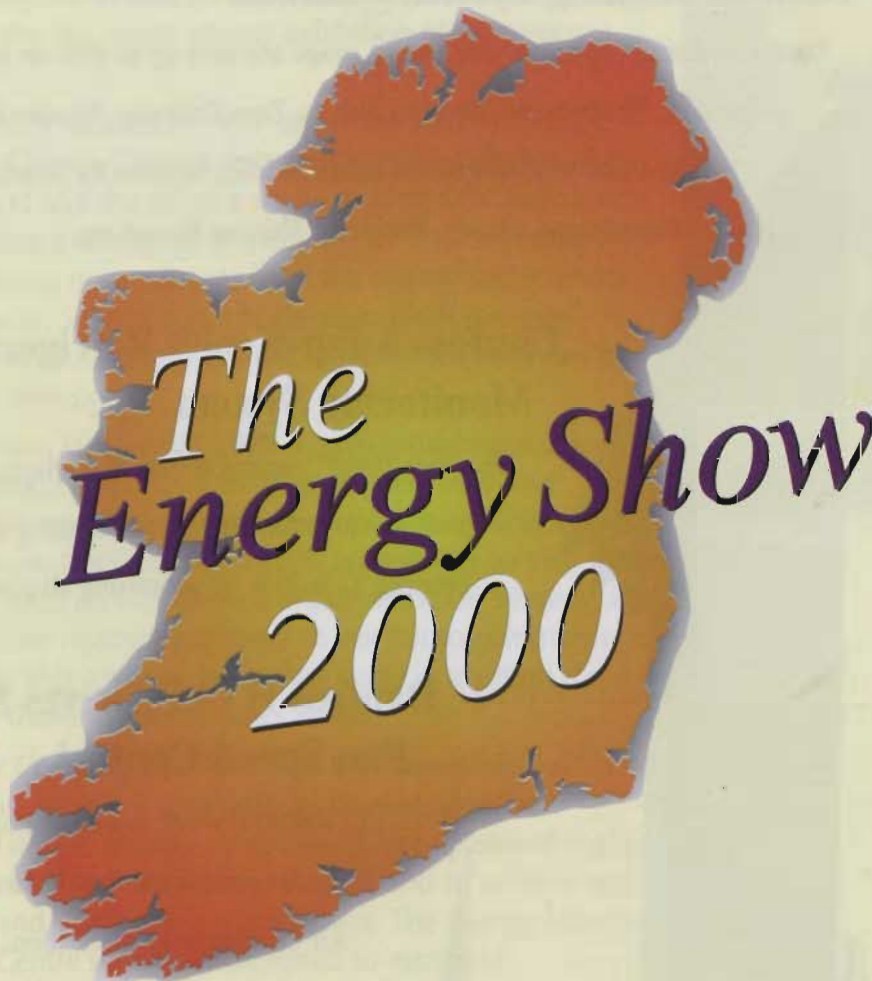

## Exhibition & Workshops

Industries Hall,  
RDS, Dublin

Wednesday, 17th &  
Thursday, 18th May 2000



IRISH ENERGY CENTRE

The Irish Energy Centre is an initiative of the Department of Public Enterprise and is supported by the EU through the Community Support Framework.



# Energy Controls in Action ...

## ✓ Danfoss Heating System Controls

Danfoss Controls optimise your energy usage and save up to 20% on your heating bills. A wide range incl., Thermostatic Radiator Valves, Zone Controls, Weather Compensators, and Under-Floor heating systems offers an ideal solution for Apartments, Office Blocks, Guesthouses, Hotels, Hospitals, Nursing Homes etc.

## ✓ Danfoss Adap-Kool® Refrigeration Control and Monitoring System

The "Intelligent" control system that adapts to the actual operating conditions to reduce energy and running costs saving between 12%-25% by optimising all plant parameters.

## ✓ Danfoss HVAC Drives for Pumps and Fan Speed Control

VLT®6000 HV-AC is a dedicated designed Speed Drive for pumps and fans in Heating, Ventilation & Air Conditioning applications.



The Danfoss logo, featuring the word "Danfoss" in a stylized, red, cursive font.

### Danfoss Ireland Ltd

Nangor Road Business Park, Dublin 12  
Tel: 01 - 626 8111; Fax: 01 - 626 9334  
Marketing E-Mail: sampson@indigo.ie



# Welcome to the Energy Show 2000

## Message from The Minister

I have great pleasure in welcoming you to Dublin for The Energy Show 2000, the first major energy exhibition of the new millennium.

The Kyoto Protocol, drafted in 1997 under the UN Framework Convention on Climate Change, sets tough and legally-binding targets for Ireland and the EU as a whole to limit CO<sub>2</sub> emissions. We face a significant challenge in meeting our commitments on limiting greenhouse gas emissions from the energy sector under the Kyoto Protocol. Simply put, a business as usual scenario would see Ireland substantially exceed its permitted increases in greenhouse gas emissions.

Since the show was last held in 1998, I have published a Green Paper on Sustainable Energy. This paper establishes a new framework for energy efficiency and the use of renewable energy sources, and sets out policies considered appropriate to Irish circumstances. With an enlightened implementation strategy, I believe that we can respond positively to our Kyoto commitments — commitments that are merely the first stage in meeting the climate change challenge in the years ahead.

The Irish Energy Centre is an initiative of the Department of Public Enterprise. Its role is threefold: to develop positive attitudes to sustainable energy, to accelerate the uptake of energy efficient and renewable energy technologies; and to achieve real energy savings and CO<sub>2</sub> emission reductions. The Energy Show is just one of the Centre's activities designed to assist Irish companies improve their competitiveness, while helping to achieve national environmental goals.

The high level of interest in the show to date is encouraging and I believe that this is an indication of the increasing number of companies who now see energy efficiency, not just as a global imperative, but as a genuine business opportunity. The combined activities of the technology workshops and the exhibition, with over 80 exhibitors, should satisfy the evident demand for information, allowing informed decisions to be made in the months and years ahead.

May I finish by wishing all show participants a successful and enjoyable time at The Energy Show 2000.

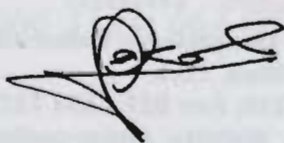

Mr Joe Jacob T.D.  
Minister of State at the Department of Public Enterprise







[www.codema.ie](http://www.codema.ie)



A Dublin Corporation Initiative

**CODEMA** – The City of Dublin Energy Management Agency – has been commissioned by Dublin Corporation to design a website featuring a compilation of water-saving fixtures and fittings commonly used in the domestic and café markets.

The aim of the website is to actively promote water conservation in accordance with the 1999 City Development Plan and the 1996 Dublin Water Strategic Study. The website will be a valuable resource to architects, engineers and building contractors.

A list of the 20 most commonly used water devices installed in houses/apartments and hotels i.e., taps, showerheads, cisterns etc has been compiled. Manufacturers/suppliers of these waterconsuming devices have been invited to send in details of their products, which are then rated according to litres/minute. The top 10 in each category are then featured on the website with relevant contact details included. There is also a separate category for ideas which is open to the general public.

The obvious benefit to this project are promoting awareness of water as a valuable and precious resource while stimulating the construction industry towards reduced water consumption.



City of Dublin Energy Management Agency

**CODEMA**

Contact: Claire Bourke, Project Manager,  
CODEMA, Paradigm House,  
Dundrum Office Park, Dublin 14.  
Tel: +353 - 1 - 296 4072;  
eMail: [codema@iol.ie](mailto:codema@iol.ie)

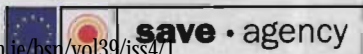

## NEW from SAUTER

**AVM/AVF actuator and  
VXN/BXN valve.**

**Fit together perfectly.  
And fit anywhere.**



**Bursting with ideas: a unique combination of stepping motor, intelligent control electronics and return spring.**

A stepping motor, an intelligent electronics control unit and a conventional spring ... these inner qualities put Sauter's innovative AVM/AVF actuator way ahead of the opposition. There is the unique ability to change the characteristic of the valve from linear to equal-percentage and also to choose the running times all the touch of a switch, with LED indication to keep you fully informed.

Whether you choose the AVM or the AVF you get an actuator which will perform reliably in the most demanding of environments.

The VXN/BXN valves with male thread are available in sizes of DN15 to DN50 with a working pressure of PN16. For further information call to us at Stand F9.

ELECTRO PNEUMATIC & MECHANICAL

**EPH**  
CONTROLS

**5 Doughcloyne Court, Doughcloyne Industrial Estate,  
Wilton, Cork.**

**Tel: 021 - 434 6238; Fax: 021 - 434 1271;  
email: [eph@indigo.ie](mailto:eph@indigo.ie) Website: [sauter-controls.com](http://sauter-controls.com)**



# Useful Information

## Opening Hours

Wednesday, 17th May — 10.00am to 6.00pm

Thursday 18th May — 10.00am to 5.00pm

## Official Opening

The official opening of the Energy Show 2000 will be performed by Minister Joe Jacob, TD, Minister of State at the Department of Public Enterprise

## Organisers Office

Located to the right of the main entrance

## First Aid

Please contact the Organisers Office

## Press Office

Please contact the Organisers Office for all Press information

## Catering

Situated at the back of the hall

## Parking

Car parking exists for over 1,000 cars in the RDS Complex.

## Lost Property

All enquiries regarding lost property should be made through the Organisers Office.

## Telephones

Public telephones are located to the left of the main entrance

## Taxi Service

Taxis are available by calling the following numbers:

668 3333; 667 0474; 661 2233; 455 5555; 454 4070; 283 6634; 475 0800

## Organised by

Business Exhibitions Ltd, Exhibition House, 6 Sandyford Office Park, Dublin 18.

Tel: 01 - 295 7418; Fax: 01 - 295 7417; email: bizex.ie



# The Energy Show 2000

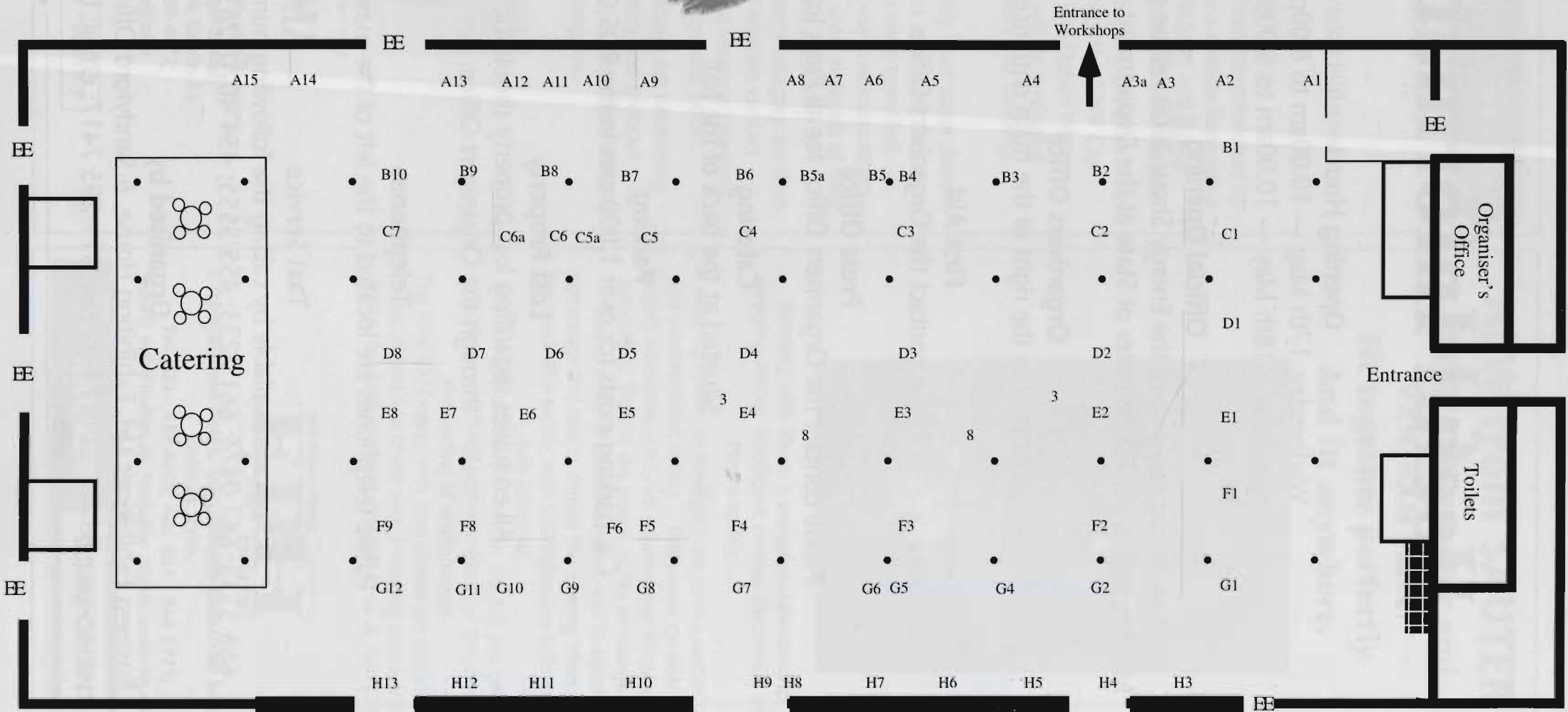

**THE ENERGY SHOW - ALPHABETICAL LISTING OF EXHIBITORS**

ABB Group.....	F6/F8	KB Combustion.....	B10
Air Technology .....	A7	Keston Heating Products .....	C5
Albar Associates .....	A9	LEM UK .....	B5
Atlas Copco Ireland .....	F1/G1	Liebert U.P.S. ....	G6/G7
Axiom .....	C7	Lighthouse Communications .....	B6
Baltimore Aircoil.....	G4	Manotherm .....	A15
Belimo Automation.....	A13	McCool Controls & Engineering.....	F4
Bord Gais.....	B4	Measureit Technology .....	H14
Casey Consulting .....	B6	Mitsui Babcock Energy Services .....	F2
Cetetherm AB .....	A10	Motogen (Electric) .....	G6/G7
CODEMA .....	C3	Natural Energy .....	A4
CompAir Broomwade.....	D5	NEG Micon UK .....	A2
Concord Boiler Engineering .....	B8	Northern Ireland Electricity.....	D2
Cummins Engine Company.....	D1/E1	Pacific Science and Technology .....	C7
Cummins Power Generation .....	D1/E1	Parkersell Lighting Services (Irl) .....	E7
Cylon Controls .....	H15	Planet Advantage .....	H11
D E Generator Hire .....	D4	Power Logic.....	A14
Dalkia .....	E7	Prolux .....	G12
Danfoss (Ireland).....	E5	RSL (IRL).....	G4
Delta Trak .....	E8	S.D.M.O Generators.....	G6/G7
Diesel Engines Ireland.....	D4	Safair Systems .....	A13
DP Energy Limited.....	C6	Safeguard Systems.....	A13
Dunlop Design Engineering .....	F5	Sauter HVAC Controls .....	F9
Dunstar .....	B3	Scan Energy & Environmental Services .....	A1
Ecomb AB .....	G2	Schneider Electric Ireland .....	A14
Edina.....	F3	Sermet OY.....	G2
Edina .....	E3	Siemens .....	E2
EFT Control Systems.....	G10	Sinergy .....	C7
Eirtricity .....	B2	Spirax Sarco.....	B7
Ekströms AB .....	G2	Stark Software Systems.....	C7
Electric Drives.....	D3	TechCon Sales.....	E8
Energy IT.....	D7	Telemecanique .....	A14
Enron Wind Corp. Ireland.....	C4	The Institute of Energy Belfast .....	D2
EPH Controls .....	F9	Thermpak Systems .....	A10
ERDA (Environmental Research & Design Associates .....	A3a	Thermwatch Ireland .....	A6
ESB .....	E4	Veris Industries Inc. ....	E8
Eurotherm Ireland .....	C2	Vestas Wind Systems A/S .....	A1
GaleForce Wind Turbines (NI) .....	B5a	Viridian Power Resources .....	D2
Gardiner Energy Management.....	A8	Viterra Energy Services .....	E8
Garo Electrical Agencies.....	A11	Wärtsilä NSD Ireland .....	E6
Green City Denmark A/S.....	A3	Wind, Water, Solar Energy Systems .....	A4
Green Innovation.....	A3	Woodleigh.....	C7
GWM Associates.....	G2		
Hanley Air Systems .....	D5		
HDS Energy .....	A5		
Holfeld Engineering.....	H9		
Honeywell Control Systems.....	F4		
Ingersoll Rand .....	G8/G9		
Invensys Brook Crompton .....	G6/G7		
Invensys Flow Control UK.....	D6		
Irish Bioenergy Association (IrBEA) .....	A12		
Irish Energy Centre.....	B1/C1		
Irish Energy Management .....	D8		

The Energy Show 2000 Exhibition is organised on  
behalf of the Irish Energy Centre by:

Business Exhibitions Ltd,

Exhibition House, 6 Sandyford Office Park, Dublin 18.

Tel: 01 - 295 7418; Fax: 01 - 295 7417;

eMail: [energy2000@irish-energy.ie](mailto:energy2000@irish-energy.ie)



THE ENERGY SHOW - DETAILED EXHIBITOR LISTING

**ABB Group  
F6/F8**

Belgard Road, Tallaght, Dublin 24, Ireland  
Tel: 01-405 7380 Fax: 01-405 7319  
Contact: Mr Richard Walsh

ABB Combined Heat and Power Installations the best investments to reduce your energy costs. ABB 100 years of supplying turn key energy solutions. ABB experience is over 2000 installations in CHP across 14 countries. Significantly reduce costs in all kinds of industries. State-of-the-art technology and performance. ABB Master Control - advanced level control and monitoring with over 950 CHP units on line via tele-metric. Optimum service for error free operation.

**Air Technology**

**Stand: A7**

5 Victoria Mill, Fowke Street, Rothley, Leicestershire LE7 7P, England  
Tel: 116-230 1750 Fax: 116-230 1751  
Contact: Mr Darren Webb - Sales Engineer  
Air Technology has established itself as the U.K.s leading provider of energy saving solutions, troubleshooting and project work in the fields of compressed air, water and inert gases. Established in 1987 Air Technology has evolved a range of expert skills and services designed to meet industry's ever growing need to conserve energy.

**Albar Associates**

**Stand: A9**

Meridian House, Road One - Winsford Industrial Estate, Winsford, Cheshire CW7 3QG, England  
Tel: 1606-861 351 Fax: 1606-861 643  
Contact: Mr Mike Dorgan - Partner  
The latest ATLAS 2000 energy metering system plus  $\mu$ -log,  $\mu$ -Atlas and Mini ATLAS provide the energy monitoring and reporting package of all resources, plus production if required, for any organisation. Also presented is a range of kWh pulsing meters and the Profile portable energy recorder for purchase or hire.

**Atlas Copco Ireland**

**Stand: F1/G1**

Kylemore Road, Bluebell, Dublin 12, Ireland  
Tel: 01-450 5978 Fax: 01-456 7686  
Contact: Mr Joe Newman  
Average saving of 35% on energy costs is achievable with Atlas Copco Variable Speed Drive compressors, the only VSD compressors available with integrated frequency converters, refrigerant dryers, oil/water separators and a whole range of other facilities. Atlas Copco also offer the only 100% oilfree VSD compressors on the market

**Axiom**

**Stand: C7**

65a Moyle Road, Dublin Industrial Estate, Glasnevin, Dublin 11, Ireland  
Tel: 01-830 3311 Fax: 01-830 3313  
Contact: Mr Liam Ward - Sales Manager  
Details available on stand.

**Baltimore Aircoil**

**Stand: G4**

48 Robinhood Industrial Estate, Clondalkin, Dublin 22, Ireland  
Tel: 01-450 8011 Fax: 01-456 7512  
Contact: Mr Gerry McDonagh  
Details available on stand.

**Belimo Automation**

**Stand: A13**

Unit 34 Southern Cross Business Park, Bray, Co. Wicklow, Ireland  
Tel: 01-276 1600 Fax: 01-276 1611  
Contact: Mr Shaun McGill  
Damper actuator and air volume control.

**Bord Gais**

**Stand: B4**

D'Olier Street, Dublin 2, Ireland  
Tel: 01-602 1212 Fax: 01-602 1110  
Contact: Mr Ger Harnett  
Details available on stand.

**Casey Consulting**

**Stand: B6**

Lacken Lodge, Dublin Road, Kilkenny, Ireland  
Tel: 086-244 0729 Fax: 056-70 041  
Contact: Mr Conor Casey  
Details available on stand.

<https://arrow.tudublin.ie/bsn/vol39/iss4/1>  
DOI: 10.21427/D7J128

**Cetetherm AB**

**Stand: A10**

Unit 92 Dunlop Commercial Park, 3 Balloo Link, Bangor, Co. Down, Northern Ireland  
Tel: 2891-463 737 Fax: 2891-463 797  
Contact: Mr Ivan Johnson - Director  
Cetetherm AB Ronnerby Sweden - Leading manufacturers of plate heat exchangers and systems.

**CODEMA**

**Stand: C3**

Paradigm House, Dundrum Office Park, Dublin 14, Ireland  
Tel: 01-296 4072 Fax: 01-296 2484  
Contact: Ms Claire Bourke - Co-ordinator - Dr Gerry Wardell - Director  
CODEMA - The City of Dublin Energy Management agency, on behalf of their client Dublin Corporation, will launch and demonstrate their website for water saving fixtures and fittings, to actively promote water conservation, in accordance with the objectives set out in the 1999 City Development Plan and the 1996 Dublin Region Water Strategic Study.

**CompAir Broomwade**

**Stand: D5**

Westpoint Industrial Park, Mulhuddart, Dublin 15, Ireland  
Tel: 01-822 4822 Fax: 01-822 4833  
Contact: Mr Finbar Keenaghan - Manager  
Details available on stand.

**Concord Boiler Engineering**

**Stand: B8**

Marrowbone House, 58 Marrowbone Lane, Dublin 8, Ireland  
Tel: 01-453 2727 Fax: 01-453 3849  
Contact: Mr Jim Byrne - Sales Engineer  
Concord Boilers - 40 years in business, supplies, services, repairs and hires new and reconditioned steam boilers from 210 45,000 lb/hr. A sole distributor of FULTON Boilers in Ireland, we will have the latest "J" series FULTON Steam Boiler on display. Special 5% discount on orders placed at the show.

**Cummins Engine Company**

**Stand: D1/E1**

Hibernian Industrial Estate, Greenhills Road, Tallaght, Dublin 24, Ireland  
Tel: 01-452 7111 Fax: 01-452 7238  
Contact: Mr John Kennedy - Sales Manager  
Supply and installation of Diesel Generating jet and gas power plant up to 2mw, manufactured by Cummins Power Generation. Multiple installations available. Sales office in Dublin with dealers throughout Ireland.

**Cummins Power Generation**

**Stand: D1/E1**

Manston Park, Columbus Avenue, Manston, Ramsgate, Kent CT12 5BF, England  
Tel: 1843-255 000 Fax: 1843-255 902  
Contact: Mr Tony Freshwater - A&P Distribution Manager  
Details available on stand.

**Cylon Controls**

**Stand: H15**

14 IDA Centre, East Wall Road, Dublin 3, Ireland  
Tel: 01-836 6626 Fax: 01-836 5108  
Contact: Mr Stuart Aynsley - Marketing Director  
Cylon Controls are an Irish manufacturer of Building Automation and Energy Management Systems. Cylon are by far the market leader in Ireland but also have substantial exports into other markets world-wide. A network of approved Cylon System Integrators covers the country to give the added benefit of local engineering and supports.

**D E Generator Hire**

**Stand: D4**

Naas Road, Clondalkin, Dublin 12, Ireland  
Tel: 01-403 4100 Fax: 01-459 1864  
Contact: Mr Sean M Smyth - Manager  
Diesel Generator Hire with 24 hour back up service. 10KVA to 2000KVA. Hire sales and back up service countrywide. Load banks and cable also available.



## Dalkia

Stand: E7

Unit 4, Dryden Vale, Bilston Glen, Edinburgh EH20 9HN, Scotland  
Tel: 131-440 1877 Fax: 131-440 2551  
Contact: Ms Zoe Lucas

'Managing Energy is our business' - Dalkia one of the leading providers of energy and integrated services management to businesses throughout the UK and Ireland. Established for over 30 years, we provide solutions developed in partnership with client organisations in both the private and public sectors, Dalkia, people, services, results...the integrated solution to add value to your business environment.

## Danfoss (Ireland)

Stand: E5

Unit 1A, Nangor Road Business Park, Dublin 12, Ireland  
Tel: 01-626 8111 Fax: 01-626 9334

Contact: Ms Tracy O'Connor - Marketing Co-ordinator - Mr Brian F. Maguire Sales Manager Heating Controls /HVAC Product Division  
Details available on stand.  
Email:- sampson@indigo.ie

## Delta Trak

Stand: E8

"Sorrel", Manor Kilbride, Blessington, Co Wicklow, Ireland  
Tel: 01-458 2449 Fax: 01-458 2770

Contact: Mr Tony Lewis - Sales Engineer  
Details available on stand.

## Diesel Engines Ireland

Stand: D4

Naas Road, Clondalkin, Dublin 12, Ireland  
Tel: 01-403 4100 Fax: 01-459 1864

Contact: Mr Sean M Smyth - Manager  
Generators to suit any application! In the home or on the construction site! Automatic standby to mains or manual start! Indoor or outdoor! Silent or super silent! Petrol or Diesel!

## DP Energy

Stand: C6

Mill House, Buttovant, Co. Cork, England  
Tel: 022-23 955 Fax: 022-23 027

Contact: Ms Maureen De Pietro - Director  
Developers of renewable energy projects, including Wind Farms (both small and utility scale) and production of energy from Biomass

## Dunlop Design Engineering

Stand: F5

2 Old Scaravor Road, Tandragee, Co. Armagh, BT6 2ED, Northern Ireland  
Tel: 2838-840 909 Fax: 2838-841 815

Contact: Mr Walton Dunlop - Sales Executive  
Dunlop Design Engineering Ltd., is a specialist supplier of Hot Water Systems, Heat Recovery and Waste Water Systems, and Laundry Equipment with custom-designed installations throughout the UK, Ireland and Europe. Offering a range of solutions based on the world's leading industrial equipment, Dunlop currently supplies major organisations in the textile, food, process manufacturing, laundry and concrete industries.

## Dunstar

Stand: B3

1 Kent Street, Clonakilty, Co Cork, Ireland  
Tel: 023-35 165 Fax: 023-35 174

Contact: Dr. Paul Sikora - Managing Director  
Dunstar is a provider of turnkey systems for renewable energy heating and cooling. Completed projects include dwellings, (1,500 to 8,000 sq. ft.); commercial offices, heritage building reconstruction and leisure / tourism and health care facilities. Solterra Systems are practical and financially interesting today.

## Ecomb AB

Stand: G2

Boughton Pumping Station, Brake Lane, Boughton, Newark, Nottinghamshire NG22 9HQ, England  
Tel: 1623-862 515 Fax: 1623-862 672

Contact: Mr Gerry Wareham - UK / Ireland Representative  
Design and turnkey supply of pollution control systems suitable for retrofit and new installations. Patented technology offers improved combustion for all forms of solid fuels including municipal waste, biomass and coal.

## Edina

Stand: F3

142a Slaney Close, Dublin Industrial Estate, Glasnevin, Dublin 11, Ireland  
Tel: 01-830 7788 Fax: 01-830 7422

Contact: Mr Paul Kavanagh - General Manager  
Specialists in co-generation /CHP

## Edina

Stand: E3

142a Slaney Close, Dublin Industrial Estate, Glasnevin, Dublin 11, Ireland  
Tel: 01-830 7788 Fax: 01-830 7422

Contact: Mr Paul Kavanagh - General Manager  
Specialists in generator sales, hire and service.

## EFT Control Systems

Stand: G10

Unit 36 Dargle Road Business Centre, Dargle Road, Bray, Co Wicklow, Ireland  
Tel: 01-286 3999 Fax: 01-286 8412

Contact: Mr Craig Ennis - Director  
Development and integration of UtilityManager™ the totally integrated Energy and Utility Management Software Suite that delivers bottom-line profit by monitoring, controlling and reducing Utility costs. Consultancy, Fast track and Turnkey systems available.

## Eirtricity

Stand: B2

8 Dawson Street, Dublin 2, Ireland  
Tel: 01-240 9348 Fax: 01-240 9349

Contact: Ms Mary Griffin  
Eirtricity is Ireland's first brand of green electricity and it can deliver savings of up to 10% on electricity consumed in your business. To find out how to reduce your electricity bill, while helping the environment, contact eirtricity at 1850 40 40 80 -email info@eirtricity.ie - www.eirtricity.ie

## Ekströms AB

Stand: G2

Boughton Pumping Station, Brake Lane, Boughton, Newark, Nottinghamshire NG22 9HQ, England  
Tel: 1623-862 515 Fax: 1623-862 672

Contact: Mr Gerry Wareham - UK / Ireland Representative  
Suppliers of extended surface energy conservation heat exchangers including economisers and air heaters. Extensive reference lists including biomass; waste to energy; fossil fuels with applications ranging across central utility power generation, industrial and maritime installations.

## Electric Drives

Stand: D3

Newbridge Industrial Estate, Newbridge, Co. Kildare, Ireland  
Tel: 045-433 044 Fax: 045-433 622

Contact: Mr John Dwan - Drives Division Manager  
Electric Drives will have on display their range of energy efficient three phase electric motors, together with variable speed drives and soft starts.

## Energy IT

Stand: D7

PO Box 110, Ware, SG12 8XG, England  
Tel: 1920-872 969 Fax: 1920-872 979

Contact: Mr Richard Morgan - Sales Engineer  
Energy IT is a European market leader in the energy monitoring systems, providing both the hardware and software solution for most applications. With many utility suppliers and multi-national organisations throughout Europe utilising the system we offer one of the most modern, flexible and reliable systems available in the market today.

## Enron Wind Corp. Ireland

Stand: C4

Coolboyoge, Co. Cavan, Ireland  
Tel: 049-32 233 /087 245 4530 Fax: 049-31 435

Contact: Mr Herman Busschots  
Turbine Manufacturer/Wind Farm Developer. Zond 550 Series full span pitch regulated WTG. Zond 750 series full span pitch regulated, variable speed WTG. Tacke TW600A, active stall regulated WTG. TackeTW1, SMW pitch regulated variable speed WTG. Tack TW2MW pitch regulated variable speed off-shore WTG.



THE ENERGY SHOW - DETAILED EXHIBITOR LISTING

**EPH Controls**

**Stand: F9**

5 Doughcloyne Court, Doughcloyne Industrial Estate, Wilton, Cork, Ireland  
Tel: 021-346 238 Fax: 021-341 271  
Contact: Mr Trevor Casey  
Details available on stand.

**ERDA (Environmental Research & Design Associates)**

**Stand: A3a**

Gleneely, Near Carndonagh, Co. Donegal, Ireland  
Tel: 077-67 321 Fax: 077-67 348  
Contact: Mr Barney Walsh - Partner  
ERDA is an environmental consultancy and renewable energy practitioners. We work in wind, solar and geothermal, also in reed bed waste treatment systems. Our work involves planning and E15 services, within educational, green tourism and community projects. We also design and build green energy powered private homes and developments.

**ESB**

**Stand: E4**

Lower Fitzwilliam Street, Dublin 2, Ireland  
Tel: 01-702 6309 Fax: 01-702 6881 email: dave.reynolds@mail.esb.ie  
Contact: Mr David Reynolds - Key Account Manager  
ESB has extensive experience of working with customers to help you get the best value from your electricity. We offer a range of services including: Energy Efficiency Audits; Power Quality Surveys; Computerised Energy Management Systems; Training Services.

**Eurotherm Ireland**

**Stand: C2**

IDA Industrial Estate, Monread Road, Naas, Co Kildare, Ireland  
Tel: 045-879 937 Fax: 045-875 123  
Contact: Mr Martin Curran - Area Sales Manager  
Eurotherm Ireland Ltd. a member of the Invensys group, is a leading supplier of Instrumentation and Control Systems. With offices in Naas, Cork and Athlone Eurotherm offers a broad range of products, ranging from graphic, strip and circular recorders, data loggers, temperature controls, thermosensors, solid state relays and power controllers, variable speed drives, control systems and off the shelf or customer specific software.

**GaleForce Wind Turbines (NI)**

**Stand: B5a**

Unit P8 Enkalon Industrial Estate, Randalstown, Antrim, BT41 4LD, Northern Ireland  
Tel: 28-9446 4301 Fax: 28-9442 8835  
Contact: Mr Andy Whitelaw - Managing Director  
Suppliers of latest wind turbine systems to the domestic and commercial market. Sizes from 800w to 10kw. Full warranty and guarantees on every system - Free Delivery

**Gardiner Energy Management**

**Stand: A8**

The Wool House, 12 St. Thomas Street, Bristol, BS1 6JJ, England  
Tel: 117-907 7377 Fax: 117-907 7378  
Contact: Mr Tim Gardiner - Managing Director  
GEM Ltd. will demonstrate the operation of the "GEM Trap" on stand A8. The GEM Trap is a revolutionary venturi orifice steam trap. Having no moving parts to corrode or wear out, they improve safety, control, reliability and efficiency. With minimal maintenance it is also guaranteed against failure for 10 years.

**Garo Electrical Agencies**

**Stand: A11**

126 Broombridge Close, Glasnevin, Dublin 11, Ireland  
Tel: 01-830 3499 Fax: 01-830 6307  
Contact: Mr Paul Fox - Sales Manager  
GARO will be exhibiting the DIRIS System from SOCOMEC. The system comprises a complete range of metering, multi-measurement, harmonic analysis, control and energy management instruments. Each instrument can operate on a stand alone basis or directly interface with P.C.  
<http://www.tudublin.ie/bsn/vol39/iss4/1>  
DOI: 10.21427/D7J128

**Green City Denmark A/S**

**Stand: A3**

Merkurvej 910, DK-7400 Herning, Denmark  
Tel: 97 21 64 00 Fax: 97 21 74 21  
Contact: Mr Martin Høj  
The Danish national showcase for energy and environmental technology and know-how. Green City Denmark with at present 242 shareholders being private companies, municipalities, counties, and institutions from all over Denmark. The main purpose is to market Danish expertise within environmentally sound production and sustainable solutions for waste treatment, water supply, waste water, energy supply/renewable energy sources/energy savings, urban ecology, etc. In October 2000, Green City Denmark organises partner meetings in Dublin between Irish and Danish side. E-mail: info@greencity.dk  
Internet: www.greencity.dk

**Green Innovation**

**Stand: A3**

Østerstradsvej 4, 7752 Snedsted, Denmark  
Tel: 97 93 66 04 Fax: 97 93 66 04  
Contact: Mr Hamish Stewart  
Details available on stand.

**GWM Associates**

**Stand: G2**

Boughton Pumping Station, Brake Lane, Boughton, Newark, Nottinghamshire NG22 9HQ, England  
Tel: 1623-862 515 Fax: 1623-862 672  
Contact: Mr Gerry Wareham - Senior Partner  
Supply of engineering / project management services and specialist products for the design / construction of power plants. Services range from feasibility studies to installation / commissioning. Products include biomass combustion plants; heat recover economisers; pollution reduction systems, all suitable for cogeneration and combined cycle installations.

**Hanley Air Systems**

**Stand: D5**

Westpoint Industrial Park, Mulhuddart, Dublin 15, Ireland  
Tel: 01-822 4822 Fax: 01-822 4833  
Contact: Mr Finbar Keenaghan - Manager  
Hanley Air Systems are distributors for CompAir Broomwade and Hydrovane who are among the most respected names in the World in this technology. With three Customer Service Centres in Dublin, Cork and Lurgan, which are all well-equipped for emergency backup and major repairs. The Services Centres are on call 24 hours a day - 365 days a year. All our Engineers are factory trained only using genuine CompAir spare parts and oils. Hanley Air Systems is part of the Hanley Control Group.

**HDS Energy**

**Stand: A5**

Celbridge Ind Estate, Celbridge, Co Kildare, Ireland  
Tel: 01-627 1011 Fax: 01-627 1015  
Contact: Mr Alan Fox - Director  
HDS Energy, sponsors of the Irish Energy Centre's National Boiler Awards 2000, are recognised as leaders in the European marketplace for the design and manufacture of boiler plant and ancillary equipment. It excels in the customisation and engineering of turnkey energy projects, the scope and reach of the company - both technologically and geographically - offering existing and new customers over 50 years of proven engineering experience. The service provided is all-embracing, covering the planning, design and construction of major energy-related projects. HDS is committed to the development of its expertise and reputation in a responsible manner so as to benefit both the customer and the environment.

**Holfeld Engineering**

**Stand: H9/H10**

2 Merville Road, Stillorgan, Co Dublin, Ireland  
Tel: 01-288 7361 Fax: 01-283 6293  
Contact: Mr John O'Reilly - Sales Manager Industrial Division  
Details available on stand.



## THE ENERGY SHOW - DETAILED EXHIBITOR LISTING

**Ingersoll Rand****Stand: G8/G9**

Unit 6, JFK Drive, Bluebell, Dublin 12, Ireland.  
Tel: 01-817 9487 Fax: 01 - 8179489  
Details available on stand.

**Invensys Brook Crompton****Stand: G6/G7**

2A Sunbury Industrial Estate, Ballymount Road, Walkinstown, Dublin 12, Ireland  
Tel: 01-450 8366 Fax: 01-450 6762  
Contact: Mr Pat Cregan - Director  
Details available on stand.

**Invensys Flow Control UK****Stand: D6**

Burrell Road, Haywards Heath, West Sussex, RH161TL, England  
Tel: 1444-314 400 Fax: 1444-314 401  
Contact: Mr Denis Fox - Area Sales Manager (Ireland)  
Details available on stand.

**Irish Bioenergy Association (IrBEA) Stand: A12**

Education Centre, Church Street, Cahir, Co. Tipperary, Ireland  
Tel: 052-43 090 Fax: 052-43 012

Contact: Mr Seamus Hoyne - Secretary

The Irish Bioenergy Association (IrBEA) was officially launched in May 2001. Its aim is to promote Biomass as an environmentally, economically and socially sustainable indigenous energy resource and also promote its non-energy-related benefits. Membership is open to those who support its aims and objectives. IrBEA covers the Republic or Ireland and Northern Ireland is officially affiliated to AEBIOM, the European Bioenergy Association.

**Irish Energy Centre****Stand: B1/C1**

Glasnevin, Dublin 9, Ireland  
Tel: 01-836 9080 Fax: 01-837 2848

Contact: Mr Tom Halpin - Marketing Executive

The Irish Energy Centre is an initiative of the Department of Public Enterprise and is supported by the EU through the Community Support Framework. The centre's mission is to support the development of a sustainable national energy economy. Increased energy efficiency and exploitation of renewable energy will serve to enhance the security of Ireland's energy supply, increase Ireland's economic competitiveness and reduce environmental impact.

**Irish Energy Management****Stand: D8**

8 Ballycurreen Industrial Estate, Kinsale Road, Cork, Ireland  
Tel: 021-4320 480 Fax: 021-4320 379

Contact: Mr John Maloney - Director

market leader in serving the energy needs of Irish Industry, offering energy auditing and consultancy, turnkey energy efficiency solutions and project management

**KB Combustion****Stand: B10**

Unit 5, Longmile Business Park, Longmile Road, Dublin 12, Ireland  
Tel: 01-456 4095 Fax: 01-456 4097

Contact: Mr Roy Birney  
Details available on stand.

**Keston Heating Products****Stand: C5**

Unit B6 Cookstown Business Centre, Cookstown Industrial Estate, Tallaght, Dublin 24, Ireland  
Tel: 01-462 1753 Fax: 01-451 7613

Contact: Ms Angela Forde - Director

Keston Heating Products has extended its range of high-efficiency boilers with the introduction of two commercial condensing boilers. They provide outputs of 76 and 100kW and achieve 98% gross efficiency. K.H.P. will also be showing its new Rotex System 70°C. This enables radiators and underfloor heating to be used without the need for separate pumps, mixing valves and sophisticated controls.

**LEM UK****Stand: B5**

1 Penketh Place, Skelmersdale, Lancashire, WN8 9QX, England  
Tel: 1695-720 777 Fax: 1695-507 04

Contact: Mr Frank Healy - Sales Manager  
Details available on stand.

**Liebert U.P.S.****Stand: G6/G7**

2A Sunbury Industrial Estate, Ballymount Road, Walkinstown, Dublin 12, Ireland

Tel: 01-450 8366 Fax: 01-450 6762

Contact: Mr Pat Cregan - Director

Details available on stand.

**Lighthouse Communications****Stand: B6**

The Innovation Centre, The National Technological Park, Limerick, Ireland

Tel: 061-330 880 Fax: 061-330 891

Contact: Mr Eamon O'Dea - Sales Manager

Details available on stand.

**Manotherm****Stand: A15**

The Control Centre, 4 Walkinstown Road, Dublin 12, Ireland

Tel: 01-452 2355 Fax: 01-451 6919

Contact: Mr Brian Harris - Mr Bob Gilbert

Details available on stand.

**McCool Controls & Engineering****Stand: F4**

Unit 20 IDA Centre, East Wall Road, Dublin 3, Ireland

Tel: 01-855 0542 Fax: 01-855 0546

Contact: Mr Finn McCool - Managing Director

Details available on stand.

**Measureit Technology****Stand: H14**

56 Southern Cross Business Park, Bray, Co Wicklow, Ireland

Tel: 01-276 8104 Fax: 01-276 8941

Contact: Mr Mark Rodford

Details available on stand.

**Mitsui Babcock Energy Services****Stand: F2**

Portfireld Road, Renfew, Renfrewshire, PA4 8DJ, Scotland

Tel: 141-885 3213 Fax: 141-886 3204

Contact: Mr Gordon Capie - Senior Sales Manager - Spares

Mitsui Babcock Energy is a UK based supplier of energy products, services and business solutions. The company has over one hundred years of experience in the design, manufacture, construction, installation, commissioning, operation, repair and maintenance of boiler plant including spares and ancillary equipment. In addition Mitsui Babcock offers a range of specialist services to optimise plant safety, reliability and performance.

**Motogen (Electric)****Stand: G6/G7**

2A Sunbury Industrial Estate, Ballymount Road, Walkinstown, Dublin 12, Ireland

Tel: 01-450 8366 Fax: 01-450 6762

Contact: Mr Pat Cregan - Director

MOTOGEN promoting their "Power Solutions" slogan will be exhibiting the energy efficient range of Invensys Brook Crompton electric motors, together with the S.D.M.O range of generating sets and their range of U.P.S. systems and power quality products.

**NEG Micon UK****Stand: A2**

Davaar, The Crescent, 5 Kelmorlie, Ayshire PA17 5DX, Scotland

Tel: 1475-521 518 Fax: 1475-521 518

Contact: Mr R. J. Leicester - Sales Manager

NEG Micon are manufacturers of wind turbines from 600kw to 2mw in size. Typical installations range from single turbines to large windfarms, both onshore and offshore. Turnkey contracts can be undertaken. Comprehensive after sales service is available.



THE ENERGY SHOW - DETAILED EXHIBITOR LISTING

**Northern Ireland Electricity Stand: D2**

Woodchester House, Newforge Lane, Belfast BT9 5NW, Northern Ireland  
Tel: 01232-661 100 Fax: 01232-685 035  
Contact: Mr David Guiney - Energy Efficiency Engineer  
NIE is promoting the Energy Efficiency Accreditation scheme in Ireland to encourage businesses to use energy more efficiently. The scheme is sponsored in Ireland by Northern Ireland Electricity; and is managed and controlled by the National Energy Foundation. It is also backed by the Confederation of Business Industries. Evaluations for the Accreditation Scheme are carried out by independent assessors who, review management commitment to energy efficiency, investment in efficiency measures and measurable improvement in energy performance. Major organisations such as Marks & Spencer, Larne Borough Council, Heathrow Airport and MFI Homeworks have already achieved accreditation.

**Natural Energy Stand: A4**

Toberscardan, Co Sligo, Ireland  
Tel: 071-85 595 Fax: 071-85 595  
Contact: Mr Peter Schnieder - Managing Director  
Details available on stand.

**Pacific Science and Technology Stand: C7**

65a Moyle Road, Dublin Industrial Estate, Glasnevin, Dublin 11, Ireland  
Tel: 01-830 3311 Fax: 01-830 3313  
Contact: Mr Liam Ward - Sales Manager  
Details available on stand.

**Parkersell Lighting Services (Irl) Stand: E7**

Unit 2 Cookstown Enterprise Park, Dublin 24, Ireland  
Tel: 01-451 1277 Fax: 01-451 1975  
Contact: Ms Geraldine Hamill - Sales Manager  
Details available on stand.

**Planet Advantage Stand: H11**

Planet House, Albert Place, Lower Darwen, Darwen, Lancs BB3 0Q2, England  
Tel: 1254-660 330 Fax: 1254-674 316  
Contact: Mr Gary Bowater - Sales Director  
Planet supplies a range of equipment and services, providing solutions for industry in respect of packaging and production waste problems. Compactors, balers, shredders, dryers, briquetting presses, glass crushers and waste to energy systems can be provided. Planet can also assist in the management of reclaimed materials or energy.

**Power Logic Stand: A14**

Maynooth Road, Celbridge, Co Kildare, Ireland  
Tel: 01-627 4030 Fax: 01-627 0859  
Contact: Mr Frank Bolger - Engineer  
Details available on stand.

**Prolux Stand: G12**

Watson & Johnson Centre, Greystones, Co Wicklow., Ireland  
Tel: 01-287 2797 Fax: 01-287 1630  
Contact: Mr Austin Doyle  
Prolux are specialists in the field of:-  
1) Energy efficient light fittings  
2) Solar energy material - Heat gain  
3) Energy control products - Heat loss  
Our lighting product range include Decorative, Hi-Bay, Low Bay, Commercial, Modular, Safety & Security. The common theme is energy reduction/efficiency. Featured products will be the "Starlight", "Adventure 3" Hi Bay, "Diadem" Luminaire and the unique 20 Metre "Light Pipe".

**RSL (IRL) Stand: G4**

48 Robinhood Industrial Estate, Clondalkin, Dublin 22, Ireland  
Tel: 01-450 8011 Fax: 01-456 7512  
Contact: Mr Gerry McDonagh - Managing Director  
RSL Ireland Ltd representing Baltimore Aircoil and other innovative manufacturers will present novel energy saving systems specifically for the refrigeration and air-conditioning industries.  
DOI: 10.21427/D71128

**S.D.M.O Generators Stand: G6/G7**

2A Sunbury Industrial Estate, Ballymount Road, Walkinstown, Dublin 12, Ireland  
Tel: 01-450 8366 Fax: 01-450 6762  
Contact: Mr Pat Cregan - Director  
Details available on stand.

**Safear Systems Stand: A13**

Unit 34 Southern Cross Business Park, Bray, Co. Wicklow, Ireland  
Tel: 01-276 1600 Fax: 01-276 1611  
Contact: Mr Shaun McGill  
Specialists in mobile and fixed air conditioning equipment and custom solutions.

**Safeguard Systems Stand: A13**

Unit 34 Southern Cross Business Park, Bray, Co. Wicklow, Ireland  
Tel: 01-276 1600 Fax: 01-276 1611  
Contact: Mr Shaun McGill  
Safeguard Systems - The Damper & Valve Control Company - will be exhibiting the new Belimo range of control valves and the Safeguard V1 fire/smoke damper control system using LonWorks technology. Furthermore, a division of Safeguard, known as Safear Systems - The Air Conditioning Company - will be exhibiting portable air conditioning equipment.

**Sauter HVAC Controls Stand: F9**

5 Doughcloyne Court, Doughcloyne Industrial Estate, Wilton, Cork, Ireland  
Tel: 021-346 238 Fax: 021-341 271  
Contact: Mr Trevor Casey  
Sauter are launching their new range of PN16 Male Threaded Valves designed specially with new drives (and your requirements) in mind. Available in sizes DN15 to DN50 On the drives you can choose the running times and characteristic curve of the valve your require, whether you want linear or =% and all at the flick of a switch. Visit stand no. F9 for more details.

**Scan EES Stand: A1**

3 Abbey Street, Howth, Co Dublin, Ireland  
Tel: 01-832 2636 Fax: 01-832 6925  
Contact: Ms Inge Buckley  
Vestas is represented in Ireland by Scan EES Ltd.

**Schneider Electric Ireland Stand: A1**

Maynooth Road, Celbridge, Co Kildare, Ireland  
Tel: 01-627 4030 Fax: 01-627 0859  
Contact: Mr Frank Bolger - Engineer  
Energy saving with the ATV range of variable speed controllers and soft starters from Schneider Electric Ireland. Full energy monitoring and analysis using Power Logic as well as other products from Schneider Electric will be displayed.

**Sermet OY Stand: G2**

Boughton Pumping Station, Brake Lane, Boughton, Newark, Nottinghamshire NG22 9HQ, England  
Tel: 1623-862 515 Fax: 1623-862 672  
Contact: Mr Gerry Wareham - UK/Ireland Representative  
Complete turnkey suppliers of combined heat and power biomass installations. Patented biograte technology enables wet biomass (mixtures of sawdust, bark, chips, peat) with up to 60% moisture to be burnt efficiently.

**Siemens Stand: E2**

Power & Automation Division, 8 Slaney Road, Dublin Industrial Estate, Dublin 11, Ireland  
Tel: 01-216 2435 Fax: 01-216 2499  
Contact: Mr Charles Smith - Engineering Sales Executive  
Exhibiting:- Variable Speed Drives and Motors, Liquid Ring Vacuum Pumps / Side Channel Blowers



# Cyclon SR

FROM COMPAIR

## Reliable compressed air provided at maximum efficiency under all operating conditions with quick, economical servicing built-in as standard

*The CompAir Cyclon SR rotary screw air compressor provides a variable speed drive system with outstanding efficiency, offering the ability to precisely match power consumed with air demand. When you need to achieve maximum efficiency at any level of demand – you now can, which means you can also cut energy costs and save money. In addition, precise pressure control and smoother acceleration and deceleration of rotary components will extend service life improving payback on your investment.*



- ◆ Outstandingly efficient – Precisely matches power consumption to air demand
- ◆ Cuts up to 50% of energy costs – Saving you money
- ◆ Easy to install
- ◆ Easy to operate
- ◆ Easy and economical to maintain
- ◆ Simple, proven, reliable
- ◆ 2-year parts warranty

### Hydrovane – The Worlds Most Reliable Air Compressor

- ◆ Be so reliable that its life expectancy could be in excess of four million miles
- ◆ Only need servicing once in every 80,000 miles
- ◆ Have a maintenance cost of only a fifth of a penny per mile
- ◆ Be capable of running at maximum speed all day, every day
- ◆ Have a superb performance that remains unchanged throughout its life
- ◆ 5-year parts warranty



HANLEY AIR SYSTEMS



Hanley Air Systems Ltd, Westpoint Industrial Park, Mulhuddart, Dublin 15.

Tel: 01 - 822 4822; Fax: 01 - 822 4833



THE ENERGY SHOW - DETAILED EXHIBITOR LISTING

**Sinergy**

**Stand: C7**

65a Moyle Road, Dublin Industrial Estate, Glasnevin, Dublin 11, Ireland  
Tel: 01-830 3311 Fax: 01-830 3313  
Contact: Mr Liam Ward - Sales Manager  
Details available on stand.

**Spirax Sarco**

**Stand: B7**

Charlton House, Cheltenham, Gloucestershire GL53 8ER, England  
Tel: 1242-521 361 Fax: 1242-535 277  
Contact: Mr Jerry Crowley - Regional Sales Manager  
Spirax-Sarco Limited are specialists in pipeline controls and instrumentation for the control and efficient use of steam and other industrial fluids. Featured on the stand at the show, is the new Spriax Sarco - Alfa Laval steam plate heat exchanger package, and the award winning APT 14 automatic pump trap for removing condensate from steam systems under all operating conditions

**Stark Software Systems**

**Stand: C7**

65a Moyle Road, Dublin Industrial Estate, Glasnevin, Dublin 11, Ireland  
Tel: 01-830 3311 Fax: 01-830 3313  
Contact: Mr Liam Ward - Sales Manager  
Details available on stand.

**TechCon Sales**

**Stand: E8**

"Sorrel", Manor Kilbride, Blessington, Co Wicklow, Ireland  
Tel: 01-458 2449 Fax: 01-458 2770  
Contact: Mr Tony Lewis - Sales Engineer  
TechCon Sales Limited specialises in the supply of products for measuring and monitoring energy including Heat meters, kwhr meters, Gas meters, Oil meters, Current switches, Data loggers and related products. TechCon Sales Limited also represent the following Companies: Viterra Energy Services, Veris Industries Inc. and Delta Trak.

**Telemecanique**

**Stand: A14**

Maynooth Road, Celbridge, Co Kildare, Ireland  
Tel: 01-627 4030 Fax: 01-627 0859  
Contact: Mr Frank Bolger - Engineer  
Details available on stand.

**The Institute of Energy Belfast**

**Stand: D2**

c/o School of the Built Environment, University of Ulster, Newtownabbey, BT37 0QB, Northern Ireland  
Tel: 01232-598 199 Fax:  
Contact: Dr. Patrick Waterfield - Membership Advisor  
The institute of Energy is an international body with branches and members all over the world, including Northern Ireland and the Republic of Ireland. The Institute is The professional body for all involved in energy, from supply to demand side, energy policy, energy management/efficiency - Engineers and Non-Engineers.

**Thermpak Systems**

**Stand: A10**

Unit 92 Dunlop Commercial Park , 3 Balloo Link, Bangor, Co. Down, Northern Ireland  
Tel: 2891-463 737 Fax: 2891-463 797  
Contact: Mr Ivan Johnson - Managing Director  
Thermpak Systems Ltd. are probably unique in being able to offer a complete range of "Thermal Solutions" such as process cooling and heating. We design and supply the following type of heat exchangers:- Spiratube corrugated tube heat exchangers. "Multiscrape" scraped surface heat exchangers.

**Thermwatch Ireland**

**Stand: A6**

48 Canonbrook Park, Lucan, Co Dublin,  
Tel: 01-621 1840 Fax: 01-621 1840  
Contact: Mr Rory McDevitt - Managing Director  
Novitherm radiator panels reduce heating costs, improve comfort levels and are easily fitted to the wall behind the radiator without having to

**Veris Industries Inc.**

**Stand: E8**

"Sorrel", Manor Kilbride, Blessington, Co Wicklow, Ireland  
Tel: 01-458 2449 Fax: 01-458 2770  
Contact: Mr Tony Lewis - Sales Engineer  
Details available on stand.

**Vestas Wind Systems A/S**

**Stand: A1**

Smed Hansens VEJ 27, DK-6940 LEM, Denmark  
Tel: 9675 2575 Fax: 9675 2342  
Contact: Mr John E Jensen - Sales Manager  
Vestas from Denmark is the world's largest wind turbine manufacturer. Vestas has a total of 9,500 turbines (3,500 mw) installed worldwide. In Ireland Vestas will have 173 turbines (107 mw) operating before the end of this year.

**Viridian Power Resources**

**Stand: D2**

58 The Cairns, Beaubec, Drogheda, Co Louth, Ireland  
Tel: 041-984 6314 Fax: 041-984 6314  
Contact: Mr Stephen Clarke - Development Engineer  
Viridian Power Resources Ltd. is part of the Viridian Group, formed during the restructuring of Northern Ireland Electricity (NIE). We build, own and operate power generation plants. Our schemes reduce site energy costs without the need for capital investment by our clients, leaving your own capital and manpower focussed on core business.

**Viterra Energy Services**

**Stand: E8**

"Sorrel", Manor Kilbride, Blessington, Co Wicklow, Ireland  
Tel: 01-458 2449 Fax: 01-458 2770  
Contact: Mr Tony Lewis - Sales Engineer  
Details available on stand.

**Wärtsilä NSD Ireland**

**Stand: E6**

Belgard Industrial Estate, Mayberry Road, Dublin 24, Ireland  
Tel: 01-459 5668 Fax: 01-459 5672  
Contact: Mr Noel O'Regan - General Manager  
The Wärtsilä NSD Corporation is the world's leading designer and supplier of diesel, dual fuel, gas-diesel and gas power plants based on reciprocating engines. These form the heart of many of the worlds CHP plants. The scope of supply from Wärtsilä NSD varies from engine only to a complete turn-key installation. After-sales support can be tailored to customer needs.

**Wind, Water, Solar Energy Systems**

**Stand: A4**

Kilgarvan, Co Kerry, Ireland  
Tel: 064-85 460 Fax: 064-85 460  
Contact: Mr Gerry Cunnane  
Details available on stand.

**Woodleigh**

**Stand: C7**

65a Moyle Road, Dublin Industrial Estate, Glasnevin, Dublin 11, Ireland  
Tel: 01-830 3311 Fax: 01-830 3313  
Contact: Mr Liam Ward - Sales Manager  
Energy monitoring and targeting systems. Temperature and energy logging systems. Suppliers of Valves and Actuators, HVAC controls.



# ... Raising the Standard in Heat Transfer Technology ...



## THE SERIES 1500 FAMILY OF COOLING TOWERS - FLUID COOLERS - EVAPORATIVE

*The Series 1500 Benefits:*

- ... Economical Installed Cost
- ... Low Power Axial Fans
- ... Unique Coil/Fill Design
- ... Easy Cleaning & Maintenance
- ... Satisfies Health & Safety Requirements
- ... Suits Both New & Replacement Installations



### RSL (Ireland) Ltd

48 Robinhood Industrial Estate, Clondalkin, Dublin 22  
Tel: 01 - 450 8011; Fax: 01 - 456 7512;  
email: gerry@rslireland.com

## The widest range of Controllers in the world



**EUROTHERM  
IRELAND**

**Eurotherm Ireland Ltd, IDA Industrial Estate,  
Monread Road, Naas, Co Kildare.  
Tel: 045 - 879937; Fax: 045 - 875123  
Email: aidan.finnegan@controls.eurotherm.co.uk**



# McCool Controls MC<sup>3</sup>E

## ENERGY UNDER CONTROL

### WE ARE THE LEADING SUPPLIER OF:

- HVAC Control Systems
- Energy Management Systems
- Max Demand Controllers
- Monitoring & Targeting Systems



Modular Controllers & Modules



Honeywell

### SUPPLIERS OF:-

- Cylon – BEMS Systems
- Honeywell – HVAC Control Systems
- Landis & Staefa – Control Equipment
- Phoenix Laboratory Airflow Controls
- Paragon Air Flow Control Systems

**FULL MAINTENANCE AND SERVICE BACK-UP FACILITY  
24 HOUR CALL OUT SERVICE**

### Contact:

#### DUBLIN OFFICE

Unit 21, IDA Enterprise Centre, East Wall Road, Dublin 3.  
Tel: 01 - 855 0542; Fax: 01 - 855 0546; Mobile: 086 2580472/088 547197  
eMail: mccooldu@iol.ie

#### CORK OFFICE

Unit 10, Ashdale House, Blarney, Co Cork  
Tel: 021 - 382055; Fax: 021 - 382348;  
eMail: mccooldc@iol.ie

#### LIMERICK OFFICE

Castleconnel, Co Limerick. Tel: 061 - 372277

#### BALLYMENA OFFICE

Unit 8, Ballymena Business Centre, 62 Fenaghy Road, Ballymena.  
Tel: 08 01266 49422; Fax: 08 01266 49423



•continued from page 12

## CODEMA Championing Proper Energy Management

CODEMA, the City Of Dublin Energy Management Agency, is acutely aware of the importance of proper energy management and the promotion of renewable energy, now even more so than when it first started out three years ago. The unique approach of the energy agency which involves identifying targets for sustainable energy interventions at local level, and implementing the relevant strategies suited to local community needs in Dublin, have been at the core of CODEMA'S work during this period.

Having completed the energy balance for the city in 1998 which showed that the largest consumer of energy in the city was residential at 46%, CODEMA worked closely with Ballymun Regeneration Ltd to ensure that the new development, which plans to build over

2800 houses, included a meaningful energy policy. This policy would, among other things, ensure that the cost of heating the new houses would be no more than the highly-subsidised cost to residents at present.

In addition, CODEMA worked closely with an innovative local adult education project in Ballymun, NOW (New Opportunities for Women) to provide valuable information on the effects of energy consumption on the environment and how to increase thermal comfort with cost benefits.

Looking to the future, CODEMA is working closely with Dublin Corporation to develop a city-wide energy strategy for the refurbishment of flat complexes throughout the city of Dublin.

It is also complementing the work of the engineering division in Dublin Corporation by

designing a website for water-saving devices commonly installed in residential buildings. This website illustrates the top 10 most water-efficient products available in Dublin

under a number of headings, ie, taps, showers, etc, and is aimed at the specifiers in the building industry.

Education is an important element of the work of CODEMA. As part of a European Project involving local energy agencies in Italy and Austria, CODEMA is carrying out a pilot project for schools with its local partner – St Louis High School Rathmines – called TEACH, which involves 'Training pupils for Energy Analysis in sCHool buildings'. This project can then be developed and implemented on a wider scale with the benefits of promoting awareness, and also improving the building stock of schools.

Set up originally as a joint initiative of Dublin Corporation and the European Union, European projects are becoming a feature of the work of CODEMA. By providing financial support and valuable links, we can avail of the most up-to-date and innovative approaches most likely to succeed in energy management.

One such project is the SURE/RESECO project, which got the highest score in the first call for proposals out of a total of 800 European projects. With our partners in Sweden, Denmark, Barcelona and Tallin, Estonia, we will exhibit the most up-to-date ideas in housing in Europe at the European Housing Expo in Malmo, Sweden in 2001. CODEMA's role is to improve the acceptability

of renewable energies in an urban context through improved associated thermal comfort in the home using modern IT technologies.

Closer to home CODEMA currently holds the Secretariat for the AIEA, the Association of Irish Energy Agencies. The members of the association come from the 12 energy agencies currently active in Ireland, three in Northern Ireland, and the remaining nine in the Republic of Ireland.

Set up primarily to represent the interests of its members, the Association has been active over the last year in contributing to both the Green Paper on Sustainable Energy produced by the Department of Public Enterprise, and also the National Greenhouse Gas Abatement Strategy, which is currently being compiled by the Department of Environment and Local Government.

With the current changing energy climate involving such issues as liberalisation of the energy market and increasing concerns of global warming, CODEMA looks forward to the challenge of the next five years of integrating these issues within a city that is facing up to the social, economical and environmental challenges of a city moving into the 21st century.

Contact: Claire Bourke, CODEMA. Tel: 01 - 288 1561; Fax: 01 - email: codema@iol.ie



Dr Gerry Wardell, Director, CODEMA with Joe Jacob, TD, Minister of State at the Department of Public Enterprise and Claire Bourke, Co-ordinator, CODEMA



TRADE NEWS

## Powrmatic Turns Up the Heat

Powrmatic has developed its range of commercial flue products to offer even greater choice to customers in the flue and chimney market.

The well-established System 250 range, previously available in internal diameters of 125-300mm, is now available in diameters up to 600mm.

System 250 is now positioned as a multi-purpose chimney product, with diameters of 250mm plus available with a wide range of optional material specifications to suit all applications and budgets. Powrmatic also aims to deliver all bespoke systems within 10-14 days, including specially-manufactured modular headers and components.

The 125-200 mm range features a 316-grade stainless steel liner, 2mm of high quality silica powder insulation, and a 304-grade stainless steel outer casing. Kitemarked to BS4543, parts 2 and 3 1990, these diameters are suitable for solid fuels and 35-sec oil appliances. They are also four-hour fire-rated in accordance with BS476, part 20 1987.

To make customer ordering even easier, the

range now comprises installed lengths of 1500mm, 1000mm, 500mm and 250mm. However, adjustable lengths are still available where dimensional flexibility between components is required.

In addition, the System 125 commercial gas vent has now been replaced by a new range called System 250 GV which provides significant improvements in construction and quality. This new gas vent, which is a further development of the System 250 concept, also has the benefit of common components and support brackets, offering designers the opportunity to change from one system to the other without the need for special adaptors.

Manufactured with an aluminium liner, 25mm air cavity and zalulite outer casing, System 250 GV is available in diameters of 175mm - 600mm. The gas vent is suitable for atmospheric gas-fired appliances where the flue gas temperature does not exceed 250°C.

Contact: Paddy Lowry, Powrmatic Ireland.  
Tel: 01 - 452 1533;  
Fax: 01 - 452 1764.



The established System 250 range from Powrmatic - previously available in internal diameters of 125-300mm - is now also available in diameters up to 600mm.

## Air-Flow Control Monitor

Designed for use in monitoring building pressurisation and air-flow control, the low-cost Dwyer Series 668 differential pressure transmitter from Manotherm measures the flow of air (or other non-conductive gasses) in ranges as low as 0 - 0.25 in. w.c. The instrument's variable-capacitance sensor design provides excellent sensitivity - measurements are accurate to ±1% (FS), including non-linearity, hysteresis, and non-repeatability.

Housed in fire-retardant, glass-filled polyester, this CE-approved transmitter has an operating temperature range of 0 to 150°F (-18 to 65°C). It can withstand up to 10 psig overpressure without damage. Featuring reverse polarity protection, the unit's output is a 2-wire design, standard 4- to 20- mA signal. Its compact, lightweight (3 oz/85g) configuration allows for quick and easy installation.

Models covering eight ranges (up to 0 to 50 in. w.c.) are available from stock.

Dwyer produces a broad range of measuring and control instruments for pressure, temperature, level and flow applications, all of which are available from Manotherm.

Contact: Bob Gilbert/  
Brian Harris, Manotherm.  
Tel: 01 - 452 2355;  
Fax: 01 - 451 6919; email:  
manotherm@eircom.com  
Northern Ireland:  
Tel: 01820 669936;  
Fax: 01820 669990;  
email: sales@manotherm.  
freeserve.co.uk

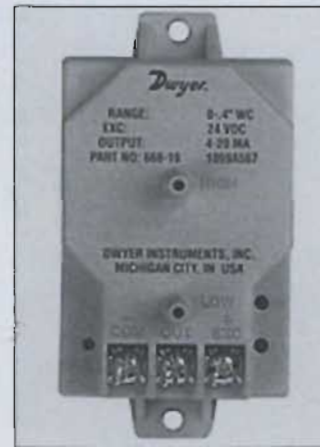

Right: Dwyers Series 668 differential pressure transmitter from Manotherm

## Noise Shield™ from NCRL

NCRL Ltd (Noise Control Research Laboratories) in Dublin has launched its new range of acoustic foams manufactured in Ireland. The product range has been launched under the brand name Noise Shield™.

The standard range of products is aimed at the HVAC industry. The foam sheets are a standard size of 1200mm x 1000mm but the machine will facilitate 1297mm x 2000mm. For special applications different facings can be put onto the foam, in addition to different adhesives if required.

The advantage that the Noise Shield™ product range will have over its competitors in Ireland and throughout Europe is that, because NCRL™ is a laboratory, it is able to test the clients product and find the correct material to use to meet the clients and legislative requirements.

"At NCRL™" says Ciaran King "we believe that noise issues are becoming more frequently an issue for OEM's. Because we have the ability to test product and produce product in compliance with national and international standards, we can best serve our clients by offering a complete solution to their noise problem".

Contact: Ciaran King/Caimin Hall, NCRL.  
Tel: 01 - 667 1077; Fax: 01 - 667 1055;  
email: ncr1@eircom.net Website: www.ncrl.net



# VENTAC

*\* Air Management Engineers \**

## Axial Roof Fans – Series HCTB – HCTT

Galvanised steel axial fans with spun aluminium cowls. These models are available ex-stock in either supply air or extract format.

Standard features:

- IP 65
- Thermal motor protection
- Class F
- Ball bearings for life
- 230/1/50H
- 400/3/50H
- Airflows from 1900m<sup>3</sup>/h to 13,000m<sup>3</sup>/h



Series HCTB/HCTT

[www.ventac.com](http://www.ventac.com)    [sales@ventac.ie](mailto:sales@ventac.ie)

## Centrifugal Roof Extra Units – Series Max Temp



Horizontal Discharge

A range of roof mounted centrifugal fans with backward inclined impellers manufactured in galvanised steel with spun aluminium cowls.

Standard Features:-

- IP55
- Class F
- Ball bearings greased for life
- 230/1/50Hz
- 400/3/50Hz
- Airflow from 800m<sup>3</sup>/h to 21,000m<sup>3</sup>/h
- 400°C/2hf



Vertical Discharge

**MAX-TEMP** 

**Fire-Rated**

**400°C/2h**

Fitzwilliam House,  
11 Fitzwilliam Quay,  
Ringsend,  
Dublin 4

[sales@ventac.ie](mailto:sales@ventac.ie)  
[www.ventac.com](http://www.ventac.com)  
Tel: 01 - 667 1077  
Fax: 01 - 667 1055



TRADE NEWS

## Sanyo Super ECO Multi Series

Sanyo's new Super ECO Multi Series represents a combination of economy and ecology. The unique power control circuit and newly-designed structural parts contribute to a major reduction in initial running costs.

The newly-developed power control refrigerant operates without an inverter control by using a super power control compressor and an external save valve to control capacity. This results in reduced harmonic wave emissions.



Sanyo Super ECO Multi Series – Instead of an inverter, the Super ECO MULTI system uses a super power control compressor and an external save valve to control capacity. This results in reduced harmonic wave emissions. Details from Redbro.

Additionally, the Super ECO Multi Series system uses R407C refrigerant which does not damage the ozone layer.

The Super ECO Multi meets the air conditioning requirements for commercial and residential use. It is possible to connect indoor units with a capacity of up to 130% of the outdoor unit capacity. Assuming that the minimum capacity of an indoor unit is 2.8kW, it is possible to connect 10 or 13 units respectively to the 22.4 kW unit, or the 28.0kW unit.

The upper and lower cylinders are connected by three bypass pathways, and capacity control is performed by the power control valves to achieve 4-step control (25-50-75-100%).

By using electronic control valves for linear control, the capacity of the indoor unit can be controlled from 25 to 100% (during cooling) to provide a more stable room temperature at a constant air flow rate.

Even when power failure occurs, preset programmed operation can be reactivated once power is resumed.

The indoor and outdoor units each have communications terminals that allow connection of as many as 94 units (Indoor unit: Max 64+ Outdoor unit: Max 30) to a single communications line (non-polar twin-line main bus). The main bus is twin-core and non-polar for easier wiring, while the indoor unit settings are automated for easy installation.

The Sanyo Super ECO multi system range is extensive, catering for virtually every requirement. It includes:-

### Indoor Units

Semi-concealed type (4-way and 2-way and 1-way discharge); One way air discharge semi-concealed slim type; ceiling-mounted type; wall-mounted type; concealed duct type; concealed duct; high-static pressure type; floor-standing type; and concealed floor standing type;

### Outdoor Units

Heat pump type and cooling type available. Capacities – ranging from 10kW to 84kW.

Contact: Barry Hennessy, Redbro. Tel: 01 - 294 0321; Fax: 01 - 294 0325; email: sanyoac@indigo.ie

## Fire Flex Sprinkler Systems

The Fire Flex sprinkler system from Design Air revolutionises the way in which sprinkler systems are designed and installed. "Key advantages are its simplicity", says a company spokesperson. "Available in three lengths, it replaces conventional sprinkler drop pipes, thereby reducing installation time significantly and also, of course, installation costs. In some cases this can mean a saving of 70% over conventional systems".

It can be used for new and retrofit installations within all industries, including commercial and industrial applications, shopping centres, hospitals and other public buildings, and in specialist areas such as cleanrooms.

Fire Flex has all relevant conformity and regulatory approvals, including that of Factory Mutual and Underwriter Laboratories.

Fire Flex comprises a unique assembly of four primary components. Each kit includes stainless steel convoluted hose; sprinkler reducer; and bracket assembly to fit to standard ceiling grids.

Fire Flex allows the installer to fit both the main pipework and fit-off pipework at the same time. Ceiling grids need not be installed and only one pressure test is required. It can be carried out without draining the system while alterations to sprinkler locations can be made by simply re-shaping the Fire Flex or by replacing a unit with the appropriate longer/shorter unit.

Contact: Design Air. Tel: 01 - 460 5555; Fax: 01 - 460 5556. email: designair@indigo.ie

RIGHT: The innovative Fire Flex sprinkler system from Design Air on the left, compared with the conventional system on the right.

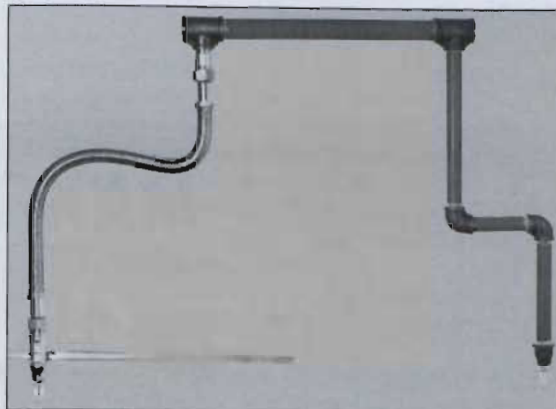



## Adopting the Complete Approach to Facility Management

For almost quarter of a century Colm O'Neill Engineering Services Ltd has been one of Ireland's leading Engineering firms with a reputation for quality and professionalism. Recent months have seen a number of exciting developments for the organisation, including the appointment in October of Dr Paddy Galvin as Chairman of the Board.

Dr Galvin previously held the position of Operations Director with Guinness Ireland, before which he was Managing Director of Guinness Dublin. As Chairman and chief Executive Officer of Waterford Crystal he was key to the revival of the Waterford brand and is currently a member of the boards of the Bank of Ireland Group, Greencore and Gallagher's.

In June last year Ruairi O'Neill joined Colm O'Neill Engineering Services as Marketing Director. His task was to develop a one-stop facility maintenance company, combining new techniques in service management with Colm O'Neill's reputation for quality. This

led to the formation of COMPLETE in January of this year.

Complete's vision is to provide an unrivalled facilities maintenance service to corporate customers. Focusing initially on the full range of mechanical services, electrical services and HVAC (including BMS systems), the company also provides for general maintenance, painting and fabric repairs.

Complete offers a "one-stop-shop" facility maintenance service utilising revolutionary Internet and information technology, a state-of-the-art 24-hour help-desk, combined with specifically-tailored marketing and customer service techniques. The core of the Complete approach is to identify and assess each client's needs and deliver a tailored programme of maintenance and service to support those needs.

Contact: Sean Ormonde, Complete. Tel: 01 - 473 0898; Fax: 01 - 453 1187; email: info@completefm.com Website: www.completefm.com



Fintan Lyons with Paddy Galvin and Ruairi O'Neill.

## Wilo Cleanson – Air & Sludge Removal Module

Wilo has introduced Cleanson, a fully self-contained system for the automatic removal of air and sludge from central heating and air conditioning installations. The module consists of the following main elements:-

- A separator: This non-moving part is made of 316 stainless steel, and includes a particle separation cylinder, the sides of which are equipped to create a magnetic field, and a collection chamber;

- A hydraulic and electromechanical system: This includes a specific circulation pump for each mode, a motorised automatic globe drain valve, a leak detector, and an equalisation valve;

- A control panel: This provides complete automation and protection of the module.

The Cleanson is based on the latest technology using innovative design. It uses only natural physical processes with no addition of chemicals. This patented process uses a combination of the following physical separation and air removal techniques – centrifuging; magnetophoresis; and the vortex effect.

Magnetophoresis allows the separation and flocculation of the iron oxides combined in the water. Water from the system entering the module is accelerated by

the pump and driven into the separator through a tangential inlet.

Continuous pressure from the pump and the accelerator cone causes the water to swirl at high speed. This creates a powerful centrifugal effect which, together with a multi-polar magnetic field, forces particles suspended in the water to the bottom of the separation cylinder where they are sucked into the collection chamber.

The vortex effect reverses the direction of movement of the swirl, forcing the water back up the centre of the separator and back into the system. A continuous process automatically removes air at the separator outlet. Iron oxides are converted into magnetite or black sludge and evacuated through the motorised valve. The process is completely automated and can be monitored from the control box.

Contact: Wilo Engineering Ltd. Tel: 061 - 410963; Fax: 061 - 414728; email: sales@wilo.ie

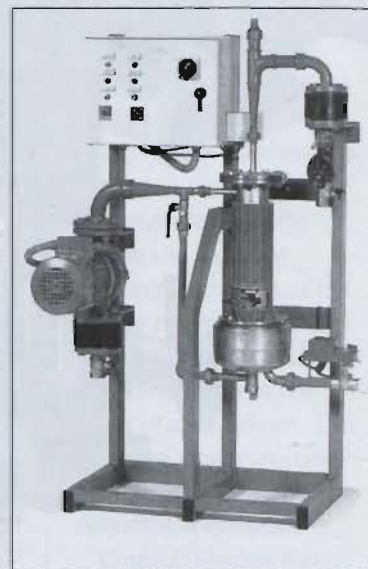

Cleanson sludge removal module from Wilo Engineering



In today's environmentally-conscious world it makes perfect sense to consume only as much energy as you need. The Hydro 2000 Booster System allows you to do just that.

Save your money and contribute to a cleaner environment by choosing the right solution - The Grundfos Hydro 2000 Self-Regulating Booster System.

# HYDRO SYSTEM 2000 & 1000

## Pressure Boosting Units

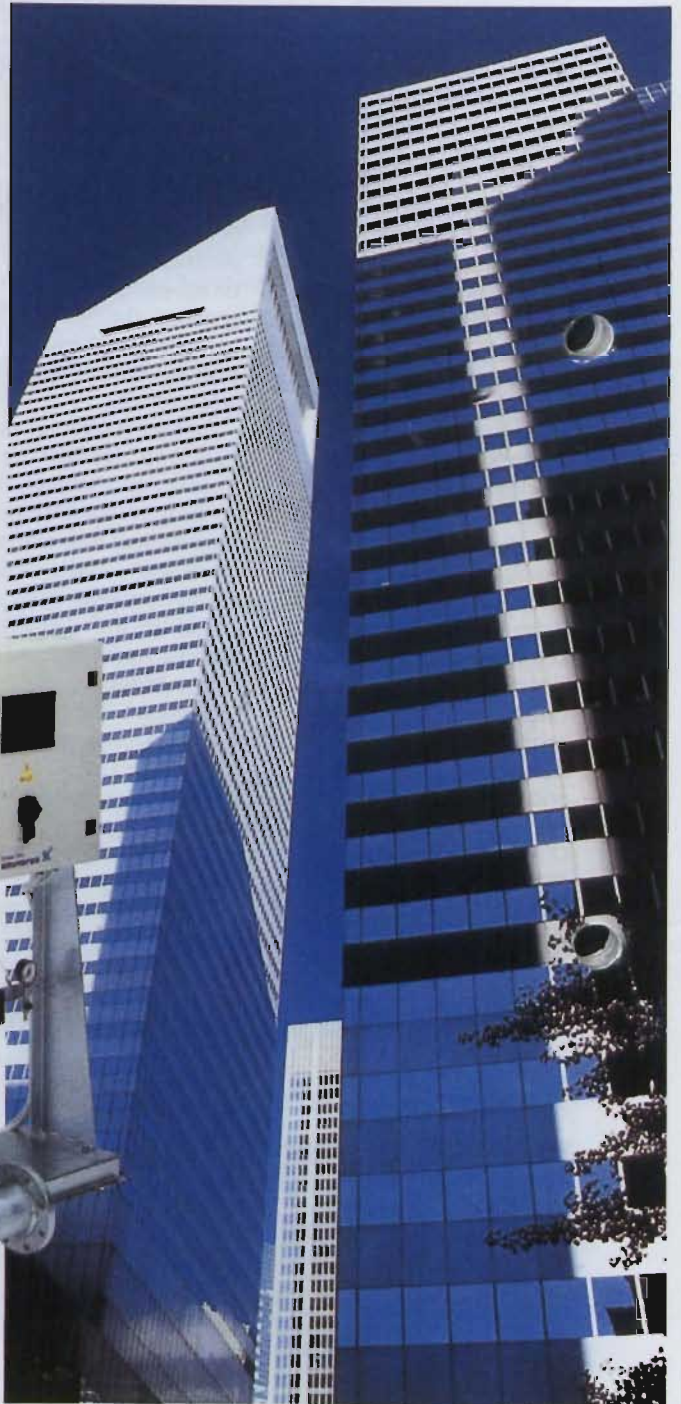

Grundfos (Ireland) Ltd, Unit 34 Stillorgan Industrial Park, Blackrock, Co Dublin.  
Tel: 01 - 295 4926; Fax: 01 - 295 4739;  
email: gbarry@grundfos.com Website: www.grundfos.com

**GRUNDFOS** 

### Grundfos Nationwide Distributors

<https://www.tudublin.ie/hsp/vol39/iss4/1822271>; **Dublin** - Euro Fluid Handling Systems; Tel: 01 - 450 3884; HR Hoffeld Ltd; Tel: 01 - 288 7361; Industrial Pumps & Process; Tel: 01 - 298 9560;  
Tel: 01 - 277 7128; **Limerick** - PJ Dore Ltd; Tel: 061 - 393240; **Louth** - Kearney Pumps & Plumbing; Tel: 042 - 937 2912; **Tipperary** - Cantwell Electrical Eng Ltd; Tel: 056 - 34198;  
**Waterford** - Paddy Butler Water Pumps; Tel: 054 - 44105.



## Grundfos Unveils Wide Range of End-Suction Pumps

Grundfos has entered the market for end-suction centrifugal pumps with a comprehensive range of heavy-duty workhorses with benefits for end-users and wholesalers alike.

The range, which includes both close-coupled and long-coupled pumps, is particularly well-suited to industrial use and in large public utility systems, such as water supply, heating or air conditioning systems. The pumps are designed to carry heavy loads under all conditions and still be reliable.

"With an eye for quality and user needs", says General Manager, Gordon Barry, "Grundfos offers local service and back-up, customised products to suit a wide variety of applications, dependability, and low running costs.

"It is the quality of materials, components and design which makes all the difference. Grundfos uses first-class cast-iron for the pump housing and impeller, top-quality bearings, shaft seals and motors. For harsh conditions a bronze impeller or an all-bronze pump may be the best option, and this too can be catered for".

Since 1991 Grundfos has been marketing pumps with integrated frequency

converter for automatic performance control of the pump. It is a well-known fact that speed controlling of pumps results in energy savings of up to 50% – depending on the application and the type of pump.

Within the end-suction programme, Grundfos offers integrated speed control – in the E-pump, in the power range up to 7.5 kW.

Grundfos' range of end-suction pumps comprises 35 basic models, which have been designed to meet ISO and DIN-EN standards for industrial applications and building services, respectively. This means that they are certified to operate at 10 bar to meet the DIN-EN 733 standard, and 16 bar in the case of the ISO 2858

## Design Air & AET Partnership



Donal Keane of Design Air pictured with Gian Blake-Thomas, Managing Director, AET on their joint stand at the recent Building Services Show in Moran's Red Cow Hotel, Dublin.

This presence marked the first formal trade presentation of the AET Flexible Space System to Ireland by underfloor air conditioning and raised access floor specialists Design Air. Contact: Donal Keane, Design Air. Tel: 01 - 460 5555; Fax: 01 - 460 5556. email: designair@indigo.ie

standard. The operating capacity of the close-

coupled and long-coupled pumps ranges from 2 – 2000 m<sup>3</sup>/h with up to 200 m head.

The comprehensive range means that the right pump can always be found for the right job. If one pump is not enough to do the job, two or more pumps can be combined in parallel. A multiple pump system means that the system can continue running even if one of the pumps needs to be taken out of action for routine maintenance, or in the event of a breakdown. This can be of vital importance in a system where non-stop operation is essential.

Contact: Gordon Barry, Grundfos. Tel: 01 - 295 4926; Fax: 01 - 295 4739; email: gbarry@grundfos.com Website: www.grundfos.com

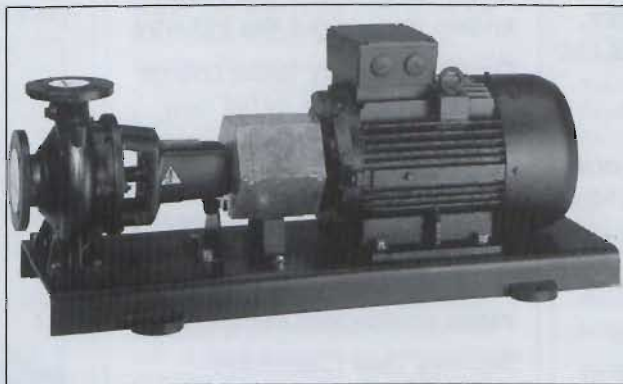
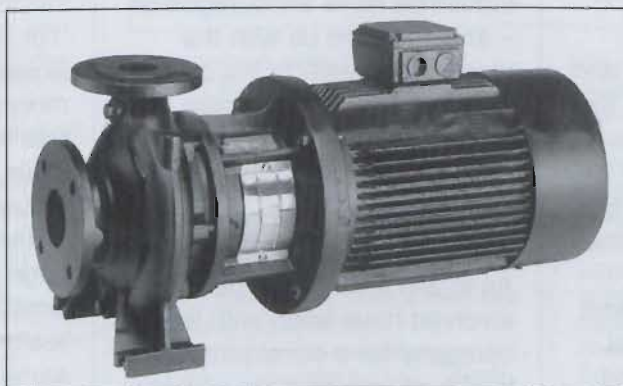

The new Grundfos NB/NBG close-coupled range of end-suction pumps.



INDUSTRY DEVELOPMENTS

# Control Aer ... Promising a Breath of Fresh Air!

John Grainger and Ben Kearney have renewed their love affair with the ventilation supply business, by teaming up with their former colleagues at Control Aer, Dave Kelly and Michael Renaghan.

"Control Aer was logical for us", said John Grainger. "The success they have experienced in 18 months reminds me of our own growth some 10 years previous but, unlike our previous growth, the structures in Control Aer are sound and exciting, in particular the hand-picked staff. Both Dave Kelly and Michael Renaghan deserve great credit for what they have achieved, with a £1 million price tag on their new 18,000 sq ft headquarters, situated in Kylemore Road, Dublin 12; a further 6,000 sq ft in Westlink Industrial Estate; and 2,000 sq ft in Clondalkin which will be brought in-house at a later date".

Control Aer has brought together leading talent in the area of sales, logistics, manufacture and finance. All of these attributes are represented at the highest level, and support staff for each team leader has been hand-picked to ensure operational decisions are delivered throughout the organisation.

John Grainger has responsibility for developing medium to long-term sales strategies, together with integrating these decisions into every aspect of the business. At present John is working on a re-launching of the company in June, with an entirely new identity, unique to the industry, which he says will be "revolutionary and should bring about a breath of 'fresh air' (excuse the pun) back to the industry".

Ben Kearney brings a very experienced (30 years) stable pair of

hands to Control Aer, something vital to keep this very young energetic company under check. Ben's technical expertise is also a major draw to clients with design, and particularly problematic, ventilation requirements. Ben commented: "It's not something I longed for, but it's what I do best".

David Kelly has continuing responsibility for logistics and manufacturing, ensuring that new production is integrated into existing facilities and delivered to customers within reasonable expectations. David said: "Traditionally, production of ventilation products in Ireland has been haphazard and leaning towards being customised more often than not. This has, in effect, resulted in higher costs, inefficiencies, long lead times and spurious qualities. It is our

credit exposure and profitability indicators, providing the management team with real-time information. "IT is an important tool for sales development and starting our web programme with our current web design is just the first step for our planned IT strategy. We are determined to be leaders in web use and will introduce practical benefits for customers in the near future.

"The directors are confident of developing a business with a strong asset value, together with sustainable profitability. This view has already been made a reality, which has enabled us to expand. To this extent we have achieved all the financial support we need".

Control Aer moved to their new premises on the weekend of 4 March

2000, just prior to the arrival of Ben and John, who started on 6 March. David Kelly said: "We understood that developing our business required a solid platform, and the additional space and facilities for our continued growth had to be delivered immediately. With the extra impetus for sales, manufacturing and distribution, we had to gear up for the future. We are well situated in the market to deliver the promises we make to customers. It is exciting, and the team spirit Michael and myself have fostered in the company makes the staff spirit a significant resource for the future".



Control Aer - Dave Kelly with John Grainger, Michael Renaghan and Ben Kearney.

view that this must change, and will change. All will be revealed in June!"

Michael Renaghan continues to manage the allocation of resources,

"The move to new premises and the arrival of Ben and John were the final pieces in the jigsaw", says Dave Kelly. "These, coupled with the excellent team spirit which already existed at Control Aer, will now blend into a significant and dynamic force for the future".



# REDBRO

et al.: BS News

# SANYO

Unit 4, 70 Heather Road, Sandyford Industrial Estate, Foxrock, Dublin 18.  
Tel: 01 - 294 0321/3/4; Fax: 01 - 294 0325; email: sanyoac@indigo.ie

## SANYO Multi System Air Conditioners "Super ECO MULTI"

Environmentally-friendly HFC R407C available.

NEW OZONE ERA, KEEP THE GREEN WORLD  
**R407C**

**ECO MULTI**  
ECONOMY & ECOLOGY

ECO

MULTI







**MANOTHERM LIMITED**

THE CONTROL CENTRES

4 WALKINSTOWN ROAD, DUBLIN 12  
Tel: 01 - 452 2355/452 2229 Fax: 01 - 451 6919  
*Building Services News*, Vol. 39, Iss. 4 [2000], Art. 1  
U 15 BANBRIDGE ENTERPRISE CENTRE  
SCARVA RD IND. EST., BANBRIDGE BT32 3QD, CO DOWN  
Tel: 01820 669936 Fax: 01820 669990  
E-mail: sales@manotherm.freeserve.co.uk

# Dwyer®

C O N T R O L S  
A N D  
G A U G E S



PRESSURE

FLOW

LEVEL

TEMPERATURE

DWYER

MERCROID

W.E. ANDERSON

LOVE

PROXIMITY